



Part 2: Test Under Dynamic Transmission Condition

For
SMARTPHONE

FCC ID: BCG-E8666A
Model Name: A3083

Report Number: 14982436-S5V2
Issue Date: 7/26/2024

Prepared for
APPLE INC.
1 APPLE PARK WAY
CUPERTINO, CA 95014-2084

Prepared by
UL VERIFICATION SERVICES INC.
47173 BENICIA STREET
FREMONT, CA 94538, U.S.A.
TEL: (510) 319-4000
FAX: (510) 661-0888

Revision History

Rev.	Date	Revisions	Revised By
V1	7/25/2024	Initial Issue (DRAFT)	--
V2	7/26/2024	1. Updated §1 with the correct <i>Highest Reported SAR</i> results 2. Updated power for n70 ANT 4	Nathan Sousa

Table of Contents

1.	Attestation of Test Results	6
2.	Introduction	7
3.	Varying Transmission Test Cases and Test Proposal	7
4.	SAR Time Averaging Validation Test Procedures	9
4.1.	Test Sequence Determination for Validation	9
4.2.	Test Configuration Selection Criteria for Validating Smart Transmit Feature	9
4.2.1.	Test Configuration Selection for Time-varying Transmission Power	9
4.2.2.	Test Configuration Selection for Change in Call	10
4.2.3.	Test Configuration Selection for Change in Technology/Band	10
4.2.4.	Test Configuration Selection for Change in Antenna	10
4.2.5.	Test Configuration Selection for Change in DSI	11
4.2.6.	Test Configuration Selection for Change in Time Window	11
4.2.7.	Test Configuration Selection for SAR Exposure Switching	11
4.3.	Test Procedures for Conducted Power Measurements	12
4.3.1.	Time-varying Transmission Power Scenario	12
4.3.2.	Change in Call Scenario	13
4.3.3.	Change in Technology and Band	14
4.3.4.	Change in Antenna	15
4.3.5.	Change in DSI	15
4.3.6.	Change in Time Window	15
4.3.7.	SAR Exposure Switching	16
4.4.	Test Procedure for Time-varying SAR Measurements	17
5.	PD Time Averaging Validation Test Procedures	18
5.1.	Test Sequence for Validation in mmW NR Transmission	18
5.2.	Test Configuration Selection Criteria for Validating Smart Transmit Feature	18
5.2.1.	Test Configuration Selection for Time-varying Transmission Power	18
5.2.2.	Test Configuration Selection for Change in Antenna Configuration (Beam)	18
5.2.3.	Test Configuration Selection for SAR versus PD Exposure Switch during Transmission	18
5.3.	Test Procedures for mmW Radiated Power Measurements	18
5.3.1.	Time-varying Transmission Power Scenario	18
5.3.2.	Switch in SAR vs. PD Exposure during Transmission	20
5.3.3.	Change in Antenna Configuration (Beam)	21
5.4.	Test Procedure for Time-varying PD Measurements	22
6.	Test Configurations	23
6.1.	WWAN (Sub-6 GHz) Transmission	23
6.2.	LTE + mmW NR Transmission	25
7.	Conducted Power Test Results for Sub-6 GHz Smart Transmit Feature Validation	26
7.1.	Measurement Setup	26
7.2.	P_{limit} and P_{max} Measurement Results	28
7.3.	Time-varying Transmission Power Measurement Results	28
7.3.1.	GPRS PCS Antenna 1 (Test Case 1 in Table 6-2)	29
7.3.2.	GPRS PCS Antenna 3 (Test Case 2 in Table 6-2)	30
7.3.3.	W-CDMA Band Band 4 Ant 1 (Test Case 3 in Table 6-2)	31
7.3.4.	W-CDMA Band 2 Ant 1 (Test Case 4 in Table 6-2)	32
7.3.5.	LTE Band 66 (Test Case 5 in Table 6-2)	33

- 7.3.6. LTE Band 2 (Test Case 6 in Table 6-2)34
- 7.3.7. Sub-6 GHz NR Band n66 (Test Case 7 in Table 6-2).....35
- 7.3.8. Sub-6 GHz NR Band n77 (Test Case 8 in Table 6-2).....36
- 7.4. Change in Call Test Results (Test Case 9 in Table 6-2)37
- 7.5. Change in Technology/Band Test Results (Test Case 10 in Table 6-2)38
- 7.6. Change in DSI Test Results (Test Case 11 in Table 6-2)39
- 7.7. Change in Time Window/Antenna Switch Test Results (Test Case 12 in Table 6-2)40
 - 7.7.1. Test Case 14: Transition from LTE 66 to LTE 48 (i.e., 100 seconds to 60 seconds), then Back to LTE 66 40
- 7.8. Switch in SAR Exposure Test Results (Test Case 13 in Table 6-2).....41
- 8. SAR Test Results for Sub-6 GHz Smart Transmit Feature Validation42**
 - 8.1. Measurement Setup.....42
 - 8.1.1. Set-up for Path Loss Calibration42
 - 8.2. SAR Measurement Results.....42
 - 8.2.1. GPRS PCS Antenna 1 SAR Test Results.....43
 - 8.2.2. GPRS PCS Antenna 3 SAR Test Results.....44
 - 8.2.3. W-CDMA Band 4 Antenna 1 SAR Test Results45
 - 8.2.4. W-CDMA Band 2 Antenna 1 SAR Test Results46
 - 8.2.5. LTE Band 66 Antenna 1 SAR Test Results47
 - 8.2.6. LTE Band 2 Antenna 1 SAR Test Results48
 - 8.2.7. Sub-6 GHz NR Band n66 SAR Test Results49
 - 8.2.8. Sub-6 GHz NR Band n77 SAR Test Results50
- 9. Radiated Power Test Results for mmW Smart Transmit Feature Validation51**
 - 9.1. Measurement Setup.....51
 - 9.2. mmW NR Radiated Power Test Results.....52
 - 9.2.1. Maximum Transmission Power Test Results for n26153
 - 9.2.2. Maximum Transmission Power Test Results for n26053
 - 9.2.3. Switch in SAR vs. PD Exposure Test Results for n26154
 - 9.2.4. Switch in SAR vs. PD Exposure Test Results for n26054
 - 9.2.5. Change in Beam Test Results for n26155
 - 9.2.6. Change in Beam Test Results for n26055
- 10. PD Test Results for mmW Smart Transmit Feature Validation56**
 - 10.1. Measurement Setup.....56
 - 10.2. PD Measurement Results for Maximum Power Transmission Scenario57
 - 10.2.1. PD Test Results for n26157
 - 10.2.2. PD Test Results for n26058
- 11. Conclusions.....58**
- Appendices.....59**
 - A Test Sequences59
 - B Test Procedures for Sub-6 GHz NR + Sub-6 GHz Radio.....61
 - B.1 Time-varying Transmission Power Test for Sub-6 GHz NR in NSA Mode.....61
 - B.2 Switch in SAR Exposure Between Sub-6 GHz vs. Sub-6 GHz NR during Transmission.....61
 - C cDASY6 System Validation.....62
 - C.1 SAR System Verification and Validation62
 - C.2 Power Density Measurement System Verification.....65
 - C.2.1 Power Density Probe66

C.2.2 Power Density System Verification66

D SPEAG Certificates of cDASY6 SAR Probe, DAE, Dipole, mmW Probe and mmW Verification Source67

E Test Setup Photos67

Figures

Figure 4-1: 100 seconds running average illustration 12

Figure 7-1a – 7-1c: Conducted power measurement setup27

Figure 9-1 mmW NR radiated power measurement setup (see Appendix E for missing figures)51

Figure A-1: Test Sequence 1 waveform59

Figure A-2: Test Sequence 2 waveform60

Tables

Table 6-1: P_{limit} for supported technologies and bands (P_{limit} in EFS file)24

Table 6-2: Radio configurations selected for Part 2.....24

Table 6-3: Selections for LTE + mmW NR validation measurements25

Table 6-4: Test configuration for LTE + mmW NR validation25

Table 7-1: Measured P_{limit} and P_{max} of selected radio configurations28

Table 9-1: Worst-case 1-g SAR, 4 cm² average PD and EIRP measured at P_{limit} for the selected configurations52

Table A-1: Test Sequence 260

Table C-1: List of calibrated equipment62



Table C-2: System verification results63

Table C-3: Tissue dielectric properties at the time of testing.....64

Table C-4: List of calibrated equipment65

Table C-5: System validation results66

1. Attestation of Test Results

Applicant Name	APPLE INC.									
FCC ID	BCG-E8666A									
Model Name	A3083									
Reference SAR Report	14982436-S1									
Exposure Category	SAR Limits (W/Kg)								PD Limits (W/m ²)	
	Peak spatial-average (1g of tissue)				Extremities (hands, wrists, ankles, etc.) (10g of tissue)					
General Population (Uncontrolled Exposure)	1.6				4				10	
RF Exposure Conditions	Equipment Class - Highest Reported SAR (W/kg)								Highest Reported PD (W/m ²)	
	TNE	PCE	CBE	DTS	NII	6CD	DSS	DXX		
Head	0.904	0.998	0.954	1.093	0.284	0.011	0.614	N/A	3.340	
Body-worn (Dist.= 5 mm)	0.609	0.993	0.864	0.885	1.188	0.515	0.548	N/A		
Hotspot (Dist.= 5 mm)	0.660	0.993	0.980	1.122	1.188	N/A	0.672	N/A		
Extremities (Dist.= 0 mm)	2.396	N/A	N/A	N/A	N/A	0.515	N/A	0.001		
Simultaneous TX	Head	1.422	1.514	1.473	1.514	1.514	1.514	1.406		N/A
	Body-worn	1.162	1.546	1.417	1.580	1.580	1.580	1.546		N/A
	Hotspot	1.223	1.551	1.441	1.580	1.580	1.580	1.546		N/A
	Extremities	2.529	N/A	N/A	N/A	N/A	2.529	N/A		2.529
Date Tested	5/15/2024 to 7/8/2024									
<p>UL Verification Services Inc. tested the above equipment in accordance with the requirements set forth in the above standards. The test results show that the equipment tested is capable of demonstrating compliance with the requirements as documented in this report. This report contains data provided by the customer which can impact the validity of results. UL Verification Services Inc. is only responsible for the validity of results after the integration of the data provided by the customer. The results documented in this report apply only to the tested sample, under the conditions and modes of operation as described herein. It is the manufacturer's responsibility to assure that additional production units of this model are manufactured with identical electrical and mechanical components. All samples tested were in good operating condition throughout the entire test program. Measurement Uncertainties are published for informational purposes only and were not taken into account unless noted otherwise. This document may not be altered or revised in any way unless done so by UL Verification Services Inc. and all revisions are duly noted in the revisions section. Any alteration of this document not carried out by UL Verification Services Inc. will constitute fraud and shall nullify the document. This report must not be used by the client to claim product certification, approval, or endorsement by A2LA, NIST, or any agency of the U.S. Government, or any agency of the U.S. government.</p>										
Approved & Released By:					Prepared By:					
										
Devin Chang Senior Laboratory Engineer UL Verification Services Inc.					Remi Rodberg Senior Laboratory Technician UL Verification Services Inc.					

2. Introduction

The equipment under test (EUT) contains the Qualcomm modem supporting 2G/3G/4G/5G technologies and millimeter wave 5G NR bands. Both WWAN modems are enabled with Qualcomm's Smart Transmit feature with algorithms to control and manage transmitting power in real time and to ensure the time-averaged RF exposure from the WWAN modems are always in compliance with FCC requirements.

In addition to these WWAN modems, the EUT contains a different modem to support WLAN (time-averaging is not applied in WLAN modem).

The purpose of this Part 2 report is to demonstrate that the EUT complies with the FCC RF exposure requirement under varying transmission scenarios, thereby validating the Qualcomm Smart Transmit feature.

P_{limit} used in this report is determined and listed in the Part 0 report, and listed in the Part 1 report.

3. Varying Transmission Test Cases and Test Proposal

To validate time averaging feature and demonstrate the compliance in varying transmission conditions, the following transmission scenarios are covered in Part 2 tests:

1. During a time-varying Tx power transmission: Prove that the Smart Transmit feature accounts for Tx power variations in time accurately.
2. During a call disconnect and re-establish scenario: Prove that the Smart Transmit feature accounts for history of past Tx power transmissions accurately.
3. During technology/band handover: Prove that the Smart Transmit feature functions correctly during transitions in technology/band.
4. During DSI (Device State Index) change: Prove that the Smart Transmit feature functions correctly during transition from one DSI to another.
5. During antenna (or beam) switch: Prove that the Smart Transmit feature functions correctly during transitions in antenna (such as AsDiv scenario) or beams (different antenna array configurations).
6. SAR vs. PD exposure switching during Sub-6 + mmW transmission: Prove that the Smart Transmit feature functions correctly and ensures total RF exposure compliance during transitions in SAR dominant exposure, SAR + PD exposure, and PD dominant exposure scenarios.
7. During time window switch: Prove that the Smart Transmit feature correctly handles the transition from one time window to another specified by FCC while maintaining the normalized time-averaged RF exposure to be less than the normalized FCC limit of 1.0 W/kg at all times.
8. SAR exposure switching between two active radios (*radio1* and *radio2*): Prove that the Smart Transmit feature functions correctly and ensures total RF exposure compliance when exposure varies among *SAR_radio1* only, *SAR_radio1* + *SAR_radio2*, and *SAR_radio2* only scenarios.

As described in the Part 0 report, the RF exposure is proportional to the transmission power for a SAR- and PD-characterized wireless device. Thus, feature validation in Part 2 can be effectively performed through conducted (for $f < 6\text{GHz}$) and radiated (for $f \geq 6\text{GHz}$) power measurement. Therefore, the compliance demonstration under dynamic transmission conditions and feature validation are done in conducted/radiated power measurement setups for transmission scenarios 1 through 8.

To add confidence in the feature validation, the time-averaged SAR and PD measurements are also performed but only performed for transmission scenario 1 to avoid the complexity in SAR and PD measurement (such as, for scenario 3, requiring change in SAR probe calibration file to accommodate different bands and/or tissue simulating liquid).

The strategy for testing in varying transmission conditions are outlined as follows:

- Demonstrate the total RF exposure averaged over FCC's defined time windows do not exceed FCC's SAR and PD limits through time-averaged power measurements.
 - Measure conducted Tx power (for $f < 6\text{GHz}$) versus time, and radiated Tx power (EIRP for $f > 10\text{-GHz}$) versus time.
 - Convert the conducted Tx power into RF exposure and divide by the respective FCC limits to get the normalized exposure versus time.

- Perform the running time-averaging over the FCC's defined time windows.
- Demonstrate that the total normalized time-averaged RF exposure is less than 1 W/kg for all transmission scenarios (i.e., transmission scenarios 1 through 8), always.

Mathematical expression:

- For Sub-6 GHz transmission scenarios only:

$$1g \text{ or } 10g \text{ SAR}(t) = \frac{\text{conducted Tx power}(t)}{\text{conducted Tx power } P_{limit}} * 1g \text{ or } 10g \text{ SAR } P_{limit} \text{ (1a)}$$

$$\frac{\frac{1}{T_{SAR}} \int_{t-T_{SAR}}^t 1g \text{ or } 10g \text{ SAR}(t) dt}{FCC \text{ SAR limit}} \leq 1 \frac{W}{kg} \text{ (1b)}$$

- For Sub-6 GHz + mmW transmission:

$$1g \text{ or } 10g \text{ SAR}(t) = \frac{\text{conducted Tx power}(t)}{\text{conducted Tx power } P_{limit}} * 1g \text{ or } 10g \text{ SAR } P_{limit} \text{ (2a)}$$

$$4 \text{ cm}^2 \text{ PD}(t) = \frac{\text{radiated Tx power}(t)}{\text{radiated Tx power input.power.limit}} * 4 \text{ cm}^2 \text{ PD input. power. limit (2b)}$$

$$\frac{\frac{1}{T_{SAR}} \int_{t-T_{SAR}}^t 1g \text{ or } 10g \text{ SAR}(t) dt}{FCC \text{ SAR limit}} + \frac{\frac{1}{T_{PD}} \int_{t-T_{PD}}^t 4 \text{ cm}^2 \text{ PD}(t) dt}{FCC 4 \text{ cm}^2 \text{ PD limit}} \leq 1 \frac{W}{kg} \text{ (2c)}$$

where, *conducted Tx power(t)*, *conducted Tx power P_{limit}*, and *1-g or 10-g SAR P_{limit}* correspond to the measured instantaneous conducted Tx power, measured conducted Tx power at P_{limit}, and measured 1-g SAR or 10-g SAR values at P_{limit} corresponding to Sub-6 GHz transmission. Similarly, *radiated Tx power(t)*, *radiated Tx power P_{limit}*, and *4 cm² PD P_{limit}* correspond to the measured instantaneous radiated Tx power, radiated Tx power at P_{limit} (i.e., radiated power limit), and 4 cm² PD value at P_{limit} corresponding to mmW transmission. P_{limit}(i) are the parameters pre-defined in Part 0 and loaded via *Embedded File System (EFS)* onto the EUT. T_{SAR} is the FCC defined time window for Sub-6 GHz radio; T_{PD} is the FCC defined time window for mmW radio.

- Demonstrate the total RF exposure averaged over FCC's defined time windows do not exceed FCC's SAR and PD limits through time-averaged SAR and PD measurements. Note, as mentioned earlier, this measurement is performed for transmission scenario 1 only.
 - For Sub-6 GHz transmission only: Measure instantaneous SAR versus time; for LTE + Sub-6 GHz NR transmission: Request low power (or all-down bits) on LTE so that measured SAR predominantly corresponds to Sub-6 GHz NR.
 - For LTE + mmW transmission: Measure instantaneous E-field versus time for mmW radio and instantaneous conducted power versus time for the LTE radio.
 - Convert the result into RF exposure and divide by the respective FCC limits to obtain the normalized exposure versus time.
 - Perform time averaging over FCC defined time window.
 - Demonstrate that the total normalized time-average RF exposure is less than 1 W/kg for transmission scenario 1, always.

Mathematical expression:

- For Sub-6 GHz transmission only:

$$1g \text{ or } 10g \text{ SAR}(t) = \frac{\text{pointSAR}(t)}{\text{pointSAR } P_{limit}} * 1g \text{ or } 10g \text{ SAR}(t) P_{limit} \text{ (3a)}$$

$$\frac{\frac{1}{T_{SAR}} \int_{t-T_{SAR}}^t 1g \text{ or } 10g \text{ SAR}(t) dt}{FCC \text{ SAR limit}} \leq 1 \frac{W}{kg} \text{ (3b)}$$

- For LTE + mmW transmission:

$$1g \text{ or } 10g \text{ SAR}(t) = \frac{\text{conducted Tx power}(t)}{\text{conducted Tx power } P_{limit}} * 1g \text{ or } 10g \text{ SAR } P_{limit} \text{ (4a)}$$

$$4 \text{ cm}^2 \text{ PD}(t) = \frac{[\text{point}E(t)]^2}{[\text{point}E \text{ input.power.limit}]^2} * 4 \text{ cm}^2 \text{ PD } P_{\text{limit}} \quad (4b)$$

$$\frac{\frac{1}{T_{\text{SAR}}} \int_{t-T_{\text{SAR}}}^t 1g \text{ or } 10g \text{ SAR}(t) dt}{\text{FCC SAR limit}} + \frac{\frac{1}{T_{\text{PD}}} \int_{t-T_{\text{PD}}}^t 4 \text{ cm}^2 \text{ PD}(t) dt}{\text{FCC } 4 \text{ cm}^2 \text{ PD limit}} \leq 1 \frac{W}{kg} \quad (4c)$$

where, $\text{pointSAR}(t)$, $\text{pointSAR } P_{\text{limit}}$, and 1-g or $10\text{-g SAR } P_{\text{limit}}$ correspond to the measured instantaneous point SAR, measured point SAR at P_{limit} , and measured 1-g SAR or 10-g SAR values at P_{limit} corresponding to Sub-6 GHz transmission. Similarly, $\text{point}E(t)$, $\text{point}E P_{\text{limit}}$, and $4 \text{ cm}^2 \text{ PD } P_{\text{limit}}$ correspond to the measured instantaneous E-field, E-field at P_{limit} , and $4 \text{ cm}^2 \text{ PD}$ value at P_{limit} corresponding to mmW transmission.¹

4. SAR Time Averaging Validation Test Procedures

This chapter provides the test plan and test procedures for validating Qualcomm Smart Transmit feature for Sub-6 GHz transmission. The 100 seconds time window for operating $f < 3$ GHz is used as an example to detail the test procedures in this chapter. The same test plan and test procedures described in this chapter apply to 60 seconds time window for operating $f \geq 3$ GHz.

4.1. Test Sequence Determination for Validation

Following the FCC recommendation, two test sequences² having time-variation in Tx power are predefined for sub-6 GHz ($f < 6$ GHz) validation:

- Test sequence 1: Request EUT's Tx power to be at maximum power, measured P_{max} , for 80s, then requesting for half of the maximum power, i.e., measured $P_{\text{max}}/2$, for the rest of the time.
- Test sequence 2: Request EUT's Tx power to vary with time. This sequence is generated relative to measured P_{max} , measured P_{limit} and calculated P_{reserve} (= measured P_{limit} in dBm – *Reserve power margin* in dB) of the EUT based on measured P_{limit} .

The details for generating these two test sequences are described and listed in Appendix A.

4.2. Test Configuration Selection Criteria for Validating Smart Transmit Feature

For validating the Smart Transmit feature, this section provides a general guidance to select test cases. In practice, an adjustment can be made in test case selection. The justification/clarification may be provided.

4.2.1. Test Configuration Selection for Time-varying Transmission Power

The Smart Transmit time averaging feature operation is independent of bands, modes, and channels for a given technology. Hence, validation of Smart Transmit in one band/mode/channel per technology is sufficient. Two bands per technology are proposed and selected for this testing to provide high confidence in this validation.

¹ cDASY6 measurement system by Schmid & Partner Engineering AG (SPEAG) of Zurich, Switzerland measures relative E-field, and provides ratio of $\frac{[\text{point}E(t)]^2}{[\text{point}E \text{ input.power.limit}]^2}$ versus time.

² For test sequence generation, “measured P_{limit} ” and “measured P_{max} ” are used instead of the “ P_{limit} ” specified in EFS entry and “ P_{max} ” specified for the device, because Smart Transmit feature operates against the actual power level of the “ P_{limit} ” that was calibrated for the EUT. The “measured P_{limit} ” accurately reflects what the feature is referencing to, therefore, it should be used during feature validation testing. The RF tune-up and device-to-device variation are already considered in the Part 0 report prior to determining P_{limit} .

The criteria for the selection are based on the P_{limit} values determined in the Part 0 report. Select two bands³ in each supported technology that correspond to least⁴ and highest⁵ P_{limit} values that are less than P_{max} for validating Smart Transmit.

4.2.2. Test Configuration Selection for Change in Call

The criteria to select a test configuration for call-drop measurement is:

- Select the technology/band with the least P_{limit} among all supported technologies/bands and select the radio configuration (e.g., # of RBs, channel#) in this technology/band that corresponds to the highest measured 1-g SAR at P_{limit} listed in the Part 1 report.
- In case of multiple bands having the same least P_{limit} , select the band having the highest measured 1-g SAR at P_{limit} in the Part 1 report.

This test is performed with the EUT's Tx power requested to be at maximum power, the above band selection will result in Tx power enforcement (i.e., EUT forced to have Tx power at $P_{reserve}$) for its longest duration in one FCC defined time window. The call change (call drop/reestablish) is performed during the Tx power enforcement duration (i.e., during the time when EUT is forced to have Tx power at $P_{reserve}$). One test is sufficient as the feature operation is independent of technology and band.

4.2.3. Test Configuration Selection for Change in Technology/Band

The selection criteria for this measurement is, for a given antenna, to have the EUT switch from a technology/band with the lowest P_{limit} within the technology group (in case of multiple bands having the same P_{limit} , then select the band with highest measured 1-g SAR at P_{limit}) to a technology/band with the highest P_{limit} within the technology group (in case of multiple bands having the same P_{limit} , then select the band with lowest measured 1-g SAR at P_{limit} in the Part 1 report, or vice versa).

This test is performed with the EUT's Tx power requested to be at maximum power, the technology/band switch is performed during Tx power enforcement duration (i.e., during the time when EUT is forced to have Tx power at $P_{reserve}$).

4.2.4. Test Configuration Selection for Change in Antenna

The criteria to select a test configuration for antenna switch measurement is:

- Whenever possible, and supported by the EUT, first select an antenna switch configuration within the same technology/band (i.e., same technology and band combination).
- Select any technology/band that supports multiple Tx antennas and has the highest difference in P_{limit} among all supported antennas.
- In case of multiple bands having the same difference in P_{limit} among supported antennas, select the band having the highest measured 1-g SAR at P_{limit} in the Part 1 report.

This test is performed with the EUT's Tx power requested to be at maximum power in a selected technology/band and antenna change is conducted during Tx power enforcement duration (i.e., during the time when EUT is forced to have Tx power at Preserve).

³ If one P_{limit} level applies to all the bands within a technology, then only one band needs to be tested. In this case, within the bands having the same P_{limit} , the radio configuration (e.g., # of RBs, channel#) and device position that correspond to the highest measured 1-g SAR at P_{limit} shown in the Part 1 report is selected.

⁴ In case of multiple bands having the same least P_{limit} within the technology, then select the band having the highest measured 1-g SAR at P_{limit} .

⁵ The band having a higher P_{limit} needs to be properly selected so that the power limiting enforced by Smart Transmit can be validated using the pre-defined test sequences. If the highest P_{limit} in a technology is too high where the power limiting enforcement is not needed when testing with the pre-defined test sequences, then the next highest level is checked. This process is continued within the technology until the second band for validation testing is determined.

4.2.5. Test Configuration Selection for Change in DSI

The criteria to select a test configuration for DSI change is:

- Select a technology/band having the $P_{limit} < P_{max}$ within any technology and DSI group and for the same technology/band having a different P_{limit} in any other DSI group. Note that the selected DSI transition needs to be supported by the device.

This test is performed with the EUT's Tx power requested to be at maximum power in selected technology/band, and DSI change is conducted during Tx power enforcement duration (i.e., during the time when EUT is forced to have Tx power at $P_{reserve}$).

4.2.6. Test Configuration Selection for Change in Time Window

The FCC specifies different time windows for time averaging based on operation frequency. The criteria to select a test configuration for validating the Smart Transmit feature and demonstrating the compliance during the change in time window is:

- Select any technology/band that has an operation frequency classified in one time window defined by the FCC (such as 100-seconds time window) and its corresponding P_{limit} is less than P_{max} if possible.
- Select the second technology/band that has an operation frequency classified in a different time window defined by the FCC (such as 60-seconds time window) and its corresponding P_{limit} is less than P_{max} if possible.
- Note it is preferred both P_{limit} values of two selected technologies/bands are less than the corresponding P_{max} ; if this is not possible, at least one of technologies/bands has its P_{limit} less than P_{max} .

This test is performed with the EUT's Tx power requested to be at maximum power in selected technology/band. Test for one pair of time windows selected is sufficient as the feature operation is the same.

4.2.7. Test Configuration Selection for SAR Exposure Switching

If supported, the test configuration for SAR exposure switching should cover:

1. SAR exposure switch when two active radios are in the same time window.
2. SAR exposure switch when two active radios are in different time windows. One test with two active radios in any two different time windows is sufficient as the Smart Transmit operation is the same for RF exposure switch in any combination of two different time windows. For devices supporting LTE + mmW NR, this test is covered in §9.2.3 and §9.2.4.

The Smart Transmit time averaging operation is independent of the source of SAR exposure (for example, LTE vs. Sub-6 GHz NR) and ensures total time-averaged RF exposure compliance. Hence, validation of Smart Transmit in any one simultaneous SAR transmission scenario (i.e., one combination for LTE + Sub-6 GHz NR transmission) is sufficient, where the SAR exposure varies among SAR_{radio1} only, $SAR_{radio1} + SAR_{radio2}$, and SAR_{radio2} only scenarios.

The criteria to select a test configuration for validating the Smart Transmit feature during SAR exposure switching scenario is:

- Select any two < 6 GHz technologies/bands that the EUT supports simultaneous transmission (for example, LTE + Sub-6 GHz NR).
- Among all supported simultaneous transmission configurations, the selection order is:
 1. Select one configuration where both P_{limit} of radio1 and radio2 is less than their corresponding P_{max} , preferable with different P_{limits} . If this configuration is not available, then
 2. Select one configuration that has P_{limit} less than its P_{max} for at least one radio. If this cannot be found, then
 3. Select one configuration that has P_{limit} of radio1 and radio2 greater than P_{max} , but with the least delta between the two ($P_{limit} - P_{max}$).

Test for one simultaneous transmission scenario is sufficient as the feature operation is the same.

4.3. Test Procedures for Conducted Power Measurements

This section provides general conducted power measurement procedures to perform compliance test under dynamic transmission scenarios described in §3. In practice, an adjustment can be made in these procedures. The justification/clarification may be provided.

4.3.1. Time-varying Transmission Power Scenario

This test is performed with the two pre-defined test sequences described in §4.1 for all the technologies and bands selected in §4.2.1. The purpose of the test is to demonstrate the effectiveness of power limiting enforcement and that the time-averaged SAR (corresponding time-averaged Tx power) does not exceed the FCC limit at all times (see Eq. (1a) and (1b)).

Test Procedure:

1. Measure P_{max} , measure P_{limit} , and calculate $P_{reserve}$ (= measured P_{limit} in dBm – Reserve_power_margin in dB) and follow §4.1 to generate the test sequences for all the technologies and bands selected in §4.2.1. Both test sequence 1 and test sequence 2 are created based on measured P_{max} and measured P_{limit} of the EUT. Test conditions to measure P_{max} and P_{limit} are:
 - a. Measure P_{max} with Smart Transmit **disabled** and the callbox set to request maximum power.
 - b. Measure P_{limit} with Smart Transmit **enabled**, Reserve_power_margin set to 0 dB, and the callbox set to request maximum power.
2. Set Reserve_power_margin to actual (intended) value and reset power on EUT to enable Smart Transmit, establish a radio link in the desired radio configuration, with callbox requesting the EUT’s Tx power to be at a pre-defined test sequence 1, measure and record Tx power versus time and then convert the conducted Tx power into 1-g SAR or 10-g SAR value (see Eq. (1a)⁶) using measured P_{limit} from Step 1. Perform a running time average⁷ to determine time-averaged power and 1-g SAR or 10-g SAR versus time, as illustrated in Figure 4-1 where using 100-seconds time window as an example.

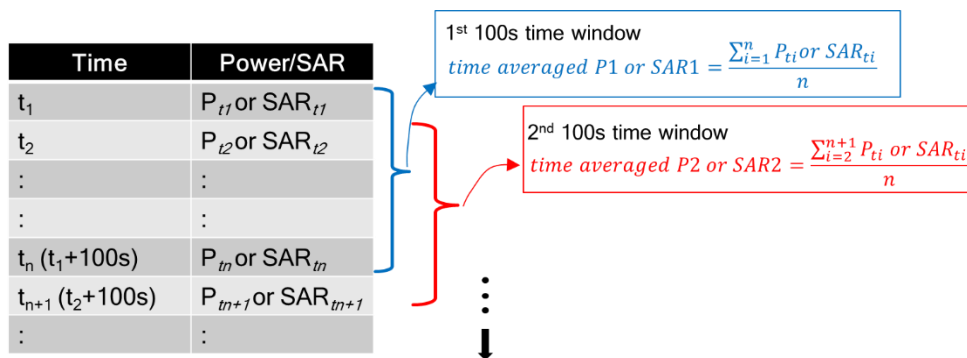

Figure 4-1: 100 seconds running average illustration

3. Make one plot containing:
 - a. Instantaneous Tx power versus time measured in Step 2.
 - b. Requested Tx power used in Step 2 (test sequence 1).
 - c. Computed time-average power versus time determined in Step 2.
 - d. Time-averaged power limit (corresponding to FCC SAR limit of 1.6 W/kg for 1-g SAR or 4.0 W/kg for 10-g SAR) given by:

$$Time\ averaged\ power\ limit = meas.P_{limit} + 10 * \log\left(\frac{FCC\ SAR\ limit}{meas.SAR\ P_{limit}}\right) \quad (5a)$$

⁶ In Eq.(1a), instantaneous Tx power is converted into instantaneous 1-g SAR or 10-g SAR value by applying the measured worst-case 1-g SAR or 10-g SAR value at P_{limit} for the corresponding technology/band/antenna/DSI reported in the Part 1 report.

⁷ For an easier computation of the running time average, 0 dBm can be added at the beginning of the test sequences. The length of the responding time window, for example, add 0dBm for 100-seconds so the running time average can be directly performed starting with the first 100-seconds data using excel spreadsheet. This technique applies to all tests performed in this Part 2 report for easier time-averaged computation using excel spreadsheet.

where $meas.P_{limit}$ and $meas.SAR P_{limit}$ corresponds to measured power at P_{limit} and measured SAR at P_{limit} .

4. Make another plot containing:
 - a. Computed time-averaged 1-g SAR or 10-g SAR versus time determined in Step 2.
 - b. FCC 1-g SAR_{limit} of 1.6 W/kg or FCC 10-g SAR_{limit} of 4.0 W/kg.
5. Repeat Steps 2 through 4 for pre-defined test sequence 2 and replace the requested Tx power (test sequence 1) in Step 2 with test sequence 2.
6. Repeat Steps 2 through 5 for all the selected technologies and bands.

The validation criteria are, at all times, the time-averaged power versus time, shown in Step 3's plot, where the result shall not exceed the time-averaged power limit (defined in Eq. (5a)); in turn, the time-averaged 1-g SAR or 10-g SAR versus time, shown in Step 4's plot, shall not exceed the FCC limit of 1.6 W/kg for 1-g SAR or 4.0 W/kg for 10-g SAR (i.e., Eq. (1b)).

4.3.2. Change in Call Scenario

This test is to demonstrate that the Smart Transmit feature accurately accounts for the past transmission powers during time-averaging when a new call is established.

The call disconnection and re-establishment need to be performed during power limit enforcement, i.e., when the EUT's transmission power is at $P_{reserve}$ level, to demonstrate the continuity of RF exposure management and limiting in call change scenario. In other words, the RF exposure averaged over any FCC defined time window (including the time windows containing the call change) does not exceed the FCC limit of 1.6 W/kg for 1-g SAR or 4.0 W/kg for 10-g SAR.

Test Procedure

1. Measure P_{limit} for the technology/band selected in §4.2.2. Measure P_{limit} with Smart Transmit enabled and $Reserve_power_margin$ set to 0 dB, and the callbox set to request maximum power.
2. Set $Reserve_power_margin$ to actual (intended) value and reset power on EUT to enable Smart Transmit.
3. Establish radio link with callbox in the selected technology/band.
4. Request EUT's transmission power at 0 dBm for at least one-time window specified for the selected technology/band, followed by requesting EUT's transmission power to be at maximum power for about ~60 seconds, and then drop the call for ~10 seconds. Afterwards, re-establish another call in the same radio configuration (i.e., same technology/band/channel) and continue callbox requesting EUT's transmission power to be at maximum power for the remaining time of at least another full duration of the specified time window. Measure and record the transmission power versus time. Once the measurement is done, extract instantaneous transmission power versus time, convert the measured conducted transmission power into 1-g SAR or 10-g SAR values using Eq. (1a), and then perform the running time average to determine time-averaged power and 1-g SAR or 10-g SAR versus time.⁸
5. Make one plot containing: (a) Instantaneous Tx power versus time, (b) requested power, (c) computed time-averaged power, (d) time-averaged power limit calculated using Eq.(5a).
6. Make another plot containing: (a) Computed time-averaged 1-g SAR or 10-g SAR versus time, and (b) FCC limit of 1.6 W/kg for 1-g SAR or 4.0 W/kg for 10-g SAR.

The time-averaged power versus time shall not exceed the time-averaged power limit (defined in Eq.(5a)) and, in turn, the time-averaged 1-g SAR or 10-g SAR versus time shall not exceed the FCC limit of 1.6 W/kg for 1-g SAR or 4.0 W/kg for 10-g SAR (i.e., Eq. (1b)).

⁸ In Eq.(1a), the instantaneous transmission power is converted into instantaneous 1-g SAR or 10-g SAR value by applying the measured worst-case 1-g SAR or 10-g SAR value at P_{limit} for the corresponding technology/band/antenna/DSI reported in the Part 1 report.

4.3.3. Change in Technology and Band

This test is to demonstrate the correct power control by Smart Transmit during technology switches and/or band handovers.

Like the *Change in Call Scenario* test in §4.3.2, to validate the continuity of RF exposure limiting during the transition, the technology and band handover needs to be performed when EUT's transmission power is at $P_{reserve}$ level (i.e., during transmission power enforcement) to make sure that the EUT's transmission power from previous $P_{reserve}$ level to the new $P_{reserve}$ level (corresponding to new technology/band). Since the P_{limit} could vary with technology and band, Eq. (1a) can be written as follows to convert the instantaneous transmission power in 1-g SAR or 10-g SAR exposure for the two given radios, respectively:

$$1g \text{ or } 10g \text{ SAR}_1(t) = \frac{\text{conducted}_{Tx \text{ power } 1(t)}}{\text{conducted}_{Tx \text{ power } P_{limit 1}}} * 1g \text{ or } 10g \text{ SAR } P_{limit 1} \quad (7a)$$

$$1g \text{ or } 10g \text{ SAR}_2(t) = \frac{\text{conducted}_{Tx \text{ power } 2(t)}}{\text{conducted}_{Tx \text{ power } P_{limit 2}}} * 1g \text{ or } 10g \text{ SAR } P_{limit 2} \quad (7b)$$

$$\frac{1}{T_{SAR}} \left[\int_{t-T_{SAR}}^{t_1} \frac{1g \text{ or } 10g \text{ SAR}_1(t)}{FCC \text{ SAR limit}} dt + \int_{t-T_{SAR}}^t \frac{1g \text{ or } 10g \text{ SAR}_2(t)}{FCC \text{ SAR limit}} dt \right] \leq 1 \quad (7c)$$

where, $\text{conducted}_{Tx \text{ power } 1(t)}$, $\text{conducted}_{Tx \text{ power } P_{limit 1}}$, and $1g \text{ or } 10g \text{ SAR } P_{limit 1}$ correspond to the measured instantaneous conducted transmission power, measured conducted transmission power at P_{limit} , and measured 1-g SAR or 10-g SAR value at P_{limit} of technology1/band1; $\text{conducted}_{Tx \text{ power } 2(t)}$, $\text{conducted}_{Tx \text{ power } P_{limit 2}}$, and $1g \text{ or } 10g \text{ SAR } P_{limit 2}$ correspond to the measured instantaneous conducted transmission power, measured conducted transmission power at P_{limit} , and measured 1-g SAR or 10-g SAR value at P_{limit} of technology2/band2. Transition from technology1/band1 to the technology2/band2 happens at time-instant ' t_1 '.

Test Procedure

1. Measure P_{limit} for both the technologies and bands selected in §4.2.3. Measure the P_{limit} with Smart Transmit enabled and set *Reserve_power_margin* to 0 dB, and the callbox set to request maximum power.
2. Set *Reserve_power_margin* to actual (intended) value and reset power on the EUT to enable Smart Transmit.
3. Establish a radio link with the callbox in the first technology/band selected.
4. Request the EUT's transmission power to be 0 dBm for at least one-time window specified for the selected technology/band, followed by requesting the EUT's transmission power to be at maximum power for about ~60 seconds, and then switch to the second technology/band selected. Continue with the callbox requesting the EUT's transmission power to be at maximum power for the remaining time or, at least, for another full duration of the specified time window. Measure and record the transmission power versus time for the full duration of the test.
5. Once the measurement is done, extract the instantaneous transmission power versus time and convert the conducted transmission power into a 1-g SAR or 10-g SAR value using Eq. (7a) and (7b) and corresponding measured P_{limit} values from Step 1 of this section. Perform the running time average to determine time-averaged power and 1-g SAR or 10-g SAR versus time.⁹
6. Make one plot containing: (a) Instantaneous transmission power versus time, (b) requested power, (c) computed time-averaged power, (d) time-averaged power limit calculated using Eq.(5a).
7. Make another plot containing: (a) Computed time-averaged 1-g SAR or 10-g SAR versus time, and (b) FCC limit of 1.6 W/kg for 1-g SAR or 4.0 W/kg for 10-g SAR.

The time-averaged 1-g SAR or 10-g SAR versus time shall not exceed the FCC limit of 1.6 W/kg for 1-g SAR or 4.0 W/kg for 10-g SAR (i.e., Eq. (7c)).

⁹ In Eq.(7a) and (7b), instantaneous transmission power is converted into instantaneous 1-g SAR or 10-g SAR value by applying the measured worst-case 1-g SAR or 10-g SAR value at P_{limit} for the corresponding technology/band/antenna/DSI reported in the Part 1 report.

4.3.4. Change in Antenna

This test is to demonstrate the correct power control by Smart Transmit during an antenna switch, i.e., switching from one antenna to another. The test procedure is identical to §4.3.3, by replacing technology/band switch operation with an antenna switch. The time-averaged 1-g SAR or 10-g SAR versus time shall not exceed FCC limit of 1.6 W/kg for 1-g SAR or 4.0 W/kg for 10-g SAR.¹⁰

4.3.5. Change in DSI

This test is to demonstrate the correct power control by Smart Transmit during a DSI switch, i.e., switching from one DSI state to another. The test procedure is identical to §4.3.3, by replacing technology/band switch operation with a DSI switch. The time-averaged 1-g SAR or 10-g SAR versus time shall not exceed FCC limit of 1.6 W/kg for 1-g SAR or 4.0 W/kg for 10-g SAR.

4.3.6. Change in Time Window

This test is to demonstrate the correct power control by Smart Transmit during the change in averaging time window when a specific band handover occurs. The FCC specifies time-averaging windows of 100 seconds for transmission frequencies < 3 GHz, and 60 seconds for transmission frequencies between 3 GHz and 6 GHz.

To validate the continuity of RF exposure limiting during the transition, the band handover test needs to be performed when the EUT handovers from one operating band less than 3 GHz to greater than 3 GHz, and vice versa. The equations (3a) and (3b) in §2 can be written as follows for transmission scenarios having a change in time windows:

$$1g SAR_1(t) = \frac{\text{conducted}_{Tx \text{ power } 1(t)}}{\text{conducted}_{Tx \text{ power } P_{limit 1}}} * 1g \text{ or } 10g SAR P_{limit 1} \quad (7a)$$

$$1g SAR_2(t) = \frac{\text{conducted}_{Tx \text{ power } 2(t)}}{\text{conducted}_{Tx \text{ power } P_{limit 2}}} * 1g \text{ or } 10g SAR P_{limit 2} \quad (7b)$$

$$\frac{1}{T_{1SAR}} \left[\int_{t-T_{1SAR}}^{t_1} \frac{1g \text{ or } 10g SAR_1(t)}{FCC SAR limit} dt \right] + \frac{1}{T_{2SAR}} \left[\int_{t-T_{2SAR}}^t \frac{1g \text{ or } 10g SAR_2(t)}{FCC SAR limit} dt \right] \leq 1 \quad (7c)$$

where, $\text{conducted}_{Tx \text{ power } 1(t)}$, $\text{conducted}_{Tx \text{ power } P_{limit 1}(t)}$, and $1g \text{ or } 10g SAR P_{limit 1}$ correspond to the instantaneous transmission power, conducted transmission power at P_{limit} , and compliance $1g \text{ or } 10g SAR$ values at $P_{limit 1}$ of band1 with the time-averaging window ' T_{1SAR} '; $\text{conducted}_{Tx \text{ power } 2(t)}$, $\text{conducted}_{Tx \text{ power } P_{limit 2}(t)}$, and $1g \text{ or } 10g SAR P_{limit 2}$ correspond to the instantaneous transmission power, conducted transmission power at P_{limit} , and compliance $1g \text{ or } 10g SAR$ values at $P_{limit 2}$ of band2 with the time-averaging window ' T_{2SAR} '. One of the two bands is less than 3 GHz, another is greater than 3 GHz. Transition from first band with time-averaging window ' T_{1SAR} ' to the second band with time-averaging window ' T_{2SAR} ' happens at time-instant ' t_1 '.

Test Procedure

1. Measure P_{limit} for both the technologies and bands selected in §4.2.6. Measure P_{limit} with Smart Transmit enabled and set Reserve_power_margin to 0 dB, and the callbox set to request maximum power.
2. Set Reserve_power_margin to actual (intended) value and enable Smart Transmit.

Transition from 100 seconds time window to 60 seconds time window, and vice versa

3. Establish radio link with the callbox in the technology/band having 100 seconds time window selected in §4.2.6.
4. Request the EUT's transmission power to be at 0 dBm for at least 100 seconds, followed by requesting the EUT's transmission power to be at maximum power for about ~140 seconds, and then switch to the second technology/band (having 60 seconds time window) selected in §4.2.6. Continue with the callbox requesting the EUT's transmission power to be at maximum power for about ~60 seconds in this second technology/band, and then switch back to the first technology/band. Continue with the callbox requesting the

¹⁰ If the EUT does not support antenna switching within the same technology/band, but has multiple antennas that support different frequency bands, then the antenna switch test is included as part of change in technology and band test (§4.3.3).

EUT's transmission power to be at maximum power for at least another 100 seconds. Measure and record the transmission power versus time for the entire duration of the test.

5. Once the measurement is done, extract the instantaneous transmission power versus time and convert the conducted transmission power into 1-g SAR or 10-g SAR value (see Eq. (7a) and (7b)) using the corresponding technology/band in Step 1's result, then perform 100 seconds running average to determine time-averaged 1-g SAR or 10-g SAR versus time.¹¹
6. Make one plot containing: (a) Instantaneous transmission power versus time measured in Step 4.
7. Make another plot containing: (a) Instantaneous 1-g SAR versus time determined in Step 5, (b) computed time-averaged 1-g SAR versus time determined in Step 5, and (c) corresponding regulatory 1-g SAR_{limit} of 1.6W/kg or 10-g SAR_{limit} of 4.0W/kg.

Transition from 60 seconds time window to 100 seconds time window, and vice versa

8. Establish radio link with the callbox in the technology/band having a 60 second time window selected in §4.2.6.
9. Request the EUT's transmission power to be at 0 dBm for at least 60 seconds, followed by requesting the EUT's transmission power to be at maximum power for about ~80 seconds, and then switch to the second technology/band (having 100 seconds time window) selected in §4.2.6. Continue with the callbox requesting the EUT's transmission power to be at maximum power for about ~100 seconds in this second technology/band, and then switch back to the first technology/band. Continue with the callbox requesting the EUT's transmission power to be at maximum power for the remaining time for a total test time of 500 seconds. Measure and record the transmission power versus time for the entire duration of the test.
10. Repeat Step 5~7 to generate the plots.

The time-averaged 1-g SAR or 10-g SAR versus time shall not exceed the regulatory 1-g SAR_{limit} of 1.6W/kg or 10-g SAR_{limit} of 4.0W/kg.

4.3.7. SAR Exposure Switching

This test is to demonstrate that the Smart Transmit feature is accurately accounting for switching in exposures among SAR from radio1 only, SAR from both radio1 and radio2, and SAR from radio2 only scenarios, and ensures total time-averaged RF exposure complies with the FCC limit. Here, radio1 represents the primary radio (for example, LTE anchor in a NR non-standalone mode call) and radio2 represents secondary radio (for example, Sub-6 GHz NR or mmW NR). The detailed test procedure for SAR exposure switching in the case of LTE+Sub-6 GHz NR non-standalone mode transmission scenario is provided in Appendix B.2.

Test Procedure

1. Measure the conducted transmission power corresponding to P_{limit} for radio1 and radio2 in the selected band. The test conditions to measure conducted P_{limit} are:
 - a. Establish a device in call with the callbox for radio1 technology/band. Measure the conducted transmission power corresponding to radio1 P_{limit} with Smart Transmit enabled, set *Reserve_power_margin* to 0 dB, and set the callbox to request maximum power.
 - b. Repeat Step 1a to measure the conducted transmission power corresponding to radio2 P_{limit} . If radio2 is dependent on radio1 (for example, non-standalone mode of Sub-6 GHz NR requiring radio1 LTE as an anchor), then establish radio1 + radio2 call with the callbox and request all down bits for radio1 LTE. In this scenario, set the callbox to request maximum power from radio2 Sub-6 GHz NR, then measure the conducted transmission power that corresponds to radio2's P_{limit} (as radio1 LTE is at all-down bits).
2. Set *Reserve_power_margin* to actual (intended) value, with the EUT setup for radio1 + radio2 call. In this description, it is assumed that radio2 has lower priority than radio1. Establish the device in radio1+radio2 call and request all-down bits or low power on radio1, with the callbox requesting the EUT's transmission power to be at maximum power in radio2 for at least one-time window. After one time window, set the callbox to request the EUT's transmission power to be at maximum power on radio1, i.e., all-up bits. Continue radio1 + radio2 call with both radios at maximum power for at least one-time window and drop (or request all-down bits on) radio2. Continue radio1 at maximum power for at least one-time window. Record the conducted transmission power for both radio1 and radio2 for the entire duration of this test.

¹¹ In Eq.(7a) & (7b), instantaneous transmission power is converted into instantaneous 1-g SAR or 10-g SAR value by applying the worst-case 1-g SAR or 10-g SAR value tested in Part 1 for the selected technologies/bands at P_{limit} .

3. Once the measurement is done, extract instantaneous transmission power versus time for both radio1 and radio2 links. Convert the conducted transmission power for both these radios into 1-g SAR or 10-g SAR value (see Eq. (7a) and (7b)) using the corresponding technology/band P_{limit} measured in Step 1, and then perform the running time average to determine time-averaged 1-g SAR or 10-g SAR versus time.
4. Make one plot containing: (a) Instantaneous transmission power versus time measured in Step 2.
5. Make another plot containing: (a) Instantaneous 1-g SAR versus time determined in Step 3, (b) computed time-averaged 1-g SAR versus time determined in Step 3, and (c) corresponding regulatory 1-g SAR_{limit} of 1.6W/kg or 10-g SAR_{limit} of 4.0W/kg.

The time-averaged 1-g SAR or 10-g SAR versus time shall not exceed the regulatory 1-g SAR_{limit} of 1.6W/kg or 10-g SAR_{limit} of 4.0W/kg.

4.4. Test Procedure for Time-varying SAR Measurements

This section provides general time-varying SAR measurement procedures to perform compliance test under dynamic transmission scenarios described in §3. In practice, an adjustment can be made in these procedures. The justification/clarification may be provided.

To perform the validation through SAR measurement for transmission scenario 1 described in §3, the “path loss” between callbox, antenna, and EUT need to be calibrated to ensure that the EUT’s transmission power reacts to the requested power from the callbox in a radiated call. It should be noted that when signaling in closed loop mode, protocol-level power control is in play, resulting in the EUT not solely following the callbox’s TPC (transmit power control) commands. In other words, the EUT response has many dependencies (RSSI, quality of signal, path loss variation, fading, etc.) other than just TPC commands. These dependencies have less impact in conducted setup (as it is a controlled environment and the path loss can be very well calibrated) but have significant impact on radiated testing in an uncontrolled environment, such as a SAR test setup. Therefore, the deviation in EUT transmit power from the callbox’s requested power is expected, however the time-averaged SAR should not exceed the FCC SAR requirements as Smart Transmit controls the transmission power at the EUT.

The following steps are for time averaging feature validation through SAR measurement:

1. “Path Loss” calibration: Place the EUT against the phantom in the worst-case position determined based on §4.2.1. For each band selected, prior to SAR measurement, perform the “path loss” calibration between callbox, antenna, and EUT. Since the SAR test environment is not controlled and well calibrated for OTA (Over the Air) test, extreme care needs to be taken to avoid the influence of reflections. The test setup is described in §8.1.
2. Time averaging feature validation:
 - a. For a given radio configuration (technology/band) selected in §4.2.1, enable Smart Transmit and set *Reserve_power_margin* to 0 dB, with the callbox set to request maximum power. Perform an area scan, conduct a *pointSAR* (single point) measurement at the peak location of the area scan. This *pointSAR* value, *pointSAR P_{limit}*, corresponds to *pointSAR* at the measured P_{limit} (i.e., measured P_{limit} from the EUT in Step 1 of §4.3.1).
 - b. Set *Reserve_power_margin* to actual (intended) value and reset power on the EUT to enable Smart Transmit.¹² Establish radio link in desired radio configuration, with the callbox requesting the EUT’s transmission power at power levels described by test sequence 1 generated in Step 1 of §4.3.1, conduct *pointSAR* measurement versus time at peak location of the area scan determined in Step 2a of this section. Once the measurement is done, extract the instantaneous *pointSAR* versus time data, *pointSAR(t)*, and convert it into instantaneous 1-g SAR or 10-g SAR versus time using Eq. (3a), re-written below:

$$1g \text{ or } 10gSAR(t) = \frac{pointSAR(t)}{pointSAR P_{limit}} * 1g \text{ or } 10gSAR P_{limit} \quad (3a)$$

where, *pointSAR P_{limit}* is the value determined in Step 2a, and *pointSAR(t)* is the instantaneous *pointSAR* measured in Step 2b, *1-g or 10-g SAR P_{limit}* is the measured 1-g SAR or 10-g SAR value listed in the Part 1 report.

- c. Perform 100 seconds running average to determine time-averaged 1-g SAR or 10-g SAR versus time.
- d. Make one plot containing: (a) Time-averaged 1-g SAR or 10-g SAR versus time determined in Step 2c of this section, (b) FCC limit of 1.6 W/kg for 1-g SAR or 4.0 W/kg for 10-g SAR.

¹² If *Reserve_power_margin* cannot be set wirelessly, care must be taken to re-position the EUT in the exact same position relative to the SAM phantom as in Step 2a.

- e. Repeat 2b ~ 2d for test sequence 2 generated in Step 1 of §4.3.1.
- f. Repeat 2a ~ 2e for all the technologies and bands selected in §4.2.1.

The time-averaged 1-g SAR or 10-g SAR versus time shall not exceed FCC limit of 1.6 W/kg for 1-g SAR or 4.0 W/kg for 10-g SAR (i.e., Eq. (3b)).

5. PD Time Averaging Validation Test Procedures

This chapter provides the test plan and test procedures for validating Qualcomm's Smart Transmit feature for mmW transmission. For this EUT, millimeter wave (mmW) transmission is only in non-standalone mode, i.e., it requires an LTE link as anchor.

5.1. Test Sequence for Validation in mmW NR Transmission

In 5G mmW NR transmission, the test sequence for validation is with the callbox always requesting the EUT's transmission power in 5G mmW NR at maximum power.

5.2. Test Configuration Selection Criteria for Validating Smart Transmit Feature

5.2.1. Test Configuration Selection for Time-varying Transmission Power

The Smart Transmit time averaging feature operation is independent of bands, modes, channels, and antenna configurations (beams) for a given technology. Hence, validation of Smart Transmit in any one band/mode/channel per technology is sufficient.

5.2.2. Test Configuration Selection for Change in Antenna Configuration (Beam)

The Smart Transmit time averaging feature operation is independent of bands, modes, channels, and antenna configurations (beams) for a given technology. Hence, validation of Smart Transmit with beam switch between any two beams is sufficient.

5.2.3. Test Configuration Selection for SAR versus PD Exposure Switch during Transmission

The Smart Transmit time averaging feature operation is independent of the nature of exposure (SAR vs. PD) and ensures total time-averaged RF exposure compliance. Hence, validation of Smart Transmit in any one band/mode/channel/beam for mmW + sub-6 GHz (LTE) transmission is sufficient, where the exposure varies among SAR dominant scenarios, SAR+PD scenarios, and PD dominant scenarios.

5.3. Test Procedures for mmW Radiated Power Measurements

Perform conducted power measurement (for $f < 6$ GHz) and radiated power measurement (for $f > 6$ GHz) for LTE + mmW transmission to validate Smart Transmit time averaging feature in the various transmission scenarios described in §3.

This section provides general conducted power measurement procedures to perform compliance test under dynamic transmission scenarios described in §3. In practice, an adjustment can be made in these procedures. The justification/clarification may be provided.

5.3.1. Time-varying Transmission Power Scenario

The purpose of the test is to demonstrate the effectiveness of power limiting enforcement and that the time-averaged transmission power when converted into RF exposure values do not exceed the FCC limit (see Eq. (2a), (2b) & (2c) in §3).

Test Procedure

1. Measure the conducted transmission power corresponding to P_{limit} for Sub-6 GHz selected band and measure the radiated transmission power corresponding to P_{limit} in desired mmW band/channel/beam by following below steps:
 - a. Measure the radiated power corresponding to mmW P_{limit} by setting up the EUT's transmission power in desired band/channel/beam at P_{limit} in Factory Test Mode (FTM). This test is performed in a calibrated anechoic chamber. Rotate the EUT to obtain maximum radiated transmission power, keep the EUT in this position and do not disturb the position of the EUT inside the anechoic chamber for the rest of this test.
 - b. Reset the EUT to place it in online mode and to establish a radio link in Sub-6 GHz, measure the conducted transmission power corresponding to Sub-6 GHz P_{limit} with Smart Transmit enabled and *Reserve_power_margin* set to 0 dB and with the callbox set to request maximum power.
2. Set *Reserve_power_margin* to actual (intended) value and reset power on the EUT to enable Smart Transmit. With the EUT setup for a mmW NR call in the desired/selected Sub-6 GHz band and mmW NR band, perform the following steps:
 - a. Establish Sub-6 GHz and mmW NR connection in the desired band/channel/beam used in Step 1. As soon as the mmW connection is established, immediately request all-down bits on the Sub-6 GHz link. With the callbox requesting the EUT's transmission power to be at maximum for mmW power to test predominantly the PD exposure scenario (as SAR exposure is less when the Sub-6 GHz transmission power is at low power).
 - b. After 120 seconds, request the Sub-6 GHz to go all-up bits for at least 100 seconds. SAR exposure is dominant. There are two scenarios:
 - i. If $P_{limit} < P_{max}$ for Sub-6 GHz, then the RF exposure margin (provided to mmW NR) gradually runs out (due to high SAR exposure). This results in gradual reduction in the 5G mmW NR transmission power and eventually seized 5G mmW NR transmission when Sub-6 GHz goes to $P_{reserve}$ level.
 - ii. If $P_{limit} \geq P_{max}$ for Sub-6 GHz, then the 5G mmW NR transmission's averaged power should gradually reduce but the mmW NR connection can sustain all the time (assuming TxAGC uncertainty equal to 0dB).
 - c. Record the conducted transmission power of Sub-6 GHz and radiated transmission power of mmW for the full duration of this test of at least 300 seconds.
3. Once the measurement is done, extract the instantaneous transmission power versus time for both Sub-6 GHz and mmW links. Convert the conducted transmission power for Sub-6 GHz into 1-g SAR or 10-g SAR values using Eq. (2a) and P_{limit} measured in Step 1.b, and then divide by FCC limit of 1.6 W/kg for 1-g SAR or 4.0 W/kg for 10-g SAR to obtain the instantaneous normalized 1-g SAR or 10-g SAR versus time. Perform 100 seconds running average to determine normalized 100 seconds-averaged 1-g SAR or 10-g SAR versus time.¹³
4. Similarly, convert the radiated transmission power for mmW into 4 cm² PD value using Eq. (2b) and the radiated transmission power limit (i.e., radiated transmission power at P_{limit}) measured in Step 1.a, then divide by FCC 4 cm² PD limit of 10 W/m² to obtain the instantaneous normalized 4 cm² PD versus time. Perform 4 seconds running average to determine normalized 4 seconds-averaged 4 cm² PD versus time.¹⁴
5. Make one plot containing: (a) Instantaneous conducted transmission power for Sub-6 GHz versus time, (b) computed 100 seconds-averaged conducted transmission power for Sub-6 GHz versus time, (c) instantaneous radiated transmission power for mmW versus time (as measured in Step 2), (d) computed 4 seconds-averaged radiated transmission power for mmW versus time, and (e) time-averaged conducted and radiated power limits for Sub-6 GHz and mmW radio using Eq. (5a) & (5b), respectively:

$$\text{Time averaged Sub-6GHz power limit} = \text{meas. } P_{limit} + 10 * \log \left(\frac{\text{FCC SAR Limit}}{\text{meas. SAR } P_{limit}} \right) \quad (5a)$$

$$\text{Time averaged mmW NR power limit} = \text{meas. EIRP}_{P_{limit}} + 10 * \log \left(\frac{\text{FCC PD limit}}{\text{meas. PD } P_{limit}} \right) \quad (5b)$$

where $\text{meas. EIRP}_{P_{limit}}$ and $\text{meas. PD}_{P_{limit}}$ correspond to measured EIRP at P_{limit} and measured power density at P_{limit} .

¹³ In Eq.(2a), instantaneous transmission power is converted into instantaneous 1-g SAR or 10-g SAR value by applying the measured worst-case 1-g SAR or 10-g SAR value at P_{limit} for the corresponding technology/band/antenna/DSI reported in the Part 1 report.

¹⁴ In Eq.(2b), instantaneous radiated transmission power is converted into instantaneous 4 cm² PD by applying the worst-case 4 cm² PD value measured at P_{limit} for the selected band/beam in the Part 1 report.

6. Make another plot containing: (a) Computed normalized 100 seconds-averaged 1-g SAR or 10-g SAR versus time determined in Step 3, (b) computed normalized 4 seconds-averaged 4 cm² PD versus time determined in Step 4, and (c) corresponding total normalized time-averaged RF exposure (sum of steps (6.a) and (6.b)) versus time.

The total normalized time-averaged RF exposure versus time determined in Step 6.c shall not exceed the normalized limit of 1.0 of FCC requirement (i.e., Eq. (2c)).

5.3.2. Switch in SAR vs. PD Exposure during Transmission

This test is to demonstrate that the Smart Transmit feature is independent of the nature of exposure (SAR vs. PD) and accurately accounts for switching in exposures among SAR dominant, SAR + PD, and PD dominant scenarios, ensuring total time-averaged RF exposure compliance.

Test Procedure

1. Measure the conducted transmission power corresponding to P_{limit} for Sub-6 GHz in selected band(s), and measure the radiated transmission power corresponding to P_{limit} in the desired mmW band/channel/beam by following the steps below:
 - a. Measure the radiated power corresponding to P_{limit} by setting up the EUT's transmission power in the desired band/channel/beam at P_{limit} in FTM. This test is performed in a calibrated anechoic chamber. Rotate the EUT to obtain the maximum radiated transmission power, keep the EUT in this position and do not disturb the position of the EUT inside the anechoic chamber for the rest of this test.
 - b. Reset the EUT to place it in online mode and establish a radio link in Sub-6 GHz, measure the conducted transmission power corresponding to Sub-6 GHz P_{limit} with Smart Transmit enabled and with *Reserve_power_margin* set to 0 dB and the callbox set to request maximum power.
2. Set *Reserve_power_margin* to actual (intended) value and reset power in the EUT, with EUT setup for Sub-6 GHz + mmW call, perform the following steps:
 - a. Establish Sub-6 GHz and mmW NR connection with the callbox.
 - b. As soon as the mmW connection is established, immediately request all-down bits on the Sub-6 GHz link. Continue Sub-6 GHz (all-down bits) + mmW transmission for more than 100 seconds duration to test predominantly the PD exposure scenario (as SAR exposure is negligible from all-down bits in Sub-6 GHz).
 - c. After 120 seconds, request the Sub-6 GHz link to go all-up bits, mmW transmission should gradually run out of RF exposure margin if Sub-6 GHz's $P_{limit} < P_{max}$ and seize mmW transmission (SAR only scenario); or mmW transmission should gradually reduce in transmission power and will sustain the connection if Sub-6 GHz's $P_{limit} > P_{max}$.
 - d. After 75 seconds, request the Sub-6 GHz link to go all-down bits, mmW transmission should start increase its RF exposure margin and resume transmission again.
 - e. Record the conducted transmission power of Sub-6 GHz and the radiated transmission power of mmW for the entire duration of this test of at least 300 seconds.
3. Once the measurement is done, extract the instantaneous transmission power versus time for both LTE and mmW links. Convert the conducted transmission power for Sub-6 GHz into 1-g SAR or 10-g SAR value using Eq. (2a) and P_{limit} measured in Step 1.b, and then divide by FCC limit of 1.6 W/kg for 1-g SAR or 4.0 W/kg for 10-g SAR to obtain the instantaneous normalized 1-g SAR or 10-g SAR versus time. Perform 100 seconds running average to determine normalized 100 seconds-averaged 1-g SAR or 10-g SAR versus time.¹⁵
4. Similarly, convert the radiated transmission power for mmW into 4 cm² PD value using Eq. (2b) and the radiated transmission power limit (i.e., radiated transmission power at P_{limit}) measured in Step 1.a, then divide this by FCC 4 cm² PD limit of 10 W/m² to obtain the instantaneous normalized 4 cm² PD versus time. Perform 4 seconds running average to determine normalized 4 seconds-averaged 4 cm² PD versus time.¹⁶

¹⁵ In Eq.(2a), the instantaneous transmission power is converted into instantaneous 1-g SAR or 10-g SAR value by applying the measured worst-case 1-g SAR or 10-g SAR value at P_{limit} for the corresponding technology/band/antenna/DSI reported in the Part 1 report.

¹⁶ In Eq.(2b), the instantaneous radiated transmission power is converted into instantaneous 4 cm² PD by applying the worst-case 4 cm² PD value measured at P_{limit} for the selected band/beam in the Part 1 report.

5. Make one plot containing: (a) Instantaneous conducted transmission power for Sub-6 GHz versus time, (b) computed 100 seconds-averaged conducted transmission power for Sub-6 GHz versus time, (c) instantaneous radiated transmission power for mmW versus time, as measured in Step 2, (d) computed 4 seconds-averaged radiated transmission power for mmW versus time, and (e) time-averaged conducted and radiated power limits for Sub-6 GHz and mmW radio using Eq. (5a) & (5b), respectively.
6. Make another plot containing: (a) Computed normalized 100 seconds-averaged 1-g SAR or 10-g SAR versus time determined in Step 3, (b) computed normalized 4 seconds-averaged 4 cm² PD versus time determined in Step 4, and (c) corresponding total normalized time-averaged RF exposure (sum of steps (6.a) and (6.b)) versus time.

The total normalized time-averaged RF exposure versus time determined in Step 6.c shall not exceed the normalized limit of 1.0 of FCC requirement (i.e., Eq. (2c)).

5.3.3. Change in Antenna Configuration (Beam)

This test is to demonstrate the correct power control by Smart Transmit during changes in antenna configuration (beam). Since the P_{limit} varies with beam, the Eq. (2a), (2b) and (2c) in §3 are written as below for transmission scenarios having change in beam:

$$1g \text{ or } 10g SAR(t) = \frac{\text{conducted Tx power}(t)}{\text{conducted Tx power } P_{limit}} * 1g \text{ or } 10g SAR P_{limit} \quad (8a)$$

$$4 \text{ cm}^2 PD_1(t) = \frac{\text{radiated Tx power } 1(t)}{\text{radiated Tx power } P_{limit_1}} * 4 \text{ cm}^2 PD P_{limit_1} \quad (8b)$$

$$4 \text{ cm}^2 PD_2(t) = \frac{\text{radiated Tx power } 2(t)}{\text{radiated Tx power } P_{limit_2}} * 4 \text{ cm}^2 PD P_{limit_2} \quad (8c)$$

$$\frac{\frac{1}{T_{SAR}} \int_{t-T_{SAR}}^t 1g \text{ or } 10g SAR(t) dt}{FCC SAR limit} + \frac{\frac{1}{T_{PD}} \left[\int_{t-T_{PD}}^{t_1} 4 \text{ cm}^2 PD_1(t) dt + \int_{t_1}^t 4 \text{ cm}^2 PD_2(t) dt \right]}{FCC 4 \text{ cm}^2 PD limit} \leq 1 \quad (8d)$$

where, $\text{conducted Tx power}(t)$, $\text{conducted Tx power } P_{limit}$, and $1-g \text{ or } 10-g SAR P_{limit}$ correspond to the measured instantaneous conducted transmission power, measured conducted transmission power at P_{limit} , and measured 1-g SAR or 10-g SAR values at P_{limit} corresponding to Sub-6 GHz transmission. Similarly, $\text{radiated Tx power } 1(t)$, $\text{radiated Tx power } P_{limit_1}$, and $4 \text{ cm}^2 PD P_{limit_1}$ correspond to the measured instantaneous radiated transmission power, radiated Tx power at P_{limit_1} , and $4 \text{ cm}^2 PD$ value at P_{limit_1} of beam 1; $\text{radiated Tx power } 2(t)$, $\text{radiated Tx power } P_{limit_2}$, and $4 \text{ cm}^2 PD P_{limit_2}$ correspond to the measured instantaneous radiated transmission power, radiated Tx power at P_{limit_2} , and $4 \text{ cm}^2 PD$ value at P_{limit_2} of beam 2 corresponding to mmW transmission.

Test Procedure

1. Measure the conducted transmission power corresponding to the P_{limit} for Sub-6 GHz in the selected band and measure the radiated transmission power corresponding to the P_{limit} in the desired mmW band/channel/beam by following the steps below:
 - a. Measure the radiated power corresponding to mmW P_{limit} by setting up the EUT's transmission power in the desired band/channel at P_{limit} of beam 1 in FTM. Do not disturb the position of the EUT inside the anechoic chamber for the rest of this test. Repeat this Step (1.a) for beam 2.
 - b. Reset the EUT to place it in online mode and establish a radio link in Sub-6 GHz; measure the conducted transmission power corresponding to Sub-6 GHz P_{limit} with Smart Transmit enabled, Reserve_power_margin set to 0 dB, and the callbox set to request maximum power.
2. Set Reserve_power_margin to actual (intended) value and reset power in EUT; with the EUT set for Sub-6 GHz + mmW connection, perform the following steps:
 - a. Establish Sub-6 GHz and mmW NR connection in beam 1. As soon as the mmW connection is established, immediately request all-down bits on Sub-6 GHz link with the callbox requesting the EUT's transmission power to be at maximum mmW power.
 - b. After beam 1 continues transmitting for at least 20 seconds, request the EUT to change from beam 1 to beam 2 and continue transmitting with beam 2 for at least 20 seconds.
 - c. Record the conducted transmission power of Sub-6 GHz and the radiated transmission power of mmW for the entire duration of this test.
3. Once the measurement is done, extract the instantaneous transmission power versus time for both Sub-6 GHz and mmW links. Convert the conducted transmission power for Sub-6 GHz into 1-g SAR or 10-g SAR value using the similar approach described in Step 3 of §5.3.2. Perform 100 seconds running average to determine normalized 100 seconds-averaged 1-g SAR versus time.

4. Similarly, convert the radiated transmission power for mmW NR into 4 cm² PD value using Eq. (8b), (8c) and the radiated transmission power limits (i.e., radiated transmission power at P_{limit}) measured in Step 1.a for beam 1 and beam 2, respectively, and then divide the resulting PD values by FCC's 4 cm² PD limit of 10 W/m² to obtain the instantaneous normalized 4 cm² PD versus time for beam 1 and beam 2. Perform 4 seconds running average to determine normalized 4 seconds-averaged 4 cm² PD versus time.¹⁷
5. Since the measured radiated powers for beam 1 and beam 2 in Step 1.a were performed at an arbitrary rotation of the EUT in anechoic chamber, repeat Step 1.a of this procedure by rotating the EUT to determine maximum radiated power at P_{limit} using FTM mode for both beams separately. Re-scale the measured instantaneous radiated power in Step 2.c by the delta in radiated power measured in Step 5 and the radiated power measured in Step 1.a for plotting purposes in the next step. In other words, this step essentially converts measured instantaneous radiated power during the measurement in Step 2 into maximum instantaneous radiated power for both beams. Perform 4 seconds running average to compute 4 seconds-averaged radiated transmission power. Additionally, use these EIRP values measured at P_{limit} at respective peak locations to determine the EIRP limits (using Eq. (5b)) for both beams.
6. Make one plot containing: (a) Instantaneous conducted transmission power for Sub-6 GHz versus time, (b) computed 100 seconds-averaged conducted transmission power for Sub-6 GHz versus time, (c) instantaneous radiated transmission power for mmW versus time, as obtained in Step 5, (d) computed 4 seconds-averaged radiated transmission power for mmW versus time, as obtained in Step 5, and (e) time-averaged conducted and radiated power limits for Sub-6 GHz and mmW radio, respectively.
7. Make another plot containing: (a) Computed normalized 100 seconds-averaged 1-g SAR versus time determined in Step 3, (b) computed normalized 4 seconds-averaged 4 cm² PD versus time determined in Step 4, and (c) corresponding total normalized time-averaged RF exposure (sum of steps (6.a) and (6.b)) versus time.

The total normalized time-averaged RF exposure versus time determined in Step 6.c shall not exceed the normalized limit of 1.0 of FCC requirement (i.e., (8d)).

5.4. Test Procedure for Time-varying PD Measurements

The following steps are used to perform the validation through PD measurement for transmission scenario 1, as described in §3:

1. Place the EUT on the cDASY6 platform to perform a PD measurement in the worst-case position/surface for the selected mmW band/beam. In the PD measurement, the callbox is set to request maximum transmission power from the EUT. Hence, "path loss" calibration between callbox, antenna, and EUT is not needed in this test.
2. Time averaging feature validation:
 - a. Measure the conducted transmission power corresponding to P_{limit} for Sub-6 GHz in the selected band and measure the point E-field corresponding to P_{limit} in the desired mmW band/channel/beam by following the below steps:
 - i. Measure the conducted transmission power corresponding to the Sub-6 GHz P_{limit} with Smart Transmit enabled, *Reserve_power_margin* set to 0 dB, and with the callbox set to request maximum power.
 - ii. Measure the point E-field at the peak location of the fast area scan corresponding to the P_{limit} by setting up the EUT's transmission power in the desired mmW band/channel/beam at $i P_{limit}$ using FTM. Do not disturb the position of the EUT and mmW cDASY6 probe.
 - b. Set *Reserve_power_margin* to actual value (i.e., intended value) and reset power on the EUT; place the EUT in online mode. With the EUT setup for Sub-6 GHz + mmW NR call, as soon as the mmW NR connection is established, request all-down bits on Sub-6 GHz link. Continue Sub-6 GHz (all-down bits) + mmW transmission for more than 100 seconds duration to test predominantly the PD exposure scenario. After 120 seconds, request the Sub-6 GHz link to go all-up bits; the mmW transmission should gradually reduce. Simultaneously, record the conducted transmission power of the Sub-6 GHz transmission using the power meter and point E-field (in terms of ratio of $\frac{[pointE(t)]^2}{[pointE_Plimit]^2}$) of mmW transmission using cDASY6 E-field probe at peak location identified in Step 2.a.ii for the entire duration of this test, of at least 300 seconds.
 - c. Once the measurement is done, extract the instantaneous conducted transmission power versus time for the Sub-6 GHz transmission and $\frac{[pointE(t)]^2}{[pointE_Plimit]^2}$ ratio versus time from the cDASY6 system for mmW transmission. Convert the conducted transmission power for the Sub-6 GHz link into 1-g SAR or 10-g SAR value using Eq.

¹⁷ In Eq.(8b) and (8c), the instantaneous radiated transmission power of beam 1 and beam 2 is converted into instantaneous 4 cm² PD by applying the worst-case 4 cm² PD value measured at the P_{limit} of beam 1 and beam 2 in the Part 1 report, respectively.

- (4a) and P_{limit} measured in Step 2.a.i, and then divide this by FCC limit of 1.6 W/kg for 1-g SAR or 4.0 W/kg for 10-g SAR to obtain the instantaneous normalized 1-g SAR or 10-g SAR versus time. Perform 100 seconds running average to determine the normalized 100 second-averaged 1-g SAR or 10-g SAR versus time.¹⁸
- d. Similarly, convert the point E-field for mmW transmission into 4 cm² PD value using Eq. (4b) and radiated power limit measured in Step 2.a.ii, and then divide this by FCC 4 cm² PD limit of 10 W/m² to obtain the instantaneous normalized 4 cm² PD versus time. Perform 4 seconds running average to determine the normalized 4 seconds-averaged 4 cm² PD versus time.
 - e. Make one plot containing: (i) Computed normalized 100 seconds-averaged 1-g SAR or 10-g SAR versus time determined in Step 2.c, (ii) computed normalized 4 seconds-averaged 4 cm² PD versus time determined in Step 2.d, and (iii) corresponding total normalized time-averaged RF exposure (sum of steps (2.e.i) and (2.e.ii)) versus time.

The total normalized time-averaged RF exposure versus time determined in Step 2.e.iii shall not exceed the normalized limit of 1.0 of FCC requirement (i.e., Eq. (4c)).

6. Test Configurations

6.1. WWAN (Sub-6 GHz) Transmission

The P_{limit} values for technologies and bands supported by the EUT are derived in the Part 0 report and summarized in Table 6-1.^{19, 20}

Based on the selection criteria described in §4.2.1, the selected technologies/bands for testing time-varying test sequences are shaded in Table 6-1.

The radio configurations used in the Part 2 test for selected technologies/bands/DSI states/antennas are listed in Table 6-2. The corresponding worst-case radio configuration 1-g SAR or 10-g SAR values for selected technology/band/DSI are extracted from the Part 1 report and are listed in the last column of Table 6-2.

Based on equations (1a), (2a), (3a) and (4a), Part 2 testing outcome is the normalized quantity, which implies that it can be applied to any radio configuration within a selected technology/band/DSI. Thus, applying the worst-case SAR obtained from the worst radio configuration in Part 1 testing to calculate time-varying SAR exposure in equations (1a), (2a), (3a) and (4a), the accuracy in compliance demonstration remains the same.

¹⁸ In Eq.(4a), the instantaneous transmission power is converted into instantaneous 1-g SAR or 10-g SAR value by applying the measured worst-case 1-g SAR or 10-g SAR value at P_{limit} for the corresponding technology/band reported in the Part 1 report.

¹⁹ All P_{limit} power levels entered in Table 6-1 correspond to average power levels after accounting for duty cycle in the case of TDD modulation schemes, e.g., GSM, LTE TDD & Sub-6 GHz NR TDD.

²⁰ Maximum tune up target power, P_{max} , is configured in the NV settings within the EUT to limit maximum transmitting power. This power is converted into peak power in the NV settings for TDD schemes. The EUT's maximum allowed output power is equal to P_{max} + device uncertainty (dB).

Table 6-1: P_{limit} for supported technologies and bands (P_{limit} in EFS file)

Tech/Band	Antenna			Worst-case SAR (W/kg)			P_{limit} (dBm) + Uncertainty (dBm)		
	Head	Body & Hotspot	Hotspot	Head	Body & Hotspot	Hotspot	Head	Body & Hotspot	Hotspot
	DSI: 0	DSI: 1	DSI: 1	DSI: 0	DSI: 1	DSI: 1	DSI: 0	DSI: 1	DSI: 1
GSM 850 2 slots	ANT 2	ANT 1	ANT 1	0.452	0.530	0.714	29.80	32.50	32.50
GSM 1900 2 slots	ANT 4	ANT 4	ANT 3	0.977	0.720	0.944	27.40	26.20	28.20
W-CDMA B2	ANT 4	ANT 4	ANT 1	0.942	0.917	0.984	19.90	20.00	21.50
W-CDMA B4	ANT 2	ANT 3	ANT 2	0.942	0.903	0.953	18.80	22.90	18.60
W-CDMA B5	ANT 2	ANT 1	ANT 1	0.687	0.535	0.543	24.50	25.70	25.70
LTE Band 5	ANT 2	ANT 2	ANT 2	0.732	0.648	0.648	24.50	25.20	25.20
LTE Band 7	ANT 4	ANT 4	ANT 1	0.980	0.807	0.998	21.10	20.60	21.40
LTE Band 12/17	ANT 2	ANT 1	ANT 1	0.692	0.532	0.825	25.20	25.70	25.70
LTE Band 13	ANT 2	ANT 1	ANT 1	0.873	0.639	0.845	24.30	25.70	25.70
LTE Band 14	ANT 2	ANT 1	ANT 1	0.852	0.670	0.848	24.20	25.70	25.70
LTE Band 25/2	ANT 4	ANT 4	ANT 3	0.880	0.982	0.988	19.60	20.00	21.90
LTE Band 26	ANT 2	ANT 1	ANT 1	0.599	0.494	0.527	24.50	25.70	25.70
LTE Band 30	ANT 4	ANT 2	ANT 4	0.998	0.877	0.997	20.40	22.10	19.90
LTE Band 41	ANT 2	ANT 2	ANT 2	0.984	0.992	0.992	21.90	22.70	22.70
LTE Band 48	ANT 8	ANT 9	ANT 7	0.954	0.728	0.980	24.40	20.70	20.60
LTE Band 53	ANT 2	ANT 1	ANT 1	0.467	0.289	0.555	20.70	20.70	20.70
LTE Band 66/4	ANT 4	ANT 3	ANT 1	0.982	0.823	0.983	22.60	22.90	20.40
LTE Band 71	ANT 2	ANT 1	ANT 1	0.447	0.497	0.685	25.20	25.70	25.70
MSS	N/A	ANT 1	ANT 4	N/A	0.690	0.929	N/A	20.00	22.40
NR n5	ANT 2	ANT 1	ANT 1	0.874	0.659	0.659	24.50	25.70	25.70
NR n7	ANT 2	ANT 3	ANT 4	0.987	0.788	0.948	20.30	19.30	20.60
NR n12	ANT 2	ANT 1	ANT 1	0.778	0.563	0.794	25.20	25.70	25.70
NR n14	ANT 2	ANT 1	ANT 1	0.745	0.777	0.840	24.30	25.70	25.70
NR n25/2	ANT 4	ANT 4	ANT 4	1.002	0.847	0.847	19.60	20.00	20.00
NR n26	ANT 2	ANT 1	ANT 1	0.911	0.622	0.665	24.50	25.70	25.70
NR n30	ANT 4	ANT 2	ANT 3	0.938	0.844	0.937	20.40	22.10	21.00
NR n41	ANT 2	ANT 2	ANT 4	0.889	0.932	1.000	19.90	20.70	20.60
NR n48	ANT 8	ANT 4	ANT 4	0.678	0.862	0.969	22.40	23.20	23.20
NR n53	ANT 2	ANT 2	ANT 2	0.898	0.611	0.661	19.10	20.70	20.70
NR n66	ANT 2	ANT 3	ANT 3	0.969	0.993	0.993	18.80	22.90	22.90
NR n70	ANT 2	ANT 4	ANT 4	0.917	0.969	0.994	19.40	23.00	23.00
NR n71	ANT 2	ANT 1	ANT 1	0.633	0.552	0.787	25.20	25.70	25.70
NR n77	ANT 4	ANT 9	ANT 9	0.721	0.680	0.814	21.50	17.40	17.40

Table 6-2: Radio configurations selected for Part 2

Part 2 Test Configurations											Part 1 worst-case radio config 1g SAR measured at P_{lim} (W/kg)
Test Case	Test Scenario	Tech	Band	ANT	DSI	Channel	Freq	RB/Offset	Mode	Detail	
1	Time-varying Tx power transmission (Seq1/Seq2) for conducted power	GSM	1900	1	1	661	1880.0	N/A	B	GSM Edge Bottom 1-g 5mm	0.604
2			1900	3	1	810	1909.8	N/A	B	GSM Edge Left 1-g 5mm	0.659
3		W-CDMA	BIV	1	1	1413	1732.6	N/A	B	W-CDMA Edge Bottom 1-g 5mm	0.700
4			BII	1	1	9262	1852.4	N/A	B	W-CDMA Edge Bottom 1-g 5mm	0.904
5		LTE	B66	1	1	132572	1770.0	50/0	B	LTE Edge Bottom 1-g 5mm	0.712
6			B25/2	1	1	26140	1860.0	1/49	B	LTE Edge Bottom 1-g 5mm	0.773
7			n66	1	1	349000	1745.0	108/54	B	FR1 Edge Bottom 1-g 5mm	0.699
8			n77	9	1	633334	3500.0	135/69	B	FR1 Edge Left 1-g 5mm	0.765
9	Call drop for conducted power test	LTE	B66	1	1	132572	1770.0	50/0	B	LTE Edge Bottom 1-g 5mm	0.712
10	Tech/band for conducted power test	W-CDMA	BIV	1	1	1413	1732.6	N/A	B	W-CDMA Edge Bottom 1-g 5mm	0.700
		LTE	B66	1	1	132572	1770.0	50/0	B	LTE Edge Bottom 1-g 5mm	0.712
11	DSI switch for conducted power test	LTE	B66	1	0	132322	1745.0	1/0	A	LTE Right Cheek 1-g 0mm	0.093
		LTE	B66	1	1	132572	1770.0	50/0	B	LTE Edge Bottom 1-g 5mm	0.712
12	Time-window/Ant switch for conducted power test	LTE	B66	1	1	132572	1770.0	50/0	B	LTE Edge Bottom 1-g 5mm	0.712
		LTE	B48	9	1	56207	3646.7	50/0	B	LTE Back 1-g 5mm	0.549
13	SAR exposure switch for conducted power test	ENDC	n77	9	1	633334	3500.0	135/69	B	FR1 Edge Left 1-g 5mm	0.765
			B66	1	1	132572	1770.0	50/0	B	LTE Edge Bottom 1-g 5mm	0.712

Based on the selection criteria described in §4.2, the radio configurations for the transmission varying test cases listed in §3 are:

1. Technologies and bands for time-varying Tx power transmission: The test case 1~10 listed in Table 6-2 are selected to test with the test sequences defined in §4.1 in both time-varying conducted power measurements and time-varying SAR measurements.
2. Technology and band for change in call test: Select the technology and frequency band having the lowest P_{limit} among all technologies and bands (test case 11 in Table 6-2) for performing the call drop test in conducted power setup.
3. Technologies and bands for change in technology/band test: Following the guidelines in §4.2.3 and 4.2.4, test case 12 in Table 6-2 is selected for handover test from a technology/band/antenna with the highest P_{limit} within one technology group, to a technology/band in the same DSI state with the lowest P_{limit} within another technology group in a conducted power setup.
4. Technologies and bands for change in DSI: Based on selection criteria in §4.2.5, for a given technology and band, test case 13 in Table 6-2 is selected for DSI switch test by establishing a call in one technology and DSI state and then handing over to another DSI state/exposure scenario in a conducted power setup.
5. Technologies and bands for change in time-window/antenna: Based on selection criteria in §4.2.6, for a given DSI state, test case 14 in Table 6-2 is selected for time window switch between 60 seconds window and 100 seconds window in a conducted power setup.
6. Technologies and bands for switch in SAR exposure: Based on selection criteria in §4.2.7 Scenario 1, test case 15 in Table 6-2 is selected for SAR exposure switching test in one of the supported simultaneous WWAN transmission scenario, i.e., LTE + Sub6 NR active in the same 100 seconds time window, in a conducted power setup. Since this device supports Sub-6 GHz + mmW NR, test for §4.2.7 Scenario 2 for RF exposure switch is covered in §9.2.3 and 9.2.4 between Sub-6 GHz (100 seconds window) and mmW NR (4 seconds window).

6.2. LTE + mmW NR Transmission

Based on the selection criteria described in §5.2, the selections for LTE and mmW NR validation test are listed in Table 6-3. The radio configurations used in this test are listed in Table 6-4.²¹

Table 6-3: Selections for LTE + mmW NR validation measurements

Transmission Scenario	Test	Technology and Band	mmW Beam
Time-varying Tx power test	1. Cond. & Rad. Power meas.	LTE B2 and n261	20
	2. PD meas.	LTE B2 and n260	19
Switch in SAR vs. PD	1. Cond. & Rad. Power meas.	LTE B2 and n261	20
		LTE B2 and n260	19
Beam switch test	1. Cond. & Rad. Power meas.	LTE B2 and n261	142 to 131
		LTE B2 and n260	142 to 130

Table 6-4: Test configuration for LTE + mmW NR validation

Tech	Band	Antenna	DSI	Channel	RB Size	RB Offset	Freq (MHz)	Mode	UL Duty Cycle
LTE	2	1	1	18900	1	49	1880	QPSK	100%
mmW NR	n261	BG1	-	MID	1		28300	CW	100% ¹
	n260	BG1	-	MID	1		37050	CW	100% ¹

²¹ mmW NR callbox UL duty cycle should be configured to be greater than 75% for all LTE + mmW NR Part 2 tests.

7. Conducted Power Test Results for Sub-6 GHz Smart Transmit Feature Validation

7.1. Measurement Setup

The Rohde & Schwarz CMW500 callbox is used in this test. The test setup picture and schematic are shown in Figures 7-1a and 7-1c for measurements with a single antenna and in Figures 7-1b and 7-1d for measurements involving antenna switching (see Appendix E for missing figures). For single antenna measurements, one port (RF1 COM) of the callbox is connected to the RF port of the EUT using a directional coupler. For antenna & technology switch measurement, two ports (RF1 COM and RF3 COM) of the callbox are used for signaling two different technologies are connected to a combiner, which is, in turn, connected to a directional coupler. The other end of the directional coupler is connected to a splitter to connect to two RF ports of the EUT corresponding to the two antennas of interest. In both the setups, a power meter is used to tap the directional coupler for measuring the conducted output power of the EUT. For time averaging validation test (§4.3.1), call drop test (§4.3.2), and DSI switch test (§4.3.4), only RF1 COM port of the callbox is used to communicate with the EUT. For technology/band switch measurement (§4.3.3), both RF1 COM and RF3 COM ports of the callbox are used to switch from one technology communicating on RF1 COM port to another technology communicating on RF3 COM port.²² All the path losses from the RF port of the EUT to the callbox RF COM port and to the power meter are calibrated and automatically entered as offsets in the callbox and the power meter via test scripts on the PC used to control callbox and power meter.

LTE + Sub-6 GHz NR Test Setup:

If the LTE conducted port and Sub-6 GHz NR conducted port are same on this EUT (i.e., they share the same antenna), then low-/high-pass filters are used to separate the LTE and Sub-6 GHz NR signals for power meter measurement via directional couplers, as shown in below Figures 6-1b and 6-1c.

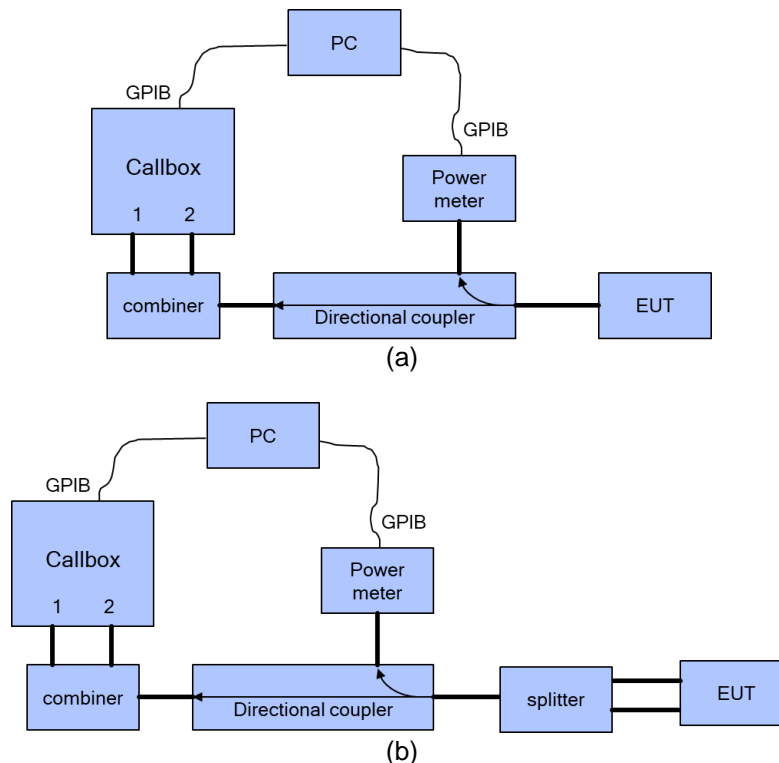

²² For this EUT, antenna switch test (§4.3.4) is included within time-window switch test (§4.3.6) as the selected technology/band combinations for the time-window switch test are on two different antennas.

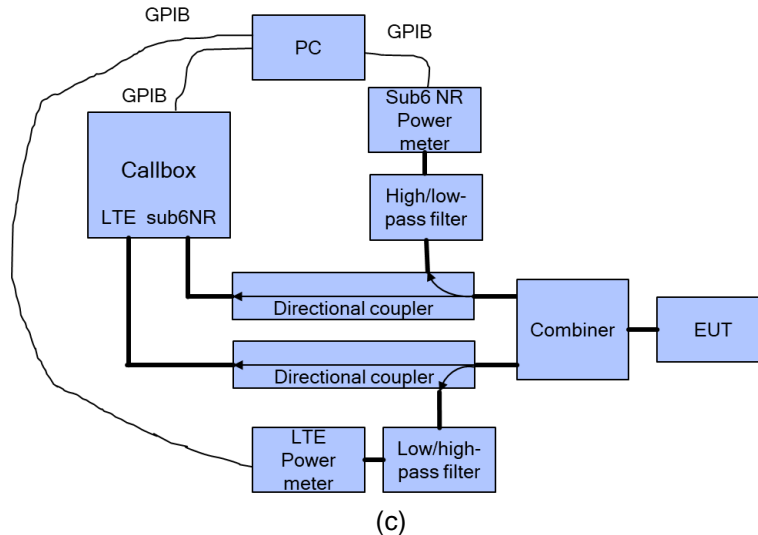

Figure 7-1a – 7-1c: Conducted power measurement setup

Both the callbox and power meter are connected to the PC using GPIB cables. Two test scripts are custom made for automation and the test duration set in the test scripts is 500 seconds.

For time-varying transmission power measurement, the PC runs the first test script to send GPIB commands to control the callbox's requested power versus time, while, at the same time, recording the conducted power measured at the EUT's RF port using the power meter. The commands sent to the callbox to request power are:

- 0 dBm for 100 seconds.
- Test sequence 1 or test sequence 2 (defined in §4.1 and generated in §4.2.1) for 360 seconds.
- Stay at the last power level of test sequence 1 or test sequence 2 for the remaining time.

The power meter readings are periodically recorded every 100 milliseconds. A running average of this measured transmission power over 100 seconds is performed in the post-data processing to determine the 100 seconds-time averaged power.

For call drop, technology/band/antenna switch, and DSI switch tests, after the call is established, the callbox is set to request the EUT's transmission power at 0 dBm for 100 seconds while simultaneously starting the second test script run at the same time to start recording the transmission power measured at the EUT's RF port using the power meter. After the initial 100 seconds, since starting the transmission power recording, the callbox is set to request maximum power from the EUT for the rest of the test.²³

²³ The call drop/re-establish, or technology/band/antenna switch, or DSI switch is manually performed when the transmission power of the EUT is at $P_{reserve}$ level. See §4.3 for the detailed test procedure of call drop test, technology/band/antenna switch test, and DSI switch test.

7.2. P_{limit} and P_{max} Measurement Results

The measured P_{limit} for all the selected radio configurations given in Table 6-2 are listed in Table 7-1. P_{max} was also measured for radio configurations selected for testing time-varying power transmission scenarios to generate test sequences following the test procedures in §4.1.

Table 7-1: Measured P_{limit} and P_{max} of selected radio configurations

Test Case	Test Scenario	Tech	Band	ANT	DSI	Channel	Freq	RB/Offset	Mode	Detail(s)	P_{lim} EFS Setting ¹ (Burst)	P_{max} (Burst)	Measured P_{lim}
1	Time-varying Tx power transmission (Seq1/Seq2) for conducted power	GSM	1900	1	1	661	1880.0	N/A	B	GSM Edge Bottom 1-g 5mm	27.70	32.00	26.90
2			1900	3	1	810	1909.8	N/A	B	GSM Edge Left 1-g 5mm	28.20	31.50	26.80
3		WCDMA	BIV	1	1	1413	1732.6	N/A	B	W-CDMA Edge Bottom 1-g 5mm	20.40	25.70	19.40
4			BII	1	1	9262	1852.4	N/A	B	W-CDMA Edge Bottom 1-g 5mm	21.50	25.70	21.00
5		LTE	B66	1	1	132572	1770.0	50/0	B	LTE Edge Bottom 1-g 5mm	20.40	25.70	19.10
6			B25/2	1	1	26140	1860.0	1/49	B	LTE Edge Bottom 1-g 5mm	21.50	25.70	20.60
7		sub6 NR	n66	1	1	349000	1745.0	108/54	B	FR1 Edge Bottom 1-g 5mm	20.40	25.70	19.10
8			n77	9	1	633334	3500.0	135/69	B	FR1 Edge Left 1-g 5mm	17.40	26.00	17.30
9	Call drop for conducted power test	LTE	B66	1	1	132572	1770.0	50/0	B	LTE Edge Bottom 1-g 5mm	20.40	25.70	19.10
10	Tech/band for conducted power test	LTE	BIV	1	1	1413	1732.6	N/A	B	W-CDMA Edge Bottom 1-g 5mm	20.40	25.70	19.40
		LTE	B66	1	1	132572	1770.0	50/0	B	LTE Edge Bottom 1-g 5mm	20.40	25.70	19.10
11	DSI switch for conducted power test	LTE	B66	1	0	132322	1745.0	1/0	A	LTE Right Cheek 1-g 0mm	25.70	25.70	24.80
		LTE	B66	1	1	132572	1770.0	50/0	B	LTE Edge Bottom 1-g 5mm	20.40	25.70	19.10
12	Time-window/Ant switch for conducted power test	LTE	B66	1	1	132572	1770.0	50/0	B	LTE Edge Bottom 1-g 5mm	20.40	25.70	19.10
		LTE	B48	9	1	56207	3646.7	50/0	B	LTE Back 1-g 5mm	20.70	24.30	19.40
13	SAR exposure switch for conducted power test	ENDC	n77	9	1	633334	3500.0	135/69	B	FR1 Edge Left 1-g 5mm	17.40	26.00	17.30
			B66	1	1	132572	1770.0	50/0	B	LTE Edge Bottom 1-g 5mm	20.40	25.70	19.10

¹ Lists the target power without manufacturer uncertainty per specified configuration.

7.3. Time-varying Transmission Power Measurement Results

The measurement setups are shown in Figures 7-1(a) and 7-1(c). The purpose of the time-varying transmission power measurement is to demonstrate the effectiveness of power limiting enforcement and that the time-averaged transmission power, when represented in time-averaged 1-g SAR or 10-g SAR values, do not exceed FCC limit as shown in Eq. (1a) and (1b), rewritten below:

$$1g \text{ or } 10g \text{ SAR}(t) = \frac{\text{conducted Tx power}(t)}{\text{conducted Tx power } P_{limit}} * 1g \text{ or } 10g \text{ SAR } P_{limit} \text{ (1a)}$$

$$\frac{\frac{1}{T_{SAR}} \int_{t-T_{SAR}}^t 1g \text{ or } 10g \text{ SAR}(t) dt}{FCC \text{ SAR limit}} \leq 1 \text{ (1b)}$$

where *conducted Tx power(t)*, *conducted Tx power P_{limits}* , and *1-g or 10-g SAR P_{limit}* correspond to the measured instantaneous conducted transmission power, measured conducted Tx power at P_{limit} , and measured 1-g SAR and 10-g SAR values at P_{limit} reported in the Part 1 test (listed in Table 6-2 of this report as well).

Following the test procedure in §4.3, the conducted transmission power measurement for all selected configurations is reported in this section. In all the conducted transmission power plots, the dotted line represents the requested power by callbox (test sequence 1 or test sequence 2), the blue curve represents the instantaneous conducted transmission power measured using the power meter, the green curve represents time-averaged power, and the red line represents the conducted power limit that corresponds to FCC limit of 1.6 W/kg for 1-g SAR or 4.0 W/kg for 10-g SAR.

Similarly, in all the 1-g or 10-g SAR plots (when converted using Eq. (1a)), the green curve represents the 100/60 seconds-time averaged 1-g SAR or 10-g SAR value calculated based on the instantaneous 1-g SAR or 10-g SAR; the red line limit represents the FCC limit of 1.6 W/kg for 1-g SAR or 4.0 W/kg for 10-g SAR.

Time-varying transmission power measurements were conducted on test cases 1 through 10 in Table 6-2, by generating test sequence 1 and test sequence 2 given in Appendix A using measured P_{limit} and measured P_{max} (last columns of Table 7-1) for each of these test cases. Measurement results for test cases 1 through 8 are given in §7.3.1 through §7.3.8.

7.3.1. GPRS PCS Antenna 1 (Test Case 1 in Table 6-2)

Test Result for Test Sequence 1:

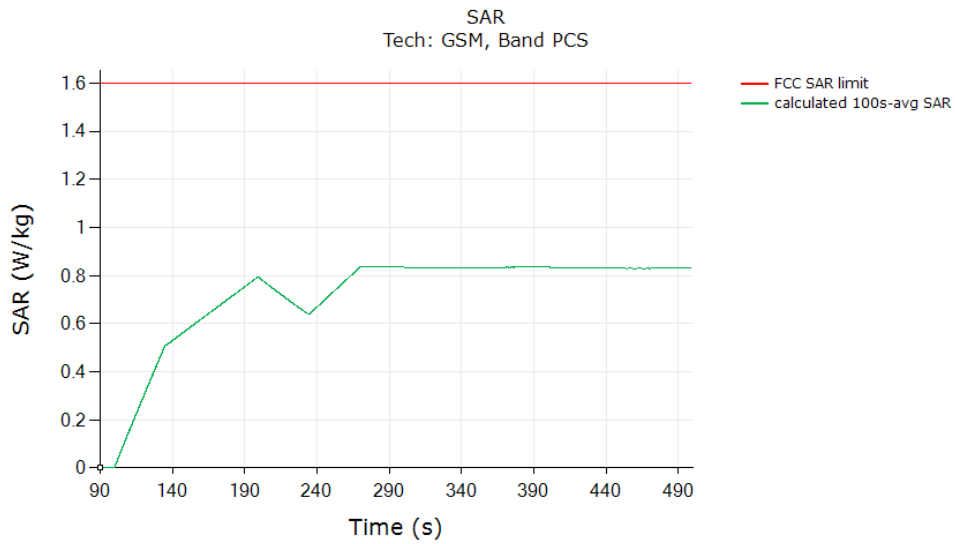

	(W/kg)
FCC 1-g SAR limit	1.6/4.0
Max 100 seconds-time averaged 1-g SAR (green curve)	0.838
Validated: Max time averaged SAR (green curve) is less than the SAR _{Design Limit} .	

Test Result for Test Sequence 2:

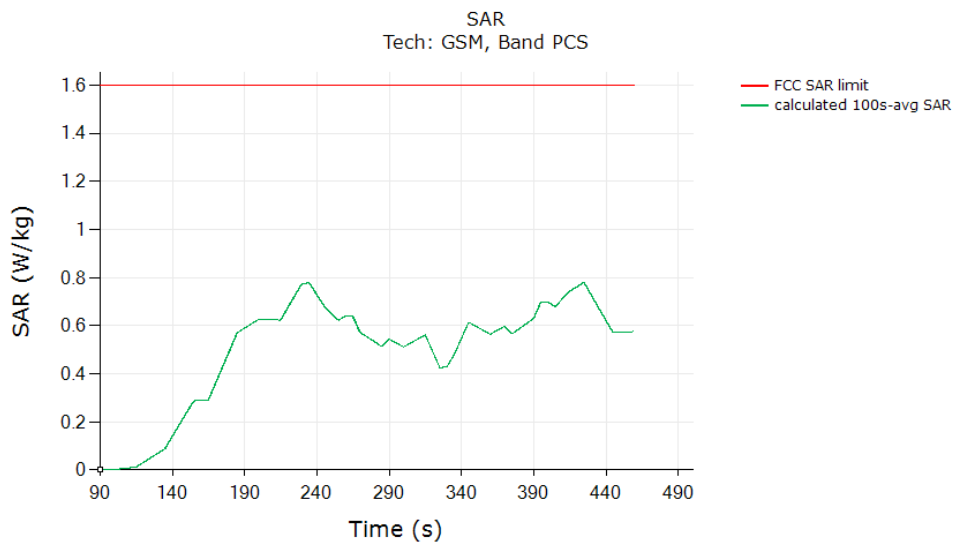

	(W/kg)
FCC 1-g SAR limit	1.6/4.0
Max 100 seconds-time averaged 1-g SAR (green curve)	0.780
Validated: Max time averaged SAR (green curve) is less than the SAR _{Design Limit} .	

7.3.2. GPRS PCS Antenna 3 (Test Case 2 in Table 6-2)

Test Result for Test Sequence 1:

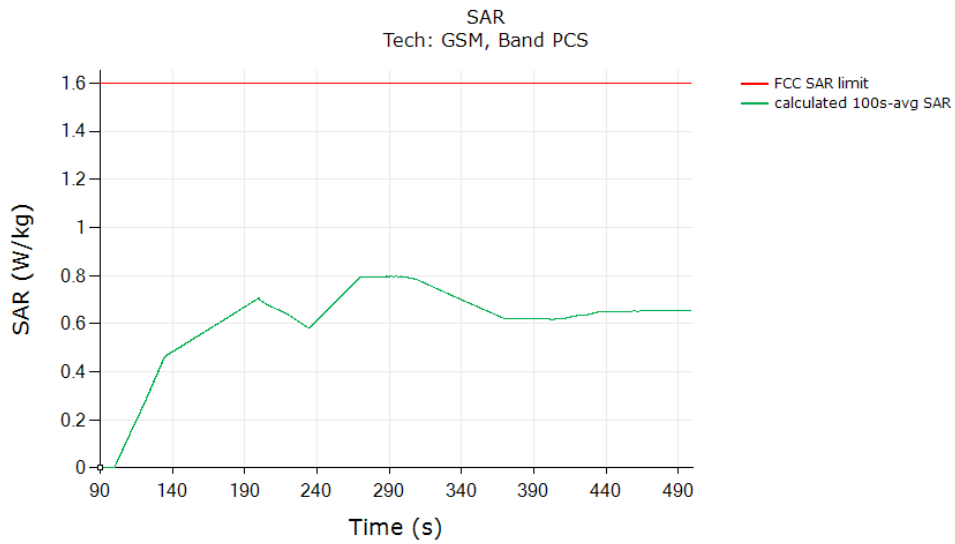

	(W/kg)
FCC 1-g SAR limit	1.6/4.0
Max 100 seconds-time averaged 1-g SAR (green curve)	0.796
Validated: Max time averaged SAR (green curve) is less than the SAR _{Design Limit} .	

Test Result for Test Sequence 2:

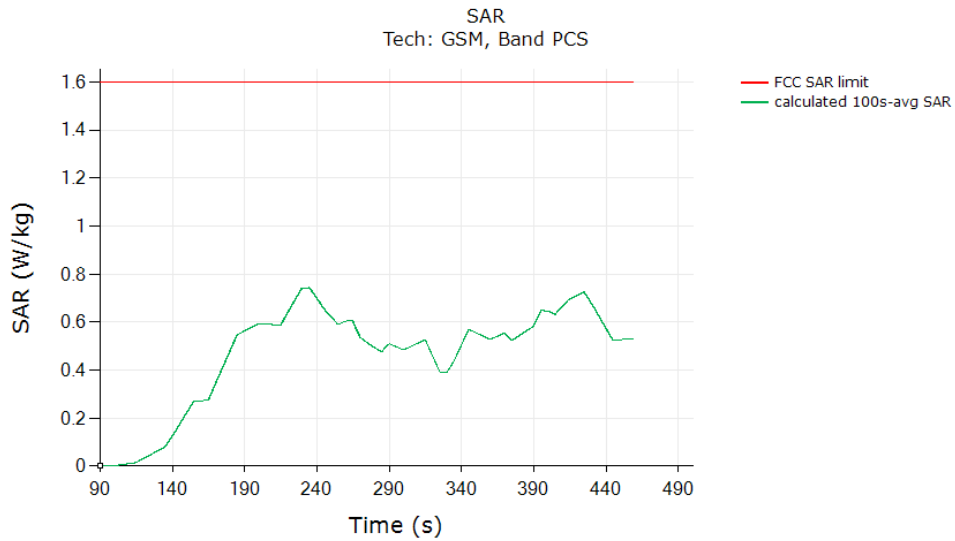

	(W/kg)
FCC 1-g SAR limit	1.6/4.0
Max 100 seconds-time averaged 1-g SAR (green curve)	0.744
Validated: Max time averaged SAR (green curve) is less than the SAR _{Design Limit} .	

7.3.3. W-CDMA Band Band 4 Ant 1 (Test Case 3 in Table 6-2)

Test Result for Test Sequence 1:

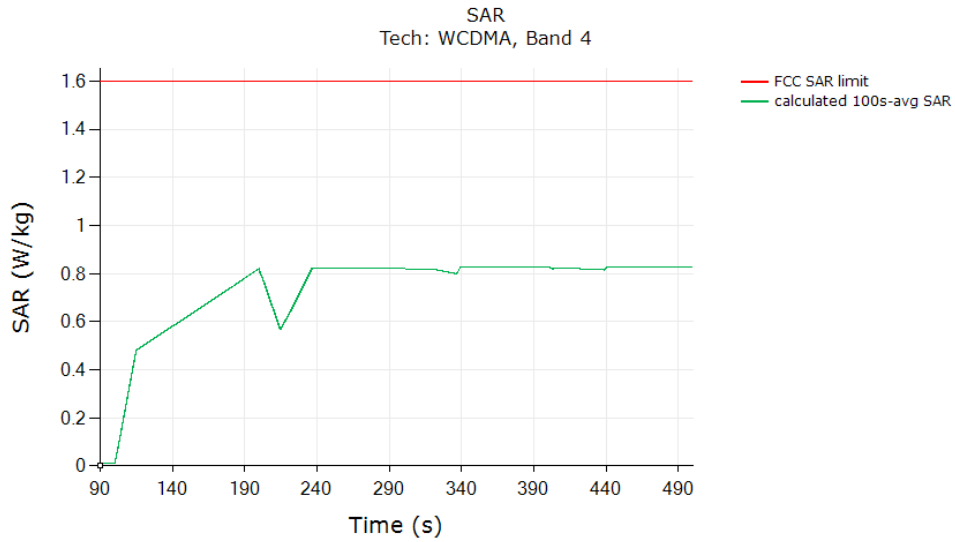

	(W/kg)
FCC 1-g SAR limit	1.6/4.0
Max 100 seconds-time averaged 1-g SAR (green curve)	0.829
Validated: Max time averaged SAR (green curve) is less than the SAR _{Design Limit} .	

Test Result for Test Sequence 2:

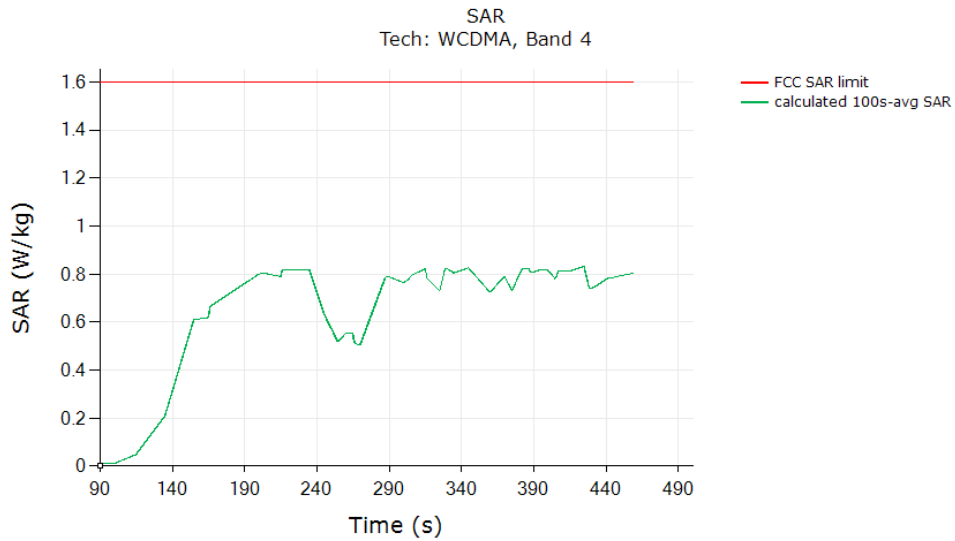

	(W/kg)
FCC 1-g SAR limit	1.6/4.0
Max 100 seconds-time averaged 1-g SAR (green curve)	0.831
Validated: Max time averaged SAR (green curve) is less than the SAR _{Design Limit} .	

7.3.4. W-CDMA Band 2 Ant 1 (Test Case 4 in Table 6-2)

Test Result for Test Sequence 1:

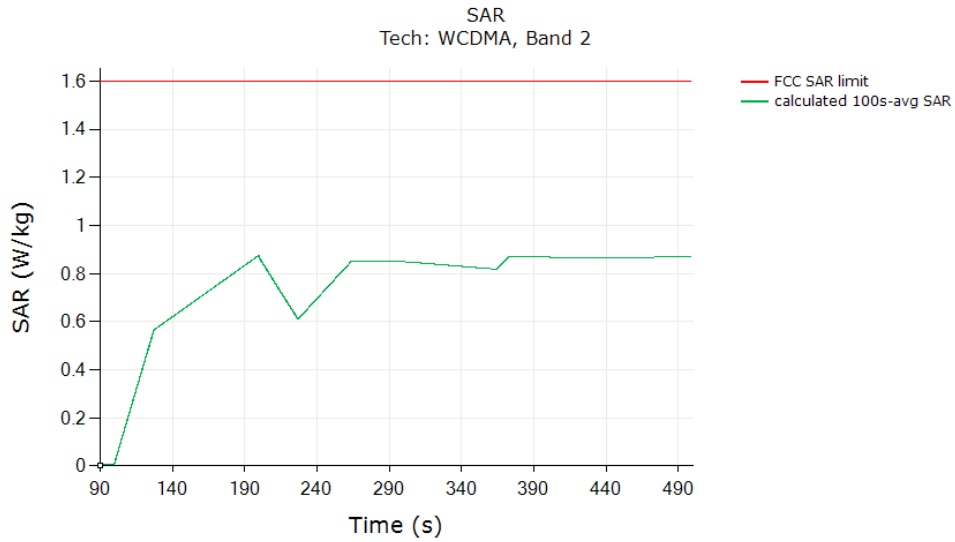

	(W/kg)
FCC 1-g SAR limit	1.6/4.0
Max 100 seconds-time averaged 1-g SAR (green curve)	0.875
Validated: Max time averaged SAR (green curve) is less than the $SAR_{Design\ Limit}$.	

Test Result for Test Sequence 2:

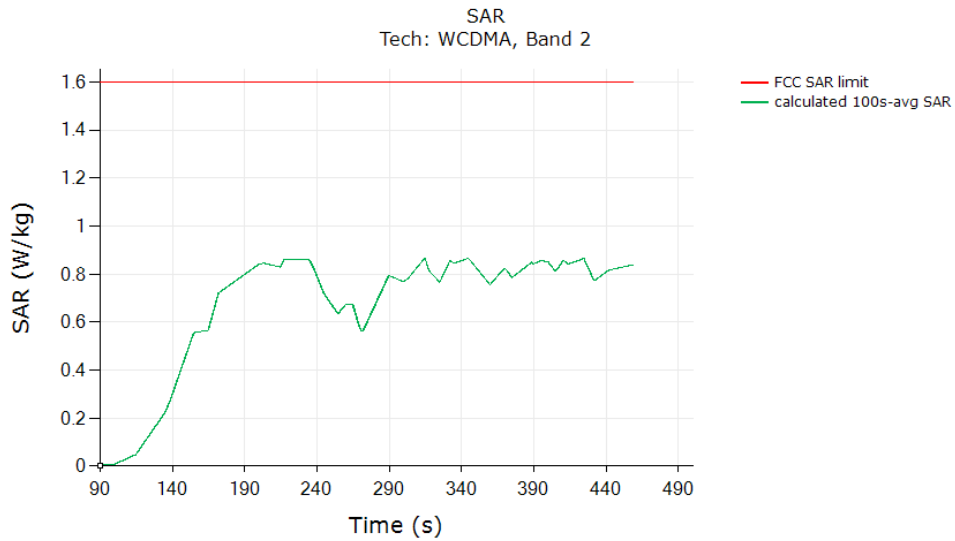

	(W/kg)
FCC 1-g SAR limit	1.6/4.0
Max 100 seconds-time averaged 1-g SAR (green curve)	0.865
Validated: Max time averaged SAR (green curve) is less than the $SAR_{Design\ Limit}$.	

7.3.5. LTE Band 66 (Test Case 5 in Table 6-2)

Test Result for Test Sequence 1:

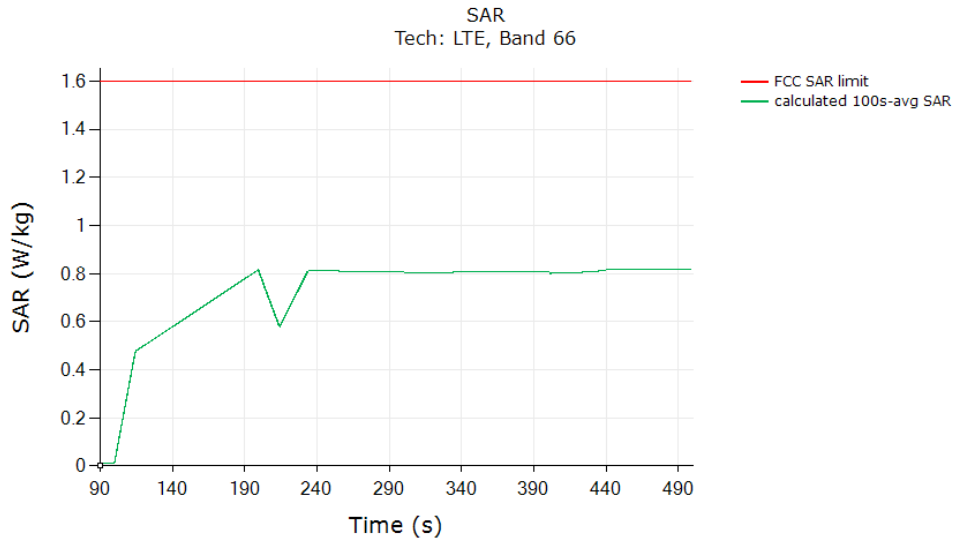

	(W/kg)
FCC 1-g SAR limit	1.6/4.0
Max 100 seconds-time averaged 1-g SAR (green curve)	0.818
Validated: Max time averaged SAR (green curve) is less than the SAR _{Design Limit} .	

Test Result for Test Sequence 2:

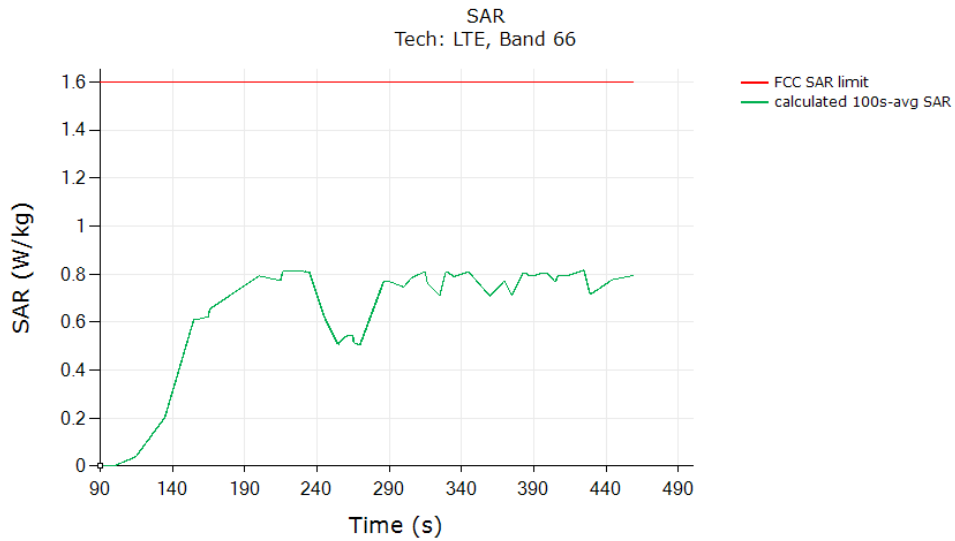

	(W/kg)
FCC 1-g SAR limit	1.6/4.0
Max 100 seconds-time averaged 1-g SAR (green curve)	0.816
Validated: Max time averaged SAR (green curve) is less than the SAR _{Design Limit} .	

7.3.6. LTE Band 2 (Test Case 6 in Table 6-2)

Test Result for Test Sequence 1:

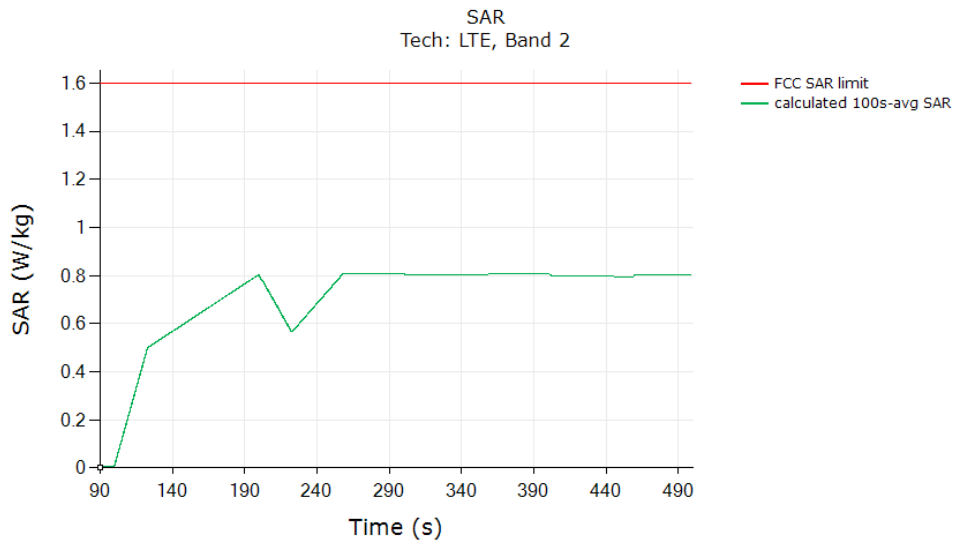

	(W/kg)
FCC 1-g SAR limit	1.6/4.0
Max 100 seconds-time averaged 1-g SAR (green curve)	0.808
Validated: Max time averaged SAR (green curve) is less than the SAR _{Design Limit} .	

Test Result for Test Sequence 2:

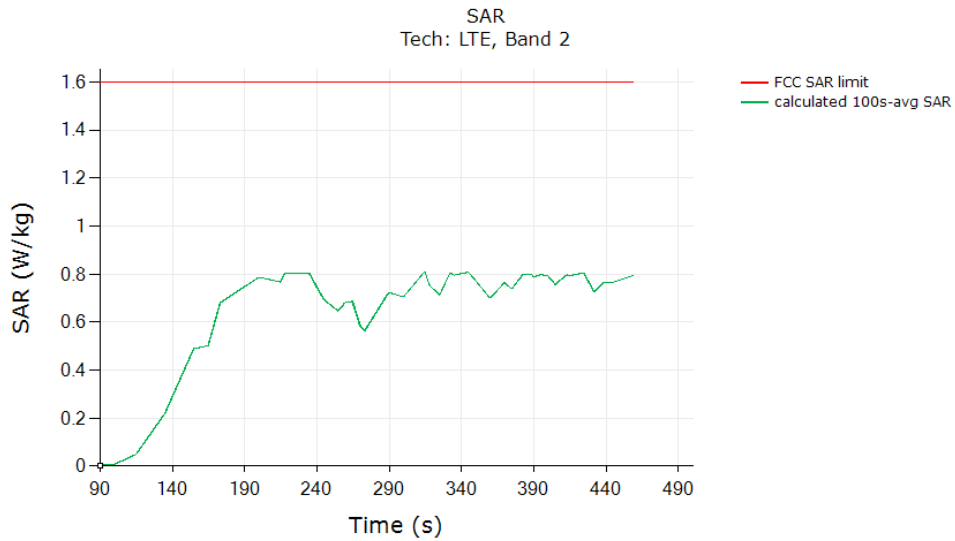

	(W/kg)
FCC 1-g SAR limit	1.6/4.0
Max 100 seconds-time averaged 1-g SAR (green curve)	0.808
Validated: Max time averaged SAR (green curve) is less than the SAR _{Design Limit} .	

7.3.7. Sub-6 GHz NR Band n66 (Test Case 7 in Table 6-2)

Test Result for Test Sequence 1:

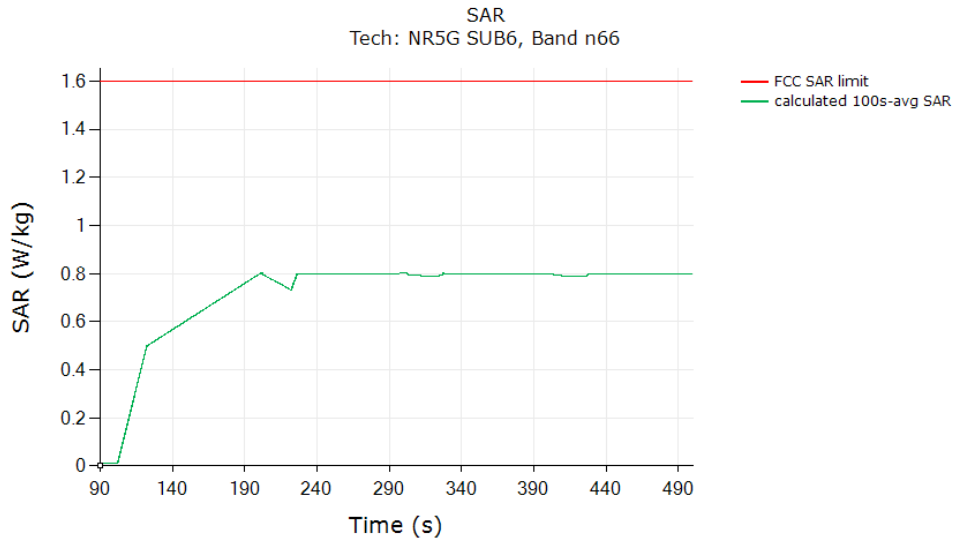

	(W/kg)
FCC 1-g SAR limit	1.6/4.0
Max 100 seconds-time averaged 1-g SAR (green curve)	0.805
Validated: Max time averaged SAR (green curve) is less than the SAR _{Design Limit} .	

Test Result for Test Sequence 2:

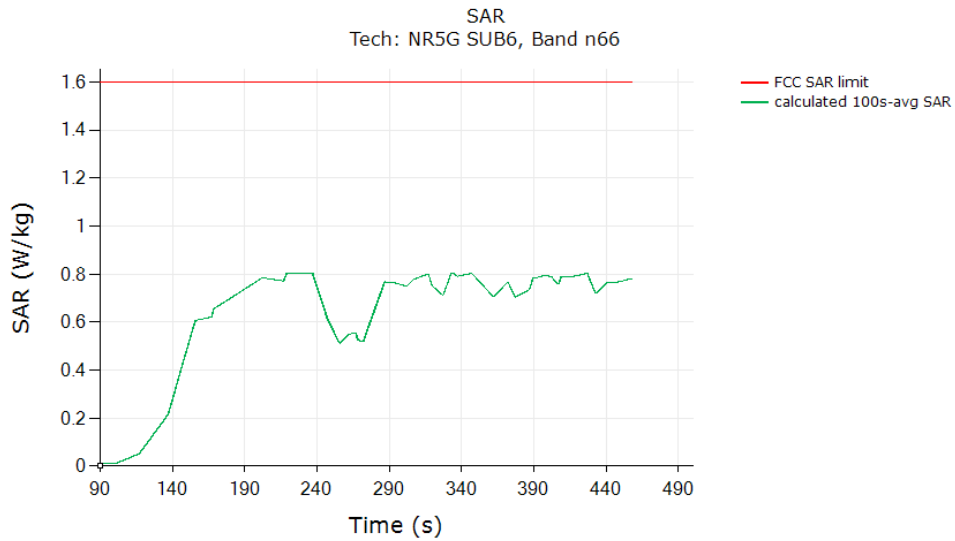

	(W/kg)
FCC 1-g SAR limit	1.6/4.0
Max 100 seconds-time averaged 1-g SAR (green curve)	0.805
Validated: Max time averaged SAR (green curve) is less than the SAR _{Design Limit} .	

7.3.8. Sub-6 GHz NR Band n77 (Test Case 8 in Table 6-2)

Test Result for Test Sequence 1:

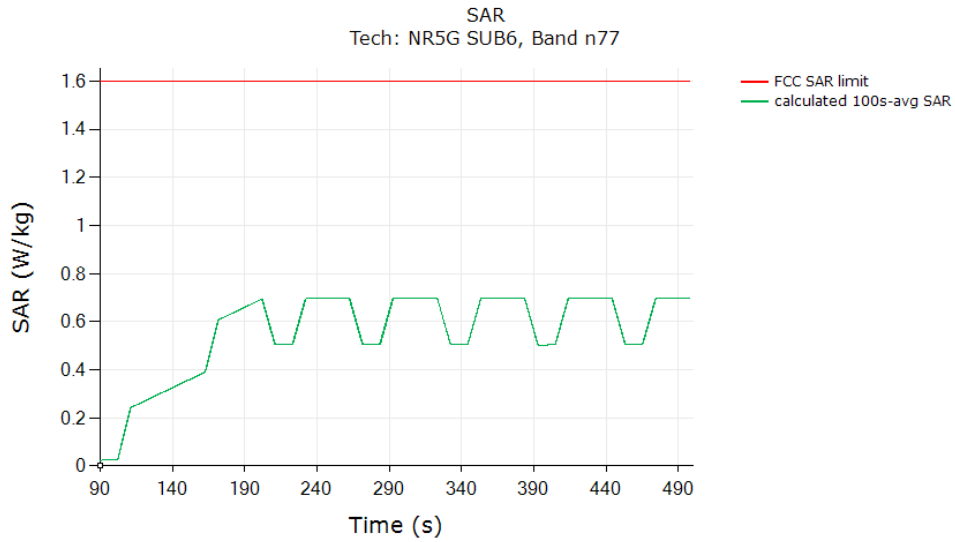

	(W/kg)
FCC 1-g SAR limit	1.6/4.0
Max 100 seconds-time averaged 1-g SAR (green curve)	0.697
Validated: Max time averaged SAR (green curve) is less than the SAR _{Design Limit} .	

Test Result for Test Sequence 2:

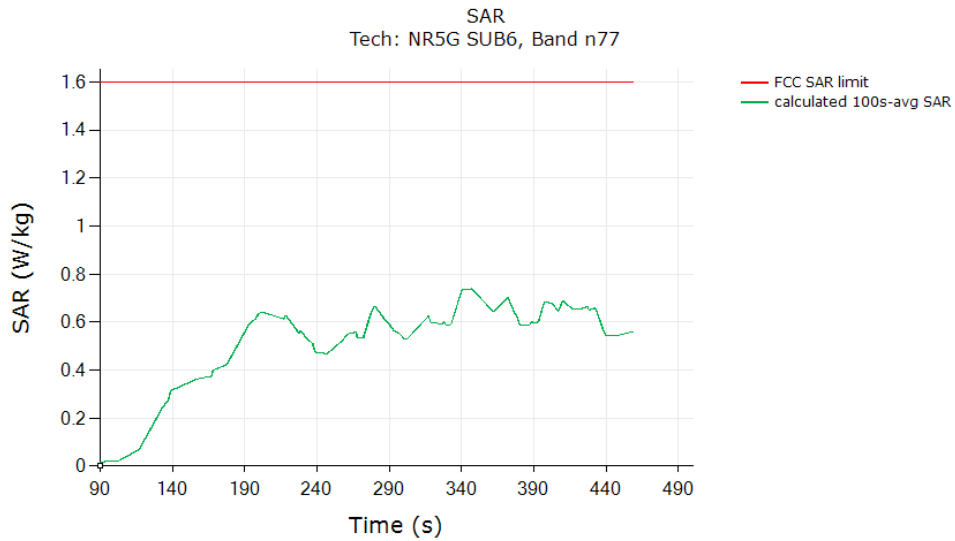

	(W/kg)
FCC 1-g SAR limit	1.6/4.0
Max 100 seconds-time averaged 1-g SAR (green curve)	0.738
Validated: Max time averaged SAR (green curve) is less than the SAR _{Design Limit} .	

7.4. Change in Call Test Results (Test Case 9 in Table 6-2)

This test was measured with LTE 66, Antenna 1, DSI state 1, and with callbox requesting maximum power. The call drop was manually performed when the EUT is transmitting at $P_{reserve}$, as shown in the plot below. The measurement setup is shown in Figure 7-1(a) and (c). The detailed test procedure is described in §4.3.2.

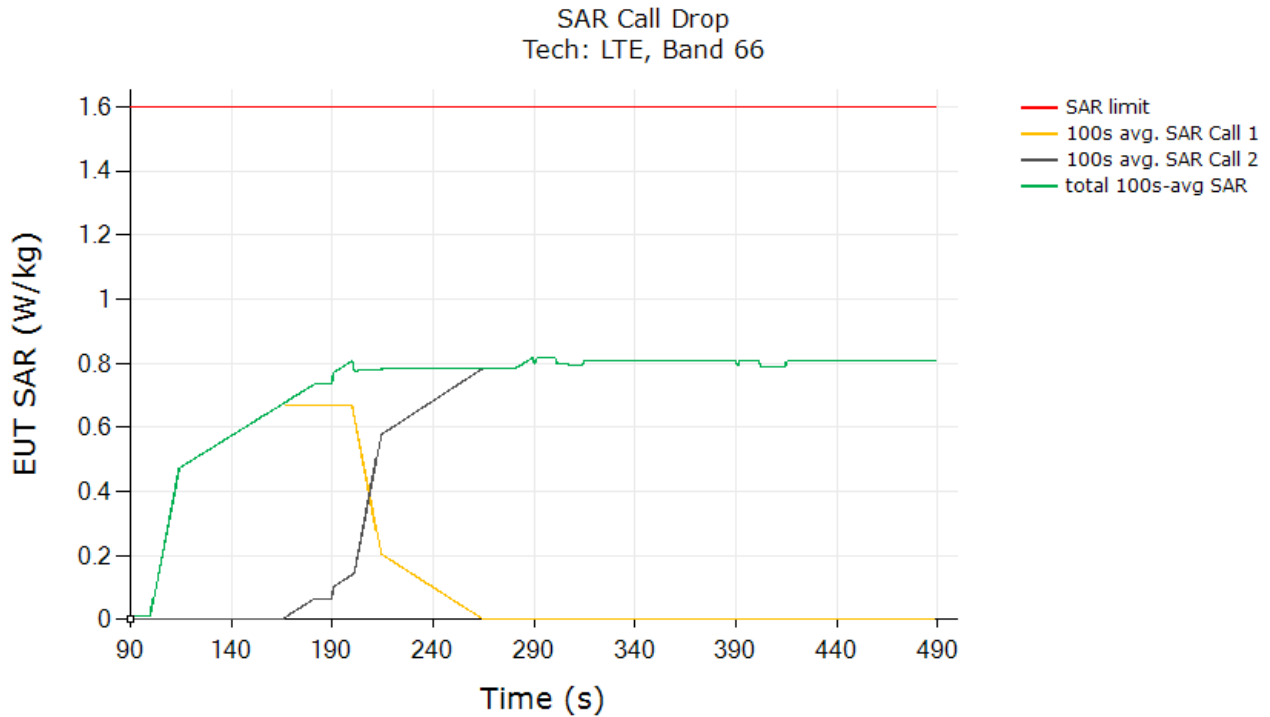

	(W/kg)
FCC 1-g SAR limit	1.6/4.0
Max 60 seconds-time averaged 1-g SAR (green curve)	0.818
Validated	

The test result validated the continuity of power limiting in the call change scenario.

7.5. Change in Technology/Band Test Results (Test Case 10 in Table 6-2)

This test was conducted with the callbox requesting maximum power and with an antenna and technology switch from LTE 66, Antenna 1, DSI state 1 to W-CDMA 4, Antenna 1, DSI state 1. Following the procedure detailed in §4.3.3 and using the measurement setup shown in Figure 7-1(a) and (c), the technology/band switch was performed when the EUT is transmitting at $P_{reserve}$ level as shown in the plot below.

Test Result for Change in Technology/Band:

All the time-averaged conducted transmission power measurement results were converted into time-averaged normalized SAR values using Equation (7a), (7b) and (7c), and plotted below to demonstrate that the time-averaged normalized SAR versus time does not exceed the normalized FCC limit of 1.0:

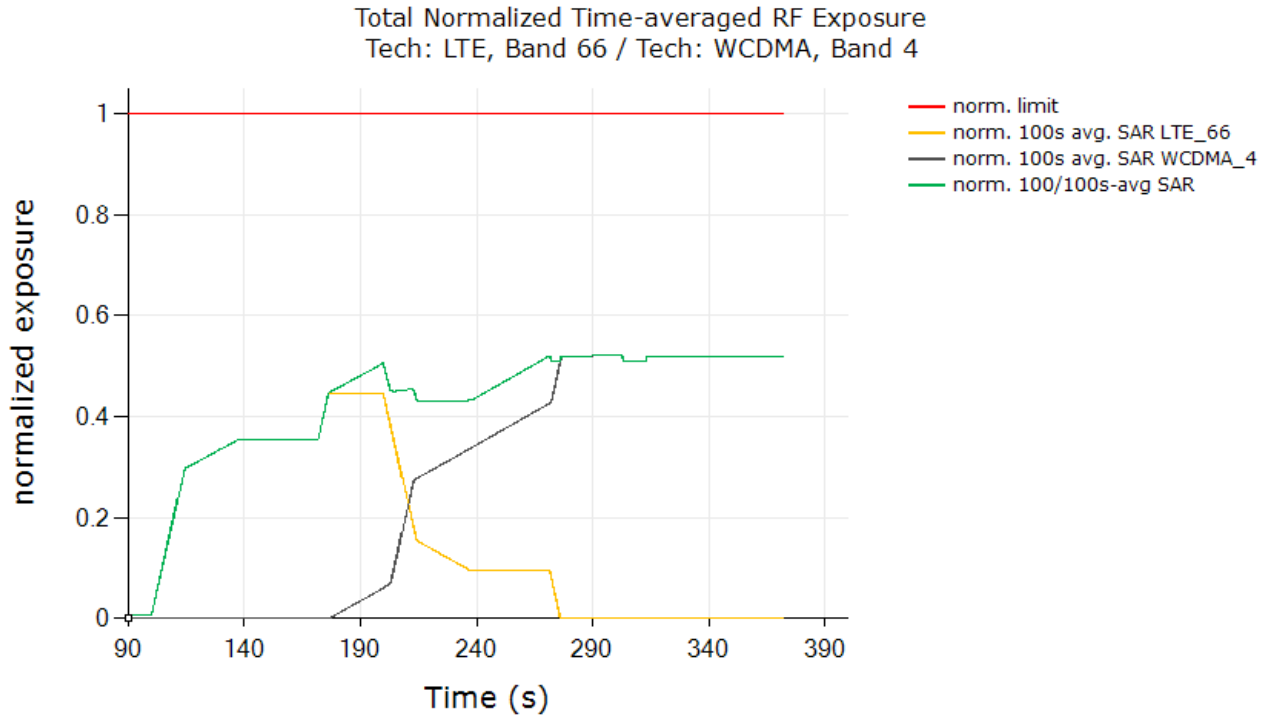

	(W/kg)
FCC normalized SAR limit	1.0
Max 100 seconds-time averaged 1-g SAR (green curve)	0.521
Validated	

The test result validated the continuity of power limiting in technology/band switch scenario.

7.6. Change in DSI Test Results (Test Case 11 in Table 6-2)

This test was conducted with the callbox requesting maximum power, and with the DSI switching states. Following the procedure detailed in §4.3.5 using the measurement setup shown in Figure 7-1(a) and (c), the DSI switch was performed when the EUT is transmitting at $P_{reserve}$ level as shown in the plot below.

Test Result for Change in DSI:

All the time-averaged conducted transmission power measurement results were converted into time-averaged normalized SAR values using Equation (7a), (7b) and (7c), and plotted below to demonstrate that the time-averaged normalized SAR versus time does not exceed the FCC limit of 1 unit.

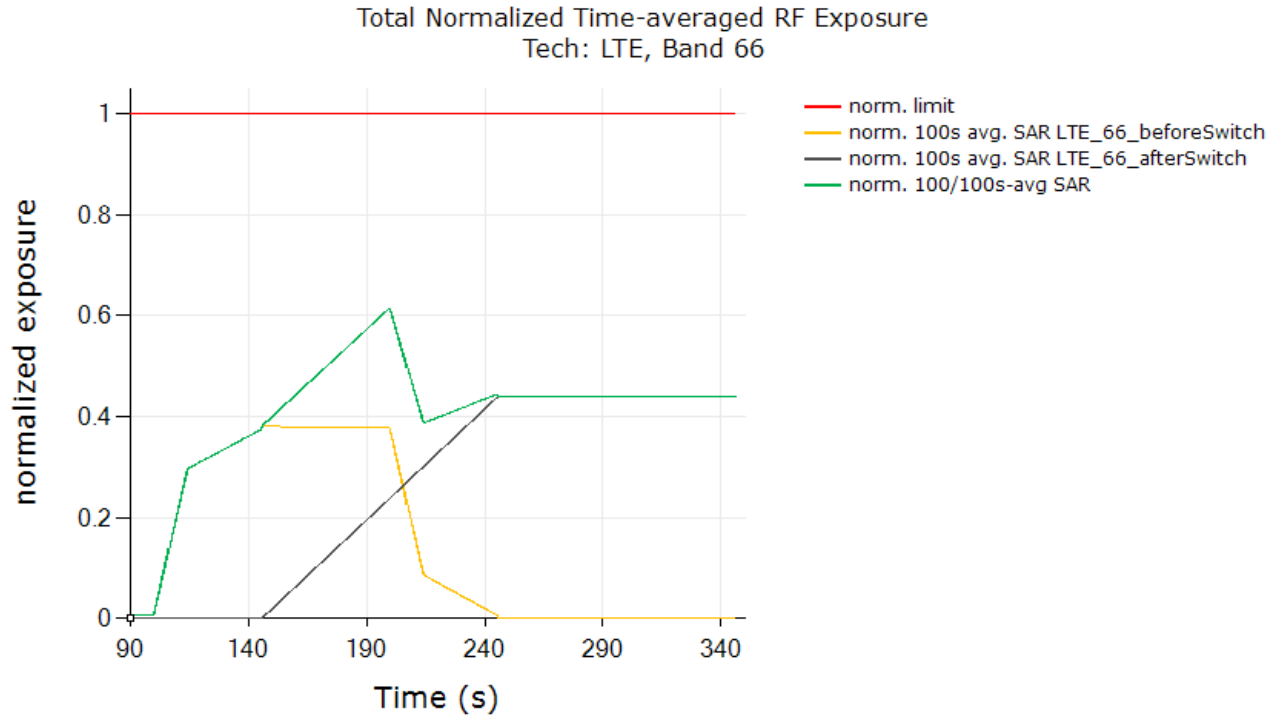

	(W/kg)
FCC normalized total exposure limit	1.0
Max 100 seconds-time averaged normalized SAR (green curve)	0.615
Validated	

The test result validated the continuity of power limiting in the DSI switching scenario.

7.7. Change in Time Window/Antenna Switch Test Results (Test Case 12 in Table 6-2)

This test was conducted with the callbox requesting maximum power and with time-window/antenna switch between LTE 66, Antenna 1, DSI 1 (100 seconds window) and LTE 48, Antenna 7, DSI 1 (60 seconds window). Following the procedure detailed in §4.3.6 and using the measurement setup shown in Figure 6-1(b) and (d), the time-window switch via tech/band/antenna switch was performed when the EUT is transmitting at $P_{reserve}$ level.

7.7.1. Test Case 14: Transition from LTE 66 to LTE 48 (i.e., 100 seconds to 60 seconds), then Back to LTE 66

Test Result for Change in Time Window (from 100 seconds to 60 seconds to 100 seconds):

All the conducted transmission power measurement results were converted into time-averaged normalized SAR values using Equation (7a), (7b) and (7c) and plotted below to demonstrate that the time-averaged normalized SAR versus time does not exceed the FCC limit of 1 unit. Equation (7a) is used to convert the transmission power of the device to obtain the 100 seconds-averaged normalized SAR for LTE 66 as shown with the black curve. Similarly, equation (7b) is used to obtain the 60 seconds-averaged normalized SAR for LTE 48 as shown with the orange curve. Equation (7c) is used to obtain the total time-averaged normalized SAR as shown with the green curve (i.e., the sum of both the black and orange curves).

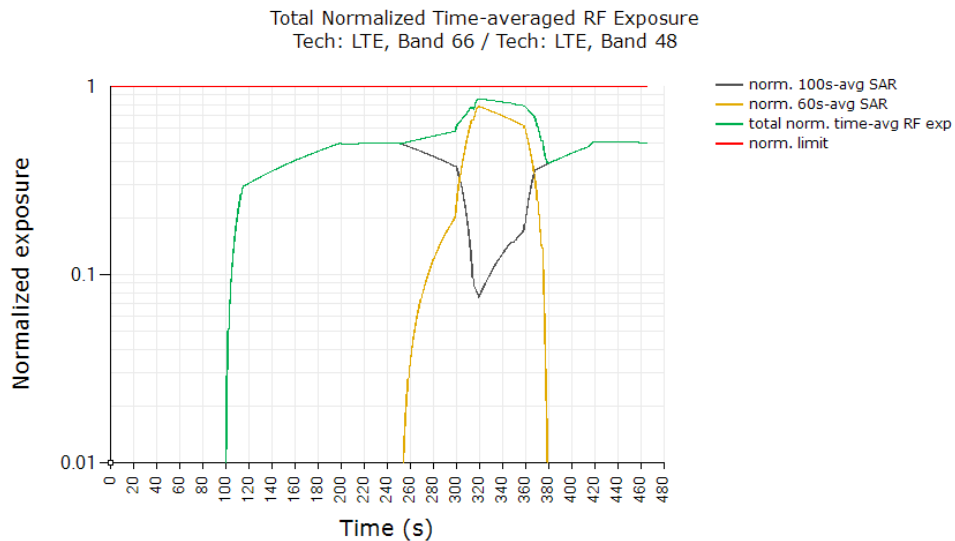

	(W/kg)
FCC normalized total exposure limit	1.0
Max time averaged normalized SAR (green curve)	0.859
Validated	

7.8. Switch in SAR Exposure Test Results (Test Case 13 in Table 6-2)

This test was conducted with the callbox requesting maximum power and with the EUT in LTE 66 + Sub-6 GHz NR Band n25 call. Following the procedure detailed in §4.3.7 and Appendix B.2, and using the measurement setup shown in Figure 7-1(a) and (c), since LTE and Sub-6 GHz NR are sharing the same antenna port (otherwise, it should be Figure 7-1(b) and (d) for different antenna ports), the SAR exposure switch measurement is performed with the EUT in various SAR exposure scenarios, i.e., in SAR_{Sub-6 GHz NR} only scenario (t =10s ~125s), SAR_{Sub-6 GHz NR} + SAR_{LTE} scenario (t =125s ~ 235s) and SAR_{LTE} only scenario (t > 235s).

All the conducted transmission power measurement results were converted into time-averaged normalized SAR values using Equation (7a), (7b) and (7c) and plotted below to demonstrate that the time-averaged normalized SAR versus time does not exceed the FCC limit of 1 unit. Equation (7a) is used to convert the LTE transmission power of the device to obtain the 100 seconds-averaged normalized SAR in LTE 66 as shown with the black curve. Similarly, equation (7b) is used to obtain the 100 seconds-averaged normalized SAR in Sub-6 GHz NR Band n25 as shown with the orange curve. Equation (7c) is used to obtain the total time-averaged normalized SAR as shown with the green curve (i.e., sum of both the black and orange curves).

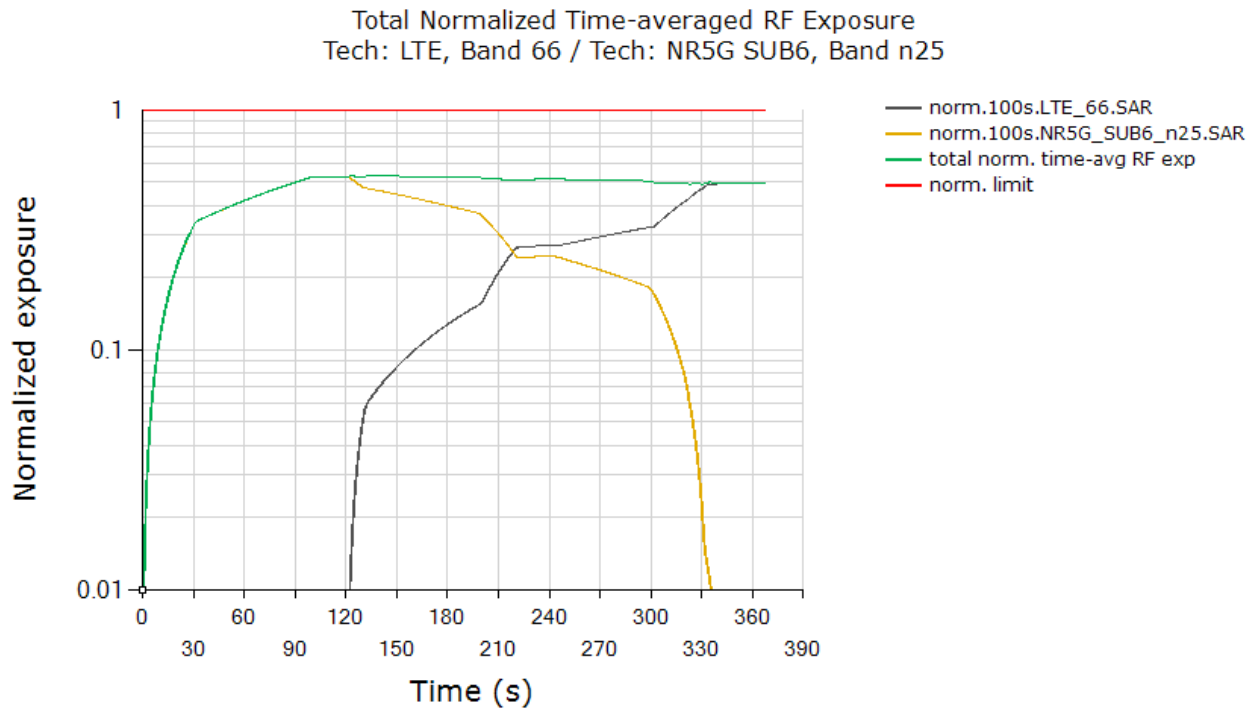

	(W/kg)
FCC normalized total exposure limit	1.0
Max time averaged normalized SAR (green curve)	0.531
Validated	

8. SAR Test Results for Sub-6 GHz Smart Transmit Feature Validation

8.1. Measurement Setup

The measurement setup in Figure 8-1 is like the normal SAR measurements (see Appendix E for missing figures). The difference in SAR measurement setup for time averaging feature validation is that the callbox is signaling in closed loop power control mode (instead of requesting maximum power in open loop control mode) and the callbox is connected to the PC using GPIB so that the test script executed on the PC can send GPIB commands to control the callbox's requested power over time (test sequence). The same test script used in the conducted setup for time-varying transmission power measurements is also used in this section for running the test sequences during SAR measurements and the recorded values from the disconnected power meter by the test script were discarded.

As mentioned in §4.4, for the EUT to follow the TPC command sent from the callbox wirelessly, the "path loss" between the callbox antenna and the EUT needs to be *very well calibrated*. Since the SAR chamber is in an uncontrolled environment, precautions must be taken to minimize the environmental influences on "path loss". Similarly, in the case of time-varying SAR measurements in Sub-6 GHz NR (with LTE as an anchor), "path loss" between the callbox antenna and the EUT needs to be carefully calibrated for both the LTE link as well as for the Sub-6 GHz NR link.

The EUT is placed in its worst-case position according to Table 6-2.

8.1.1. Set-up for Path Loss Calibration

Operator movements inside SAR chamber significantly influence the path loss between callbox and EUT, which in turn causes fluctuations in EUT Tx power during SAR measurements. Therefore, cDASY6 operator is required to be as still as possible during SAR measurements.

8.2. SAR Measurement Results

Following §4.4 procedure, time-averaged SAR measurements are conducted using ES3DV3 probe at peak location of area scan over 500 seconds. The distance between ES3DV3 probe tip to flat section of the SAM Twin phantom surface is 3 mm, and the distance between ES3DV3 probe sensor to probe tip is 2 mm. Furthermore detailed the steps for conducting time-averaged SAR measurements using cDASY6 SAR measurement system used for this validation. cDASY6 records pointSAR values periodically every X seconds, where

X = maximum (0.5s; least multiple of probe integration time \geq 0.5s).

Probe integration times depend on the communication signal being tested. Integration times used by SPEAG for their probe calibrations can be downloaded from here (integration time is listed on the bottom of the first page for each tech):

<https://www.speag.com/assets/downloads/services/cs/UIDSummary171205.pdf>

Since the sampling rate used by cDASY6 for pointSAR measurements is not in user control, the individual pointSAR data from cDASY6 are extracted into excel spreadsheet and the number of points in 100s interval is determined by $\text{total_points} * (100\text{s} / \text{pointSAR_total_scan_time_duration})$. Running average is performed over these number of points in excel spreadsheet to obtain 100s-averaged pointSAR.

Following §4.4, for each of selected technology/band:

1. With EUT set to peak mode, area scan is performed at P_{limit}, and time-averaged pointSAR measurements are conducted to determine the pointSAR at P_{limit}, denoted as pointSAR_{P_{limit}}.
2. With EUT set to intended Smart Transmit exposure mode, two more time-averaged pointSAR measurements are performed at the same peak location for test sequences 1 and 2.

To demonstrate compliance, all the pointSAR measurement results were converted into 1-gSAR values by using equation (6a) listed below:

$$1gSAR(t) = \text{pointSAR}(t) \cdot \text{pointSAR_P}_{limit} * 1gSAR_P_{limit} \quad (6a)$$

and by applying the worst-case 1-gSAR value for each technology/band at P_{limit} as reported in the Part 1 report.

8.2.1. GPRS PCS Antenna 1 SAR Test Results

SAR Test Results for Test Sequence 1:

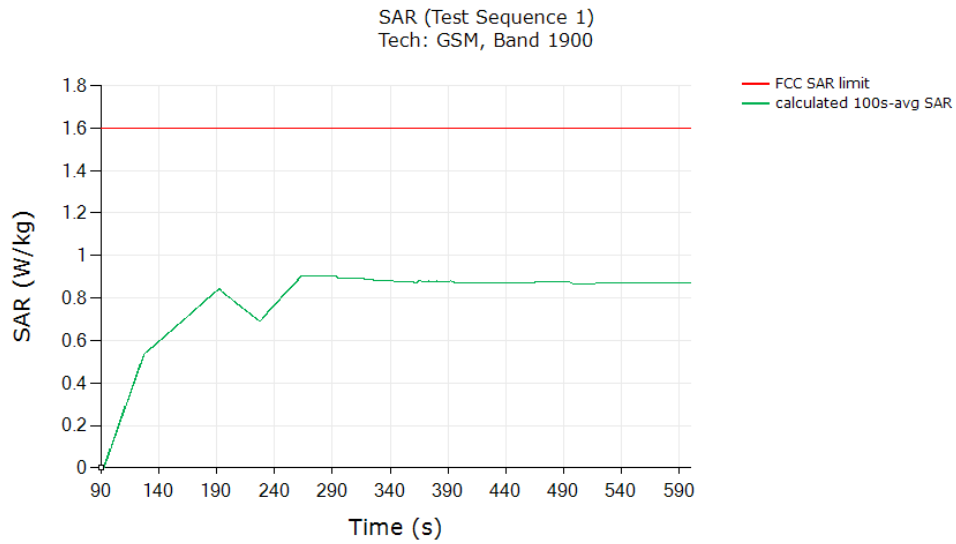

	(W/kg)
FCC 1-g SAR limit	1.6/4.0
Max 100 seconds-time averaged point 1-g SAR (green curve)	0.903
Validated: Max time averaged SAR (green curve) is less than the $SAR_{Design Limit}$.	

SAR Test Results for Test Sequence 2:

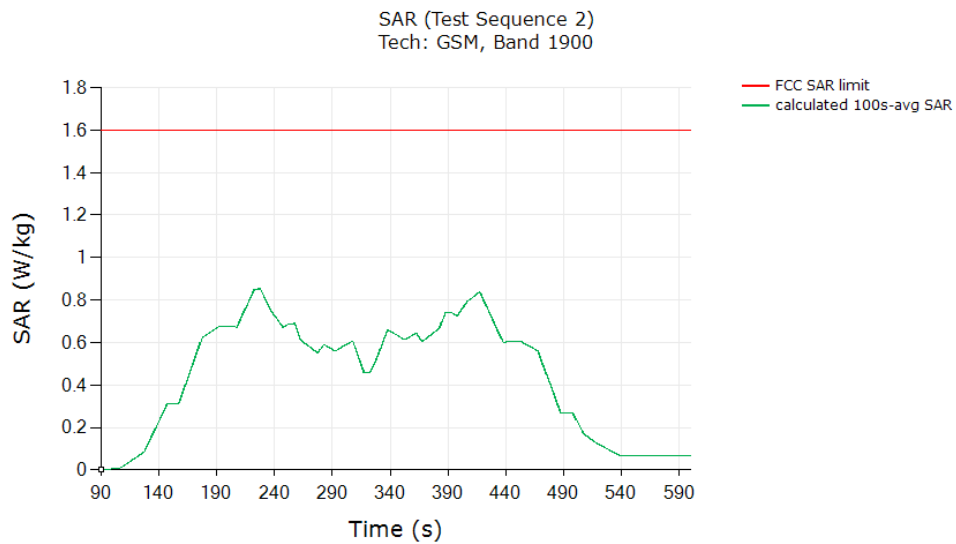

	(W/kg)
FCC 1-g SAR limit	1.6/4.0
Max 100 seconds-time averaged point 1-g SAR (green curve)	0.854
Validated: Max time averaged SAR (green curve) is less than the $SAR_{Design Limit}$.	

8.2.2. GPRS PCS Antenna 3 SAR Test Results

SAR Test Results for Test Sequence 1:

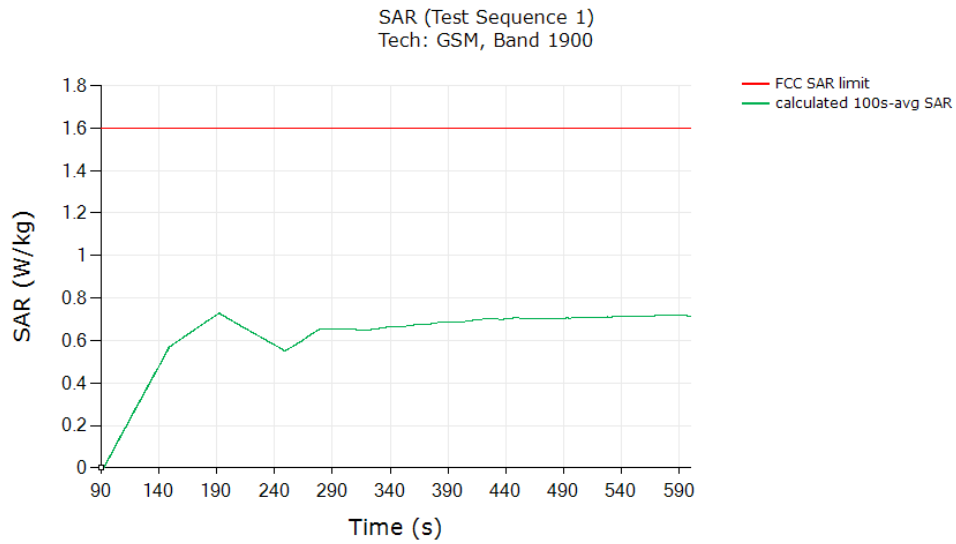

	(W/kg)
FCC 1-g SAR limit	1.6/4.0
Max 100 seconds-time averaged point 1-g SAR (green curve)	0.730
Validated: Max time averaged SAR (green curve) is less than the SAR _{Design Limit} .	

SAR Test Results for Test Sequence 2:

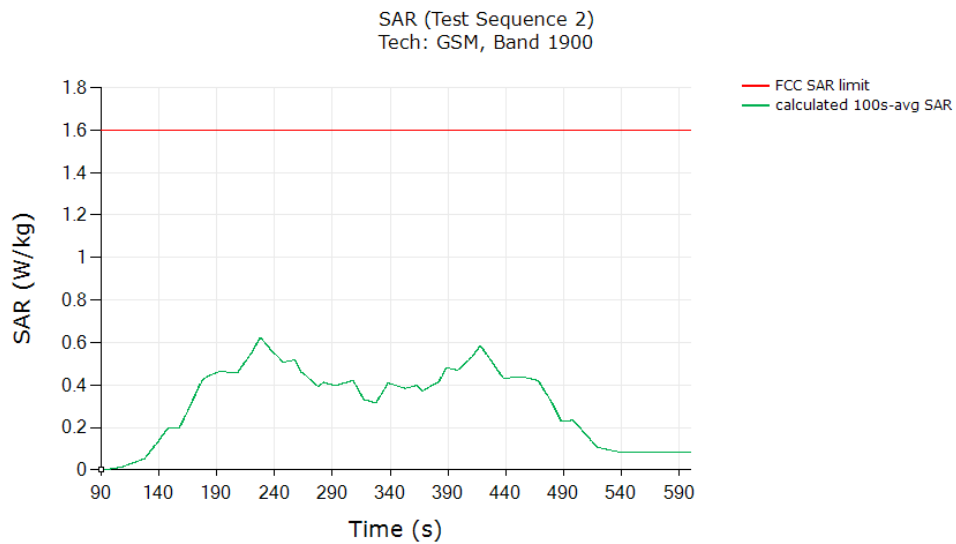

	(W/kg)
FCC 1-g SAR limit	1.6/4.0
Max 100 seconds-time averaged point 1-g SAR (green curve)	0.623
Validated: Max time averaged SAR (green curve) is less than the SAR _{Design Limit} .	

8.2.3. W-CDMA Band 4 Antenna 1 SAR Test Results

SAR Test Results for Test Sequence 1:

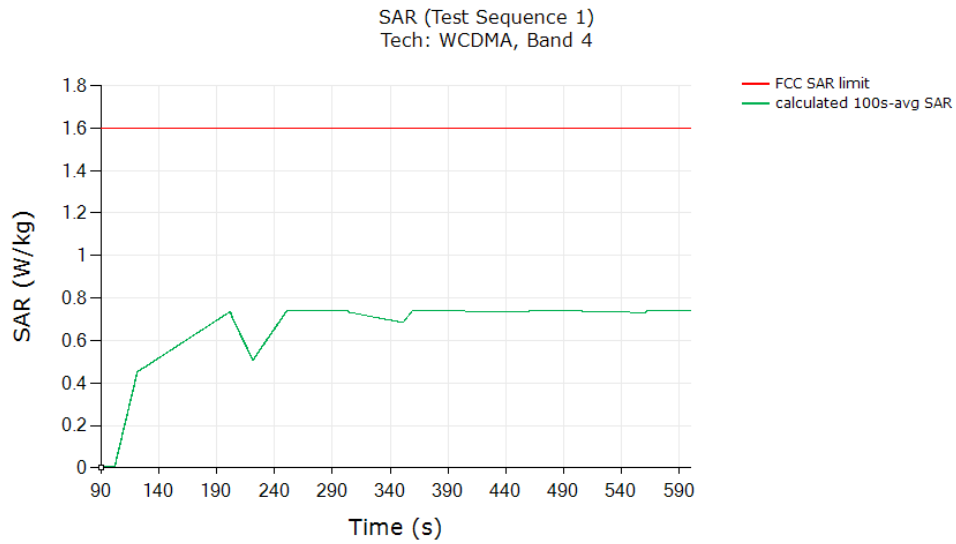

	(W/kg)
FCC 1-g SAR limit	1.6/4.0
Max 100 seconds-time averaged point 1-g SAR (green curve)	0.743
Validated: Max time averaged SAR (green curve) is less than the $SAR_{Design\ Limit}$.	

SAR Test Results for Test Sequence 2:

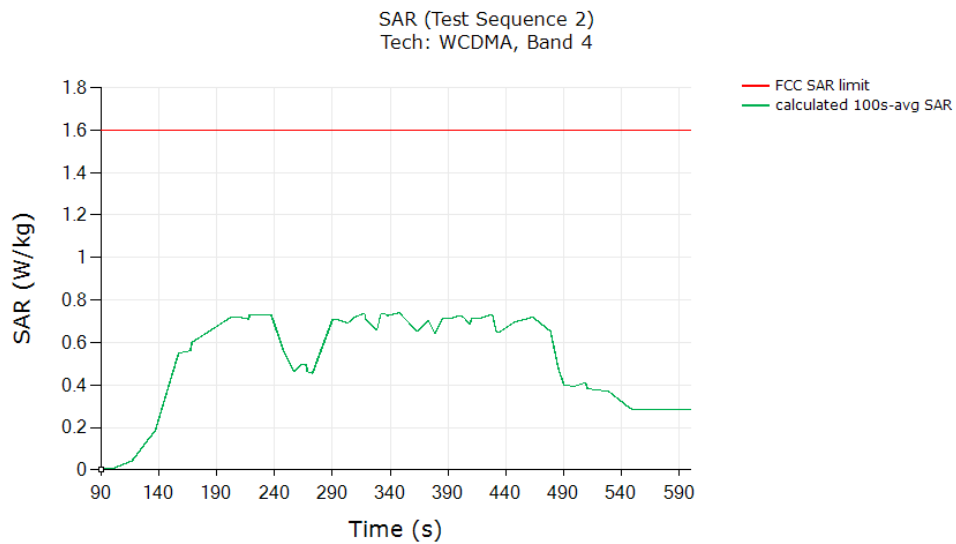

	(W/kg)
FCC 1-g SAR limit	1.6/4.0
Max 100 seconds-time averaged point 1-g SAR (green curve)	0.739
Validated: Max time averaged SAR (green curve) is less than the $SAR_{Design\ Limit}$.	

8.2.4. W-CDMA Band 2 Antenna 1 SAR Test Results

SAR Test Results for Test Sequence 1:

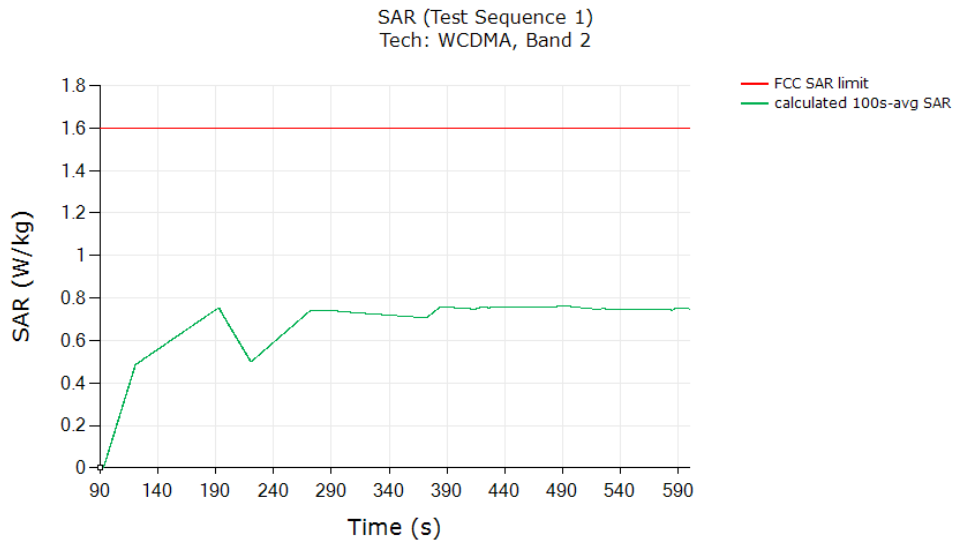

	(W/kg)
FCC 1-g SAR limit	1.6/4.0
Max 100 seconds-time averaged point 1-g SAR (green curve)	0.762
Validated: Max time averaged SAR (green curve) is less than the $SAR_{Design\ Limit}$.	

SAR Test Results for Test Sequence 2:

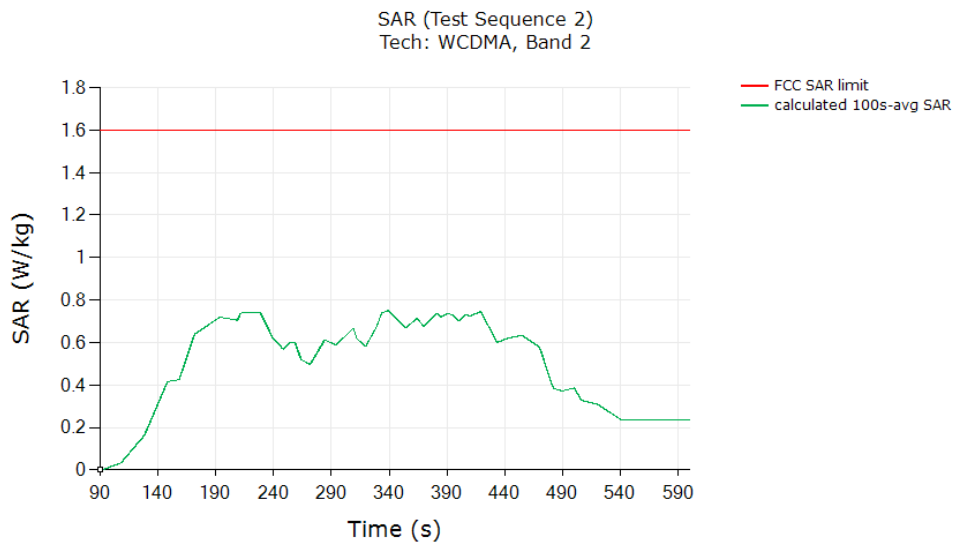

	(W/kg)
FCC 1-g SAR limit	1.6/4.0
Max 100 seconds-time averaged point 1-g SAR (green curve)	0.749
Validated: Max time averaged SAR (green curve) is less than the $SAR_{Design\ Limit}$.	

8.2.5. LTE Band 66 Antenna 1 SAR Test Results

SAR Test Results for Test Sequence 1:

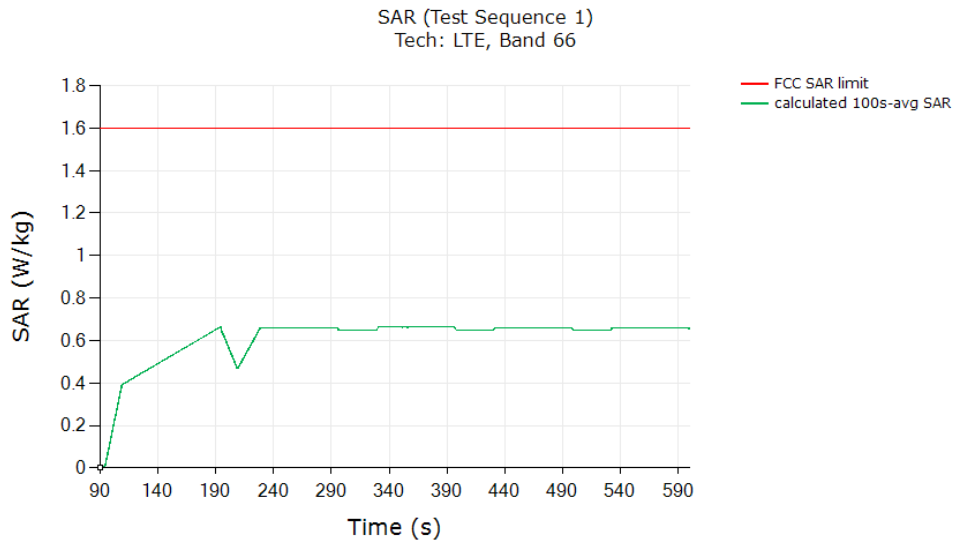

	(W/kg)
FCC 1-g SAR limit	1.6/4.0
Max 100 seconds-time averaged point 1-g SAR (green curve)	0.664
Validated: Max time averaged SAR (green curve) is less than the $SAR_{Design\ Limit}$.	

SAR Test Results for Test Sequence 2:

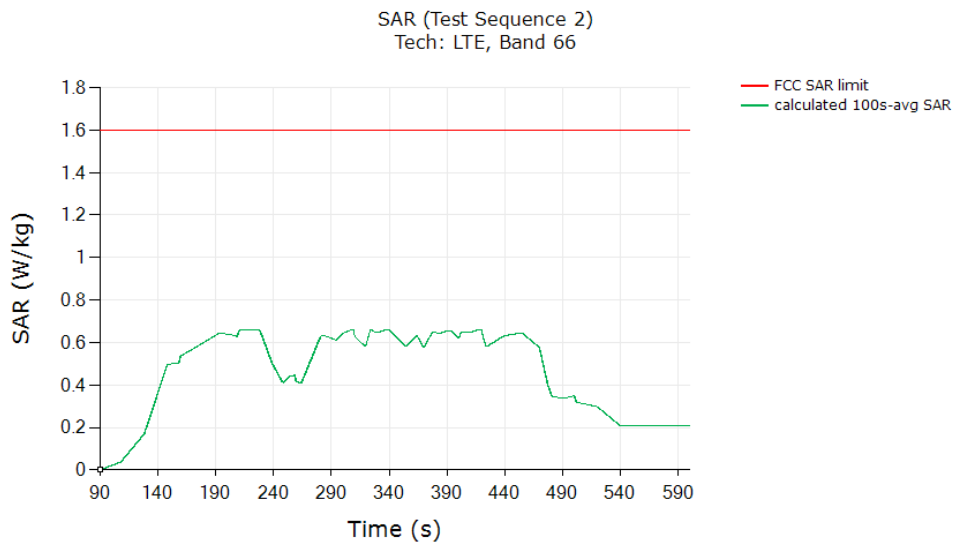

	(W/kg)
FCC 1-g SAR limit	1.6/4.0
Max 100 seconds-time averaged point 1-g SAR (green curve)	0.662
Validated: Max time averaged SAR (green curve) is less than the $SAR_{Design\ Limit}$.	

8.2.6. LTE Band 2 Antenna 1 SAR Test Results

SAR Test Results for Test Sequence 1:

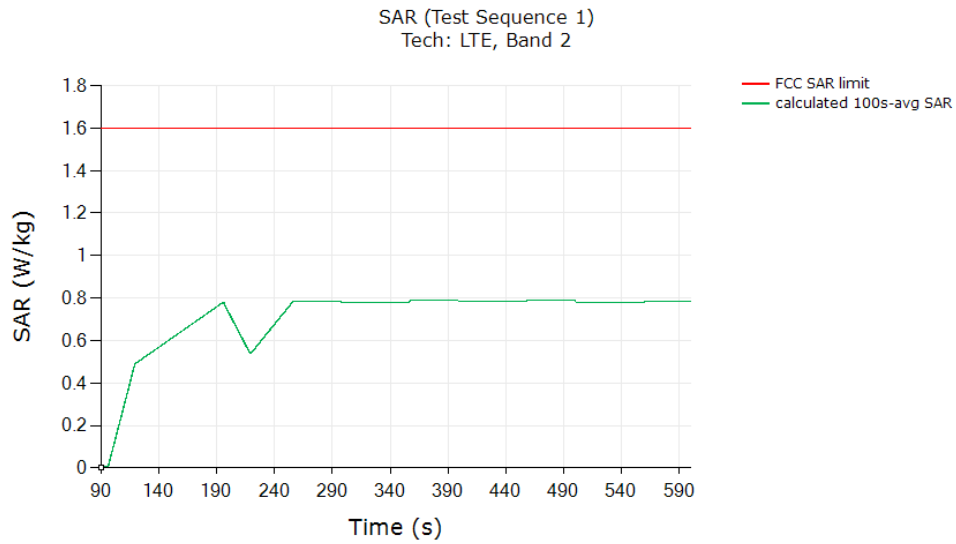

	(W/kg)
FCC 1-g SAR limit	1.6/4.0
Max 100 seconds-time averaged point 1-g SAR (green curve)	0.790
Validated: Max time averaged SAR (green curve) is less than the $SAR_{Design Limit}$.	

SAR Test Results for Test Sequence 2:

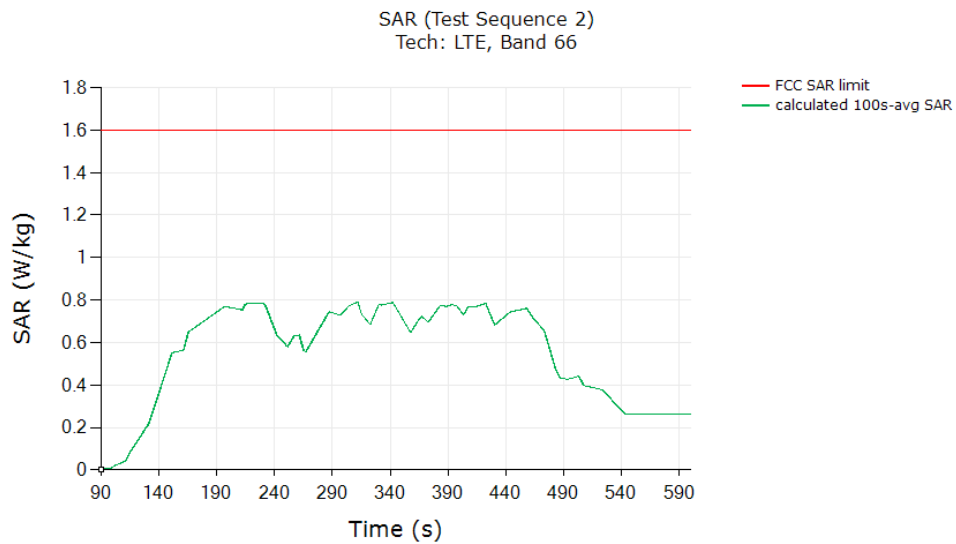

	(W/kg)
FCC 1-g SAR limit	1.6/4.0
Max 100 seconds-time averaged point 1-g SAR (green curve)	0.789
Validated: Max time averaged SAR (green curve) is less than the $SAR_{Design Limit}$.	

8.2.7. Sub-6 GHz NR Band n66 SAR Test Results

SAR Test Results for Test Sequence 1:

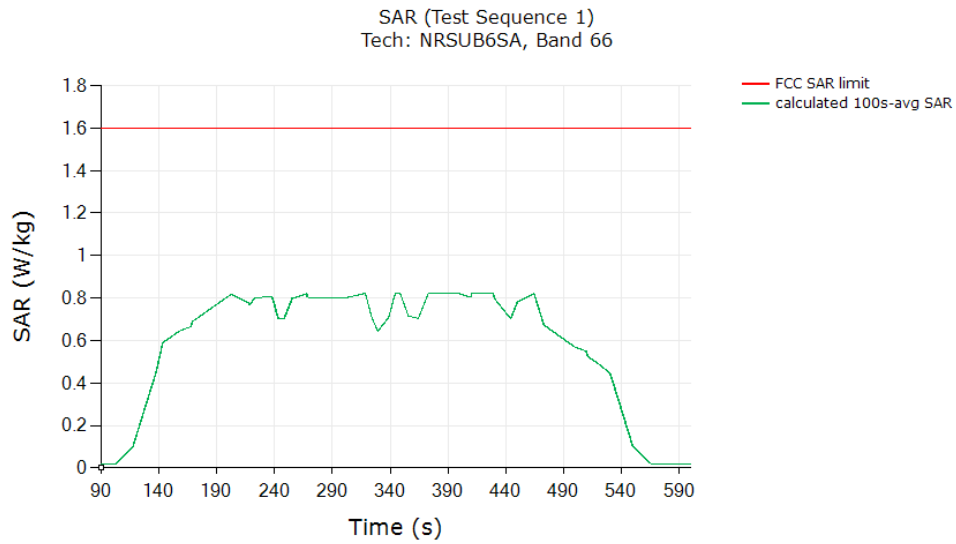

	(W/kg)
FCC 1-g SAR limit	1.6/4.0
Max 100 seconds-time averaged point 1-g SAR (green curve)	0.821
Validated: Max time averaged SAR (green curve) is less than the $SAR_{Design Limit}$.	

SAR Test Results for Test Sequence 2:

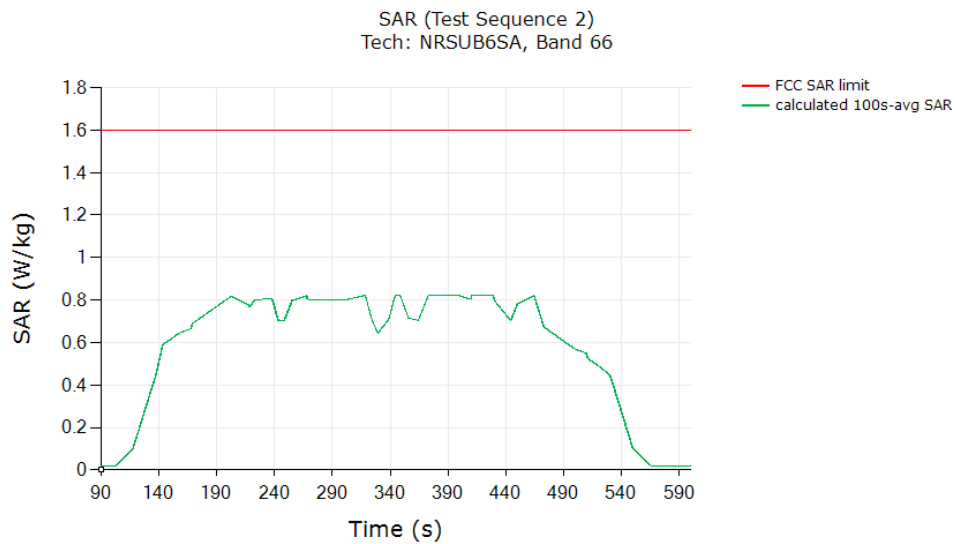

	(W/kg)
FCC 1-g SAR limit	1.6/4.0
Max 100 seconds-time averaged point 1-g SAR (green curve)	0.821
Validated: Max time averaged SAR (green curve) is less than the $SAR_{Design Limit}$.	

8.2.8. Sub-6 GHz NR Band n77 SAR Test Results

SAR Test Results for Test Sequence 1:

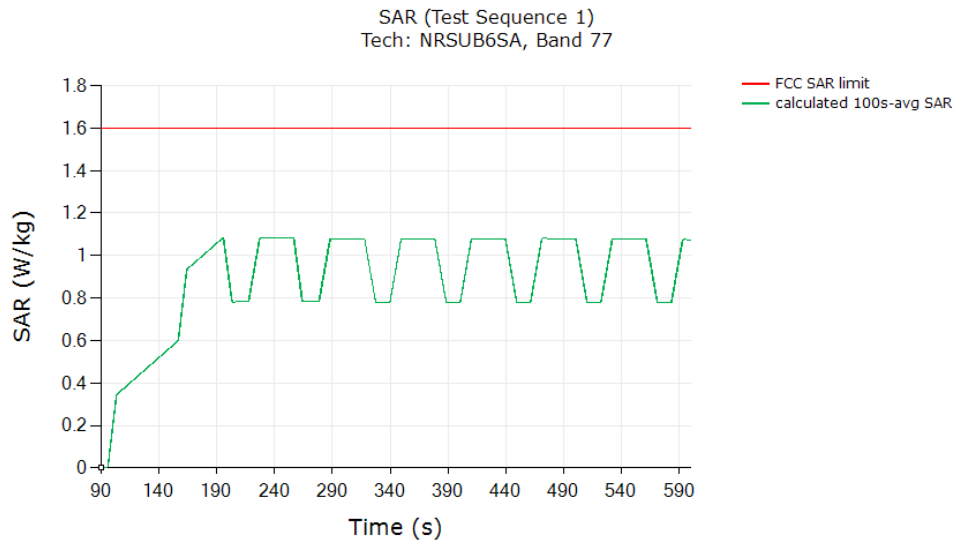

	(W/kg)
FCC 1-g SAR limit	1.6/4.0
Max 100 seconds-time averaged point 1-g SAR (green curve)	1.084
Validated: Max time averaged SAR (green curve) is less than the $SAR_{Design\ Limit}$.	

SAR Test Results for Test Sequence 2:

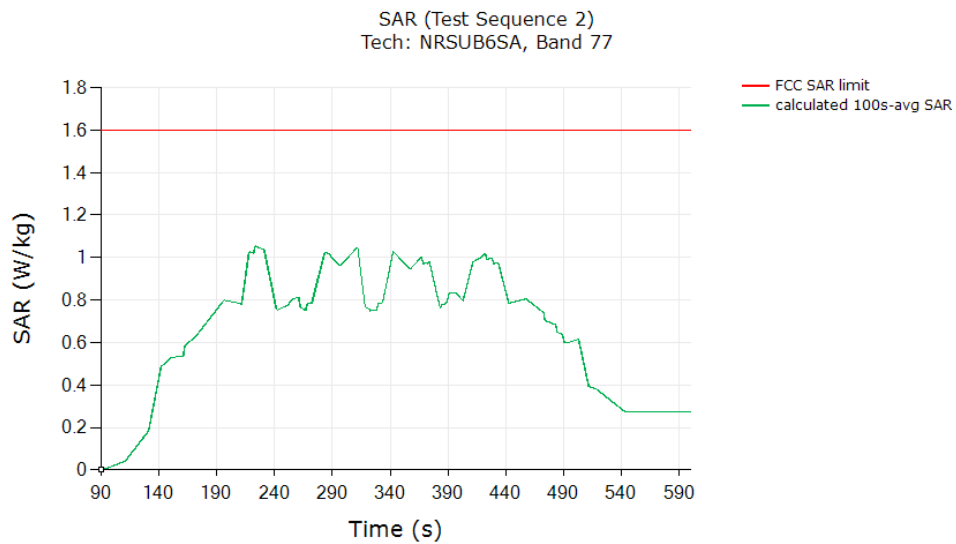

	(W/kg)
FCC 1-g SAR limit	1.6/4.0
Max 100 seconds-time averaged point 1-g SAR (green curve)	1.053
Validated: Max time averaged SAR (green curve) is less than the $SAR_{Design\ Limit}$.	

9. Radiated Power Test Results for mmW Smart Transmit Feature Validation

9.1. Measurement Setup

The Keysight Technologies E7515B UXM callbox is used in this test. The test setup is shown in Figure 9-1a and the schematic of the setup is shown in Figure 9-1b (see Appendix E for missing figures). The UXM callbox has two RF radio heads to up/down convert IF to mmW frequencies, which, in turn, are connected to two horn antennas for V- and H-polarizations for downlink communication. In the uplink, a directional coupler is used in the path of one of the horn antennas to measure and record radiated power using a Rohde & Schwarz NR50S power sensor and NRP2 power meter.²⁴

The EUT is placed inside an anechoic chamber with V- and H-pol horn antennas to establish the radio link as shown in Figure 9-1. The callbox's LTE port is directly connected to the EUT's RF port via a directional coupler to measure the EUT's conducted transmission power using a Rohde & Schwarz NR8S power sensor and NRP2 power meter. Additionally, the EUT is connected to the PC via USB connection for sending beam switch command. Care is taken to route the USB cable and RF cable (for LTE connection) away from the EUT's mmW antenna modules.

Setup in Figure 9-1 is used for the test scenario 1, 4, and 5, as described in §3. The test procedures described in §5 are followed. The path losses from the EUT to both the power meters are calibrated and used as an offset in the power meter.

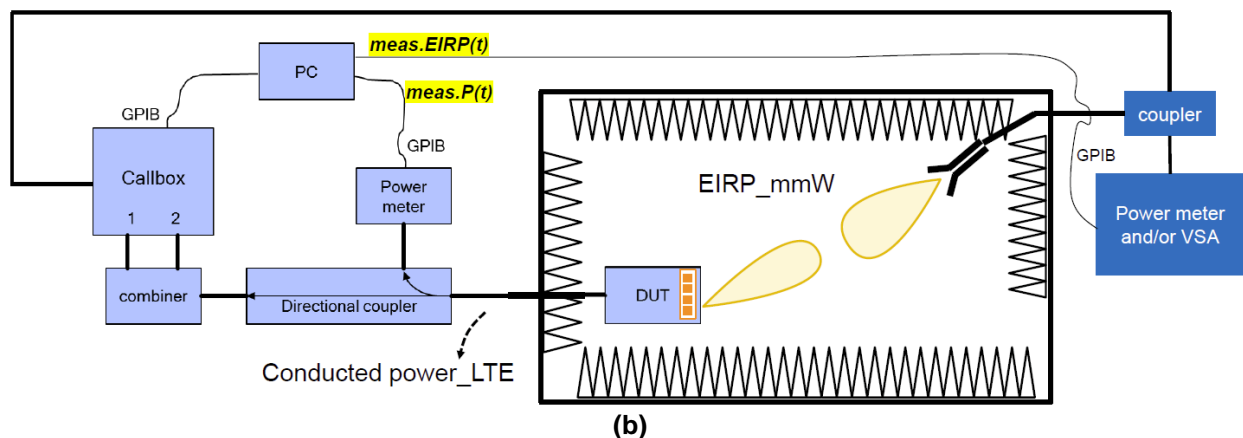

Figure 9-1 mmW NR radiated power measurement setup (see Appendix E for missing figures)

Both the callbox and power meters are connected to the PC using USB cables. Test scripts are custom made for automation, i.e., establishing an LTE + mmW call, conducted transmission power recording for LTE, and radiated transmission power recording for mmW. These tests are manually stopped after the desired time duration. The test script is programmed to set the LTE transmission power to all-down bits on the callbox immediately after the mmW link is established and programmed to toggle between all-up and all-down bits depending on the transmission scenario being evaluated. Similarly, the test script is also programmed to send beam switching commands manually to the EUT via a USB connection. For all the tests, the callbox is set to request maximum transmission power from the mmW NR radio from the EUT.

Smart Transmit EFS version 18 supports DSI applicability feature. With this new enhancement, in simultaneous transmission scenarios involving sub6 radio + mmW radio, for a given DSI, both sub6 exposure and mmW exposure will be evaluated at the DSI corresponding separation distance in TER analysis, but in the same time, the compliance of mmW exposure at 2mm is ensured for all DSI states (Note: at this time, FCC requires PD compliance at 2mm for all DSI states). Thus, below two steps are implemented in Smart Transmit with EFS version 18:

²⁴ The isolation of the directional coupler may not be sufficient to attenuate the downlink signal from the callbox, which will result in high noise floor masking the recording of radiated power from EUT. In that case, either lower the downlink signal strength emanating from the RF radio heads of the callbox or add an attenuator between the callbox radio heads and the directional coupler. Additionally, since the measurements performed in this validation are all relative, measurement of the EUT's radiated power in one polarization is sufficient.

- For TER calculation, scale PD exposure at 2mm down to the same separation distance at which sub6 exposure is measured for that DSI using 'DSI_PD_ratio' (see Part 1 report for the definition of DSI_PD_ratio and its calculation), i.e.,

$$TER_{at_DSI_distance} = sub6\ exposure_{regulatory\ sub6\ limit} + PD\ exposure_{regulatory\ PD\ limit} \times DSI_PD_ratio \quad (9a)$$

where,

$$DSI_PD_ratio = \frac{PD\ at\ DSI\ separation\ distance}{PD\ at\ 2mm} \quad (9b)$$

- Below condition will also be met irrespective of DSI state:

$$PD\ at\ 2mm_{regulatory\ PD\ limit} \leq 1.0 \quad (9c)$$

To provide the example plots for the EUT enabled with Smart Transmit EFS version 18, the worst-case SAR exposure for a particular LTE band was measured at 5mm in hotspot mode, and the corresponding DSI_PD_ratio (i.e., PD from 2mm to 10mm separation distance) was also derived following procedures described in the Part 1 report.²⁷

Test configurations for this validation are detailed in §5.2. Test procedures are listed in §4.3.

9.2. mmW NR Radiated Power Test Results

To demonstrate the compliance, the conducted transmission power of n260/n261 in DSI = 0 is converted to 1-g SAR exposure by applying the corresponding worst-case 1-g SAR value at P_{limit} , as reported in the Part 1 report and listed in Table 6-2 of this report.

Similarly, following Step 4 in §5.3.1, radiated transmission power of mmW Band n261 and n260 for the beams tested is converted by applying the corresponding worst-case 4 cm² PD values measured in the Qualcomm lab and listed in Table 9-1. Qualcomm Smart Transmit feature operates based on the time-averaged transmission power reported on a per symbol basis, which is independent of modulation, channel, and bandwidth (RBs); therefore, the worst-case 4 cm² PD was conducted with the EUT in FTM mode, with CW modulation, and 100% duty cycle. cDASY6 system verification for power density measurement is provided in Appendix C and the associated SPEAG certificates are attached in Appendix D.

Both the worst-case 1-g SAR and 4 cm² PD values used in this section are listed in Table 9-1. The measured EIRP at P_{limit} for the beams tested in this section are also listed in Table 9-1.

Table 9-1: Worst-case 1-g SAR, 4 cm² average PD and EIRP measured at P_{limit} for the selected configurations

mmW Transmission Scenario	Test Case	Test Scenario	Antenna	mmW Band/ Beam	P_{limit} (dBm)	Configuration	Meas. EIRP at P_{limit} (dBm)
A	1	Max Power Test	BG1	n261/20	0.5	Back	15.00
G	2	SAR vs. PD Switch		n261/20	0.5	Back	15.00
D	3	Beam Switch		n261/142	-0.6	Back	17.80
				n261/131	6.6	Back	15.00
A	4	Max Power Test	BG1	n260/19	1.5	Back	21.10
G	5	SAR vs. PD Switch		n260/19	1.5	Back	21.10
D	6	Beam Switch		n260/142	0.7	Back	21.40
				n260/130	7.3	Back	17.80

Test Scenario	Antenna	Band	Meas. P_{limit} (dBm)	Configuration	SAR at P_{limit} (W/kg)
LTE Anchor	1	B25/2	20.70	Back	0.517

9.2.1. Maximum Transmission Power Test Results for n261

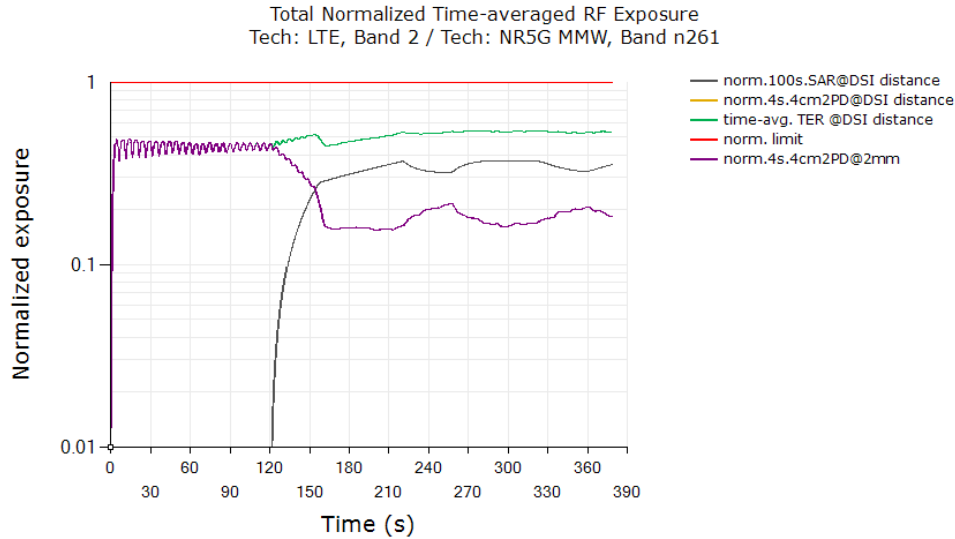

FCC requirement for total RF exposure (normalized)	1.0
Max total normalized time-averaged RF exposure 1-g SAR (green curve)	0.544
Validated	

As can be seen, the power limiting enforcement is effective and the total normalized time-averaged RF exposure does not exceed 1.0. Therefore, the Smart Transmit time averaging feature is validated.

9.2.2. Maximum Transmission Power Test Results for n260

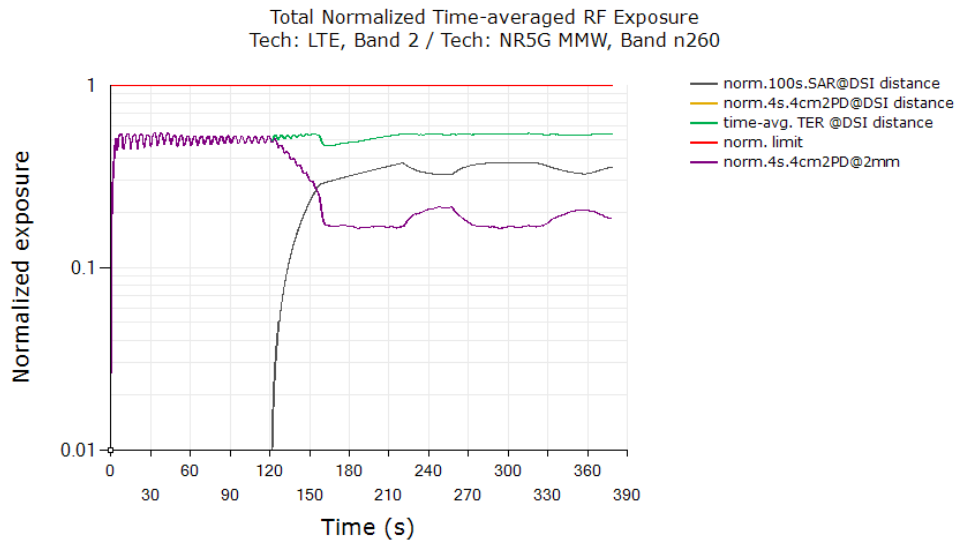

FCC requirement for total RF exposure (normalized)	1.0
Max total normalized time-averaged RF exposure 1-g SAR (green curve)	0.549
Validated	

As can be seen, the power limiting enforcement is effective and the total normalized time-averaged RF exposure does not exceed 1.0. Therefore, the Smart Transmit time averaging feature is validated.

9.2.3. Switch in SAR vs. PD Exposure Test Results for n261

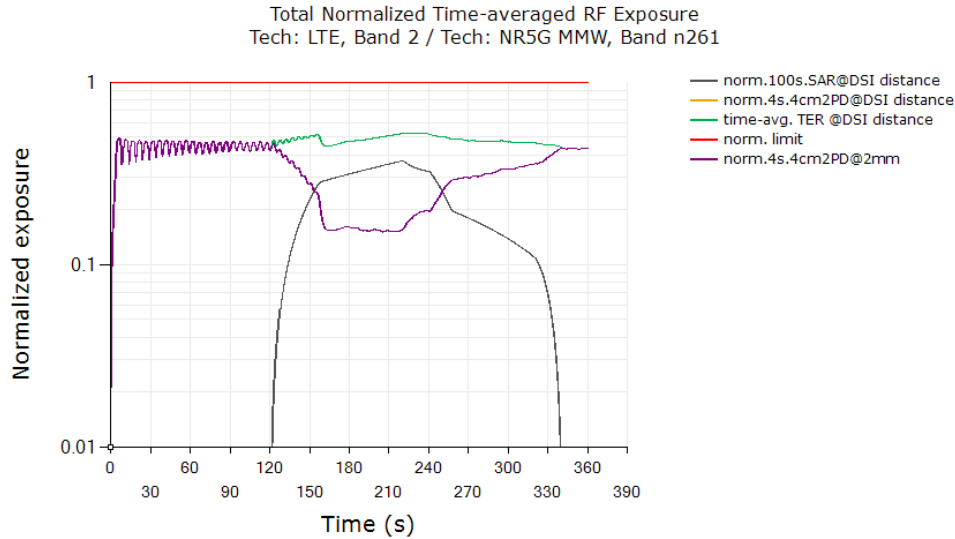

FCC requirement for total RF exposure (normalized)	1.0
Max total normalized time-averaged RF exposure 1-g SAR (green curve)	0.529
Validated	

The power limiting enforcement is effective during transmission when SAR and PD exposures are switched, and the total normalized time-averaged RF exposure does not exceed 1.0. Therefore, the Smart Transmit time averaging feature is validated.

9.2.4. Switch in SAR vs. PD Exposure Test Results for n260

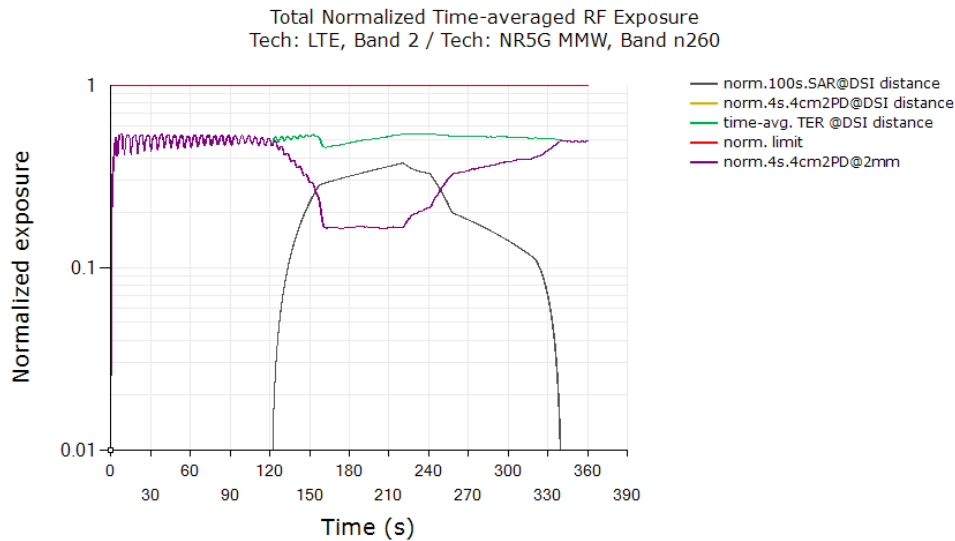

FCC requirement for total RF exposure (normalized)	1.0
Max total normalized time-averaged RF exposure 1-g SAR (green curve)	0.544
Validated	

The power limiting enforcement is effective during transmission when SAR and PD exposures are switched, and the total normalized time-averaged RF exposure does not exceed 1.0. Therefore, the Smart Transmit time averaging feature is validated.

9.2.5. Change in Beam Test Results for n261

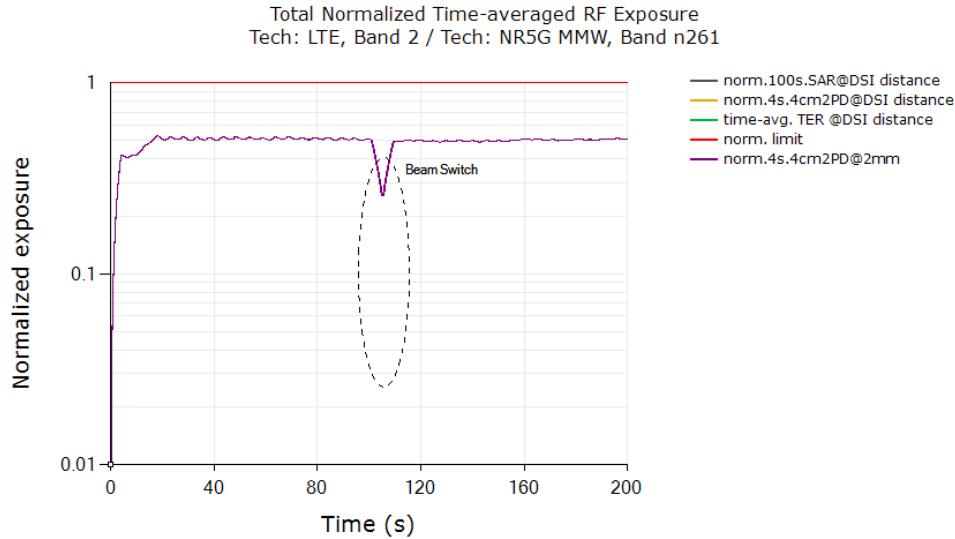

FCC requirement for total RF exposure (normalized)	1.0
Max total normalized time-averaged RF exposure 1-g SAR (green curve)	0.526
Validated	

Additionally, during the switch, the ratio between the averaged radiated powers of the two beams (dotted black circle) should correspond to the difference in EIRPs measured at each corresponding P_{limit} for these beams listed in Table 9-1.

9.2.6. Change in Beam Test Results for n260

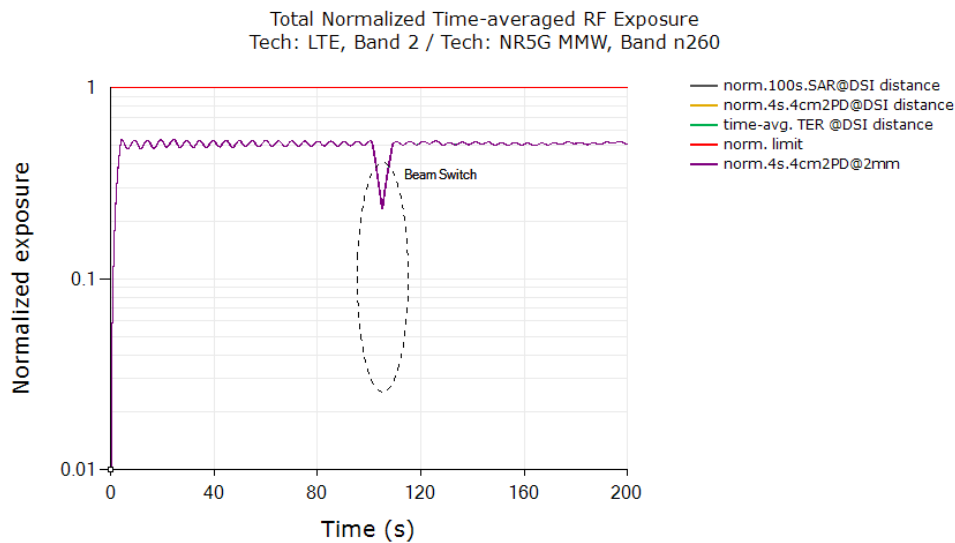

FCC requirement for total RF exposure (normalized)	1.0
Max total normalized time-averaged RF exposure 1-g SAR (green curve)	0.535
Validated	

Additionally, during the switch, the ratio between the averaged radiated powers of the two beams (dotted black circle) should correspond to the difference in EIRPs measured at each corresponding P_{limit} for these beams listed in Table 9-1.

10. PD Test Results for mmW Smart Transmit Feature Validation

10.1. Measurement Setup

The measurement setup is like normal PD measurements where the EUT is positioned on the cDASY6 platform and is connected with the callbox (conducted for Sub-6 GHz and wirelessly for mmW). The Keysight UXM callbox is set to request maximum mmW transmission power from the EUT all the time. Hence, “path loss” calibration between callbox antenna and EUT is not needed in this test. The callbox’s Sub-6 GHz port is directly connected to the EUT’s RF port via a directional coupler to measure the EUT’s conducted transmission power using a Rohde & Schwarz NR8S power sensor and NRP2 power meter. Additionally, EUT is connected to the PC via USB connection for toggling between FTM and online modes with Smart Transmit enabled following the test procedures described §5.4.

Worst-surface of the EUT (for the mmW beam being tested) is positioned facing up for PD measurement with cDASY6 mmW probe as shown in Figure 10-1 (see Appendix E for missing figures). Figure 10-2 shows the schematic of this measurement setup.

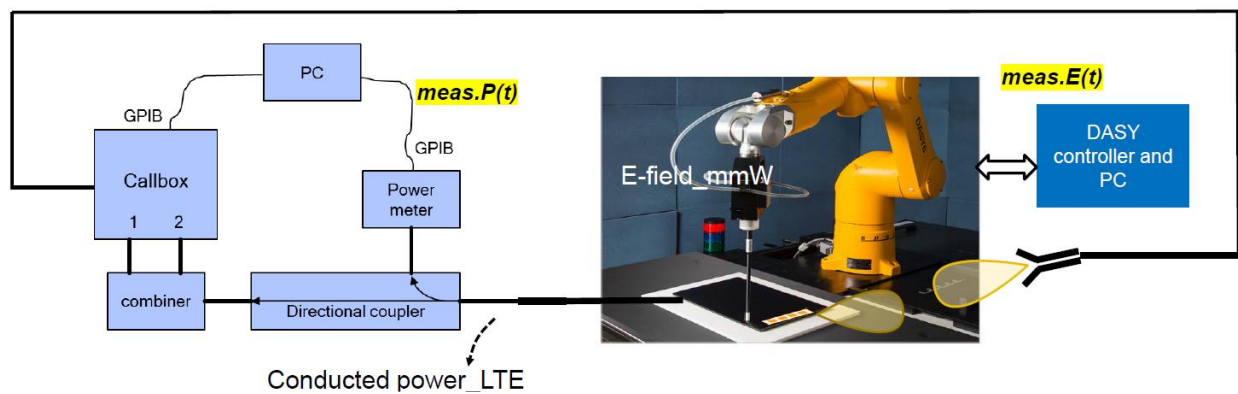

Figure 10-1: PD measurement setup

Both the callbox and the power meters are connected to the PC using USB cables. Test scripts are custom made for automation of establishing Sub-6 GHz + mmW call and for conducted transmission power recording of Sub-6 GHz transmission. These tests are manually stopped after the desired time duration. Once the mmW link is established, Sub-6 GHz transmission power is programmed to toggle between all-up and all-down bits on the callbox. For all the tests, the callbox is set to request maximum transmission power in mmW NR radio from the EUT all the time. Therefore, the calibration for the “path loss” between the EUT and the horn antenna connected to the remote radio head of the callbox is not required.

Power meter readings are periodically recorded every 10 milliseconds on the NR8S power sensor for Sub-6 GHz conducted transmission power. Time-averaged E-field measurements are performed using EUmmWV2 mmW probe at peak location of the fast area scan. The distance between EUmmWV2 mmW probe tip to the EUT’s surface is ~0.5 mm and the distance between EUmmWV2 mmW probe sensor to probe tip is 1.5 millimeters. cDASY6 records relative point E-field (i.e., ratio $\frac{[pointE(t)]^2}{[pointE_Plimit]^2}$) versus time for mmW NR transmission.

10.2. PD Measurement Results for Maximum Power Transmission Scenario

The following configurations were measured by following the detailed test procedure as described in §5.4:

1. LTE Band 2 (DSI state 0) and mmW Band n261 Beam ID 50
2. LTE Band 2 (DSI state 0) and mmW Band n260 Beam ID 50

The measured conducted Tx power of LTE and ratio of $\frac{[pointE(t)]^2}{[pointE_Plimit]^2}$ of mmW is converted into 1-g SAR and 4 cm² PD value, respectively, using Eq. (4a) and (4b), rewritten below:

$$1g \text{ or } 10g \text{ SAR}(t) = \frac{\text{conducted Tx power}(t)}{\text{conducted Tx power } P_{limit}} * 1g \text{ or } 10g \text{ SAR } P_{limit} \text{ (4a)}$$

$$4 \text{ cm}^2 \text{ PD}(t) = \frac{[pointE(t)]^2}{[pointE_Plimit]^2} * 4 \text{ cm}^2 \text{ PD } P_{limit} \text{ (4b)}$$

$$\frac{\frac{1}{T_{SAR}} \int_{t-T_{SAR}}^t 1g \text{ or } 10g \text{ SAR}(t) dt}{FCC \text{ SAR limit}} + \frac{\frac{1}{T_{PD}} \int_{t-T_{PD}}^t 4 \text{ cm}^2 \text{ PD}(t) dt}{FCC 4 \text{ cm}^2 \text{ PD limit}} \leq 1 \text{ (4c)}$$

where, *conducted Tx power(t)*, *conducted Tx power P_{limit}*, and *1-g or 10-g SAR P_{limit}* correspond to the measured instantaneous conducted transmission power, measured conducted transmission power at *P_{limit}*, and measured 1-g SAR or 10-g SAR values at *P_{limit}* corresponding to Sub-6 GHz transmission. Similarly, *pointE(t)*, *pointE P_{limit}*, and *4 cm² PD P_{limit}* correspond to the measured instantaneous E-field, E-field at *P_{limit}*, and 4 cm² PD value at *P_{limit}* corresponding to mmW transmission.²⁵

The radio configurations tested are described in Table 6-3 and 6-4. The 1-g SAR at *P_{limit}* for Sub-6 GHz and the measured 4 cm² PD at *P_{limit}* of mmW bands and Beam IDs are all listed in Table 9-1.

10.2.1. PD Test Results for n261

Step 2.e plot (in §5.4) for normalized instantaneous and time-averaged exposures for Sub-6 GHz and mmW n261 beam 50:

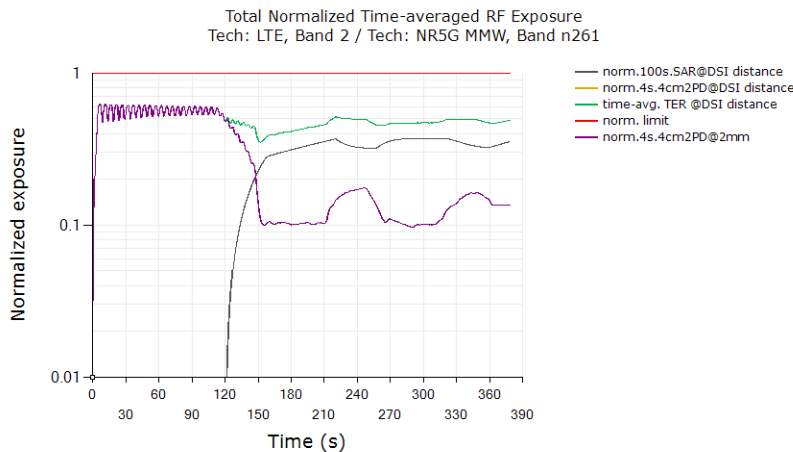

FCC limit for total RF exposure (normalized)	1.0
Max total normalized time-averaged RF exposure 1-g SAR (green curve)	0.624
Validated	

The power limiting enforcement is effective and the total normalized time-averaged RF exposure does not exceed 1.0. Therefore, the Smart Transmit time averaging feature is validated.

²⁵ cDASY6 system measures relative E-field and provides ratio of $\frac{[pointE(t)]^2}{[pointE_Plimit]^2}$ versus time.

10.2.2. PD Test Results for n260

Step 2.e plot (in §5.4) for normalized instantaneous and time-averaged exposures for Sub-6 GHz and mmW n260 beam 50:

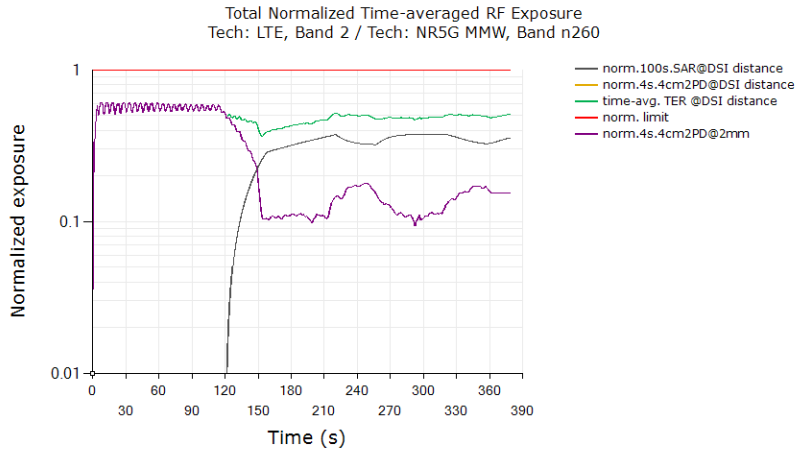

FCC limit for total RF exposure (normalized)	1.0
Max total normalized time-averaged RF exposure 1-g SAR (green curve)	0.612
Validated	

The power limiting enforcement is effective and the total normalized time-averaged RF exposure does not exceed 1.0. Therefore, the Smart Transmit time averaging feature is validated.

11. Conclusions

Qualcomm Smart Transmit feature employed herein has been validated through the conducted/radiated power measurement (as demonstrated in §7 and §9), as well as SAR and PD measurement (as demonstrated in §8 and §10).

As demonstrated in this report, the power limiting enforcement is effective and the total normalized time-averaged RF exposure does not exceed 1.0 for all the transmission scenarios as described in §3. Therefore, the EUT complies with FCC RF exposure requirements.

Appendices

A Test Sequences

1. Test sequence is generated based on the following parameters of the EUT:
 - a. Measured maximum power (P_{max})
 - b. Measured transmission power at SAR_{Design Target} (P_{limit})
 - c. Reserve_power_margin (dB)
 - i. $P_{reserve}$ (dBm) = measured P_{limit} (dBm) - Reserve_power_margin (dB)
 - d. SAR time window (100 seconds for FCC)
2. Test Sequence 1 Waveform: Based on the parameters above, Test Sequence 1 is generated with one transition between high and low transmission powers. Here, high power = P_{max} ; low power = $P_{max}/2$, and the transition occurs after 80 seconds at high power (P_{max}). If the power enforcement is taking into effective during one 100 seconds/60 seconds time window, the validation test with this defined Test Sequence 1 is valid; otherwise, select other radio configurations (band/DSI within the same technology group) having lower P_{limit} for this test. The Test Sequence 1 waveform is shown below:

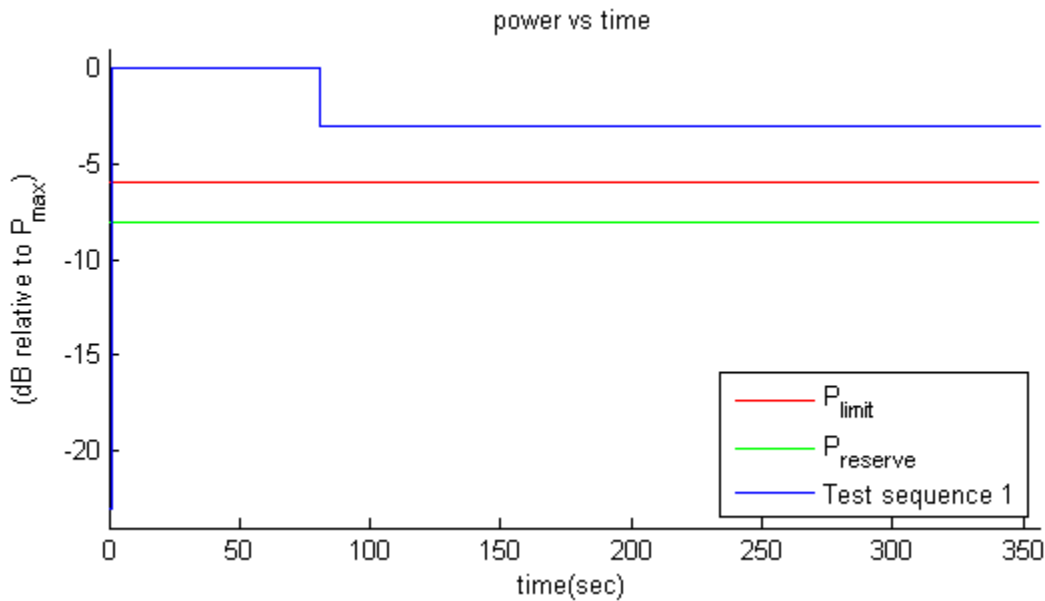

Figure A-1: Test Sequence 1 waveform

3. Test Sequence 2 Waveform: Based on the parameters in A-1, the Test Sequence 2 is generated as described in Table A-1 and pictured in Figure A-2, which contains two 170 seconds-long sequences (yellow and green highlighted rows) that are mirrored around the center row of 20 seconds, resulting in a total duration of 360 seconds:

Table A-1: Test Sequence 2

Time duration (seconds)	dB relative to P_{limit} or $P_{reserve}$
15	$P_{reserve} - 2$
20	P_{limit}
20	$(P_{limit} + P_{max})/2$ averaged in mW and rounded to nearest 0.1 dB step
10	$P_{reserve} - 6$
20	P_{max}
15	P_{limit}
15	$P_{reserve} - 5$
20	P_{max}
10	$P_{reserve} - 3$
15	P_{limit}
10	$P_{reserve} - 4$
20	$(P_{limit} + P_{max})/2$ averaged in mW and rounded to nearest 0.1 dB step
10	$P_{reserve} - 4$
15	P_{limit}
10	$P_{reserve} - 3$
20	P_{max}
15	$P_{reserve} - 5$
15	P_{limit}
20	P_{max}
10	$P_{reserve} - 6$
20	$(P_{limit} + P_{max})/2$ averaged in mW and rounded to nearest 0.1 dB step
20	P_{limit}
15	$P_{reserve} - 2$

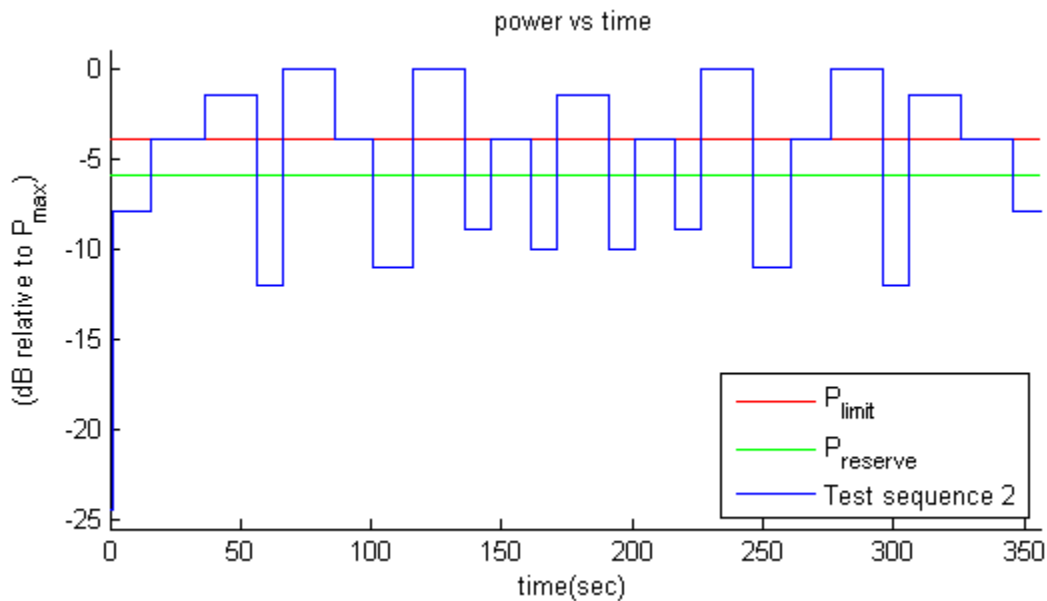

Figure A-2: Test Sequence 2 waveform

B Test Procedures for Sub-6 GHz NR + Sub-6 GHz Radio

Appendix B provides the test procedures for validating the Smart Transmit feature for Sub-6 GHz + Sub-6 GHz NR non-standalone (NSA) mode transmission scenario, where Sub-6 GHz link acts as an anchor.

B.1 Time-varying Transmission Power Test for Sub-6 GHz NR in NSA Mode

Following §4.2.1 to select the test configurations for time-varying tests, these tests are performed with two pre-defined test sequences (as described in §4.1) and applied to Sub-6 GHz NR (with Sub-6 GHz on all-down bits or low power for the entire test after establishing the Sub-6 GHz + Sub-6 GHz NR call with the callbox). Follow the test procedures described in §4.3.1 to demonstrate the effectiveness of power limiting enforcement and that the time averaged transmission power of Sub-6 GHz NR when converted into 1-g SAR values do not exceed the regulatory limit (see Eq. (1a) and (1b)). Sub-6 GHz NR response to Test Sequence 1 and Test Sequence 2 will be similar to other technologies (say, LTE), and are shown in §7.3.7 and §7.3.8.

B.2 Switch in SAR Exposure Between Sub-6 GHz vs. Sub-6 GHz NR during Transmission

This test is to demonstrate that the Smart Transmit feature accurately accounts for switching in exposures among SAR for Sub-6 GHz radio only, SAR from both Sub-6 GHz radio and Sub-6 GHz NR, and SAR from Sub-6 GHz NR only scenarios, and ensures total time-averaged RF exposure compliance with FCC limit.

Test Procedure:

1. Measure the conducted transmission power corresponding to P_{limit} for Sub-6 GHz and Sub-6 GHz NR in selected bands. Test conditions to measure conducted P_{limit} are:
 - a. Establish the device in a call with the callbox for Sub-6 GHz in a desired band. Measure the conducted transmission power corresponding to Sub-6 GHz P_{limit} with Smart Transmit enabled and *Reserve_power_margin* set to 0 dB, and the callbox set to request maximum power.
 - b. Repeat Step 1a to measure the conducted transmission power corresponding to Sub-6 GHz NR P_{limit} . If testing Sub-6 GHz + Sub-6 GHz NR in non-standalone mode (NSA), then establish a Sub-6 GHz + Sub-6 GHz NR call with the callbox and request all down bits for radio1 Sub-6 GHz. In this scenario, with the callbox requesting maximum power from the Sub-6 GHz NR radio, measure the conducted transmission power corresponding to radio2 P_{limit} (as radio1 Sub-6 GHz is at all-down bits).
2. Set *Reserve_power_margin* to actual (intended) value with the EUT setup for Sub-6 GHz + Sub-6 GHz NR call. First, establish a Sub-6 GHz connection in all-up bits with the callbox and then a Sub-6 GHz NR connection is added with the callbox requesting the EUT to transmit at maximum power in Sub-6 GHz NR. When the Sub-6 GHz NR connection is established, request all-down bits on the Sub-6 GHz link (otherwise, Sub-6 GHz NR will not have sufficient RF exposure margin to sustain the call with Sub-6 GHz in all-up bits). Continue the Sub-6 GHz (all-down bits) + Sub-6 GHz NR transmission for more than one time-window duration to test, predominantly, the Sub-6 GHz NR SAR exposure scenario (as SAR exposure is negligible from all-down bits in Sub-6 GHz). After at least one time-window, request Sub-6 GHz to go all-up bits to test Sub-6 GHz SAR and Sub-6 GHz NR SAR exposure scenario. After at least one more time-window, drop (or request all-down bits) Sub-6 GHz NR transmission to test predominantly the Sub-6 GHz SAR exposure scenario. Continue the test for at least one more time-window. Record the conducted transmission powers for both Sub-6 GHz and Sub-6 GHz NR for the entire duration of this test.
3. Once the measurement is done, extract the instantaneous transmission power versus time for both Sub-6 GHz and Sub-6 GHz NR links. Like the technology/band switch test in §4.3.3, convert the conducted transmission power for both these radios into 1-g SAR value (see Eq. (7a) and (7b)) using corresponding technology/band P_{limit} measured in Step 1 and then perform 100 seconds running average to determine time-averaged 1-g SAR versus time as illustrated in Figure 4-1.²⁶
4. Make one plot containing: (a) Instantaneous transmission power versus time measured in Step 2.
5. Make another plot containing: (a) Instantaneous 1-g SAR versus time determined in Step 3, (b) computed time-averaged 1-g SAR versus time determined in Step 3, and (c) corresponding regulatory 1-g SAR_{limit} of 1.6/4.0 W/kg.

²⁶ It is assumed both radios have transmission frequencies < 3 GHz; otherwise, 60 seconds running average should be performed for radios having transmission frequencies between 3 GHz and 6 GHz.

The validation criterion is the time-averaged 1-g SAR versus time shall not exceed the regulatory 1-g SAR_{limit} of 1.6/4.0 W/kg.

C cDASY6 System Validation

C.1 SAR System Verification and Validation

Table C-1 provides the list of calibrated equipment for SAR measurement system verification.

Table C-1: List of calibrated equipment

Dielectric Property Measurements

Name of Equipment	Manufacturer	Type/Model	Serial No.	Cal. Due Date
Vector Network Analyzer	ROHDE & SCHWARZ	ZNLE6	101274-mn	2/28/2025
Dielectric Probe kit	SPEAG	DAK-3.5	1087	11/1/2024
Shorting Block	SPEAG	DAK-1.2/3.5 Short	SMDAK 200 DA	11/1/2024
Thermometer	Fisher Scientific	Traceable	122529162	1/31/2025
E-Field Probe (SAR Lab 16)	SPEAG	EX3DV4	3929	3/14/2025
Data Acquisition Electronics (SAR Lab 16)	SPEAG	DAE4	1673	5/13/2025
System Validation Dipole	SPEAG	D1750V2	1053	10/13/2024
System Validation Dipole**	SPEAG	D1900V2	5d140	4/14/2025
System Validation Dipole**	SPEAG	D3500V2	1060	2/7/2025
Signal Generator	R&S	SMB 100A	180969-yC	2/21/2025
Power Meter	Keysight	N1912A	MY55196008	1/31/2025
Power Sensor	Agilent	N1912A	MY53260001	1/31/2025
Power Sensor	Agilent	N1912A	MY52200012	1/31/2025
Bi-directional coupler	Mini-Circuits	ZUDC10-183+	1722	N/A

Note(s):

**Dipole Calibration Date has been extended past 1 year. Impedance measurements have been performed to validate Dipole performance.

The system verification was performed using a dipole antenna against the flat section of the SAM phantom. Table C-2 shows the verification test results and the relevant plots are provided in Appendix C. The measured SAR values for the frequency bands of interest were within $\pm 10\%$ of the corresponding target SAR levels.

Table C-2: System verification results

System Check											
Date	Dipole Type & Serial Number	Dipole Cal. Due Date	Input Power (dBm)	Measured results for 1-g SAR				Measured results for 10-g SAR			
				Meas. Zoom Scan	Normalize to 1 W	Target (Ref. Value)	Delta ±10%	Meas. Zoom Scan	Normalize to 1 W	Target (Ref. Value)	Delta ±10%
6/14/2024	D1750V2 SN: 1053	10/13/2024	20.0	3.480	34.800	36.600	-4.92%	1.840	18.400	19.300	-4.66%
6/14/2024	D1750V2 SN: 1053	10/13/2024	20.0	3.900	39.000	36.600	6.56%	2.010	20.100	19.300	4.15%
6/17/2024	D1750V2 SN: 1053	10/13/2024	20.0	3.580	35.800	36.600	-2.19%	1.900	19.000	19.300	-1.55%
6/17/2024	D1900V2 SN: 5d140	4/14/2025	20.0	4.070	40.700	39.400	3.30%	2.110	21.100	20.600	2.43%
6/21/2024	D1750V2 SN: 1053	10/13/2024	20.0	3.670	36.700	36.600	0.27%	1.940	19.400	19.300	0.52%
6/21/2024	D1900V2 SN: 5d140	4/14/2025	20.0	4.140	41.400	39.400	5.08%	2.130	21.300	20.600	3.40%
6/25/2024	D1750V2 SN: 1053	10/13/2024	20.0	3.540	35.400	36.600	-3.28%	1.880	18.800	19.300	-2.59%
6/25/2024	D1900V2 SN: 5d140	4/14/2025	20.0	3.970	39.700	39.400	0.76%	2.050	20.500	20.600	-0.49%
7/2/2024	D1750V2 SN: 1053	10/13/2024	20.0	3.780	37.800	36.600	3.28%	2.000	20.000	19.300	3.63%
7/2/2024	D3500V2 SN: 1060	2/7/2025	20.0	6.170	61.700	65.700	-6.09%	2.380	23.800	24.900	-4.42%
7/6/2024	D3500V2 SN: 1060	2/7/2025	20.0	6.070	60.700	65.700	-7.61%	2.340	23.400	24.900	-6.02%

The broad-band solution MBL600-6000V6 is used for body tissue-simulating liquid. Similarly, broad-band solution HBBL600-10000V6 was used for head tissue-simulating liquid. Table C-3 list the tissue dielectric properties.²⁷

Table C-3: Tissue dielectric properties at the time of testing

Liquid Check										
SAR Lab	Date	Tissue Type	Band (MHz)	Freq. (MHz)	Relative Permittivity (ϵ_r)			Conductivity (σ)		
					Measured	Target	Delta	Measured	Target	Delta
SAR 16	6/14/2024	Head	1750	1750	39.69	40.08	-0.98%	1.35	1.37	-1.46%
				1695	39.74	40.17	-1.07%	1.32	1.34	-1.42%
				1755	39.68	40.08	-0.99%	1.35	1.37	-1.44%
SAR 16	6/14/2024	Head	1900	1900	39.45	40.00	-1.37%	1.43	1.40	2.29%
				1850	39.52	40.00	-1.20%	1.41	1.40	0.50%
				1920	39.41	40.00	-1.48%	1.45	1.40	3.21%
SAR 16	6/17/2024	Head	1750	1750	39.88	40.08	-0.51%	1.33	1.37	-3.14%
				1695	40.00	40.17	-0.42%	1.29	1.34	-3.43%
				1755	39.87	40.08	-0.52%	1.33	1.37	-3.12%
SAR 16	6/17/2024	Head	1900	1900	39.67	40.00	-0.82%	1.41	1.40	0.57%
				1850	39.73	40.00	-0.68%	1.38	1.40	-1.71%
				1920	39.64	40.00	-0.90%	1.42	1.40	1.43%
SAR 16	6/21/2024	Head	1750	1750	38.58	40.08	-3.75%	1.38	1.37	0.73%
				1695	38.66	40.17	-3.76%	1.35	1.34	1.05%
				1755	38.58	40.08	-3.74%	1.38	1.37	0.74%
SAR 16	6/21/2024	Head	1900	1900	38.34	40.00	-4.15%	1.47	1.40	5.14%
				1850	38.46	40.00	-3.85%	1.44	1.40	3.07%
				1920	38.30	40.00	-4.25%	1.48	1.40	6.00%
SAR 16	6/25/2024	Head	1750	1750	38.66	40.08	-3.55%	1.34	1.37	-1.82%
				1695	38.75	40.17	-3.53%	1.31	1.34	-1.94%
				1755	38.65	40.08	-3.56%	1.35	1.37	-1.73%
SAR 16	6/25/2024	Head	1900	1900	38.38	40.00	-4.05%	1.43	1.40	2.00%
				1850	38.47	40.00	-3.83%	1.40	1.40	0.14%
				1920	38.34	40.00	-4.15%	1.44	1.40	2.79%

²⁷ The deviation should be controlled within $\pm 5\%$. If the deviation is between $\pm 5\%$ to $\pm 10\%$, the correction will be made in the corresponding SAR result to compensate the additional deviation.

Liquid Check										
SAR Lab	Date	Tissue Type	Band (MHz)	Freq. (MHz)	Relative Permittivity (ϵ_r)			Conductivity (σ)		
					Measured	Target	Delta	Measured	Target	Delta
SAR 16	7/2/2024	Head	1750	1750	37.41	40.08	-6.67%	1.40	1.37	2.05%
				1695	37.51	40.17	-6.62%	1.37	1.34	2.55%
				1780	37.40	40.04	-6.59%	1.40	1.39	1.02%
SAR 16	7/2/2024	Head	3500	3500	38.15	37.93	0.58%	2.76	2.91	-5.21%
				3400	38.33	38.04	0.75%	2.68	2.81	-4.74%
				3700	37.83	37.70	0.34%	2.94	3.12	-5.65%
SAR 16	7/6/2024	Head	3500	3500	36.74	37.93	-3.14%	2.74	2.91	-5.96%
				3400	36.93	38.04	-2.93%	2.65	2.81	-5.56%
				3700	36.40	37.70	-3.45%	2.92	3.12	-6.30%

Appendix D provides the calibration certificates for SAR measurement equipment used in this report.

C.2 Power Density Measurement System Verification

Table C-4 provides the list of calibrated equipment for power density measurement system verification.

Table C-4: List of calibrated equipment

Name of Equipment	Manufacturer	Type/Model	Serial No.	Cal. Due Date
E-Field Probe (SAR Lab C)	SPEAG	EummmVV4	9589	9/5/2024
Data Acquisition Electronics (SAR Lab C)	SPEAG	DAE4	1621	4/12/2025
5G Verification Source	SPEAG	30 GHz	1117	9/20/2024

C.2.1 Power Density Probe

The novel EUmmWV2 probe is used in the power density measurement. It is designed for precise near-field measurements in the mm-wave range by SPEAG. The specifications are:

- Frequency range: 0.75 ~ 110 GHz
- Dynamic range: <50 – 3000 V/m (up to 10000 V/m with additional PRE-10 voltage divider)
- Linearity: < ± 0.2 dB
- Supports sensor model calibration (SMC)
- ISO17025 accredited calibration

C.2.2 Power Density System Verification

The power density system verification is performed using the SPEAG verification device. It consists of a ka-band horn antenna with a corresponding gun oscillator packaged within a cube-shaped housing.

The specifications of the verification device are:

- Calibrated frequency: 30 GHz at 10 mm from the case surface
- Frequency accuracy: ± 100 MHz
- E-field polarization: linear
- Harmonics: -20 dBc (typ)
- Total radiated power: 14 dBm (typ)
- Power stability: 0.05 dB
- Power consumption: 5 W (max)
- Size: 100 x 100 x 100 mm
- Weight: 1 kg

Table C-5 shows the verification test results. The measured power density (PD) value is within 0.2 dB of target level.²⁸

Table C-5: System validation results

SAR Lab	Test Date	SG Probe SN	Probe Cal. Due Date	DME SN	DME Cal. Due Date	Frequency (GHz)	SG Verification Source SN	Source Cal. Due Date	Averaging Type	Measured psPDn (W/m ²) over 4cm ²	Target psPDn (W/m ²) over 4cm ²	Deviation (dB)	Delta	Measured psPDtot (W/m ²) over 4cm ²	Target psPDtot (W/m ²) over 4cm ²	Deviation (dB)	Delta	Measured psPDmod (W/m ²) over 4cm ²	Target psPDmod (W/m ²) over 4cm ²	Deviation (dB)	Delta	Measured psPDmod (W/m ²) over 4cm ²	Target psPDmod (W/m ²) over 4cm ²	Deviation (dB)	Delta				
C	5/29/2024	9589	9/20/2024	1621	4/12/2025	30	1117	9/20/2024	Square	86.4	92.5	-0.10	-2%	86.1	92.5	-0.07	-2%	85.9	92.1	-0.18	-4%	79.9	85.1	-0.11	-2%	79.9	85.1	-0.06	-1%
C	5/29/2024	9589	9/20/2024	1621	4/12/2025	30	1117	9/20/2024	Square	85.9	92.5	-0.12	-2%	85.8	92.5	-0.08	-2%	85.6	92.1	-0.20	-4%	77.7	85.1	-0.13	-2%	78.7	85.1	-0.08	-2%
C	5/29/2024	9589	9/20/2024	1621	4/12/2025	30	1117	9/20/2024	Square	90.1	92.5	-0.11	-2%	89.9	92.5	-0.08	-2%	89.7	92.1	-0.22	-5%	77.3	85.1	-0.15	-2%	78.3	85.1	-0.10	-2%
C	5/29/2024	9589	9/20/2024	1621	4/12/2025	30	1117	9/20/2024	Square	85.6	92.5	-0.13	-2%	85.6	92.5	-0.09	-2%	81.4	92.5	-0.09	-1%	76.0	85.1	-0.23	-5%	77.1	85.1	-0.17	-4%
C	5/29/2024	9589	9/20/2024	1621	4/12/2025	30	1117	9/20/2024	Square	90.3	92.5	-0.16	-2%	90.3	92.5	-0.07	-2%	91.9	92.5	-0.08	-1%	77.6	85.1	-0.16	-2%	78.8	85.1	-0.08	-1%
C	5/29/2024	9589	9/20/2024	1621	4/12/2025	30	1117	9/20/2024	Square	92.0	92.5	-0.12	-2%	92.8	92.5	-0.08	-2%	93.5	92.5	-0.02	-1%	79.2	85.1	-0.22	-5%	77.3	85.1	-0.15	-2%
C	5/29/2024	9589	9/20/2024	1621	4/12/2025	30	1117	9/20/2024	Square	85.3	92.5	-0.15	-2%	85.1	92.5	-0.11	-2%	80.7	92.5	-0.09	-2%	75.5	85.1	-0.26	-4%	76.7	85.1	-0.19	-4%
C	5/29/2024	9589	9/20/2024	1621	4/12/2025	30	1117	9/20/2024	Square	85.8	92.5	-0.15	-2%	86.7	92.5	-0.09	-2%	81.4	92.5	-0.05	-1%	75.4	85.1	-0.26	-4%	76.7	85.1	-0.19	-4%
C	5/29/2024	9589	9/20/2024	1621	4/12/2025	30	1117	9/20/2024	Square	85.3	92.5	-0.04	1%	84.1	92.5	-0.07	2%	84.9	92.5	-0.11	2%	79.0	85.1	-0.08	-1%	80.4	85.1	-0.02	0%
C	5/29/2024	9589	9/20/2024	1621	4/12/2025	30	1117	9/20/2024	Square	91.1	92.5	-0.07	-2%	91.9	92.5	-0.03	-1%	92.8	92.5	-0.06	-2%	77.9	85.1	-0.19	-2%	79.1	85.1	-0.08	-1%
C	5/29/2024	9589	9/20/2024	1621	4/12/2025	30	1117	9/20/2024	Average	86.4	92.5	-0.10	-2%	85.2	92.5	-0.06	-1%	82.8	92.5	-0.02	-1%	78.7	85.1	-0.19	-4%	77.9	85.1	-0.12	-2%

Table C-6: System verification results

SAR Lab	Date	Frequency (GHz)	5G Verification Source SN	Source Cal. Due Date	Measured psPDn (W/m ²) over 4cm ²	Target psPDn (W/m ²) over 4cm ²	Deviation (dB)	Delta ±16 %	Measured psPDtot (W/m ²) over 4cm ²	Target psPDtot (W/m ²) over 4cm ²	Deviation (dB)	Delta ±16 %	Measured psPDmod (W/m ²) over 4cm ²	Target psPDmod (W/m ²) over 4cm ²	Deviation (dB)	Delta ±16 %
C	7/8/2024	30	1117	9/20/2024	81.5	76.7	0.26	6%	83.3	77.9	0.29	7%	83.6	78.9	0.25	6%

²⁸ The uncertainty of 5G verification source is 1.28 dB (k=2).

D SPEAG Certificates of cDASY6 SAR Probe, DAE, Dipole, mmW Probe and mmW Verification Source

E Test Setup Photos

End of Report