

TEST REPORT

Report Number : 14982436-E24V3

Applicant : APPLE INC.
1 APPLE PARK WAY
CUPERTINO, CA 95104, U.S.A.

Model : A3083 (Parent Model)
A3292, A3293 (Variant Models)

Brand : APPLE

FCC ID : BCG-E8666A (Parent Model)
BCG-E8667A, BCG-E8668A (Variant Models)

IC : 579C-E8666A (Parent Model)
579C-E8667A, 579C-E8668A (Variant Models)

EUT Description : SMARTPHONE

Test Standard(s) : FCC CFR47 PART 25
ISED RSS-170 ISSUE 4

Date Of Issue:
2024/08/08

Prepared by:
UL VEIFICATION SERVICES INC.
47173 Benicia Street
Fremont, CA 94538, U.S.A.
TEL: (510) 319-4000
FAX: (510) 661-0888



REPORT REVISION HISTORY

Rev.	Issue Date	Revisions	Revised By
V1	2024/06/07	Initial Issue	---
V2	2024/08/01	The rule sections have been updated to reflect the new issue 4 of ISED standard	---
V3	2024/08/08	Addressed TCB Questions	Chris Xiong

TABLE OF CONTENTS

- 1. ATTESTATION OF TEST RESULTS 5**
- 3. TEST METHODOLOGY 6**
- 4. FACILITIES AND ACCREDITATION 7**
- 5. DECISION RULES AND MEASUREMENT UNCERTAINTY 7**
 - 5.1. METROLOGICAL TRACEABILITY 7
 - 5.2. DECISION RULES 7
 - 5.3. MEASUREMENT UNCERTAINTY 8
 - 5.4. SAMPLE CALCULATION 8
- 6. EQUIPMENT UNDER TEST 9**
 - 6.1. DESCRIPTION OF EUT 9
 - 6.2. MAXIMUM OUTPUT POWER 9
 - 6.3. SOFTWARE AND FIRMWARE 10
 - 6.4. MAXIMUM ANTENNA GAIN 10
 - 6.5. WORST-CASE CONFIGURATION AND MODE 10
 - 6.6. DESCRIPTION OF TEST SETUP 11
- 7. TEST AND MEASUREMENT EQUIPMENT 14**
- 8. RF OUTPUT POWER MEASUREMENT 15**
- 9. CONDUCTED TEST RESULTS 16**
 - 9.1. OCCUPIED BANDWIDTH 16
 - 9.1.1. ANT 1 17
 - 9.1.2. ANT 4 18
 - 9.2. EMISSIONS MASK WITHIN 250% OF AUTHORIZED BANDWIDTH 19
 - 9.2.1. ANT 1 20
 - 9.2.2. ANT 4 23
 - 9.3. OUT OF BAND EMISSIONS 26
 - 9.3.1. ANT 1 27
 - 9.3.2. ANT 4 28
- 10. RADIATED TEST RESULTS 29**
 - 10.1. FIELD STRENGTH OF SPURIOUS RADIATION 30
 - 10.1.1. ANT 1 (Above 1 GHz) 31
 - 10.1.2. ANT 4 (Above 1 GHz) 33
 - 10.1.3. ANT 1 (Below 1GHz) 35
 - 10.1.4. ANT 4 (Below 1GHz) 37
 - 10.2. ADDITIONAL UNWANTED EMISSION (1559MHz – 1610MHz) 39
 - 10.2.1. ANT 1 41
 - 10.2.2. ANT 4 45

10.3. CARRIER-OFF STATE EMISSIONS (1559 MHz – 1610 MHz) 49
10.3.1. ANT 1..... 50
10.3.2. ANT 4..... 50
10.4. FREQUENCY STABILITY..... 51
11. SETUP PHOTOS..... 52



1. ATTESTATION OF TEST RESULTS

Applicant Name and Address	APPLE INC. 1 APPLE PARK WAY CUPERTINO, CA 95104, U.S.A.
Model	A3083 (Parent Model) A3292, A3293 (Variant Models)
Brand	APPLE
FCC ID	BCG-E8666A (Parent Model) BCG-E8667A, BCG-E8668A (Variant Models)
IC	579C-E8666A (Parent Model) 579C-E8667A, 579C-E8668A (Variant Models)
EUT Description	SMARTPHONE
Serial Number	Y9L65H9LXJ (Conducted), L73Q9RQC46/QM2WVQQ45T (Radiated)
Sample Receipt Date	2023/11/09 (Conducted), 2024/05/29 (Radiated)
Date Tested	2023/11/17 to 2024/08/08
Applicable Standards	FCC CFR47 PART 25 ISED RSS-170 ISSUE 4
Test Results	COMPLIES

UL Verification Services Inc. tested the above equipment in accordance with the requirements set forth in the above standards. The test results show that the equipment tested is capable of demonstrating compliance with the requirements as documented in this report.

The results documented in this report apply only to the tested sample, under the conditions and modes of operation as described herein. It is the manufacturer's responsibility to assure that additional production units of this model are manufactured with identical electrical and mechanical components. All samples tested were in good operating condition throughout the entire test program. Measurement Uncertainties are published for informational purposes only and were not taken into account unless noted otherwise.

This document may not be altered or revised in any way unless done so by UL Verification Services Inc. and all revisions are duly noted in the revisions section. Any alteration of this document not carried out by UL Verification Services Inc. will constitute fraud and shall nullify the document.

Approved & Released By: 	Prepared & Reviewed By: 
Thu Chan Staff Engineer UL Verification Services, Inc.	Chris Xiong Senior Test Engineer UL Verification Services, Inc.

2. SUMMARY OF TEST RESULTS

This report contains data provided by the customer which can impact the validity of results. UL Verification Services Inc. is only responsible for the validity of results after the integration of the data provided by the customer.

Below is a list of the data provided by the customer:

1. Antenna gain and type (see Section 6.4)
2. Cable loss (see Section 8)

Requirement Description	Requirement Clause Number (FCC)	Requirement Clause Number (ISED)	Result*	Remarks
RF Output Power Verification	25.204 (a)	RSS-170 §5.5	Complies	N/A
Occupied Bandwidth	2.1049	RSS-170 RSS-GEN	Reporting purposes only	N/A
Emissions Mask - within 250% of Authorized Bandwidth	25.202 (f)(1)&(2)	RSS-170 §5.8 (a) (b)	Complies	N/A
Out of Band Emissions	25.202 (f)(3)	RSS-170 §5.8 (c)	Complies	N/A
Additional Unwanted Emission (1559-1610MHz)	25.216 (c)&(g) FCC 03-283	RSS-170 §5.9.1	Complies	N/A
Carrier-Off State Emissions (1559-1610MHz)	25.216 (i) FCC 03-283	RSS-170 §5.10	Complies	N/A
Frequency Stability	25.202 (d)	RSS-170 §5.3	Complies	N/A

3. TEST METHODOLOGY

The tests documented in this report were performed in accordance with the following:

- ANSI C63.26:2015
- ISED RSS-170 ISSUE 4
- FCC 47 CFR Part 2 and 25
- FCC KDB 971168 D01 v03r01: Power Meas License Digital Systems
- FCC KDB 971168 D02 v02r01: Misc Rev Approv License Devices
- FCC KDB 412172 D01 v01r01: Determining ERP and EIRP

4. FACILITIES AND ACCREDITATION

UL Verification Services Inc. is accredited by A2LA, certification #0751.05, for all testing performed within the scope of this report. Testing was performed at the locations noted below.

	Address	ISED CABID	ISED Company Number	FCC Registration
<input checked="" type="checkbox"/>	Building 1: 47173 Benicia Street, Fremont, CA 94538 USA	US0104	2324A	550739
<input checked="" type="checkbox"/>	Building 2: 47266 Benicia Street, Fremont, CA 94538 USA			
<input type="checkbox"/>	Building 3: 843 Auburn Court, Fremont, CA 94538 USA			
<input type="checkbox"/>	Building 4: 47658 Kato Rd, Fremont, CA 94538 USA			
<input type="checkbox"/>	Building 5: 47670 Kato Rd, Fremont, CA 94538 USA			

5. DECISION RULES AND MEASUREMENT UNCERTAINTY

5.1. METROLOGICAL TRACEABILITY

All test and measuring equipment utilized to perform the tests documented in this report are calibrated on a regular basis, with a maximum time between calibrations of one year or the manufacturers' recommendation, whichever is less, and where applicable is traceable to recognized national standards.

5.2. DECISION RULES

The Decision Rule is based on Simple Acceptance in accordance with ISO Guide 98-4:2012 Clause 8.2. (Measurement uncertainty is not taken into account when stating conformity with a specified requirement.)

5.3. MEASUREMENT UNCERTAINTY

Where relevant, the following measurement uncertainty levels have been estimated for tests performed on the apparatus:

PARAMETER	U _{Lab}
Worst Case Conducted Disturbance, 9KHz to 0.15 MHz	3.78 dB
Worst Case Conducted Disturbance, 0.15 to 30 MHz	3.40 dB
Worst Case Radiated Disturbance, 9KHz to 30 MHz	2.87 dB
Worst Case Radiated Disturbance, 30 to 1000 MHz	6.01 dB
Worst Case Radiated Disturbance, 1000 to 18000 MHz	4.73 dB
Worst Case Radiated Disturbance, 18000 to 26000 MHz	4.51 dB
Worst Case Radiated Disturbance, 26000 to 40000 MHz	5.29 dB
Occupied Channel Bandwidth	±1.22 %
Temperature	±0.57 °C
Supply voltages	±0.57 %
Time	±3.39 %

Uncertainty figures are valid to a confidence level of 95%.

5.4. SAMPLE CALCULATION

RADIATED EMISSIONS

Where relevant, the following sample calculation is provided:

Field Strength (dBuV/m)

= Measured Voltage (dBuV) + Antenna Factor (dB/m) + Cable Loss (dB) – Preamp Gain (dB)

= 36.5 dBuV + 18.7 dB/m + 0.6 dB – 26.9 dB = 28.9 dBuV/m

6. EQUIPMENT UNDER TEST

6.1. DESCRIPTION OF EUT

The Apple iPhone is a smartphone with cellular GSM, GPRS, EGPRS, WCDMA, LTE, 5G NR1, 5G NR2, IEEE 802.11a/b/g/n/ac/ax/be, Bluetooth (BT), Ultra-Wideband (UWB), Global Positioning System (GPS), Near-Field Communication (NFC), Narrow-Band (NB) UNII, 802.15.4, 802.15.4ab-Narrow Band (NB), Wireless Power Transfer (WPT) and Mobile Satellite Service (MSS) technologies. The rechargeable battery is not user accessible. This device is not user-serviceable and requires special tools to disassemble.

6.2. MAXIMUM OUTPUT POWER

EIRP/ERP TEST PROCEDURE

ANSI C63.26:2015

KDB 971168 D01 Section 5.6

$$EIRP = P_{Meas} + GT - LC$$

where: EIRP = effective isotropic radiated power, respectively (expressed in the same units as P_{Meas}, typically dBW or dBm);

P_{Meas} = measured transmitter output power or PSD, in dBm or dBW;

GT = gain of the transmitting antenna, in dBi (EIRP);

LC = signal attenuation in the connecting cable between the transmitter and antenna, in dB.

For devices utilizing multiple antennas, KDB 662911 provides guidance for determining the effective array transmit antenna gain term to be used in the above equation.

The transmitter has a maximum average conducted and EIRP output powers as follows:

FCC Part 25 & ISSED RSS-170 (1610 - 1626.5MHz):

Frequency (MHz)	Conducted Average Power (dBm)	Antenna Gain (dBi)	Limit (W)	EIRP		99% BW (kHz)	Emission Designator
				(dBm)	(W)		
1610.17	25.800	-3.4	10000	22.40	0.174	201.24	201KG1D
1618.40	25.782		10000	22.38	0.173	203.96	204KG1D
1626.03	25.744		10000	22.34	0.172	202.02	202KG1D

6.3. SOFTWARE AND FIRMWARE

The EUT firmware installed during testing was FW Version: 0.02.01.

6.4. MAXIMUM ANTENNA GAIN

The antenna(s) gain as provided by the manufacturer are as follow:

Frequency Range (MHz)	Antenna Gain ANT 1 (dBi)	Antenna Gain ANT 4 (dBi)
1610-1626.5	-4.1	-3.4

6.5. WORST-CASE CONFIGURATION AND MODE

The EUT was investigated in three orthogonal orientations: X (Flatbed), Y (Landscape), and Z (Portrait) on both ANT 1 and ANT 4. It was determined that X (Flatbed) orientation was the worst-case orientation with AC/DC adapter for both ANT 1 and ANT 4.

The emissions mask tests were performed based on declared authorized bandwidths of 200kHz, 230kHz and 280kHz.

Radiated spurious emissions below 1GHz were performed with the highest output power on both ANT 1 and ANT 4 as worst-case scenario.

Radiated spurious emissions below 30MHz were investigated and there were no emissions found with less than 20dB of margin below the specified emissions limits.

For simultaneous transmission of multiple channels in the 2.4GHz/5GHz WLAN, tests were conducted for various configurations having the highest power, least separation in frequencies and widest operation bandwidths. No noticeable new emission was found.

NOTE: ANT 1 is disabled and data is for information only.

6.6. DESCRIPTION OF TEST SETUP

SUPPORT TEST EQUIPMENT						
Description	Manufacturer	Model	Serial Number	FCC ID/ DoC		
Laptop	Apple	MacBook Pro	C02TQ0T5HV2L	DoC		
Laptop AC/DC Adapter	Apple	61W Model A1947	C02VR00VJLM5	DoC		
EUT AC/DC Adapter	Apple	A2305	HHY23570SL11PW9A1	DoC		
I/O CABLES (RF CONDUCTED TEST)						
Cable No.	Port	# Of Identical Ports	Connector Type	Cable Type	Cable Length (m)	Remarks
1	AC	3	US 115V	Un-shielded	2.0	N/A
2	USB	1	Type-C	Shielded	2.0	N/A
3	RF In/Out	1	SMA	Shielded	1.0	N/A
4	RF In/Out	1	SMA	Shielded	0.5	N/A
5	RF In/Out	1	SMA Adapter	N/A	N/A	N/A
I/O CABLES (RF RADIATED TEST)						
Cable No.	Port	# Of Identical Ports	Connector Type	Cable Type	Cable Length (m)	Remarks
1	AC	1	Type-C	Un-shielded	1.0	N/A

CONDUCTED SETUP ANT 1

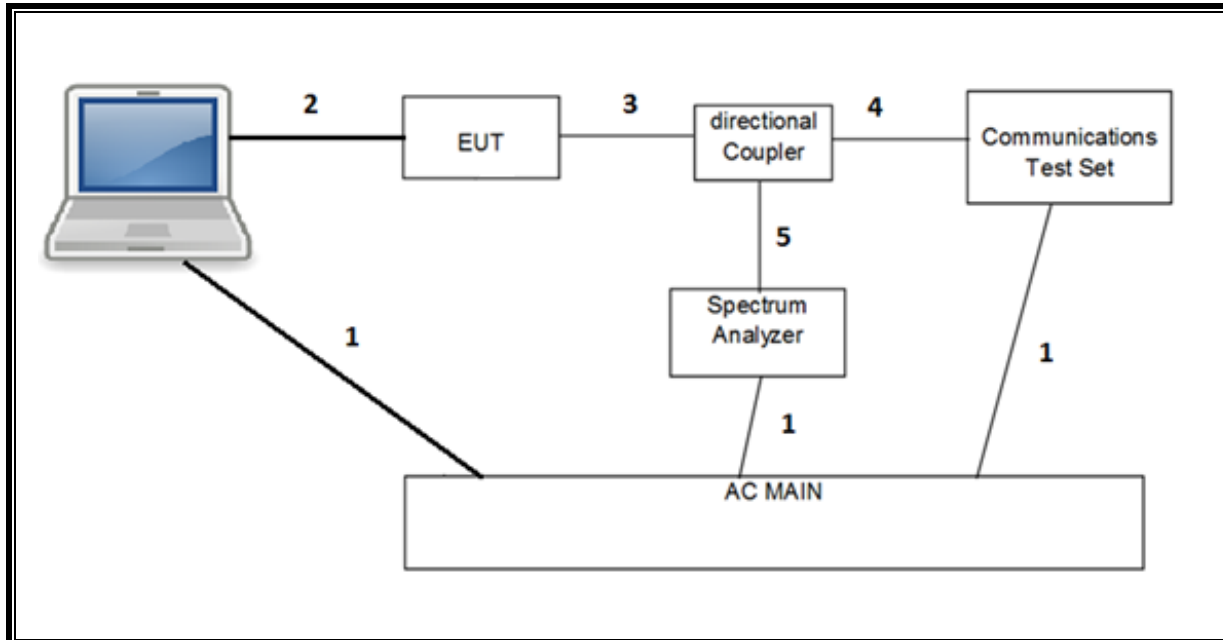

CONDUCTED SETUP ANT 4

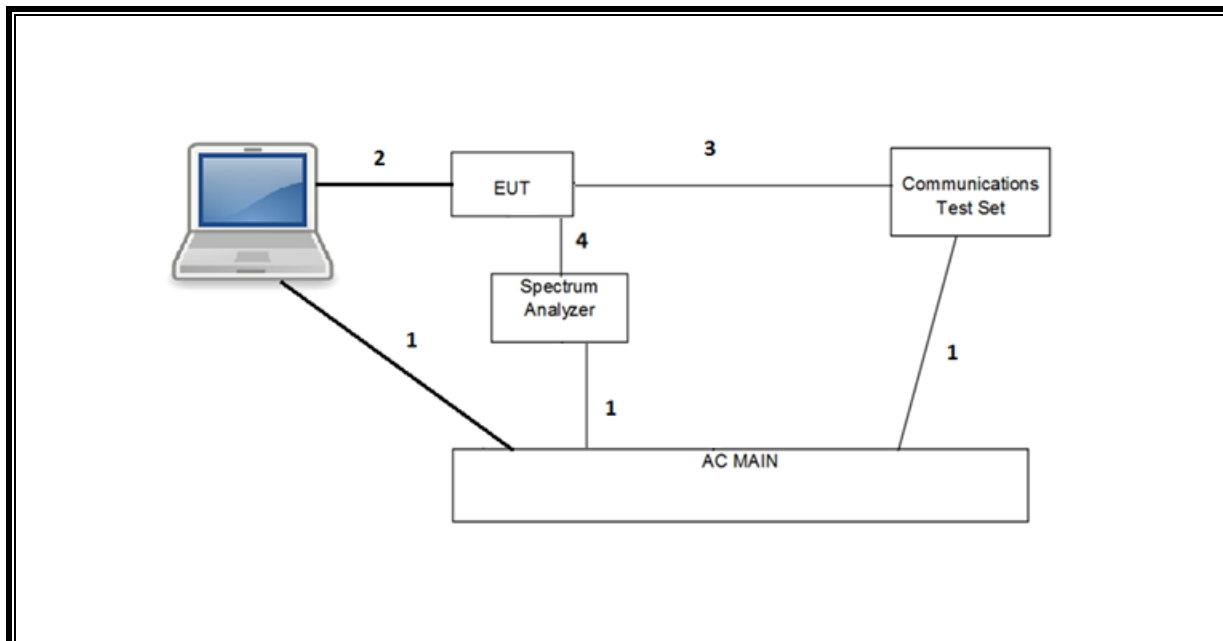

RADIATED SETUP

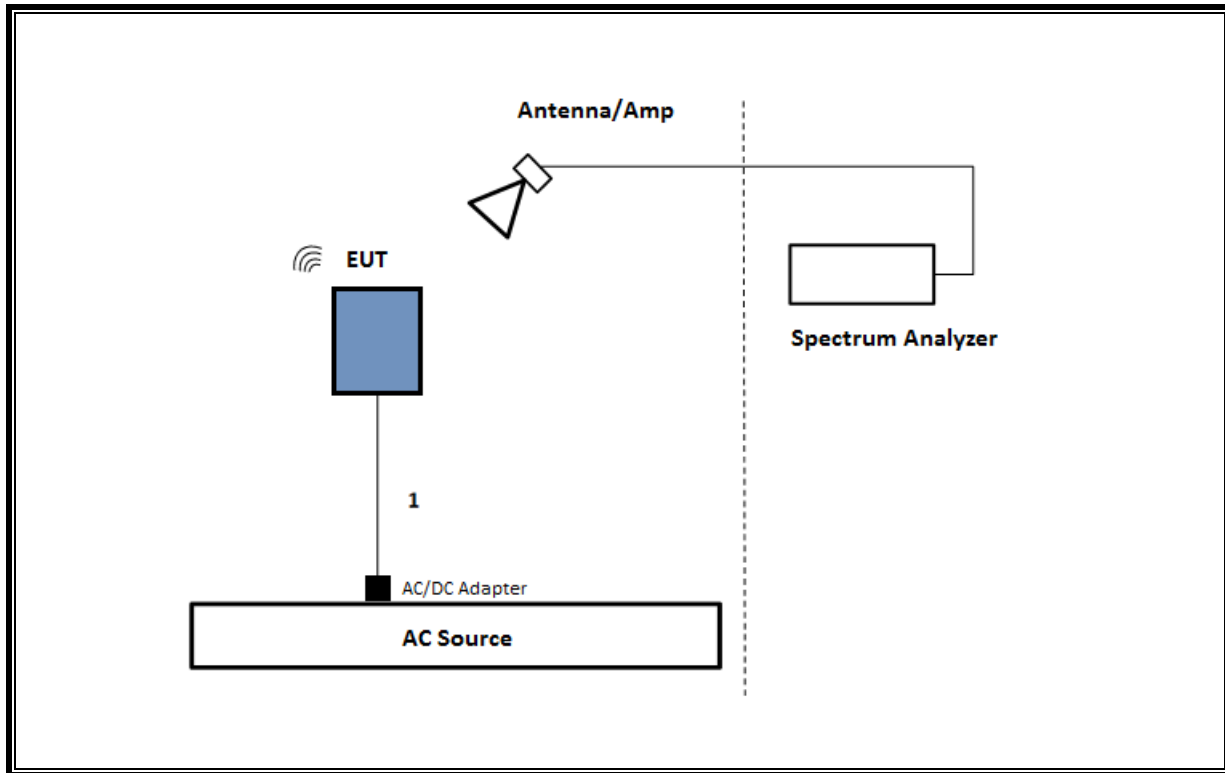

7. TEST AND MEASUREMENT EQUIPMENT

The following test and measurement equipment was utilized for the tests documented in this report:

Description	Manufacturer	Model	ID Num	Cal Due	Last Cal
EMI TEST RECEIVER	Rohde & Schwarz	ESW44	191428	2025/02/28	2024/02/17
EMI TEST RECEIVER	Rohde & Schwarz	ESW44	191428	2024/02/29	2023/02/15
Antenna, Horn 1-18GHz	ETS-Lindgren (Cedar Park, Texas)	3117	206807	2025/05/31	2024/05/16
Antenna, Horn 1-18GHz	ETS-Lindgren (Cedar Park, Texas)	3117	206807	2024/02/29	2023/02/14
RF Filter Box, 1-18GHz, 12 Port.	UL-FR1	Frankenstein	230878	2025/03/31	2024/03/11
RF Filter Box, 1-18GHz, 12 Port.	UL-FR1	Frankenstein	230878	2024/02/29	2023/02/06
EMI TEST RECEIVER	Rohde & Schwarz	ESW44	201501	2024/11/30	2023/11/07
Antenna, Horn 1-18GHz	ETS-Lindgren (Cedar Park, Texas)	3117	81886	2025/03/31	2023/03/20
RF Filter Box, 1-18GHz	UL-FR1	N/A	168534	2025/02/28	2024/02/28
RF Filter Box, 1-18GHz	UL-FR1	N/A	168534	2024/01/05	2023/01/05
* Antenna, BroadBand Hybrid, 30MHz to 3GHz	Sunol Sciences Corp.	JB3	232076	2024/03/31	2023/03/13
* Antenna, Passive Loop 30Hz - 1MHz	ELECTRO-METRICS	EM-6871	170013	2024/07/31	2023/07/31
* Antenna, Passive Loop 100kHz to 30MHz	ELECTRO-METRICS	EM-6872	170015	2024/07/31	2023/07/31
* Amplifier, 100KHz to 1GHz, 32dB	Keysight Technologies Inc	8447D	80670	2024/07/31	2023/07/28
Directional Coupler	KRYTAR	152610	231740	2025/04/30	2024/04/04
Directional Coupler	KRYTAR	152610	231740	2024/02/29	2023/02/24
Directional Coupler	KRYTAR	152610	198817	2024/10/31	2023/10/03
* Environmental Chamber	Cincinnati Sub Zero – Division of Weiss Technik	ZPHS-8-3.5-SCT/WC	82472	2024/06/30	2023/12/15
Spectrum Analyzer, PXA, 3Hz to 44GHz	Keysight Technologies Inc.	N9030A	85313	2025/02/28	2024/02/05
Spectrum Analyzer, PXA, 3Hz to 44GHz	Keysight Technologies Inc.	N9030A	125178	2025/01/31	2024/01/29
Spectrum Analyzer, PXA, 3Hz to 44GHz	Keysight Technologies Inc.	N9030A	125178	2024/02/29	2023/02/06
Wideband Communication Test Set, Call Box	Rohde & Schwarz (Koeln) GmbH & Co. KG	CMW500	11311276	2024/08/14	2023/08/14

UL AUTOMATION SOFTWARE

Radiated Software	UL	UL EMC	Ver 9.5, May 1, 2023
-------------------	----	--------	----------------------

NOTES:

- * = Testing is completed before equipment expiration date.
- Equipment listed above that has a calibration due date during the testing period, the testing is completed before equipment expiration date.

8. RF OUTPUT POWER MEASUREMENT

LIMITS

FCC: §25.204

(a) In bands shared coequally with terrestrial radio communication services, the equivalent isotropically radiated power transmitted in any direction towards the horizon by an earth station, other than an ESV, operating in frequency bands between 1 and 15 GHz, shall not exceed the following limits except as provided for in paragraph (c) of this section:

+ 40 dBW in any 4 kHz band for $\theta \leq 0^\circ$

+ 40 + 3 θ dBW in any 4 kHz band for $0^\circ < \theta \leq 5^\circ$

where θ is the angle of elevation of the horizon viewed from the center of radiation of the antenna of the earth station and measured in degrees as positive above the horizontal plane and negative below it.

ISED RSS-170:

5.5 Mobile Earth Stations (MESs)

The application for MES certification shall state the MES e.i.r.p. that is necessary for satisfactory communication. The maximum permissible e.i.r.p. will be the stated e.i.r.p. plus a 2 dB margin. If a detachable antenna is used, the certification application shall state the recommended antenna type and manufacturer, the antenna gain and the maximum transmitter output power at the antenna terminal.

TEST PROCEDURE

The transmitter output is connected to a wideband power meter/sensor which is greater than the occupied bandwidth as worst-case scenario, also the total power readings still comply with the required limit.

The cable assembly insertion loss of 13.27 dB (ANT 1) / 12.28 dB (ANT 4) (including 10.90 dB coupler and 2.37 dB cable (ANT 1) / 10 dB pad and 2.28 dB cable (ANT 4)) was entered as an offset in the power meter to allow for a gated average reading of power.

RESULTS

Test Engineer:	26118
Test Date:	11/17/2023

Test Frequency (MHz)	Conducted Average Power (dBm)		Antenna Gain (dBi)		EIRP Average Power (dBm)	
	ANT 1	ANT 4	ANT 1	ANT 4	ANT 1	ANT 4
1610.17	27.983	25.800	-4.1	-3.4	23.883	22.400
1618.40	28.000	25.782			23.900	22.382
1626.03	27.980	25.744			23.880	22.344

9. CONDUCTED TEST RESULTS

9.1. OCCUPIED BANDWIDTH

RULE PART(S)

FCC: §2.1049
ISED RSS-170 and RSS-GEN

LIMITS

For reporting purposes only.

TEST PROCEDURE

The transmitter output was connected to a calibrated coaxial cable and coupler, the other end of which was connected to a spectrum analyzer. The occupied bandwidth was measured with the spectrum analyzer at the middle channel in each band. The nominal RBW shall be in the range of 1% to 5% of the anticipated OBW, and the VBW shall be set $\geq 3 \times$ RBW. The 99% bandwidths were measured and recorded.

RESULTS

Test Engineer:	26118
Test Date:	2023/11/17 2024/08/08

Test Frequency (MHz)	99% Bandwidth (kHz) ANT 1	99% Bandwidth (kHz) ANT 4
1610.17	199.54	201.24
1618.40	197.86	203.96
1626.03	199.78	202.02

9.1.1. ANT 1

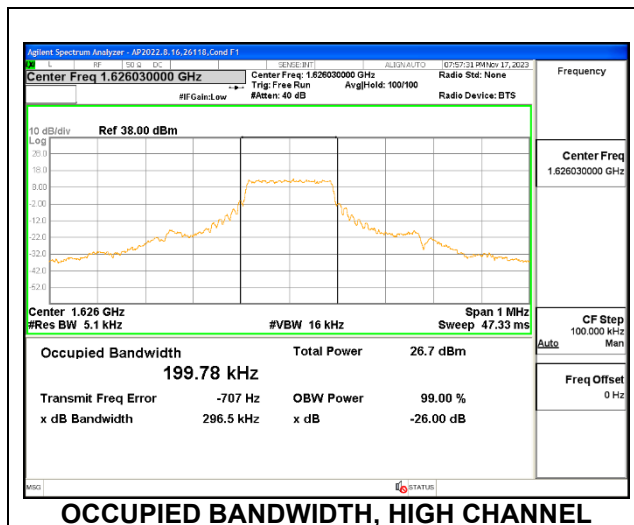
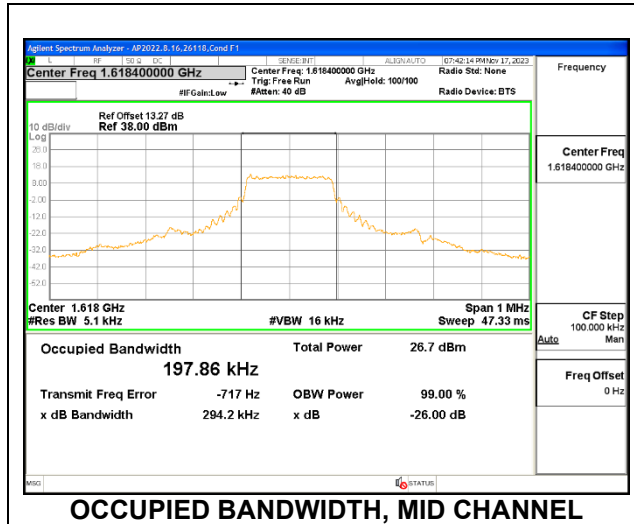
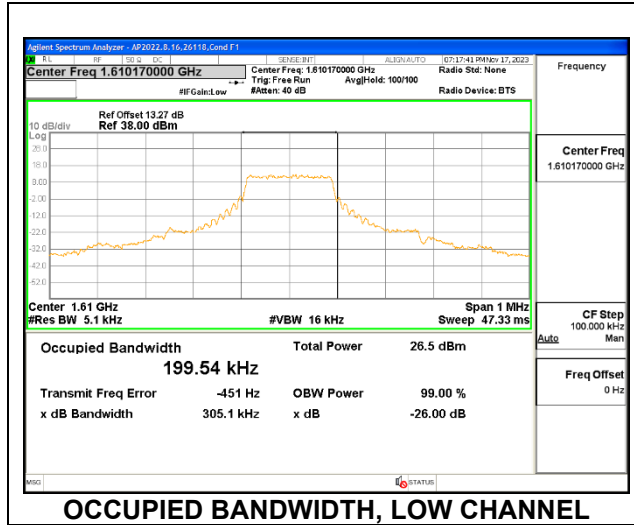

9.1.2. ANT 4

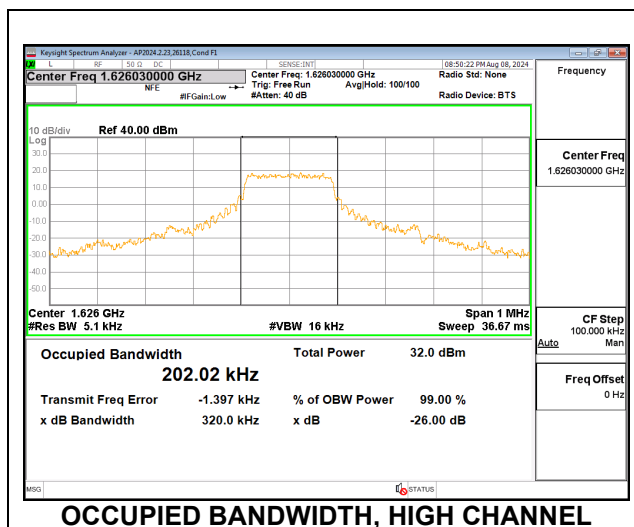
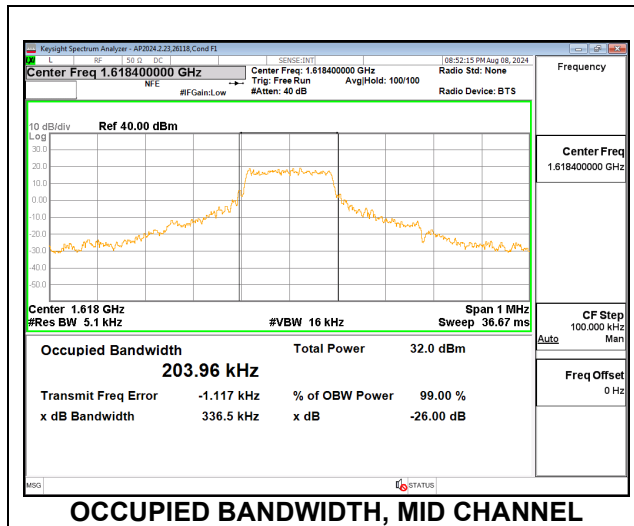
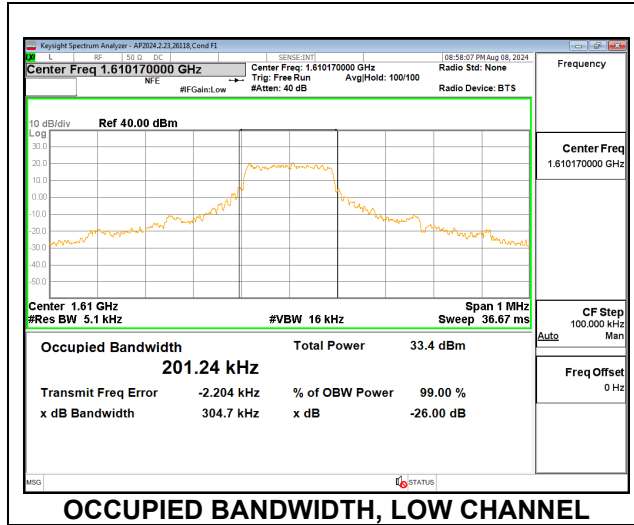

9.2. EMISSIONS MASK WITHIN 250% OF AUTHORIZED BANDWIDTH

LIMITS

FCC §25.202 and ISSED RSS-170: 5.8 (a) & (b)

(f) Emission limitations. Except for SDARS terrestrial repeaters and as provided for in paragraph (i), the mean power of emissions shall be attenuated below the mean output power of the transmitter in accordance with the schedule set forth in paragraphs (f)(1) through (f)(4) of this section. The out-of-band emissions of SDARS terrestrial repeaters shall be attenuated in accordance with the schedule set forth in paragraph (h) of this section.

(1) In any 4 kHz band, the center frequency of which is removed from the assigned frequency by more than 50 percent up to and including 100 percent of the authorized bandwidth: 25 dB;

(2) In any 4 kHz band, the center frequency of which is removed from the assigned frequency by more than 100 percent up to and including 250 percent of the authorized bandwidth: 35 dB;

TEST PROCEDURE

The transmitter output was connected to a calibrated coaxial cable and coupler, the other end of which was connected to a spectrum analyzer. The channel edge emissions were measured on the low, mid and high channels. The limits within 250% of the authorized bandwidth are relative to the total in-band (channel) power. The measurement bandwidth (RBW) is set to ≥ 4 kHz and VBW set to at least 3 times the RBW. To measure the average value of the emissions the detector is set to rms while observing the minimum required number of points as detailed in ANSI C63.26 for average rms measurements. The sweep time is set to 2ms multiplied by the number of points to obtain the average over 2ms. Multiple sweeps with max hold enabled are made to capture the maximum average value.

RESULTS

The tests were performed based on declared authorized bandwidths of 200 kHz, 230 kHz and 280 kHz. The ANT 4 was performed only on center channel since it was the same signal to each antenna.

Test Engineer:	26118
Test Date:	2023/11/17 2023/11/20

9.2.1. ANT 1

200 kHz Authorized Bandwidth

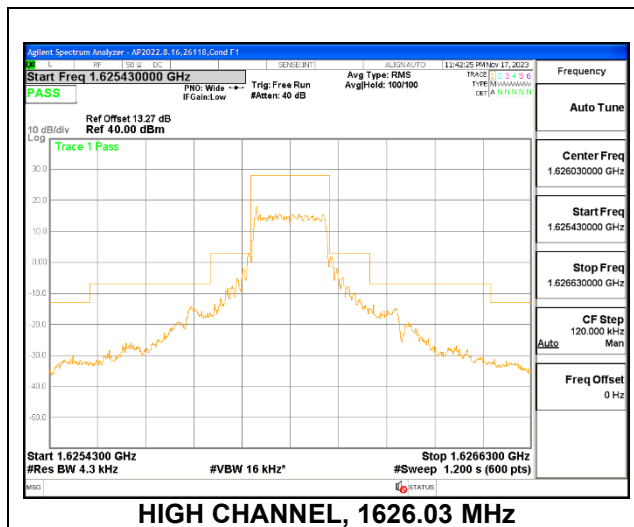
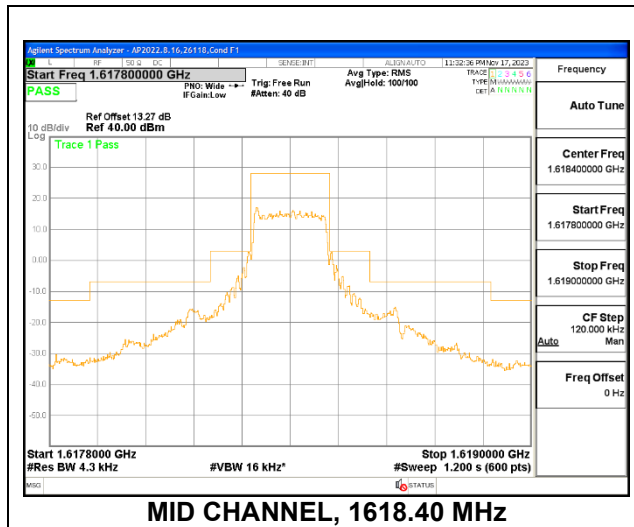
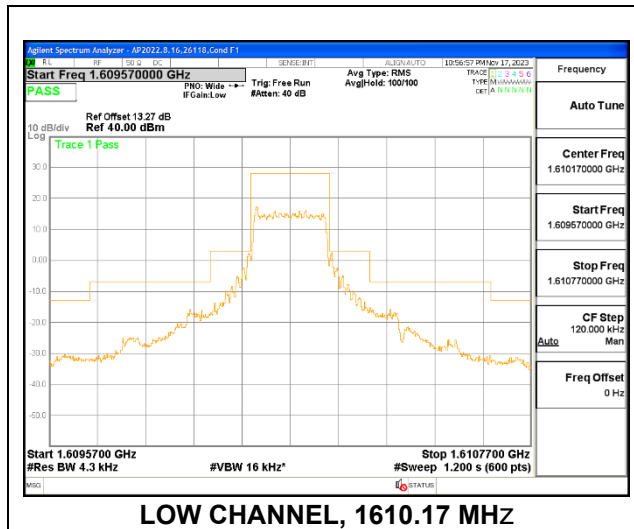

230 kHz Authorized Bandwidth

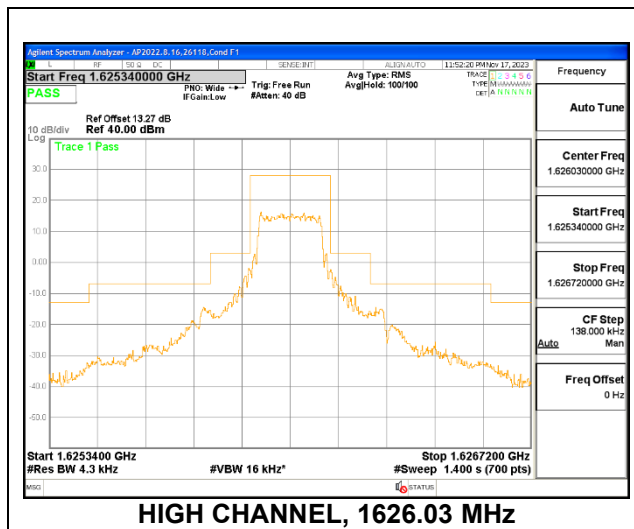
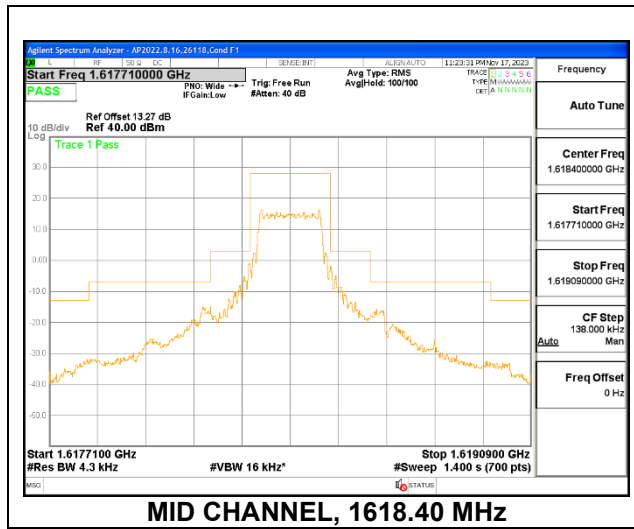
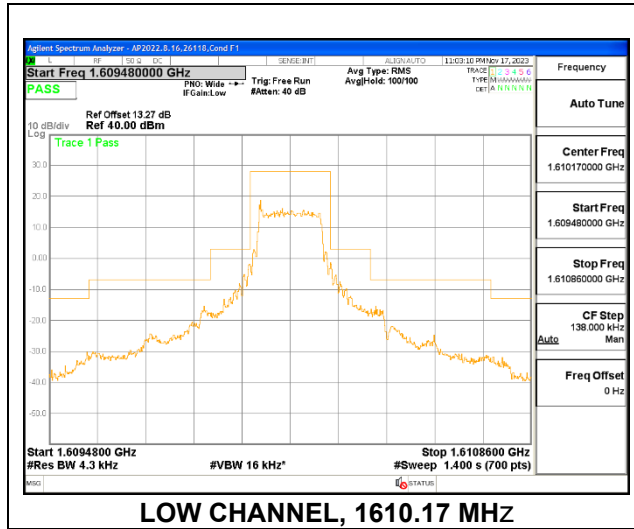

280 kHz Authorized Bandwidth

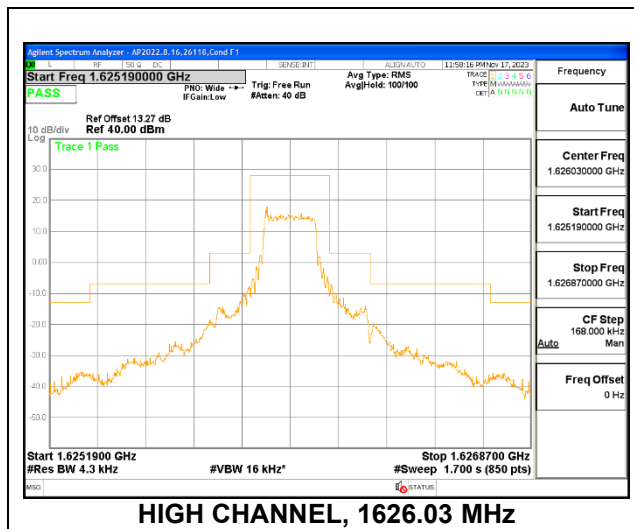
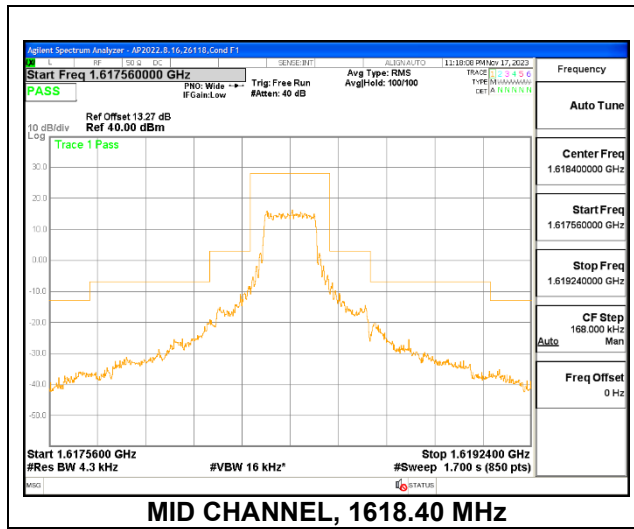
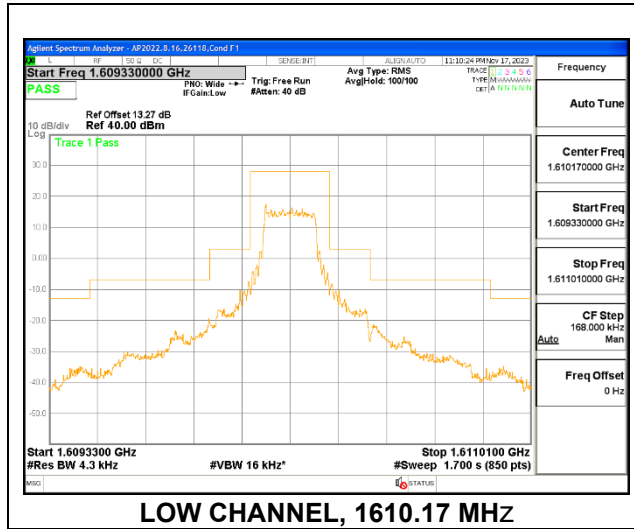

9.2.2. ANT 4

200 kHz Authorized Bandwidth

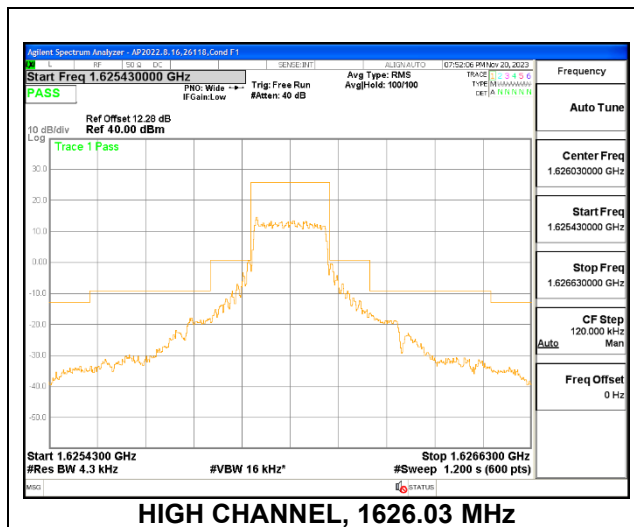
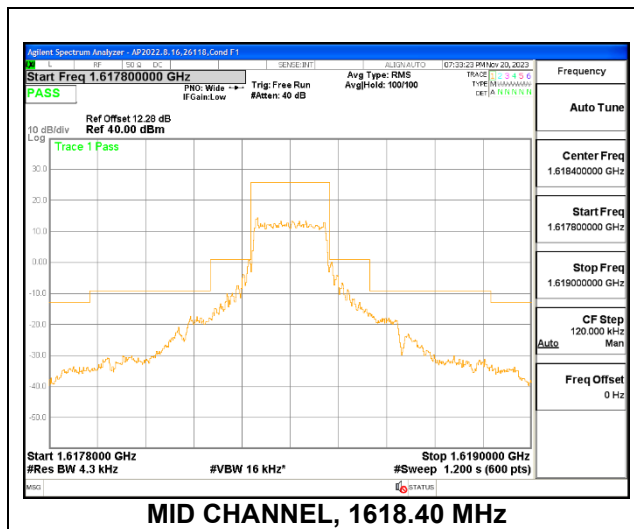
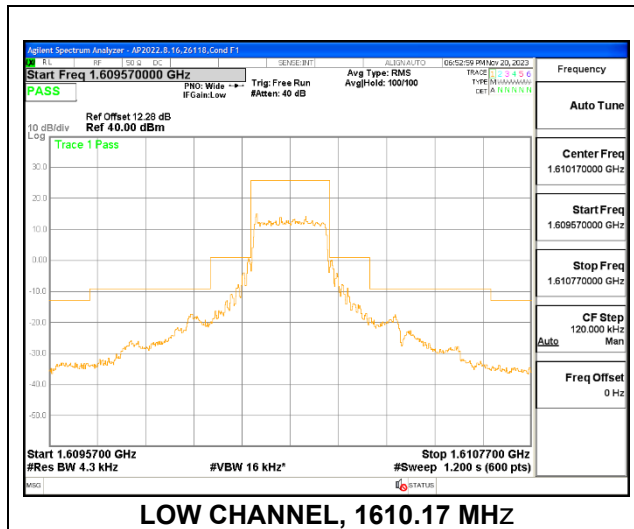

230 kHz Authorized Bandwidth

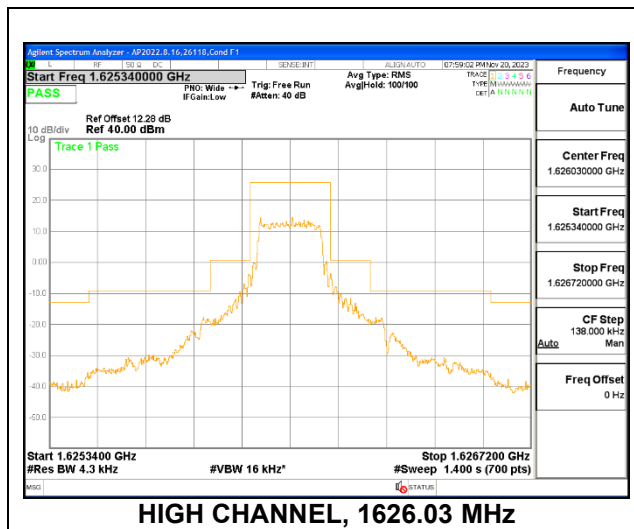
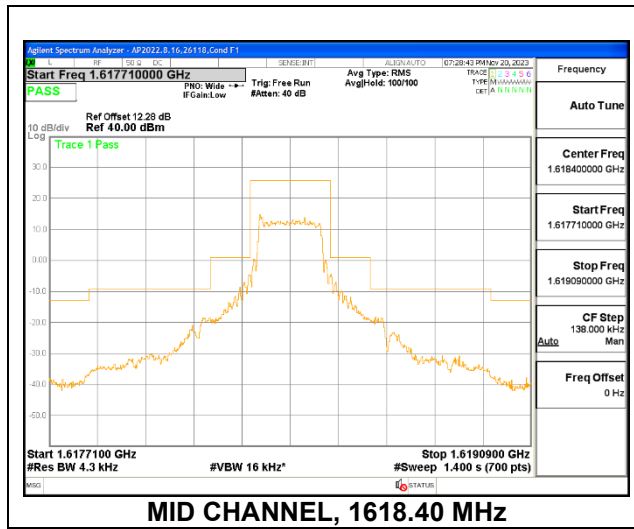
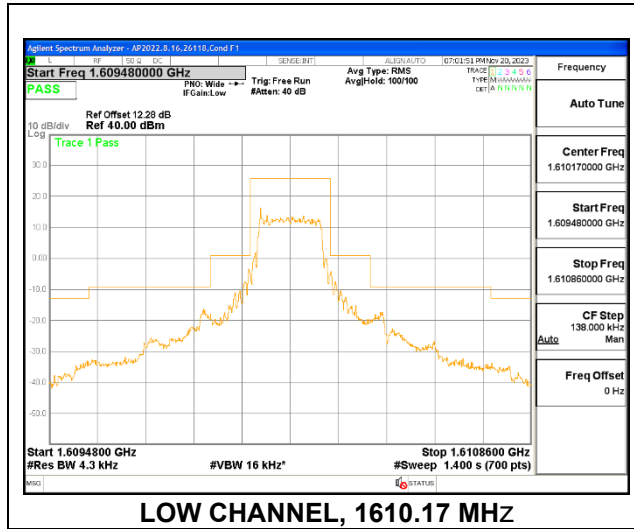

280 kHz Authorized Bandwidth

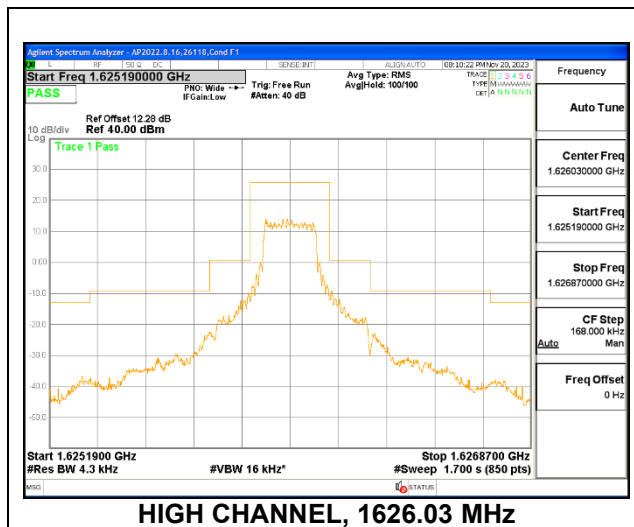
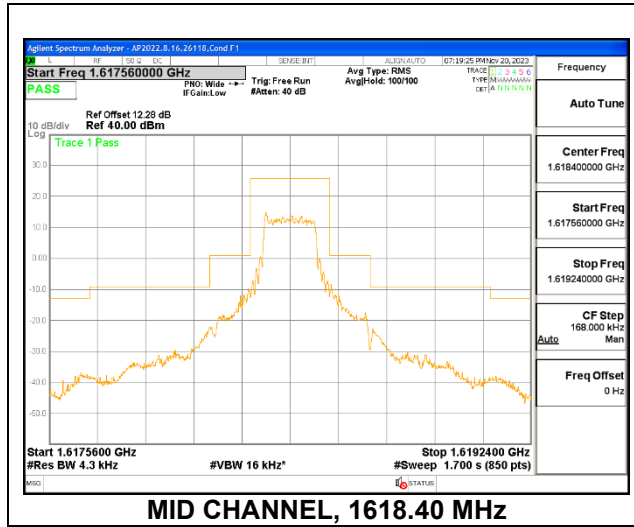
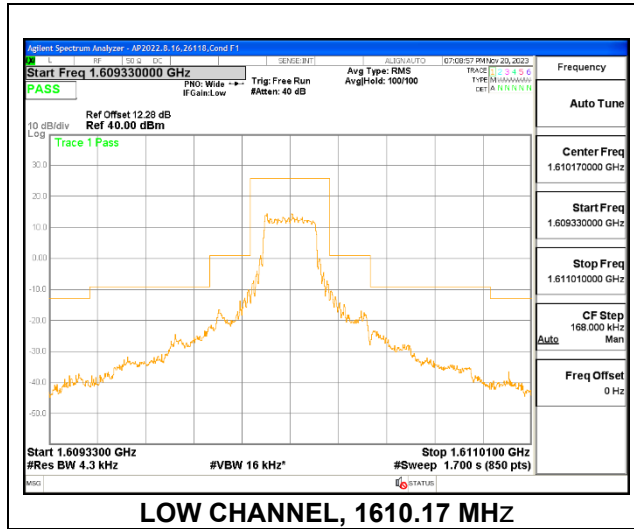

9.3. OUT OF BAND EMISSIONS

LIMITS

FCC §25.202 and ISSED RSS-170: 5.8 (c)

(f) Emission limitations. Except for SDARS terrestrial repeaters and as provided for in paragraph (i), the mean power of emissions shall be attenuated below the mean output power of the transmitter in accordance with the schedule set forth in paragraphs (f)(1) through (f)(4) of this section. The out-of-band emissions of SDARS terrestrial repeaters shall be attenuated in accordance with the schedule set forth in paragraph (h) of this section.

(3) In any 4 kHz band, the center frequency of which is removed from the assigned frequency by more than 250 percent of the authorized bandwidth: An amount equal to 43 dB plus 10 times the logarithm (to the base 10) of the transmitter power in watts.

TEST PROCEDURE

KDB 971168 D01 v03r01/D02 v02/r01

For each out of band emissions measurement:

- Set display line at -13 dBm (the limit of $43 + 10\text{Log}(P)$)
- Set RBW $\geq 4\text{kHz}$ and VBW $\geq 3 \times \text{RBW}$ with peak detector for all measurements. The limit is an average limit so any emissions that exceed the limit using the peak detector are measured using rms detection with an averaging time of 2ms.

RESULTS

The conducted spurious emissions were performed with the highest output power on ANT 1 as worst-case scenario.

Test Engineer:	26118
Test Date:	2023/11/17 2024/08/08

9.3.1. ANT 1

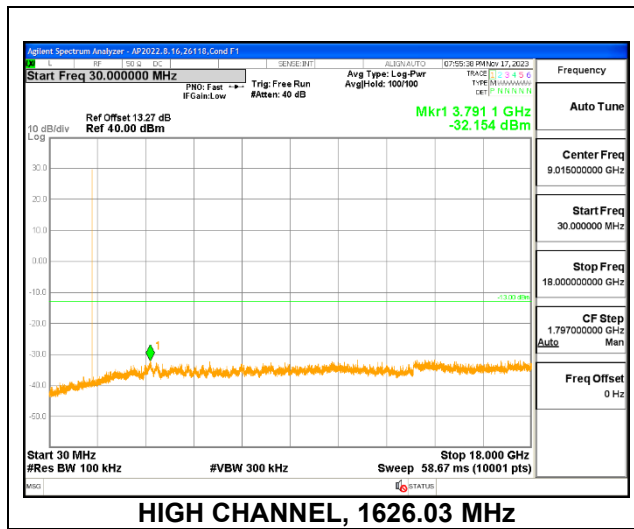
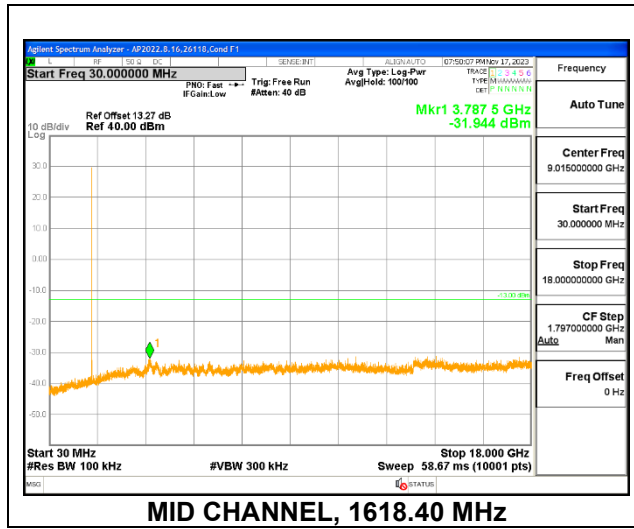
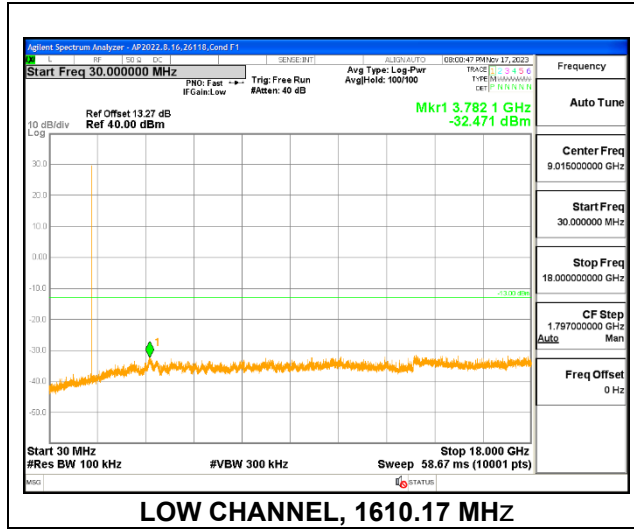

9.3.2. ANT 4

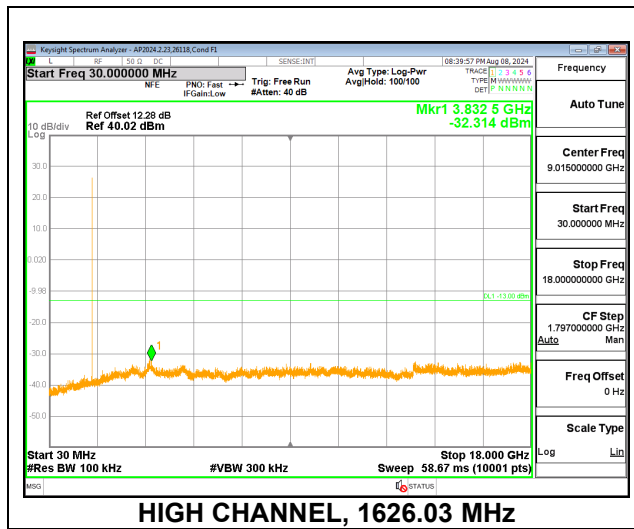
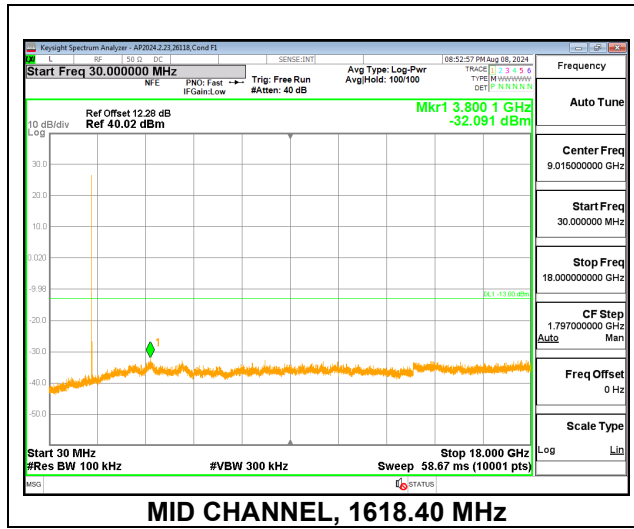
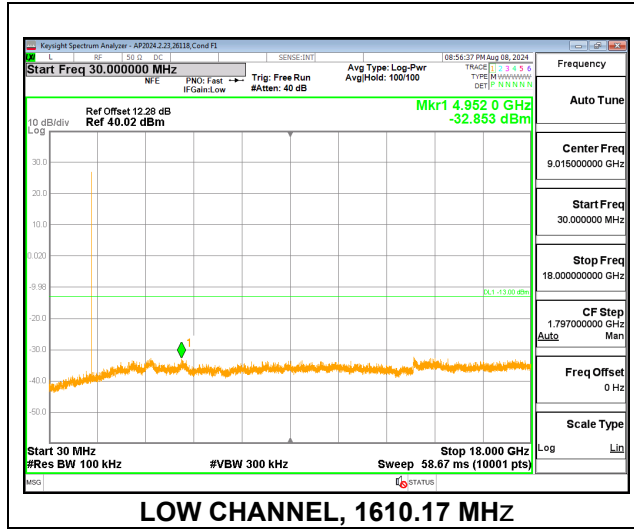

10. RADIATED TEST RESULTS

Radiated measurement using the Field Strength Method

Using the test configuration shown in Figure 6 below, we measure the radiated emissions directly from the EUT and convert the measured field strength or received power to EIRP, as required, for comparison to the applicable limits. As stated in 5.5.1 of ANSI C63.26-2015, the field strength measurement method using a test site validated to the requirements of ANSI C63.4 is an alternative to the substitution measurement method.

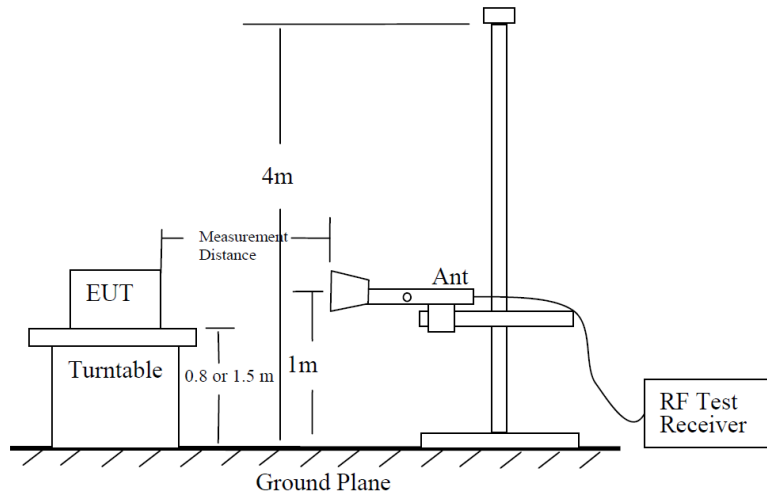

Figure 6—Test site-up for radiated ERP and/or EIRP measurements

Radiated Power Measurement Calculation According to ANSI C63.26-2015

- a) $E \text{ (dB}\mu\text{V/m)} = \text{Measured amplitude level (dB}\mu\text{V)} + \text{Cable Loss (dB)} + \text{Antenna Factor (dB/m)}$
- b) $E \text{ (dB}\mu\text{V/m)} = \text{Measured amplitude level (dBm)} + 107 + \text{Cable Loss (dB)} + \text{Antenna Factor (dB/m)}$
- c) $E \text{ (dB}\mu\text{V/m)} = \text{EIRP (dBm)} - 20 \cdot \log(D) + 104.8$; where D is the measurement distance (in the far field region) in m
- d) $\text{EIRP (dBm)} = E \text{ (dB}\mu\text{V/m)} + 20 \cdot \log(D) - 104.8$; where D is the measurement distance (in the far field region) in m

So, from d)

The measuring distance is usually at 3m, then $20 \cdot \log(3) = 9.5424$

Then, $\text{EIRP (dBm)} = E \text{ (dB}\mu\text{V/m)} + 9.5424 - 104.8 = E \text{ (dB}\mu\text{V/m)} - 95.2576$

10.1. FIELD STRENGTH OF SPURIOUS RADIATION

LIMITS

FCC §25.202 and ISSED RSS-170: 5.8 (c)

(f) Emission limitations. Except for SDARS terrestrial repeaters and as provided for in paragraph (i), the mean power of emissions shall be attenuated below the mean output power of the transmitter in accordance with the schedule set forth in paragraphs (f)(1) through (f)(4) of this section. The out-of-band emissions of SDARS terrestrial repeaters shall be attenuated in accordance with the schedule set forth in paragraph (h) of this section.

(3) In any 4 kHz band, the center frequency of which is removed from the assigned frequency by more than 250 percent of the authorized bandwidth: An amount equal to 43 dB plus 10 times the logarithm (to the base 10) of the transmitter power in watts;

TEST PROCEDURE

KDB 971168 D01 v03r01/D02 v02/r01

For each out of band emissions measurement:

- Set display line at -13 dBm (the limit of $43 + 10\text{Log}(P)$)
- Set RBW $\geq 4\text{kHz}$ and VBW $\geq 3 \times \text{RBW}$ with peak detector for all measurements. The limit is an average limit so any emissions that exceed the limit using the peak detector are measured using rms detection with an averaging time of 2ms.

RESULTS

Plots are provided for the center channel. Tabular data for all channels is presented.

10.1.1. ANT 1 (Above 1 GHz)

Date:	3/22/2024
Test Engineer:	24943
Configuration:	EUT + Charger
Mode:	TX
Chamber:	02-RDE-E

LOW CHANNEL DATA

Marker	Frequency (GHz)	Meter Reading (dBuV)	Det	206807 ACF (dB/m)	EIRP CF	Gain/Loss (dB)	Corrected Reading (dBm)	LIMIT	Margin (dB)	Azimuth (Degs)	Height (cm)	Polarity
2	4.830497	59.23	Pk	33.9	-95.2	-46.95	-49.02	-13	-36.02	142	164	H
5	4.830491	60.44	Pk	33.9	-95.2	-46.95	-47.81	-13	-34.81	193	169	V
4	*3.133578	45.98	Pk	33.1	-95.2	-46.91	-63.03	-13	-50.03	0-360	150	V
1	*3.219931	45.99	Pk	33	-95.2	-45.96	-62.17	-13	-49.17	0-360	150	H
6	*6.257391	43.11	Pk	35.4	-95.2	-44.11	-60.8	-13	-47.8	0-360	150	V
3	*6.387628	42.34	Pk	35.5	-95.2	-44.12	-61.48	-13	-48.48	0-360	150	H

Pk - Peak detector

* - Noise floor

MID CHANNEL DATA

Marker	Frequency (GHz)	Meter Reading (dBuV)	Det	206807 ACF (dB/m)	EIRP CF	Gain/Loss (dB)	Corrected Reading (dBm)	LIMIT	Margin (dB)	Azimuth (Degs)	Height (cm)	Polarity
2	*4.854978	46.62	Pk	33.9	-95.2	-46.82	-61.5	-13	-48.5	0-360	150	H
5	*4.837991	45.55	Pk	33.9	-95.2	-46.95	-62.7	-13	-49.7	0-360	150	V
1	*3.277500	45.35	Pk	32.9	-95.2	-45.89	-62.84	-13	-49.84	0-360	150	H
4	*3.282219	45.13	Pk	32.8	-95.2	-45.97	-63.24	-13	-50.24	0-360	150	V
6	*6.448972	42.58	Pk	35.5	-95.2	-44.44	-61.56	-13	-48.56	0-360	150	V
3	*6.470678	41.94	Pk	35.5	-95.2	-44.4	-62.16	-13	-49.16	0-360	150	H

Pk - Peak detector

* - Noise floor

HIGH CHANNEL DATA

Marker	Frequency (GHz)	Meter Reading (dBuV)	Det	206807 ACF (dB/m)	EIRP CF	Gain/Loss (dB)	Corrected Reading (dBm)	LIMIT	Margin (dB)	Azimuth (Degs)	Height (cm)	Polarity
2	4.878080	57.59	Pk	33.9	-95.2	-47.04	-50.75	-13	-37.75	338	118	H
5	4.878071	59.15	Pk	33.9	-95.2	-47.04	-49.19	-13	-36.19	4	317	V
4	*3.175103	47.06	Pk	33	-95.2	-46.52	-61.66	-13	-48.66	0-360	150	V
1	*3.212381	45.4	Pk	33	-95.2	-45.95	-62.75	-13	-49.75	0-360	150	H
3	*6.602803	43.77	Pk	35.5	-95.2	-43.61	-59.54	-13	-46.54	0-360	150	H
6	*6.632059	42.29	Pk	35.5	-95.2	-43.34	-60.75	-13	-47.75	0-360	150	V

Pk - Peak detector

* - Noise floor

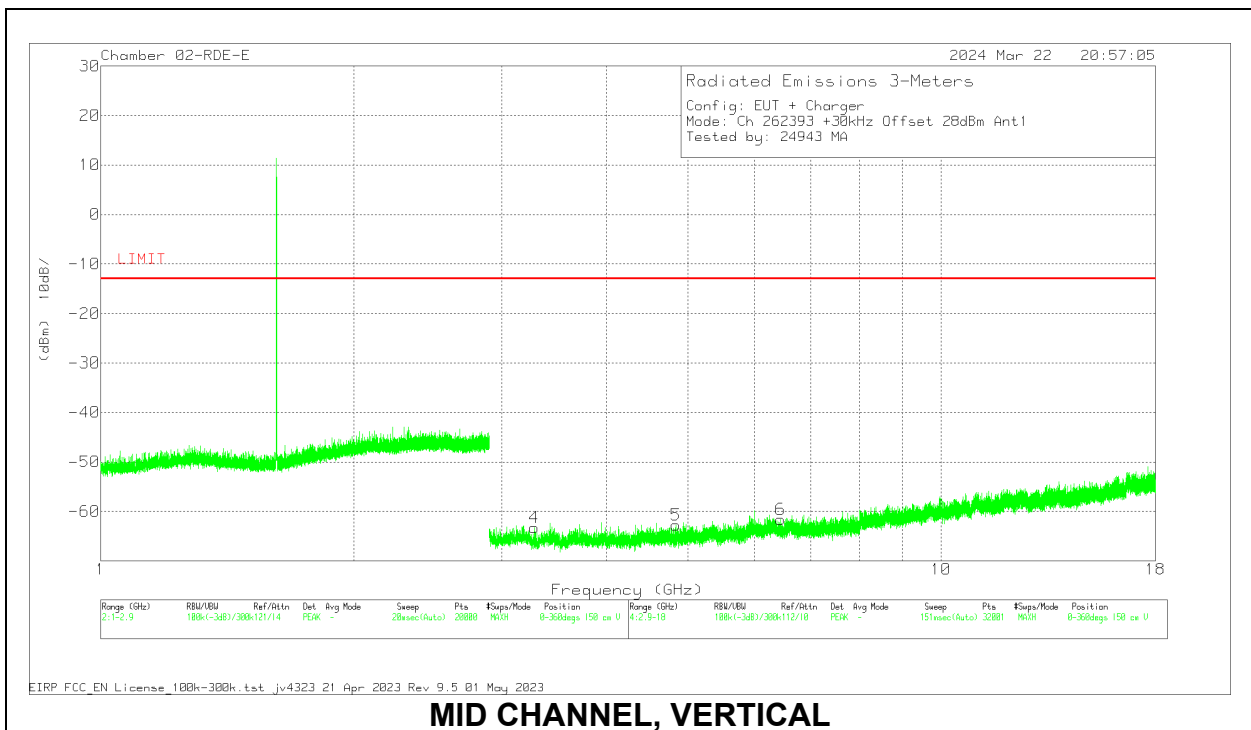
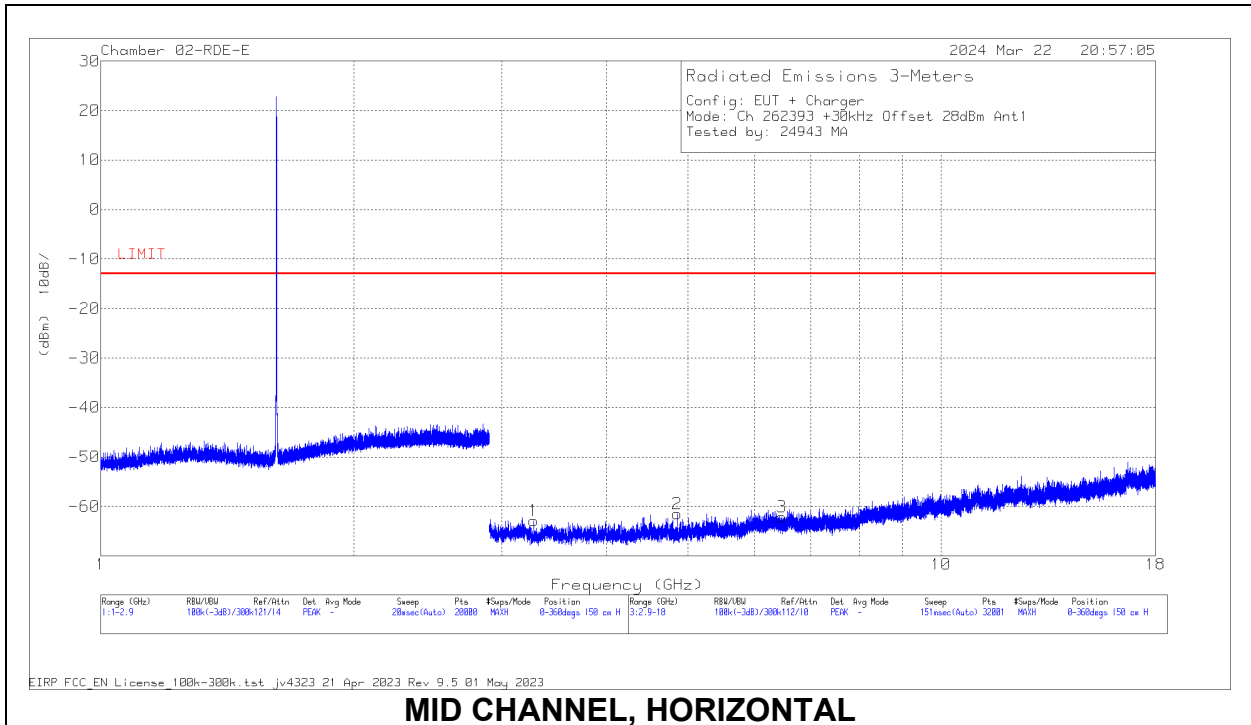

10.1.2. ANT 4 (Above 1 GHz)

Date:	2/22/2024
Test Engineer:	24943
Configuration:	EUT + Charger
Mode:	TX
Chamber:	02-RDE-E

LOW CHANNEL DATA

Marker	Frequency (GHz)	Meter Reading (dBuV)	Det	206807 ACF (dB/m)	EIRP CF	Gain/Loss (dB)	Corrected Reading (dBm)	LIMIT	Margin (dB)	Azimuth (Degs)	Height (cm)	Polarity
2	*4.772400	44.59	Pk	34	-95.2	-47	-63.61	-13	-50.61	0-360	150	H
5	*4.738897	45.71	Pk	34	-95.2	-47.07	-62.56	-13	-49.56	0-360	150	V
1	*3.287409	44.6	Pk	32.8	-95.2	-46.08	-63.88	-13	-50.88	0-360	150	H
4	*3.301566	44.57	Pk	32.8	-95.2	-46.14	-63.97	-13	-50.97	0-360	150	V
6	*6.295141	43.44	Pk	35.4	-95.2	-43.94	-60.3	-13	-47.3	0-360	150	V
3	*6.370169	42.78	Pk	35.5	-95.2	-44.01	-60.93	-13	-47.93	0-360	150	H

Pk - Peak detector

* - Noise floor

MID CHANNEL DATA

Marker	Frequency (GHz)	Meter Reading (dBuV)	Det	206807 ACF (dB/m)	EIRP CF	Gain/Loss (dB)	Corrected Reading (dBm)	LIMIT	Margin (dB)	Azimuth (Degs)	Height (cm)	Polarity
2	*4.825722	45.33	Pk	33.9	-95.2	-47.01	-62.98	-13	-49.98	0-360	150	H
5	*4.861584	45.38	Pk	33.9	-95.2	-46.83	-62.75	-13	-49.75	0-360	150	V
4	*3.247772	44.87	Pk	33	-95.2	-46.03	-63.36	-13	-50.36	0-360	150	V
1	*3.251547	44.9	Pk	32.9	-95.2	-46.08	-63.48	-13	-50.48	0-360	150	H
6	*6.396122	42.69	Pk	35.5	-95.2	-44.22	-61.23	-13	-48.23	0-360	150	V
3	*6.440478	42.55	Pk	35.5	-95.2	-44.39	-61.54	-13	-48.54	0-360	150	H

Pk - Peak detector

* - Noise floor

HIGH CHANNEL DATA

Marker	Frequency (GHz)	Meter Reading (dBuV)	Det	206807 ACF (dB/m)	EIRP CF	Gain/Loss (dB)	Corrected Reading (dBm)	LIMIT	Margin (dB)	Azimuth (Degs)	Height (cm)	Polarity
2	*4.910659	46.2	Pk	33.9	-95.2	-47	-62.1	-13	-49.1	0-360	150	H
5	*4.849316	45.05	Pk	33.9	-95.2	-46.96	-63.21	-13	-50.21	0-360	150	V
4	*3.158588	46.7	Pk	33	-95.2	-46.56	-62.06	-13	-49.06	0-360	150	V
1	*3.193034	46.08	Pk	33	-95.2	-46.31	-62.43	-13	-49.43	0-360	150	H
3	*6.366394	42.66	Pk	35.5	-95.2	-44	-61.04	-13	-48.04	0-360	150	H
6	*6.371113	42.57	Pk	35.5	-95.2	-44.02	-61.15	-13	-48.15	0-360	150	V

Pk - Peak detector

* - Noise floor

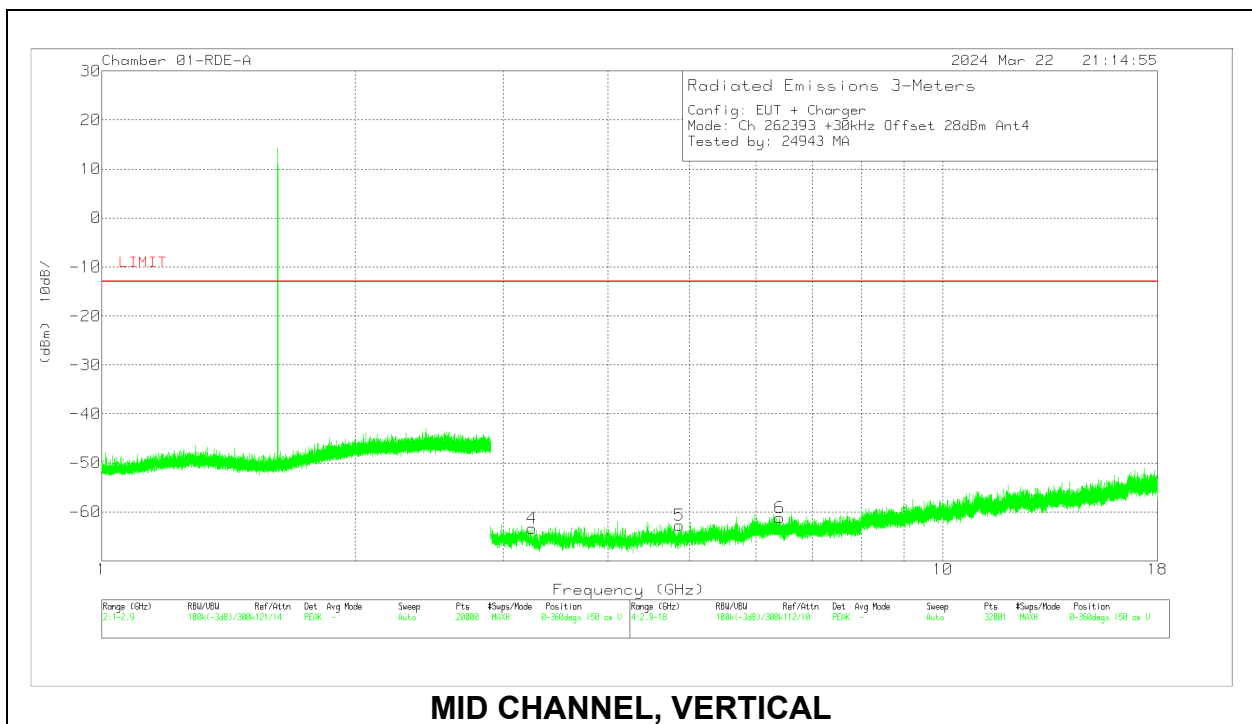
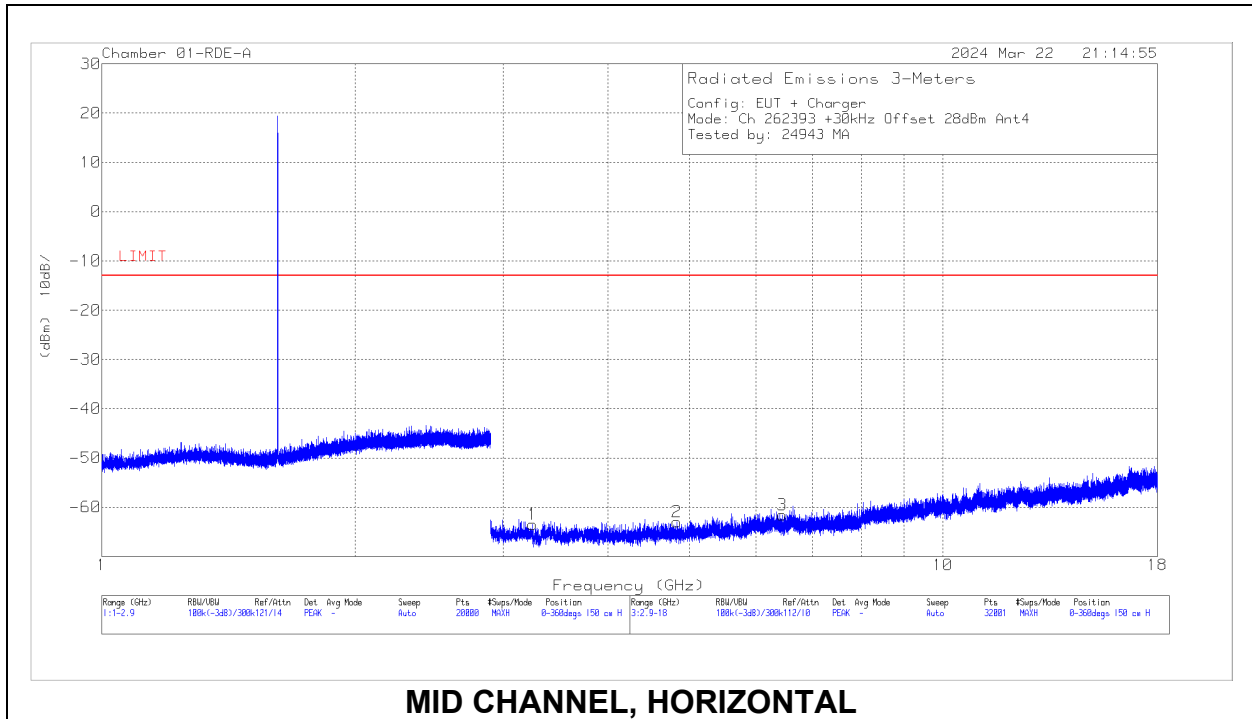

10.1.3. ANT 1 (Below 1GHz)

Date:	3/27/2024
Test Engineer:	45258
Configuration:	EUT + Charger
Mode:	TX
Chamber:	01-RDE-A

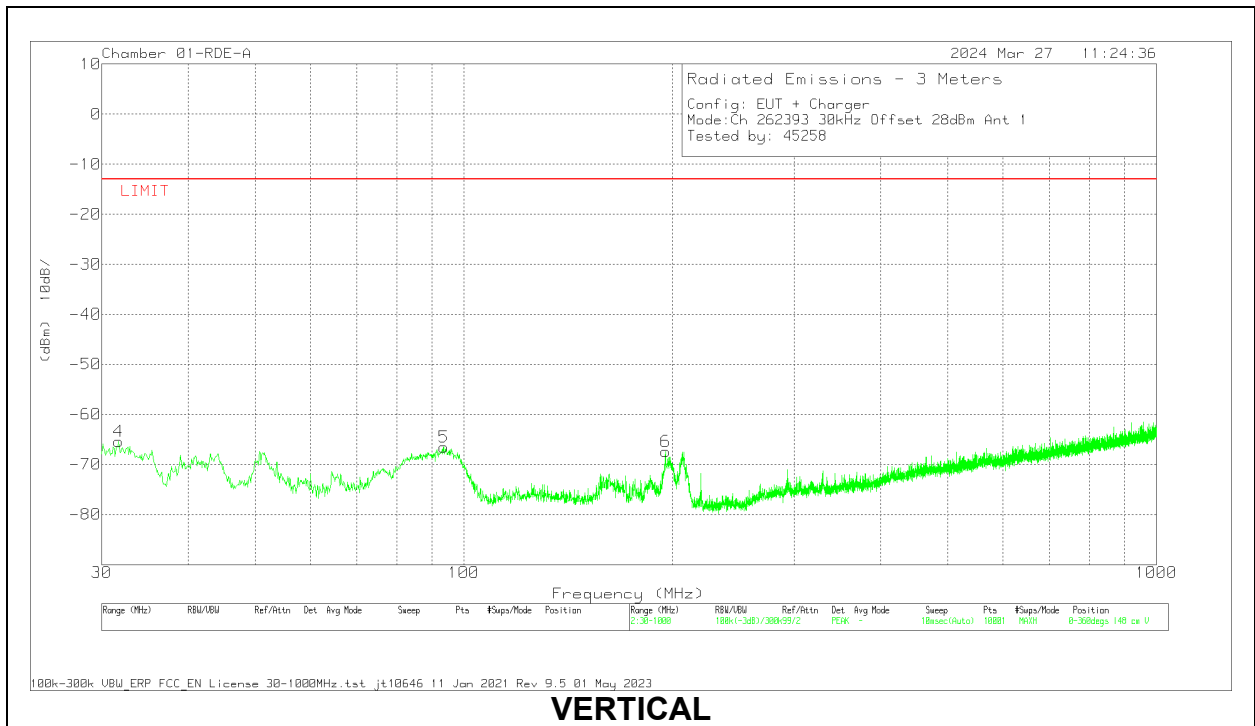
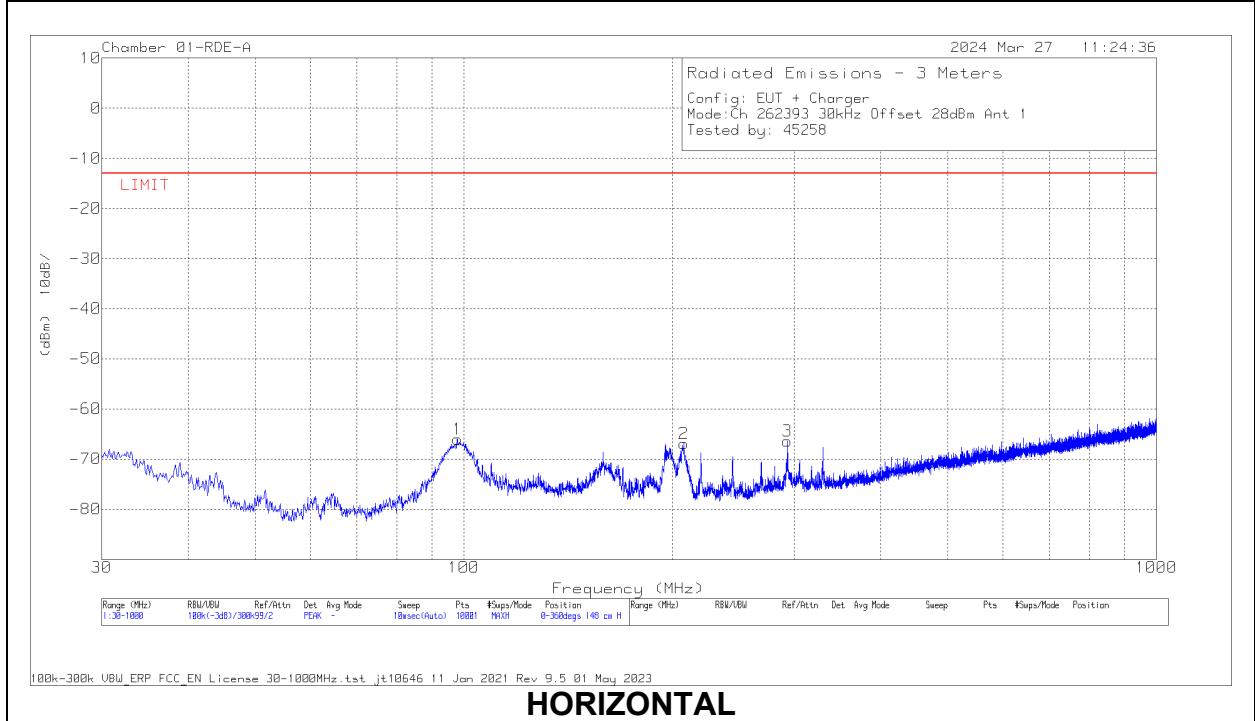

DATA

Marker	Frequency (MHz)	Meter Reading (dBuV)	Det	232075 ACF (dB/m)	Cbl (dB)	EIRP CF	Corrected Reading (dBm)	LIMIT	Margin (dB)	Azimuth (Degs)	Height (cm)	Polarity
4	31.746	31.17	Pk	25.7	-27.1	-95.2	-65.43	-13	-52.43	0-360	148	V
5	93.535	40.46	Pk	14.5	-26.3	-95.2	-66.54	-13	-53.54	0-360	148	V
1	97.9	39.7	Pk	15.7	-26.2	-95.2	-66	-13	-53	0-360	148	H
6	195.579	35.04	Pk	17.8	-25.1	-95.2	-67.46	-13	-54.46	0-360	148	V
2	207.704	36.69	Pk	16.7	-25.1	-95.2	-66.91	-13	-53.91	0-360	148	H
3	293.258	33.96	Pk	19.2	-24.4	-95.2	-66.44	-13	-53.44	0-360	148	H

Pk - Peak detector

10.1.4. ANT 4 (Below 1GHz)

Date:	3/27/2024
Test Engineer:	45258
Configuration:	EUT + Charger
Mode:	TX
Chamber:	01-RDE-A

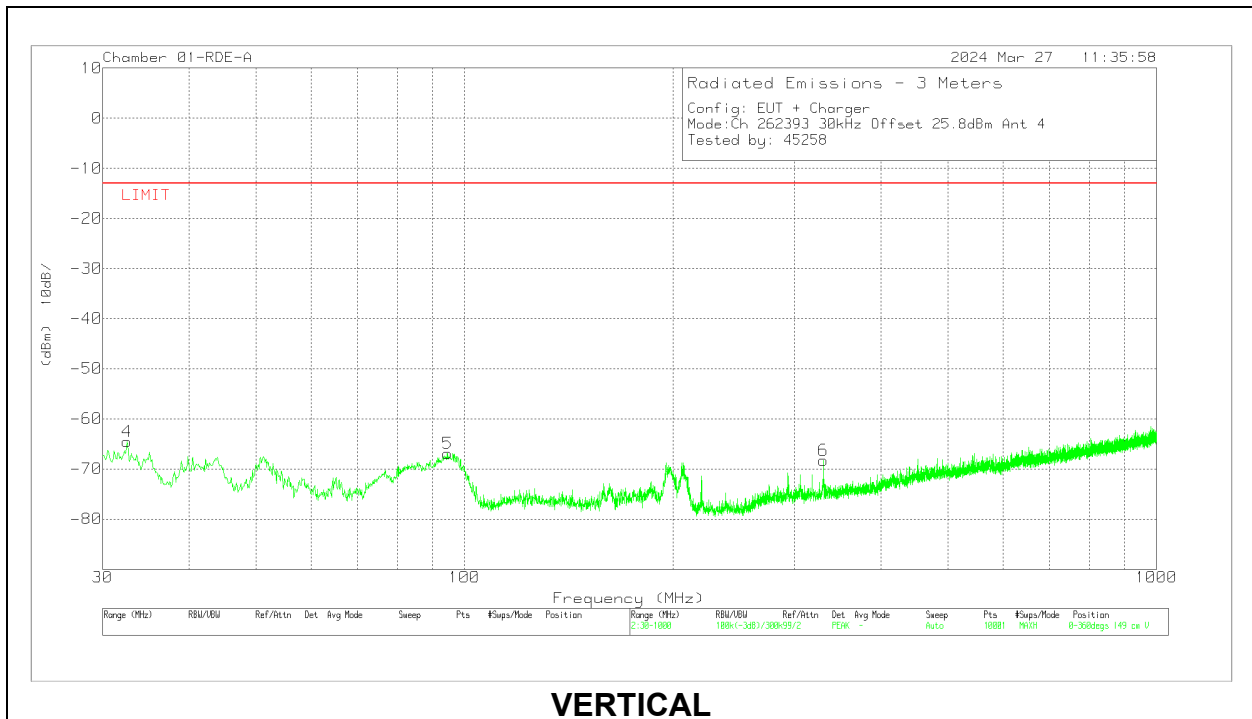
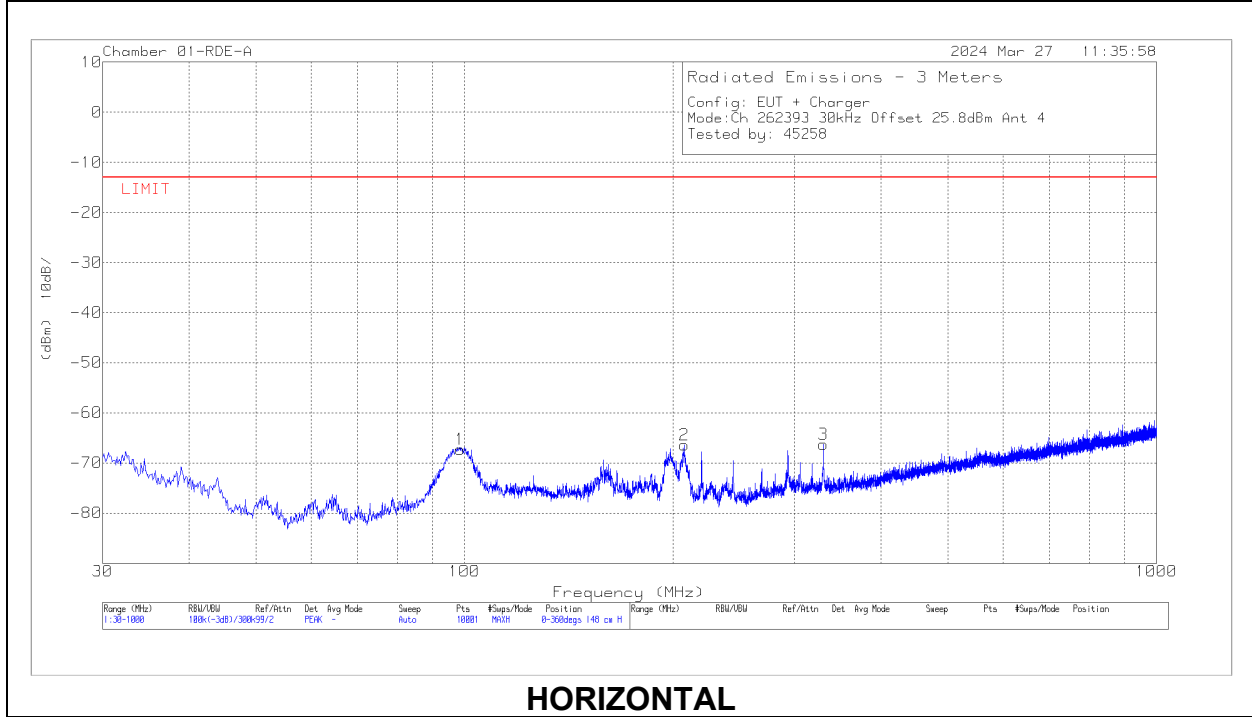

DATA

Marker	Frequency (MHz)	Meter Reading (dBuV)	Det	232075 ACF (dB/m)	Cbl (dB)	EIRP CF	Corrected Reading (dBm)	LIMIT	Margin (dB)	Azimuth (Degs)	Height (cm)	Polarity
3	* 329.924	33.38	Pk	19.8	-24.3	-95.2	-66.32	-13	-53.32	0-360	148	H
6	* 329.924	31.46	Pk	19.8	-24.3	-95.2	-68.24	-13	-55.24	0-360	149	V
4	32.522	32.61	Pk	25.2	-27.1	-95.2	-64.49	-13	-51.49	0-360	149	V
5	94.505	39.82	Pk	14.8	-26.3	-95.2	-66.88	-13	-53.88	0-360	149	V
1	98.579	38.18	Pk	15.9	-26.2	-95.2	-67.32	-13	-54.32	0-360	148	H
2	207.704	37.16	Pk	16.7	-25.1	-95.2	-66.44	-13	-53.44	0-360	148	H

* - indicates frequency in CFR47 Pt 15 / IC RSS-Restricted Band
 Pk - Peak detector

10.2. ADDITIONAL UNWANTED EMISSION (1559MHz – 1610MHz)

LIMITS

FCC §25.216

Limits on emissions from mobile earth stations for protection of aeronautical radionavigation-satellite service

(a) The e.i.r.p. density of emissions from mobile earth stations placed in service on or before July 21, 2002 ...

(b) The e.i.r.p. density of emissions from mobile earth stations placed in service on or before July 21, 2002 ...

(c) The e.i.r.p. density of emissions from mobile earth stations placed in service after July 21, 2002 with assigned uplink frequencies between 1610 MHz and 1660.5 MHz shall not exceed -70 dBW/MHz, averaged over any 2 millisecond active transmission interval, in the band 1559-1605 MHz. The e.i.r.p. of discrete emissions of less than 700 Hz bandwidth from such stations shall not exceed -80 dBW, averaged over any 2 millisecond active transmission interval, in the 1559-1605 MHz band.

FCC §25.216 and ISSED RSS-170: 5.9.1

(g) Mobile earth stations manufactured more than six months after Federal Register publication of the rule changes adopted in FCC 03-283 with assigned uplink frequencies in the 1610-1626.5 MHz band shall suppress the power density of emissions in the 1605-1610 MHz band-segment to an extent determined by linear interpolation from -70 dBW/MHz at 1605 MHz to -10 dBW/MHz at 1610 MHz averaged over any 2 millisecond active transmission interval. The e.i.r.p. of discrete emissions of less than 700 Hz bandwidth from such stations shall not exceed a level determined by linear interpolation from -80 dBW at 1605 MHz to -20 dBW at 1610 MHz, averaged over any 2 millisecond active transmission interval.

TEST PROCEDURE

KDB 971168 D01 v03r01/D02 v02/r01

Measure wideband emissions using either:

RBW = 1MHz, VB = 3MHz

RBW < 1MHz, integrate over 1MHz if necessary

Measure narrowband emissions using:

RBW = 10kHz, VB = 30kHz as worst case setting

Set detector = rms, sweep time ~ number of points x 2ms, and sweep multiple times with max hold enabled. When the detector is set to rms the number of points is set to exceed the minimum number required by ANSI C63.26 for average measurements. A peak detector may be used (e.g. to avoid slow sweep times for the narrowband emissions measurements) in lieu of average rms detection as this will provide a more conservative (higher) measured value than the rms value.

RESULTS

Both horizontal / vertical polarizations and low/mid/high channels were investigated on ANT 1 and ANT 4. It was found low channel to be worst case for both antennas.

Date:	4/12/2024
Test Engineer:	31300
Configuration:	EUT + Charger
Mode:	TX
Chamber:	01-RDE-A

Offset Calculation:

Antenna Factor (dB/m)	Amp/Cbl/Filtr/Pad (dB)	EIRP CF	Offset (dB)
28.5	-17.4	11.8	22.9

Plots for Determining Wide Band or Narrow Band Emissions

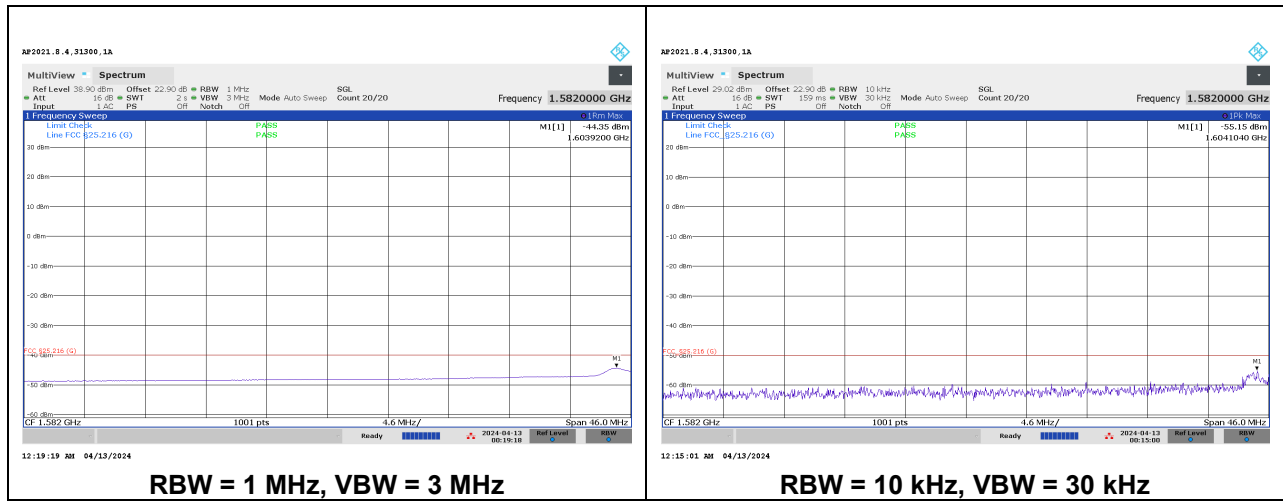

Note: It was found that the Marker 1 @ 1604.931 MHz frequency which belonged to wideband emission.

10.2.1. ANT 1

HORIZONTAL DATA

Wideband Low Channel 1610.17 MHz:

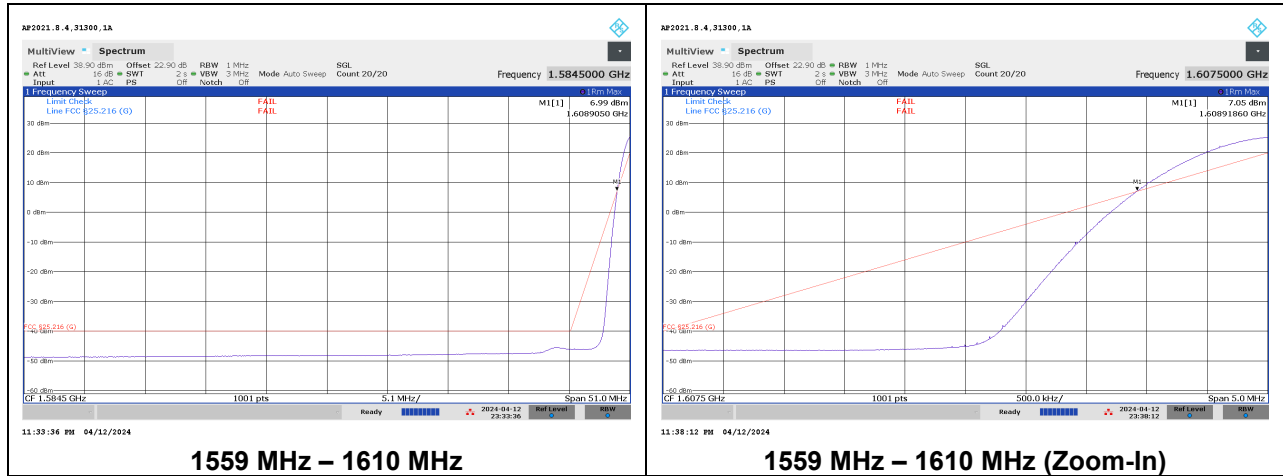

Plots below show passing result using integration method:

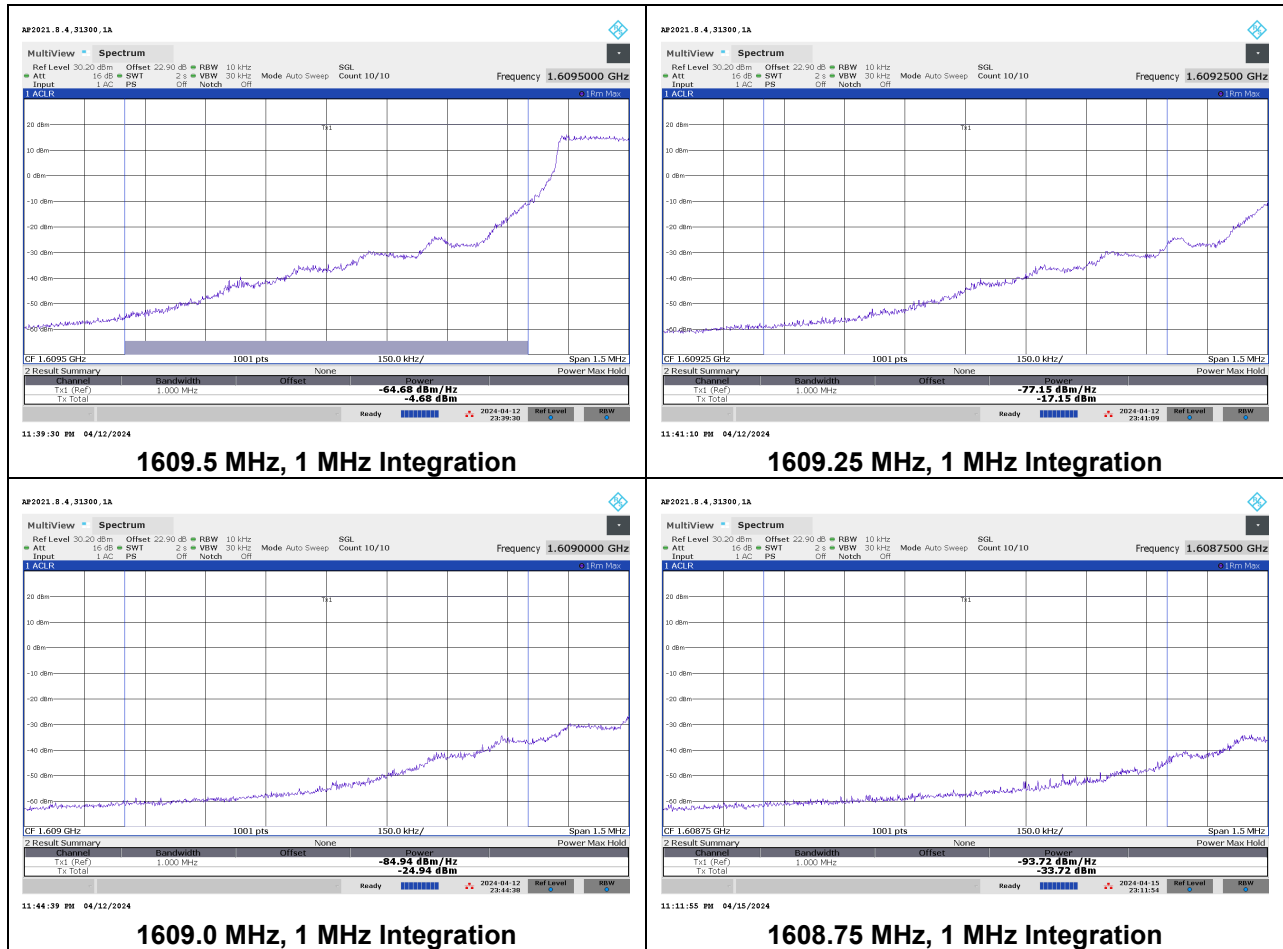

Narrowband Low Channel 1610.17 MHz:

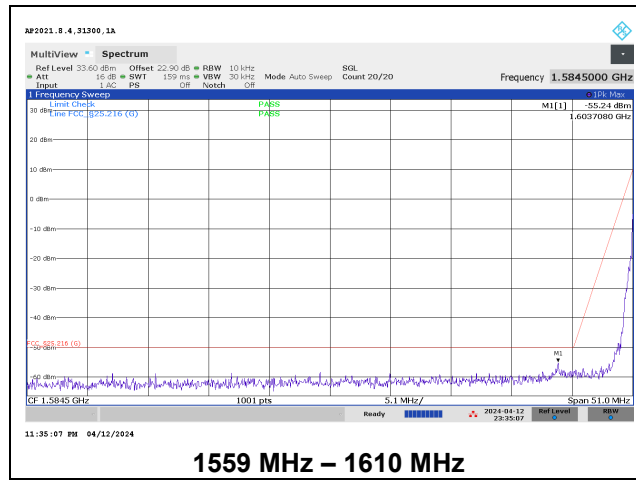

VERTICAL DATA

Wideband Low Channel 1610.17 MHz:

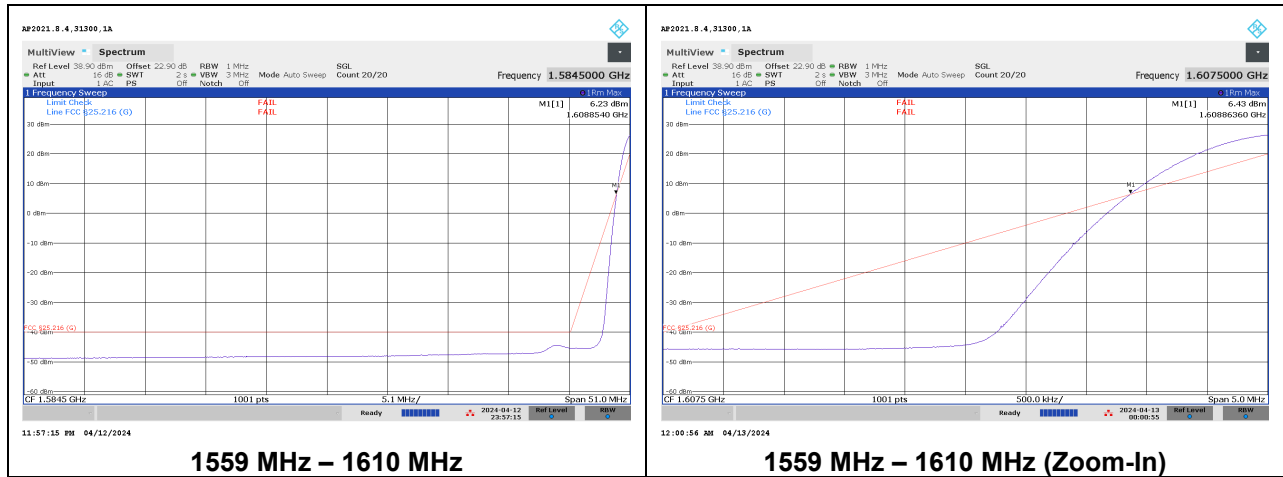

Plots below show passing result using integration method:

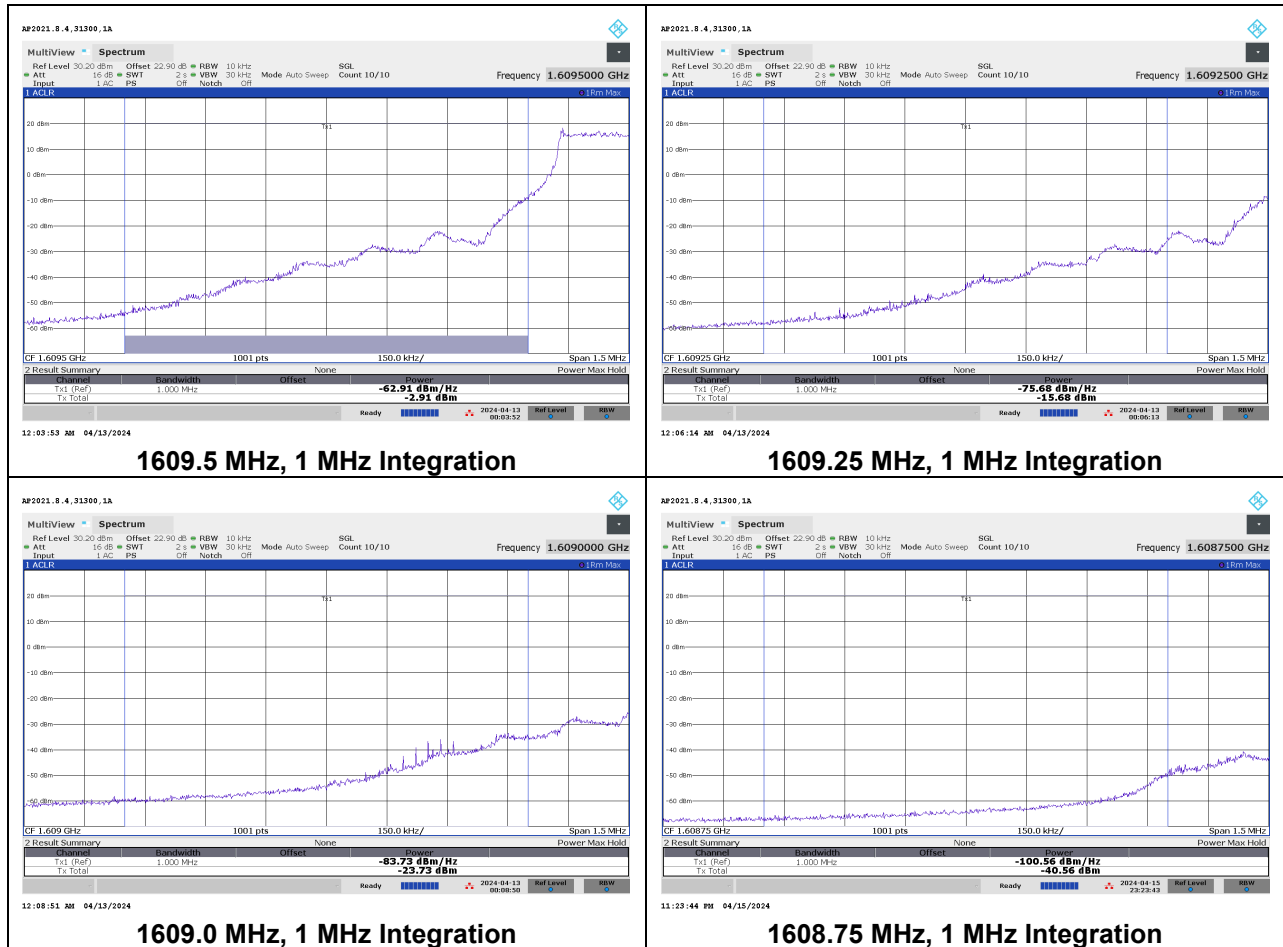

Narrowband Low Channel 1610.17 MHz:

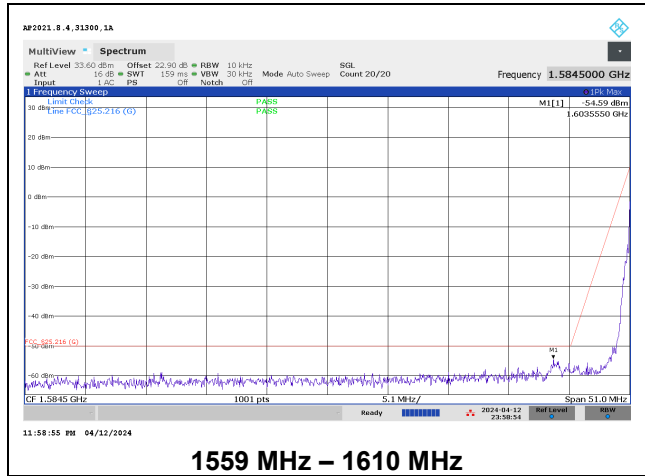

1559 MHz – 1610 MHz

10.2.2. ANT 4

HORIZONTAL DATA

Wideband Low Channel 1610.17 MHz:

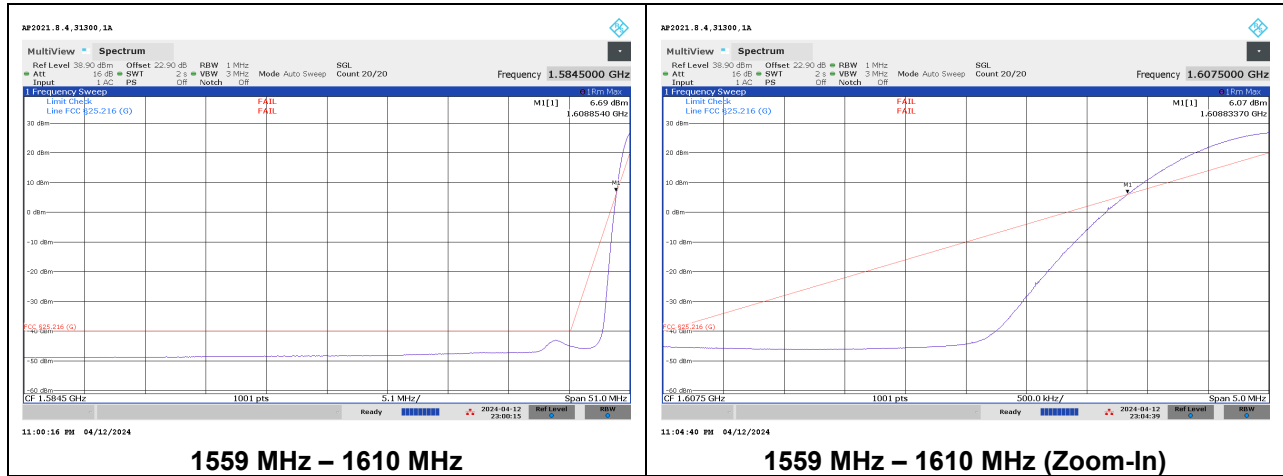

Plots below show passing result using integration method:

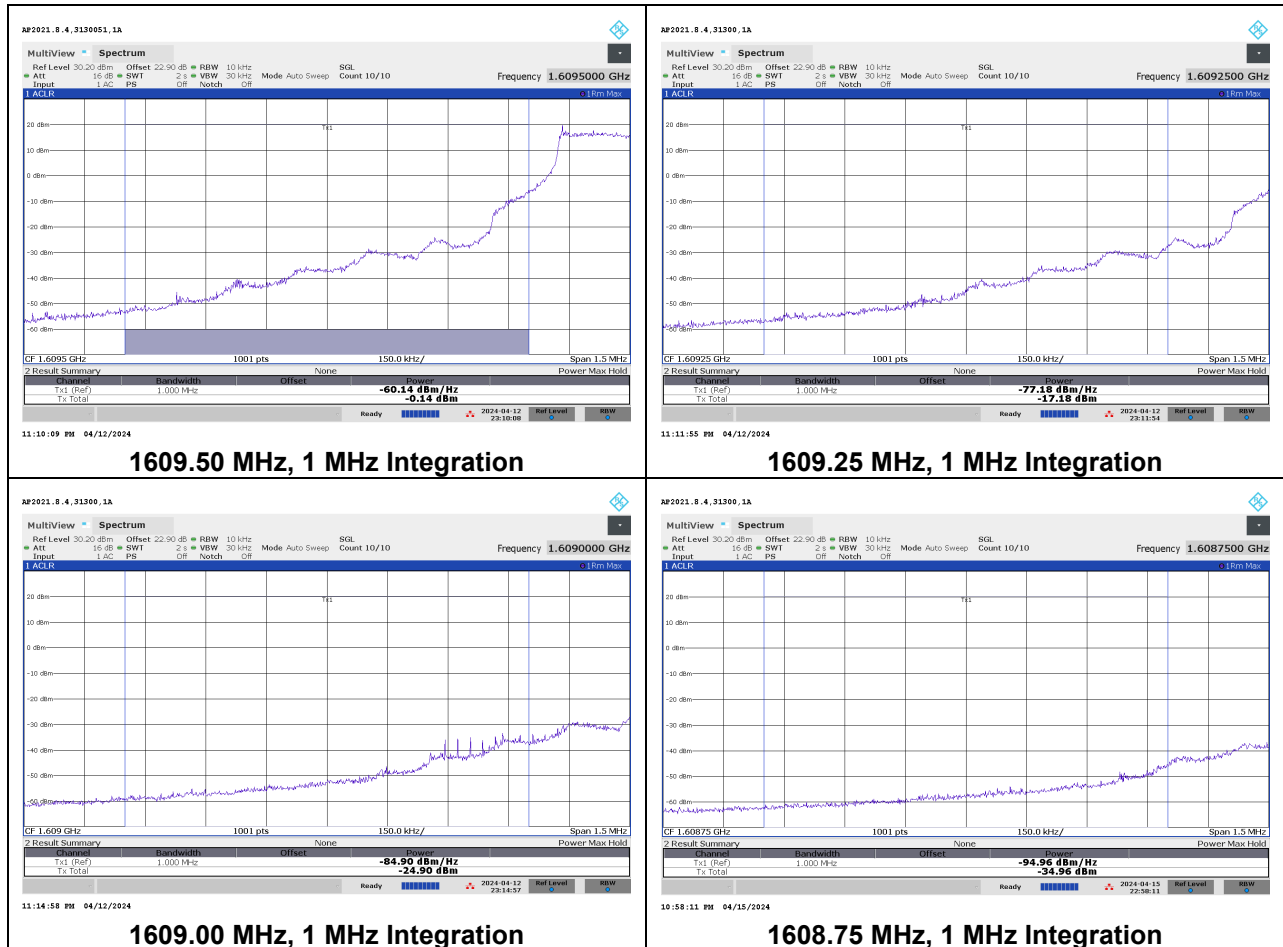

Narrowband Low Channel 1610.17 MHz:

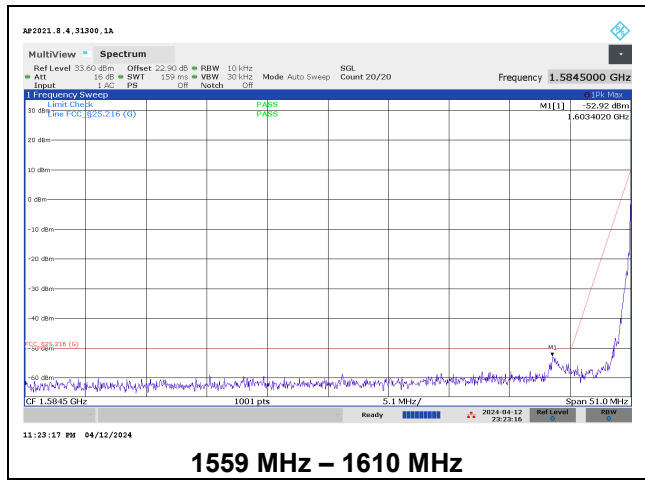

VERTICAL DATA

Wideband Low Channel 1610.17 MHz:

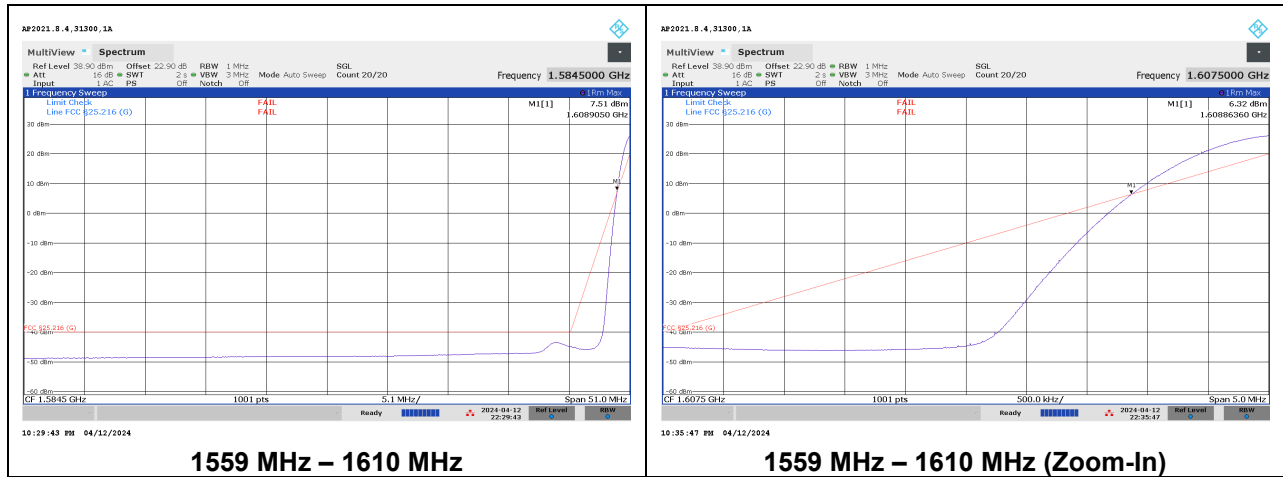

Plots below show passing result using integration method:

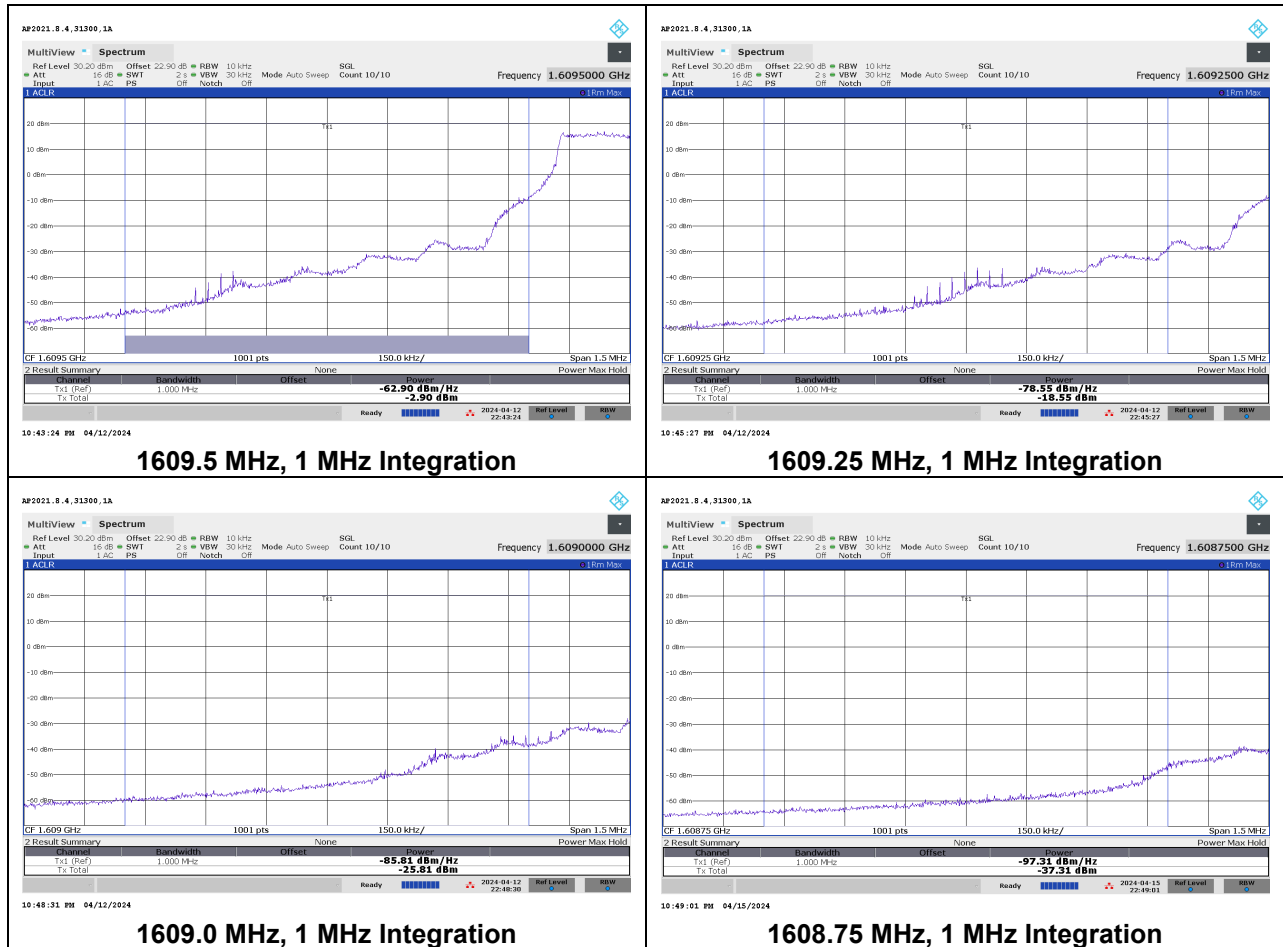

Narrowband Low Channel 1610.17 MHz:

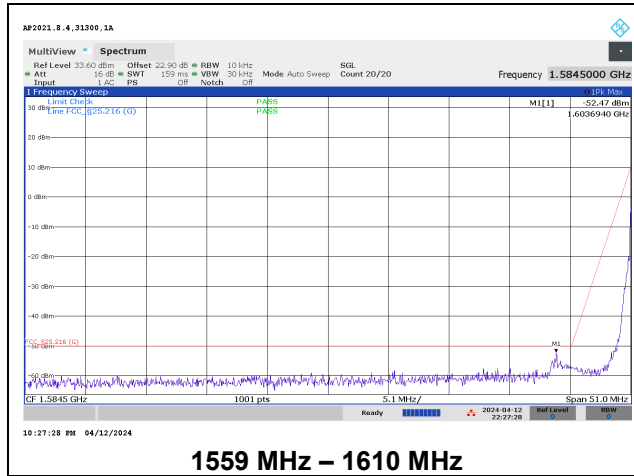

10.3. CARRIER-OFF STATE EMISSIONS (1559 MHz – 1610 MHz)

LIMITS

FCC §25.216 and ISED RSS-170: 5.10

Limits on emissions from mobile earth stations for protection of aeronautical radionavigation-satellite service

(i) The e.i.r.p density of carrier-off state emissions from mobile earth stations manufactured more than six months after Federal Register publication of the rule changes adopted in FCC 03-283 with assigned uplink frequencies between 1 and 3 GHz shall not exceed -80 dBW/MHz in the 1559-1610 MHz band averaged over any two millisecond interval.

ISED RSS-170: 5.4.4 Carrier-off State Emissions

Mobile equipment with transmitting frequencies between 1 GHz and 3 GHz shall have the e.i.r.p. density of carrier-off state emissions in the band 1559-1610 MHz not exceed -80 dBW/MHz.

TEST PROCEDURE

KDB 971168 D01 v03r01/D02 v02/r01

Set RBW = 1MHz, VB = 3MHz, Detector = RMS, Sweep Time = Number of Points x 2ms, and sweep multiple times with Max Hold enabled.

RESULTS

No emissions were found on both horizontal and vertical polarization for ANT 1 and ANT 4.

Date:	2024/08/01
Test Engineer:	31300
Configuration:	EUT + Charger
Mode:	RX (TX Off)
Chamber:	01-RDE-A

10.3.1. ANT 1

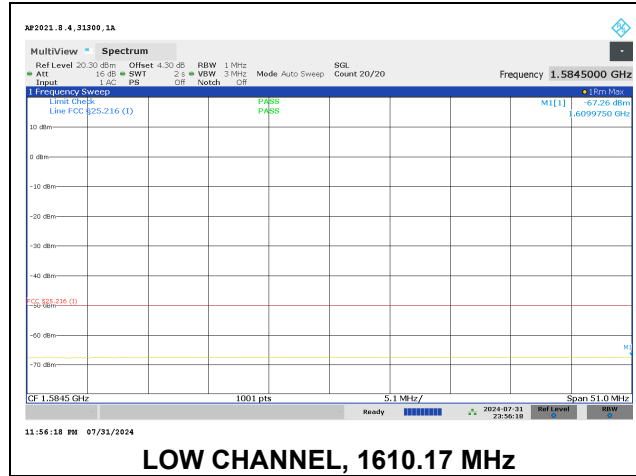

10.3.2. ANT 4

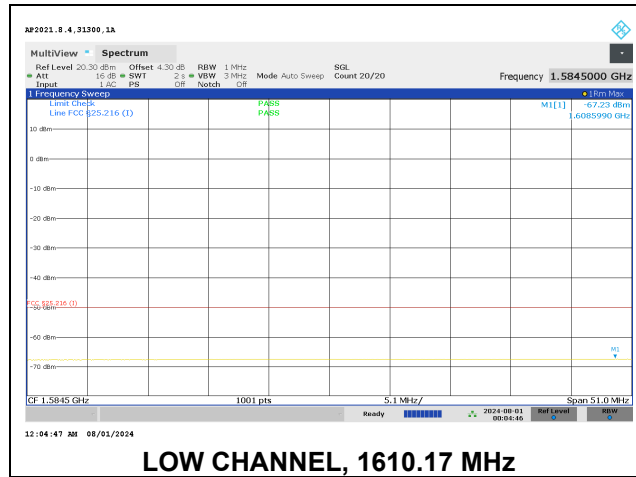

10.4. FREQUENCY STABILITY

LIMITS

FCC §25.202

(d) Frequency tolerance, Earth stations. The carrier frequency of each earth station transmitter authorized in these services shall be maintained within 0.001 percent of the reference frequency.

ISED RSS-170: 5.3

For mobile earth station equipment, the carrier frequency shall not depart from the reference frequency by more than ±10 ppm.

TEST PROCEDURE

Use spectrum with Frequency Error measurement capability.

- Temp. = -30°C to +50°C
- Voltage = (85% - 115%)

Low Voltage = 3.23 VDC; Normal Voltage = 3.8 VDC and High Voltage = 4.37 VDC
 End Voltage = 2.79 VDC

Frequency Stability vs Temperature:

The EUT is placed inside a temperature chamber. The temperature is set to 20°C and allowed to stabilize. After sufficient soak time, the transmitting frequency error is measured. The temperature is increased by 10 degrees, allowed to stabilize and soak, and then the measurement is repeated. This is repeated until +50°C is reached.

Frequency Stability vs Voltage:

The peak frequency error is recorded (worst-case).

RESULTS

Test Engineer:	26118
Test Date:	4/4/2024

Frequency Reference (MHz)		1610.17078		Frequency Reading (MHz)	Delta (Hz)	Frequency Stability (ppm)
Condition		F low @ -10dB BW (MHz)	F high @ -10dB BW (MHz)			
Temperature	Voltage					
Normal (20 C)	Normal	1610.079750	1610.261813	1610.170781		
Extreme (50C)		1610.078688	1610.260625	1610.169656	-1125.0	-0.70
Extreme (40C)		1610.078000	1610.261438	1610.169719	-1062.5	-0.66
Extreme (30C)		1610.078438	1610.260625	1610.169531	-1250.0	-0.78
Extreme (10C)		1610.077563	1610.259375	1610.168469	-2312.5	-1.44
Extreme (0C)		1610.078688	1610.260750	1610.169719	-1062.5	-0.66
Extreme (-10C)		1610.078500	1610.262375	1610.170438	-343.7	-0.21
Extreme (-20C)		1610.078688	1610.260188	1610.169438	-1343.7	-0.83
Extreme (-30C)		1610.077875	1610.261188	1610.169531	-1250.0	-0.78
20C		+15%	1610.077875	1610.260813	1610.169344	-1437.5
	-15%	1610.078438	1610.260625	1610.169531	-1250.0	-0.78
	End Point	1610.077875	1610.260438	1610.169156	-1625.0	-1.01

11. SETUP PHOTOS

Please refer to 14982436-EP1V1 for setup photos.

END OF REPORT