

9.1.12. LTE BAND 66 AND 5G NR n66

LTE BAND 66

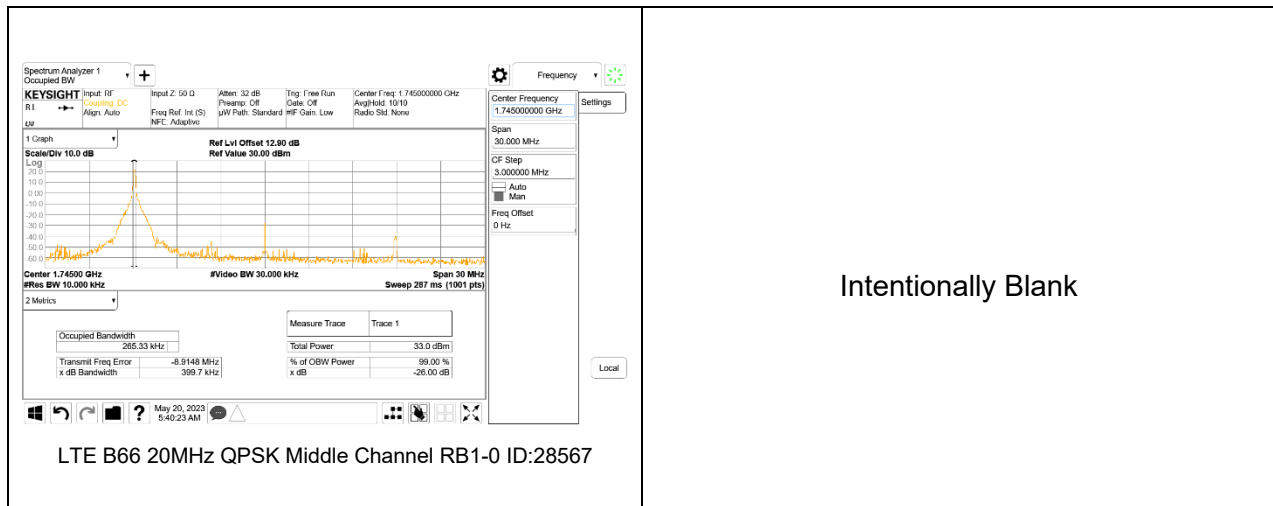



5G NR n66

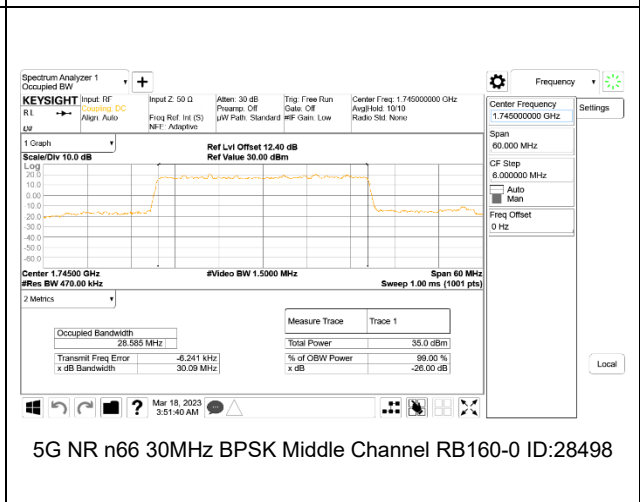
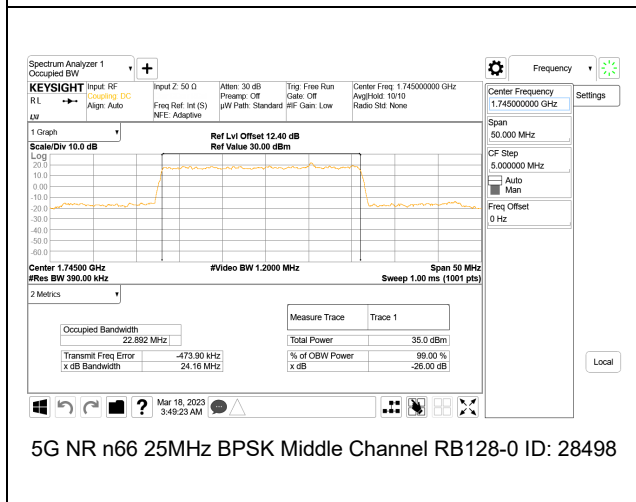
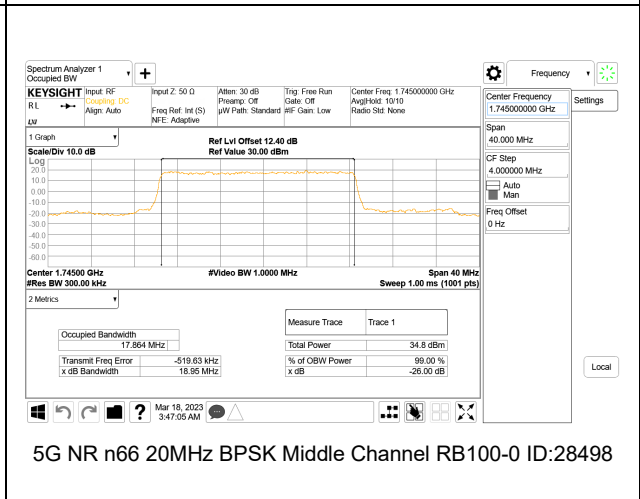
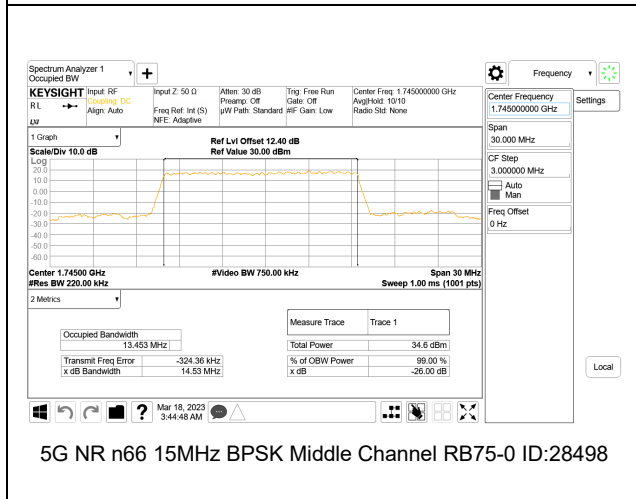
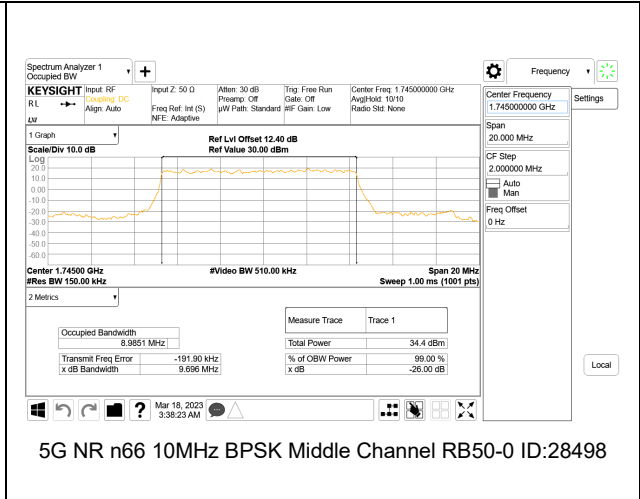
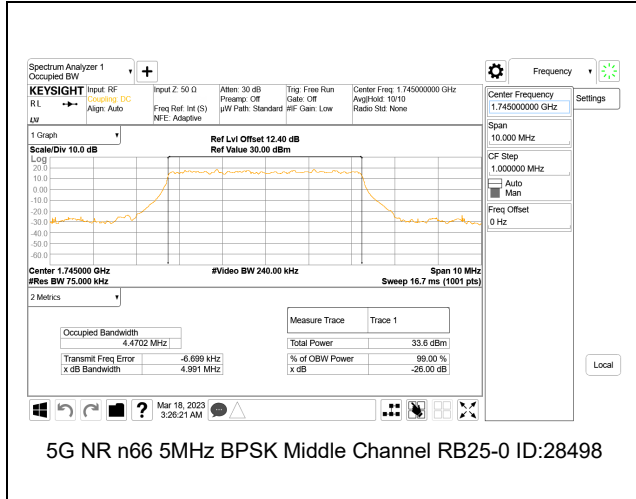

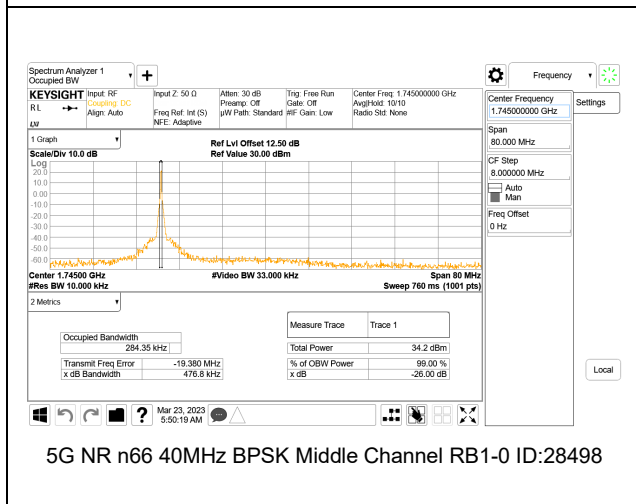
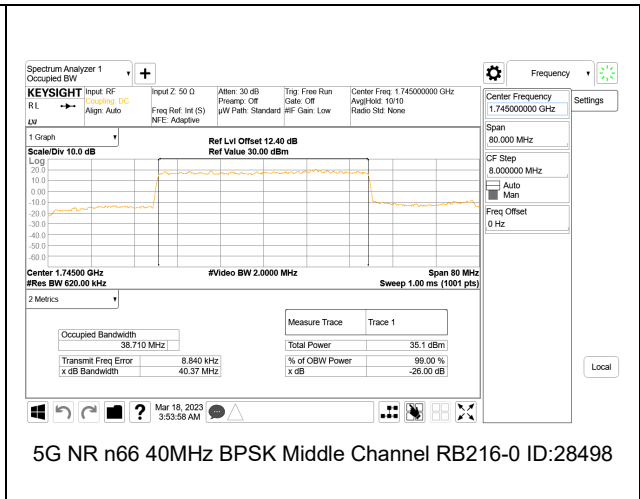
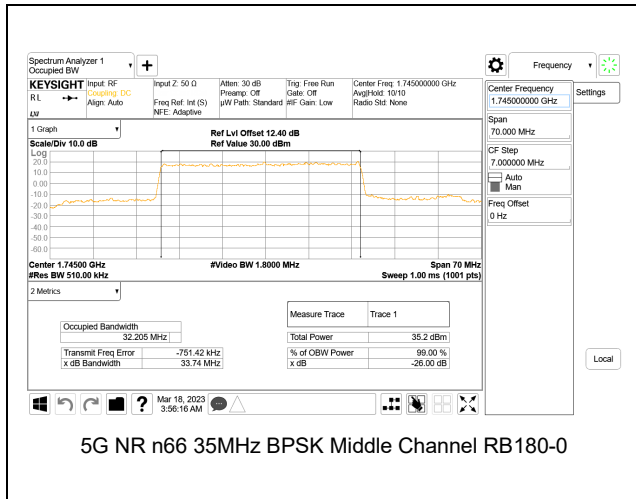

Intentionally Blank

9.1.13. 5G NR n70

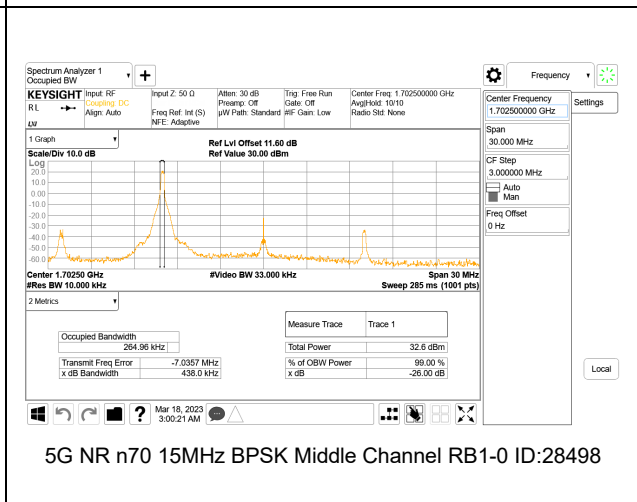
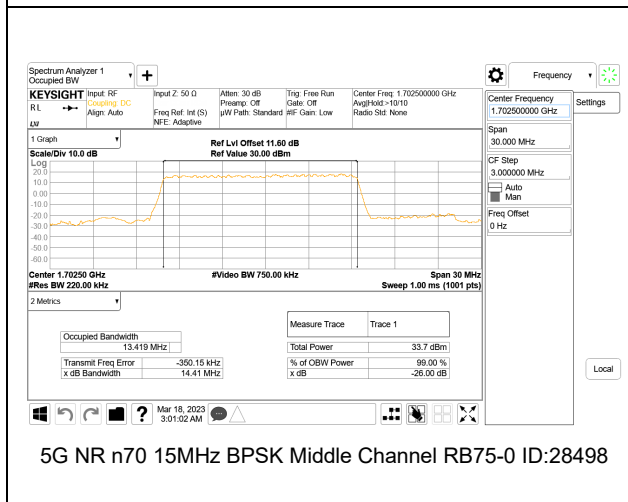
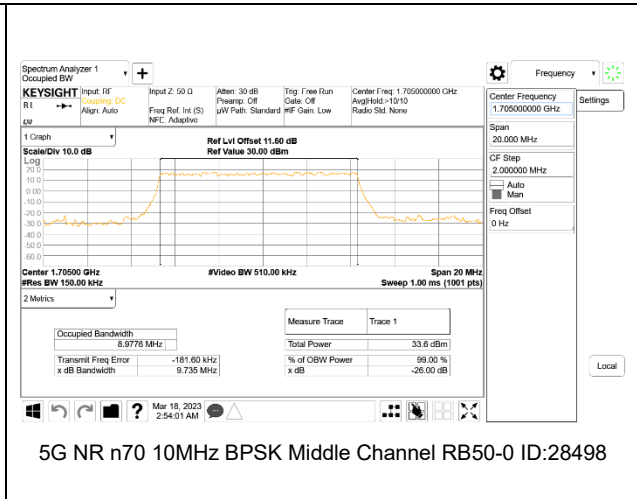
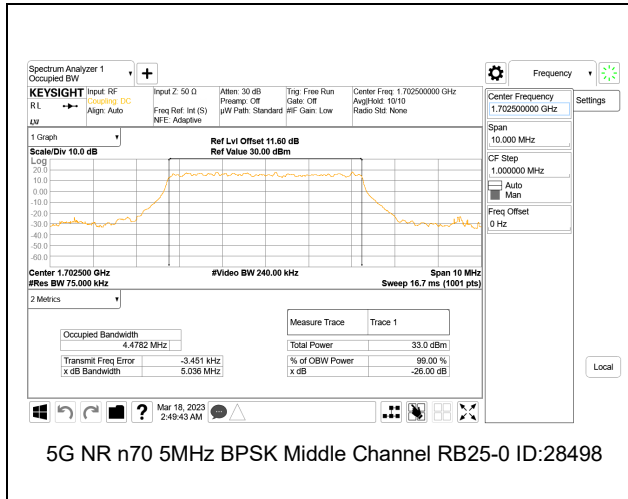

9.1.14. LTE BAND 71 AND 5G NR n71

LTE BAND 71



5G NR n71

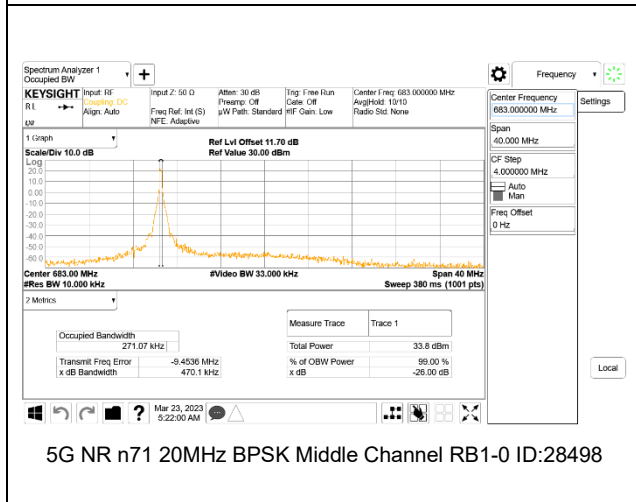
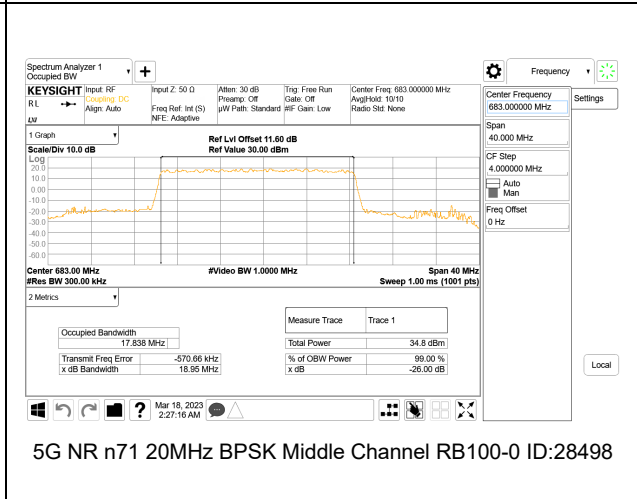
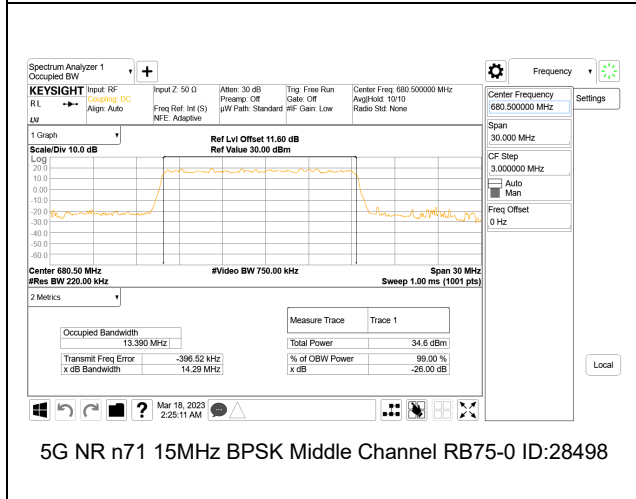
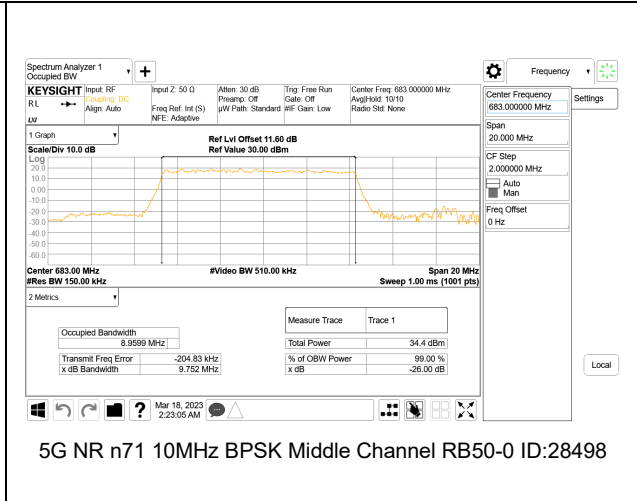
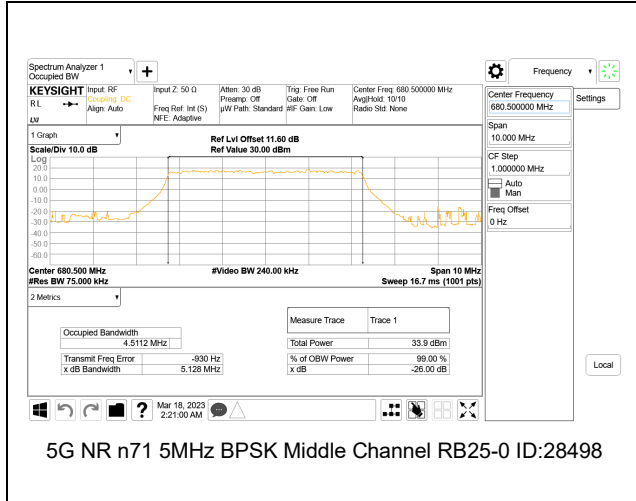

Intentionally Blank

9.1.15. 5G NR n77 (Part 27 3450-3550MHz)

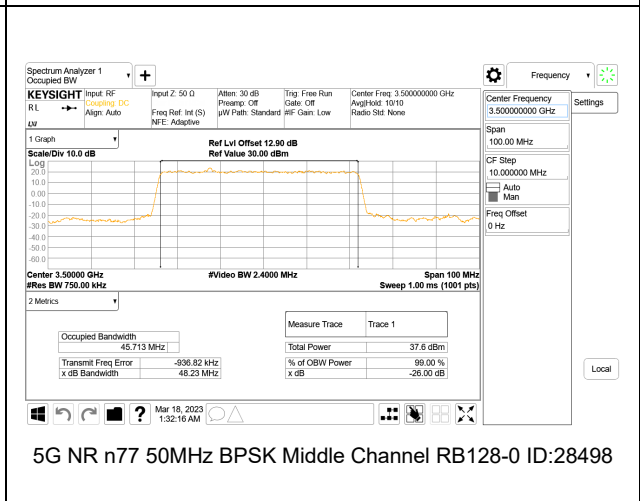
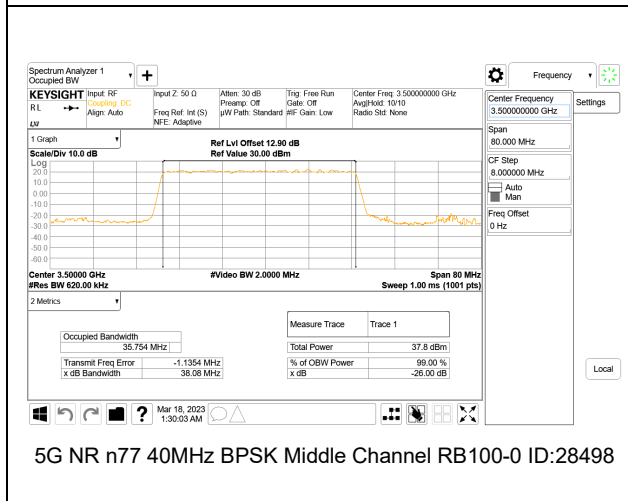
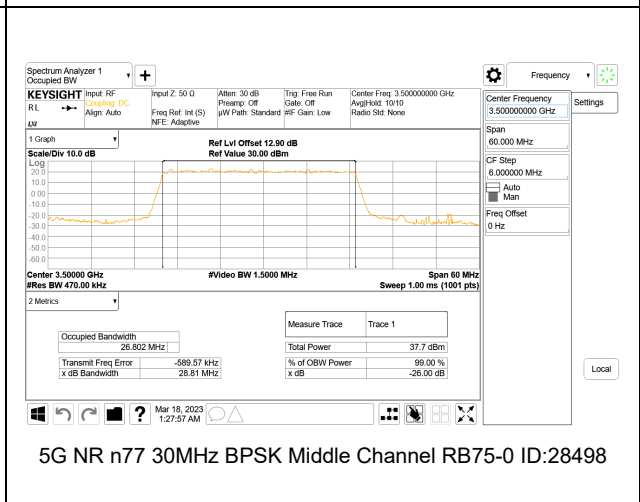
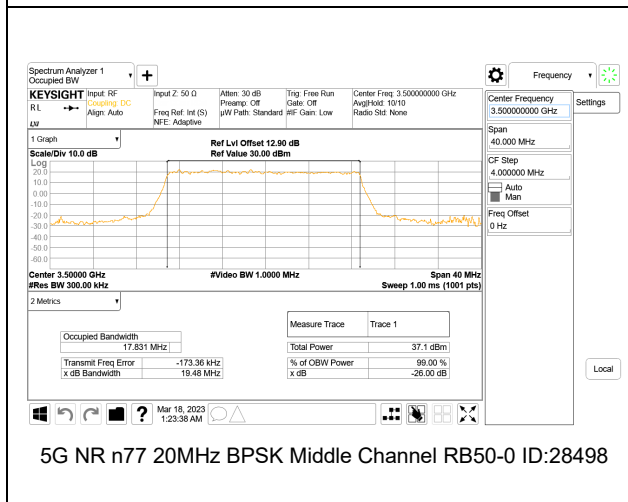
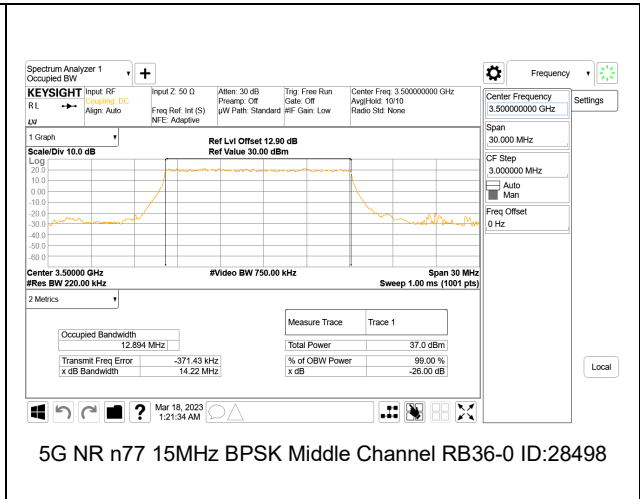
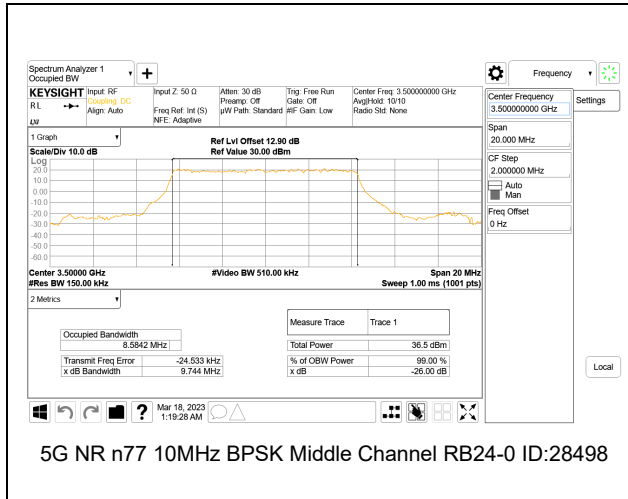

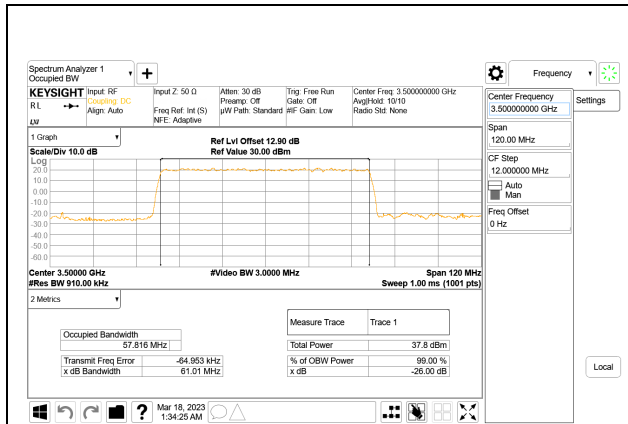

5G NR n77 60MHz BPSK Middle Channel RB162-0 ID:28498

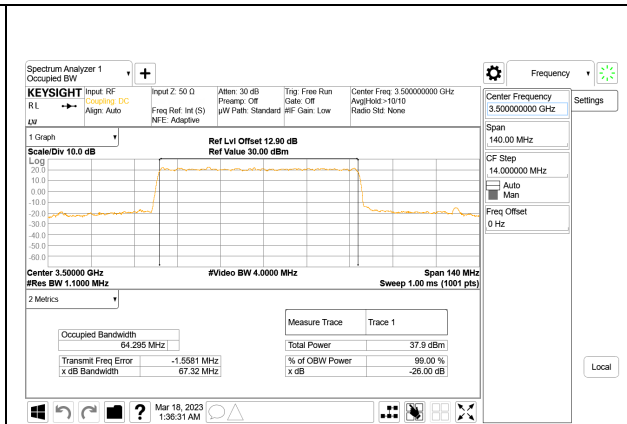

5G NR n77 70MHz BPSK Middle Channel RB180-0 ID:28498

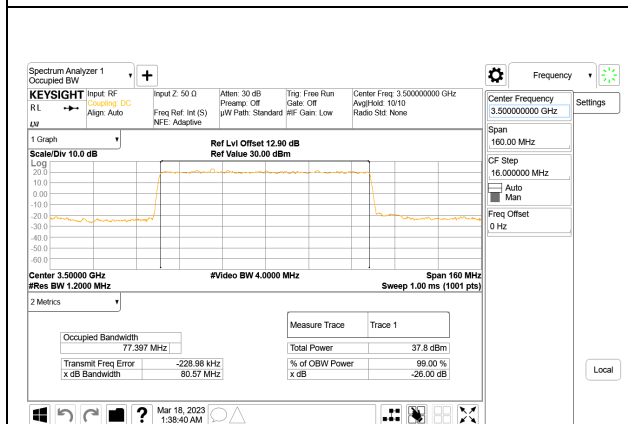

5G NR n77 80MHz BPSK Middle Channel RB216-0 ID:28498

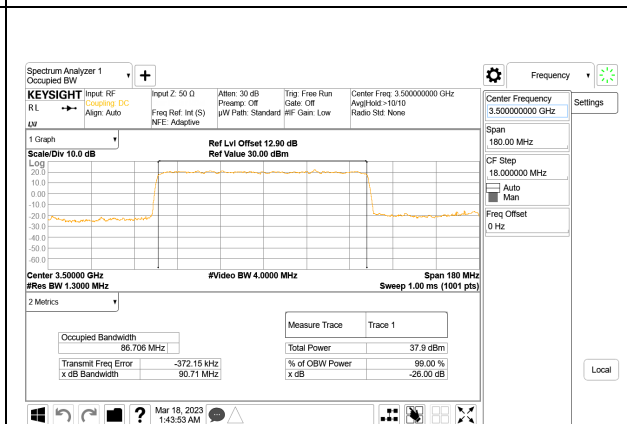

5G NR n77 90MHz BPSK Middle Channel RB243-0 ID:28498

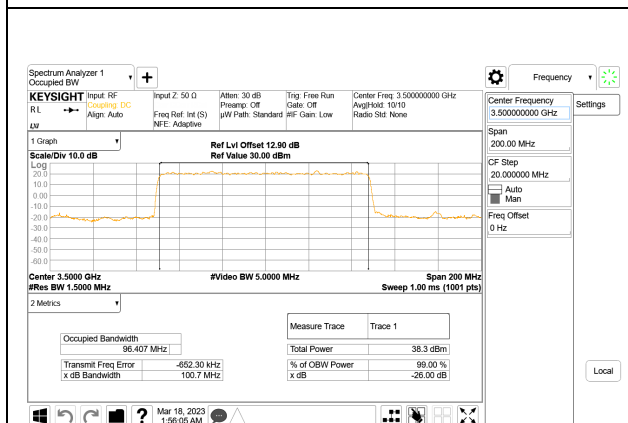

5G NR n77 100MHz BPSK Middle Channel RB270-0 ID:28498

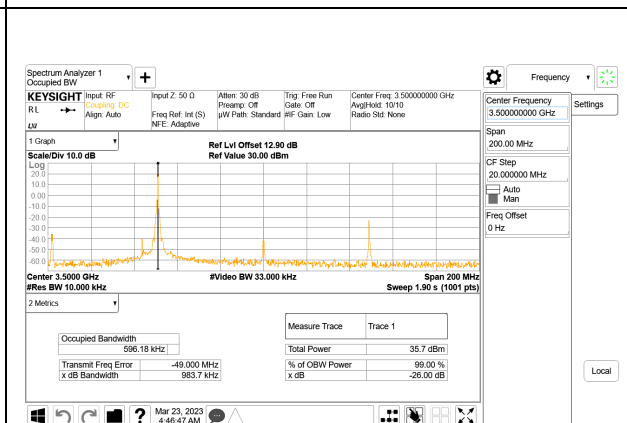

5G NR n77 100MHz BPSK Middle Channel RB1-0 ID:28498

9.1.16. 5G NR n77 (Part 27 3700-3980MHz)

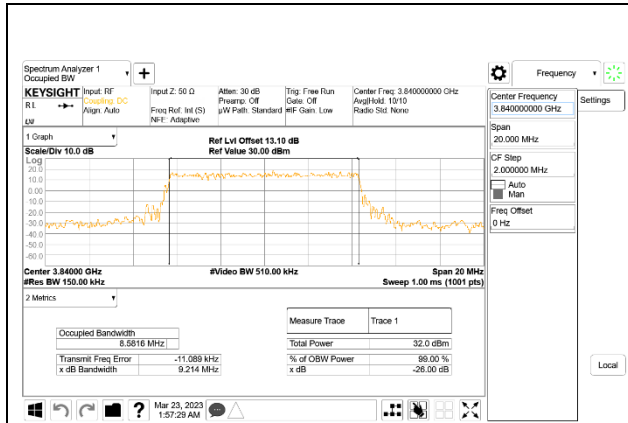

5G NR n77 10MHz BPSK Middle Channel RB24-0 ID:28498

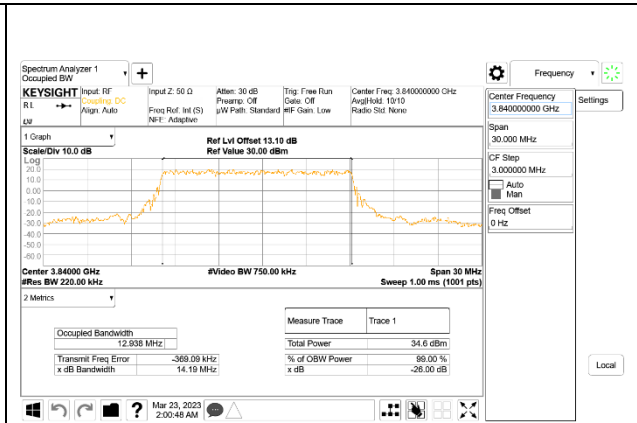

5G NR n77 15MHz BPSK Middle Channel RB36-0 ID:28498

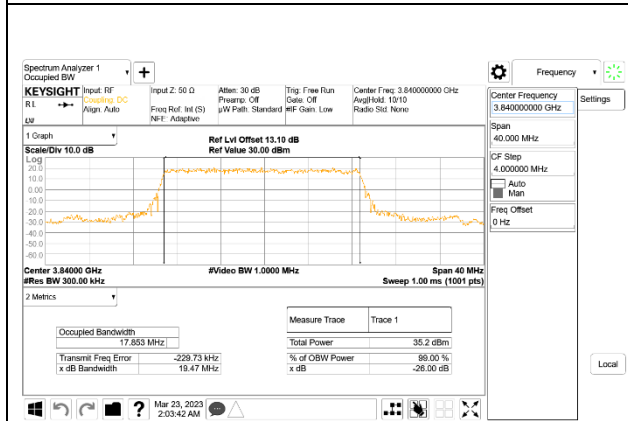

5G NR n77 20MHz BPSK Middle Channel RB50-0 ID:28498

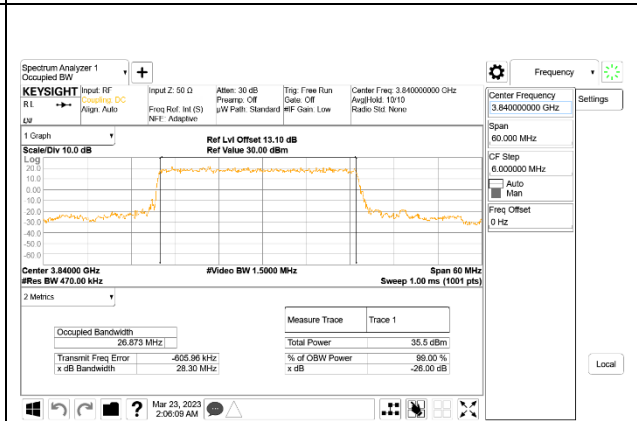

5G NR n77 30MHz BPSK Middle Channel RB75-0 ID:28498

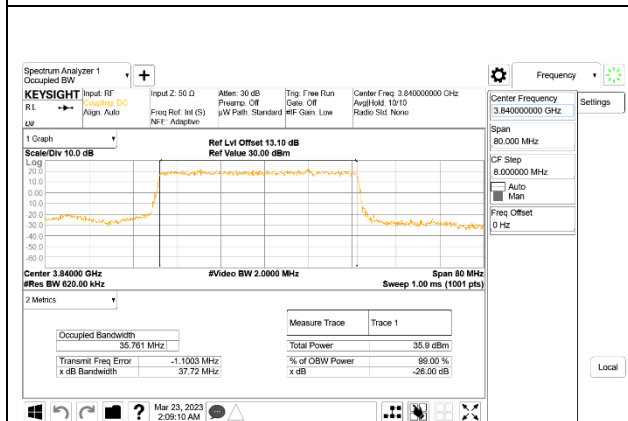

5G NR n77 40MHz BPSK Middle Channel RB100-0 ID:28498

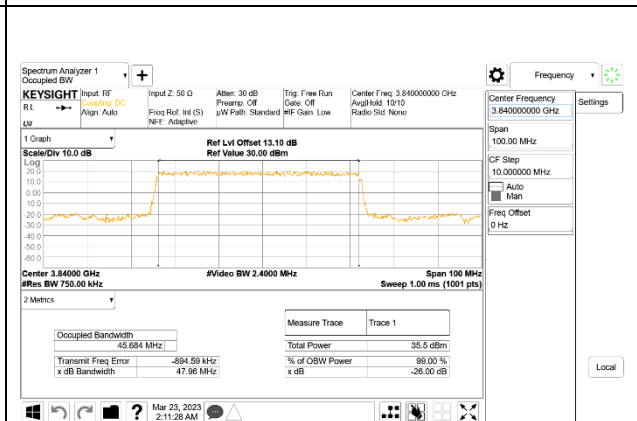

5G NR n77 50MHz BPSK Middle Channel RB128-0 ID:28498

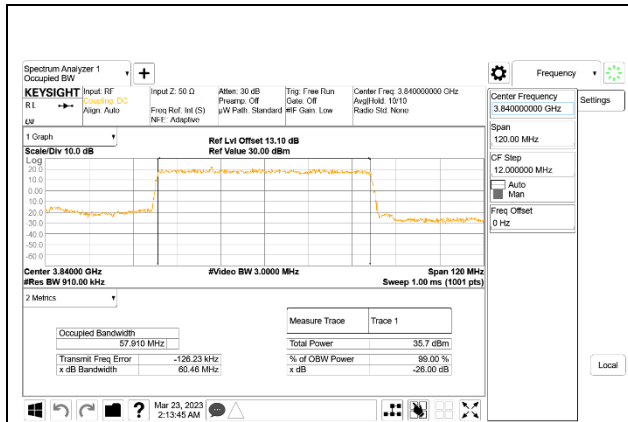

5G NR n77 60MHz BPSK Middle Channel RB162-0 ID:28498

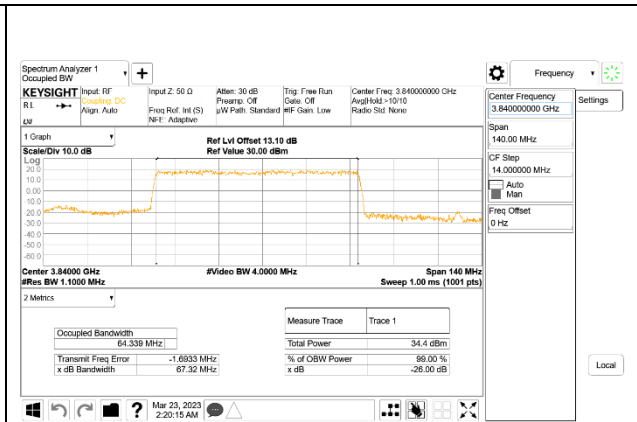

5G NR n77 70MHz BPSK Middle Channel RB180-0 ID:28498

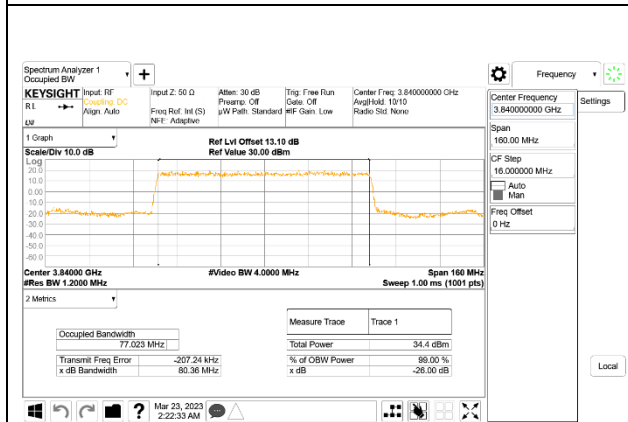

5G NR n77 80MHz BPSK Middle Channel RB216-0 ID:28498

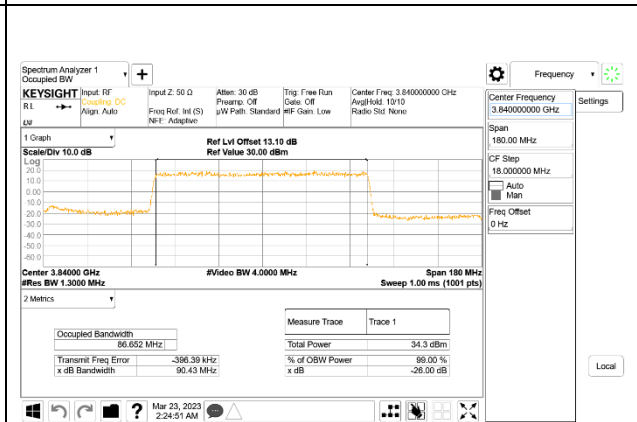

5G NR n77 90MHz BPSK Middle Channel RB243-0 ID:28498

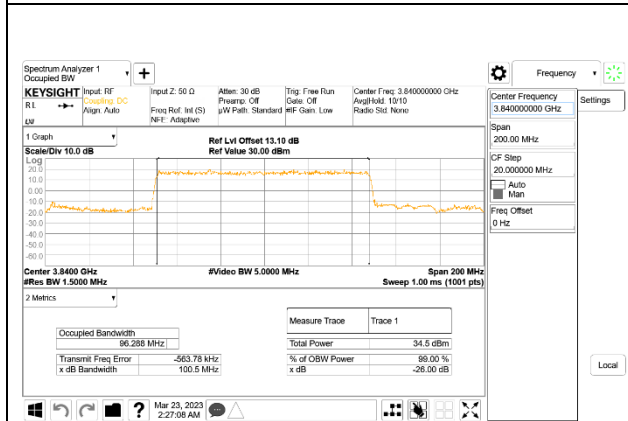

5G NR n77 100MHz BPSK Middle Channel RB270-0 ID:28498

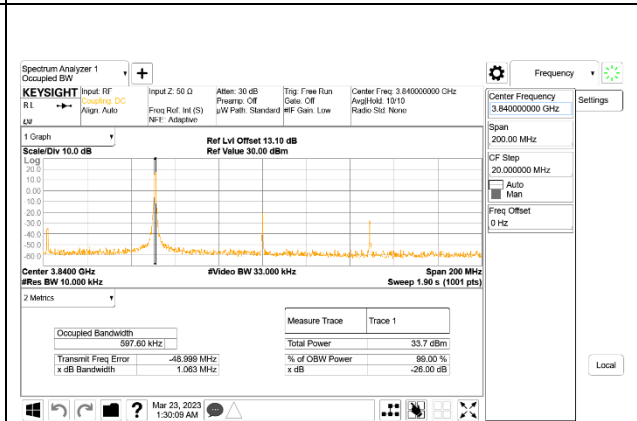

5G NR n77 100MHz BPSK Middle Channel RB1-0 ID:28498

9.2. EMISSION MASK AND ADJACENT CHANNEL POWER

For Spectrum Emission Mask plots, the Keysight PXA N9030A is configured to sweep with a moving integration window, the width of which can be adjusted to different sizes across the sweep. The window width is configured to be greater than or equal to the required reference bandwidth. The center frequencies of the integration window for the different integration windows was set such that the upper and lower edges of the windows are aligned with the transition points in the reference bandwidths. This is achieved by setting the start / stop frequencies of the window with an offset equal to the reference bandwidth / 2 from the transition point.

TEST PROCEDURE

The transmitter output was connected to a CMW500 Test Set and configured to operate at maximum power. The band edge emissions were measured at the required operating frequencies in each band on the Spectrum Analyzer.

For each band edge measurement:

1. Set the spectrum analyzer span to include the block edge frequency.
2. Set a marker to point the corresponding band edge frequency in each test case.
3. Set display line at -13 dBm
4. Set resolution bandwidth to at least 1% of emission bandwidth.

TEST PROCEDURE (FCC LTE BAND 14)

(b) ACP measurement procedure. The following are the procedures for making the transmitter ACP measurements. For all measurements modulate the transmitter as it would be modulated in normal operating conditions. For time division multiple access (TDMA) systems, the measurements are to be made under TDMA operation only during time slots when the transmitter is active. All measurements are made at the transmitter's output port. If a transmitter has an integral antenna, a suitable power coupling device shall be used to couple the RF signal to the measurement instrument. The coupling device shall substantially maintain the proper transmitter load impedance. The ACP measurements may be made with a spectrum analyzer capable of making direct ACP measurements. "Measurement bandwidth", as used for non-swept measurements, implies an instrument that measures the power in many narrow bandwidths equal to the nominal resolution bandwidth and integrates these powers to determine the total power in the specified measurement bandwidth.

(1) Setting reference level. Set transmitter to maximum output power. Using a spectrum analyzer capable of ACP measurements, set the measurement bandwidth to the channel size. For example, for a 6.25 kHz transmitter set the measurement bandwidth to 6.25 kHz. Set the frequency offset of the measurement bandwidth to zero and adjust the center frequency of the instrument to the assigned center frequency to measure the average power level of the transmitter. Record this power level in dBm as the "reference power level."

(2) Non-swept power measurement. Using a spectrum analyzer capable of ACP measurements, set the measurement bandwidth and frequency offset from the assigned center frequency as shown in the tables in §90.543 (a) above. Any value of resolution bandwidth may be used as long as it does not exceed 2 percent of the specified measurement bandwidth. Measure the power level in dBm. These measurements should be made at maximum power. Calculate ACP by subtracting the reference power level measured in (b)(1) from the measurements made in this step. The absolute value of the calculated ACP must be greater than or equal to the absolute value of the ACP given in the table for each condition above.

(3) Swept power measurement. Set a spectrum analyzer to 30 kHz resolution bandwidth, 1 MHz video bandwidth and average, sample, or RMS detection. Set the reference level of the spectrum analyzer to the RMS value of the transmitter power. Sweep above and below the carrier frequency to the limits defined in the tables. Calculate ACP by subtracting the reference power level measured in (b)(1) from the measurements made in this step. The absolute value of the calculated ACP must be greater than or equal to the absolute value of the ACP given in the table for each condition above.

TEST PROCEDURE (FCC LTE BAND 7, 41)

(m)(6) Measurement procedure. Compliance with these rules is based on the use of measurement instrumentation employing a resolution bandwidth of 1 megahertz or greater. However, in the 1 MHz bands immediately outside and adjacent to the frequency block a resolution bandwidth of at least one percent of the emission bandwidth of the fundamental emission of the transmitter may be employed; for mobile digital stations, in the 1 megahertz bands immediately outside and adjacent to the frequency block a resolution bandwidth of at least two percent may be employed, except when the 1 megahertz band is 2495-2496 MHz, in which case a resolution bandwidth of at least one percent may be employed. A narrower resolution bandwidth is permitted in all cases to improve measurement accuracy provided the measured power is integrated over the full required measurement bandwidth (i.e. 1 megahertz or 1 percent of emission bandwidth, as specified; or 1 megahertz or 2 percent for mobile digital stations, except in the band 2495-2496 MHz). The emission bandwidth is defined as the width of the signal between two points, one below the carrier center frequency and one above the carrier center frequency, outside of which all emissions are attenuated at least 26 dB below the transmitter power. With respect to television operations, measurements must be made of the separate visual and aural operating powers at sufficiently frequent intervals to ensure compliance with the rules.

TEST PROCEDURE (FCC LTE BAND 30)

(5) Measurement procedure. Compliance with these rules is based on the use of measurement instrumentation employing a resolution bandwidth of 1 MHz or greater. However, in the 1 MHz bands immediately outside and adjacent to the channel blocks at 2305, 2310, 2315, 2320, 2345, 2350, 2355, and 2360 MHz, a resolution bandwidth of at least 1 percent of the emission bandwidth of the fundamental emission of the transmitter may be employed. A narrower resolution bandwidth is permitted in all cases to improve measurement accuracy provided the measured power is integrated over the full required measurement bandwidth (i.e., 1 MHz). The emission bandwidth is defined as the width of the signal between two points, one below the carrier center frequency and one above the carrier center frequency, outside of which all emissions are attenuated at least 26 dB below the transmitter power.

TEST PROCEDURE (FCC LTE BAND 48, 5G NR n77 FCC Part 96)

(i) Compliance with this provision is based on the use of measurement instrumentation employing a resolution bandwidth of 1 megahertz or greater. However, in the 1 megahertz bands immediately outside and adjacent to the licensee's authorized frequency channel, a resolution bandwidth of no less than one percent of the fundamental emission bandwidth may be employed. A narrower resolution bandwidth is permitted in all cases to improve measurement accuracy provided the measured power is integrated over the full reference bandwidth (i.e., 1 MHz or 1 percent of emission bandwidth, as specified). The emission bandwidth is defined as the width of the signal between two points, one below the carrier center frequency and one above the carrier center frequency, outside of which all emissions are attenuated at least 26 dB below the transmitter power.

(ii) When measuring unwanted emissions to demonstrate compliance with the limits, the CBSD and End User Device nominal carrier frequency/channel shall be adjusted as close to the licensee's authorized frequency block edges, both upper and lower, as the design permits.

(iii) Compliance with emission limits shall be demonstrated using either average (RMS)-detected or peak-detected power measurement techniques.

RESULTS

9.2.1. LTE BAND 7 AND 5G NR n7

FCC: §27.53

(m)(4) For mobile digital stations, the attenuation factor shall be not less than $40 + 10 \log (P)$ dB on all frequencies between the channel edge and 5 megahertz from the channel edge, $43 + 10 \log (P)$ dB on all frequencies between 5 megahertz and X megahertz from the channel edge, and $55 + 10 \log (P)$ dB on all frequencies more than X megahertz from the channel edge, where X is the greater of 6 megahertz or the actual emission bandwidth as defined in paragraph (m)(6) of this section. In addition, the attenuation factor shall not be less than $43 + 10 \log (P)$ dB on all frequencies between 2490.5 MHz and 2496 MHz and $55 + 10 \log (P)$ dB at or below 2490.5 MHz. Mobile Satellite Service licensees operating on frequencies below 2495 MHz may also submit a documented interference complaint against BRS licensees operating on channel BRS Channel 1 on the same terms and conditions as adjacent channel BRS or EBS licensees.

LTE BAND 7 EMISSION MASK

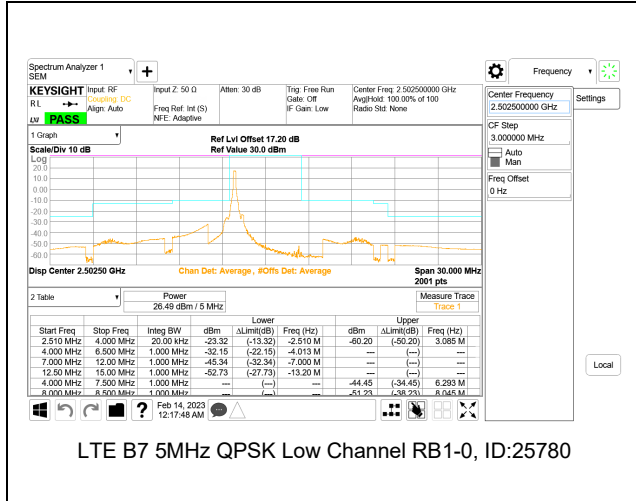

LTE B7 5MHz QPSK Low Channel RB1-0, ID:25780

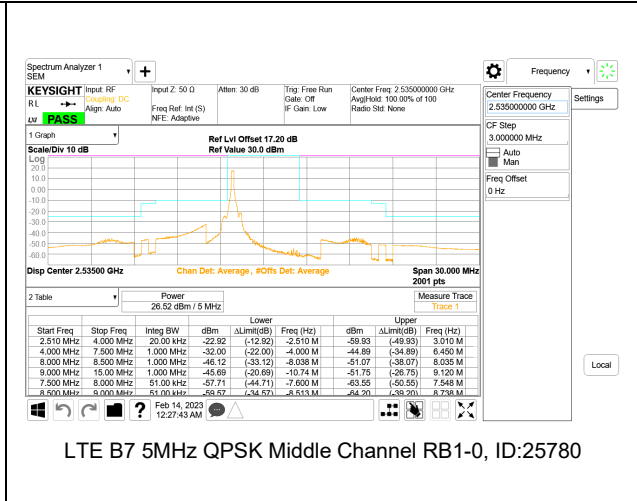

LTE B7 5MHz QPSK Middle Channel RB1-0, ID:25780

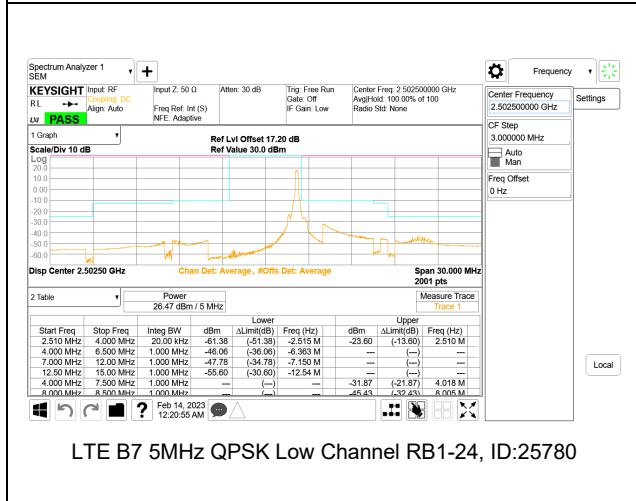

LTE B7 5MHz QPSK Low Channel RB1-24, ID:25780

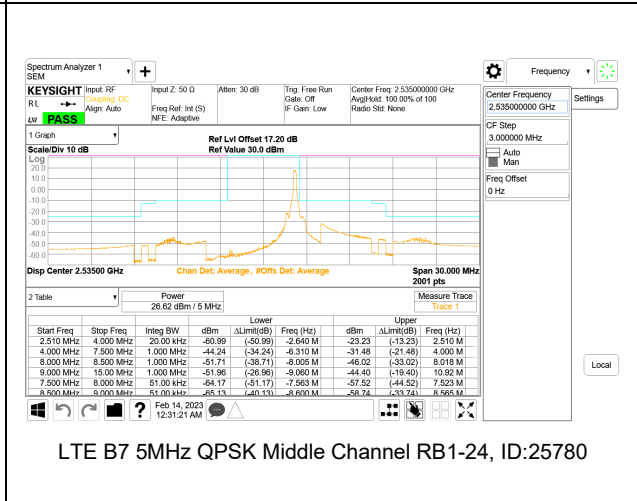

LTE B7 5MHz QPSK Middle Channel RB1-24, ID:25780

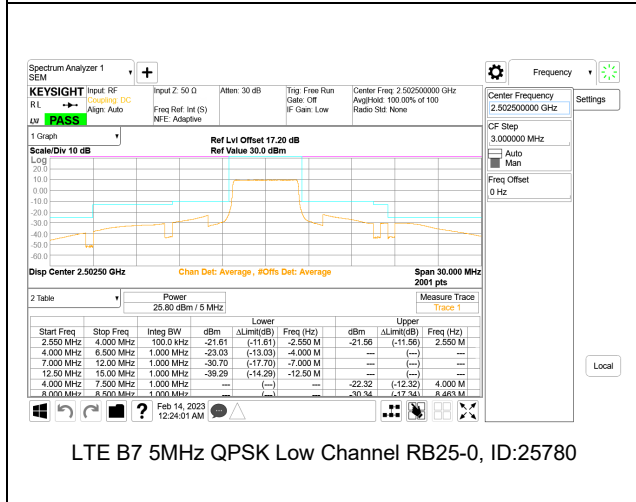

LTE B7 5MHz QPSK Low Channel RB25-0, ID:25780

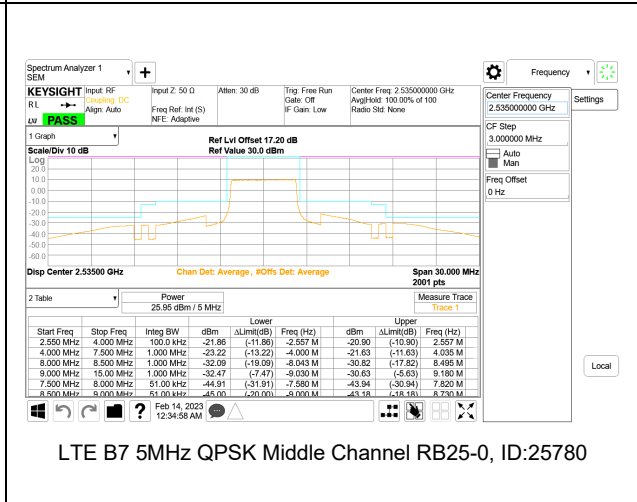

LTE B7 5MHz QPSK Middle Channel RB25-0, ID:25780