

Thank you

Thank you for purchasing the Jabra M5390 Multiuse headset.

The Jabra M5390 Multiuse Headset is supplied together with the Jabra A335w Dongle and the Jabra M5390 Multiuse Base. This unique combination allows you to use one single headset for all your communication needs. The Jabra M5390 Multiuse headset connects simultaneously to mobile phones and desk phones - or to mobile phones and PC softphones.

The headset base and the headset are used together with your desk phone.

The dongle allows the headset to communicate with a softphone such as Microsoft Office Communicator, Skype or Cisco IP Communicator, etc. through your PC or laptop. The headset can also be connected directly to your Bluetooth®-enabled cell phone.

Furthermore, the headset and dongle have been optimized for the new wideband technology and are compliant to the TIA-920 specifications that ensure clear and crisp voice reception and transmission (wideband is only supported between the dongle and the headset).

Contents

1.	Overview	2
2.	Fitting the headset	3
3.	Setting up your desk phone	4
4.	Setting up your cell phone.	7
5.	Making a call from your desk phone	8
6.	Answering a call from your desk phone	9
7.	Making and answering a call from your cell phone	10
8.	Features	12
9.	Reset/Pairing	15
10.	Using the Jabra M5390 Multiuse Headset with multiple Bluetooth®-enabled devices	16
11.	Operating devices in multiuse scenarios	16
12.	Switching between Base and Jabra A335w Dongle in a multiuse scenario	17
13.	Troubleshooting & FAQ	17
14.	Maintenance, safety and disposal	18
15.	Appendix – GN 1000 Remote Handset Lifter (RHL) (optional accessory)	19

1. Overview

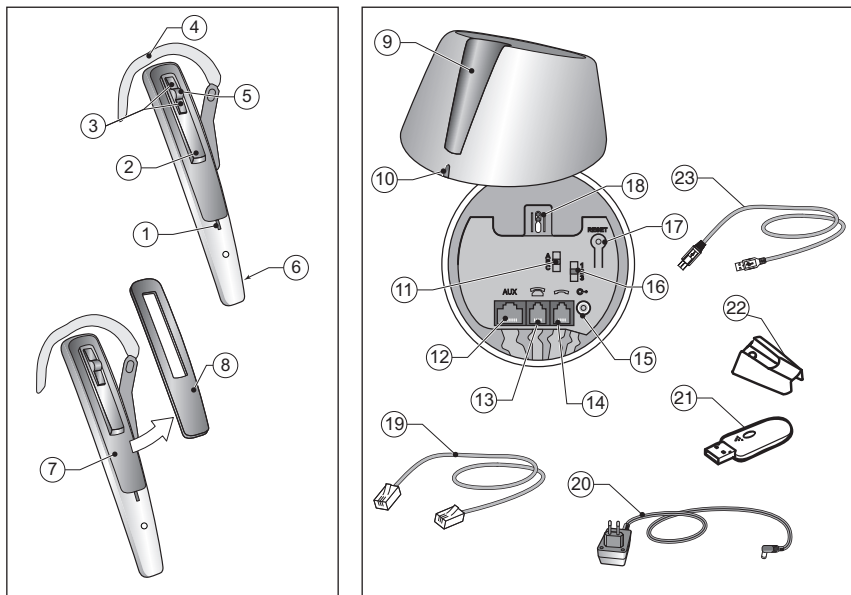
**Headset**

- [1] Visual indicator
- [2] Answer/End button
- [3] Volume up/down
- [4] Ear hook
- [5] Mute button
- [6] Microphone
- [7] Reset button
- [8] Snap-on cover (replaceable)

Base unit

- [9] Charge cradle
- [10] Visual indicator
- [11] Clear dial tone switch
- [12] AUX port
- [13] Telephone port
- [14] Handset port
- [15] AC power adapter port
- [16] Transmit volume
- [17] Reset button
- [18] Headset switch

Cords & adapters

- [19] Connection cord
- [20] AC power adapter
- [21] Dongle
- [22] Travel charger
- [23] USB cable for travel charger

Definition of "Tap, double tap and press":

Tap = Press the button for up to 0.8 sec.

Press = Press a button for longer than 0.8 sec, and release before 1.5 sec. Listen for a tone.

Double tap = Two taps made within 0.5 sec.

2. Fitting the headset

2.1

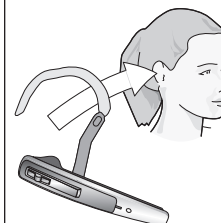

2.2

**Fitting to the headset to your ear**

2.1 Open the hinged ear hook as wide as possible. ¹⁾

2.2 Hold the headset to your ear so that the speaker fits comfortably and the microphone points towards your mouth.

2.3

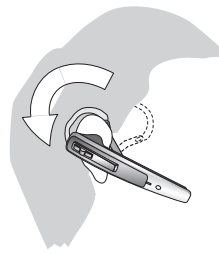

2.4

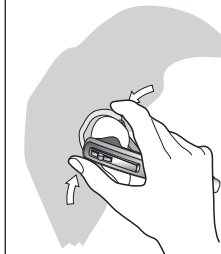

2.3 Close the hinged ear hook around your ear.

2.4 Adjust the ear hook for a comfortable fit.

2.5

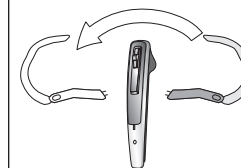
**Fitting the headset to your left ear**

2.5 Pull the ear hook hinge from the slot and insert it on the opposite side of the headset into the slot marked with L. Perform steps 2.1 - 2.4 above.

1) Note: The headset is configured by default for use with the right ear.

3. Setting up your desk phone

3.1

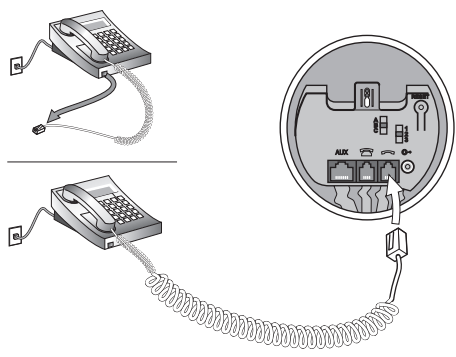



If your telephone has a headset port, go directly to 3.2b.

3.1 Unplug the handset cord from your telephone and connect it to the port on the base unit marked with .

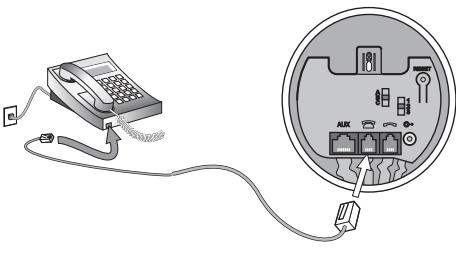
3.2



3.2a Connect the enclosed telephone cord to the now empty handset port on the telephone, and to the port on the base unit marked with .

3.2b (Only for use on phones with a headset port) Connect the enclosed telephone cord to the headset port on telephone, and to the port on base unit marked with .

3.3

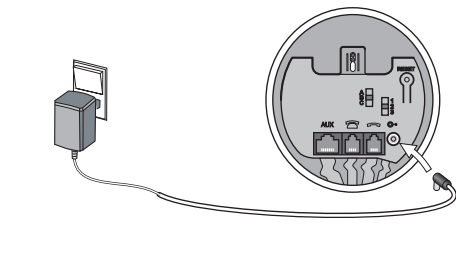

3.3 Connect the AC power adapter to the port on the bottom of base unit, then plug the adapter into the AC power outlet. If the headset power supply is disconnected, the indicator on the base will flash green.

3.4

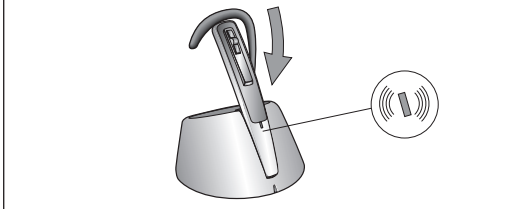

3.4 Place the headset in the charge cradle and **charge for a minimum of 30 min. before use**. A full charge takes about 2 hours. The visual indicator on the headset will flash green while headset is charging, and the light will remain steady green when fully charged. The same procedure is to be followed when using the travel charger.

3.5



3.5 Turn the headset on by pressing the Answer/End button for 1 sec. (the visual indicator will flash blue four times and headset will beep three times), or by placing headset in charge cradle. Turn the headset off by pressing the Answer/End button for 2 sec. (visual indicator will flash blue four times and headset will beep three times).

3.6



Clear dial tone

3.6 Take the headset out of charge cradle and put it on.

3.7

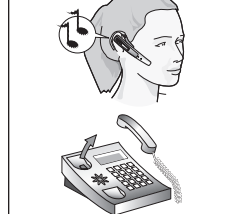

3.7 Pick up the telephone handset and listen for a dial tone through the headset.

3.8

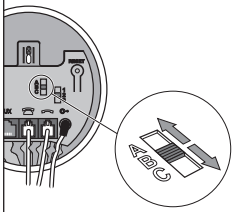

3.8 If dial tone is missing or unclear, slowly slide the clear dial tone switch on bottom of base unit through the 3 settings.

3.9

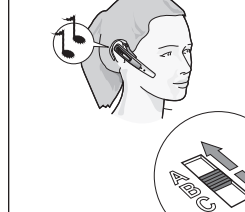

3.9 Set the switch to the position that gives the clearest dial tone.

Note: The AUX port is used for Remote Handset Lifter (RHL). Please refer to the Appendix.

3.10

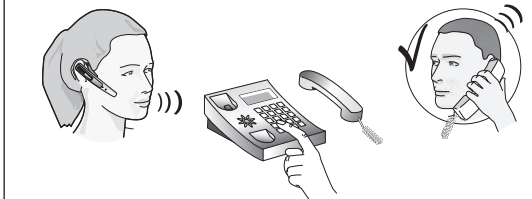

Setting the outgoing volume

3.10 Make a call (see section 4) to someone who can act as a test person.

3.11

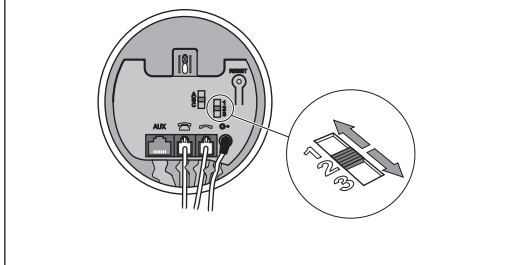

3.11 Adjust the outgoing volume using the transmit volume control on the base unit. Move the switch through the 3 settings until test person confirms the appropriate volume. ¹⁾

3.12

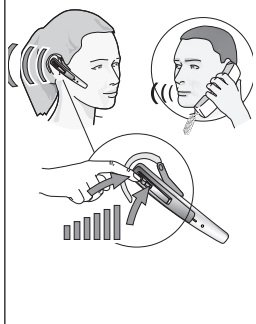

Setting the incoming volume

3.12 During a call, adjust incoming volume by pressing the Volume button on the headset.

3.13

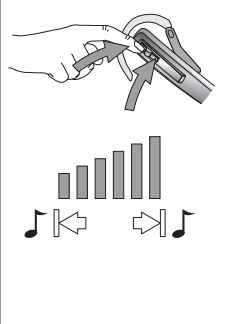

3.13 A tone will be heard to indicate when min./max. volume is reached.

¹⁾ **Note:** If you can hear your own voice, the outgoing volume is probably too high. Reduce the volume setting on your desk phone (if the feature is available) and compensate by increasing the volume on your headset.

4. Setting up your cell phone

Setup

Pairing your headset with your cell phone

NOTE: Before use, please charge your headset (see 3.4).

Before using your Jabra M5390 Multiuse headset with a cell phone, you need to pair it with your cell phone.

- Make sure the headset is off.
- During start-up keep pressing the Answer/End button for three seconds. Alternatively remove the snap-on cover and press the reset button on the headset for three seconds. The visual indicator on the headset will turn to steady blue. (see 9.1)
- Instruct your phone's Bluetooth® to 'discover' the Jabra M5390 Multiuse headset:
 - Follow the instructions in your phone's User Manual. This usually involves going to a 'setup,' 'connect' or 'Bluetooth' menu on your phone and selecting the option to 'discover' or 'add' a Bluetooth® device.
 - Your phone will find the Jabra M5390 Multiuse headset and ask if you want to pair with it.
- Accept pairing by pressing Yes/OK (or similar) on the phone and confirm with the passkey or PIN '0000' (4 zeros).
- Your phone will confirm when pairing is complete. If pairing is unsuccessful, repeat the steps above. Some cell phones require a manual connection to be established after pairing. Note that on some cell phones, the headset has to be set as "Trusted device".

NOTE: If you accidentally put the headset into pairing mode, tap the Answer/End button to exit pairing mode.

! **IMPORTANT:** The same headset can be paired with multiple cell phones. However, if you have multiple cell phones paired, switched on and within range of the headset, the headset will not be able to connect to the base. It is only possible to be connected to one cell phone and the headset base at a time. To be able to connect to the headset base, only have one paired cell phone may be turned on and within range of the headset.

5. Making a call from your desk phone

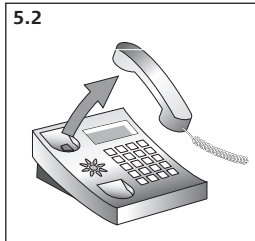
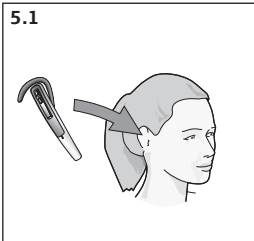

5.1 Put on headset. ¹⁾

5.2 Lift the handset from cradle, or press the telephone's "line" button if the base is connected directly to the telephone's headset port. Then tap the Answer/End button to transfer the call to the headset.

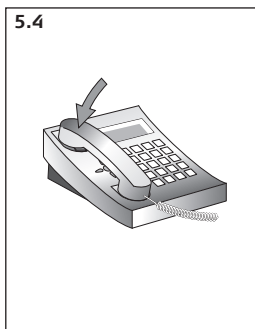

5.3 Wait for a dial tone, then the dial number.

5.4 To end the call, tap the Answer/End button on the headset and replace the handset in the cradle, or press the telephone's "end call" button if the base is connected directly to the telephone's headset port.

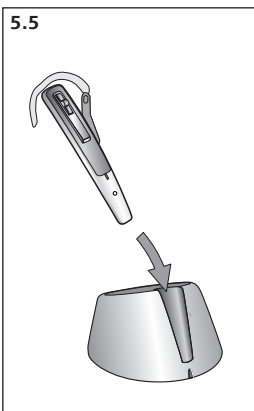

Making a call with your handset

5.5 Place the headset in charge cradle.

5.6 Use the handset as usual.

¹⁾ **Note:** When making a call using the telephone handset, make sure the headset is placed in charge cradle. Otherwise, the call will be routed through to the headset.

6. Answering a call from your desk phone

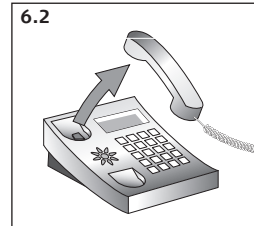
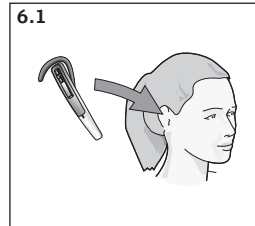

6.1 Put on headset. ¹⁾

6.2 Lift the handset from cradle, or press the telephone's "line" button if the base is connected directly to the telephone's headset port. Then tap the Answer/End button to transfer the call to the headset.



6.3 To end the call, tap the Answer/End button on the headset and replace the handset in the cradle, or press the telephone's "end call" button if the base is connected directly to the telephone's headset port.

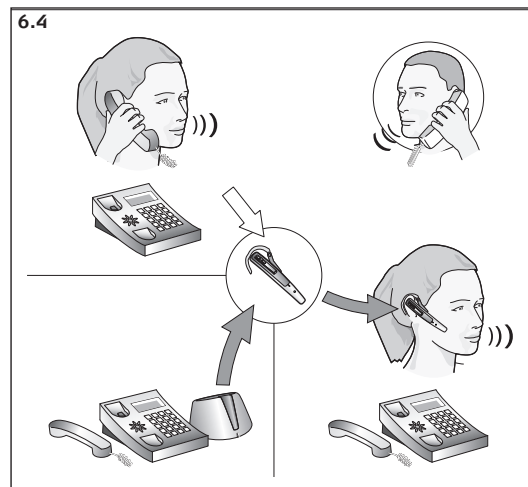

Switching from your phone's handset to the headset

6.4 During a call using the telephone handset, take the headset from the charge cradle. Tap the Answer/End button and the call will automatically be routed to the headset. ¹⁾

6.5

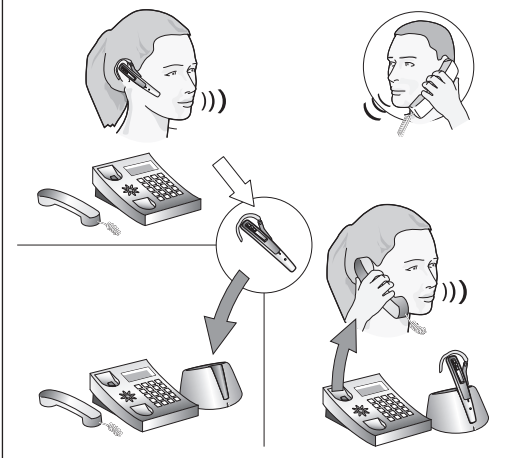

Switching from the headset to the telephone's handset

6.5 During a call using the headset, pick up the telephone handset and replace the headset in charge cradle. The call will not be routed through to the telephone handset until after the headset is in the charge cradle.

1) **Important:** Do not hang up the handset as this will disconnect the call.

7. Making and answering a call from your cell phone

Making and ending a cell phone call

- When you make a call from your cell phone, the call will transfer to your headset automatically (this is subject to your phone's settings, see your cell phone's User Manual to find out how to activate this feature).

If your phone does not allow this feature, see your cell phone's User Manual for details on how to answer a call with a headset.

- To end a call, tap the headset Answer/End button, OR press End/Off (or similar) on your cell phone.

Answering and ending an incoming cell phone call

- To answer, tap the headset Answer/End button on your headset after the first ring OR, if the headset is placed in the base, simply remove it from the base.
- To end a call, tap the headset Answer/End button, OR press End/Off (or similar) on your cell phone, or place the headset in the base.

! IMPORTANT: If you answer a call on your cell phone handset, some cell phone models will not automatically transfer the call to your headset.

Switching from the headset to your cell phone

You can switch from your headset to your cell phone during an active call. You might want to do this if, for example, your headset battery is running low.

- Use the menu on your cell phone to switch from the headset to your cell phone during an active call (see your cell phone's User Manual).

Switching from your cell phone to the headset

You can switch from your cell phone to your headset during an active call.

- Use the menu on your cell phone to switch from your cell phone to the headset during an active call (see your cell phone's User Manual).

Rejecting an incoming call

- Press the headset Answer/End button when the phone rings to reject an incoming call.

Depending on your phone settings, the person who called will either be forwarded to your voice mail or hear a busy signal.

Making a call with Voice Dial

- **Tap** the headset Answer/End button to enter Voice Dial mode. (Consult your cell phone's User Manual for more information about how to use this feature.)

For best results, record the voice dialing tag through your headset.

Redialing the last number dialed

- **Double tap** the headset Answer/End button.

Handling multiple calls

When one call is active on the headset

- **Double tap** the Answer/End to place the active call on hold and call the last number dialed.

When one call is active and you receive a second incoming call

- **Tap** the Answer/End button to end the active call and answer the incoming call.
- **Double tap** the Answer/End button to reject the incoming call.
- **Press** Answer/End button for app. 1.5 sec to put the active call on hold and answer the incoming call.

When one call is active and a second call is on hold

- **Tap** the Answer/End button to end the active call and retrieve call waiting on hold.
- **Press** Answer/End button for app. 1.5 sec. to switch between the two calls.

Please note that this behaviour may change depending on type of phone connected to the headset.

Staying within range

The sound quality through your headset will deteriorate if you move outside of range.¹⁾ Move back into range to restore sound quality. If you move too far from your cell phone, the call might end or be re-routed to your cell phone from the headset, depending on the cell phone model you are using. Please see your cell phone's User Manual for more information on this function.

Remember!

For optimal performance, wear the Jabra M5390 Multiuse headset and your cell phone on the same side of your body or within a line of sight of one another. In general, you will get better performance when there are no obstructions between your headset and your cell phone.

8. Features

8.1

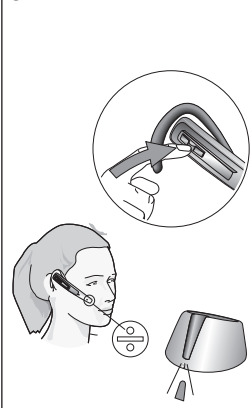

8.2

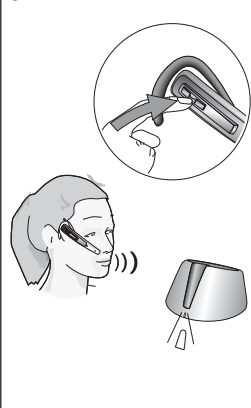

Muting & unmuting

8.1 Press the Mute button on headset. A dual tone will be heard in the headset.

8.2 To unmute, press Mute button again. A dual tone will be heard in the headset.

1) Note: If answering a call with telephone handset, make sure the headset is placed in charge cradle. Otherwise, the call will be routed through the headset.

8.3

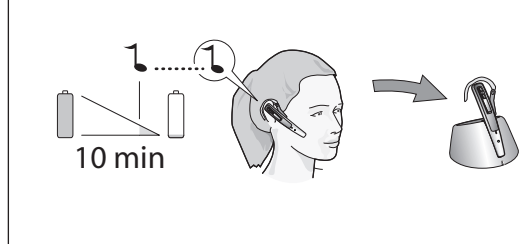

Low battery

8.3 App. 10 minutes before the headset runs out of battery, the visual indicator on headset will start to flash with a red light and a series of tones will be heard. If the battery runs out of power, the visual indicator on headset will switch off automatically. Replace the headset in the charge cradle and continue the call using telephone handset. The headset contains a battery level indicator. Tap the Vol. up/down button and the visual indicator will flash quickly twice - green, yellow or red depending on the battery level.

8.4

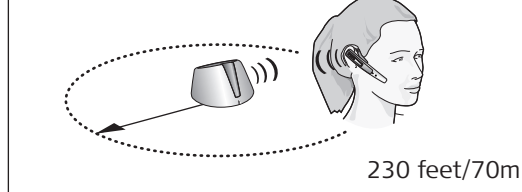

Out of range

8.4 If you go out of range (app. 230 feet/70m), all buttons except the Answer/End button will stop working until back in range again.²⁾ Please note that the majority of cell phones only support 33 feet/10m.

If the headset is muted when going out of range, it will also be muted when returning within range again.

2) Important: If the headset is out of range for more than 1 min., the connection between base and headset will be terminated.

8.5

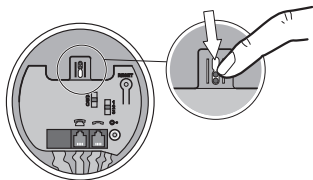
**Headset switch**

8.5 If the headset is absent, the headset switch must be activated in order to use the handset or, if the headset is in use with another Bluetooth® device, the headset switch must be activated in order to use the handset.

Features:

Range	230 feet/70m headset/base - headset/dongle 33 feet/10 m for most cell phones
Talk time/ standby time	Up to 5 hours/up to 60 hours
Transmission protocol	Bluetooth®
Frequency band	2.4 GHz

9. Reset/Pairing

9.1

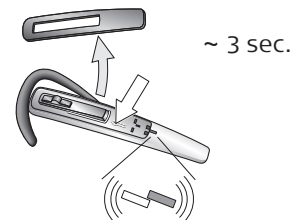

9.1 At start-up, press the Answer/End button down for three seconds. Alternatively, remove the snap-on cover and press the reset button on the headset for three seconds. The visual indicator on the headset will turn to steady blue. ¹⁾

9.2

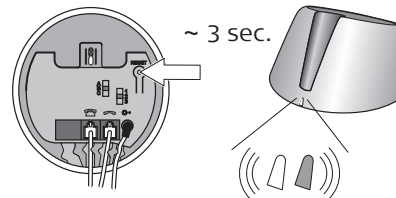

9.2 Then press the reset button on the base unit for 3 seconds. The visual indicator on the base unit will turn steady to blue.

9.3

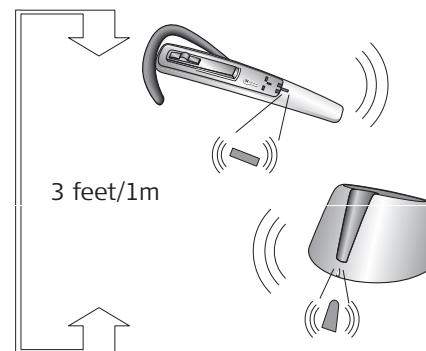

9.3 Make sure headset and the base are within 3 feet/1m of each other. When pairing is successful, both visual indicators will flash blue 5 times, and the visual indicator on the base unit will turn to steady green.

In order to clear the pairing list in the base, press and hold the reset button underneath the base for 5 seconds. In order to clear the pairing list in the headset, press and hold the reset button on the headset for 5 seconds. Note that after resetting, a new pairing sequence has to be set up.

¹⁾ **Note:** The headset is already paired with the base unit from the factory. Pairing should only be necessary if a new headset is required to work with an existing base unit (or vice versa).

10. Using the Jabra M5390 Multiuse headset with multiple Bluetooth®-enabled devices

Your Jabra M5390 Multiuse headset can be paired with up to 8 devices. However, only two can be connected (paired with the headset, turned on and in range) with the headset at one time. This could be any two Bluetooth® devices (for example, a cell phone and the Jabra M5390 Multiuse base, or the Jabra A335w Dongle and a cell phone, or two cell phones). Therefore, if the headset is in range of the Jabra M5390 Multiuse base or Jabra A335w Dongle, only one additional Bluetooth® device can be connected to the headset (paired with the headset, turned on and in range).

The headset is by default paired with the base and the dongle. This means that the headset will automatically connect to these two devices from the factory if in range and turned on. Therefore, if a cell phone needs to be connected to the headset, either the dongle or base has to be turned off or placed out of range.

It is also possible to have two Bluetooth®-enabled cell phones connected to the Jabra M5390 Multiuse headset simultaneously. In this case, both the base and the dongle should be disconnected from the headset.

11. Operating devices in multiuse scenarios

Using the button interface of the headset, it is possible to operate both connected devices in a multiuse scenario (the two devices connected to the headset). Operations can be divided into receiving incoming and placing outgoing calls.

If receiving an incoming call from either of the connected devices, this device will automatically be the device "in use" and a tap of the button will answer the call. Press the button to cancel the call.

If you would like to place an outgoing call activated from the headset, you must manually place one of the devices "in use". When a device is placed "in use", everytime a button is pressed on the headset, the instruction is sent to the selected device. For example, if you wish to make a call using Voice Dial on the second connected device, you must first make sure that the second device is "in use". After confirming the device is "in use", simply tap the button to activate Voice Dial.

In order to switch between the two connected devices, press the Answer/End button for app. 1.5 seconds.

After swapping the "in use" status of two devices, different indicators will be used to indicate which device is now "in use"; When activating the Jabra A335w dongle as "in use", the LED of the dongle will give 5 quick light-blue flashes. Also the speaker of the headset will say "Dongle in focus". When activating the Jabra M5390 base as "in use", the LED on the base will give 5 quick light-blue flashes. Also the speaker of the headset will say "Base in focus". When activating a cell phone as "in use" the speaker of the headset will say "Mobile in focus".

Please note that this only applies to multiuse scenarios. If the headset is only connected to one device, then this device will automatically be "in focus".

Also note that the Last Number Redial command does not use the "in focus" concept. Upon double tapping the Answer/End button, the Last Number Redial command will automatically be sent to the connected device with the most recent incoming call (which was received while connected to the headset).

NOTE: When multiple Bluetooth-enabled devices are paired with the headset, the Voice Dial* function will work with the last device that was paired.

12. Switching between the base and the Jabra A335w Dongle in a multiuse scenario

A typical multiuse scenario is to have the headset connected to one cell phone and either the base or the dongle. If you wish to switch the between base and dongle, while maintaining the cell phone connection, just press and hold the Volume up/down button for 4 seconds.

13. Troubleshooting & FAQ

- Q:** Nothing happens when I try to adjust the clear dial tone.
- A:** Make sure the base is tuning at full power (the visual indicator on the base unit is a steady green). Then establish a voice link between base and headset (visual indicators on base unit and headset will be flashing green). Also ensure that the telephone is activated (the handset is off the hook or the "line" button is pressed).
- Q:** I hear myself when I talk.
- A:** Your transmit volume level (please refer to section 3.10) is probably too high. Turn down the transmit volume level (3->2, 2->1).
- Q:** The sound through the headset is of poor quality or the person at the other end cannot hear me.
- A:** Make sure that you have positioned the clear dial tone switch correctly. To do this, call someone as a test case, and adjust the clear dial tone switch.
- Q:** When I press the Answer/End button, the GN 1000 RHL lifts, but the call is not connected.
- A:** Make sure that you are using the telephone's handset port and not the headset port (if your telephone has one), when using a GN 1000 RHL for remote answering.
- Q:** I have moved desks at work. Is it possible to put my headset on another base?
- A:** Yes, this is possible. The headset only needs to be paired to the new base. Just follow the procedure as described in section 9 of this guide.
- Q:** I cannot hear anything in my headset when using my cell phone.
- A:** - Increase the volume on the headset (or phone).
- As the volume level needed might vary between your desk phone and cell phone, it might be best to adjust the level on the phones.
- Then use the headset volume level adjustments for general adjustments (but ensure that the headset is paired with the cell phone).
- Make sure that the phone is connected to the headset - if it does not connect either from the phone's Bluetooth® menu or by tapping the Answer/End button, follow the pairing procedure (see section 4 "Pairing your headset with your cell phone" in this guide).

**If the cell phone supports this feature.*

Q: Can I use wideband with a cell phone or a desk phone?

A: No, the headset only supports wideband with the Jabra A335w Dongle. Please see the Jabra A335w Dongle manual for wideband settings.

Note: If your desk phone has a volume button, it might help to adjust it to optimize the sound quality in your headset.

14. Maintenance, safety and disposal

Maintenance

The ear hook can be wiped with a dry or slightly damp cloth. The cords and base unit can be dry-dusted as required. Avoid getting moisture or liquids into any button sockets, receptors or other openings. Avoid exposing the product to rain.

Children and product packaging

The packaging, including plastic bags and wrapping parts, are not toys for children. The bags themselves or the small parts they contain may cause choking if ingested.

Batteries and product disposal

Do not expose the headset batteries to heat. Dispose of the product and/or batteries according to local standards and regulations.

Need more help?

For your country's support details, see the European and Australasia Safety & Declaration or North American Declaration & Warranty that came with your Jabra M5390 Multiuse.

Charger

Warning: Do not attempt to charge your Jabra headset with anything other than the AC adapter provided. The use of any other AC adapter may damage or destroy the headset and may invalidate any approval or warranty, and may be dangerous. For the availability of approved accessories, please check with your dealer. When you disconnect the power cord of any accessory, grasp and pull the plug, not the cord. Never use a charger that is damaged. **Important:** The "colored" indicator light will be on while charging and will turn off when charging is complete. The Jabra headset cannot be used while charging.

Battery information

Your device is powered by a rechargeable battery. The full performance of a new battery is achieved only after two or three complete charge and discharge cycles. The battery can be charged and discharged hundreds of times, but will eventually wear out. Recharge your battery only with the provided approved chargers designated for this device. Unplug the charger from the electrical plug and the device when not in use. Do not leave a fully charged battery connected to a charger, since overcharging may shorten its lifetime. If left unused, a fully charged battery will lose its charge over time. Leaving the device in hot or cold places, such as in a closed car in the summer or in winter conditions, will reduce the capacity and lifetime of the battery. Always try to keep the battery between 15°C and 25°C (59°F and 77°F). A device with a hot or cold battery may not work temporarily, even when the battery is fully charged. Battery performance is particularly limited in temperatures well below freezing. Do not dispose of batteries in a fire as they may explode. Batteries may also explode if damaged. Dispose of batteries according to local regulations. Please recycle when possible. Do not dispose as household waste.

15. Appendix – GN 1000 Remote Handset Lifter (RHL) (optional accessory)

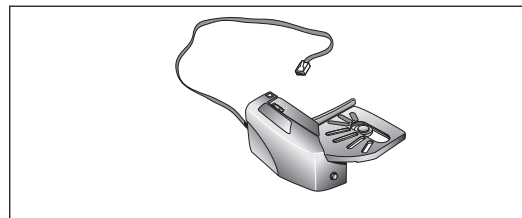

The GN 1000 Remote Handset Lifter (RHL) is an optional accessory that automatically lifts and lowers your telephone's handset when making, answering or ending a call.

Setting it up

15.1 Attach the RHL to the telephone handset cradle. Connect the RHL cord to AUX port on the bottom of the base unit.

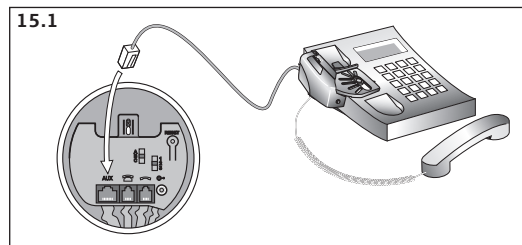

Making/answering a call

15.2 Put on the headset, or press the Answer/End button if you are already wearing headset. The RHL will automatically lift the telephone handset.

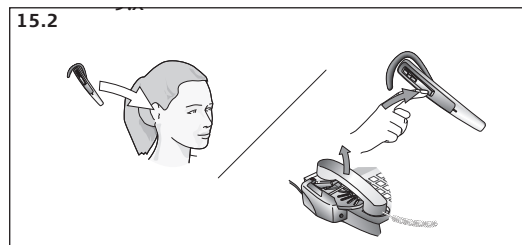

Ending a call

15.3 Press the Answer/End button, or place the headset in the charge cradle. The RHL will automatically replace the telephone handset, and the call will be terminated.

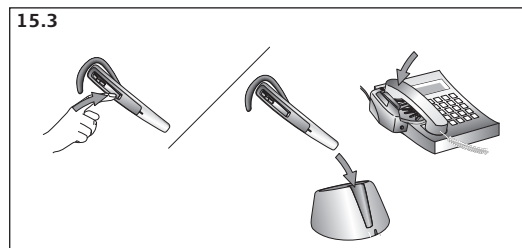

Note: Out of range. If headset is out of range for more than 1 min., any on-going call will be terminated.