

FCC Test Report (Part 22: CA mode)

Report No.: RF200109E02B-5

FCC ID: 2AQ68T99W175

Test Model: T99W175

Received Date: Jan. 10, 2020

Test Date: May 05 ~ May 18, 2020

Issued Date: May 22, 2020

Applicant: Hon Lin Technology Co., Ltd.

Address: 11F, No. 32, Jihu Rd., Neihu Dist., Taipei City 114, Taiwan R.O.C.

Issued By: Bureau Veritas Consumer Products Services (H.K.) Ltd., Taoyuan Branch
Lin Kou Laboratories

Lab Address: No. 47-2, 14th Ling, Chia Pau Vil., Lin Kou Dist., New Taipei City, Taiwan

Test Location: No.19, Hwa Ya 2nd Rd., Wen Hwa Vil., Kwei Shan Dist., Taoyuan City
33383, Taiwan

FCC Registration / 788550 / TW0003

Designation Number:



This report is for your exclusive use. Any copying or replication of this report to or for any other person or entity, or use of our name or trademark, is permitted only with our prior written permission. This report sets forth our findings solely with respect to the test samples identified herein. The results set forth in this report are not indicative or representative of the quality or characteristics of the lot from which a test sample was taken or any similar or identical product specifically and expressly noted. Our report includes all of the tests requested by you and the results thereof based upon the information that you provided to us. You have 60 days from date of issuance of this report to notify us of any material error or omission caused by our negligence, provided, however, that such notice shall be in writing and shall specifically address the issue you wish to raise. A failure to raise such issue within the prescribed time shall constitute your unqualified acceptance of the completeness of this report, the tests conducted and the correctness of the report contents. Unless specific mention, the uncertainty of measurement has been explicitly taken into account to declare the compliance or non-compliance to the specification. The report must not be used by the client to claim product certification, approval, or endorsement by TAF or any government agencies

Table of Contents

Release Control Record	3
1 Certificate of Conformity	4
2 Summary of Test Results	5
2.1 Measurement Uncertainty.....	5
2.2 Test Site and Instruments.....	6
3 General Information	7
3.1 General Description of EUT.....	7
3.2 Configuration of System under Test.....	10
3.2.1 Description of Support Units.....	10
3.3 Test Mode Applicability and Tested Channel Detail.....	11
3.4 EUT Operating Conditions.....	12
3.5 General Description of Applied Standards and References.....	12
4 Test Types and Results	13
4.1 Output Power Measurement.....	13
4.1.1 Limits of Output Power Measurement.....	13
4.1.2 Test Procedures.....	13
4.1.3 Test Setup.....	13
4.1.4 Test Results.....	14
4.2 Occupied Bandwidth Measurement.....	16
4.2.1 Test Procedure.....	16
4.2.2 Test Setup.....	16
4.2.3 Test Result.....	16
4.3 Frequency Stability Measurement.....	18
4.3.1 Limits of Frequency Stability Measurement.....	18
4.3.2 Test Procedure.....	18
4.3.3 Test Setup.....	18
4.3.4 Test Results.....	19
4.4 Band Edge Measurement.....	20
4.4.1 Limits of Band Edge Measurement.....	20
4.4.2 Test Setup.....	20
4.4.3 Test Procedures.....	20
4.4.4 Test Results.....	21
4.5 Peak to Average Ratio.....	22
4.5.1 Limits of Peak to Average Ratio Measurement.....	22
4.5.2 Test Setup.....	22
4.5.3 Test Procedures.....	22
4.5.4 Test Results.....	22
4.6 Conducted Spurious Emissions.....	23
4.6.1 Limits of Conducted Spurious Emissions Measurement.....	23
4.6.2 Test Setup.....	23
4.6.3 Test Procedure.....	23
4.6.4 Test Results.....	24
4.7 Radiated Emission Measurement.....	25
4.7.1 Limits of Radiated Emission Measurement.....	25
4.7.2 Test Procedure.....	25
4.7.3 Deviation from Test Standard.....	25
4.7.4 Test Setup.....	26
4.7.5 Test Results.....	27
5 Pictures of Test Arrangements	31
Appendix – Information of the Testing Laboratories	32

Release Control Record

Issue No.	Description	Date Issued
RF200109E02B-5	Original release	May 22, 2020

1 Certificate of Conformity

Product: 5G WWAN Module

Brand: Foxconn

Test Model: T99W175

Sample Status: Engineering Sample

Applicant: Hon Lin Technology Co., Ltd.

Test Date: May 05 ~ May 18, 2020

Standards: FCC Part 22, Subpart H

The above equipment has been tested by **Bureau Veritas Consumer Products Services (H.K.) Ltd., Taoyuan Branch**, and found compliance with the requirement of the above standards. The test record, data evaluation & Equipment Under Test (EUT) configurations represented herein are true and accurate accounts of the measurements of the sample's RF characteristics under the conditions specified in this report.

Prepared by : Pettie Chen , **Date:** May 22, 2020
Pettie Chen / Senior Specialist

Approved by : Bruce Chen , **Date:** May 22, 2020
Bruce Chen / Senior Project Engineer

2 Summary of Test Results

Applied Standard: FCC Part 22 & Part 2			
FCC Clause	Test Item	Result	Remarks
2.1046 22.913 (a)	Effective radiated power	Pass	Meet the requirement of limit.
2.1047	Modulation Characteristics	Pass	Refer to Note 2
22.913 (d)	Peak To Average Ratio	Pass	Meet the requirement of limit.
2.1055 22.355	Frequency Stability	Pass	Meet the requirement of limit.
2.1049	Occupied Bandwidth	Pass	Meet the requirement of limit.
22.917	Band Edge Measurements	Pass	Meet the requirement of limit.
2.1051 22.917	Conducted Spurious Emissions	Pass	Meet the requirement of limit.
2.1053 22.917	Radiated Spurious Emissions	Pass	Meet the requirement of limit. Minimum passing margin is -38.5dB at 997.12MHz.

Note:

- Determining compliance based on the results of the compliance measurement, not taking into account measurement instrumentation uncertainty.
- LTE CA mode is similar to digital modulation in LTE single frequency band, so please refer to BV CPS report no.: RF200109E02B for the modulation characteristics data of CA mode

2.1 Measurement Uncertainty

Where relevant, the following measurement uncertainty levels have been estimated for tests performed on the EUT as specified in CISPR 16-4-2:

Measurement	Frequency	Expanded Uncertainty (k=2) (\pm)
Radiated Emissions up to 1 GHz	9kHz ~ 30MHz	3.04 dB
	30MHz ~ 200MHz	3.63 dB
	200MHz ~ 1000MHz	3.64 dB
Radiated Emissions above 1 GHz	1GHz ~ 18GHz	2.29 dB
	18GHz ~ 40GHz	2.29 dB

2.2 Test Site and Instruments

Description & Manufacturer	Model No.	Serial No.	Cal. Date	Cal. Due
Test Receiver ROHDE & SCHWARZ	ESIB7	100187	May 30, 2019	May 29, 2020
Spectrum Analyzer ROHDE & SCHWARZ	FSP40	100269	Jun. 04, 2019	Jun. 03, 2020
Spectrum Analyzer KEYSIGHT	N9030B	MY57140953	Jul. 03, 2019	Jul. 02, 2020
Radio Communication Analyzer Anritsu	MT8821C	6261806803	Jan. 18, 2020	Jan. 17, 2021
MXG Vector signal generator Agilent	N5182B	MY53050162	Jan. 14, 2020	Jan. 13, 2021
BILOG Antenna SCHWARZBECK	VULB9168	9168-160	Nov. 07, 2019	Nov. 06, 2020
HORN Antenna SCHWARZBECK	BBHA 9120 D	9120D-1169	Nov. 24, 2019	Nov. 23, 2020
HORN Antenna SCHWARZBECK	BBHA 9170	BBHA9170241	Nov. 24, 2019	Nov. 23, 2020
Preamplifier Agilent (Below 1GHz)	8447D	2944A10638	Jul. 11, 2019	Jul. 10, 2020
Preamplifier Agilent (Above 1GHz)	8449B	3008A02367	Feb. 18, 2020	Feb. 17, 2021
RF signal cable HUBER+SUHNER&EMCI	SUCOFLEX 104 & EMC104-SM-SM8 000	CABLE-CH9-02 (248780+171006)	Jan. 18, 2020	Jan. 17, 2021
RF signal cable HUBER+SUHNER	SUCOFLEX 104	CABLE-CH9-(250795/4)	Jul. 11, 2019	Jul. 10, 2020
RF signal cable Woken	8D-FB	Cable-CH9-01	Jul. 30, 2019	Jul. 29, 2020
Software BV ADT	ADT_Radiated_ V7.6.15.9.5	NA	NA	NA
Antenna Tower EMCO	2070/2080	512.835.4684	NA	NA
Turn Table EMCO	2087-2.03	NA	NA	NA
Antenna Tower & Turn BV ADT	AT100	AT93021705	NA	NA
Turn Table BV ADT	TT100	TT93021705	NA	NA
Turn Table Controller BV ADT	SC100	SC93021705	NA	NA
Boresight Antenna Fixture	FBA-01	FBA-SIP01	NA	NA
Standard Temperature And Humidity Chamber	MHU-225AU	920842	May 31, 2019	May 30, 2020
JFW 20dB attenuation	50HF-020-SMA	NA	NA	NA
True RMS Clamp Meter Fluke	325	31130711WS	May 21, 2019	May 20, 2020
DC power supply	U8002A	MY56330015	NA	NA

Note: 1. The calibration interval of the above test instruments is 12 months and the calibrations are traceable to NML/ROC and NIST/USA.

2. The test was performed in HwaYa Chamber 9.

3 General Information

3.1 General Description of EUT

Product	5G WWAN Module				
Brand	Foxconn				
Test Model	T99W175				
Sample Status	Engineering Sample				
Power Supply Rating	5 Vdc (Host equipment) 3.135Vdc~3.63Vdc (Module)				
Modulation Type	LTE: QPSK, 16QAM, 64QAM, 256QAM				
Operating Frequency	LTE Band 5 (CA 5B)	826.8~846.2MHz			
Max. ERP Power	LTE Band 5 (CA 5B) (10MHz+10MHz)	QPSK	16QAM	64QAM	256QAM
		379.315mW (25.79dBm)	347.536mW (25.41dBm)	314.051mW (24.97dBm)	246.604mW (23.92dBm)
Emission Designator	LTE Band 5 (CA 5B) (10MHz+10MHz)	18M8G7D	18M7D7W	18M7D7W	18M9D7W
Antenna Type	Refer to Note as below				
Antenna Connector	Refer to Note as below				
Accessory Device	NA				
Cable Supplied	NA				

Note:

1. This report is prepared for FCC class II permissive change. This report is issued as a supplementary report of BV CPS report no.: RF200109E02-6. Difference compared with the original report is adding Modulation Type 256QAM by software. Therefore, the EUT was tested all tests for 256QAM and presented in the test report.
2. There are four Difference HW of T99W175.

Brand	Model	HW
Foxconn	T99W175	1. 3G+LTE+Sub6+eSIM
		2. 3G+LTE+Sub6 only w/o eSIM
		3. 3G+LTE+Sub6+eSIM+GNSS connector
		4. 3G+LTE+Sub6 only+w/o eSIM+GNSS connector

*After pre-testing, "HW: 1. 3G+LTE+Sub6+eSIM" is the worst for the final tests.

3. For CA mode configuration, please consult the manufacturer to declare the test mode.
4. E-UTRA CA configuration / Bandwidth combination set.

E-UTRA CA configuration / Bandwidth combination set					
E-UTRA CA configuration	Uplink CA configurations	Component carriers in order of increasing carrier frequency		Maximum aggregated bandwidth [MHz]	Bandwidth combination set
		Channel bandwidths for carrier [MHz]	Channel bandwidths for carrier [MHz]		
CA_5B	CA_5B	5, 10	10	20	0
		10	5		

*5B is continuous CA and maximum combination is 10M+10M.

5. The following antennas were provided to the EUT.

Antenna No.	RF Chain No.	Brand	Model	Antenna Net Gain(dBi)	Frequency range (MHz)	Antenna Type	Connector Type
1		WHA YU	C107-511720-A	4.41	660~803	PCB	I-PEX
2		WHA YU	C107-511721-A	3.81 4.03	791~960 1447.9~1606	PCB	I-PEX
3		WHA YU	C107-511722-A	4.27 5.31	1710~2170 2500~2690	PCB	I-PEX
4		WHA YU	C107-511723-A	2.99 0.92	2300~2400 3500~3700	PCB	I-PEX
5		WHA YU	C107-511724-A	6.45	5150~5925	PCB	I-PEX
6		WHA YU	C107-511725-A	4.89	3400~3700	PCB	I-PEX
7		AVX	5000106-R1-X01	2.91	699~803	Monopole	I-PEX
8		AVX	5000107-R1-X01	2.59	791~960	Monopole	I-PEX
9		AVX	5000108-R1-X01	2.85	1427~1610	Monopole	I-PEX
10		AVX	5000109-R1-X01	2.23 2.94	1710~2200 5150~5925	Monopole	I-PEX
11		AVX	5000110-R1-X01	0.9	2300~2690	Monopole	I-PEX
12		AVX	5000111-R1-X01	0.87	3300~5000	Monopole	I-PEX
13	Tx1/ Rx1	Ethertronics	5003806	0.4 -1.61 0.39 2.95 1.98 0.38 0.83 2.31	698-821 824-960 1425-1515 1710-2200 2300-2690 3300-4200 4400-5000 5150-5925	PIFA	I-PEX
	Rx2	Ethertronics	5003807	-2.24 -4.52 2.87 2.99 2.93 2.91 2.23 -0.85 -3.04	716-821 824-960 1425-1515 1557-1610 1805-2200 2300-2690 3300-4200 4400-5000 5150-5925	PIFA	I-PEX
	Tx2/ Rx3	Ethertronics	5003806	2.21 2.25 -0.45 2.6	1710-2200 2300-2690 3300-4200 4400-5000	PIFA	I-PEX
	Rx4	Ethertronics	5003700	1.38 2.87 0.6 -2.09	1805-2200 2300-2690 3300-4200 4400-5000	PIFA	I-PEX

Antenna No.	RF Chain No.	Brand	Model	Antenna Net Gain(dBi)	Frequency range (MHz)	Antenna Type	Connector Type
14	Ant. 0 (TX/RX)	Master Wave	NA	2.4 2.2 2.9 2.9 2.9 NA	880~960 1020~2170 2545~2595 3565~3600 3900~4000 GPS	PCB	I-PEX
	Ant. 2 (TX/RX)	Master Wave	NA	NA 2.2 2.8 2.9 2.8 NA	880~960 1020~2170 2545~2595 3565~3600 3900~4000 GPS	PCB	I-PEX
	Ant. 1 (RX)	Master Wave	NA	NA 5.3 5.1 4.3 4.5 NA	880~960 1020~2170 2545~2595 3565~3600 3900~4000 GPS	PCB	I-PEX
	Ant. 3 (RX)	Master Wave	NA	1.3 6.8 3.7 6.4 6.2 3.7	880~960 1020~2170 2545~2595 3565~3600 3900~4000 GPS	PCB	I-PEX

*The antenna for the final tests as following table.

	Band	Antenna
WCDMA	2	Antenna 3
	4	Antenna 3
	5	Antenna 2
LTE	2	Antenna 3
	4	Antenna 3
	5	Antenna 2
	7	Antenna 3
	12	Antenna 1
	13	Antenna 1
	14	Antenna 1
	17	Antenna 1
	25	Antenna 3
	26	Antenna 2
	30	Antenna 4
	66	Antenna 3
	71	Antenna 1
	38	Antenna 3
	41	Antenna 3
48	Antenna 4	

3.2 Configuration of System under Test

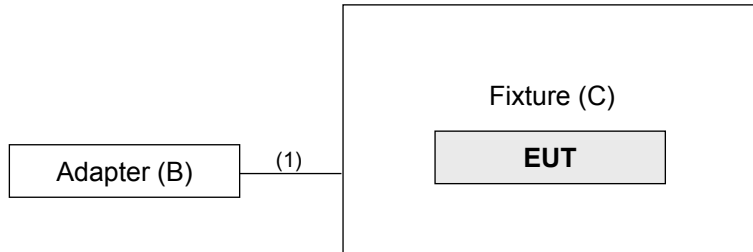

Remote site



3.2.1 Description of Support Units

The EUT has been tested as an independent unit together with other necessary accessories or support units. The following support units or accessories were used to form a representative test configuration during the tests.

ID	Product	Brand	Model No.	Serial No.	FCC ID	Remarks
A.	Radio Communication Analyzer	Anritsu	MT8821C	6261806803	NA	-
B.	Adapter	LITEON	PA-1050-39	NA	NA	-
C.	Fixture	NA	NA	NA	NA	Provided by client.

Note:

1. All power cords of the above support units are non-shielded (1.8m).
2. Item A acted as a communication partner to transfer data.

ID	Descriptions	Qty.	Length (m)	Shielding (Yes/No)	Cores (Qty.)	Remarks
1.	USB cable	1	1.5	Y	0	-

3.3 Test Mode Applicability and Tested Channel Detail

Pre-Scan has been conducted to determine the worst-case mode from all possible combinations between available modulations, data rates, XYZ axis and antenna ports. The worst case was found when positioned on Z-plane. Following channel(s) was (were) selected for the final test as listed below.

LTE Band 5 (CA 5B)

EUT Configure Mode	Test item	Available channel	Tested channel	Channel Bandwidth	Modulation	Mode
-	ERP	20450 to 20501 20549 to 20600	20450(829.0MHz)+ 20549(838.9MHz), 20476(831.6MHz)+ 20575(841.5MHz), 20501(834.1MHz)+ 20600(844.0MHz)	10MHz + 10MHz	256QAM	1 RB / 0 RB Offset 1 RB / 49 RB Offset 1 RB / 24 RB Offset
		20428 to 20528 20500 to 20600	20428 (826.8MHz)+ 20500 (834.0MHz), 20478 (831.8MHz)+ 20550 (839.0MHz), 20528 (836.8MHz)+ 20600 (844.0MHz)	5MHz + 10MHz	256QAM	1 RB / 0 RB Offset 1 RB / 49 RB Offset 1 RB / 24 RB Offset
		20450 to 20550 20522 to 20622	20450 (829.0MHz)+ 20522 (836.2MHz), 20500 (834.0MHz)+ 20572 (841.2MHz), 20550 (839.0MHz)+ 20622 (846.2MHz)	10MHz + 5MHz	256QAM	1 RB / 0 RB Offset 1 RB / 49 RB Offset 1 RB / 24 RB Offset
-	Frequency Stability	20450 to 20501 20549 to 20600	20476(831.6MHz)+ 20575(841.5MHz)	10MHz + 10MHz	256QAM	50 RB / 0 RB offset
-	Occupied Bandwidth	20450 to 20501 20549 to 20600	20450(829.0MHz)+ 20549(838.9MHz), 20476(831.6MHz)+ 20575(841.5MHz), 20501(834.1MHz)+ 20600(844.0MHz)	10MHz + 10MHz	256QAM	100 RB / 0 RB offset
		20428 to 20528 20500 to 20600	20428 (826.8MHz)+ 20500 (834.0MHz), 20478 (831.8MHz)+ 20550 (839.0MHz), 20528 (836.8MHz)+ 20600 (844.0MHz)	5MHz + 10MHz	256QAM	75 RB / 0 RB offset
		20450 to 20550 20522 to 20622	20450 (829.0MHz)+ 20522 (836.2MHz), 20500 (834.0MHz)+ 20572 (841.2MHz), 20550 (839.0MHz)+ 20622 (846.2MHz)	10MHz + 5MHz	256QAM	75 RB / 0 RB offset
-	Band Edge	20450 to 20501 20549 to 20600	20450(829.0MHz)+ 20549(838.9MHz), 20501(834.1MHz)+ 20600(844.0MHz)	10MHz + 10MHz	256QAM	1 RB / 49 RB Offset 1 RB / 0 RB Offset 50 RB / 0 RB offset
-	Peak to Average Ratio	20450 to 20501 20549 to 20600	20450(829.0MHz)+ 20549(838.9MHz), 20476(831.6MHz)+ 20575(841.5MHz), 20501(834.1MHz)+ 20600(844.0MHz)	10MHz + 10MHz	256QAM	1 RB / 49 RB Offset 1 RB / 0 RB Offset
-	Conducted Emission	20450 to 20501 20549 to 20600	20450(829.0MHz)+ 20549(838.9MHz), 20476(831.6MHz)+ 20575(841.5MHz), 20501(834.1MHz)+ 20600(844.0MHz)	10MHz + 10MHz	256QAM	1 RB / 49 RB Offset 1 RB / 0 RB Offset
-	Radiated Emission Below 1GHz	20450 to 20501 20549 to 20600	20476(831.6MHz)+ 20575(841.5MHz)	10MHz + 10MHz	256QAM	1 RB / 49 RB Offset 1 RB / 0 RB Offset

EUT Configure Mode	Test item	Available channel	Tested channel	Channel Bandwidth	Modulation	Mode
-	Radiated Emission Above 1GHz	20450 to 20501 20549 to 20600	20450(829.0MHz)+ 20549(838.9MHz), 20476(831.6MHz)+ 20575(841.5MHz), 20501(834.1MHz)+ 20600(844.0MHz)	10MHz + 10MHz	256QAM	1 RB / 49 RB Offset 1 RB / 0 RB Offset

Note:

- For radiated emission below 1 GHz and frequency stability, choose the maximum ERP power worst mode for final test.
- LTE CA mode is similar to digital modulation in LTE single frequency band, so please refer to BV CPS report no.: RF200109E02B for the modulation characteristics data of CA mode.

Test Condition:

Test Item	Environmental Conditions	Input Power (system)	Tested By
ERP	25deg. C, 70%RH	5Vdc	James Yang
Frequency Stability	25deg. C, 70%RH	5Vdc	James Yang
Occupied Bandwidth	24deg. C, 64%RH	5Vdc	James Yang
Band Edge	24deg. C, 64%RH	5Vdc	James Yang
Peak To Average Ratio	24deg. C, 64%RH	5Vdc	James Yang
Conducted Emission	24deg. C, 64%RH	5Vdc	James Yang
Radiated Emission	22deg. C, 68%RH	120Vac, 60Hz	Greg Lin

3.4 EUT Operating Conditions

The EUT makes a call to the communication simulator. The communication simulator station system controlled a EUT to export maximum output power under transmission mode and specific channel frequency

3.5 General Description of Applied Standards and References

The EUT is a RF Product. According to the specifications of the manufacturer, it must comply with the requirements of the following standards and References:

Test Standard:

FCC 47 CFR Part 2

FCC 47 CFR Part 22

ANSI/TIA/EIA-603-E 2016

ANSI 63.26-2015

All test items have been performed and recorded as per the above standards.

References Test Guidance:

KDB 971168 D01 Power Meas License Digital Systems v03r01

All test items have been performed as a reference to the above KDB test guidance.

4 Test Types and Results

4.1 Output Power Measurement

4.1.1 Limits of Output Power Measurement

Mobile / Portable station are limited to 7 watts e.r.p.

4.1.2 Test Procedures

Conducted Power Measurement:

The EUT was set up for the maximum power with LTE link data modulation and link up with simulator. Set the EUT to transmit under low, middle and high channel and record the power level shown on simulator.

Maximum EIRP

The relevant equation for determining the maximum ERP or EIRP from the measured RF output power is given in Equation as follows:

$$\text{ERP or EIRP} = P_{\text{Meas}} + G_{\text{T}}$$

where

ERP or EIRP effective radiated power or equivalent isotropically radiated power, respectively
(expressed in the same units as P_{Meas} , e.g., dBm or dBW)

P_{Meas} measured transmitter output power or PSD, in dBm or dBW

G_{T} gain of the transmitting antenna, in dBd (ERP) or dBi (EIRP)

4.1.3 Test Setup

Conducted Power Measurement:



For the actual test configuration, please refer to the attached file (Test Setup Photo).

4.1.4 Test Results

Conducted Output Power (dBm)

LTE Band 5 (CA 5B)

Con- figure	Com- bination	PCC							SCC							Measurement Power
		Band	BW (MHz)	Modu- lation	RB Size	RB Offset	UL Chan.	UL Freq. (MHz)	Band	BW (MHz)	Modu- lation	RB Size	RB Offset	UL Chan.	UL Freq. (MHz)	Tx Power with UL-CA Active (dBm)
Intra Band Conti- guous	CA_5B	5	10	256 QAM	1	0	20450	829	5	10	256 QAM	1	49	20549	838.9	11.59
					1	49						22.26				
		5	10	256 QAM	1	0	20476	831.6	5	10	256 QAM	1	49	20575	841.5	11.86
					1	49						22.26				
		5	10	256 QAM	1	0	20501	834.1	5	10	256 QAM	1	49	20600	844	11.77
					1	49						22.20				
Intra Band Conti- guous	CA_5B	5	5	256 QAM	1	0	20428	826.8	5	10	256 QAM	1	49	20500	834	11.02
					1	49						22.07				
		5	5	256 QAM	1	0	20478	831.8	5	10	256 QAM	1	49	20550	839	11.37
					1	49						21.94				
		5	5	256 QAM	1	0	20528	836.8	5	10	256 QAM	1	49	20600	844	11.12
					1	49						22.17				
Intra Band Conti- guous	CA_5B	5	10	256 QAM	1	0	20450	829	5	5	256 QAM	1	49	20522	836.2	11.28
					1	49						21.89				
		5	10	256 QAM	1	0	20500	834	5	5	256 QAM	1	49	20572	841.2	11.45
					1	49						22.13				
		5	10	256 QAM	1	0	20550	839	5	5	256 QAM	1	49	20622	846.2	11.50
					1	49						21.78				

ERP Power (dBm)

LTE Band 5 (CA 5B)

Con- figure	Com- bination	PCC							SCC							Measurement Power
		Band	BW (MHz)	Modu- lation	RB Size	RB Offset	UL Chan.	UL Freq. (MHz)	Band	BW (MHz)	Modu- lation	RB Size	RB Offset	UL Chan.	UL Freq. (MHz)	ERP (dBm)
															Total	
Intra Band Conti- guous	CA_5B	5	10	256 QAM	1	0	20450	829	5	10	256 QAM	1	49	20549	838.9	13.25
					1	49						1	0			23.92
		5	10	256 QAM	1	0	20476	831.6	5	10	256 QAM	1	49	20575	841.5	13.52
					1	49						1	0			23.92
		5	10	256 QAM	1	0	20501	834.1	5	10	256 QAM	1	49	20600	844.0	13.43
					1	49						1	0			23.86
Intra Band Conti- guous	CA_5B	5	5	256 QAM	1	0	20428	826.8	5	10	256 QAM	1	49	20500	834	12.68
					1	49						1	0			23.73
		5	5	256 QAM	1	0	20478	831.8	5	10	256 QAM	1	49	20550	839	13.03
					1	49						1	0			23.60
		5	5	256 QAM	1	0	20528	836.8	5	10	256 QAM	1	49	20600	844	12.78
					1	49						1	0			23.83
Intra Band Conti- guous	CA_5B	5	10	256 QAM	1	0	20450	829	5	5	256 QAM	1	49	20522	836.2	12.94
					1	49						1	0			23.55
		5	10	256 QAM	1	0	20500	834	5	5	256 QAM	1	49	20572	841.2	13.11
					1	49						1	0			23.79
		5	10	256 QAM	1	0	20550	839	5	5	256 QAM	1	49	20622	846.2	13.16
					1	49						1	0			23.44

*ERP = Conducted + antenna gain (3.81dBi)-2.15

4.2 Occupied Bandwidth Measurement

4.2.1 Test Procedure

The EUT makes a call to the communication simulator. All measurements were done at low, middle and high operational frequency range. The communication simulator station system controlled a EUT to export maximum output power under transmission mode and specific channel frequency. Use OBW measurement function of Spectrum analyzer to measure 99 % occupied bandwidth.

4.2.2 Test Setup

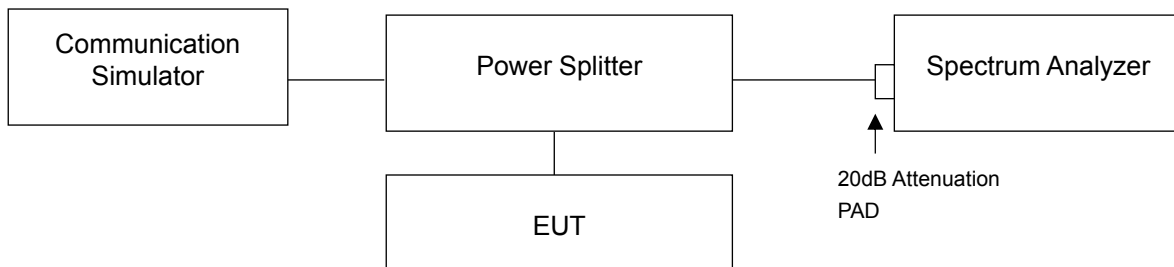

4.2.3 Test Result

LTE Band 5 (CA 5B)

LTE Band 5 (CA 5B), Channel Bandwidth 10MHz+10MHz			
Channel	Frequency (MHz)	99% Occupied Bandwidth (MHz)	26dB Bandwidth (MHz)
		256QAM_Full RB	256QAM_Full RB
20450+20549	829.0+838.9	18.86	38.24
20476+20575	831.6+841.5	18.85	35.61
20501+20600	834.1+844.0	18.67	19.38

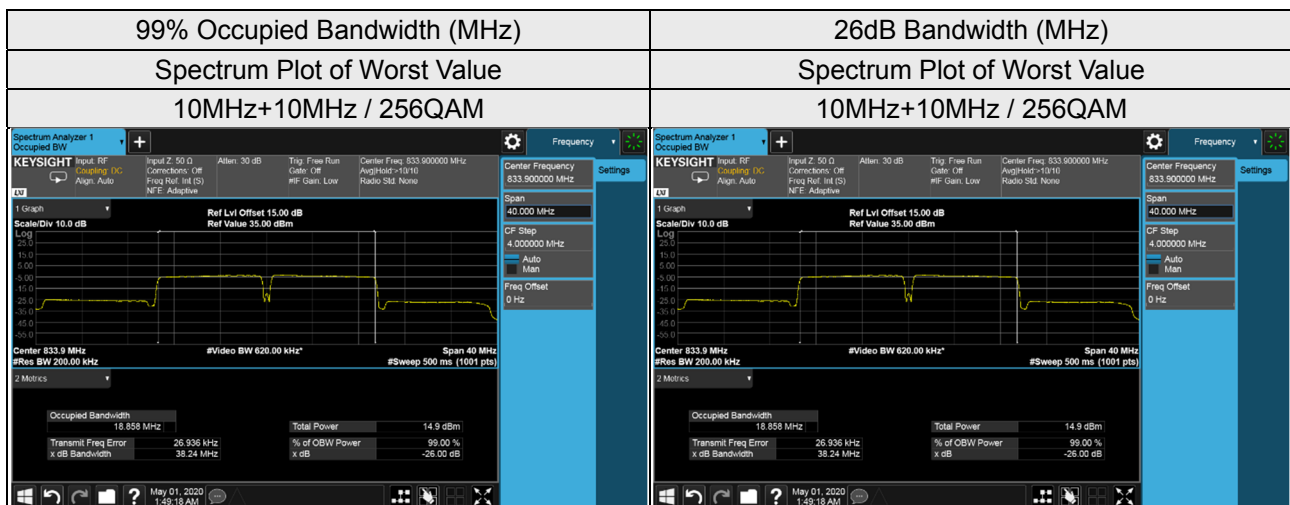

LTE Band 5 (CA 5B), Channel Bandwidth 5MHz+10MHz

Channel	Frequency (MHz)	99% Occupied Bandwidth (MHz)	26dB Bandwidth (MHz)
		256QAM_Full RB	256QAM_Full RB
20428+20500	826.8+834.0	13.802	14.30
20478+20550	831.8+839.0	13.814	14.31
20528+20600	836.8+844.0	13.793	14.30

99% Occupied Bandwidth (MHz)

26dB Bandwidth (MHz)

Spectrum Plot of Worst Value

Spectrum Plot of Worst Value

5MHz+10MHz / 256QAM

5MHz+10MHz / 256QAM

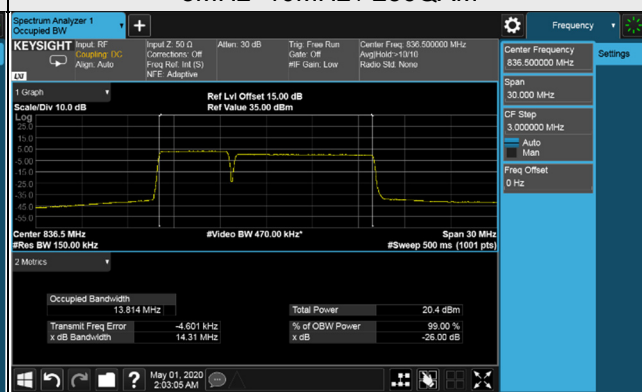
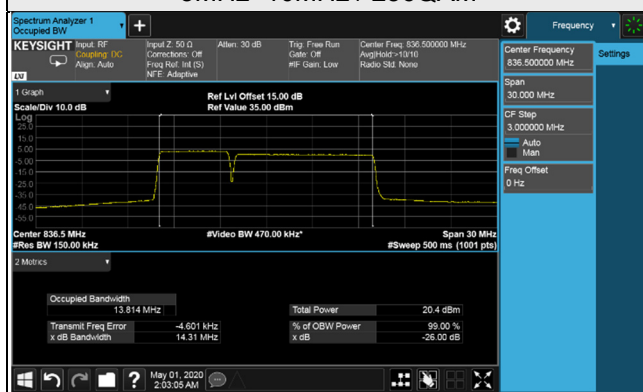

LTE Band 5 (CA 5B), Channel Bandwidth 10MHz+5MHz

Channel	Frequency (MHz)	99% Occupied Bandwidth (MHz)	26dB Bandwidth (MHz)
		256QAM_Full RB	256QAM_Full RB
20450+20522	829.0+836.2	13.804	14.30
20500+20572	834.0+841.2	13.818	14.31
20550+20622	839.0+846.2	13.815	14.31

99% Occupied Bandwidth (MHz)

26dB Bandwidth (MHz)

Spectrum Plot of Worst Value

Spectrum Plot of Worst Value

10MHz+5MHz / 256QAM

10MHz+5MHz / 256QAM

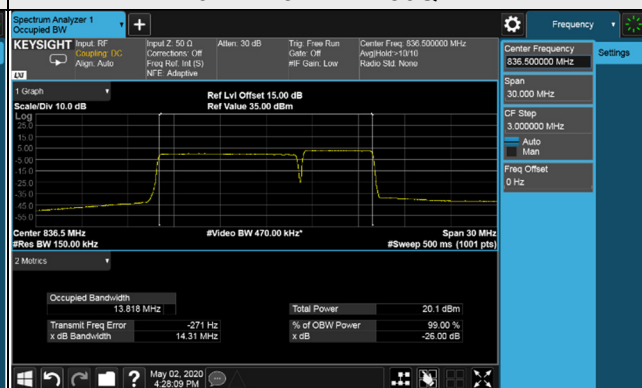
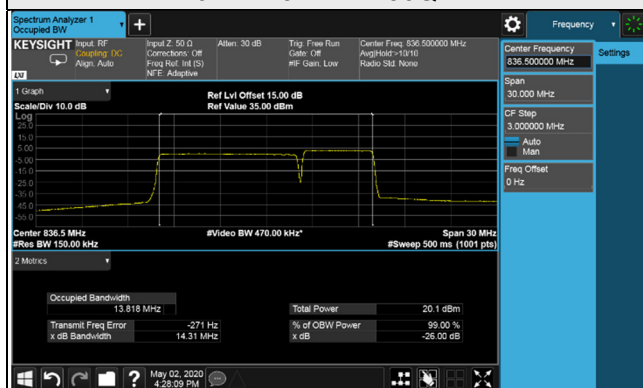

4.3 Frequency Stability Measurement

4.3.1 Limits of Frequency Stability Measurement

1.5 ppm is for base and fixed station. 2.5 ppm is for mobile station.

4.3.2 Test Procedure

- Device is placed at the oven room. The oven room could control the temperatures and humidity. Power warm up is at least 15 min and power applied should perform before recording frequency error.
- EUT is connected the external power supply to control the DC input power. The test voltage range is from minimum to maximum working voltage. Each step shall be record the frequency error rate.
- The temperature range step is 10 degrees in this test items. All temperature levels shall be hold the ± 0.5 °C during the measurement testing. The each temperature step shall be at least 0.5 hours, consider the EUT could be test under the stability condition.

Note: The frequency error was recorded frequency error from the communication simulator.

4.3.3 Test Setup

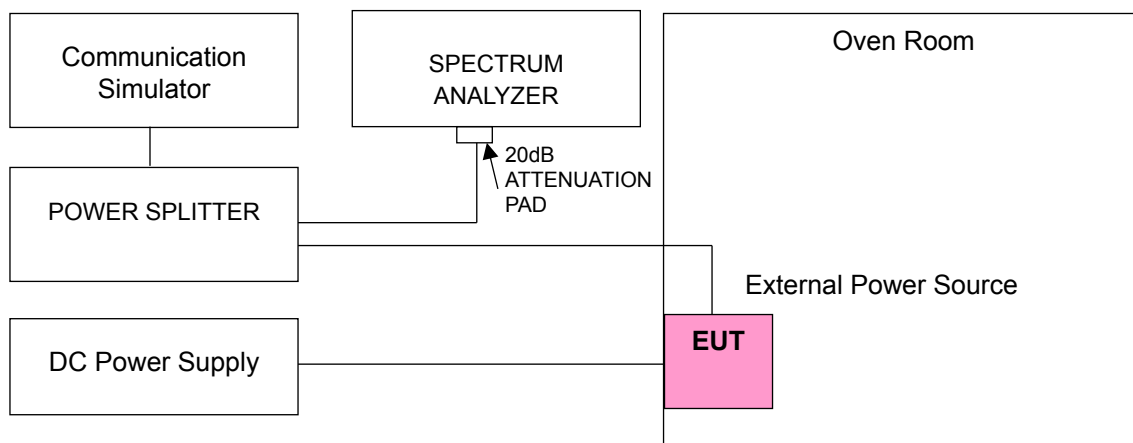

4.3.4 Test Results

Frequency Error vs. Voltage

Voltage (Volts)	LTE Band 5 (CA 5B), Channel Bandwidth 10MHz+10MHz			
	Low Channel		High Channel	
	Frequency (MHz)	Frequency Error (ppm)	Frequency (MHz)	Frequency Error (ppm)
4.25	829.000002	0.002	838.900002	0.003
5	829.000002	0.003	838.900002	0.003
5.75	829.000002	0.002	838.900004	0.005

Note: The applicant defined the normal working voltage is from 4.25Vdc to 5.75Vdc.

Frequency Error vs. Temperature

Temp. (°C)	LTE Band 5 (CA 5B), Channel Bandwidth 10MHz+10MHz			
	Low Channel		High Channel	
	Frequency (MHz)	Frequency Error (ppm)	Frequency (MHz)	Frequency Error (ppm)
-30	829.000004	0.004	838.900003	0.004
-20	829.000002	0.003	838.900002	0.002
-10	829.000003	0.004	838.900002	0.002
0	829.000002	0.002	838.900002	0.002
10	829.000003	0.003	838.900001	0.001
20	828.999998	-0.003	838.899998	-0.003
30	828.999997	-0.004	838.899999	-0.002
40	828.999998	-0.003	838.899996	-0.004
50	828.999996	-0.005	838.899999	-0.001

4.4 Band Edge Measurement

4.4.1 Limits of Band Edge Measurement

Power of any emission outside of the authorized operating frequency ranges must be attenuated below the transmitting power (P) by a factor of at least $43 + 10 \log(P)$ dB. In the 1 MHz bands immediately outside and adjacent to the frequency block a resolution bandwidth of at least one percent of the emission bandwidth of the fundamental emission of the transmitter may be employed.

4.4.2 Test Setup

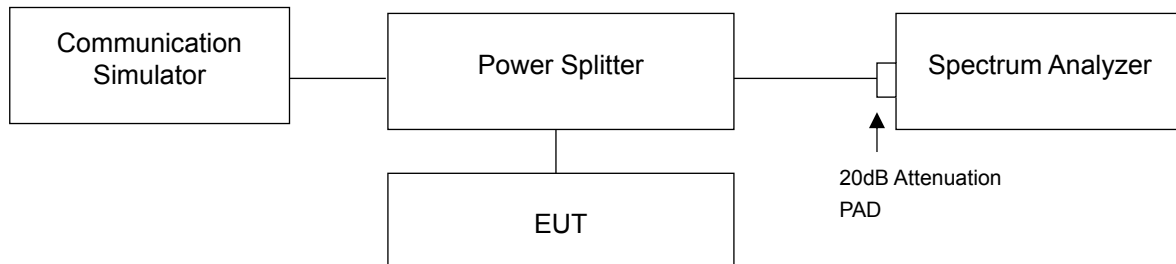

4.4.3 Test Procedures

- All measurements were done at low and high operational frequency range.
- The center frequency of spectrum is the band edge frequency and span is 2MHz. RB of the spectrum is 200kHz and VB of the spectrum is 620kHz (LTE Channel Bandwidth 10MHz+10MHz)
- Record the max trace plot into the test report.

4.4.4 Test Results

LTE Band 5 (CA 5B), Channel Bandwidth 10MHz+10MHz

Channel 20450 (829.0MHz)+ Channel 20549 (838.9MHz)	256QAM	1 RB / 0 RB Offset	Channel 20501 (834.1MHz)+ Channel 20600 (844.0MHz)	256QAM	1 RB / 49 RB Offset
---	--------	--------------------	---	--------	---------------------



Channel 20450 (829.0MHz)+ Channel 20549 (838.9MHz)	256QAM	50 RB / 0 RB Offset	Channel 20501 (834.1MHz)+ Channel 20600 (844.0MHz)	256QAM	50 RB / 0 RB Offset
---	--------	---------------------	---	--------	---------------------

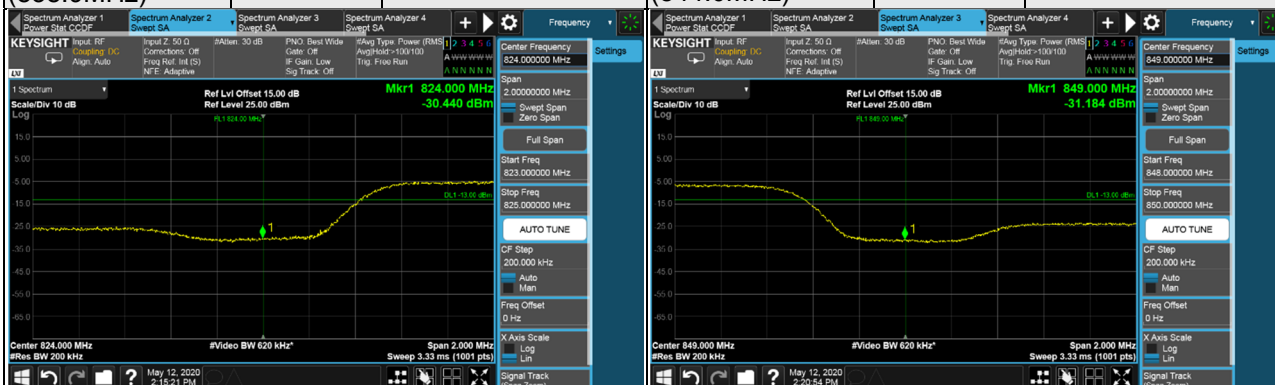

4.5 Peak to Average Ratio

4.5.1 Limits of Peak to Average Ratio Measurement

In measuring transmissions in this band using an average power technique, the peak to-average ratio (PAR) of the transmission may not exceed 13 dB

4.5.2 Test Setup

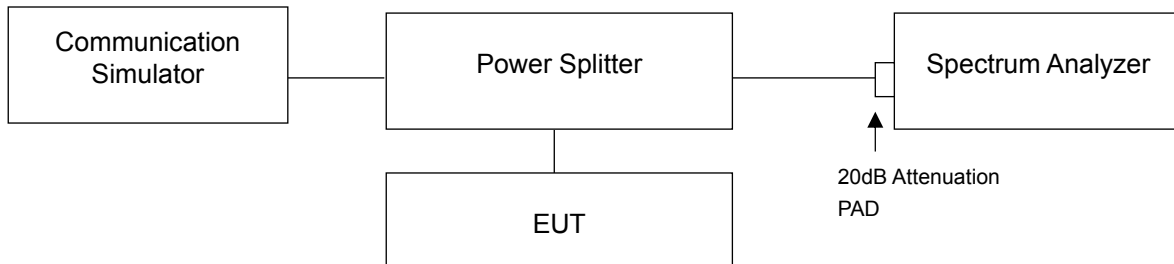

4.5.3 Test Procedures

- Set resolution/measurement bandwidth \geq signal's occupied bandwidth;
- Set the number of counts to a value that stabilizes the measured CCDF curve;
- Record the maximum PAPR level associated with a probability of 0.1%.

4.5.4 Test Results

LTE Band 5 (CA 5B)

LTE Band 5 (CA 5B), Channel Bandwidth 10MHz+10MHz		
Channel	Frequency (MHz)	Peak To Average Ratio (dB)
		256QAM
20450+20549	829.0+838.9	9.17
20476+20575	831.6+841.5	9.03
20501+20600	834.1+844.0	9.05

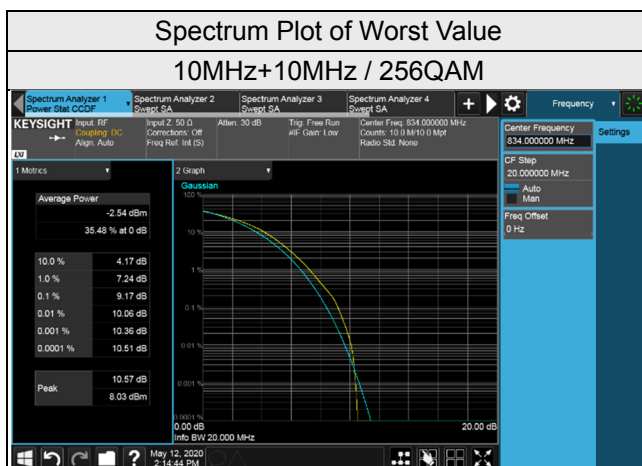

4.6 Conducted Spurious Emissions

4.6.1 Limits of Conducted Spurious Emissions Measurement

The power of any emission outside of the authorized operating frequency ranges must be attenuated below the transmitting power (P) by a factor of at least $43 + 10 \log(P)$ dB. The emission limit equal to -13dBm .

4.6.2 Test Setup

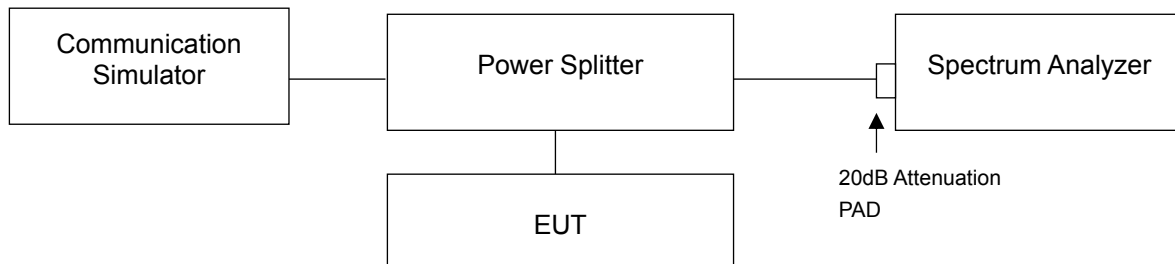

4.6.3 Test Procedure

- The EUT makes a phone call to the communication simulator. All measurements were done at low, middle and high operational frequency range.
- Measuring frequency range is from 9kHz to 10GHz. 20dB attenuation pad is connected with spectrum. RBW=1MHz and VBW=3MHz is used for conducted emission measurement.

4.6.4 Test Results

LTE Band 5 (CA 5B), Channel Bandwidth 10MHz+10MHz

Channel 20450(829.0MHz) + Channel 20549(838.9MHz)

Frequency Range : 9kHz~1GHz

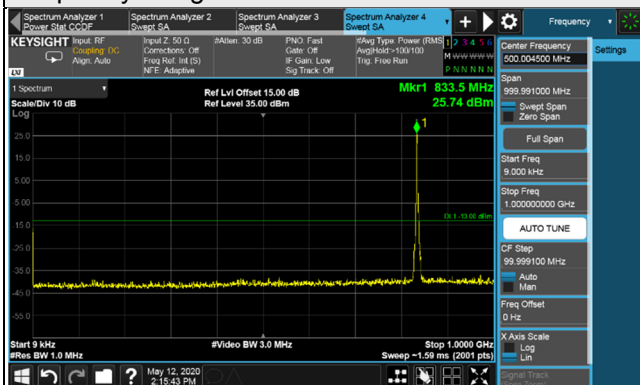

Frequency Range : 1GHz~10GHz

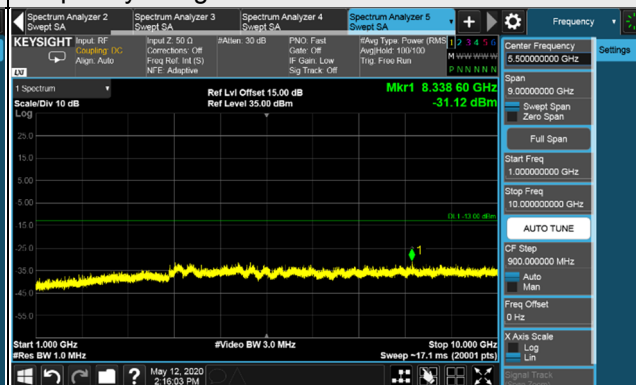

Channel 20476(831.6MHz) + Channel 20575(841.5MHz)

Frequency Range : 9kHz~1GHz

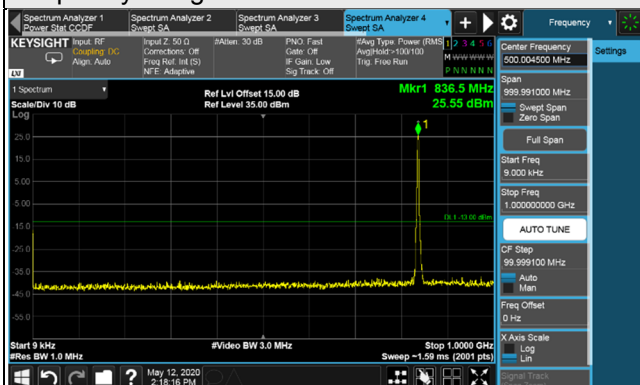

Frequency Range : 1GHz~10GHz

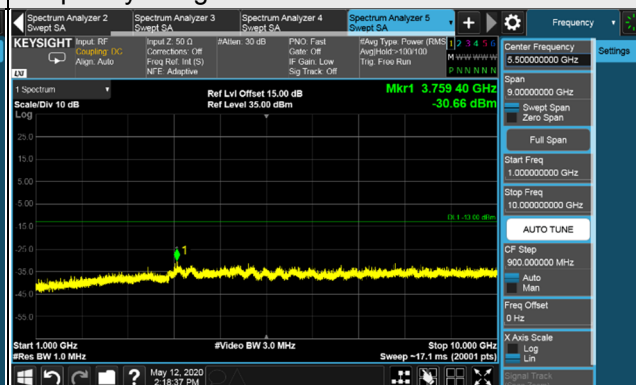

Channel 20501(834.1MHz) + Channel 20600(844.0MHz)

Frequency Range : 9kHz~1GHz

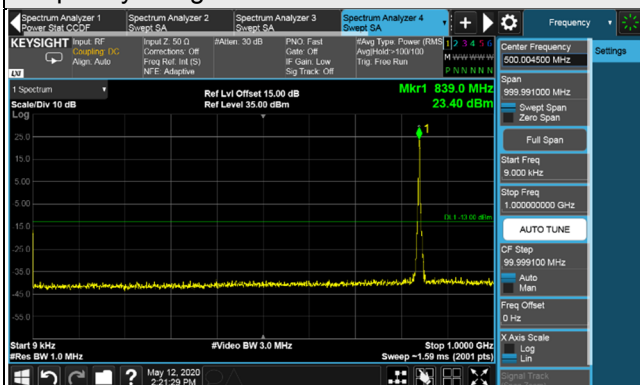

Frequency Range : 1GHz~10GHz

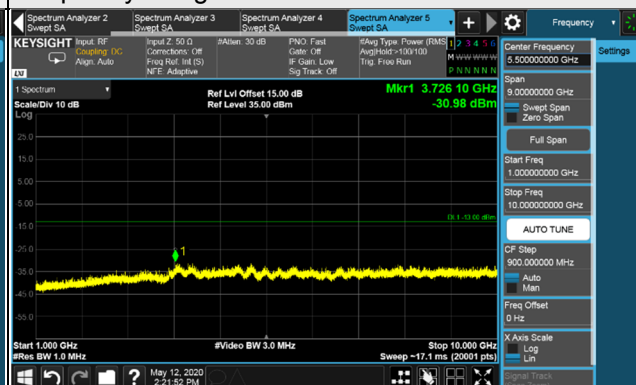

*The 9kHz signal over the limit is from Spectrum.

4.7 Radiated Emission Measurement

4.7.1 Limits of Radiated Emission Measurement

The power of any emission outside of the authorized operating frequency ranges must be attenuated below the transmitting power (P) by a factor of at least $43 + 10 \log(P)$ dB. The emission limit equal to -13dBm .

4.7.2 Test Procedure

- a. Substitution method is used for E.I.R.P measurement. In the semi-anechoic chamber, EUT placed on the 0.8m (below or equal 1 GHz) and/or 1.5 m (above 1 GHz) height of Turn Table, rotated the table around 360 degrees to search the maximum radiation power and receiver antenna shall be rotated vertical and horizontal polarization and moved height from 1m to 4m to find the maximum polar radiated power. The "Read Value" is the spectrum reading the maximum power value.
- b. The substitution horn antenna is substituted for EUT at the same position and signals generator export the CW signal to the substitution antenna via a TX cable. Rotated the Turn Table and moved receiving antenna to find the maximum radiation power. Adjust output power level of S.G to get a Value of spectrum reading equal to "Read Value" of step a. Record the power level of S.G
- c. $\text{EIRP} = \text{Output power level of S.G} - \text{TX cable loss} + \text{Antenna gain of substitution horn}$.
- d. E.R.P power can be calculated form E.I.R.P power by subtracting the gain of dipole, $\text{E.R.P power} = \text{E.I.R.P power} - 2.15\text{dBi}$.

NOTE: The resolution bandwidth and video bandwidth of test receiver/spectrum analyzer is 1MHz/3MHz.

4.7.3 Deviation from Test Standard

No deviation.

4.7.4 Test Setup

For radiated emission 30MHz to 1GHz

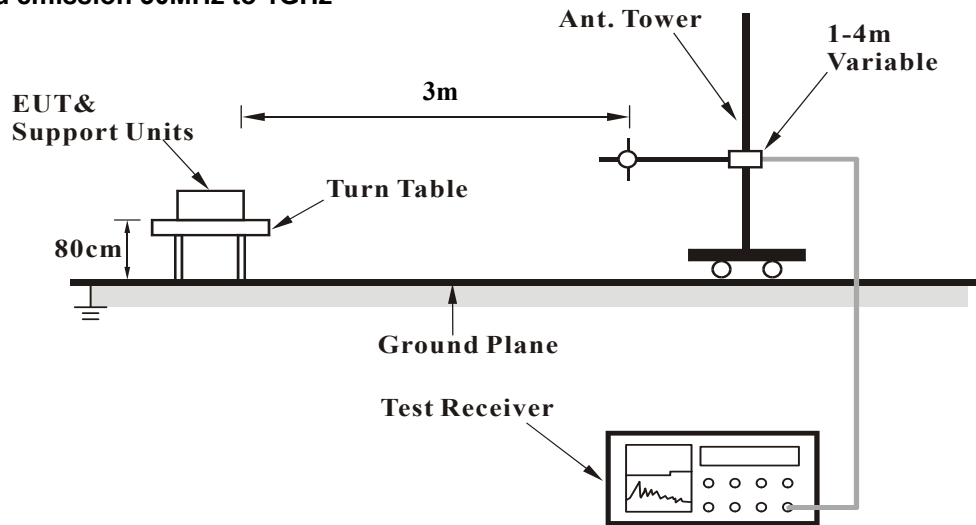

For radiated emission above 1GHz

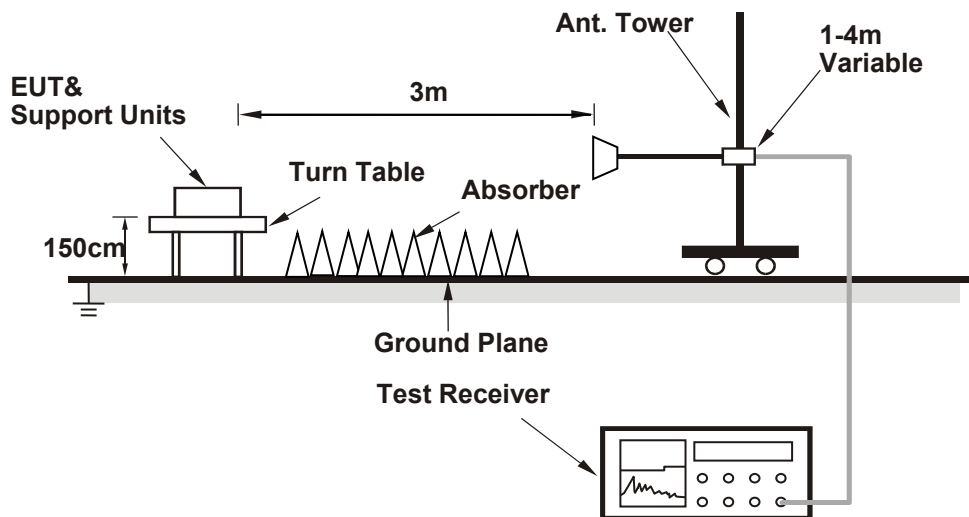

For the actual test configuration, please refer to the attached file (Test Setup Photo).

4.7.5 Test Results

Below 1GHz

LTE Band 5 (CA 5B), Channel Bandwidth: 10MHz+10MHz

Mode	TX channel 20476(831.6MHz)+ TX channel 20575(841.5MHz)	Frequency Range	Below 1000 MHz
Environmental Conditions	22deg. C, 68%RH	Input Power	120Vac, 60Hz
Tested By	Greg Lin		

Antenna Polarity & Test Distance: Horizontal at 3 M							
No.	Freq. (MHz)	Reading (dBm)	S.G Power Value (dBm)	Correction Factor (dB)	ERP (dBm)	Limit (dBm)	Margin (dB)
1	31.94	-54.4	-34.8	-18.3	-53.1	-13.0	-40.1
2	74.62	-44.5	-52.6	0.1	-52.5	-13.0	-39.5
3	265.71	-59.4	-64.3	-1.6	-65.9	-13.0	-52.9
4	567.38	-60.8	-65.7	3.7	-62.0	-13.0	-49.0
5	818.61	-60.4	-60.2	3.9	-56.3	-13.0	-43.3
6	975.75	-60.8	-57.6	3.6	-54.0	-13.0	-41.0

Remarks:

- ERP (dBm) = S.G Value (dBm) + Correction Factor (dB).
- Correction Factor (dB) = Substitution Antenna Gain (dB) - Cable Loss (dB) + 2.15dB.

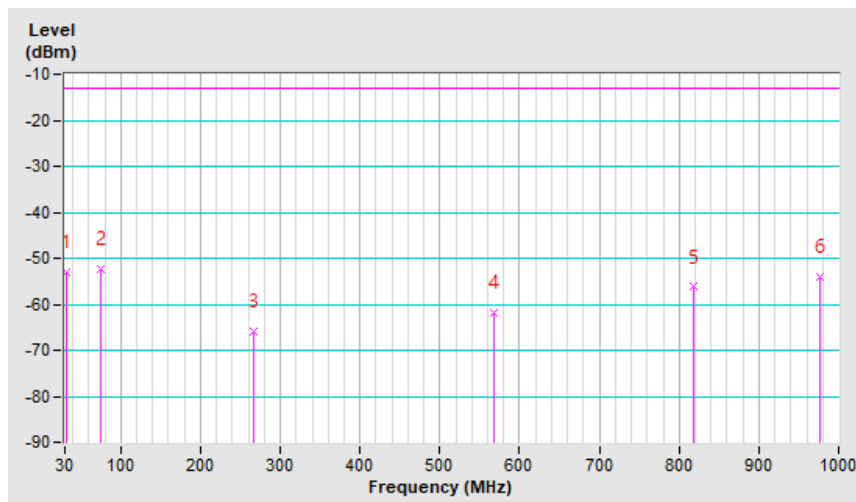

Mode	TX channel 20476(831.6MHz)+ TX channel 20575(841.5MHz)	Frequency Range	Below 1000 MHz
Environmental Conditions	22deg. C, 68%RH	Input Power	120Vac, 60Hz
Tested By	Greg Lin		

Antenna Polarity & Test Distance: Vertical at 3 M							
No.	Freq. (MHz)	Reading (dBm)	S.G Power Value (dBm)	Correction Factor (dB)	ERP (dBm)	Limit (dBm)	Margin (dB)
1	30.97	-47.4	-40.9	-18.8	-59.7	-13.0	-46.7
2	131.85	-45.9	-49.3	-3.3	-52.6	-13.0	-39.6
3	266.68	-59.2	-58.5	-1.6	-60.1	-13.0	-47.1
4	618.79	-59.4	-60.4	3.7	-56.7	-13.0	-43.7
5	800.18	-58.5	-58.0	4.0	-54.0	-13.0	-41.0
6	997.12	-59.4	-54.8	3.3	-51.5	-13.0	-38.5

Remarks:

- ERP (dBm) = S.G Value (dBm) + Correction Factor (dB).
- Correction Factor (dB) = Substitution Antenna Gain (dB) - Cable Loss (dB) + 2.15dB.

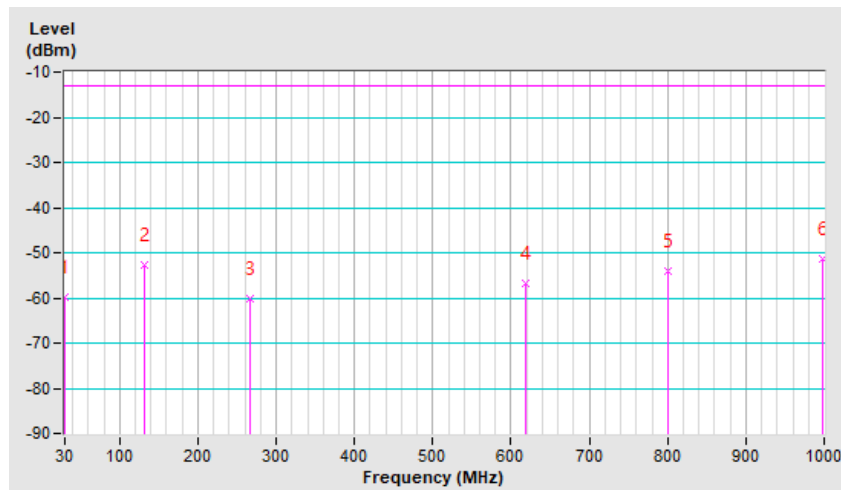

Above 1GHz

LTE Band 5 (CA 5B), Channel Bandwidth: 10MHz+10MHz

Mode	TX channel 20450 (829.0MHz)+ TX channel 20549 (838.9MHz)	Frequency Range	1GHz ~ 10GHz
Environmental Conditions	22deg. C, 68%RH	Input Power	120Vac, 60Hz
Tested By	Greg Lin		

Antenna Polarity & Test Distance: Horizontal at 3 M

No.	Freq. (MHz)	Reading (dBm)	S.G Power Value (dBm)	Correction Factor (dB)	ERP (dBm)	Limit (dBm)	Margin (dB)
1	1668.00	-65.5	-57.8	0.8	-57.0	-13.0	-44.0

Antenna Polarity & Test Distance: Vertical at 3 M

No.	Freq. (MHz)	Reading (dBm)	S.G Power Value (dBm)	Correction Factor (dB)	ERP (dBm)	Limit (dBm)	Margin (dB)
1	1668.00	-63.6	-56.3	0.8	-55.5	-13.0	-42.5

Mode	TX channel 20476 (831.6MHz)+ TX channel 20575 (841.5MHz)	Frequency Range	1GHz ~ 10GHz
Environmental Conditions	22deg. C, 68%RH	Input Power	120Vac, 60Hz
Tested By	Greg Lin		

Antenna Polarity & Test Distance: Horizontal at 3 M

No.	Freq. (MHz)	Reading (dBm)	S.G Power Value (dBm)	Correction Factor (dB)	ERP (dBm)	Limit (dBm)	Margin (dB)
1	1673.00	-65.5	-57.8	0.8	-57.0	-13.0	-44.0

Antenna Polarity & Test Distance: Vertical at 3 M

No.	Freq. (MHz)	Reading (dBm)	S.G Power Value (dBm)	Correction Factor (dB)	ERP (dBm)	Limit (dBm)	Margin (dB)
1	1673.00	-63.1	-55.8	0.8	-55.0	-13.0	-42.0

Remarks:

1. ERP (dBm) = S.G Value (dBm) + Correction Factor (dB).
2. Correction Factor (dB) = Substitution Antenna Gain (dB) - Cable Loss (dB) + 2.15dB.

Mode	TX channel 20501 (834.1MHz)+ TX channel 20600 (844.0MHz)	Frequency Range	1GHz ~ 10GHz
Environmental Conditions	22deg. C, 68%RH	Input Power	120Vac, 60Hz
Tested By	Greg Lin		

Antenna Polarity & Test Distance: Horizontal at 3 M							
No.	Freq. (MHz)	Reading (dBm)	S.G Power Value (dBm)	Correction Factor (dB)	ERP (dBm)	Limit (dBm)	Margin (dB)
1	1678.00	-65.0	-57.3	0.8	-56.5	-13.0	-43.5
Antenna Polarity & Test Distance: Vertical at 3 M							
No.	Freq. (MHz)	Reading (dBm)	S.G Power Value (dBm)	Correction Factor (dB)	ERP (dBm)	Limit (dBm)	Margin (dB)
1	1678.00	-64.2	-56.9	0.8	-56.1	-13.0	-43.1

Remarks:

1. ERP (dBm) = S.G Value (dBm) + Correction Factor (dB).
2. Correction Factor (dB) = Substitution Antenna Gain (dB) - Cable Loss (dB) + 2.15dB.

5 Pictures of Test Arrangements

Please refer to the attached file (Test Setup Photo).

Appendix – Information of the Testing Laboratories

We, Bureau Veritas Consumer Products Services (H.K.) Ltd., Taoyuan Branch, were founded in 1988 to provide our best service in EMC, Radio, Telecom and Safety consultation. Our laboratories are FCC recognized accredited test firms and accredited and approved according to ISO/IEC 17025.

If you have any comments, please feel free to contact us at the following:

Lin Kou EMC/RF Lab

Tel: 886-2-26052180

Fax: 886-2-26051924

Hsin Chu EMC/RF/Telecom Lab

Tel: 886-3-6668565

Fax: 886-3-6668323

Hwa Ya EMC/RF/Safety Lab

Tel: 886-3-3183232

Fax: 886-3-3270892

Email: service.adt@tw.bureauveritas.com

Web Site: www.bureauveritas-adt.com

The address and road map of all our labs can be found in our web site also.

--- END ---