

Prüfbericht-Nr.: <i>Test report no.:</i>	CN244OGF 001	Auftrags-Nr.: <i>Order no.:</i>	48247503	Seite 1 von 28 Page 1 of 28
Kunden-Referenz-Nr.: <i>Client reference no.:</i>	N/A	Auftragsdatum: <i>Order date:</i>	2024-05-13	
Auftraggeber: <i>Client:</i>	HP Inc. 3390 East Harmony Road, Fort Collins, CO 80528, USA			
Prüfgegenstand: <i>Test item:</i>	Wireless Mouse			
Bezeichnung / Typ-Nr.: <i>Identification / Type no.:</i>	HXMS234, HXMS241			
Auftrags-Inhalt: <i>Order content:</i>	FCC Part 15C Test report (BLE)			
Prüfgrundlage: <i>Test specification:</i>	FCC 47CFR Part 15: Subpart C Section 15.247			
Wareneingangsdatum: <i>Date of sample receipt:</i>	2024-04-18			
Prüfmuster-Nr.: <i>Test sample no.:</i>	A003700748-041 A003700748-070			
Prüfzeitraum: <i>Testing period:</i>	2024-05-09 - 2024-05-14			
Ort der Prüfung: <i>Place of testing:</i>	EMC/RF Taipei Testing Site			
Prüflaboratorium: <i>Testing laboratory:</i>	Taipei Testing Laboratories			
Prüfergebnis*: <i>Test result*:</i>	Pass			
überprüft von: <i>compiled by:</i>		genehmigt von: <i>authorized by:</i>		
Datum: <i>Date:</i>	2024-07-11	Ausstellungsdatum: <i>Issue date:</i>	2024-07-11	
Stellung / Position:	Senior Project Manager	Stellung / Position:	Senior Project Manager	
Sonstiges / Other:				
Zustand des Prüfgegenstandes bei Anlieferung: <i>Condition of the test item at delivery:</i>	Prüfmuster vollständig und unbeschädigt <i>Test item complete and undamaged</i>			
* Legende:	1 = sehr gut P(ass) = entspricht o.g. Prüfgrundlage(n)	2 = gut F(ail) = entspricht nicht o.g. Prüfgrundlage(n)	3 = befriedigend N/A = nicht anwendbar	4 = ausreichend N/T = nicht getestet
* Legend:	1 = very good P(ass) = passed a.m. test specification(s)	2 = good F(ail) = failed a.m. test specification(s)	3 = satisfactory N/A = not applicable	4 = sufficient N/T = not tested
Dieser Prüfbericht bezieht sich nur auf das o.g. Prüfmuster und darf ohne Genehmigung der Prüfstelle nicht auszugsweise vervielfältigt werden. Dieser Bericht berechtigt nicht zur Verwendung eines Prüfzeichens. <i>This test report only relates to the a. m. test sample. Without permission of the test center this test report is not permitted to be duplicated in extracts. This test report does not entitle to carry any test mark.</i>				

Prüfbericht-Nr.:
Test report no.:

CN244OGF 001

Seite 2 von 28
Page 2 of 28

Anmerkungen
Remarks

1	<p>Alle eingesetzten Prüfmittel waren zum angegebenen Prüfzeitraum gemäß eines festgelegten Kalibrierungsprogramms unseres Prüfhauses kalibriert. Sie entsprechen den in den Prüfprogrammen hinterlegten Anforderungen. Die Rückverfolgbarkeit der eingesetzten Prüfmittel ist durch die Einhaltung der Regelungen unseres Managementsystems gegeben. Detaillierte Informationen bezüglich Prüfkonditionen, Prüfequipment und Messunsicherheiten sind im Prüflabor vorhanden und können auf Wunsch bereitgestellt werden.</p> <p><i>The equipment used during the specified testing period was calibrated according to our test laboratory calibration program. The equipment fulfils the requirements included in the relevant standards. The traceability of the test equipment used is ensured by compliance with the regulations of our management system. Detailed information regarding test conditions, equipment and measurement uncertainty is available in the test laboratory and could be provided on request.</i></p>
2	<p>Wie vertraglich vereinbart, wurde dieses Dokument nur digital unterzeichnet. Der TÜV Rheinland hat nicht überprüft, welche rechtlichen oder sonstigen diesbezüglichen Anforderungen für dieses Dokument gelten. Diese Überprüfung liegt in der Verantwortung des Benutzers dieses Dokuments. Auf Verlangen des Kunden kann der TÜV Rheinland die Gültigkeit der digitalen Signatur durch ein gesondertes Dokument bestätigen. Diese Anfrage ist an unseren Vertrieb zu richten. Eine Umweltgebühr für einen solchen zusätzlichen Service wird erhoben. Informationen zur Verifizierung der Authentizität unserer Dokumente erhalten Sie auf folgender Webseite: go.tuv.com/digital-signature</p> <p><i>As contractually agreed, this document has been signed digitally only. TUV Rheinland has not verified and unable to verify which legal or other pertaining requirements are applicable for this document. Such verification is within the responsibility of the user of this document. Upon request by its client, TUV Rheinland can confirm the validity of the digital signature by a separate document. Such request shall be addressed to our Sales department. An environmental fee for such additional service will be charged. For information on verifying the authenticity of our documents, please visit the following website: go.tuv.com/digital-signature</i></p>
3	<p>Prüfklausel mit der Note * wurden an qualifizierte Unterauftragnehmer vergeben und sind unter der jeweiligen Prüfklausel des Berichts beschrieben. Abweichungen von Prüfspezifikation(en) oder Kundenanforderungen sind in der jeweiligen Prüfklausel im Bericht aufgeführt.</p> <p><i>Test clauses with remark of * are subcontracted to qualified subcontractors and described under the respective test clause in the report. Deviations of testing specification(s) or customer requirements are listed in specific test clause in the report.</i></p>
4	<p>Die Entscheidungsregel für Konformitätserklärungen basierend auf numerischen Messergebnissen in diesem Prüfbericht basiert auf der "Null-Grenzwert-Regel" und der "Einfachen Akzeptanz" gemäß ILAC G8:2019 und IEC Guide 115:2021, es sei denn, in der auf Seite 1 dieses Berichts genannten angewandten Norm ist etwas anderes festgelegt oder vom Kunden gewünscht. Dies bedeutet, dass die Messunsicherheit nicht berücksichtigt wird und daher auch nicht im Prüfbericht angegeben wird. Zu weiteren Informationen bezüglich des Risikos durch diese Entscheidungsregel siehe ILAC G8:2019.</p> <p><i>The decision rule for statements of conformity, based on numerical measurement results, in this test report is based on the "Zero Guard Band Rule" and "Simple Acceptance" in accordance with ILAC G8:2019 and IEC Guide 115:2021, unless otherwise specified in the applied standard mentioned on Page 1 of this report or requested by the customer. This means that measurement uncertainty is not taken in account and hence also not declared in the test report. For additional information to the resulting risk based of this decision rule please refer to ILAC G8:2019.</i></p>

TEST SUMMARY

Report Section	FCC Clause	Test Item	Result
5.1.1	15.247(b) & 15.203	Antenna Requirement	Pass
5.1.2	15.247(b)(3)	Peak Output Power	Pass
5.1.3	15.247(a)(2)	6 dB Bandwidth	Pass
5.1.3	2.1049	99% Occupied Bandwidth	Pass
5.1.4	15.247(e)	Power Spectral Density	Pass
5.1.5	15.247(d)	Conducted Spurious Emissions and Band Edges	Pass
5.1.6	15.247(d) & 15.205 & 15.209	Radiated Spurious Emissions and Band Edges	Pass
5.2.1	15.207	Mains Conducted Emission	Pass

Note: Determining compliance based on the results of the compliance measurement, not taking into account measurement instrumentation uncertainty.

Contents

HISTORY OF THIS TEST REPORT	6
1. GENERAL REMARKS	7
1.1 COMPLEMENTARY MATERIALS.....	7
1.2 DECISION RULE OF CONFORMITY	7
2. TEST SITES	8
2.1 TEST LABORATORY	8
2.2 TEST FACILITY.....	8
2.3 TRACEABILITY	9
2.4 CALIBRATION	9
2.5 MEASUREMENT UNCERTAINTY	9
3. GENERAL PRODUCT INFORMATION.....	10
3.1 PRODUCT FUNCTION AND INTENDED USE	10
3.2 SYSTEM DETAILS AND RATINGS.....	10
3.3 NOISE GENERATING AND NOISE SUPPRESSING PARTS	11
3.4 SUBMITTED DOCUMENTS.....	11
4. TEST SET-UP AND OPERATION MODES	12
4.1 PRINCIPLE OF CONFIGURATION SELECTION	12
4.2 CARRIER FREQUENCY AND CHANNEL.....	12
4.3 TEST OPERATION AND TEST SOFTWARE.....	13
4.4 SPECIAL ACCESSORIES AND AUXILIARY EQUIPMENT	14
4.5 TEST SETUP DIAGRAM	15
5. TEST RESULTS	16
5.1 TRANSMITTER REQUIREMENT & TEST SUITES	16
5.1.1 <i>Antenna Requirement</i>	<i>16</i>
5.1.2 <i>Peak Output Power</i>	<i>17</i>
5.1.3 <i>6 dB Bandwidth and 99% Occupied Bandwidth.....</i>	<i>19</i>
5.1.4 <i>Power Spectral Density.....</i>	<i>20</i>
5.1.5 <i>Conducted Spurious Emissions and Frequency Band Edges Measured in 100kHz Bandwidth</i>	<i>21</i>
5.1.6 <i>Radiated Spurious Emissions and Band Edges</i>	<i>22</i>
5.2 MAINS EMISSION	27
5.2.1 <i>Mains Conducted Emission.....</i>	<i>27</i>

Prüfbericht - Nr.: **CN244OGF 001**
Test Report No.

Seite 5 von 28
Page 5 of 28

APPENDIX A - TEST RESULT OF CONDUCTED

APPENDIX B - TEST RESULT OF RADIATED EMISSIONS & MAINS CONDUCTED EMISSION

APPENDIX SP - PHOTOGRAPHS OF TEST SETUP

APPENDIX EP - PHOTOGRAPHS OF EUT

Prüfbericht - Nr.: **CN244OGF 001**
Test Report No.

Seite 6 von 28
Page 6 of 28

HISTORY OF THIS TEST REPORT

Revision	Description	Date Issued
R01	Original Release	2024-07-11

1. General Remarks

1.1 Complementary Materials

All attachments are integral parts of this test report. This applies especially to the following appendix:

Appendix A - Test Result of Conducted

Appendix B - Test Result of Radiated Emissions & Mains Conducted Emission

Appendix SP - Photographs of Test Setup

Appendix EP - Photographs of EUT

Applied Standard and Test Levels

Radio
FCC 47CFR Part 15: Subpart C Section 15.247
FCC 47CFR Part 2: Subpart J Section 2.1049
ANSI C63.10:2013
KDB 558074 D01 15.247 Meas Guidance v05r02

1.2 Decision Rule of Conformity

The decision rule of conformity of this test report is following the requirements of the requested standard in the quotation, and agreed among testing laboratory and manufacturer (applicant) to exclude the consideration of Measurement Uncertainty, unless it is required by the specific standard.

2. Test Sites

2.1 Test Laboratory

Taipei Testing Laboratories

11F. No.758, Sec. 4, Bade Rd., Songshan Dist.
Taipei City 105
Taiwan (R.O.C.)

2.2 Test Facility

Taipei Testing Laboratories

No.458-18, Sec. 2, Fenliao Rd., Linkou Dist.,
New Taipei City 244
Taiwan (R.O.C.)
FCC Registration No.: 180491
ISED Registration No.: 25563

2.3 Traceability

All measurement equipment calibrations are traceable to NML(Taiwan)/NIST(USA) or where calibration is performed outside Taiwan, to equivalent nationally recognized standards organizations.

2.4 Calibration

Equipment requiring calibration is calibrated periodically in a suitably accredited Calibration Lab. Additionally all equipment is verified for proper performance on a regular basis using in house standards or comparisons.

2.5 Measurement Uncertainty

All measurement uncertainty values are shown with a coverage factor of $k=2$ to indicate a 95% level of confidence.

Emission Measurement Uncertainty

Parameter	Uncertainty
Radiated Emission (9 kHz ~ 30 MHz)	± 1.15 dB
Radiated Emission (30 MHz ~ 200 MHz)	± 1.32 dB
Radiated Emission (200 MHz ~ 1 GHz)	± 1.31 dB
Radiated Emission (1 GHz ~ 18 GHz)	± 1.53 dB
Radiated Emission (18 GHz ~ 40 GHz)	± 2.50 dB
Mains Conducted Emission	± 1.65 dB

3. General Product Information

3.1 Product Function and Intended Use

The EUT is a Wireless Mouse. It contains a Bluetooth compatible module enabling the user to communicate data through a Wireless interface.

For details refer to the User Guide, Data Sheet and Circuit Diagram.

3.2 System Details and Ratings

Basic Information of EUT

Item	EUT information
Kind of Equipment/Test Item	Wireless Mouse
Type Identification	HXMS234, HXMS241
FCC ID	B94-HXMS234

Technical Specification of EUT

Item	EUT information
Operating Frequency	1Mbps: 2402 MHz ~ 2480 MHz 2Mbps: 2404 MHz ~ 2478 MHz
Channel Number	1Mbps: 40 2Mbps: 37
Data Rate	1Mbps, 2Mbps
Operation Voltage	3.8 Vdc (Battery) 5 Vdc (USB)
Modulation	GFSK
Maximum Output Power (mW)	4.2
Antenna Information	Refer to 5.1.1
Accessory Device	Refer to 4.4

Note:

- All models are listed as below.

Main Model (Test Model)	Series Model	Difference
HXMS234	HXMS241	All models are electrically identical, the differences are in the colors and button position.

3.3 Noise Generating and Noise Suppressing Parts

Refer to the Circuit Diagram.

3.4 Submitted Documents

- Circuit Diagram
- Instruction Manual
- Rating Label
- Technical Description

4. Test Set-up and Operation Modes

4.1 Principle of Configuration Selection

The test modes were adapted accordingly in reference to the instructions for use.

During testing, Channel and Power Controlling Software provided by the customer was used to control the operating channel as well as the output power level. The RF output power selection is for the setting of RF output expected by the customer and is going to be fixed on the firmware of the final end product.

Table for Parameters of Test Software Setting

Frequency (MHz)	Power Setting
2402	Default
2404	Default
2440	Default
2478	Default
2480	Default

4.2 Carrier Frequency and Channel

1Mbps

Channel	Freq. (MHz)	Channel	Freq. (MHz)	Channel	Freq. (MHz)	Channel	Freq. (MHz)
0	2402	10	2422	20	2442	30	2462
1	2404	11	2424	21	2444	31	2464
2	2406	12	2426	22	2446	32	2466
3	2408	13	2428	23	2448	33	2468
4	2410	14	2430	24	2450	34	2470
5	2412	15	2432	25	2452	35	2472
6	2414	16	2434	26	2454	36	2474
7	2416	17	2436	27	2456	37	2476
8	2418	18	2438	28	2458	38	2478
9	2420	19	2440	29	2460	39	2480

2Mbps

Channel	Freq. (MHz)	Channel	Freq. (MHz)	Channel	Freq. (MHz)	Channel	Freq. (MHz)
1	2404	11	2424	21	2446	31	2466
2	2406	12	2428	22	2448	32	2468
3	2408	13	2430	23	2450	33	2470
4	2410	14	2432	24	2452	34	2472
5	2412	15	2434	25	2454	35	2474
6	2414	16	2436	26	2456	36	2476
7	2416	17	2438	27	2458	37	2478
8	2418	18	2440	28	2460		
9	2420	19	2442	29	2462		
10	2422	20	2444	30	2464		

4.3 Test Operation and Test Software

Setup for testing: It was used to enable the operation modes through pressing button listed as below.

The samples were used as follows:

A003700748-041

A003700748-070

Full test was applied on all test modes, but only worst case was shown.

EUT Configure Mode	Applicable To				Description
	Antenna Port Conducted Measurement	Radiated Spurious Emissions above 1 GHz	Radiated Spurious Emissions below 1 GHz	Mains Conducted Emission	
-	√	√	√	√	-

Note:

1. The EUT had been pre-tested on the positioned of each 3 axis. The worst case was found when position on **Z-plane**.
2. "-" means no effect.

Antenna Port Conducted Measurement

- Pre-Scan full test was applied on all test modes, but only worst case was shown.
- Following channel(s) was (were) selected for the final test as listed below.

EUT Configure Mode	Available Frequency (MHz)	Tested Frequency (MHz)	Date Rate (Mbps)
-	2402 to 2480	2402, 2440, 2480	1
-	2404 to 2478	2404, 2440, 2478	2

Radiated Spurious Emissions (Above 1 GHz)

- Pre-Scan full test was applied on all test modes, but only worst case was shown.
- Following channel(s) was (were) selected for the final test as listed below.

EUT Configure Mode	Available Frequency (MHz)	Tested Frequency (MHz)	Date Rate (Mbps)
-	2402 to 2480	2402, 2440, 2480	1
-	2404 to 2478	2404, 2440, 2478	2

Radiated Spurious Emissions (Below 1 GHz)

- Pre-Scan full test was applied on all test modes, but only worst case was shown.
- Following channel(s) was (were) selected for the final test as listed below.

EUT Configure Mode	Available Frequency (MHz)	Tested Frequency (MHz)	Date Rate (Mbps)
-	2402 to 2480	2402	1

Mains Conducted Emission

- Pre-Scan full test was applied on all test modes, but only worst case was shown.
- Following channel(s) was (were) selected for the final test as listed below.

EUT Configure Mode	Available Frequency (MHz)	Tested Frequency (MHz)	Date Rate (Mbps)
-	2402 to 2480	2402	1

Prüfbericht - Nr.: CN244OGF 001
Test Report No.

 Seite 14 von 28
 Page 14 of 28

Test Condition

Test Item	Ambient Temperature	Relative Humidity	Tested by
Conducted Measurement	24.8-25.4 °C	53-55.2 %	Andy Chen
Radiated Spurious Emissions above 1 GHz	23.7-24.8 °C	54-56 %	Roger Liao
Radiated Spurious Emissions below 1 GHz	23.7-24.8 °C	54-56 %	Roger Liao
Mains Conducted Emission	20.1-25.9 °C	50.2-58.9 %	Roger Liao

4.4 Special Accessories and Auxiliary Equipment

The product has been tested together with the following additional accessories:

Accessory of EUT

No.	Product	Brand	Model	Description
-	Li-ion Battery	Everpower	PL762024V	3.8 Vdc, 450 mAh
A	USB Cable	Siyoto	A203-2804-0001	1.8 m
-	USB Wireless Dongle	HYPERX	HXWD231	--
-	Extension Adapter	HYPERX	PF009A	--

Support Unit

Support Unit								
No	Description	Brand	Model	S/N	Shielded	Ferrite Core (Qty)	Length (cm)	Remark
1	Notebook	HP	TPN-C139	N/A	-	-	-	Radiated
2	Adapter	HP	TPN-LA16	L25298-001	NO	NO	180	
1	Notebook	HP	15s-fq5031TU	CND911RJB	-	-	-	Mains Conducted
2	AC Adapter	HP	TPN-LA16	L25298-001	NO	NO	180	

4.5 Test Setup Diagram

<Radiated Spurious Emissions mode>

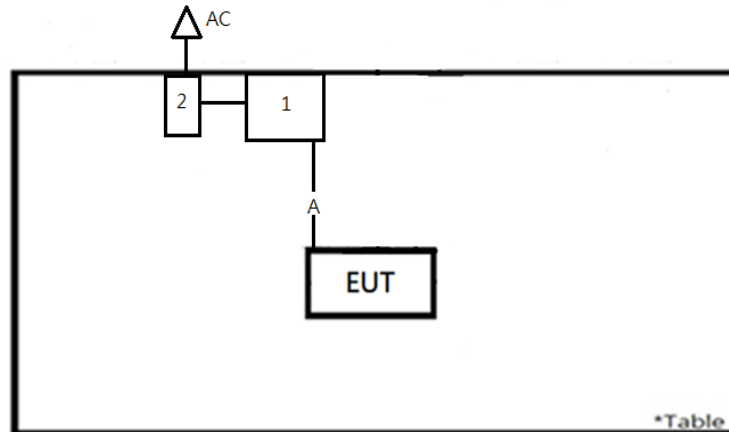

<Mains Conducted Emission mode>

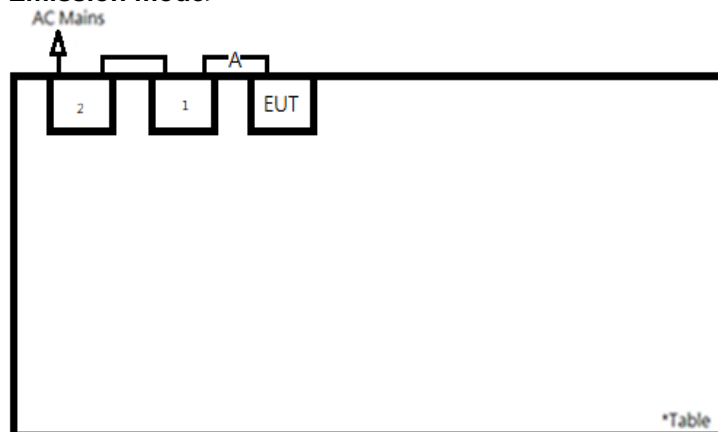

5. Test Results

5.1 Transmitter Requirement & Test Suites

5.1.1 Antenna Requirement

Requirement Use of approved antennas only

According to the manufacturer declaration, the EUT has an antenna with a directional gain of 3.41 dBi. The antenna is PCB antenna with no possibility of replacement with a non-approved antenna by the end-user. Therefore, the EUT is considered to comply with this provision.
Refer to EUT photo for details.

Refer to EUT photo for details.

Prüfbericht - Nr.: CN244OGF 001
Test Report No.

 Seite 17 von 28
 Page 17 of 28

5.1.2 Peak Output Power

Limit 1 watt (30 dBm)

Kind of Test Site Shielded room

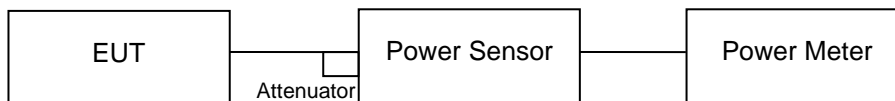
Test Setup

Test Instruments

Kind of Equipment	Manufacturer	Type	S/N	Calibration Date	Calibration Due Date	Test Date	
						From	Until
Power Meter	Anritsu	ML2495A	1901008	2024/03/12	2025/03/12	2024/5/10	2024/5/13
Power Sensor	Anritsu	MA2411B	1725269	2024/03/12	2025/03/12	2024/5/10	2024/5/13

Test Procedures

A peak power sensor was used on the output port of the EUT. A power meter was used to read the response of the peak power sensor. Record the power level.

Average power sensor was used to perform output power measurement, trigger and gating function of wide band power meter is enabled to measure max output power of TX on burst. Duty factor is not added to measured value.

Test Result
Peak Output Power
<1Mbps>

Channel	Channel Frequency	Peak Output Power		Limit (dBm)
	(MHz)	(dBm)	(mW)	
Low Channel	2402	4.89	3.08	30
Middle Channel	2440	5.71	3.72	30
High Channel	2480	6.22	4.19	30

<2Mbps>

Channel	Channel Frequency	Peak Output Power		Limit (dBm)
	(MHz)	(dBm)	(mW)	
Low Channel	2404	4.97	3.14	30
Middle Channel	2440	5.73	3.74	30
High Channel	2478	6.23	4.20	30

Average Power
<1Mbps>

Channel	Channel Frequency	Average Power	
	(MHz)	(dBm)	(mW)
Low Channel	2402	4.74	2.98
Middle Channel	2440	5.57	3.61
High Channel	2480	6.10	4.07

<2Mbps>

Channel	Channel Frequency	Average Power	
	(MHz)	(dBm)	(mW)
Low Channel	2404	4.80	3.02
Middle Channel	2440	5.58	3.61
High Channel	2478	6.12	4.09

Prüfbericht - Nr.: CN244OGF 001
Test Report No.

 Seite 19 von 28
 Page 19 of 28

5.1.3 6 dB Bandwidth and 99% Occupied Bandwidth

Limit The minimum 6 dB bandwidth shall be at least 500 kHz.

Kind of Test Site Shielded room

Test Setup

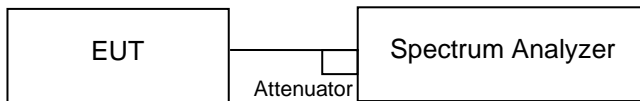

Test Instruments

Kind of Equipment	Manufacturer	Type	S/N	Calibration Date	Calibration Due Date	Test Date	
						From	Until
Spectrum Analyzer	R&S	FSV	101512	2024/02/22	2025/02/20	2024/5/10	2024/5/13

Test Procedure

- a. Set resolution bandwidth (RBW) = 100 kHz
- b. Set the video bandwidth (VBW) $\geq 3 \times$ RBW, Detector = Peak.
- c. Trace mode = max hold.
- d. Sweep = auto couple.
- e. Measure the maximum width of the emission that is constrained by the frequencies associated with the two amplitude points (upper and lower) that are attenuated by 6 dB relative to the maximum level measured in the fundamental emission.
- f. For 99% occupied bandwidth measurement, the transmitter output was connected to the spectrum analyzer through an attenuator. The bandwidth of the fundamental frequency was measured by spectrum analyzer with resolution bandwidth in the range of 1% to 5% of the anticipated emission bandwidth, and a video bandwidth at least 3x the resolution bandwidth and set the detector to PEAK. The width of a frequency band such that, below the lower and above the upper frequency limits, the mean powers emitted are each equal to a specified percentage 0.5% of the total mean power of a given emission.

Test Results

Please refer to Appendix A.

Prüfbericht - Nr.: **CN244OGF 001**
Test Report No.

 Seite 20 von 28
 Page 20 of 28

5.1.4 Power Spectral Density

Limit

The power spectral density shall not be greater than 8 dBm in any 3 kHz band.

Kind of Test Site Shielded room

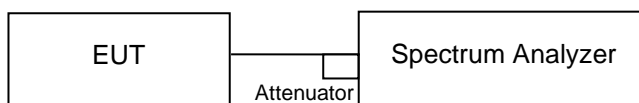
Test Setup

Test Instruments

Kind of Equipment	Manufacturer	Type	S/N	Calibration Date	Calibration Due Date	Test Date	
						From	Until
Spectrum Analyzer	R&S	FSV	101512	2024/02/22	2025/02/20	2024/5/10	2024/5/13

Test Procedure

- a. Set analyzer center frequency to DTS channel center frequency.
- b. Set the span to 1.5 times the DTS bandwidth.
- c. Set the RBW to: $3 \text{ kHz} \leq \text{RBW} \leq 100 \text{ kHz}$.
- d. Set the VBW $\geq 3 \times \text{RBW}$.
- e. Detector = peak.
- f. Sweep time = auto couple.
- g. Trace mode = max hold.
- h. Allow trace to fully stabilize.
- i. Use the peak marker function to determine the maximum amplitude level within the RBW.

Test Results

Please refer to Appendix A.

Prüfbericht - Nr.: CN244OGF 001
Test Report No.

 Seite 21 von 28
 Page 21 of 28

5.1.5 Conducted Spurious Emissions and Frequency Band Edges Measured in 100kHz Bandwidth

Limit

20 dB (below that in the 100 kHz bandwidth within the band that contains the highest level of the desired power.)

Kind of Test Site Shielded room

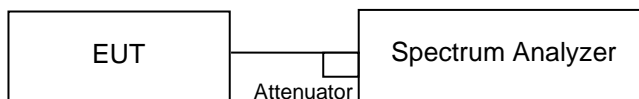
Test Setup

Test Instruments

Kind of Equipment	Manufacturer	Type	S/N	Calibration Date	Calibration Due Date	Test Date	
						From	Until
Spectrum Analyzer	R&S	FSV	101512	2024/02/22	2025/02/20	2024/5/10	2024/5/13

Test Procedure

Measurement procedure REF

1. Set the RBW = 100 kHz.
2. Set the VBW \geq 300 kHz.
3. Detector = peak.
4. Sweep time = auto couple.
5. Trace mode = max hold.
6. Allow trace to fully stabilize.
7. Use the peak marker function to determine the maximum power level in any 100 kHz band segment within the fundamental EBW.

Measurement procedure OOBE

1. Set RBW = 100 kHz.
2. Set VBW \geq 300 kHz.
3. Detector = peak.
4. Sweep = auto couple.
5. Trace Mode = max hold.
6. Allow trace to fully stabilize.
7. Use the peak marker function to determine the maximum amplitude level.

Test Results

Please refer to Appendix A.

5.1.6 Radiated Spurious Emissions and Band Edges

Limit

Radiated emissions which fall in the restricted bands, as defined in §15.205(a), must comply with the radiated emission limits specified in §15.209(a).

Emissions radiated outside the restricted and authorized frequency bands must either comply with the radiated emission limits specified for the restricted bands or in §15.247(d).

Kind of Test Site 3m Semi-Anechoic Chamber

Test Setup

<Radiated Emissions below 30 MHz>

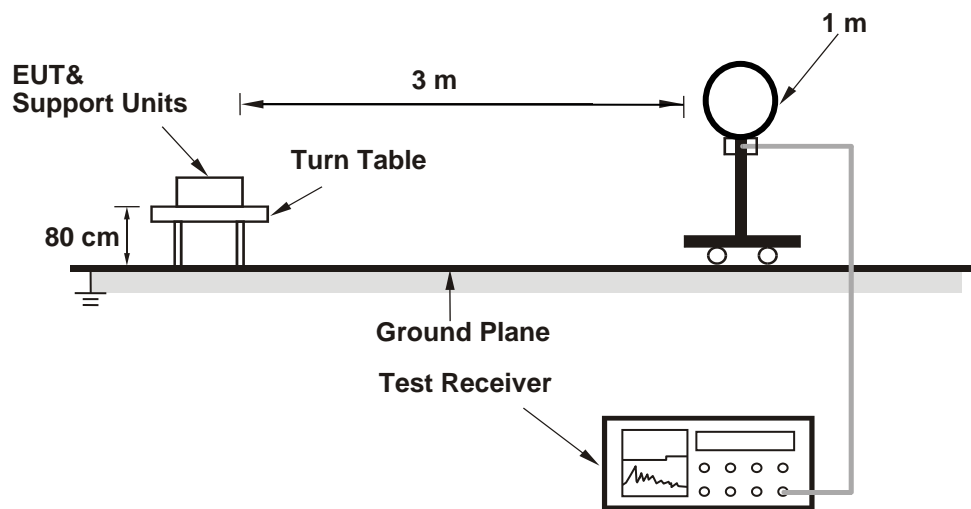

<Radiated Emissions 30 MHz to 1 GHz>

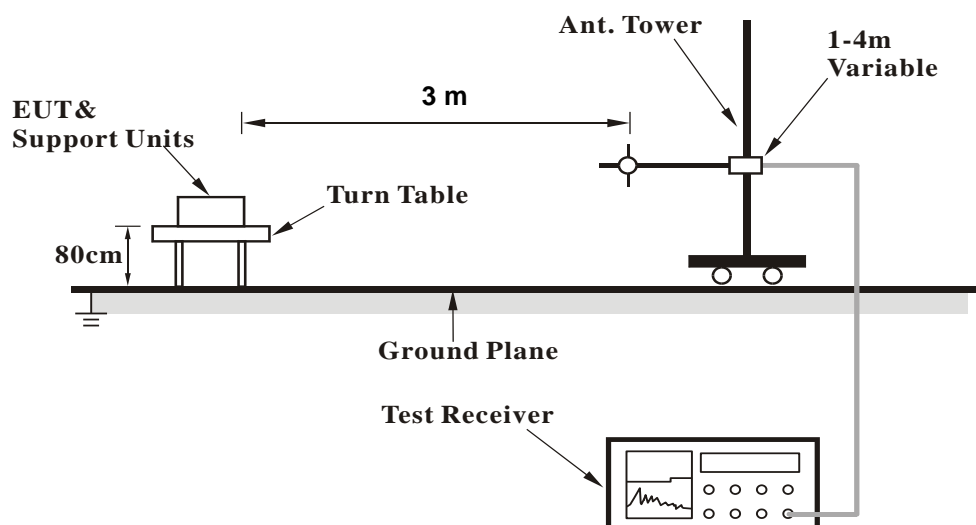

<Radiated Emissions above 1 GHz>

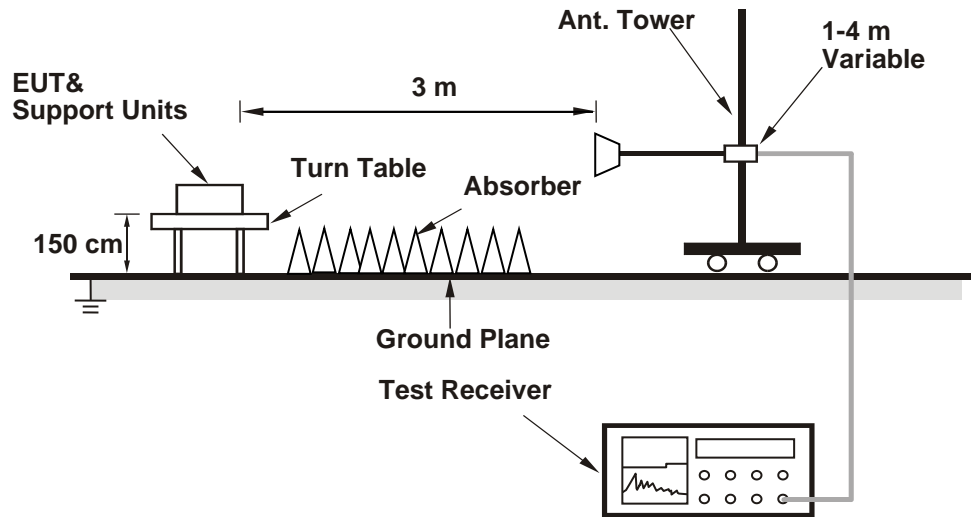

For the actual test configuration, please refer to the attached file (Test Setup Photo).

Prüfbericht - Nr.: CN244OGF 001
Test Report No.
Test Instruments

Kind of Equipment	Manufacturer	Type	S/N	Calibration Date	Calibration Due Date
Above 1 GHz					
Signal Analyzer	R&S	FSV40	101509	2024/4/30	2025/4/29
Horn Antenna	ETS-Lindgren	3117	00218929	2023/11/17	2024/11/15
Horn Antenna	SCHWARZBECK	BBHA 9170	00890	2024/4/30	2025/4/29
HF-AMP + AC source	EMCI	EMC051845SE	980633	2024/1/24	2025/1/22
HF-AMP + AC source	EMCI	EMC051845SE	980656	2024/1/18	2025/1/16
Test Software	Audix E3	15914a_20191106 tuv	PK-001087	N/A	N/A
30 MHz ~ 1 GHz					
Receiver	R&S	ESR7	102109	2024/2/22	2025/2/20
Bilog Antenna	SCHWARZBECK	VULB-9168	00951	2024/3/21	2025/3/20
LF-AMP	Agilent	8447D	2727A05146	2024/1/24	2025/1/22
Test Software	Audix E3	15914a_20191106 tuv	PK-001087	N/A	N/A
Below 30 MHz					
Receiver	R&S	ESR7	102109	2024/2/22	2025/2/20
Loop Antenna	SCHWARZBECK	FMZB 1519B	00215	2024/1/4	2025/1/2
Test Software	Audix E3	15914a_20191106 tuv	PK-001087	N/A	N/A

Test Procedures**For Radiated Emissions below 30 MHz**

- a. The EUT was placed on the top of a rotating table 0.8 meters above the ground at a 3 meter chamber room. The table was rotated 360 degrees to determine the position of the highest radiation.
- b. The EUT was set 3 meters away from the interference-receiving antenna, which was mounted on the top of a variable-height antenna tower.
- c. Parallel (OPEN), perpendicular (CLOSE), and ground-parallel (GROUND) orientations of the antenna are set to make the measurement.
- d. For each suspected emission, the EUT was arranged to its worst case and the rotatable table was turned from 0 degrees to 360 degrees to find the maximum reading.
- e. The test-receiver system was set to Quasi-Peak Detect Function and Specified Bandwidth with Maximum Hold Mode.

Note:

1. The resolution bandwidth and video bandwidth of test receiver/spectrum analyzer is 9 kHz at frequency below 30 MHz.
2. All modes of operation were investigated and the worst-case emissions are reported.

For Radiated Emissions above 30 MHz

- a. The EUT was placed on the top of a rotating table 0.8 meters (for 30 MHz ~ 1 GHz) / 1.5 meters (for above 1 GHz) above the ground at 3 meter chamber room for test. The table was rotated 360 degrees to determine the position of the highest radiation.
- b. The EUT was set 3 meters away from the interference-receiving antenna, which was mounted on the top of a variable-height antenna tower.
- c. The height of antenna is varied from one meter to four meters above the ground to determine the maximum value of the field strength. Both horizontal and vertical polarizations of the antenna are set to make the measurement.
- d. For each suspected emission, the EUT was arranged to its worst case and then the antenna was tuned to heights from 1 meter to 4 meters and the rotatable table was turned from 0 degrees to 360 degrees to find the maximum reading.
- e. The test-receiver system was set to quasi-peak detect function and specified bandwidth with maximum hold mode when the test frequency is below 1 GHz.
- f. The test-receiver system was set to peak and average detected function and specified bandwidth with maximum hold mode when the test frequency is above 1 GHz. If the peak reading value also meets average limit, measurement with the average detector is unnecessary.

Note:

1. The resolution bandwidth and video bandwidth of test receiver/spectrum analyzer is 120 kHz for Quasi-peak detection (QP) or Peak detection (PK) at frequency below 1 GHz.
2. The resolution bandwidth of test receiver/spectrum analyzer is 1 MHz and the video bandwidth is 3 MHz for Peak detection (PK) at frequency above 1 GHz.
3. The resolution bandwidth of test receiver/spectrum analyzer is 1 MHz and the video bandwidth is $\geq 1/T$ (Duty cycle < 98 %) or 10 Hz (Duty cycle ≥ 98 %) for Average detection (AV) at frequency above 1 GHz.
4. All modes of operation were investigated and the worst-case emissions are reported.
5. The Radiated Emissions testing was performed in the X(E1), Y(H) and Z(E2) axis orientation. The worst-case Axis orientation is recorded in this test report.
6. The emission levels of other frequencies (including the 10th harmonic of the highest fundamental frequency) are very lower than the limit and are not shown in the test report.

Prüfbericht - Nr.: **CN244OGF 001**
Test Report No.

Seite 26 von 28
Page 26 of 28

Test Results

Factor (dB/m) = Antenna Factor (dB/m) + Cable Loss (dB) – Amplifier (dB)

Level (dBuV/m) = Reading (dBuV) + Factor (dB/m)

Please refer to Appendix B.

5.2 Mains Emission

5.2.1 Mains Conducted Emission

Limit

Mains Conducted Emission as defined in §15.207 must comply with the mains conducted emission limits.

Kind of Test Site Shielded room

Test Setup

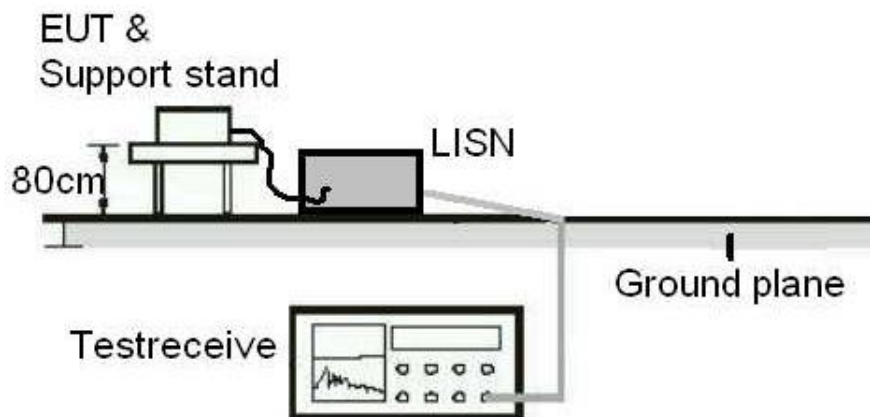

Test Instruments

Kind of Equipment	Manufacturer	Type	S/N	Calibration Date	Calibration Due Date
Two-Line V-Network	Rohde & Schwarz	ENV216	101938	2023/10/23	2024/10/21
EMI Test Receiver	R&S	ESCI	100797	2023/7/21	2024/7/19

Prüfbericht - Nr.: **CN244OGF 001**
Test Report No.

Seite 28 von 28
Page 28 of 28

Test Procedures

- a. The EUT was placed 0.4 meters from the conducting wall of the shielded room with EUT being connected to the power mains through a line impedance stabilization network (LISN). Other support units were connected to the power mains through another LISN. The two LISNs provide 50 ohm/50 uH of coupling impedance for the measuring instrument.
- b. Both lines of the power mains connected to the EUT were checked for maximum conducted interference.
- c. The frequency range from 150 kHz to 30 MHz was searched. Emission levels under (Limit – 20 dB) was not recorded.

Note: The resolution bandwidth and video bandwidth of test receiver is 9 kHz for quasi-peak detection (QP) and average detection (AV) at frequency 0.15 MHz – 30 MHz.

Test Results

Please refer to Appendix B.

Appendix A: Test Results of Conducted Test

Test Result of 6 dB Bandwidth

BLE_1M

Channel	Channel Frequency (MHz)	6 dB Bandwidth (MHz)	Limit (MHz)	Result
Low Channel	2402	0.73	0.5	Pass
Middle Channel	2440	0.76	0.5	Pass
High Channel	2480	0.76	0.5	Pass

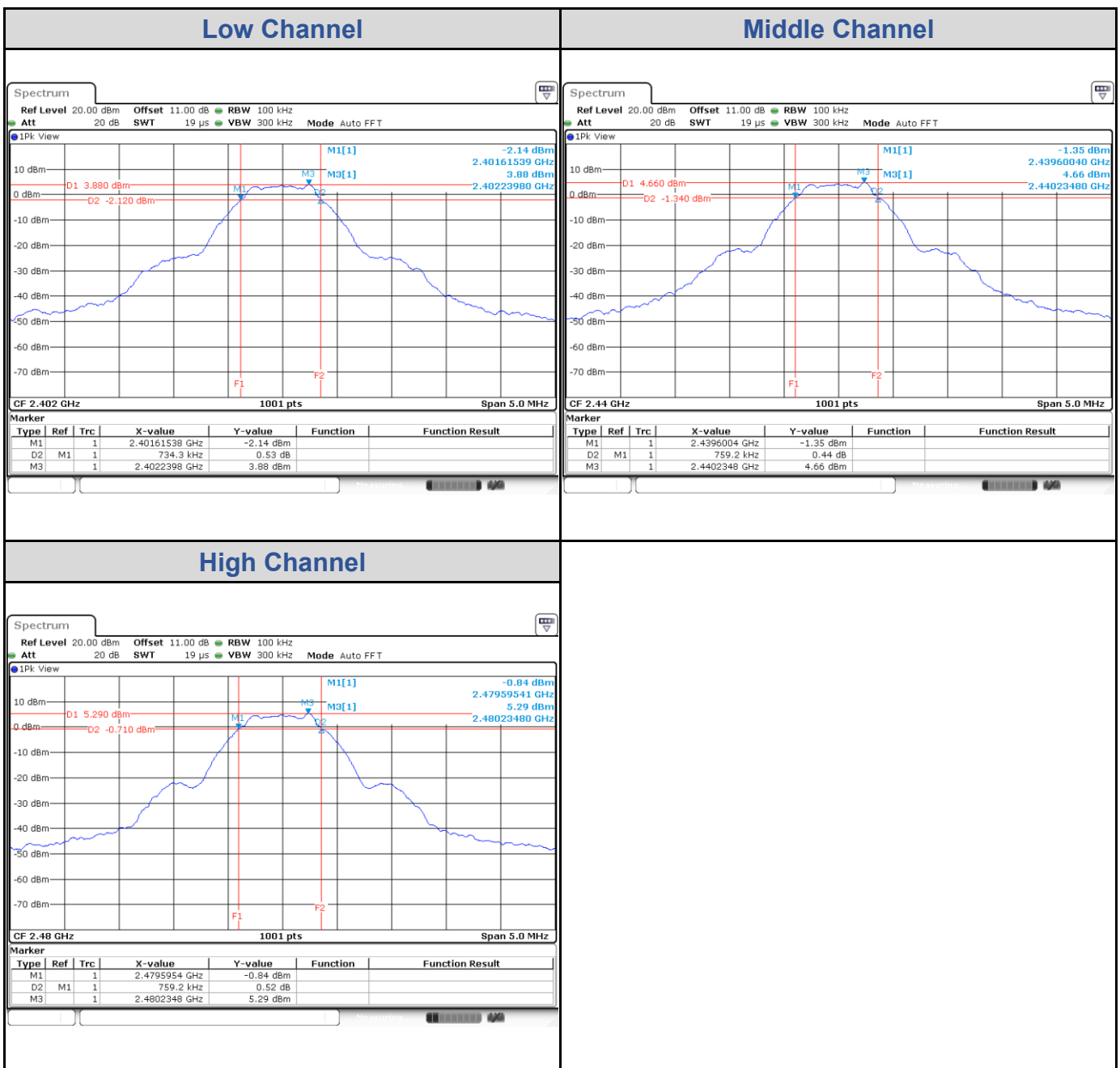

BLE_2M

Channel	Channel Frequency (MHz)	6 dB Bandwidth (MHz)	Limit (MHz)	Result
Low Channel	2404	1.31	0.5	Pass
Middle Channel	2440	1.35	0.5	Pass
High Channel	2478	1.50	0.5	Pass

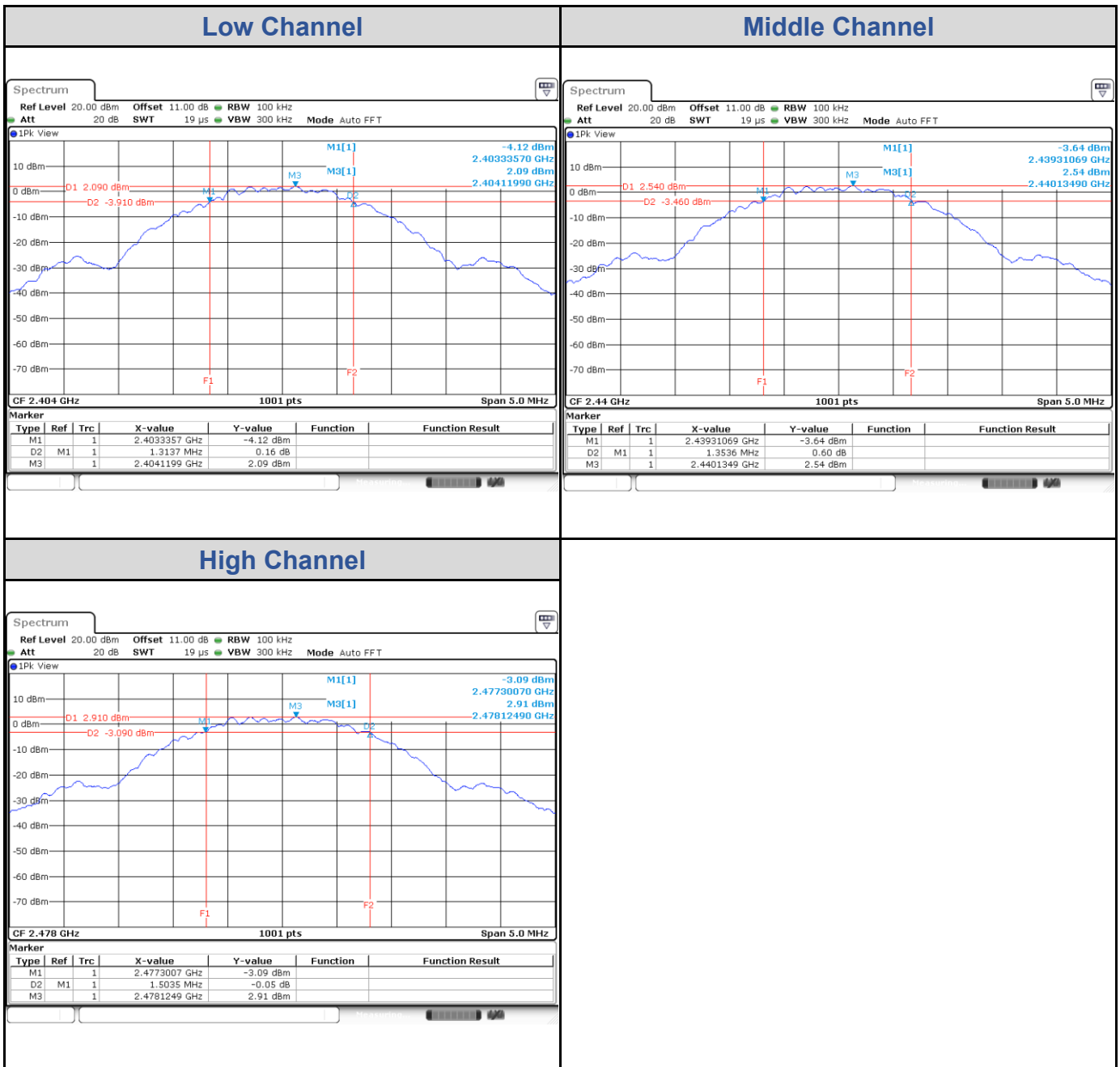

Test Result of 99% Occupied Bandwidth

BLE_1M

Channel	Channel Frequency (MHz)	99% Bandwidth (MHz)
Low Channel	2402	1.10
Middle Channel	2440	1.13
High Channel	2480	1.11

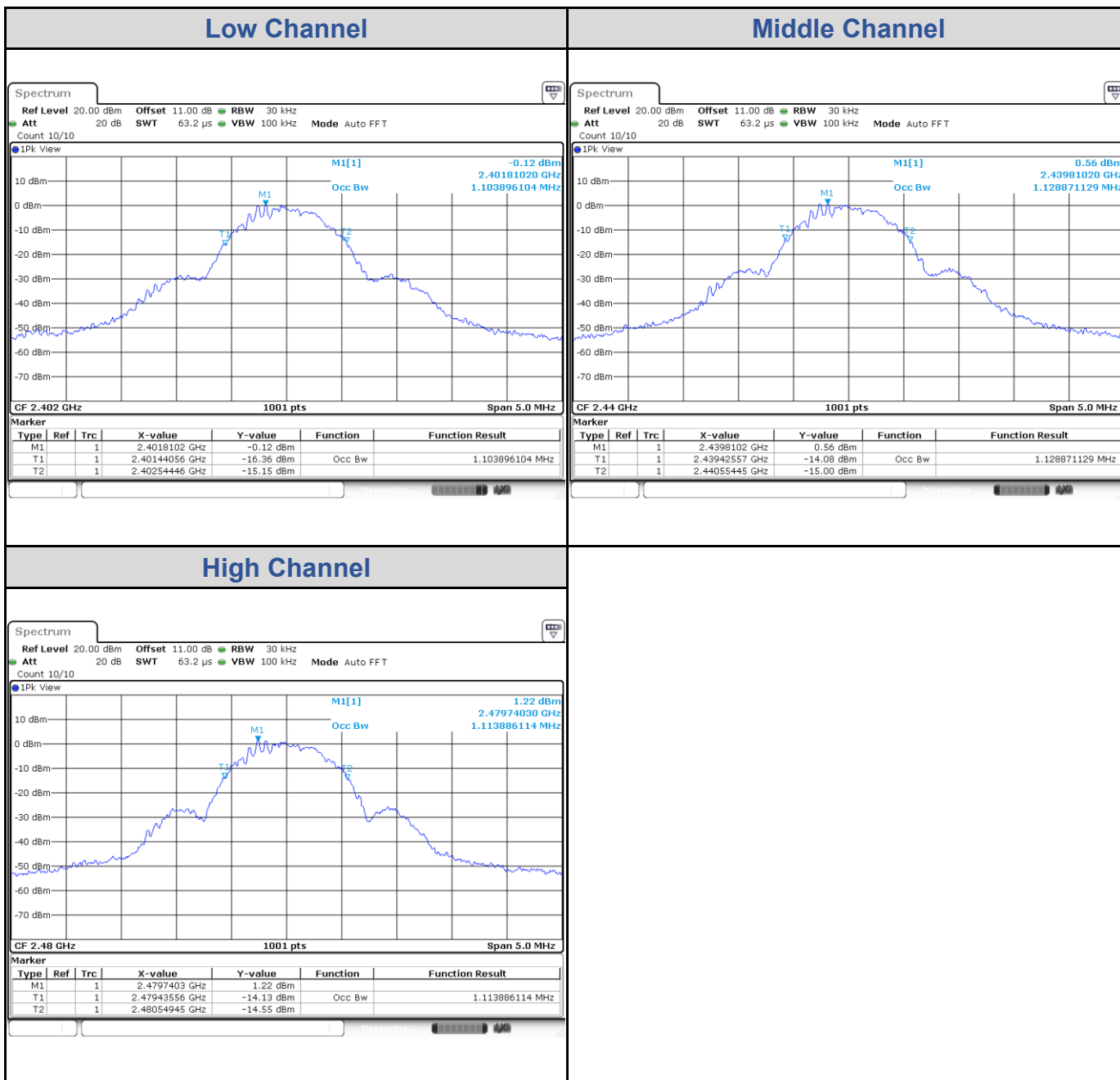

BLE_2M

Channel	Channel Frequency (MHz)	99% Bandwidth (MHz)
Low Channel	2404	2.22
Middle Channel	2440	2.33
High Channel	2478	2.39

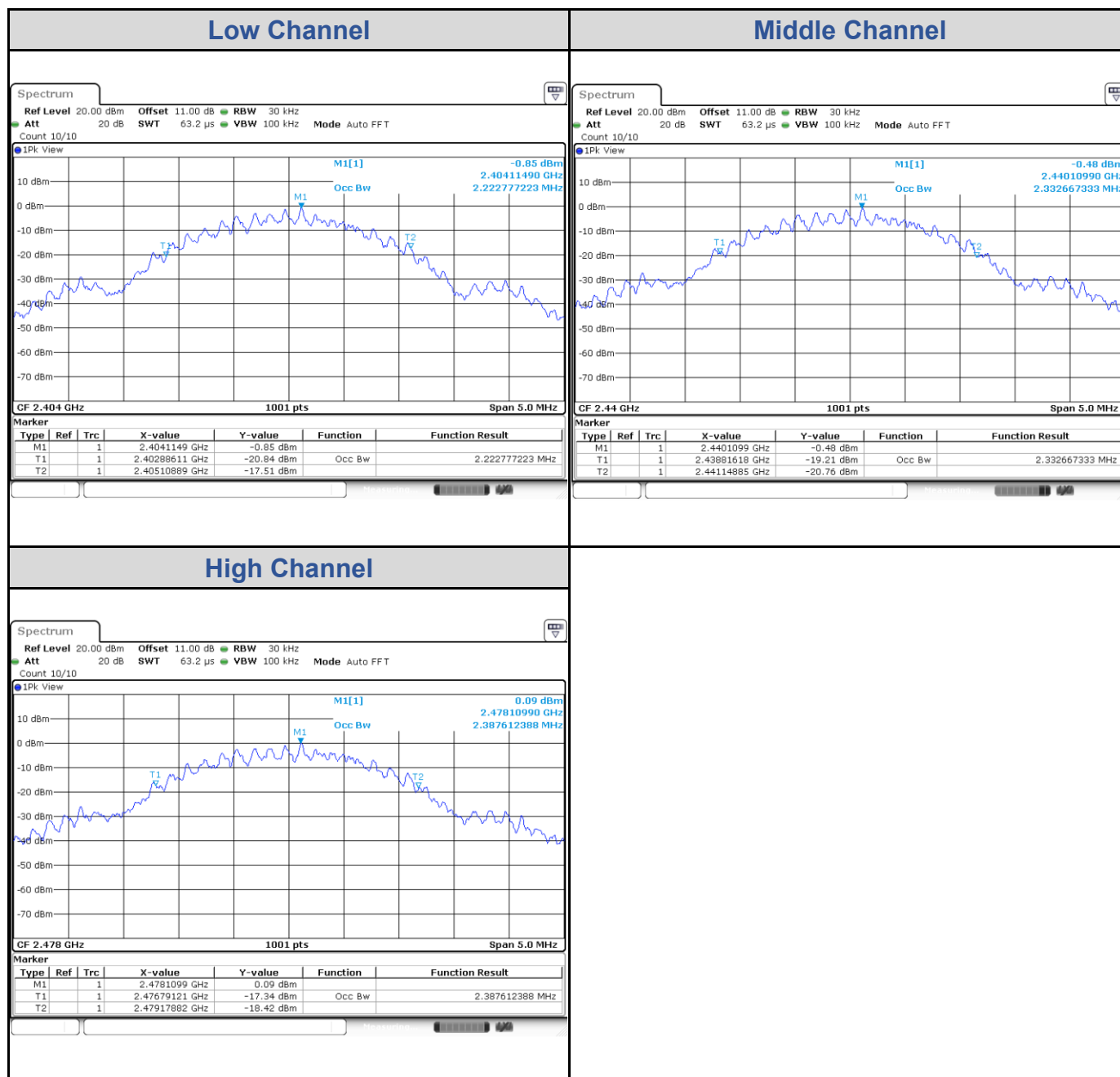

Test Result of Power Spectral Density

BLE_1M

Channel	Channel Frequency (MHz)	Power Density (dBm)	Limit (dBm)	Result
Low Channel	2402	-12.05	8	Pass
Middle Channel	2440	-11.32	8	Pass
High Channel	2480	-10.75	8	Pass

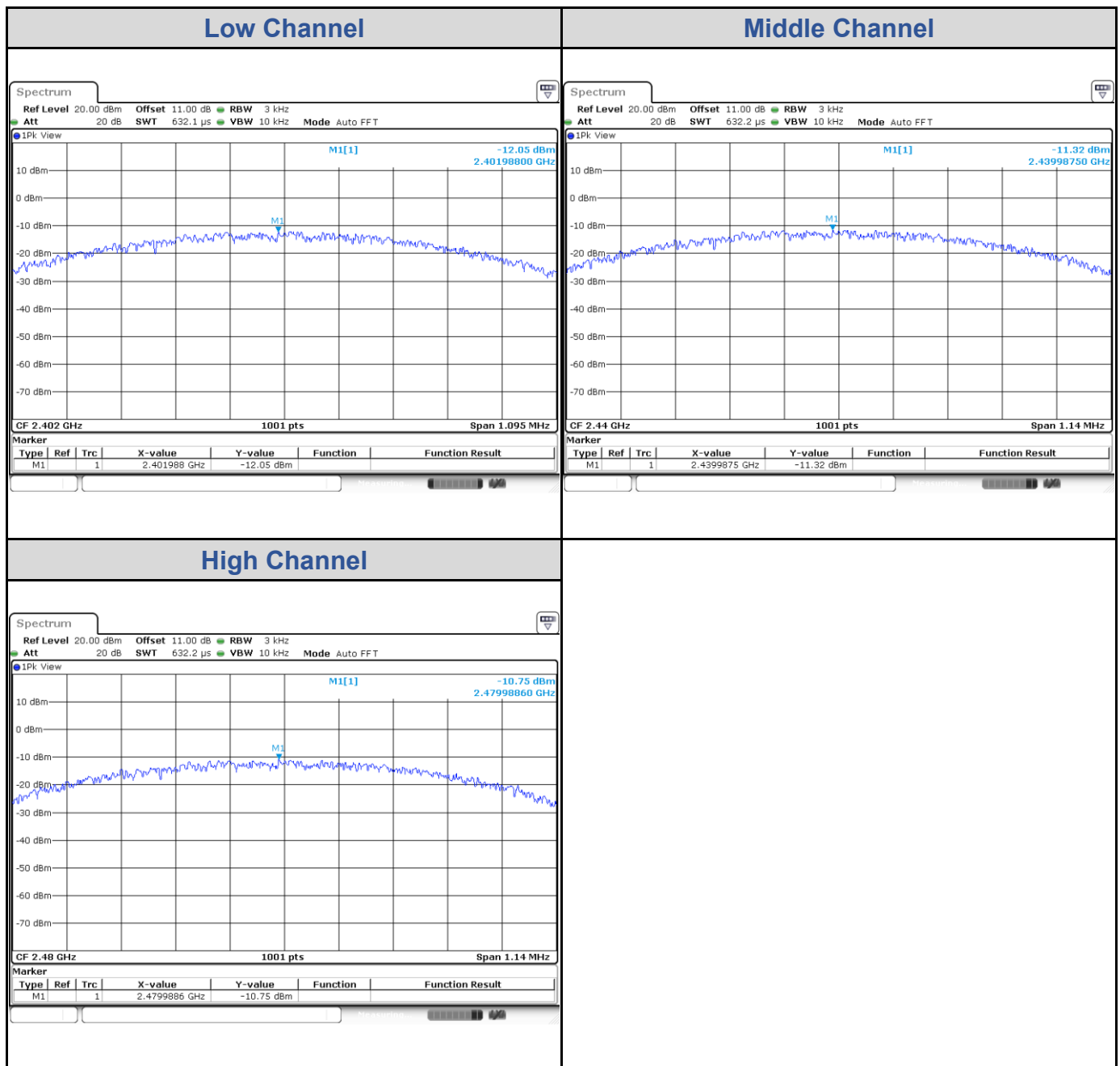

BLE_2M

Channel	Channel Frequency (MHz)	Power Density (dBm)	Limit (dBm)	Result
Low Channel	2404	-11.85	8	Pass
Middle Channel	2440	-11.45	8	Pass
High Channel	2478	-11.30	8	Pass

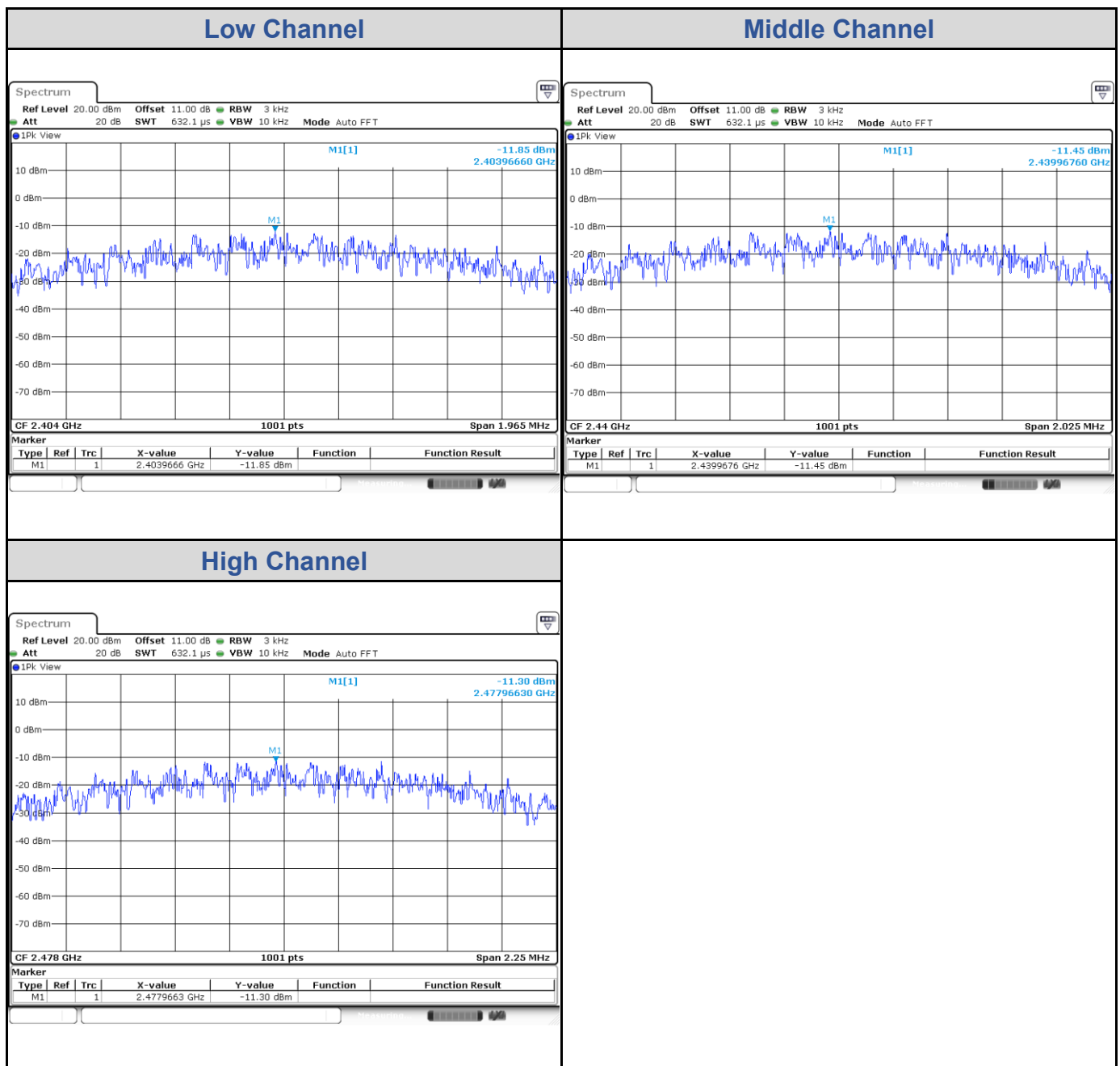

Test Result of Conducted Spurious Emissions

BLE_1M

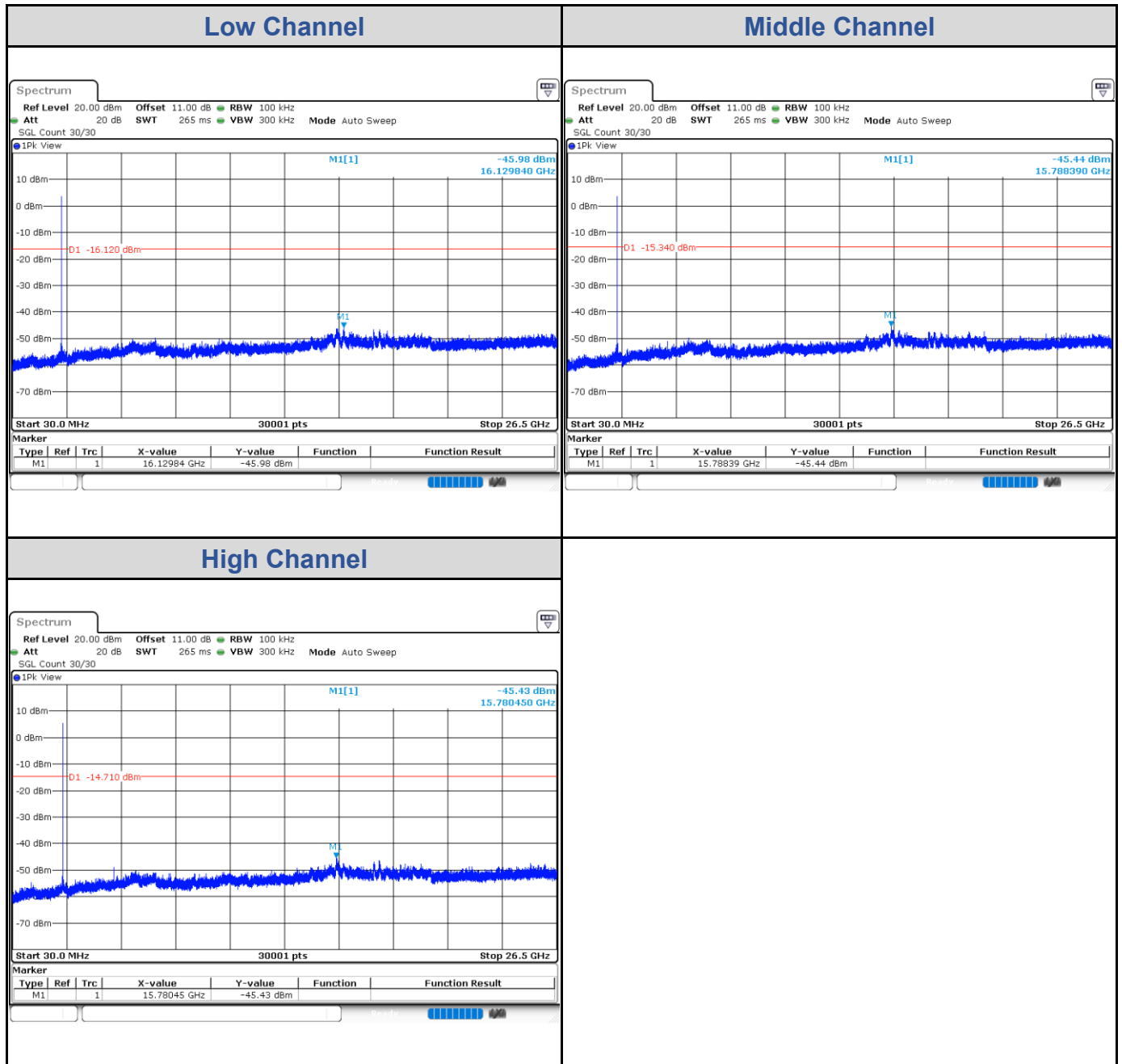

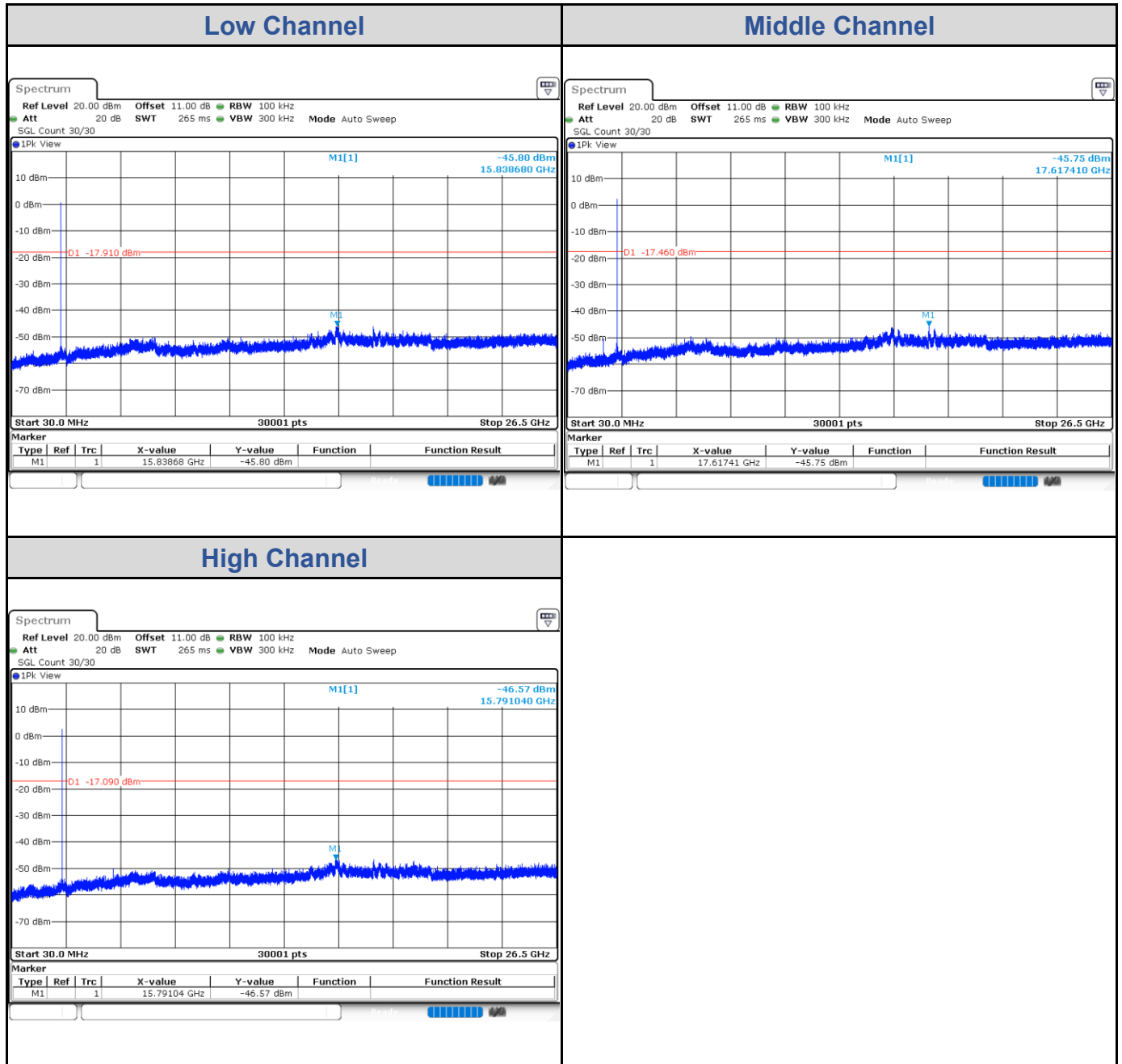
BLE_2M

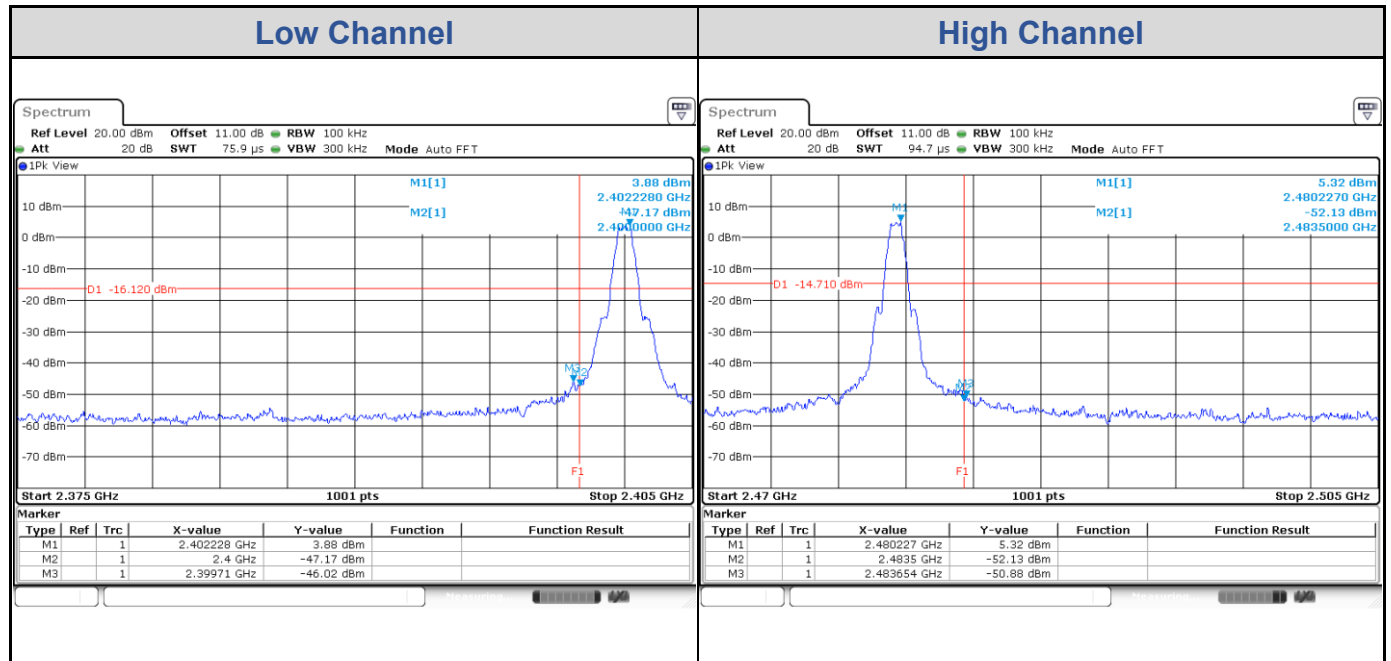
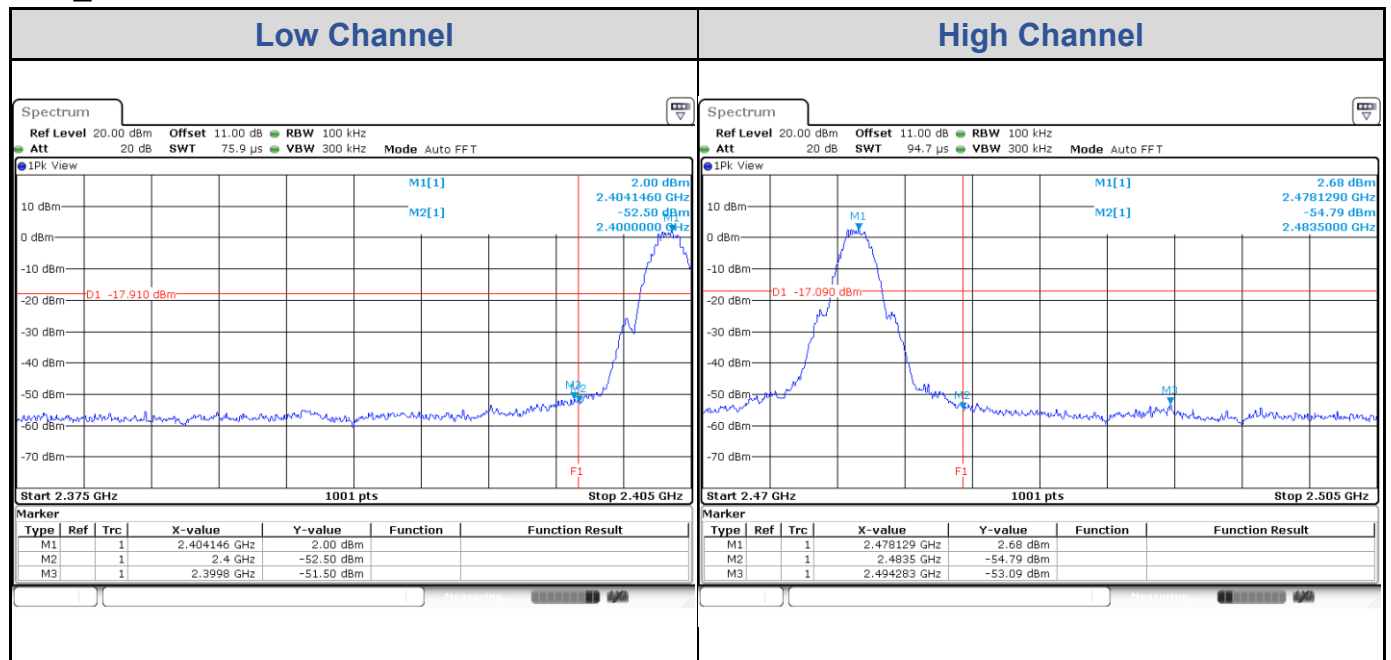
Test Result of Conducted Band Edge
BLE_1M

BLE_2M

Appendix B: Test Results of Radiated Spurious Emissions & Mains

Conducted Emission Test

Band Edges, 2.31GHz ~ 2.9GHz

SRD_1M

Low Channel (Horizontal) Peak

Low Channel (Vertical) Peak



TUV Rheinland Taiwan Ltd.
No. 458-18, Sec 2, Fenliao, Linkou Dist., New Taipei City 244, Taiwan(R.O.C.)
Tel: +886-2172-1000 Fax: +886-2172-1322



TUV Rheinland Taiwan Ltd.
No. 458-18, Sec 2, Fenliao, Linkou Dist., New Taipei City 244, Taiwan(R.O.C.)
Tel: +886-2172-1000 Fax: +886-2172-1322

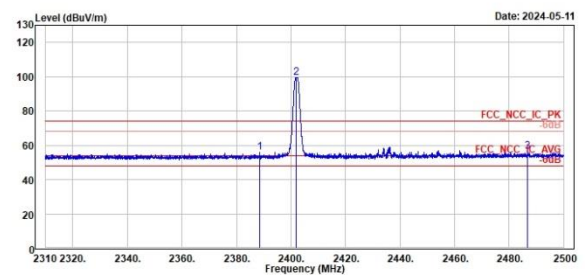
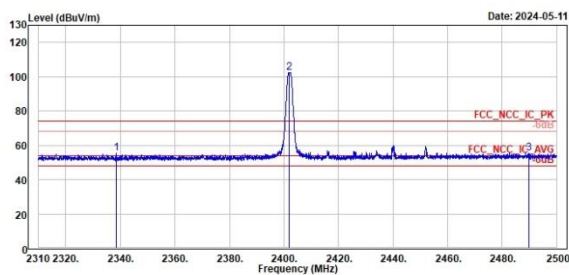

Peak	Freq (MHz)	Level (dBuV/m)	Read Level (dBuV)	Factor (dB/m)	Limit Line (dBuV/m)	Over Limit (dB)	APos (cm)	TPos (deg)	Remark	Pol/Phase	Note
1	2338.45	55.18	17.31	37.87	74.00	-18.82	159	207	Peak	Horizontal	
2 *	2402.00	102.46	64.36	38.10	74.00	28.46	159	207	Peak	Horizontal	
3	2489.79	55.19	16.87	38.32	74.00	-18.81	159	207	Peak	Horizontal	

Peak	Freq (MHz)	Level (dBuV/m)	Read Level (dBuV)	Factor (dB/m)	Limit Line (dBuV/m)	Over Limit (dB)	APos (cm)	TPos (deg)	Remark	Pol/Phase	Note
1	2308.57	55.84	17.78	38.06	74.00	-18.16	345	146	Peak	Vertical	
2 *	2402.00	99.41	61.31	38.10	74.00	25.41	345	146	Peak	Vertical	
3	2486.65	56.47	18.15	38.32	74.00	-17.53	345	146	Peak	Vertical	

SRD_1M

Low Channel (Horizontal) Average

Low Channel (Vertical) Average

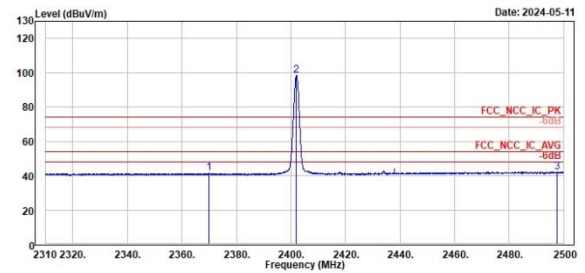
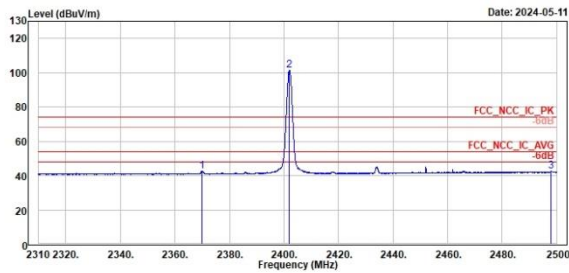

1	2	3
Level	Level	Level
dBuV/m	dBuV/m	dBuV/m
42.67	101.52	42.42
4.60	63.42	4.11
37.99	38.10	38.31
54.00	54.00	54.00
-11.33	47.52	-11.58
159	159	159
207	207	207
Average	Average	Average
Horizontal	Horizontal	Horizontal

1	2	3
Level	Level	Level
dBuV/m	dBuV/m	dBuV/m
41.41	98.45	42.08
3.42	60.35	3.77
37.99	38.10	38.31
54.00	54.00	54.00
-12.59	44.45	-11.92
345	345	345
146	146	146
Average	Average	Average
Vertical	Vertical	Vertical

SRD_1M

Middle Channel (Horizontal) Peak

Middle Channel (Vertical) Peak



TUV Rheinland Taiwan Ltd.
No. 458-18, Sec 2, Fenliao, Linkou Dist., New Taipei City 244, Taiwan(R.O.C.)
Tel: +886-2172-1000 Fax: +886-2172-1322

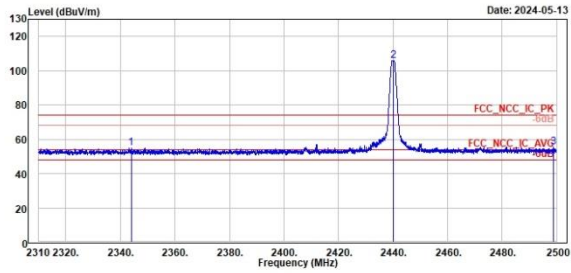

Peak	Freq (MHz)	Level (dBuV/m)	Read Level (dBuV)	Factor (dB/m)	Limit Line (dBuV/m)	Over Limit (dB)	APos (cm)	TPos (deg)	Remark	Pol/Phase	Note
1	2343.96	54.02	16.92	37.90	74.00	-19.18	301	198	Peak	Horizontal	
2 *	2440.00	105.91	67.61	38.30	74.00	31.91	301	198	Peak	Horizontal	
3	2498.77	55.21	16.90	38.31	74.00	-18.79	301	198	Peak	Horizontal	



TUV Rheinland Taiwan Ltd.
No. 458-18, Sec 2, Fenliao, Linkou Dist., New Taipei City 244, Taiwan(R.O.C.)
Tel: +886-2172-1000 Fax: +886-2172-1322

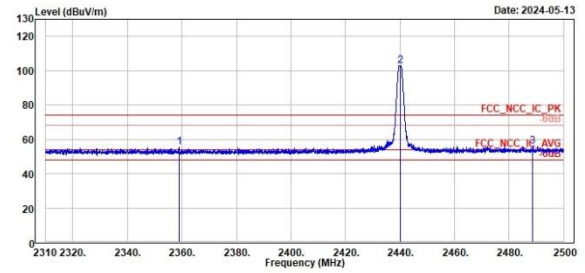

Peak	Freq (MHz)	Level (dBuV/m)	Read Level (dBuV)	Factor (dB/m)	Limit Line (dBuV/m)	Over Limit (dB)	APos (cm)	TPos (deg)	Remark	Pol/Phase	Note
1	2358.00	55.20	17.24	37.96	74.00	-18.00	367	254	Peak	Vertical	
2 *	2440.00	102.98	64.68	38.30	74.00	28.98	367	254	Peak	Vertical	
3	2488.55	55.78	17.46	38.32	74.00	-18.22	367	254	Peak	Vertical	

SRD_1M

Middle Channel (Horizontal) Average

Middle Channel (Vertical) Average



TUV Rheinland Taiwan Ltd.
No. 458-18, Sec 2, Fenliao, Linkou Dist., New Taipei City 244, Taiwan(R.O.C.)
Tel: +886-2172-1000 Fax: +886-2172-1322

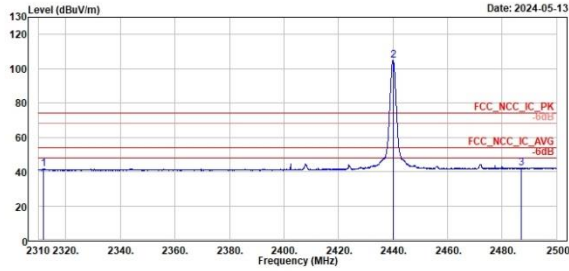

Freq	Level	Read Level	Factor	Limit Line	Over Limit	APos	TPos	Remark	Pol/Phase	Note
MHz	dBuV/m	dBuV	dB/m	dBuV/m	dB	cm	deg			
1	2311.81	41.72	3.99	37.73	54.00	-12.28	301	198 Average	Horizontal	
2 *	2440.00	104.85	66.55	38.30	54.00	50.85	301	198 Average	Horizontal	
3	2487.13	42.19	3.87	38.32	54.00	-11.81	301	198 Average	Horizontal	



TUV Rheinland Taiwan Ltd.
No. 458-18, Sec 2, Fenliao, Linkou Dist., New Taipei City 244, Taiwan(R.O.C.)
Tel: +886-2172-1000 Fax: +886-2172-1322

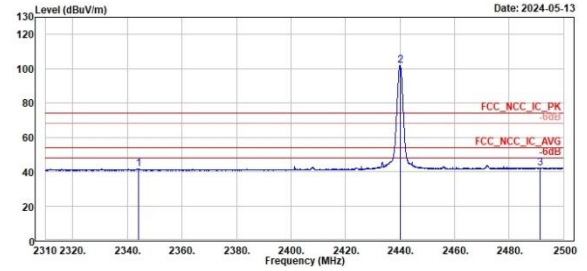

Freq	Level	Read Level	Factor	Limit Line	Over Limit	APos	TPos	Remark	Pol/Phase	Note
MHz	dBuV/m	dBuV	dB/m	dBuV/m	dB	cm	deg			
1	2344.15	41.69	3.79	37.90	54.00	-12.31	367	254 Average	Vertical	
2 *	2440.00	101.88	63.58	38.30	54.00	47.88	367	254 Average	Vertical	
3	2491.26	42.13	3.81	38.32	54.00	-11.87	367	254 Average	Vertical	

SRD_1M

High Channel (Horizontal) Peak

High Channel (Vertical) Peak

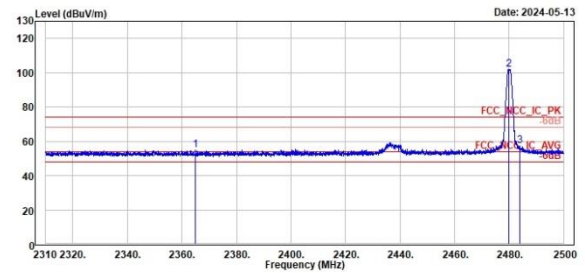
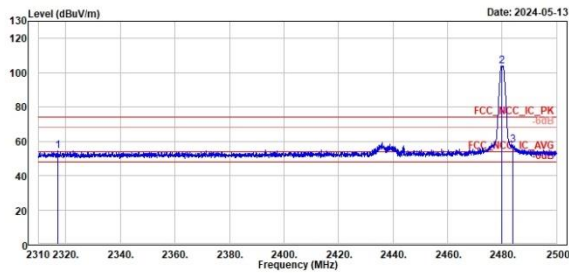

Peak	Freq (MHz)	Level (dBuV/m)	Read Level (dBuV)	Level Factor (dB/m)	Limit Line (dBuV/m)	Over Limit (dB)	APos (cm)	TPos (deg)	Remark	Pol/Phase	Note
1	2317.03	54.40	15.64	37.76	74.00	-19.60	287	293	Peak	Horizontal	
2 *	2480.00	103.00	65.47	38.33	74.00	29.00	287	293	Peak	Horizontal	
3	2483.95	58.08	19.76	38.32	74.00	-15.92	287	293	Peak	Horizontal	

Peak	Freq (MHz)	Level (dBuV/m)	Read Level (dBuV)	Level Factor (dB/m)	Limit Line (dBuV/m)	Over Limit (dB)	APos (cm)	TPos (deg)	Remark	Pol/Phase	Note
1	2364.96	55.05	17.07	37.98	74.00	-18.95	326	262	Peak	Vertical	
2 *	2480.00	101.64	63.31	38.33	74.00	27.64	326	262	Peak	Vertical	
3	2483.90	57.31	18.99	38.32	74.00	-16.69	326	262	Peak	Vertical	

SRD_1M

High Channel (Horizontal) Average

High Channel (Vertical) Average



TUV Rheinland Taiwan Ltd.
No. 458-18, Sec 2, Fenliao, Linkou Dist., New Taipei City 244, Taiwan(R.O.C.)
Tel: +886-2172-1000 Fax: +886-2172-1322

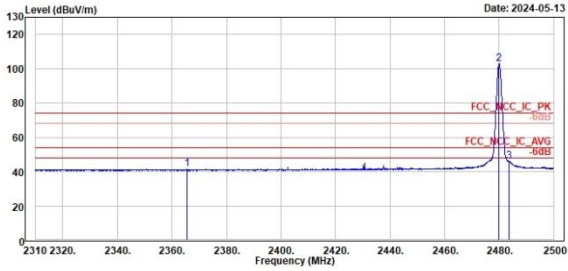

1	2	3	4	5	6	7	8	9	10	11	12	13	14	15	16	17	18	19	20
Freq	Level	Read	Limit	Over	APos	TPos	Remark	Pol/Phase	Note										
MHz	dBuV/m	dBuV	dB/m	dBuV/m	dB	cm	deg												
2365.67	41.34	3.36	37.98	54.00	-12.66	287	293 Average	Horizontal											
2480.00	102.71	64.38	38.33	54.00	48.71	287	293 Average	Horizontal											
2483.52	46.12	7.80	38.32	54.00	-7.88	287	293 Average	Horizontal											



TUV Rheinland Taiwan Ltd.
No. 458-18, Sec 2, Fenliao, Linkou Dist., New Taipei City 244, Taiwan(R.O.C.)
Tel: +886-2172-1000 Fax: +886-2172-1322

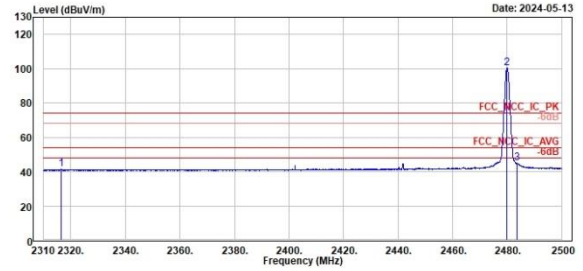

1	2	3	4	5	6	7	8	9	10	11	12	13	14	15	16	17	18	19	20
Freq	Level	Read	Limit	Over	APos	TPos	Remark	Pol/Phase	Note										
MHz	dBuV/m	dBuV	dB/m	dBuV/m	dB	cm	deg												
2316.56	41.38	3.62	37.76	54.00	-12.62	326	262 Average	Vertical											
2480.00	100.55	62.22	38.33	54.00	46.55	326	262 Average	Vertical											
2483.61	44.89	6.57	38.32	54.00	-9.11	326	262 Average	Vertical											

SRD_2M

Low Channel (Horizontal) Peak

Low Channel (Vertical) Peak



TUV Rheinland Taiwan Ltd.
No. 458-18, Sec 2, Fenliao, Linkou Dist., New Taipei City 244, Taiwan(R.O.C.)
Tel: +886-2172-1000 Fax: +886-2172-1322

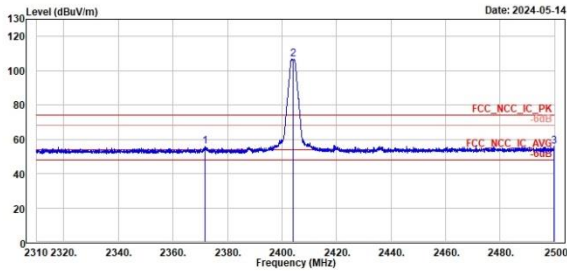

Peak	Freq (MHz)	Level (dBuV/m)	Read Level (dBuV)	Factor (dB/m)	Limit Line (dBuV/m)	Over Limit (dB)	APos (cm)	TPos (deg)	Remark	Pol/Phase	Note
1	2371.70	55.70	17.70	38.00	74.00	-18.30	348	198	Peak	Horizontal	
2 *	2404.00	106.57	68.46	38.11	74.00	32.57	348	198	Peak	Horizontal	
3	2499.62	55.92	17.61	38.31	74.00	-18.08	348	198	Peak	Horizontal	



TUV Rheinland Taiwan Ltd.
No. 458-18, Sec 2, Fenliao, Linkou Dist., New Taipei City 244, Taiwan(R.O.C.)
Tel: +886-2172-1000 Fax: +886-2172-1322

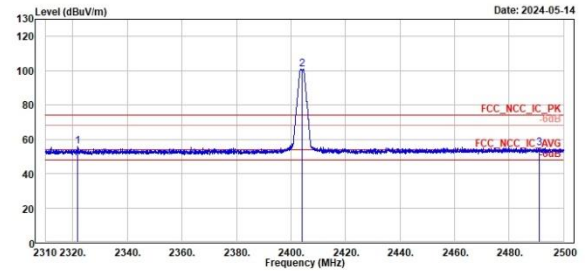

Peak	Freq (MHz)	Level (dBuV/m)	Read Level (dBuV)	Factor (dB/m)	Limit Line (dBuV/m)	Over Limit (dB)	APos (cm)	TPos (deg)	Remark	Pol/Phase	Note
1	2321.80	56.02	18.23	37.79	74.00	-17.98	344	147	Peak	Vertical	
2 *	2404.00	100.87	62.76	38.11	74.00	26.87	344	147	Peak	Vertical	
3	2499.98	55.06	16.74	38.32	74.00	-18.94	344	147	Peak	Vertical	

SRD_2M

Low Channel (Horizontal) Average

Low Channel (Vertical) Average



TUV Rheinland Taiwan Ltd.
No. 458-18, Sec 2, Fenliao, Linkou Dist., New Taipei City 244, Taiwan(R.O.C.)
Tel: +886-2172-1000 Fax: +886-2172-1322

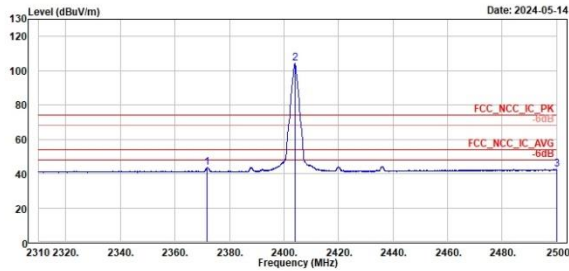

1	2	3
Level	Level	Level
Factor	Factor	Factor
Line	Line	Line
Limit	Limit	Limit
Over	Over	Over
Limit	Limit	Limit
APos	APos	APos
TPos	TPos	TPos
Remark	Remark	Remark
Pol/Phase	Pol/Phase	Pol/Phase
Note	Note	Note
2371.89	2404.00	2500.00
43.74	104.16	42.53
5.74	66.85	4.22
38.00	38.11	38.31
54.00	54.00	54.00
-10.26	50.16	-11.47
348	348	348
198	198	198
Average	Average	Average
Horizontal	Horizontal	Horizontal



TUV Rheinland Taiwan Ltd.
No. 458-18, Sec 2, Fenliao, Linkou Dist., New Taipei City 244, Taiwan(R.O.C.)
Tel: +886-2172-1000 Fax: +886-2172-1322

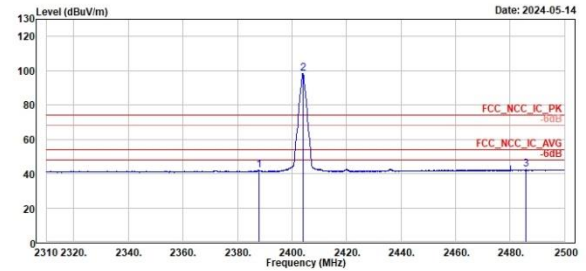

1	2	3
Level	Level	Level
Factor	Factor	Factor
Line	Line	Line
Limit	Limit	Limit
Over	Over	Over
Limit	Limit	Limit
APos	APos	APos
TPos	TPos	TPos
Remark	Remark	Remark
Pol/Phase	Pol/Phase	Pol/Phase
Note	Note	Note
2387.85	2404.00	2485.85
41.83	98.48	42.30
3.77	60.29	3.98
38.06	38.11	38.32
54.00	54.00	54.00
-12.17	44.40	-11.70
344	344	344
147	147	147
Average	Average	Average
Vertical	Vertical	Vertical

SRD_2M

Middle Channel (Horizontal) Peak

Middle Channel (Vertical) Peak

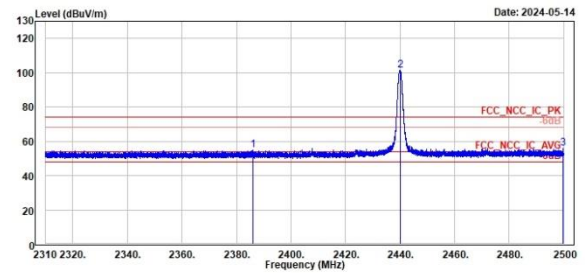
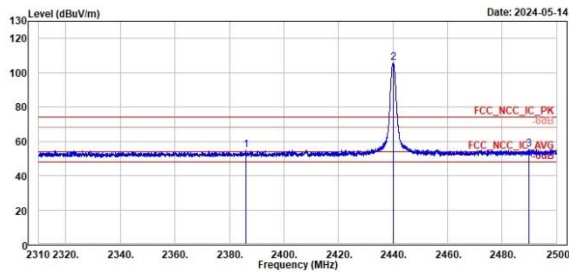

Peak	Freq (MHz)	Level (dBuV/m)	Read Level (dBuV)	Factor (dB/m)	Limit Line (dBuV/m)	Over Limit (dB)	APos (cm)	TPos (deg)	Remark	Pol/Phase	Note
1	2386.05	54.63	15.59	38.04	74.00	-19.37	288	203	Peak	Horizontal	
2 *	2440.00	105.56	67.26	38.30	74.00	31.56	288	203	Peak	Horizontal	
3	2489.84	55.33	17.01	38.32	74.00	-18.67	288	203	Peak	Horizontal	

Peak	Freq (MHz)	Level (dBuV/m)	Read Level (dBuV)	Factor (dB/m)	Limit Line (dBuV/m)	Over Limit (dB)	APos (cm)	TPos (deg)	Remark	Pol/Phase	Note
1	2386.01	55.10	17.06	38.04	74.00	-18.90	375	264	Peak	Vertical	
2 *	2440.00	101.56	63.26	38.30	74.00	27.56	375	264	Peak	Vertical	
3	2499.82	55.69	17.38	38.31	74.00	-18.31	375	264	Peak	Vertical	

SRD_2M

Middle Channel (Horizontal) Average

Middle Channel (Vertical) Average



TUV Rheinland Taiwan Ltd.
No. 458-18, Sec 2, Fenliao, Linkou Dist., New Taipei City 244, Taiwan(R.O.C.)
Tel: +886-2172-1000 Fax: +886-2172-1322

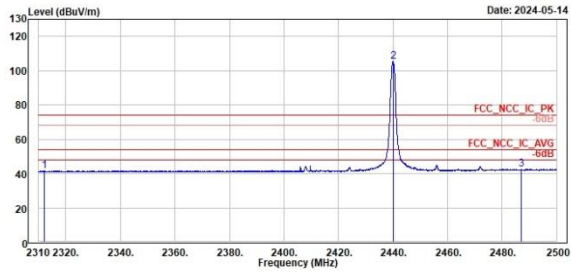

Freq	Level	Read Level	Factor	Limit Line	Over Limit	APos	TPos	Remark	Pol/Phase	Note
MHz	dBuV/m	dBuV	dB/m	dBuV/m	dB	cm	deg			
1	2312.14	41.74	4.01	37.73	54.00	-12.26	288	203 Average	Horizontal	
2 *	2440.00	105.50	67.20	38.30	54.00	51.50	288	203 Average	Horizontal	
3	2496.89	42.48	4.16	38.32	54.00	-11.52	288	203 Average	Horizontal	



TUV Rheinland Taiwan Ltd.
No. 458-18, Sec 2, Fenliao, Linkou Dist., New Taipei City 244, Taiwan(R.O.C.)
Tel: +886-2172-1000 Fax: +886-2172-1322

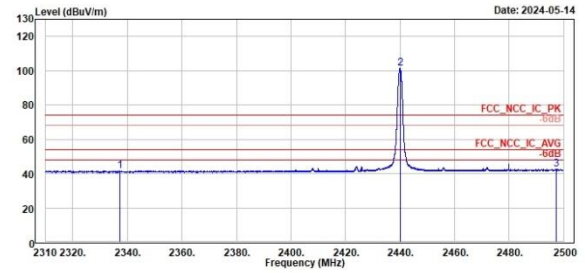

Freq	Level	Read Level	Factor	Limit Line	Over Limit	APos	TPos	Remark	Pol/Phase	Note
MHz	dBuV/m	dBuV	dB/m	dBuV/m	dB	cm	deg			
1	2337.20	41.63	3.77	37.86	54.00	-12.37	375	264 Average	Vertical	
2 *	2440.00	101.49	63.19	38.30	54.00	47.49	375	264 Average	Vertical	
3	2497.32	42.43	4.11	38.32	54.00	-11.57	375	264 Average	Vertical	

SRD_2M

High Channel (Horizontal) Peak

High Channel (Vertical) Peak

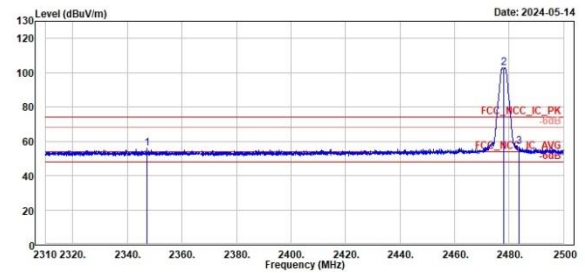
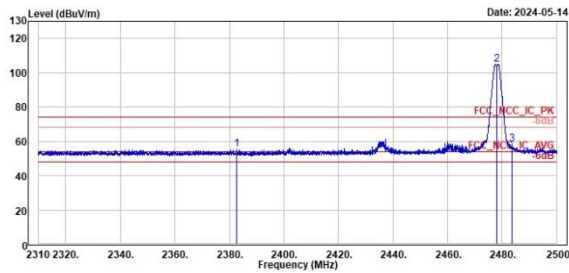

Peak	Freq (MHz)	Level (dBuV/m)	Read Level (dBuV)	Level Factor (dB/m)	Limit Line (dBuV/m)	Over Limit (dB)	APos (cm)	TPos (deg)	Remark	Pol/Phase	Note
1	2382.53	55.37	17.33	38.04	74.00	-18.63	160	212	Peak	Horizontal	
2 *	2478.00	104.86	66.56	38.32	74.00	30.86	160	212	Peak	Horizontal	
3	2483.52	58.18	19.86	38.32	74.00	-15.82	160	212	Peak	Horizontal	

Peak	Freq (MHz)	Level (dBuV/m)	Read Level (dBuV)	Level Factor (dB/m)	Limit Line (dBuV/m)	Over Limit (dB)	APos (cm)	TPos (deg)	Remark	Pol/Phase	Note
1	2347.24	55.62	17.70	37.92	74.00	-18.38	361	255	Peak	Vertical	
2 *	2478.00	102.87	64.55	38.32	74.00	28.87	361	255	Peak	Vertical	
3	2483.52	57.03	18.71	38.32	74.00	-16.97	361	255	Peak	Vertical	

SRD_2M

High Channel (Horizontal) Average

High Channel (Vertical) Average



TÜV Rheinland Taiwan Ltd.
No. 458-18, Sec 2, Fenliao, Linkou Dist., New Taipei City 244, Taiwan(R.O.C.)
Tel: +886-2172-1000 Fax: +886-2172-1322

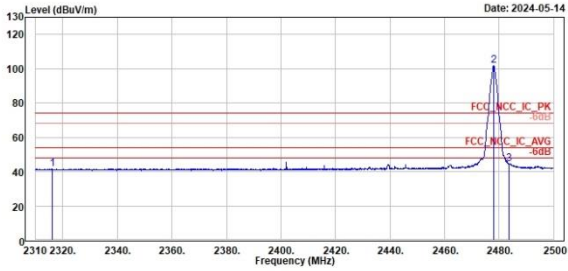

1	2	3	Read Level	Read Level Factor	Limit Line	Over Limit	APos	TPos	Remark	Pol/Phase	Note
MHz	dBuV/m	dBuV	dB/m	dBuV/m	dB	cm	deg				
2316.22	41.70	3.95	37.75	54.00	-12.30	160	212	Average	Horizontal		
2478.00	101.84	63.52	38.32	54.00	47.84	160	212	Average	Horizontal		
2483.57	44.66	6.34	38.32	54.00	-9.34	160	212	Average	Horizontal		



TÜV Rheinland Taiwan Ltd.
No. 458-18, Sec 2, Fenliao, Linkou Dist., New Taipei City 244, Taiwan(R.O.C.)
Tel: +886-2172-1000 Fax: +886-2172-1322

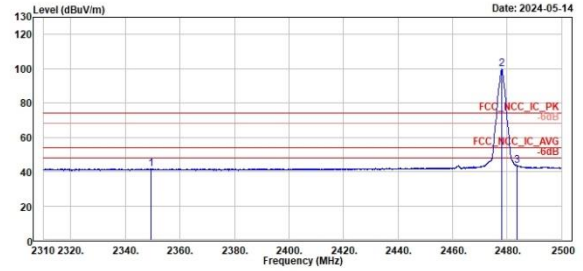

1	2	3	Read Level	Read Level Factor	Limit Line	Over Limit	APos	TPos	Remark	Pol/Phase	Note
MHz	dBuV/m	dBuV	dB/m	dBuV/m	dB	cm	deg				
2349.43	41.69	3.76	37.93	54.00	-12.31	361	255	Average	Vertical		
2478.00	99.74	61.42	38.32	54.00	45.74	361	255	Average	Vertical		
2483.57	43.71	5.39	38.32	54.00	-10.29	361	255	Average	Vertical		

Spurious Emissions, Tx Mode, 9kHz ~ 30MHz

SRD_1M

Middle Channel (Open) 9kHz~150kHz

Middle Channel (Open) 150kHz~30MHz



TUV Rheinland Taiwan Ltd.
No. 458-18, Sec 2, Fenliao, Linkou Dist., New Taipei City 244, Taiwan(R.O.C.)
Tel: +886-2172-1000 Fax: +886-2172-1322

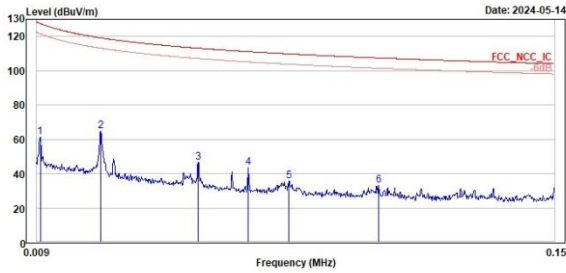

Peak	Freq (MHz)	Level (dBuV/m)	Read Level (dBuV)	Level Factor (dB/m)	Limit Line (dBuV/m)	Over Limit (dB)	APos (cm)	TPos (deg)	Remark	PoL/Phase	Note
1	0.01	61.21	42.90	18.31	127.60	-66.39	100	238	Peak	Open	
2	0.03	64.90	45.09	19.81	119.13	-54.23	100	117	Peak	Open	
3	0.05	46.48	27.18	19.30	113.11	-66.63	100	117	Peak	Open	
4	0.07	43.74	25.00	18.74	111.12	-67.38	100	201	Peak	Open	
5	0.08	35.51	16.95	18.56	109.79	-74.28	100	278	Peak	Open	
6	0.10	33.01	14.49	18.52	107.41	-74.40	100	151	Peak	Open	



TUV Rheinland Taiwan Ltd.
No. 458-18, Sec 2, Fenliao, Linkou Dist., New Taipei City 244, Taiwan(R.O.C.)
Tel: +886-2172-1000 Fax: +886-2172-1322

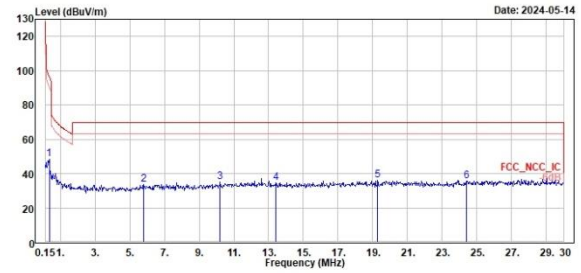

Peak	Freq (MHz)	Level (dBuV/m)	Read Level (dBuV)	Level Factor (dB/m)	Limit Line (dBuV/m)	Over Limit (dB)	APos (cm)	TPos (deg)	Remark	PoL/Phase	Note
1	0.36	48.61	29.52	19.09	96.50	-47.89	100	205	Peak	Open	
2	5.82	33.72	13.09	20.63	69.50	-35.78	100	185	Peak	Open	
3	10.21	35.15	13.92	21.23	69.50	-34.35	100	354	Peak	Open	
4	13.40	34.59	13.21	21.38	69.50	-34.91	100	160	Peak	Open	
5	19.28	36.32	13.85	22.47	69.50	-33.18	100	164	Peak	Open	
6	24.42	35.54	13.05	22.49	69.50	-33.96	100	170	Peak	Open	

Spurious Emissions, Tx Mode, 30MHz ~ 1GHz
SRD_1M
Middle Channel (Horizontal)
Middle Channel (Vertical)

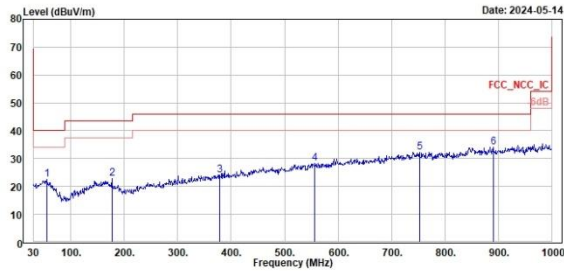

TÜV Rheinland Taiwan Ltd.
 No. 458-18, Sec 2, Fenliao, Linkou Dist., New Taipei City 244, Taiwan(R.O.C.)
 Tel: +886-2172-1000 Fax: +886-2172-1322



Peak	Freq (MHz)	Level (dBuV/m)	Read Level (dBuV)	Factor (dB/m)	Limit Line (dBuV/m)	Over Limit (dB)	APos (cm)	TPos (deg)	Remark	Pol/Phase	Note
1	55.22	22.62	28.88	-6.26	48.00	-17.38	100	212	Peak	Horizontal	
2	176.47	22.75	29.51	-6.76	43.50	-20.75	200	229	Peak	Horizontal	
3	378.23	24.13	28.10	-3.97	46.00	-21.87	124	0	Peak	Horizontal	
4	556.71	28.30	28.49	-0.19	46.00	-17.70	200	350	Peak	Horizontal	
5	752.65	32.25	28.96	3.29	46.00	-13.75	100	292	Peak	Horizontal	
6	898.39	34.13	29.59	4.54	46.00	-11.87	100	62	Peak	Horizontal	

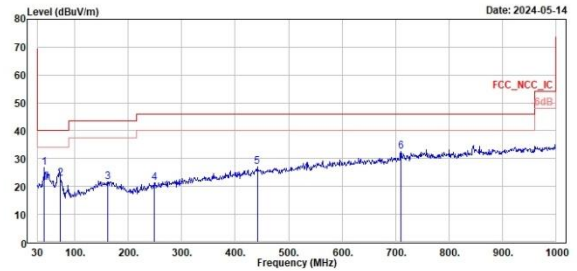

TÜV Rheinland Taiwan Ltd.
 No. 458-18, Sec 2, Fenliao, Linkou Dist., New Taipei City 244, Taiwan(R.O.C.)
 Tel: +886-2172-1000 Fax: +886-2172-1322



Peak	Freq (MHz)	Level (dBuV/m)	Read Level (dBuV)	Factor (dB/m)	Limit Line (dBuV/m)	Over Limit (dB)	APos (cm)	TPos (deg)	Remark	Pol/Phase	Note
1	42.61	26.71	33.36	-6.65	48.00	-13.29	100	280	Peak	Vertical	
2	72.68	22.82	32.45	-9.63	48.00	-17.18	100	260	Peak	Vertical	
3	161.92	21.68	27.70	-6.02	43.50	-21.82	100	353	Peak	Vertical	
4	248.25	21.17	28.27	-7.10	46.00	-24.83	200	214	Peak	Vertical	
5	441.28	26.92	29.32	-2.40	46.00	-19.08	100	168	Peak	Vertical	
6	709.97	32.44	30.17	2.27	46.00	-13.56	200	137	Peak	Vertical	

Spurious Emissions, Tx Mode, 1GHz ~ 26.5GHz

SRD_1M

Low Channel (Horizontal)

Low Channel (Vertical)



TUV Rheinland Taiwan Ltd.
No. 458-18, Sec 2, Fenliao, Linkou Dist., New Taipei City 244, Taiwan(R.O.C.)
Tel: +886-2172-1000 Fax: +886-2172-1322

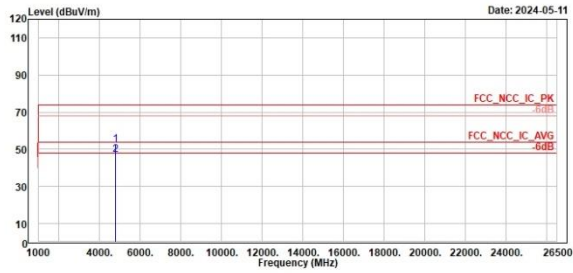

Read	Limit	Over	APos	TPos	Remark	Pol/Phase	Note
Level	Line	Limit					
dBuV/m	dBuV	dB	cm	deg			
52.44	74.00	-21.56	364	228	Peak	Horizontal	
46.88	54.00	-7.12	364	228	Average	Horizontal	



TUV Rheinland Taiwan Ltd.
No. 458-18, Sec 2, Fenliao, Linkou Dist., New Taipei City 244, Taiwan(R.O.C.)
Tel: +886-2172-1000 Fax: +886-2172-1322

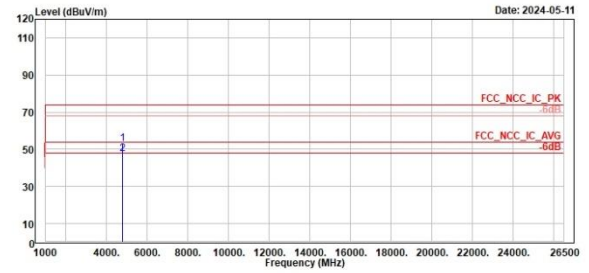

Read	Limit	Over	APos	TPos	Remark	Pol/Phase	Note
Level	Line	Limit					
dBuV/m	dBuV	dB	cm	deg			
52.78	74.00	-21.22	380	141	Peak	Vertical	
47.41	54.00	-6.59	380	141	Average	Vertical	

SRD_1M

Middle Channel (Horizontal)

Middle Channel (Vertical)



TUV Rheinland Taiwan Ltd.
No. 458-18, Sec 2, Fenliao, Linkou Dist., New Taipei City 244, Taiwan(R.O.C.)
Tel: +886-2172-1000 Fax: +886-2172-1322

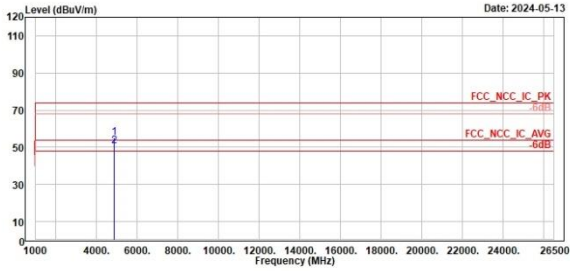

Freq	Level	Read Level	Factor	Limit Line	Over Limit	APos	TPos	Remark	Pol/Phase	Note
MHz	dBuV/m	dBuV	dB/m	dBuV/m	dB	cm	deg			
1	4880.00	55.09	63.81	-7.92	74.00	-18.91	180	35 Peak	Horizontal	
2	4880.00	50.84	58.76	-7.92	54.00	-3.16	180	35 Average	Horizontal	



TUV Rheinland Taiwan Ltd.
No. 458-18, Sec 2, Fenliao, Linkou Dist., New Taipei City 244, Taiwan(R.O.C.)
Tel: +886-2172-1000 Fax: +886-2172-1322

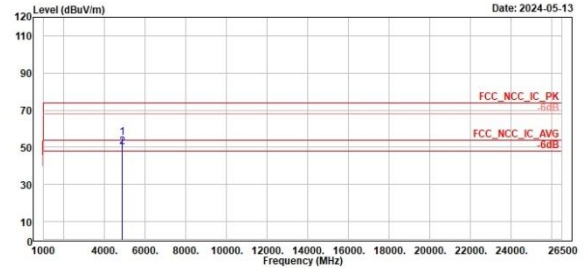

Freq	Level	Read Level	Factor	Limit Line	Over Limit	APos	TPos	Remark	Pol/Phase	Note
MHz	dBuV/m	dBuV	dB/m	dBuV/m	dB	cm	deg			
1	4880.00	55.43	63.35	-7.92	74.00	-18.57	300	205 Peak	Vertical	
2	4880.00	50.02	57.94	-7.92	54.00	-3.98	300	205 Average	Vertical	

SRD_1M

High Channel (Horizontal)

High Channel (Vertical)



TÜV Rheinland Taiwan Ltd.
No. 458-18, Sec 2, Fenliao, Linkou Dist., New Taipei City 244, Taiwan(R.O.C.)
Tel: +886-2172-1000 Fax: +886-2172-1322

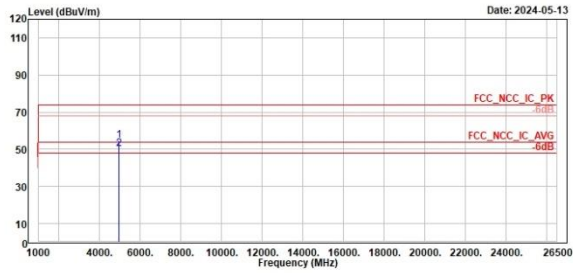

Read	Level	Factor	Limit	Over	APos	TPos	Remark	Pol/Phase	Note
Freq	Level	Level	Line	Line	cm	deg			
MHz	dBuV/m	dBuV	dB/m	dBuV/m	dB				
1	4968.00	54.68	62.39	-7.79	74.00	-19.48	180	51	Peak Horizontal
2	4968.00	50.17	57.96	-7.79	54.00	-3.83	180	51	Average Horizontal



TÜV Rheinland Taiwan Ltd.
No. 458-18, Sec 2, Fenliao, Linkou Dist., New Taipei City 244, Taiwan(R.O.C.)
Tel: +886-2172-1000 Fax: +886-2172-1322

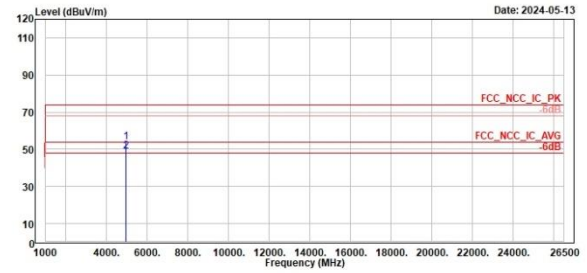

Read	Level	Factor	Limit	Over	APos	TPos	Remark	Pol/Phase	Note
Freq	Level	Level	Line	Line	cm	deg			
MHz	dBuV/m	dBuV	dB/m	dBuV/m	dB				
1	4968.00	53.66	61.45	-7.79	74.00	-20.34	180	314	Peak Vertical
2	4968.00	48.94	56.73	-7.79	54.00	-5.06	180	314	Average Vertical

SRD_2M

Low Channel (Horizontal)

Low Channel (Vertical)



TUV Rheinland Taiwan Ltd.
No. 458-18, Sec 2, Fenliao, Linkou Dist., New Taipei City 244, Taiwan(R.O.C.)
Tel: +886-2172-1000 Fax: +886-2172-1322

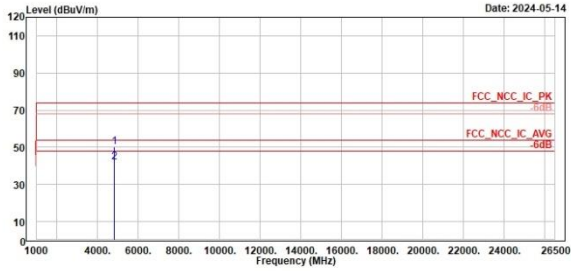

Freq	Level	Read Level	Factor	Limit Line	Over Limit	APos	TPos	Remark	Pol/Phase	Note
MHz	dBuV/m	dBuV	dB/m	dBuV/m	dB	cm	deg			
1	4888.00	50.15	58.15	-8.00	74.00	-23.85	180	238 Peak	Horizontal	
2	4888.00	41.34	49.94	-8.00	54.00	-12.06	180	238 Average	Horizontal	



TUV Rheinland Taiwan Ltd.
No. 458-18, Sec 2, Fenliao, Linkou Dist., New Taipei City 244, Taiwan(R.O.C.)
Tel: +886-2172-1000 Fax: +886-2172-1322

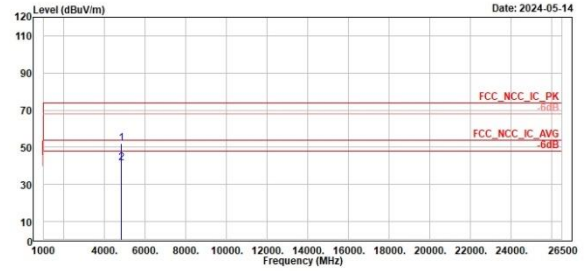

Freq	Level	Read Level	Factor	Limit Line	Over Limit	APos	TPos	Remark	Pol/Phase	Note
MHz	dBuV/m	dBuV	dB/m	dBuV/m	dB	cm	deg			
1	4888.00	51.96	59.96	-8.00	74.00	-22.04	280	324 Peak	Vertical	
2	4888.00	41.47	49.47	-8.00	54.00	-12.53	280	324 Average	Vertical	

SRD_2M

Middle Channel (Horizontal)

Middle Channel (Vertical)



TUV Rheinland Taiwan Ltd.
No. 458-18, Sec 2, Fenliao, Linkou Dist., New Taipei City 244, Taiwan(R.O.C.)
Tel: +886-2172-1000 Fax: +886-2172-1322

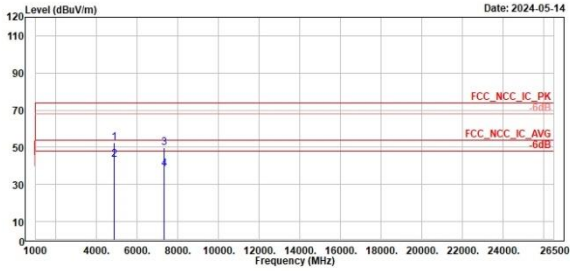

1	2	3	4							
Level	Level	Level	Level							
Factor	Factor	Factor	Factor							
Limit	Limit	Limit	Limit							
Line	Line	Line	Line							
Over	Over	Over	Over							
Limit	Limit	Limit	Limit							
APos	APos	APos	APos							
TPos	TPos	TPos	TPos							
Remark	Remark	Remark	Remark							
Pol/Phase	Pol/Phase	Pol/Phase	Pol/Phase							
Note	Note	Note	Note							
4880.00	52.62	68.54	-7.92	74.00	-21.38	100	267	Peak	Horizontal	
4880.00	43.35	51.27	-7.92	54.00	-10.65	100	267	Average	Horizontal	
7320.00	49.54	54.90	-5.36	74.00	-24.46	100	64	Peak	Horizontal	
7320.00	38.36	43.72	-5.36	54.00	-15.64	100	64	Average	Horizontal	



TUV Rheinland Taiwan Ltd.
No. 458-18, Sec 2, Fenliao, Linkou Dist., New Taipei City 244, Taiwan(R.O.C.)
Tel: +886-2172-1000 Fax: +886-2172-1322

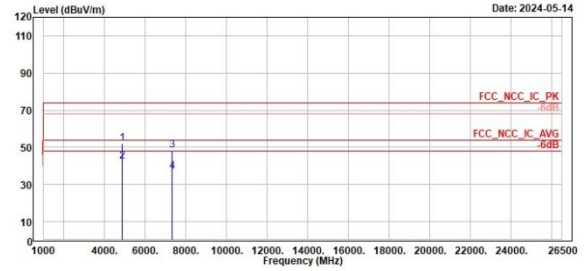

1	2	3	4							
Level	Level	Level	Level							
Factor	Factor	Factor	Factor							
Limit	Limit	Limit	Limit							
Line	Line	Line	Line							
Over	Over	Over	Over							
Limit	Limit	Limit	Limit							
APos	APos	APos	APos							
TPos	TPos	TPos	TPos							
Remark	Remark	Remark	Remark							
Pol/Phase	Pol/Phase	Pol/Phase	Pol/Phase							
Note	Note	Note	Note							
4880.00	51.99	59.91	-7.92	74.00	-22.01	268	162	Peak	Vertical	
4880.00	42.26	50.18	-7.92	54.00	-11.74	268	162	Average	Vertical	
7320.00	48.38	53.74	-5.36	74.00	-25.62	300	218	Peak	Vertical	
7320.00	37.05	42.41	-5.36	54.00	-16.95	300	218	Average	Vertical	

SRD_2M

High Channel (Horizontal)

High Channel (Vertical)



TUV Rheinland Taiwan Ltd.
No. 458-18, Sec 2, Fenliao, Linkou Dist., New Taipei City 244, Taiwan(R.O.C.)
Tel: +886-2172-1000 Fax: +886-2172-1322



TUV Rheinland Taiwan Ltd.
No. 458-18, Sec 2, Fenliao, Linkou Dist., New Taipei City 244, Taiwan(R.O.C.)
Tel: +886-2172-1000 Fax: +886-2172-1322

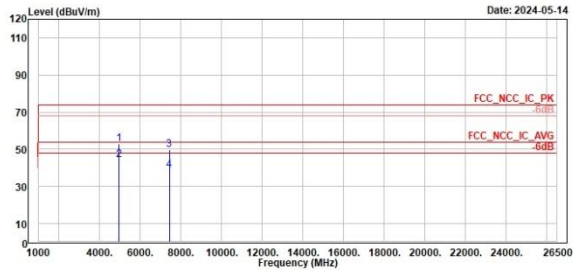

Line	Freq	Level	Read Level	Factor	Limit Line	Over Limit	APos	TPos	Remark	Pol/Phase	Note
	MHz	dBuV/m	dBuV	dB/m	dBuV/m	dB	cm	deg			
1	4956.00	53.05	68.84	-7.79	74.00	-20.95	338	62	Peak	Horizontal	
2	4956.00	44.23	52.02	-7.79	54.00	-9.77	338	62	Average	Horizontal	
3	7434.00	49.82	55.21	-5.39	74.00	-24.18	100	57	Peak	Horizontal	
4	7434.00	38.98	44.37	-5.39	54.00	-15.02	100	57	Average	Horizontal	

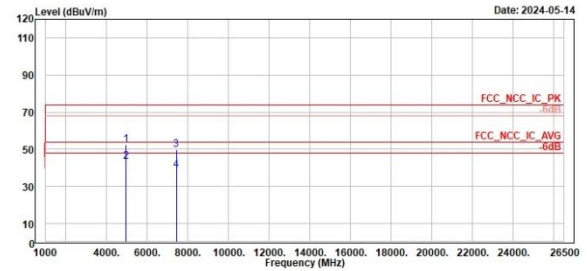

Line	Freq	Level	Read Level	Factor	Limit Line	Over Limit	APos	TPos	Remark	Pol/Phase	Note
	MHz	dBuV/m	dBuV	dB/m	dBuV/m	dB	cm	deg			
1	4956.00	52.44	68.23	-7.79	74.00	-21.56	316	318	Peak	Vertical	
2	4956.00	43.15	58.94	-7.79	54.00	-10.85	316	318	Average	Vertical	
3	7434.00	49.52	54.91	-5.39	74.00	-24.48	100	206	Peak	Vertical	
4	7434.00	38.56	43.95	-5.39	54.00	-15.44	100	206	Average	Vertical	

Mains Conducted Emission, TX 150kHz ~ 30MHz

Worst Band

(Line)

(Neutral)



TUV Rheinland Taiwan Ltd.
No. 458-18, Sec 2, Fenliao, Linkou Dist., New Taipei City 244, Taiwan(R.O.C.)
Tel:+886-2172-1000 Fax:+886-2172-1322

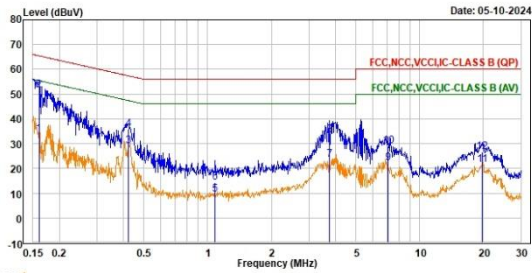

Trace: 1

Line	Freq (MHz)	Level (dBuV)	Read Level (dBuV)	Factor (dB)	Limit Line (dBuV)	Over Limit (dB)	Remark	Pol/Phase	Note
1	0.16	33.81	24.19	9.62	55.46	-21.65	Average	line1	
2	0.16	51.52	41.90	9.62	65.46	-13.94	QP	line1	
3	0.42	29.02	19.39	9.63	47.39	-18.37	Average	line1	
4	0.42	35.09	26.26	9.63	57.39	-21.50	QP	line1	
5	1.09	9.35	-0.29	9.64	46.00	-36.65	Average	line1	
6	1.09	14.37	4.73	9.64	56.00	-41.63	QP	line1	
7	3.75	23.37	13.69	9.68	46.00	-22.63	Average	line1	
8	3.75	33.41	23.73	9.68	56.00	-22.59	QP	line1	
9	7.07	22.05	12.33	9.72	50.00	-27.95	Average	line1	
10	7.07	29.12	19.40	9.72	60.00	-30.88	QP	line1	
11	19.64	21.41	11.64	9.77	50.00	-28.59	Average	line1	
12	19.64	26.61	16.84	9.77	60.00	-33.39	QP	line1	



TUV Rheinland Taiwan Ltd.
No. 458-18, Sec 2, Fenliao, Linkou Dist., New Taipei City 244, Taiwan(R.O.C.)
Tel:+886-2172-1000 Fax:+886-2172-1322

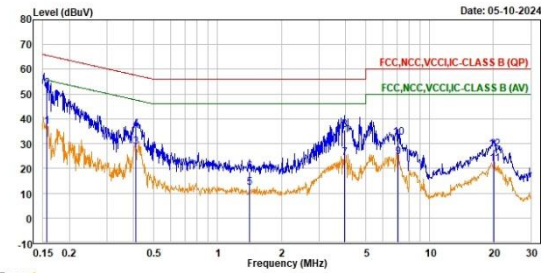

Trace: 1

Line	Freq (MHz)	Level (dBuV)	Read Level (dBuV)	Factor (dB)	Limit Line (dBuV)	Over Limit (dB)	Remark	Pol/Phase	Note
1	0.16	36.81	27.19	9.62	55.63	-18.82	Average	neutral	
2	0.16	52.39	42.77	9.62	65.63	-13.24	QP	neutral	
3	0.41	28.56	18.93	9.63	47.64	-19.08	Average	neutral	
4	0.41	35.82	26.19	9.63	57.64	-21.82	QP	neutral	
5	1.42	12.35	2.70	9.65	46.00	-33.65	Average	neutral	
6	1.42	18.09	9.24	9.65	56.00	-37.11	QP	neutral	
7	3.97	24.06	14.37	9.69	46.00	-21.94	Average	neutral	
8	3.97	35.52	25.83	9.69	56.00	-20.48	QP	neutral	
9	7.10	24.69	14.94	9.75	50.00	-25.31	Average	neutral	
10	7.10	32.27	22.52	9.75	60.00	-27.73	QP	neutral	
11	20.13	21.70	11.84	9.86	50.00	-28.30	Average	neutral	
12	20.13	27.54	17.68	9.86	60.00	-32.46	QP	neutral	