 <p>MS ISO/IEC 17025 TESTING SAMM No. 0825</p>
---	---

MOTOROLA PENANG ADV. COMM. LABORATORY
Motorola Solutions Malaysia Sdn Bhd
Innoplex Plot 2A, Medan Bayan Lepas,
Mukim 12 S.W.D, 11900 Bayan Lepas,
Penang, Malaysia.

FCC / ISED TEST REPORT
Report Revision : Rev.B

Date/s Tested	: 11-FEB-2018 - 20-FEB-2018
Report Issue Date	: 23-APR-2018
Manufacturer/Location	: Motorola Solutions Malaysia Sdn Bhd
Requestor	: MOHD HAFIZ ABDUL RAHMAN
Product Type	: Portable
Model Number	: AAH56JDN9RA1AN
Frequency Band	: 136 - 174 MHZ
Low / Max RF Output Power	: 1 Watts / 6 Watts
Applicant Name	: Motorola Solutions Malaysia Sdn Bhd
Applicant Address	: Innoplex Plot 2A, Medan Bayan Lepas, Mukim 12 S.W.D, 11900 Bayan Lepas, Penang, Malaysia
FCC Registrations	: 772092
ISED Registrations	: 109AK
FCC Test Firm Registrations	: 461337



The equipment was tested accordance to the requirement listed below:

(LMR) FCC 47 CFR Part 22 / 80 / 74 / 90 ISED RSS- Gen / 119 / 182	PASS
---	-------------

This report shall not be reproduced without written approval from an officially designated representative of the Motorola Penang Adv. Comm. Laboratory. The results and statements contained in this report pertain only to the device(s) evaluated.

Prepared By: <hr/> Khor Wei Loong Test Personnel	Approved By: <hr/> Goh Aik Hong Responsible Engineer
---	---

Table of Contents

Report Revision History	3
1.0 General Information.....	4
2.0 Summary of Test Results	5
3.0 Measurement Uncertainty	5
4.0 Equipment List.....	6
5.0 Test Condition.....	8
5.1. Transmitter Test Conditions	8
6.0 Transmitter Test Parameters	9
6.1. RF Output Power	9
6.1.1. Test Setup.....	9
6.1.2. Test Result	10
6.2. Frequency Stability	11
6.2.1. Test Setup.....	11
6.2.2. Test Result	12
6.2.3 Test Limit.....	13
6.3. Audio Frequency Response	14
6.3.1. Test Setup.....	14
6.3.2. Test Result	15
6.3.3. Test Limit.....	16
6.4. Audio Low Pass Filter Response	17
6.4.1. Test Setup.....	17
6.4.2. Test Result	18
6.4.3. Test Limit.....	19
6.5. Modulation Limiting	20
6.5.1. Test Setup.....	20
6.5.2. Test Result	21
6.5.3. Test Limit.....	21
6.6. Occupied Bandwidth.....	22
6.6.1. Test Setup (Analog)	22
6.6.2. Test Result (Analog).....	23
6.6.3. Test Setup (Digital).....	27
6.6.4. Test Result (Digital).....	28
6.6.1. Test Limit.....	33
6.7. Band Edge Conducted Spurious Emission (Part 22)	34
6.7.1. Test Setup (Analog)	34
6.7.2. Test Result (Analog).....	35
6.7.3. Test Setup (Digital).....	36
6.7.4. Test Result (Digital).....	37
6.7.5. Test Limit.....	37
6.8. Transient Frequency Behavior	38
6.8.1. Test Setup.....	38
6.8.2. Test Result	39
6.8.3. Test Limit.....	41

6.9. Adjacent Channel Power..... 42

6.9.1. Test Setup (Analog) 42

6.9.2. Test Result (Analog) 42

6.9.3. Test Setup (Digital)..... 43

6.9.4. Test Result 43

6.9.5. Test Limit..... 44

6.10. Conducted Spurious Emission 46

6.10.1. Test Setup..... 46

6.10.2. Test Result (Analog) 47

6.10.3. Test Result (Digital)..... 57

6.10.4. Test Limit..... 67

6.11. Radiated Spurious Emission 68

6.11.1. Test Setup..... 68

6.11.2. Test Result (Analog) 69

6.11.3. Test Result (Digital)..... 79

6.11.4. Test Limit..... 89

6.12. Effective Radiated Power (ERP) 90

6.12.1. Test Setup..... 90

6.12.2. Test Result 90

6.12.3. Test Limit..... 90

6.13. GNSS (EIRP for 1559 - 1610MHz)..... 91

6.13.1. Test Setup..... 91

6.13.1. Test Result 91

6.13.2. Test Limit..... 92

Report Revision History

Revision History	Description	Date	Originator
Rev. A	Initial Report	5-Mar-18	Khor Wei Loong
Rev. B	Removed FCC rules part in page 52 .	23-APR-18	Khor Wei Loong

1.0 General Information

EUT Description:

Technologies	Land Mobile Radio (LMR)
Modulation Type	Analog, 4FSK

General Description of Applied Standards

The EUT is a RF Product. According to the specifications of the manufacturer, the EUT is to comply with the requirements of the following standards:

ANSI/TIA/-603-D
ANSI C63.4-2014
ANSI C63.26-2015

2.0 Summary of Test Results

FCC General Rules Part (47CFR)	ISED General Rules Part	Test Item	Result	Remark
2.1046, 22.565, 74.461, 74.534, 80.215	RSS-Gen, RSS-119	RF Power Output	Pass	-
2.1055, 90.213, 22.355, 74.464, 74.561	-	Frequency Stability	Pass	-
2.1047, 74.463, 80.213	RSS-Gen, RSS-119	Audio Frequency Response	Pass	-
2.1047, 74.463, 80.213	RSS-Gen, RSS-119	Audio Low Pass Filter Response	Pass	-
2.1047, 74.463, 80.213	RSS-Gen, RSS-119	Modulation limiting	Pass	-
2.1049, 90.210, 22.359, 74.462, 74.535, 80.211(c), 80.211(f)	RSS-Gen, RSS-119, RSS182	Occupied Bandwidth	Pass	11k0F3E – 9.8297kHz 16k0F3E – 14.9646kHz 7k60F1D – 7.3505kHz 7k60F1E – 6.9578kHz 7k60F1W – 7.5648kHz
22.359	-	Band Edge Conducted Spurious Emission	Pass	16k0F3E – 14.9668kHz 7k60F1D – 7.3959kHz
90.214	-	Transient Frequency Behavior	Pass	-
-	-	Adjacent Channel Power	NA	-
90.210, 22.359, 74.462, 74.535, 80.211(c)	RSS-Gen, RSS119, RSS182	Conducted Spurious Emissions	Pass	Highest Spur Level -40.87dBm
90.210, 22.359, 74.462, 74.535, 80.211(c)	RSS-Gen, RSS119, RSS182	Radiated Spurious Emission	Pass	Highest Emission Spur Level -59.0786dBm
-	-	GNSS (EIRP for 1559 – 1610MHz)	NA	-
-	-	Effective Radiated Power (ERP)	NA	-

3.0 Measurement Uncertainty

Measurement	Frequency	Expanded Uncertainty (k=1.96) (±)
AC Power Line Conducted Spurious Emission	150KHz ~ 30MHz	3.43
Radiated Emissions up to 1 GHz	30MHz ~ 200MHz	5.01
	200MHz ~ 1000MHz	5.01
Radiated Emissions above 1 GHz	1GHz ~ 18GHz	5.01
	18GHz ~ 25GHz	5.01

4.0 Equipment List
FCC ANALOG ATE 1: (SW version: FCC_Frequency Stability 1.0.3 rev.)

Description	Model	Serial Number	Calibration Date	Calibration Due Date
Audio Analyzer	8903B	3011A10475	2/May/17	2/May/18
SIGNAL GENERATOR	2042	203002/745	2/May/17	2/May/18
MODULATION ANALYZER	8901B	3216A03889	3/May/17	3/May/18
TRANSCEIVER INTERFACE	8954A	2234A00398	4/May/17	4/May/18
DSA	36570A	MY42506781	3/May/17	3/May/18
SIGNAL GENERATOR	E4420B	MY41000465A	26/Mar/17	26/Mar/18
SIGNAL GENERATOR	2042	203002/747	2/May/17	2/May/18
POWER SENSOR	E4412A	MY41502652	9/May/17	9/May/18
POWER METER	E4416A	GB41293855	9/May/17	9/May/19
POWER SUPPLY	6031A	2430A00146	28/Mar/17	28/Mar/18
CHAMBER	SH-641	92014678	4/Apr/17	3/Apr/18
RF TRANSCEIVER CONTROLLER	AX2007AI	NA	CNR	CNR

FCC Transient ATE #1: (SW version: FCC Transient ATE_R1.1.1)

Description	Model	Serial Number	Calibration Date	Calibration Due Date
POWER SUPPLY	6032A	2818A03549	11-May-17	11-May-18
POWER SENSOR	E4412A	MY41498918	9-May-17	9-May-18
POWER METER	E4416A	GB41293747	12-May-16	12-May-18
ATTENUATORS/SWITCH DRIVER	11713A	2508A10141	CNR	CNR
STEP ATTENUATOR/11dB	8494G	MY52300223	9-May-17	9-May-18
STEP ATTENUATOR/110dB	8496G	MY52300176	9-May-17	9-May-18
OSCILLOSCOPE	MSO8064A	MY45001903	25-May-17	25-May-18
AUDIO ANALYZER	8903B	3729A17409	2-May-17	2-May-18
AUDIO ANALYZER	8903B	3011A08952	2-May-17	2-May-18
MODULATION ANALYZER	8901B	3019A02766	4-Mar-17	4-Mar-18
SIGNAL GENERATOR	8657A	3323A05725	2-May-17	2-May-18
SPECTRUM ANALYZER	E4440A	MY46185415	24-May-17	24-May-19
SWITCH CONTROL UNIT	-	-	CNR	CNR

CONDUCTED SPUR EMISSION ATE # 1 (SW version: Conducted Spur ATE_rev 1.23.01)

Description	Model	Serial Number	Calibration Date	Calibration Due Date
SWITCH CONTROL UNIT	3488A	2719A32735	CNR	CNR
SPECTRUM ANALYZER	E4440A	US45303111	16-Feb-17	16-Feb-18
POWER SUPPLY	6032A	MY41002067	5-May-17	5-May-18
HIGH PASS FILTER SWITCH BOX	-	CS001	7-Apr-17	7-Apr-18
MICROWAVE GENERATOR	SMP04	100146	18-Sept-17	18-Sept-18
MODULATION ANALYZER	8901B	3438A05278	3-May-17	3-May-18

Radiated Emission Station (SW version: 1.5.1)

DESCRIPTION	MODEL	SERIAL NUMBER	CALIBRATION DATE	CALIBRATION DUE DATE
DRG HORN FREQ.	SAS-571	719	18-Jul-17	18-Jul-19
DRG HORN FREQ.	SAS-571	720	2-Mar-17	2-Mar-19
POWER SUPPLY	6032A	2615A01178	6-Jun-17	6-Jun-18
MICROWAVE SIGNAL GENERATOR	SMP04	100127	19-Jul-17	18-Jul-18
EMI TEST RECEIVER	ESIB26	100336	13-Jul-17	12-Jul-18
SIGNAL ANALYZER	FSV40	101103	18-Jul-17	17-Jul-18
5m Semi-anechoic Chamber	S800-HX	J2308	CNR	CNR
BILOG ANTENNA	CBL6112D	25224	22-Jul-17	22-Jul-18
BILOG ANTENNA	CBL6112B	30991	10-Apr-2017	10-Apr-2018
BROAD-BAND HORN ANTENNA	BBHA9170	BBHA9170143	20-Mar-17	10-Apr-18
DATA LOGGER	SDL500	A.016776	18-Mar-17	18-Mar-18
LOOP ANTENNA	6502	208416	27-Jul-17	27-Jul-18
SYSTEM CONTROLLER	SC104V	050806-1	CNR	CNR
TURNTABLE FLUSH MOUNT 2M	FM2011	NA	CNR	CNR
ANTENNA POSITIONING TOWER	TLT2	NA	CNR	CNR
18 - 40GHz PREAMPLIFIER	BBV9721	9721-007	CNR	CNR
PREAMPLIFIER	PAM-0118P	361	CNR	CNR

CNR → Calibration Not Required

5.0 Test Condition

5.1 Transmitter Test Conditions

Test Item, (Channel Spacing)	Power (W)	Modulation	Test Frequency (MHz)	Tested By
RF Output Power	Low & Max	Analog	138.0125, 158.55, 161.7, 173.3875	Khor Wei Loong
Frequency Stability	Max	Analog	158.55	Khor Wei Loong
Audio Frequency Response (12.5kHz / 25kHz)	Max	Analog	158.55	Khor Wei Loong
Audio Low Pass Filter Response (12.5kHz / 25kHz)	Max	Analog	158.55	Khor Wei Loong
Modulation limiting (12.5kHz / 25kHz)	Max	Analog	158.55	Khor Wei Loong
Occupied Bandwidth (12.5kHz / 25kHz)	Max	Analog, 4FSK	138.0125, 158.55, 161.7, 173.3875	Khor Wei Loong
Band Edge Conducted Spurious Emissions (Part 22) (12.5kHz / 25kHz)	Max / Low	Analog, 4FSK	157.77, 158.67	Khor Wei Loong
Transient Frequency Behavior (UHF & VHF Band) (12.5kHz / 25kHz)	Max	Analog	158.55	Khor Wei Loong
Adjacent Channel Power (700MHz Band) (12.5kHz / 25kHz)	Max	Analog	NA	NA
Conducted Spurious Emissions (12.5kHz / 25kHz)	Low / Max	Analog, 4FSK	138.0125, 158.55, 161.7, 173.3875, 157.77, 158.67	Khor Wei Loong
Radiated Spurious Emission (12.5kHz / 25kHz)	Low / Max	Analog, 4FSK	138.0125, 158.55, 161.7, 173.3875	Nazrin & Qawiman
GNSS (EIRP for 1559 - 1610MHz) (12.5kHz / 25kHz)	Max	Analog	NA	NA
Effective Radiated Power (ERP) (12.5kHz / 25kHz)	Max	Analog	NA	NA

NA → Not Applicable

6.0 Transmitter Test Parameters

6.1. RF Output Power

6.1.1. Test Setup

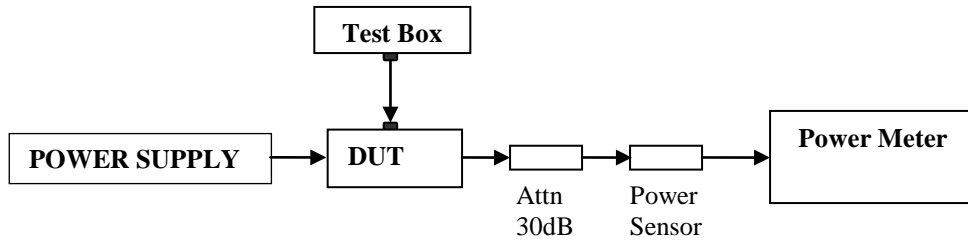

- 1) The DUT transmitter connected to Power Meter using the 30 dB attenuator and power sensor with above setup.
- 2) Path loss for the measurement included.
- 3) All the measurement was done at low, mid, high frequency for each band.
- 4) Record the power into the test report.

6.1.2. Test Result

Temperature	25°C				Remarks
Voltage (V)	7.5V				
Frequency (MHz)	Low Power (W)	Current (A)	Max Power (W)	Current (A)	
138.0125	1.04	0.67	6.00	1.83	Not For FCC Review
158.5500	1.04	0.68	5.97	1.74	
161.7000	1.03	0.67	5.99	1.74	
173.3875	0.99	0.66	5.94	1.88	

6.2. Frequency Stability

6.2.1. Test Setup

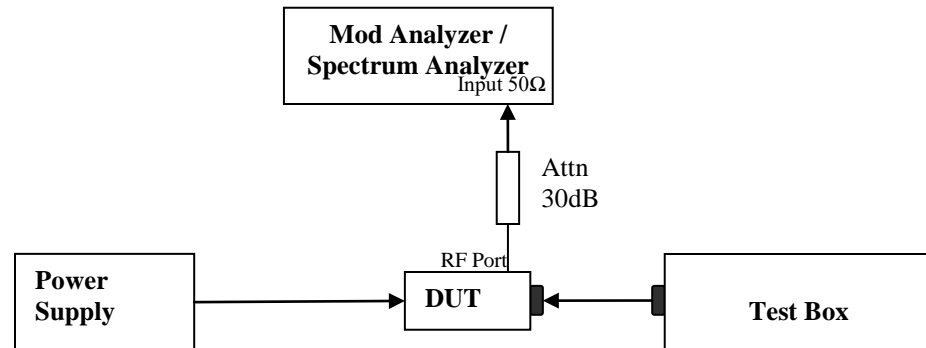

- 1) The DUT transmitter output port was connected to Modulation / Spectrum Analyzer.
- 2) Path loss for the measurement included.
- 3) Transmit the DUT and record the freq in MCF_{MHz} .
- 4) Test in 2 conditions:
 - Temperature: The frequency of the transmitter was measured from -30°C to 50°C .
 - Supply Voltage:
 - Mobile: The frequency of the transmitter was measured from 85% to 115% of the nominal operating input voltage.
 - Portable: The frequency of the transmitter was measured from nominal $\pm x\%$ as specified by the manufacturer
- 5) Calculate the ppm frequency error by the following:

$$ppm\ error = \left(\frac{MCF_{MHz}}{ACF_{MHz}} - 1 \right) * 10^6$$

Where: MCF_{MHz} is the Measured Carrier Frequency in MHz
 ACF_{MHz} is the Assigned Carrier Frequency in MHz

6.2.2. Test Result

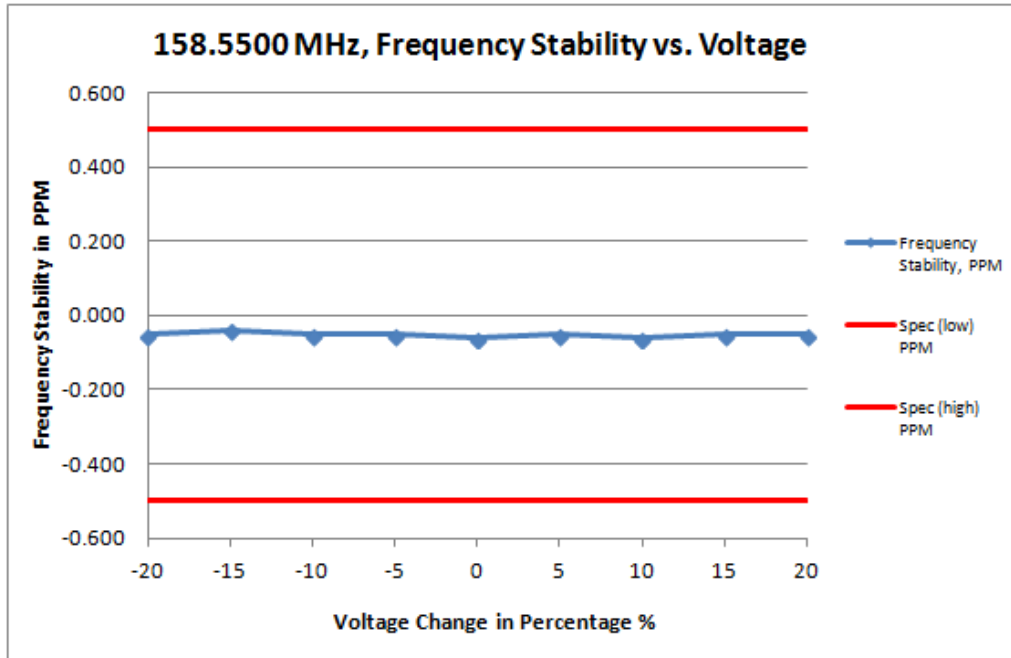

(i) Frequency Stability VS Voltage

Frequency / Channel Spacing	158.5500 MHz / 12.5 kHz				
Temperature, °C	25				
Voltage %	Voltage, V	Frequency, MHz	Frequency Stability, PPM	Spec (low) PPM	Spec (high) PPM
-20	6.000	158.549992	-0.050	-0.500	0.500
-15	6.375	158.549994	-0.040	-0.500	0.500
-10	6.750	158.549992	-0.050	-0.500	0.500
-5	7.125	158.549992	-0.050	-0.500	0.500
0	7.500	158.549991	-0.060	-0.500	0.500
5	7.875	158.549992	-0.050	-0.500	0.500
10	8.250	158.549991	-0.060	-0.500	0.500
15	8.625	158.549992	-0.050	-0.500	0.500
20	9.000	158.549992	-0.050	-0.500	0.500

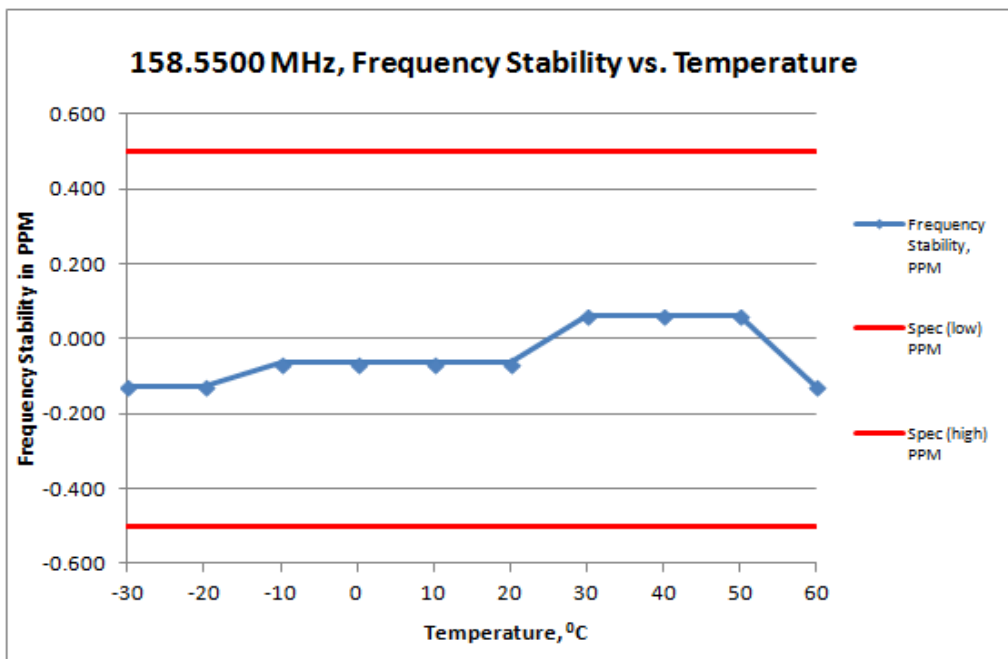

(ii) Frequency Stability VS temperature

Frequency / Channel Spacing		158.5500 MHz / 12.5 kHz		
Voltage, V		7.5		
Temperature, °C	Frequency, MHz	Frequency Stability, PPM	Spec (low) PPM	Spec (high) PPM
-30	158.549980	-0.126	-0.500	0.500
-20	158.549980	-0.126	-0.500	0.500
-10	158.549990	-0.063	-0.500	0.500
0	158.549990	-0.063	-0.500	0.500
10	158.549990	-0.063	-0.500	0.500
20	158.549990	-0.063	-0.500	0.500
30	158.550010	0.063	-0.500	0.500
40	158.550010	0.063	-0.500	0.500
50	158.550010	0.063	-0.500	0.500
60	158.549980	-0.126	-0.500	0.500

6.2.3 Test Limit

As per manufacturer declared spec +/- 0.5ppm

6.3. Audio Frequency Response

6.3.1. Test Setup

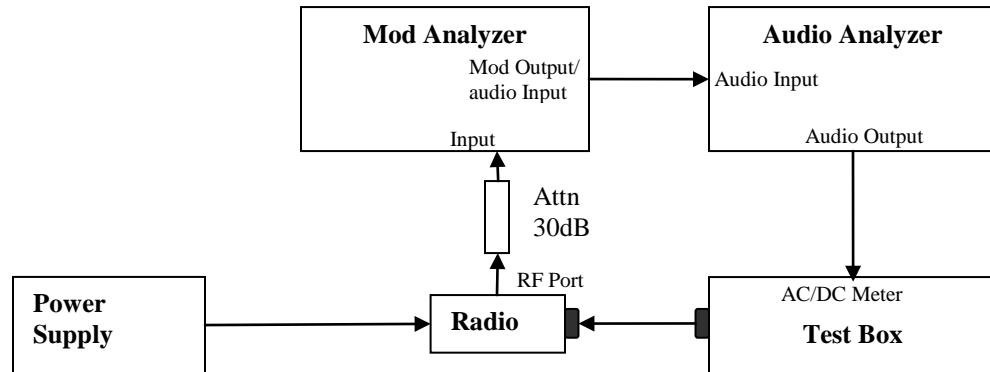

- 1) The DUT transmitter output port was connected to Modulation Analyzer.
- 2) Path loss for the measurement included.
- 3) Set the audio bandwidth filter to 15 kHz and 50 kHz.
- 4) Transmit the radio and set the audio analyzer to 1 kHz audio frequency and 20% of the Full rated system deviation.
- 5) On audio analyzer, set the rated level as reference to zero.
- 6) Vary the audio frequency from 300 Hz to 3 kHz. Record the change in dB on the audio analyzer.

6.3.2. Test Result

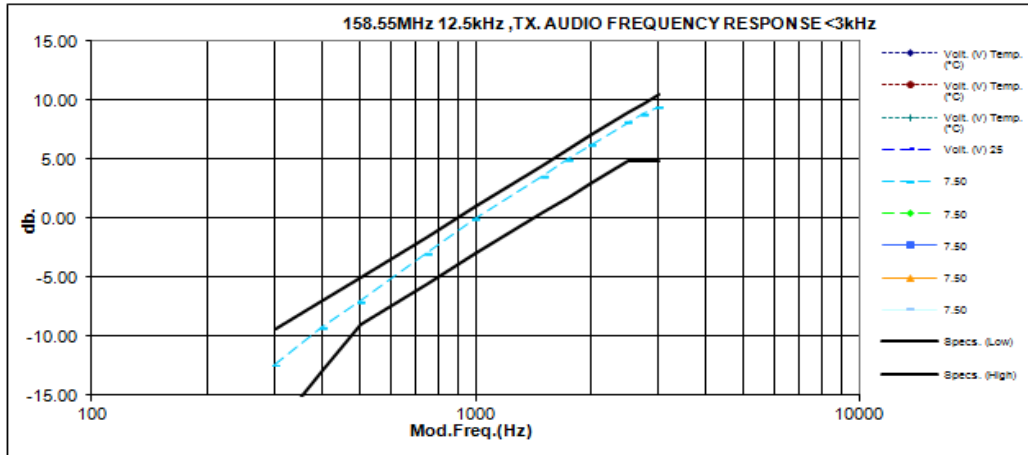

Not For FCC Review

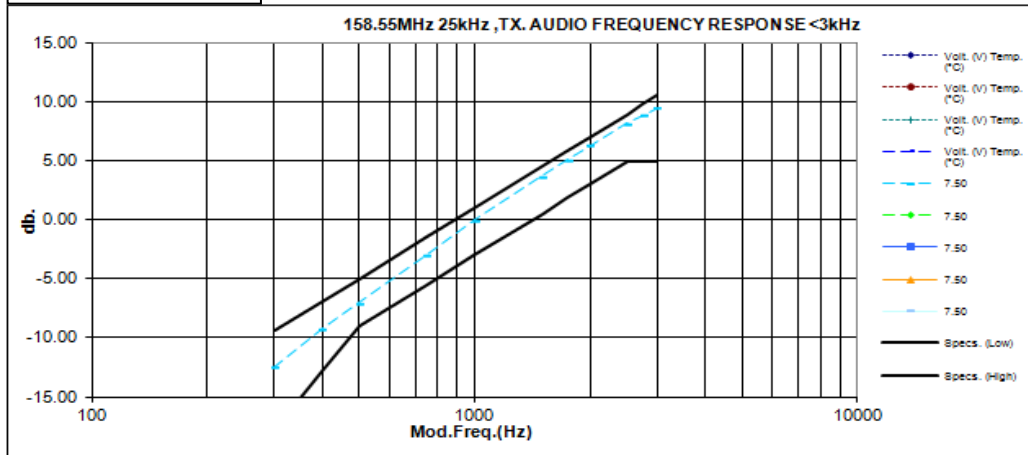

6.3.3. Test Limit

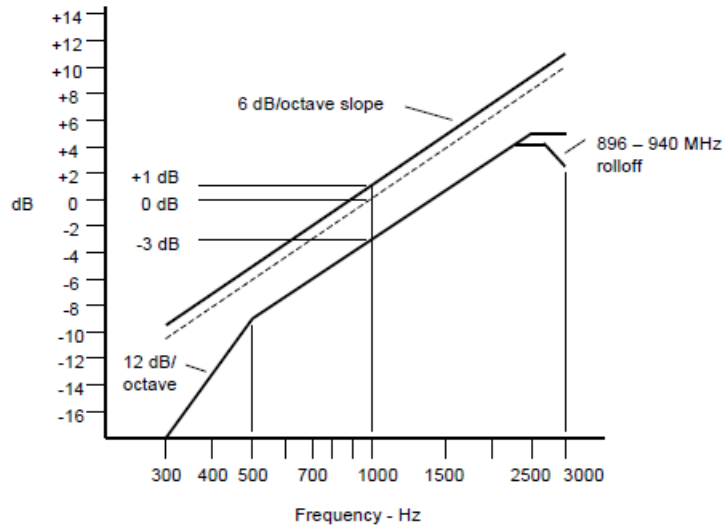

Note:

- o There are additional 6 dB per octave attenuation is allowed from 2.5KHz to 3KHz in equipment 25MHz to 869MHz radio.
- o Additional 6 dB per octave attenuation is allowed from 2.3KHz to 2.7KHz & additional 12 dB per octave attenuation is allowed from 2.7KHz to 3KHz in equipment 896MHz to 940MHz radio.

6.4. Audio Low Pass Filter Response

6.4.1. Test Setup

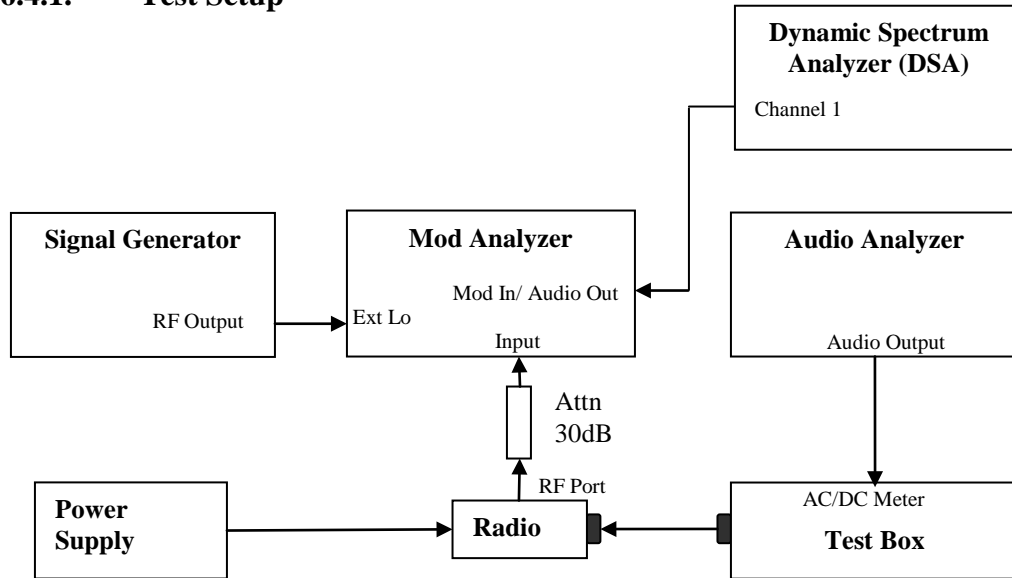

- 1) The DUT transmitter output port was connected to Modulation Analyzer.
- 2) Path loss for the measurement included.
- 3) Press 23.1SPCL on modulation analyzer to enable the external LO from Sigen.
- 4) Set the Sigen frequency to $F_c + 1.5$ MHz, RF output level to 0dBm without modulation.
- 5) Transmit the radio and set the audio analyzer to 1 kHz audio frequency and 60% of the Full rated system deviation.
- 6) Up the amplitude by 20dB.
- 7) On DSA, get the reference point to 0dB.
- 8) Vary the frequency on audio analyzer from 3 kHz to 20 kHz, record the audio tone from DSA

6.4.2. Test Result

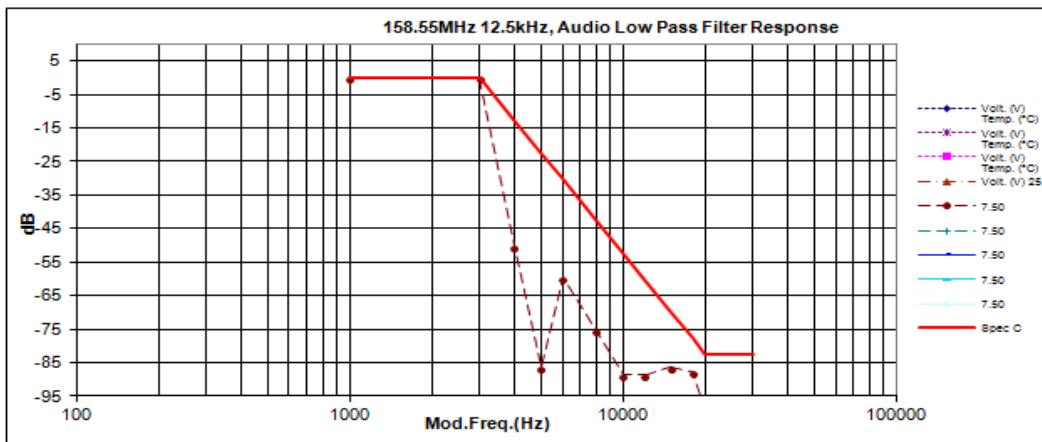

Not For FCC Review

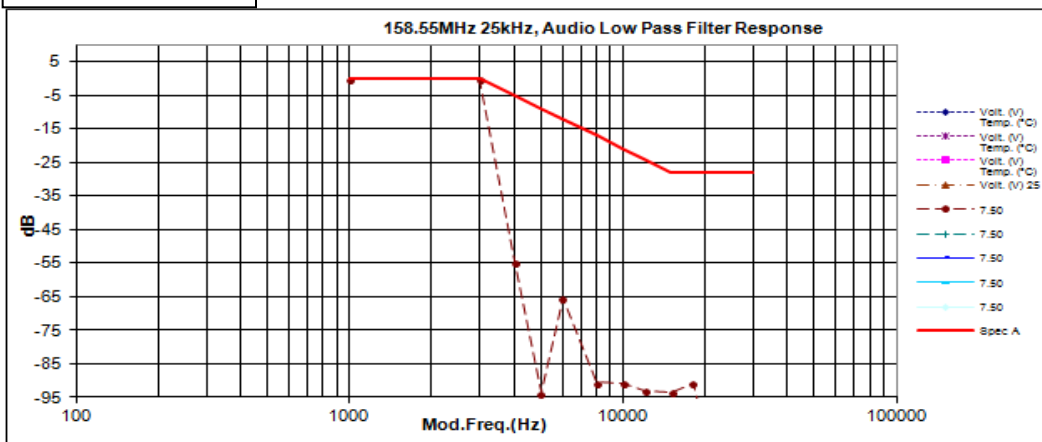

6.4.3. Test Limit

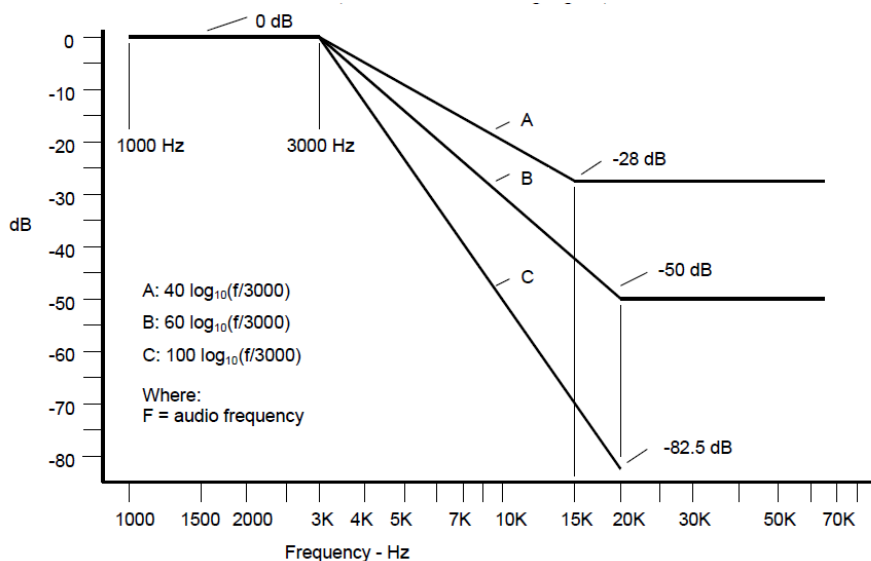

For audio frequencies above 3000 Hz, the audio response of the post limiter low-pass filter shall meet or exceed the following requirements:

- a) For equipment operating on 20, 25 or 30 kHz channel bandwidth in the 25 MHz to 174 MHz range:

At frequencies from 3000 Hz through 15,000 Hz the attenuation shall be greater than the attenuation at 1000 Hz by at least: $40 \log_{10}(f/3000)$ dB

where: f is the audio frequency in Hz.

At frequencies above 15,000 Hz, the attenuation shall be greater than the attenuation at 1000 Hz, by at least: 28 dB.

- b) For equipment operating with 25 kHz bandwidth channels between 406 and 512 MHz through 896 MHz, and between 929 MHz through 930 MHz:

At frequencies from 3000 Hz through 20,000 Hz, the attenuation shall be greater than the attenuation at 1000 Hz by at least: $60 \log_{10}(f/3000)$ dB

where: f is the audio frequency in Hz.

At frequencies above 20,000 Hz the attenuation shall be greater than the attenuation at 1000 Hz by at least: 50 dB.

- c) For equipment operating on channels between 896 MHz through 901 MHz, between 935 MHz through 940 MHz, and 12.5 or 15 kHz spaced channels in the frequency range 138-174 MHz and 406-512 MHz.

At frequencies from 3000 Hz through 20,000 Hz the attenuation shall be greater than the attenuation at 1000 Hz by at least: $100 \log_{10}(f/3000)$ dB

where: f is the audio frequency in Hz.

6.5. Modulation Limiting

6.5.1. Test Setup

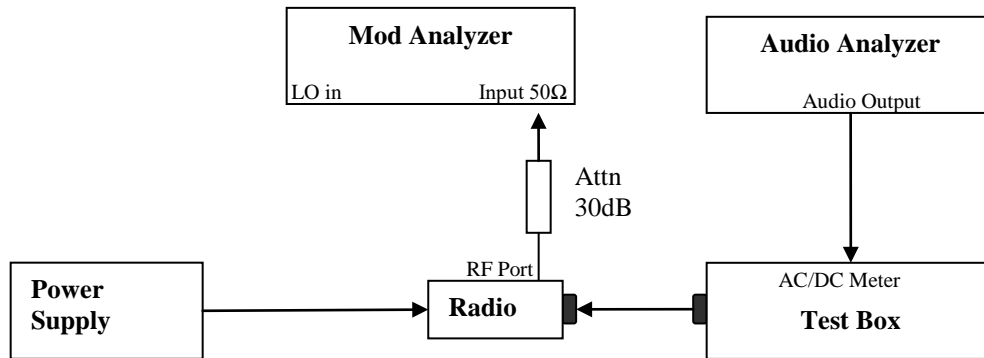

- 1) The DUT transmitter output port was connected to Modulation Analyzer.
- 2) Path loss for the measurement included.
- 3) Set the audio bandwidth filter to 15 kHz.
- 4) Transmit the radio and set the audio analyzer to 1 kHz audio frequency and 60% of the Full rated system deviation.
- 5) Record the frequency deviation as 0dB input level at 1kHz audio frequency.
- 6) Repeat the step and record the frequency deviation from -20 dB to 20dB by 5 dB increments and different audio freq 300 Hz, 2.5 kHz and 3 kHz.

6.5.2. Test Result

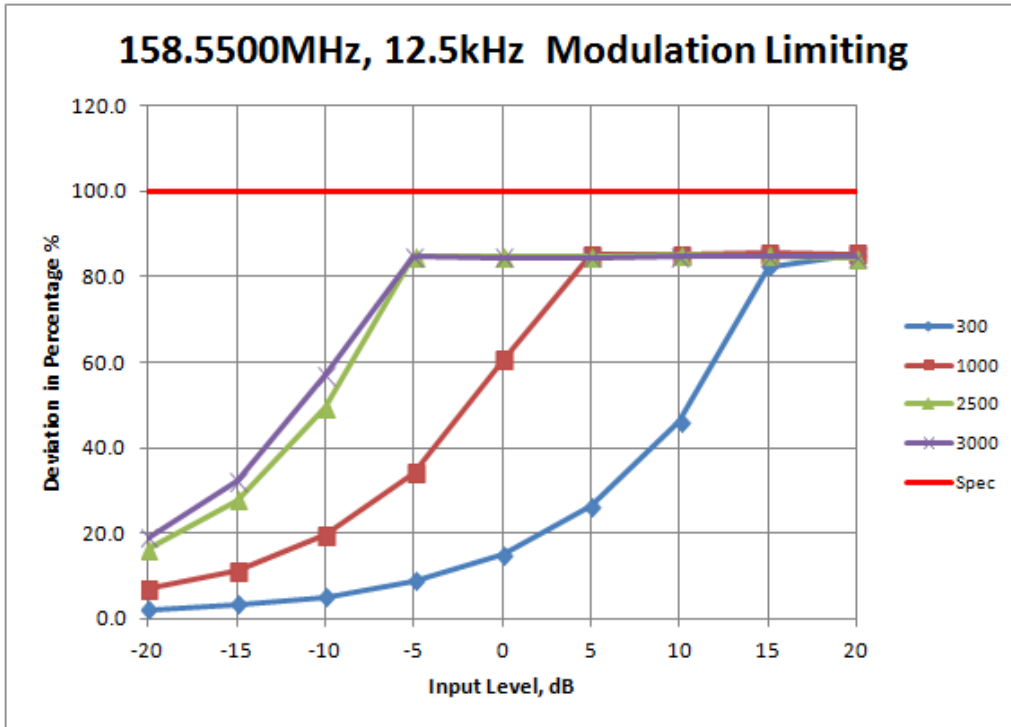

Not For FCC Review

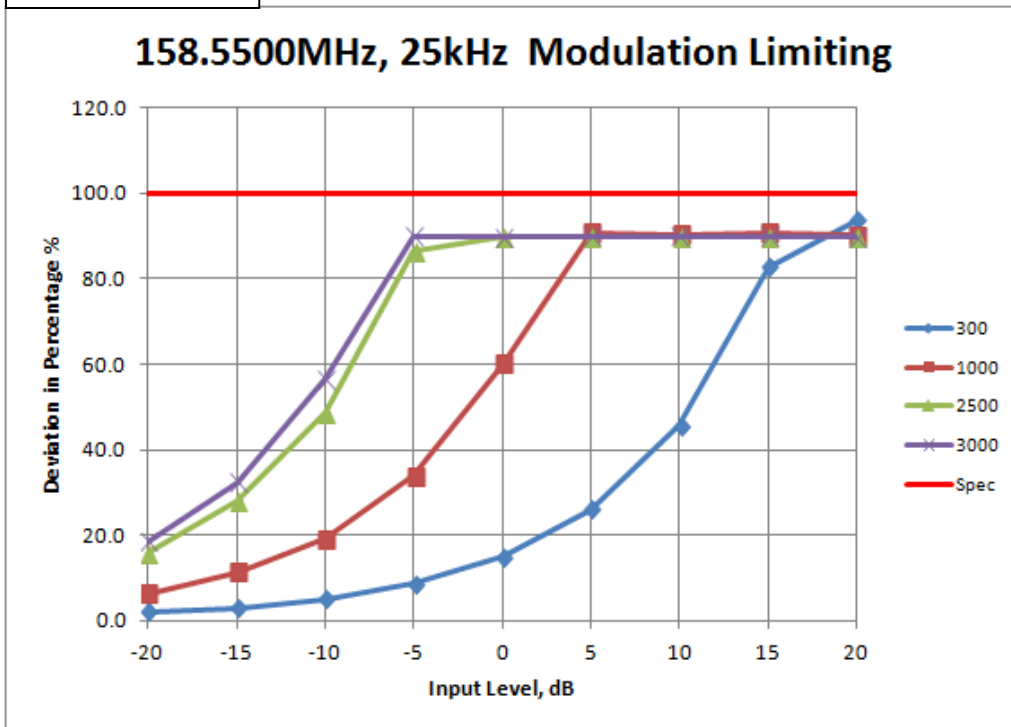

6.5.3. Test Limit

Modulation Limiting shall not exceed 100 percent.

6.6. Occupied Bandwidth

6.6.1. Test Setup (Analog)

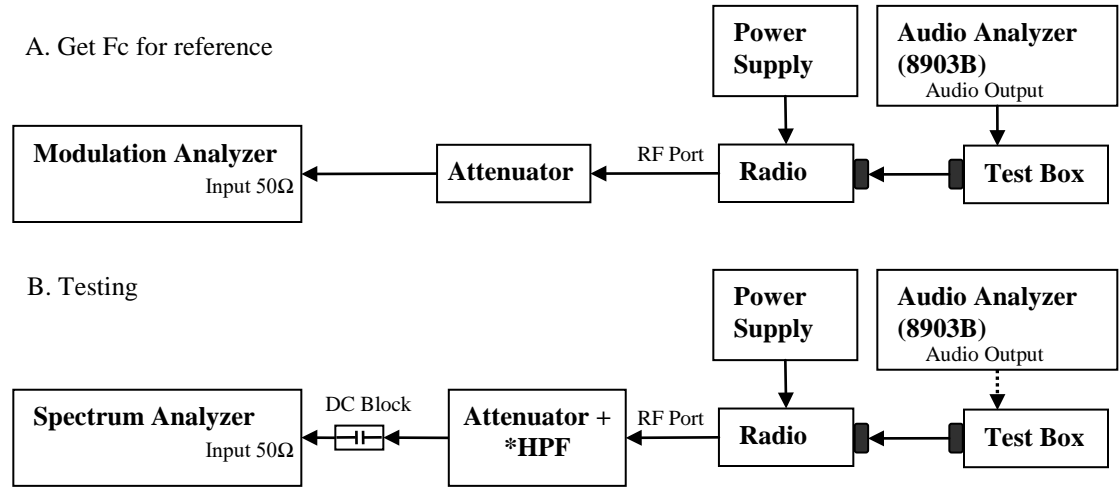

- 1) The DUT transmitter output port was connected to Modulation Analyzer.
- 2) Set the audio bandwidth filter to 15 kHz low pass filter and 50 kHz high pass filter.
- 3) Transmit the radio and set the audio analyzer to 2.5 kHz audio frequency and 50% of the rated deviation. Up the amplitude by 16 dB. Dekey the DUT.
- 4) Path loss for the measurement included.
- 5) Select the Occupied Bandwidth measurement for 99% Emissions Bandwidth Measurement.
- 6) Key in the Fc and Resolution Bandwidth (1 ~ 5 % of emission designator).
- 7) Transmit the DUT and record the occupied Bandwidth frequency.
- 8) Preset the spectrum analyzer for sideband spectrum measurement.
- 9) Set the span and Resolution Bandwidth (according to FCC/ ISED standard).
- 10) Save the screen shot as modulated signal
- 11) Remove the audio tone from audio analyzer to capture unmodulated signal.

* Only HPF added for Mask 80.211 measurement with attenuator.

6.6.2. Test Result (Analog)

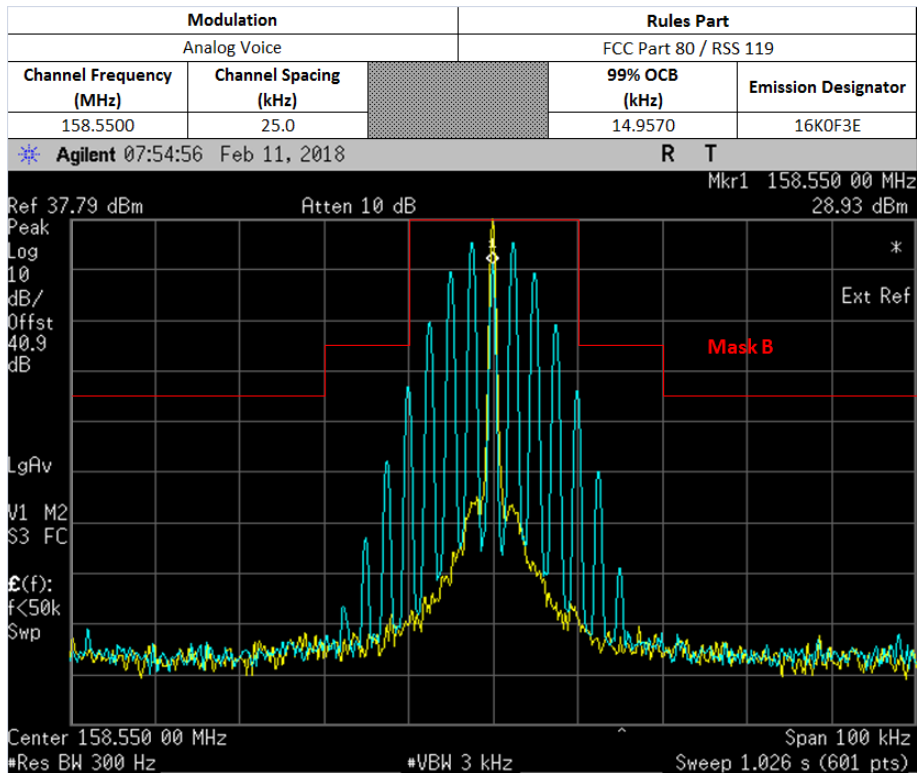
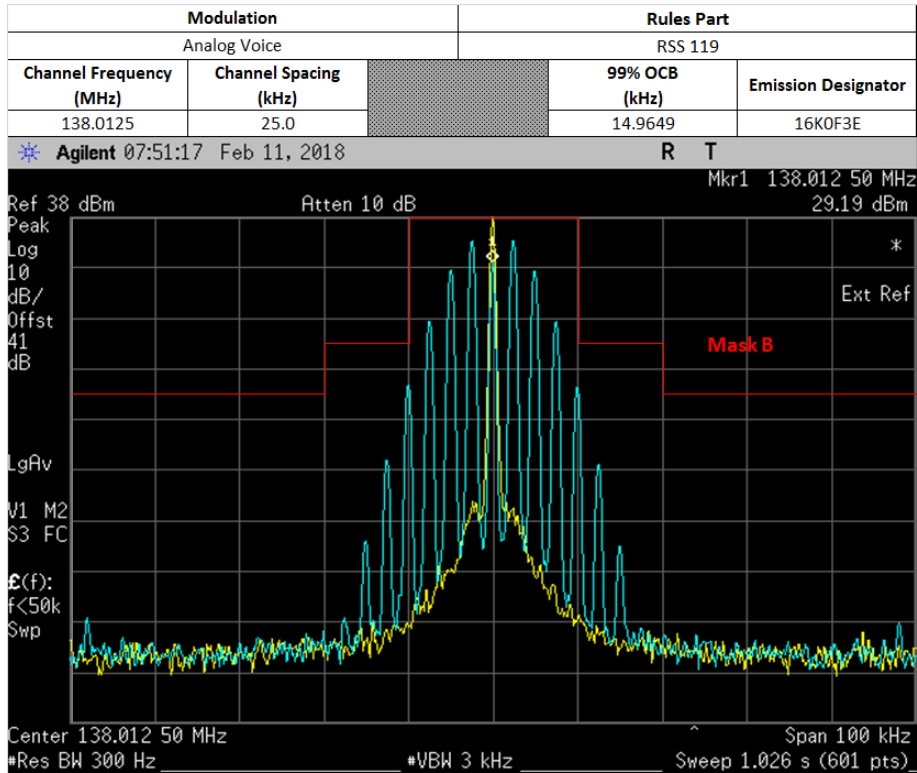

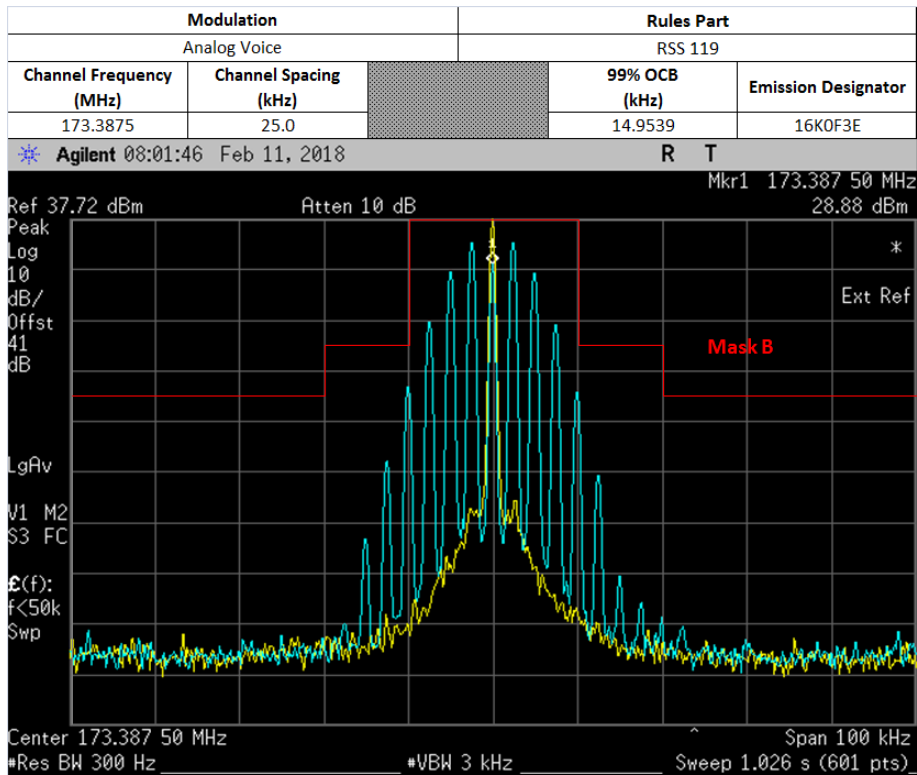
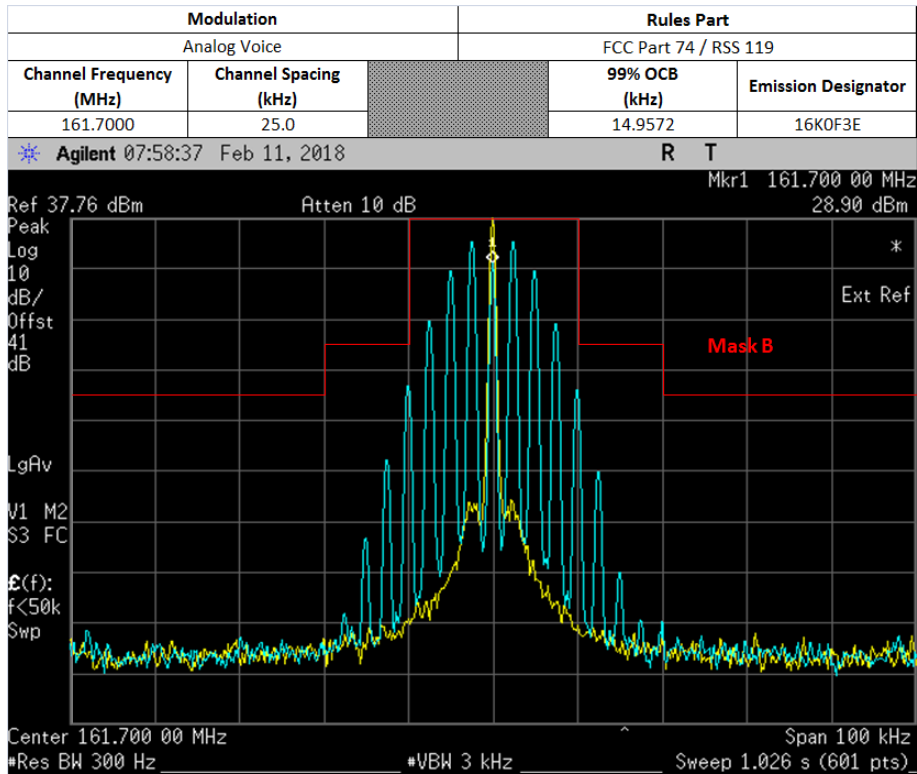

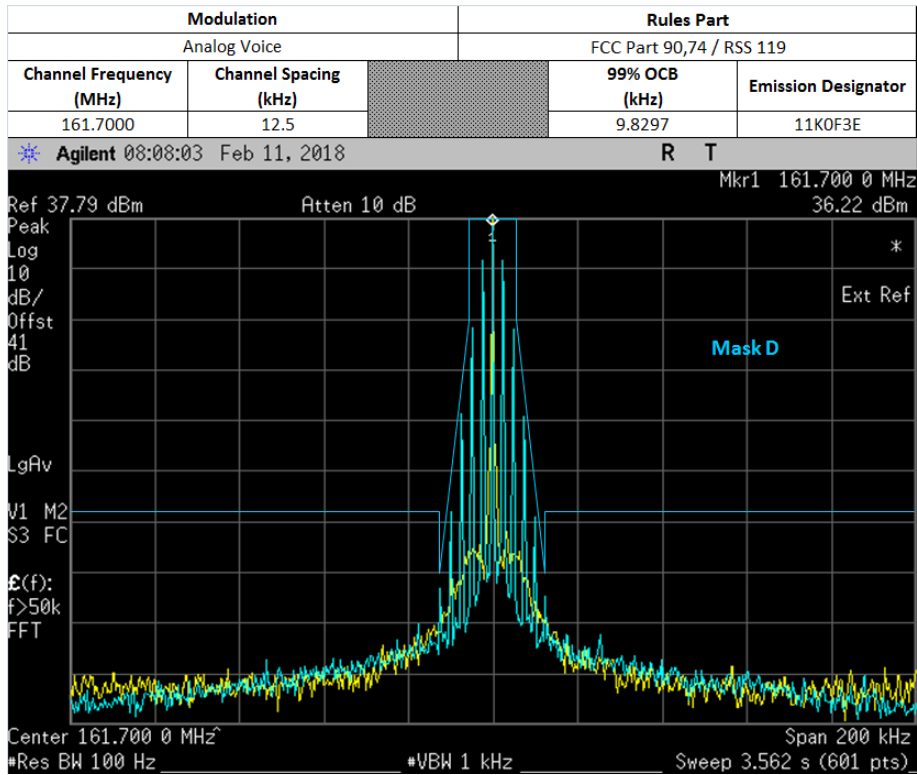
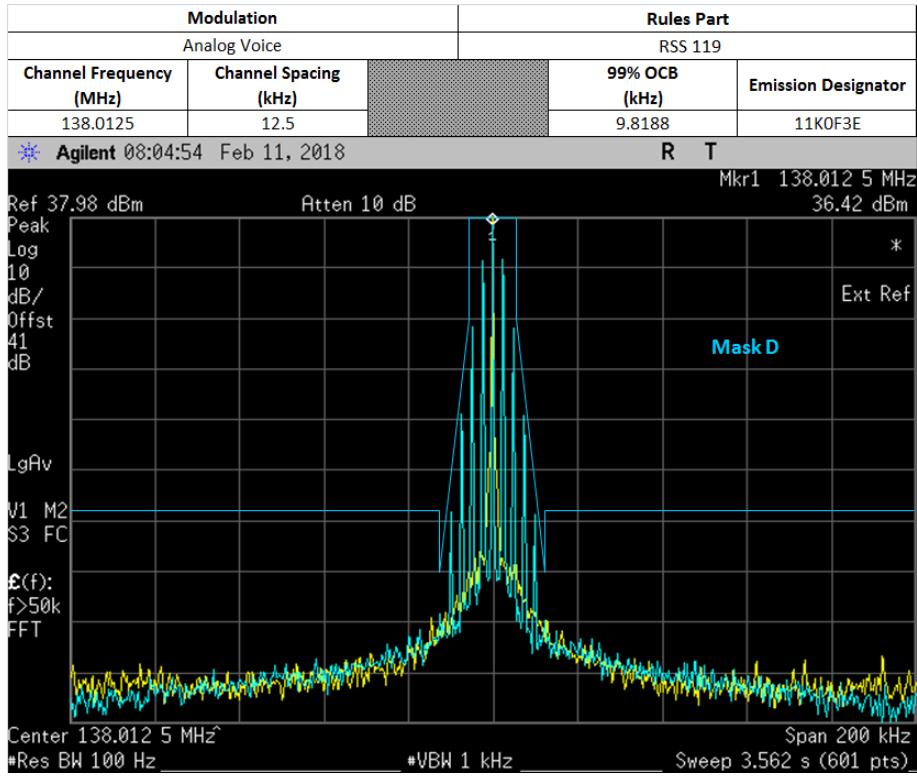

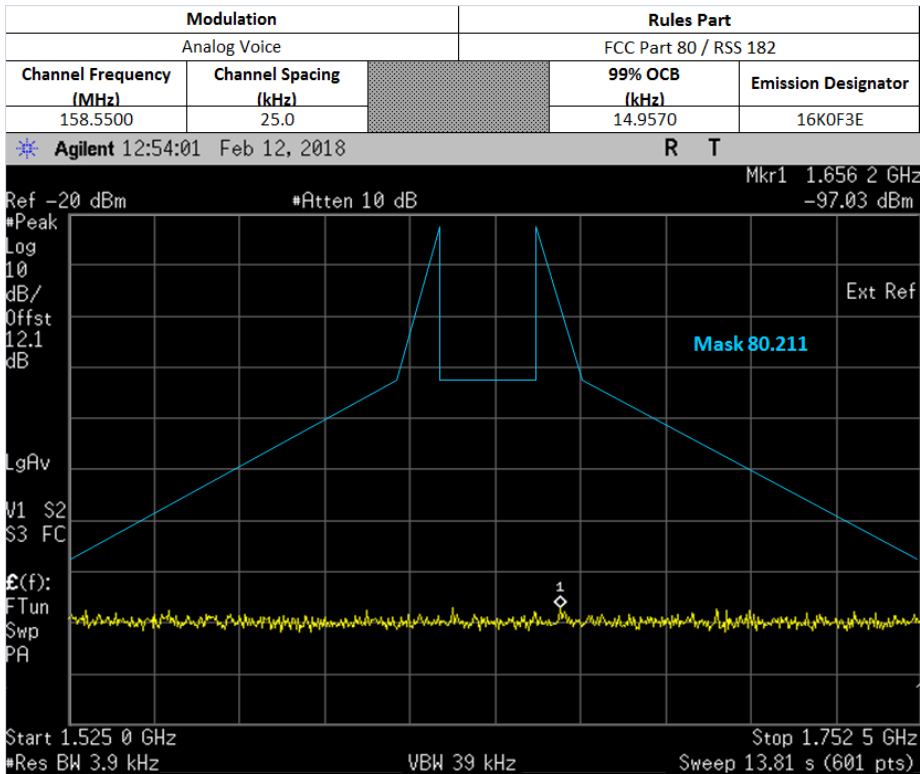
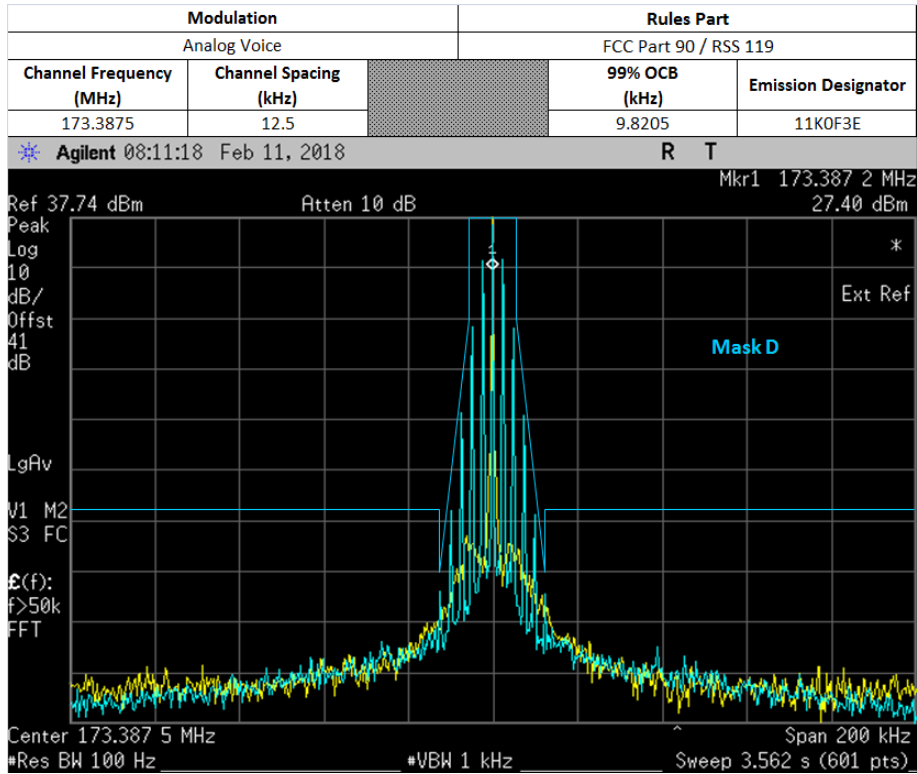

6.6.3. Test Setup (Digital)

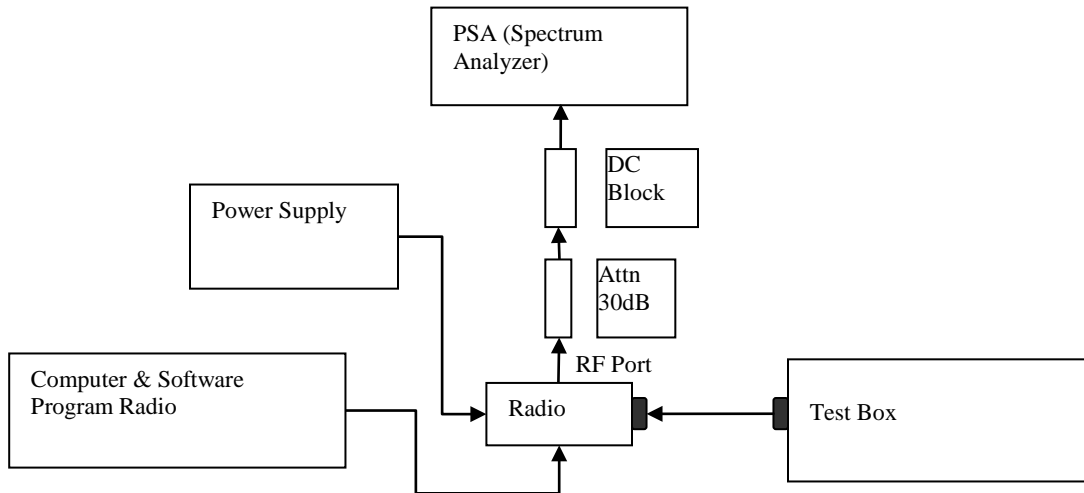

- 1) Program and set radio to operate in desire test frequency and digital mode with modulation. (*4FSK, C4FM or other digital modulation form).
- 2) Path loss for the measurement included.
- 3) Select the Occupied Bandwidth measurement for 99% Emissions Bandwidth Measurement.
- 4) Key in the Fc and Resolution Bandwidth (1 ~ 5 % of emission designator).
- 5) Transmit the DUT and record the occupied Bandwidth frequency.
- 6) Preset the spectrum analyzer for modulation emission spectrum measurement.
- 7) Set the span and Resolution Bandwidth (according to FCC/ ISED standard).
- 8) Capture the screen shot as modulated signal.

*Note:

- For Digital Modulation, 12.5 kHz Data F1D & FXD would be the same. Therefore only measurements with F1D modulation shown below.
- For Digital Modulation, 12.5 kHz Data F1E & FXE would be the same. Therefore only measurements with F1E modulation shown below.

6.6.4. Test Result (Digital)

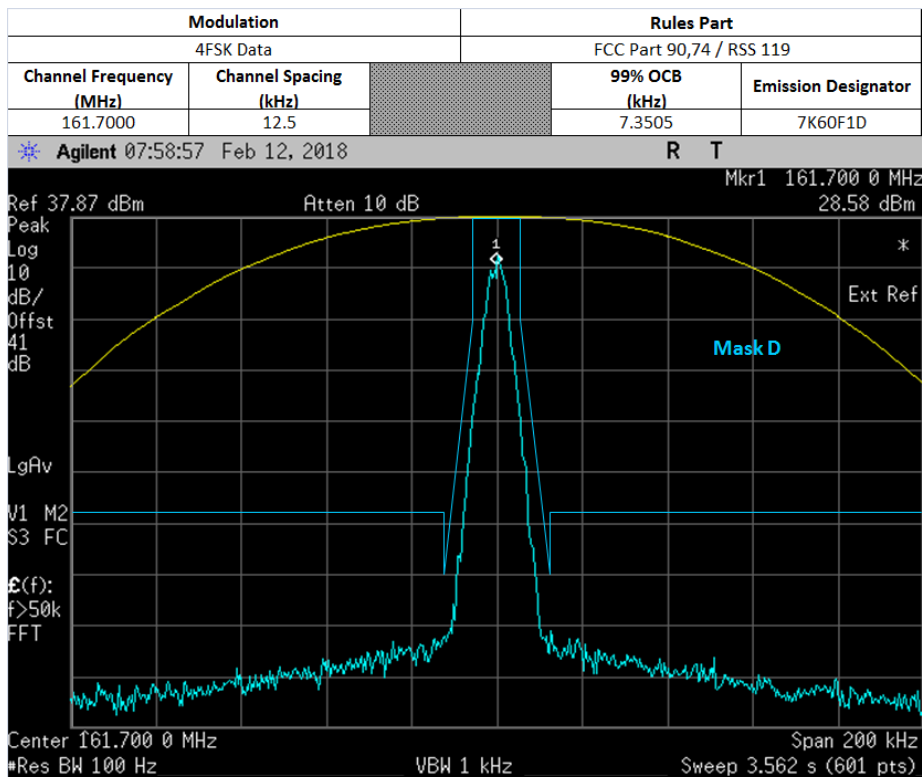
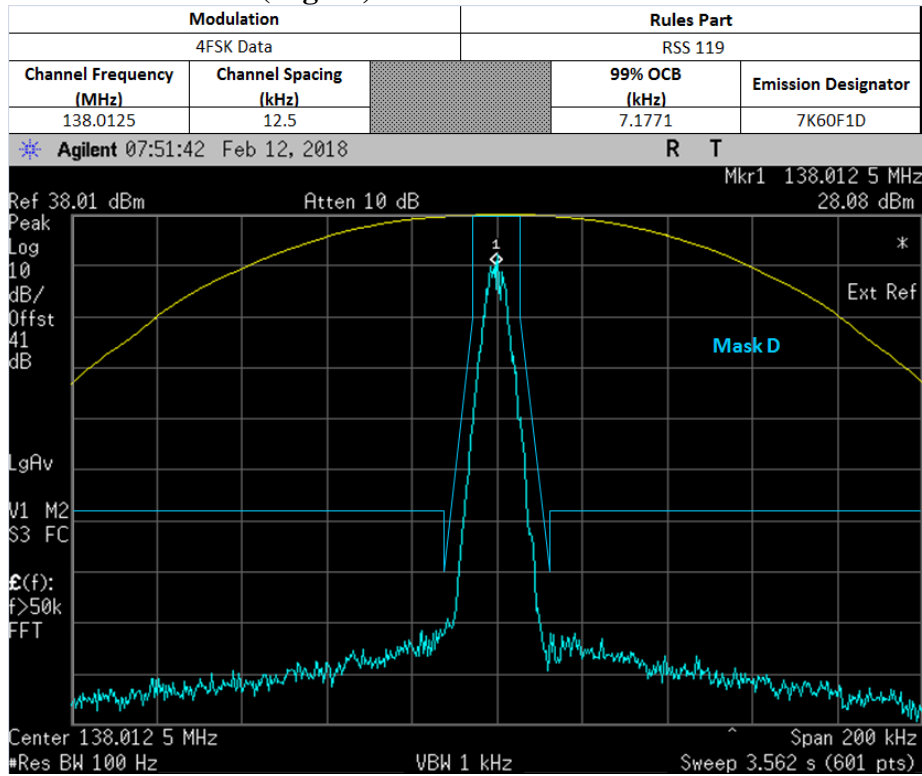

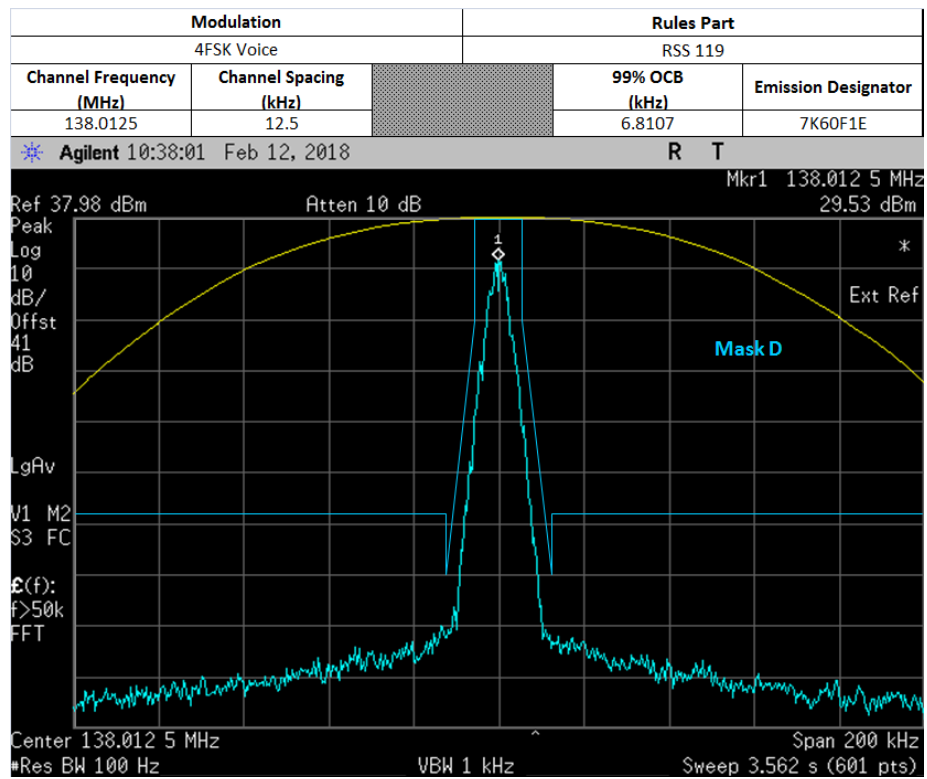
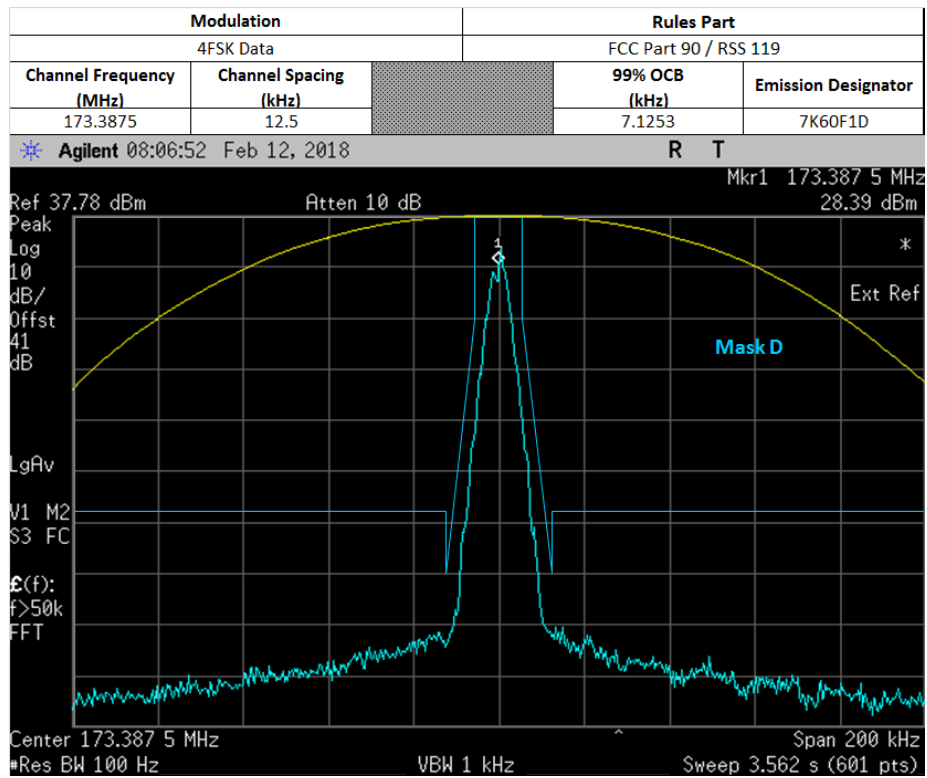

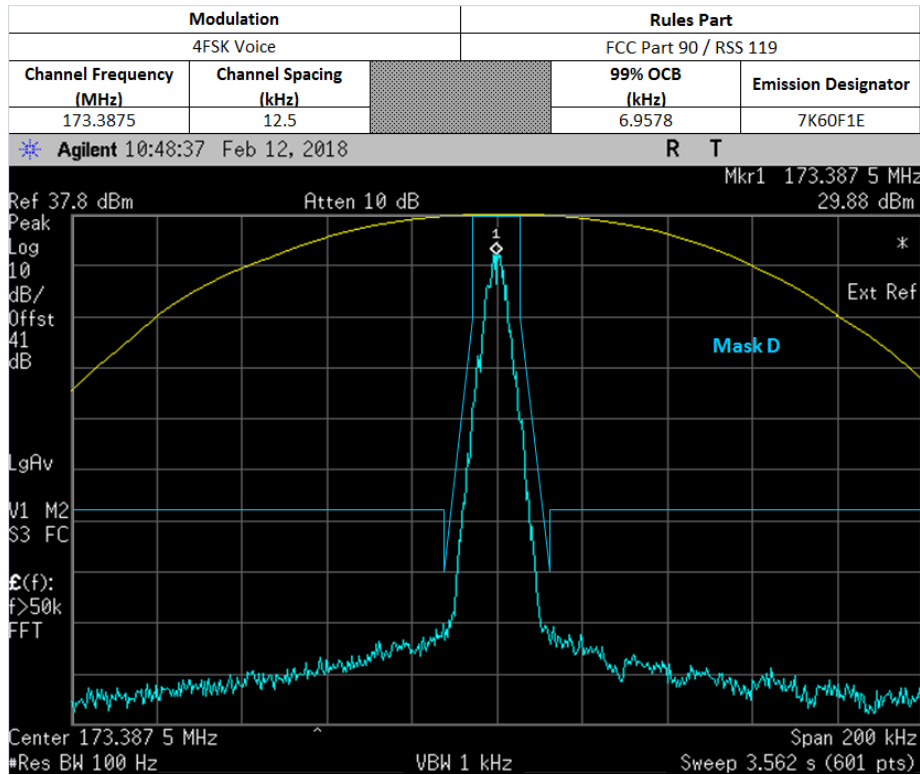
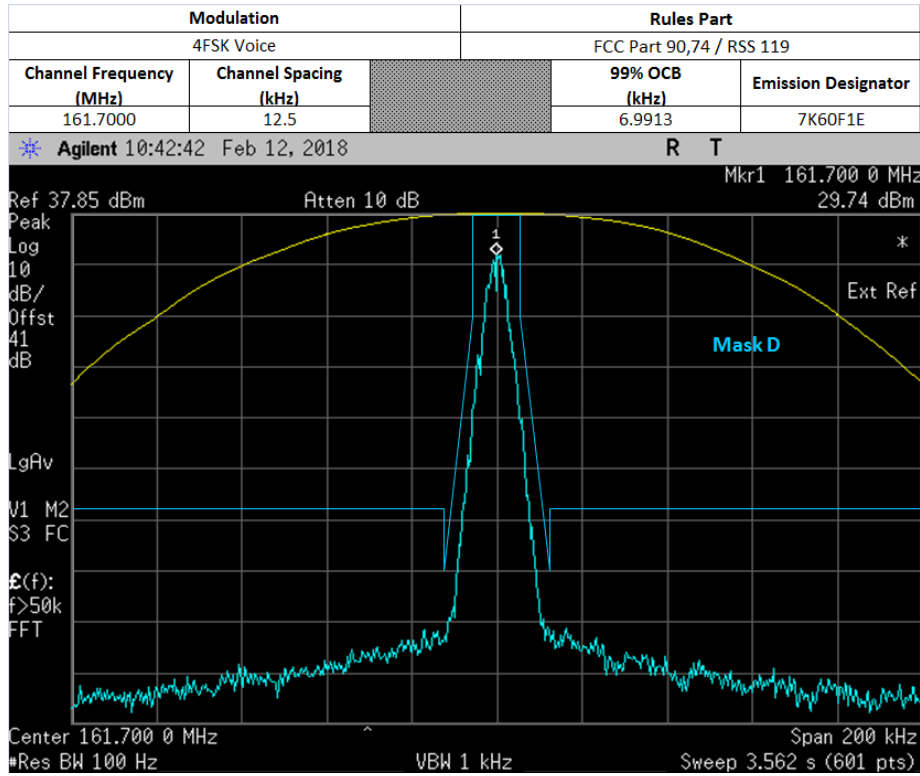

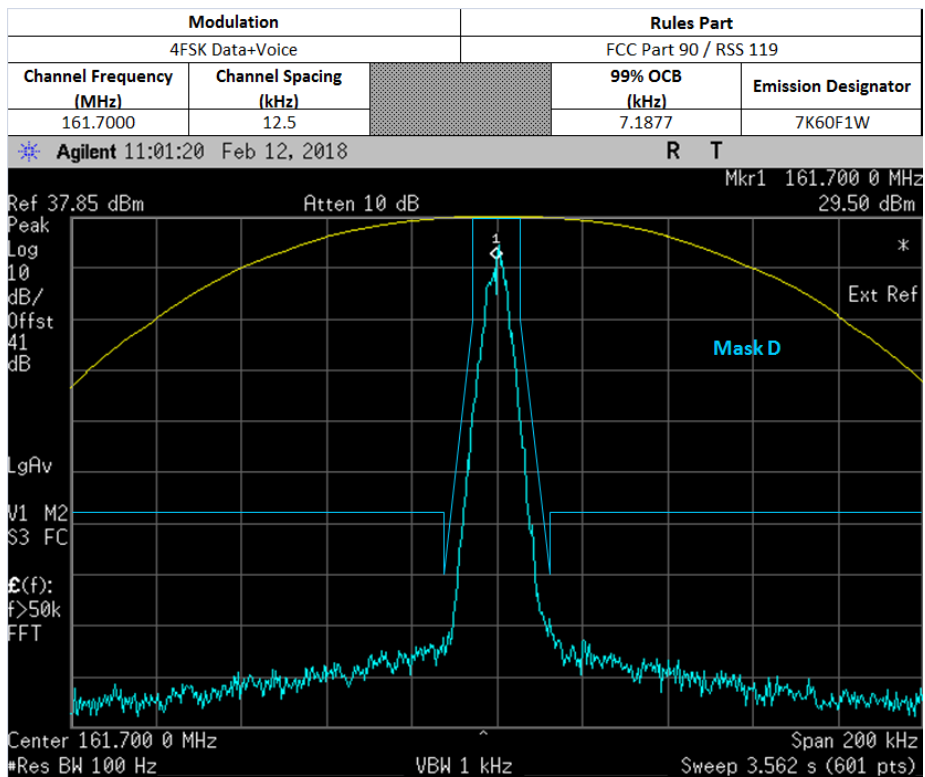
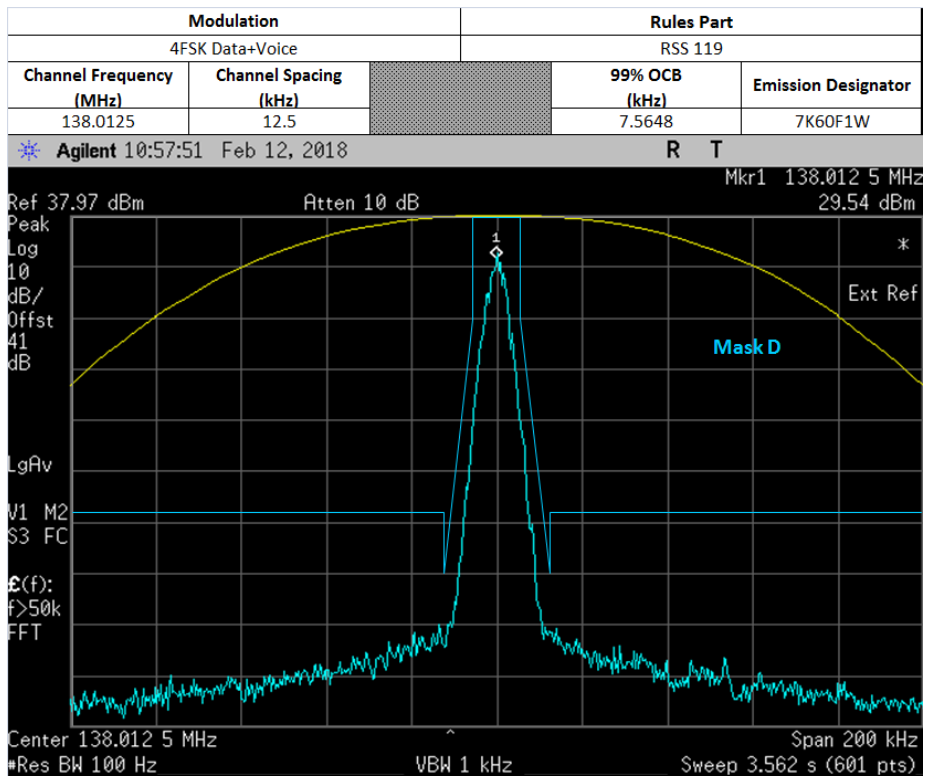

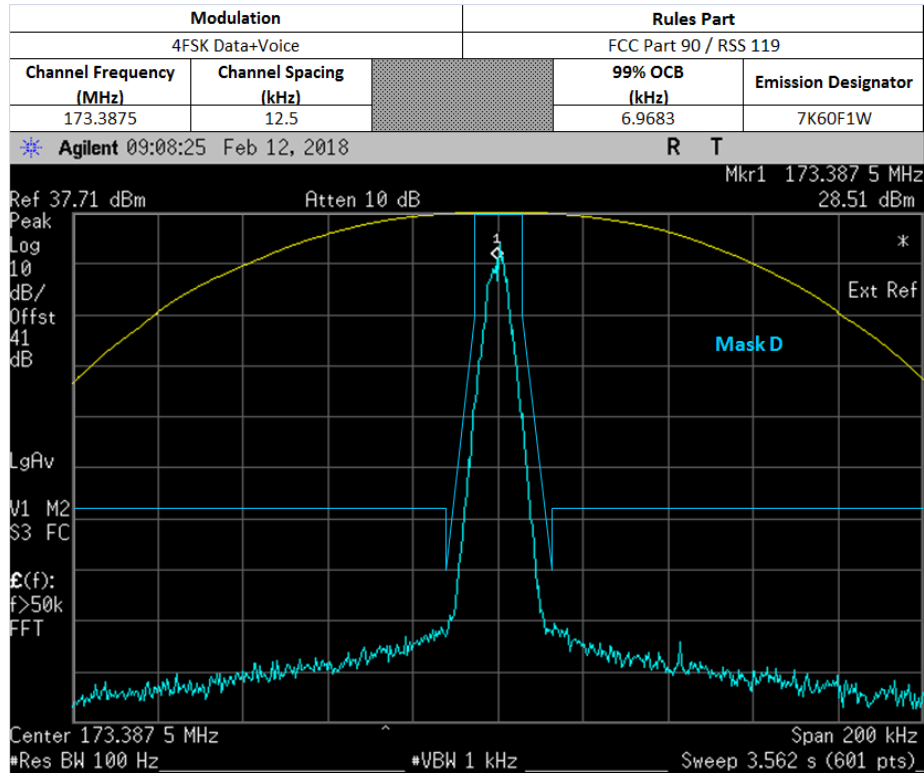

6.6.1. Test Limit

The 99% occupied bandwidth is the width of a frequency band such that, below the lower and above the upper frequency limits, the mean powers emitted are each equal to a specified percentage 0.5% of the total mean transmitted power.

6.7. Band Edge Conducted Spurious Emission (Part 22)

6.7.1. Test Setup (Analog)

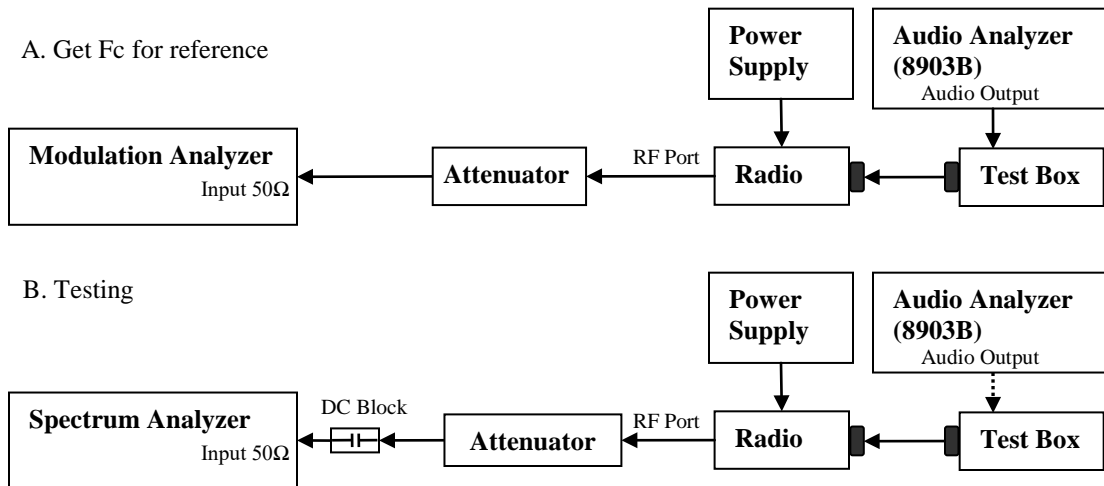

- 1) The DUT transmitter output port was connected to Modulation Analyzer.
- 2) Set the audio bandwidth filter to 15 kHz low pass filter and 50 kHz high pass filter.
- 3) Transmit the radio and set the audio analyzer to 2.5 kHz audio frequency and 50% of the rated deviation. Up the amplitude by 16 dB. Dekey the DUT.
- 4) Path loss for the measurement included.
- 5) Select the Occupied Bandwidth measurement for 99% and 26dB Emissions Bandwidth Measurement.
- 6) Key in the Fc and Resolution Bandwidth.
- 7) Transmit the DUT and record the occupied Bandwidth frequencies.
- 8) Preset the spectrum analyzer for band edge measurement.
- 9) The band edges of lowest and highest channels were measured.
- 10) Key in the Lowest and highest channel frequency, span is 60 kHz and Resolution Bandwidth is at least 1% of Emission Bandwidth.
- 11) Save the screen shot as modulated signal.
- 12) Remove the audio tone from audio analyzer to capture unmodulated signal.

*Note:

- For emission designator ending with F3E, 16K0F3E is the worst case and therefore only 16K0F3E will be shown.

6.7.2. Test Result (Analog)

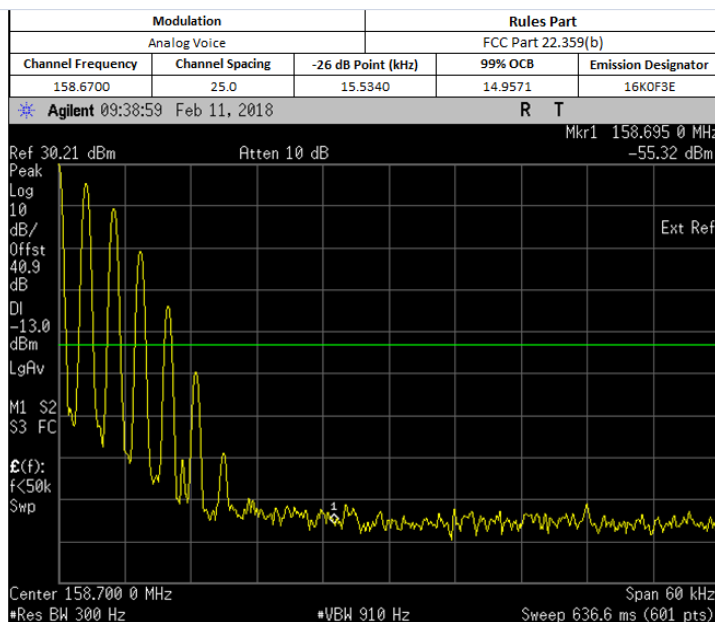
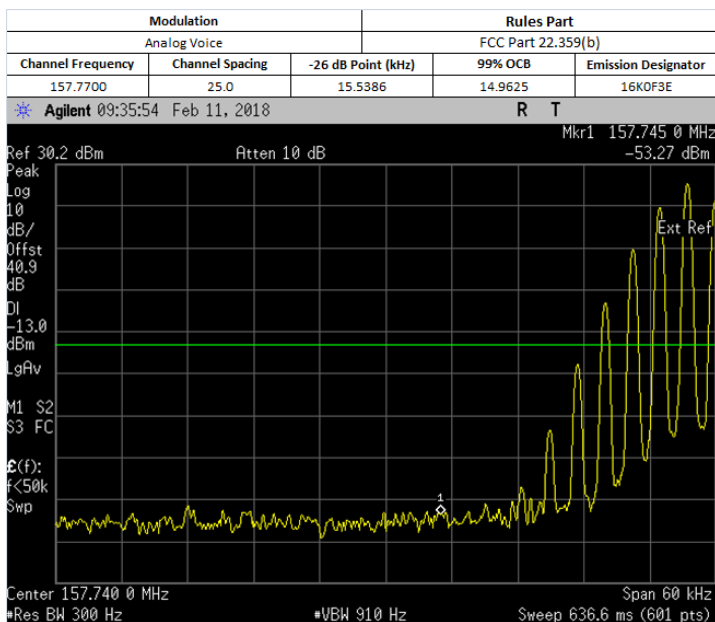
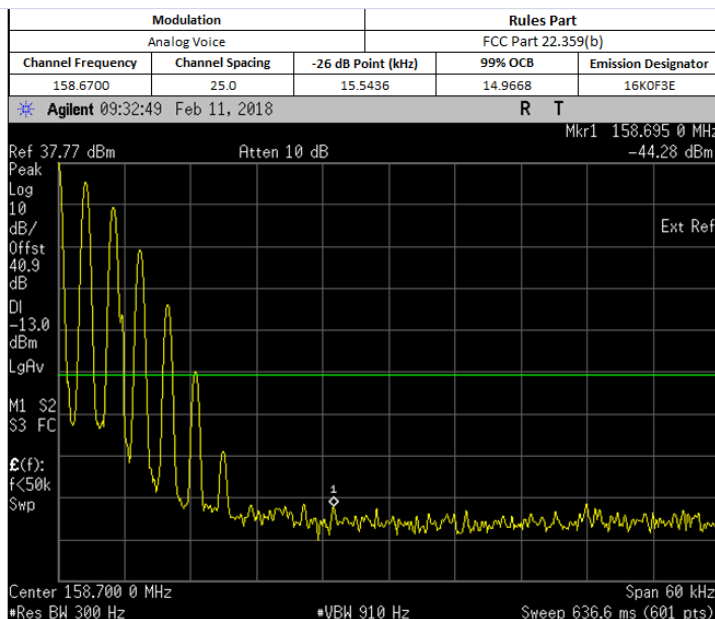
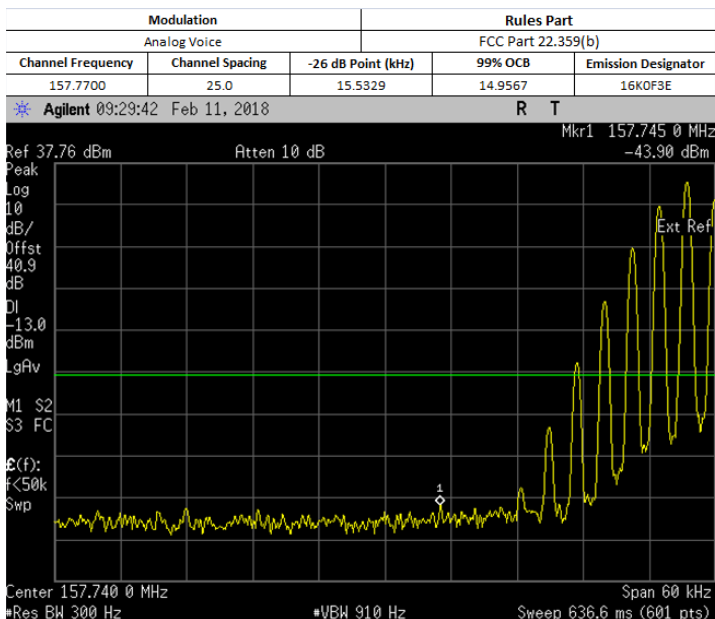

6.7.3. Test Setup (Digital)

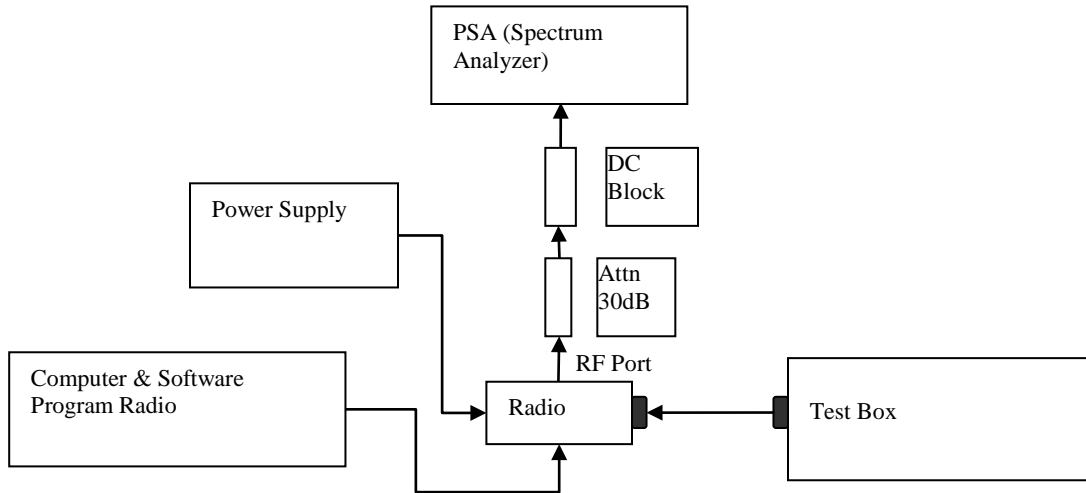

- 1) Program and set radio to operate in desire test frequency and digital mode with modulation. (*4FSK, C4FM or other digital modulation form).
- 2) Path loss for the measurement included.
- 3) Select the Occupied Bandwidth measurement for 99% and 26dB Emissions Bandwidth Measurement.
- 4) Key in the Fc and Resolution Bandwidth.
- 5) Transmit radio record the occupied Bandwidth frequencies.
- 6) Preset the spectrum analyzer for band edge measurement.
- 7) Key in the lowest and highest channels frequency, span is 60 kHz and Resolution Bandwidth is at least 1% of Emission Bandwidth.
- 8) Save the screen shot.

*Note:

- All digital modulation emission IDs use the same high deviation test pattern and are therefore identical. Hence only F1D will be shown.

6.7.4. Test Result (Digital)

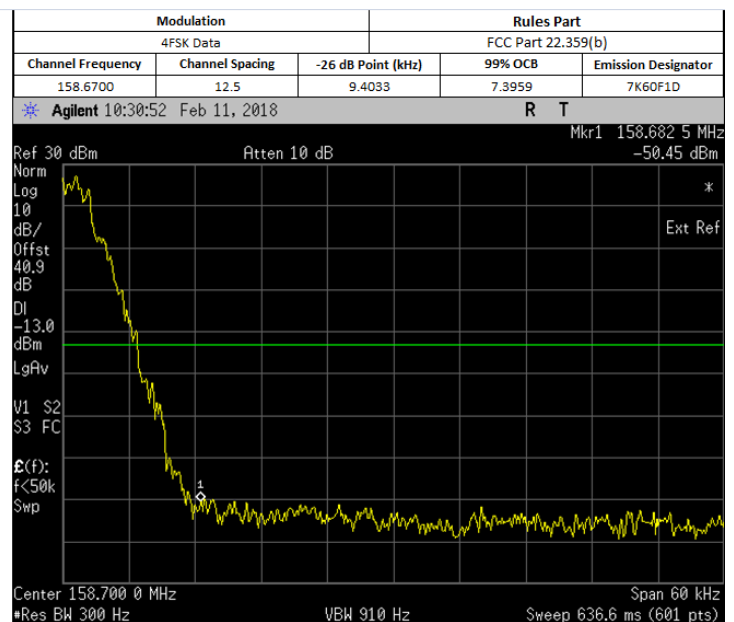
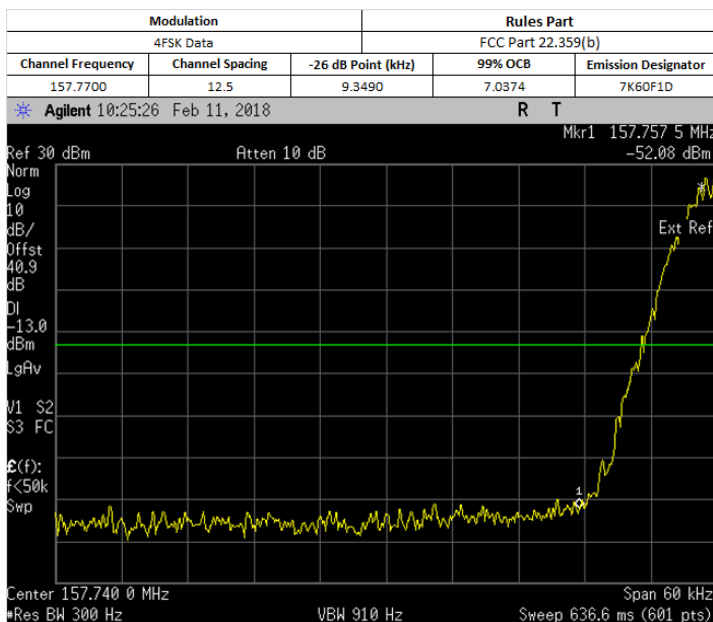
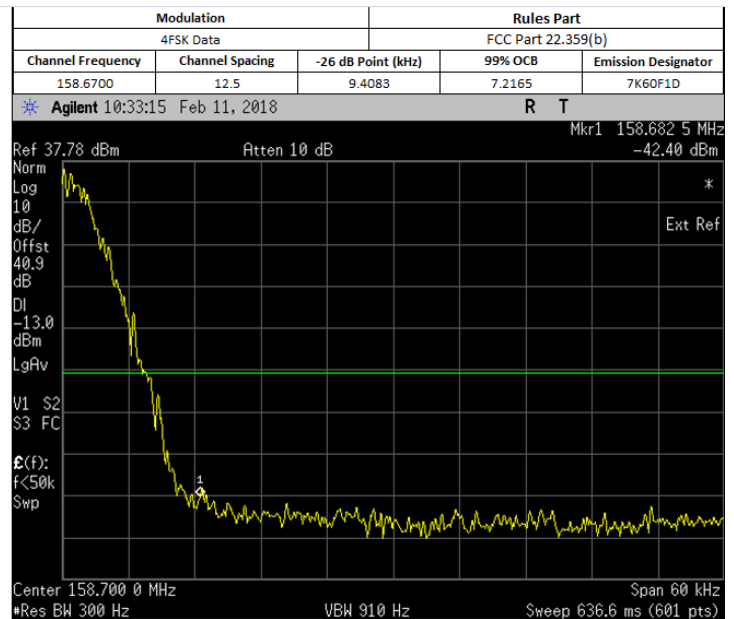
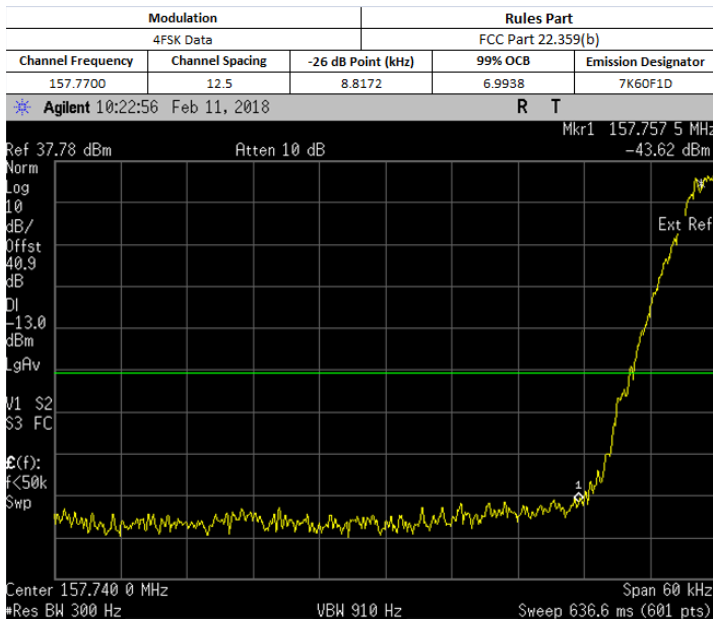

6.7.5. Test Limit

The power of any emission outside of the authorized operating frequency ranges must be attenuated below the transmitting power (P) by a factor of at least $43 + 10 \log(P)$ dB.

6.8. Transient Frequency Behavior

6.8.1. Test Setup

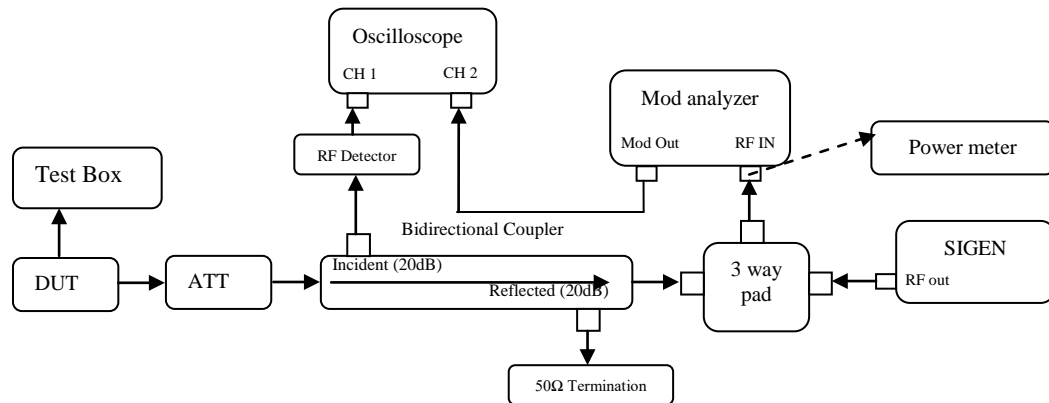

- 1) Connect the setup as figure above.
- 2) Path loss for the measurement included.
- 3) Set on Sigen with the assigned center frequency, internal 1 kHz FM tone.
FM Deviation: Analog 25kHz Channel Spacing = 25 kHz
Analog 12.5 kHz Channel Spacing = 12.5 kHz
C4FM = 12.5 kHz
- 4) Turn on 50 kHz high pass filter and 15 kHz low pass filter on modulation analyzer.
- 5) Supply sufficient attenuation ATT to provide the output power of $\leq -11\text{dBm}$ into power meter when DUT is keying up.
- 6) Note the power level on power meter and dekey the DUT.
- 7) Adjust the amplitude of the signal generator to the level power meter, maintained the amplitude throughout the rest of the measurement.
- 8) Connect the output to modulation analyzer.
- 9) Reduce 30dB attenuation and transmit the radio to get the trigger line.
- 10) Capture the screen shot for key-up (rising edge) and de-key (falling edge) mode.

6.8.2. Test Result

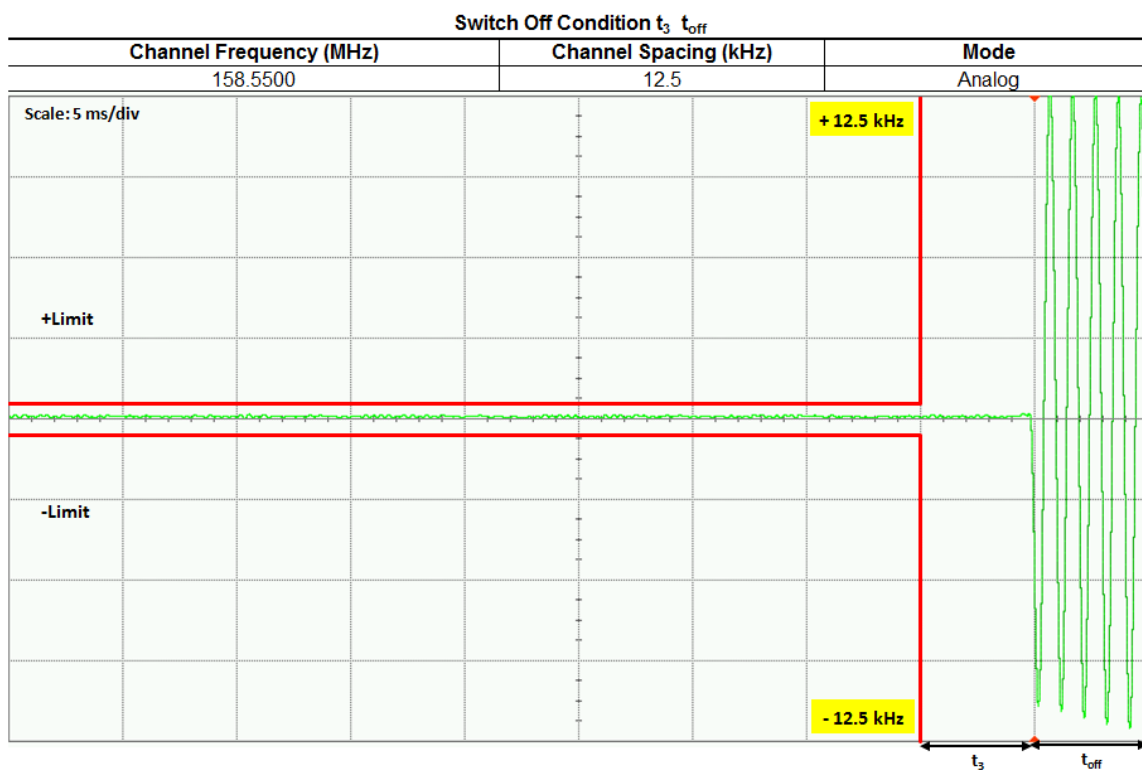
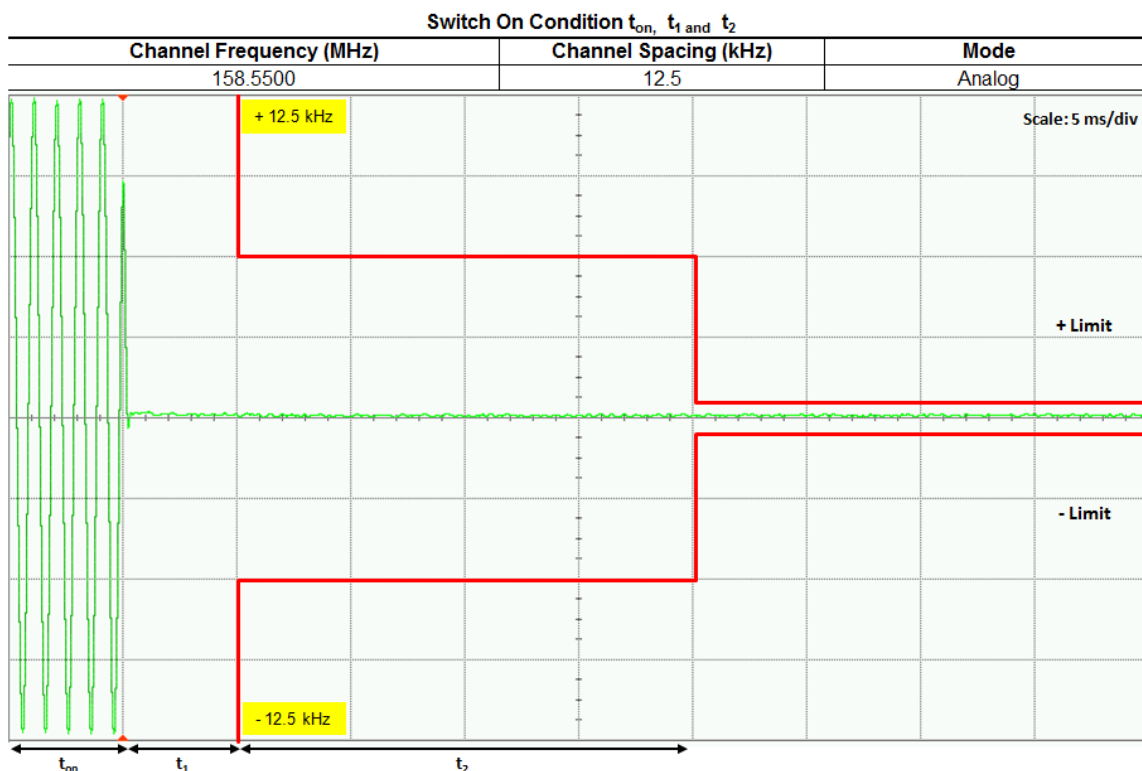

Not For FCC Review

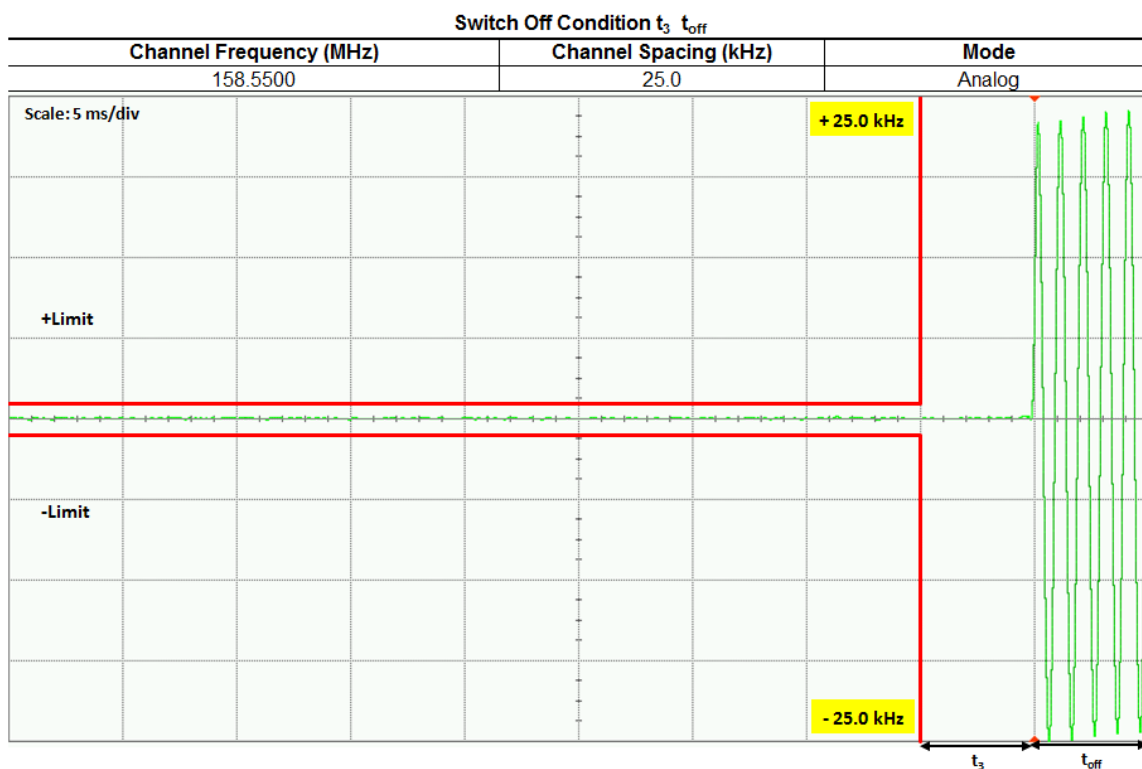
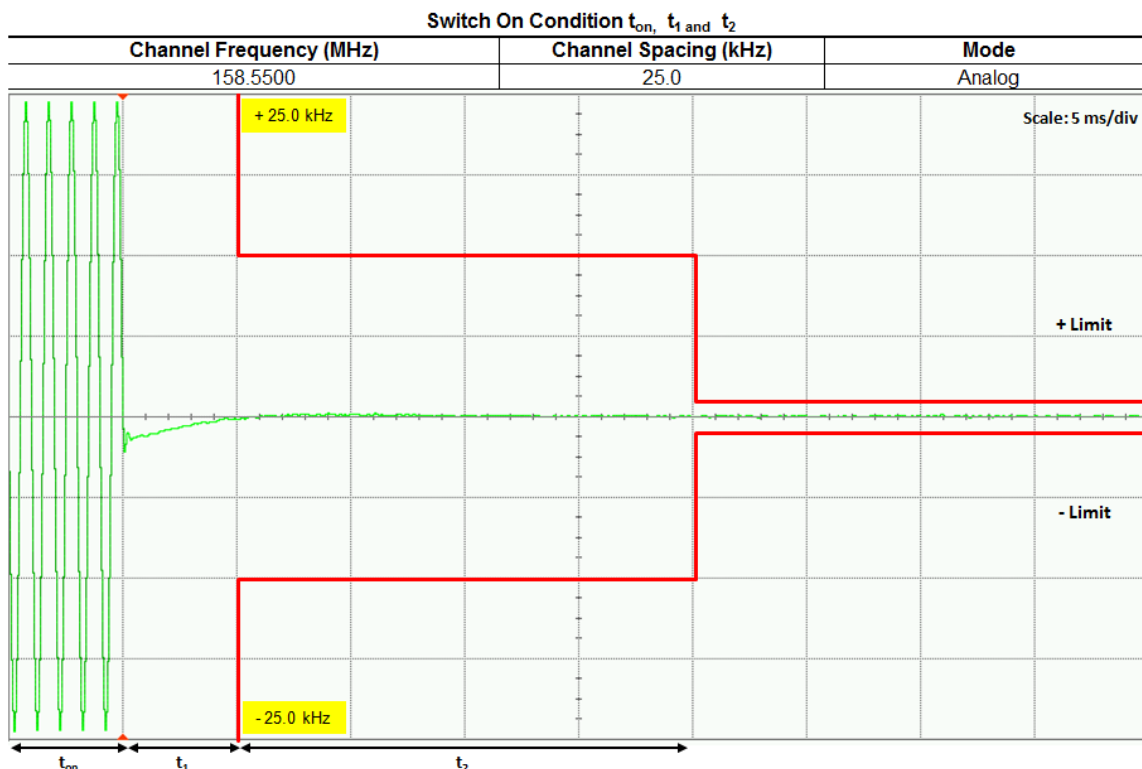

6.8.3. Test Limit

Transmitters designed to operate in the 150-174 MHz and 421-512 MHz frequency bands must maintain transient frequencies within the maximum frequency difference limits during the time intervals indicated:

Time intervals ^{1 2}	Maximum frequency difference ³	All equipment	
		150 to 174 MHz	421 to 512 MHz
Transient Frequency Behavior for Equipment Designed to Operate on 25 kHz Channels			
t ₁ ⁴	±25.0 kHz	5.0 ms	10.0 ms
t ₂	±12.5 kHz	20.0 ms	25.0 ms
t ₃ ⁴	±25.0 kHz	5.0 ms	10.0 ms
Transient Frequency Behavior for Equipment Designed to Operate on 12.5 kHz Channels			
t ₁ ⁴	±12.5 kHz	5.0 ms	10.0 ms
t ₂	±6.25 kHz	20.0 ms	25.0 ms
t ₃ ⁴	±12.5 kHz	5.0 ms	10.0 ms
Transient Frequency Behavior for Equipment Designed to Operate on 6.25 kHz Channels			
t ₁ ⁴	±6.25 kHz	5.0 ms	10.0 ms
t ₂	±3.125 kHz	20.0 ms	25.0 ms
t ₃ ⁴	±6.25 kHz	5.0 ms	10.0 ms

¹ t_{on} is the instant when a 1 kHz test signal is completely suppressed, including any capture time due to phasing.

t₁ is the time period immediately following t_{on}.

t₂ is the time period immediately following t₁.

t₃ is the time period from the instant when the transmitter is turned off until t_{off}.

t_{off} is the instant when the 1 kHz test signal starts to rise.

² During the time from the end of t₂ to the beginning of t₃, the frequency difference must not exceed the limits specified in §90.213.

³ Difference between the actual transmitter frequency and the assigned transmitter frequency.

⁴ If the transmitter carrier output power rating is 6 watts or less, the frequency difference during this time period may exceed the maximum frequency difference for this time period.

6.9. Adjacent Channel Power

6.9.1. Test Setup (Analog)

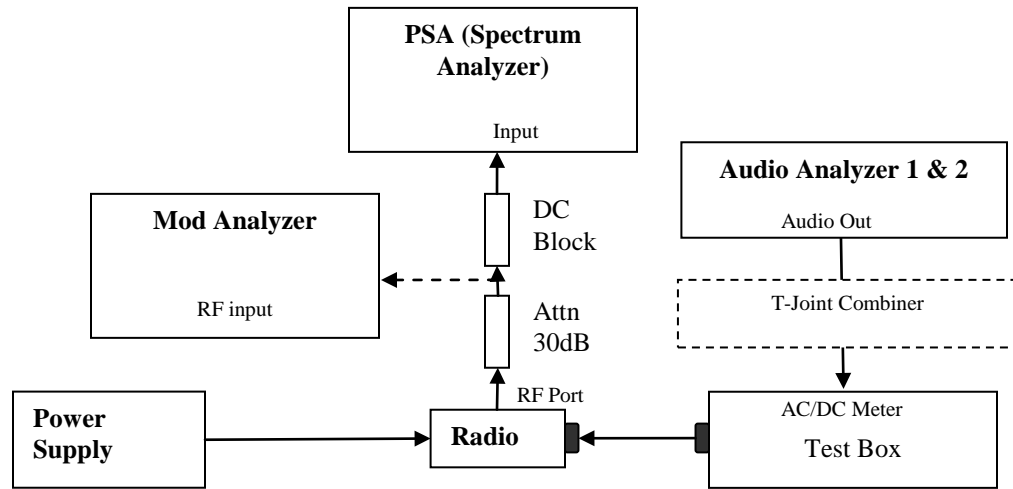

- 1) The DUT transmitter output port was connected to modulation analyzer.
- 2) Transmit the radio and turn on 1st audio analyzer with audio frequency 650Hz, 50% rated deviation, and record the amplitude value as AmpT1.
- 3) Turn off Audio analyzer 1 and turn on audio analyzer 2, set the audio frequency to 2.2 kHz and 50% deviation. Record the amplitude as AmpT2.
- 4) Turn both audio analyzers ON and up 10dB amplitude level.
- 5) Connect the output to PSA and set to assigned center frequency.
- 6) Set Span, Resolution Bandwidth and Video Bandwidth per rules part.
- 7) Transmit the radio and record the Adjacent Channel Power value in dBc.

6.9.2. Test Result (Analog) Not Applicable

6.9.3. Test Setup (Digital)

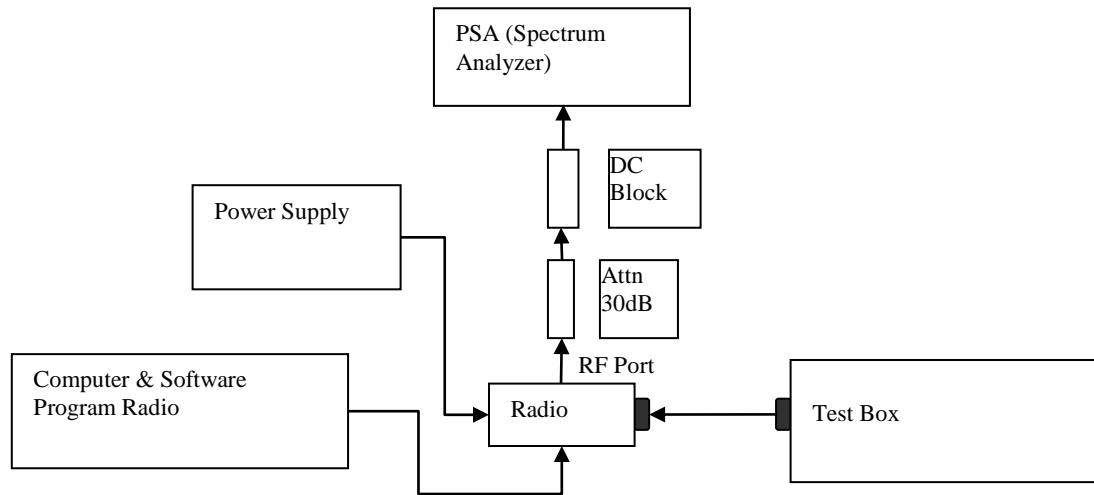

- 1) Program and set radio to operate in desire test frequency and digital mode with modulation. (4FSK, C4FM or other digital modulation form).
- 2) Prepare setup as per picture.
- 3) Turn on the ACP Measurement – Press Measure, ACP.
- 4) Set Span, Resolution Bandwidth and Video Bandwidth as per rules part.
- 5) Transmit the radio and record the Adjacent Channel Power value in dBc.

6.9.4. Test Result **Not Applicable**

6.9.5. Test Limit

12.5 kHz MOBILE TRANSMITTER ACP REQUIREMENTS

Offset from center frequency (kHz)	Measurement bandwidth (kHz)	Maximum ACP relative (dBc)
9.375	6.25	-40
15.625	6.25	-60
21.875	6.25	-60
37.50	25.00	-60
62.50	25.00	-65
87.50	25.00	-65
150.00	100	-65
250.00	100	-65
350.00	100	-65
>400 to 12 MHz	30 (s)	-75
12 MHz to paired receive band	30 (s)	-75
In the paired receive band	30 (s)	-100

25 kHz MOBILE TRANSMITTER ACP REQUIREMENTS

Offset from center frequency (kHz)	Measurement bandwidth (kHz)	Maximum ACP relative (dBc)
15.625	6.25	-40
21.875	6.25	-60
37.50	25	-60
62.50	25	-65
87.50	25	-65
150.00	100	-65
250.00	100	-65
350.00	100	-65
>400 kHz to 12 MHz	30 (s)	-75
12 MHz to paired receive band	30 (s)	-75
In the paired receive band	30 (s)	-100

12.5 kHz BASE TRANSMITTER ACP REQUIREMENTS

Offset from center frequency (kHz)	Measurement bandwidth (kHz)	Maximum ACP (dBc)
9.375	6.25	-40
15.625	6.25	-60
21.875	6.25	-60
37.5	25	-60
62.5	25	-65
87.5	25	-65
150	100	-65
250	100	-65
350.00	100	-65
>400 kHz to 12 MHz	30 (s)	-80
12 MHz to paired receive band	30 (s)	-80
In the paired receive band	30 (s)	-85

25 kHz BASE TRANSMITTER ACP REQUIREMENTS

Offset from center frequency (kHz)	Measurement bandwidth (kHz)	Maximum ACP (dBc)
15.625	6.25	-40
21.875	6.25	-60
37.5	25	-60
62.5	25	-65
87.5	25	-65
150	100	-65
250	100	-65
350	100.00	-65
>400 kHz to 12 MHz	30 (s)	-80
12 MHz to paired receive band	30 (s)	-80
In the paired receive band	30 (s)	-85

6.10. Conducted Spurious Emission

6.10.1. Test Setup

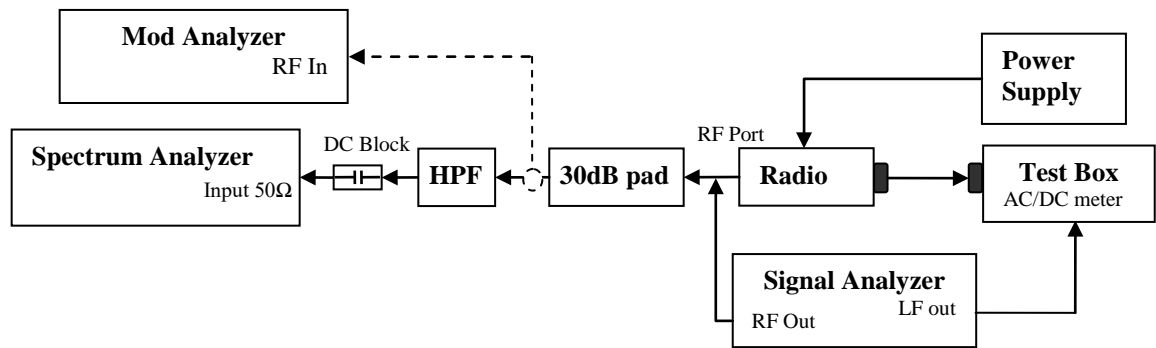

- 1) The DUT transmitter output port was connected to Modulation Analyzer or Spectrum Analyzer with above setup.
- 2) For analog measurement, turn off the High Pass Filter path and turn on 15 kHz low pass filter on modulation analyzer. Set Sigen to LF out ON with the assigned center frequency. Key up the DUT to get the 50% of rated deviation at mod analyzer and up amplitude 16dB with internal 2.5 kHz FM tone.
- 3) For Digital Measurement, Program and set radio to operate in desire test frequency and digital mode with modulation. (4FSK, C4FM or other digital modulation form).
- 4) Path loss for the measurement included.
- 5) Set the spectrum Resolution Bandwidth as per rules part.
- 6) Adjust the center frequency of the spectrum analyzer for incremental coverage of the range from:
 - a. 9 KHz to $F_c - \text{Test Bandwidth}$
 - b. $F_c + \text{Test Bandwidth}$ to $2F_c - 5\text{MHz}$.
- 7) Key up the DUT, record all the frequencies and levels of spurious emissions from step 5) and dekey the DUT.
- 8) Turn On HPF path and Key up the DUT.
- 9) Adjust the PSA Freq for coverage of range from $2F_c$ to $10F_c$, record the spur and harmonics level in dBm.
- 10) Whichever Spur level in step 7) & step 9) is within 20dB from the test limit, replace the DUT with the Sigen and adjust the signal level to reproduce the frequencies & levels. Record the signal generator levels in dBm.

6.10.2. Test Result (Analog)

Analog: 138.0125 MHz, 25.0 kHz Channel Spacing, Max Power RSS 119(Not for FCC review)

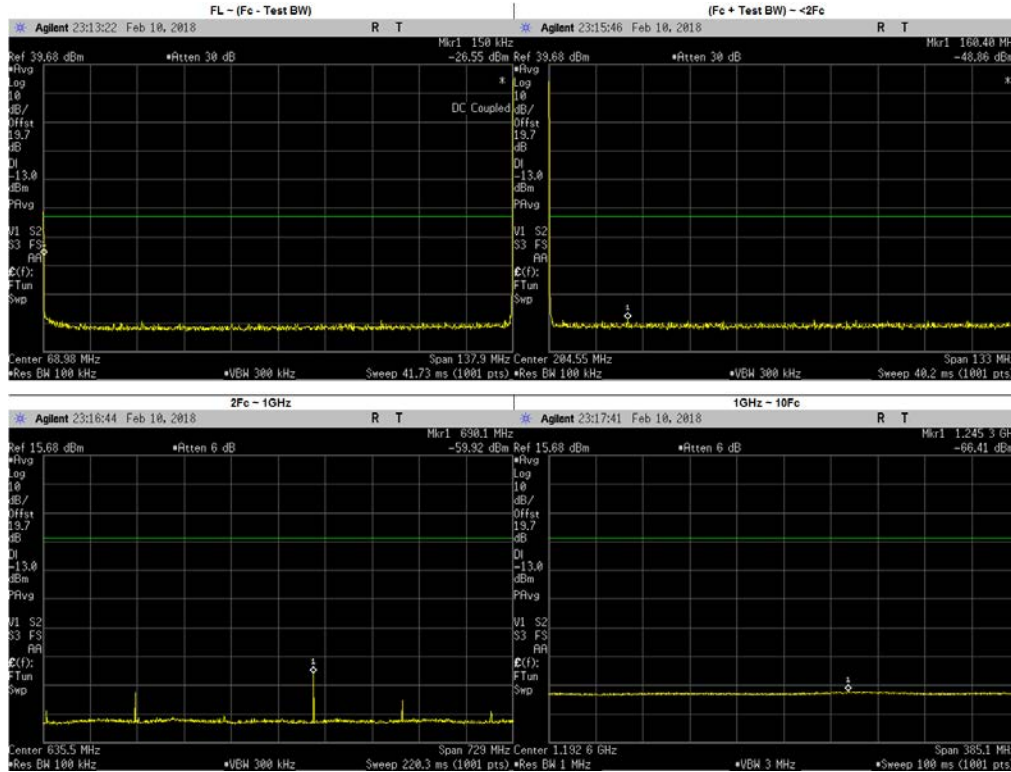

Frequency Range	Highest Spur Frequency (MHz)	Spurious Level (dBm)	Failing Limit (dBm)	Results
FL ~ (Fc - Test BW)	1.8023	-48.34	-13	PASS
(Fc + Test BW) ~ <2Fc	160.4049	-48.86	-13	PASS
2Fc ~ 1GHz	276.0250	-73.77	-13	PASS
	414.0375	-68.69	-13	PASS
	552.0500	-75.10	-13	PASS
	690.0625	-59.92	-13	PASS
	828.0750	-70.63	-13	PASS
	966.0875	-73.97	-13	PASS
1GHz ~ 10Fc	1245.3250	-66.41	-13	PASS
	1104.1000	-66.96	-13	PASS
	1242.1120	-66.77	-13	PASS
	1380.1250	-67.18	-13	PASS

Analog: 158.55 MHz, 25.0 kHz Channel Spacing, Max Power
FCC Part 22, 80, RSS 119, 182

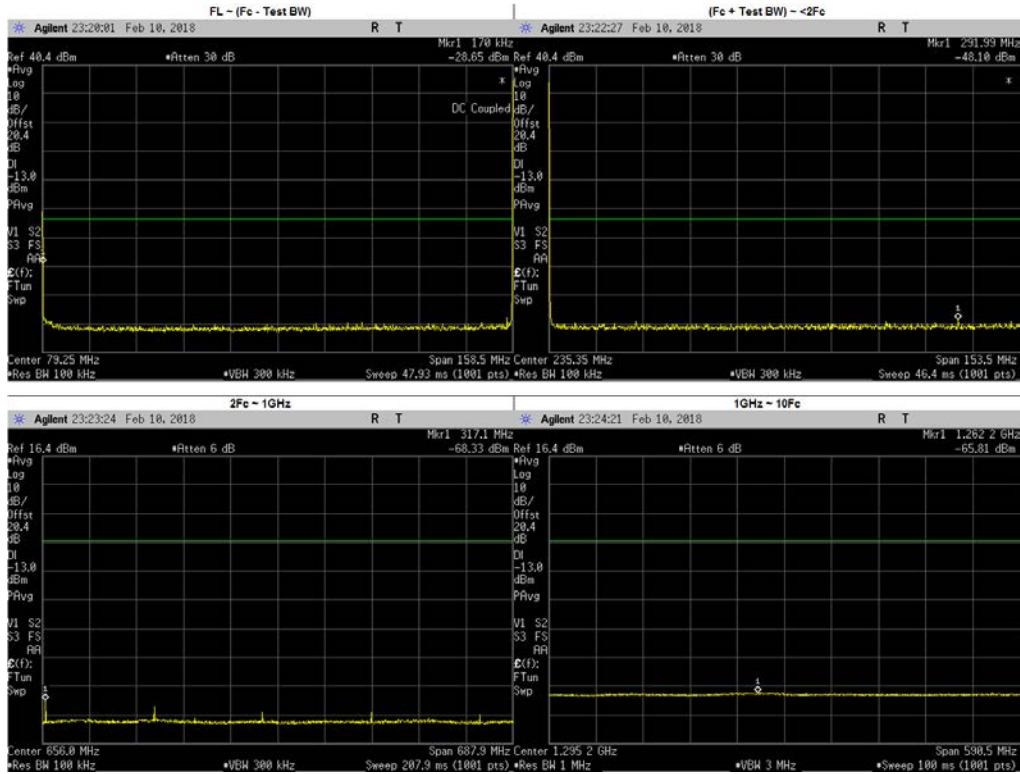

Frequency Range	Highest Spur Frequency (MHz)	Spurious Level (dBm)	Failing Limit (dBm)	Results
FL ~ (Fc - Test BW)	1.2769	-48.13	-13	PASS
(Fc + Test BW) ~ <2Fc	291.9922	-48.10	-13	PASS
2Fc ~ 1GHz	317.1000	-68.33	-13	PASS
	475.6500	-71.80	-13	PASS
	634.2000	-73.52	-13	PASS
	792.7500	-73.76	-13	PASS
	951.3000	-74.12	-13	PASS
1GHz ~ 10Fc	1262.1820	-65.81	-13	PASS
	1109.8500	-66.08	-13	PASS
	1268.4000	-66.21	-13	PASS
	1426.9500	-66.55	-13	PASS
	1585.5000	-66.38	-13	PASS

Analog: 158.55 MHz, 25.0 kHz Channel Spacing, Low Power
FCC Part 22, 80, RSS 119, 182

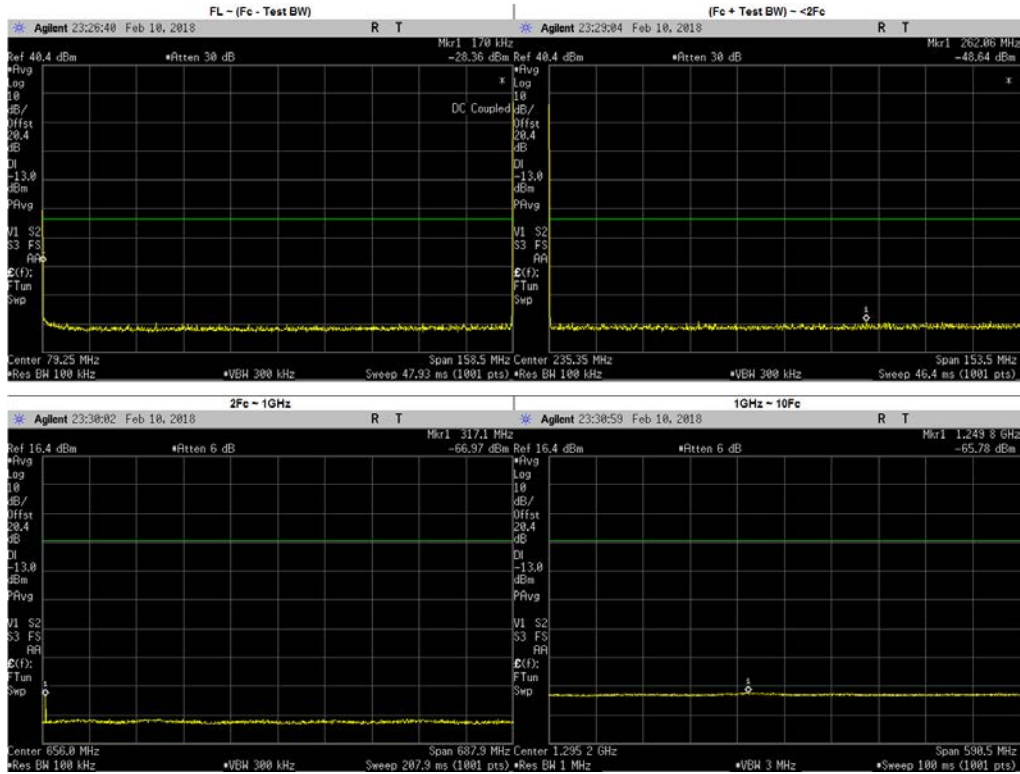

Frequency Range	Highest Spur Frequency (MHz)	Spurious Level (dBm)	Failing Limit (dBm)	Results
FL ~ (Fc - Test BW)	1.4354	-48.37	-13	PASS
(Fc + Test BW) ~ <2Fc	262.0608	-48.64	-13	PASS
2Fc ~ 1GHz	317.1000	-66.97	-13	PASS
	475.6500	-75.36	-13	PASS
	634.2000	-75.33	-13	PASS
	792.7500	-75.97	-13	PASS
	951.3000	-76.46	-13	PASS
1GHz ~ 10Fc	1249.7820	-65.78	-13	PASS
	1109.8500	-66.45	-13	PASS
	1268.4000	-66.15	-13	PASS
	1426.9500	-66.49	-13	PASS
	1585.5000	-66.31	-13	PASS

**Analog: 161.7 MHz, 25.0 kHz Channel Spacing, Max Power
 FCC Part 74, RSS 119**

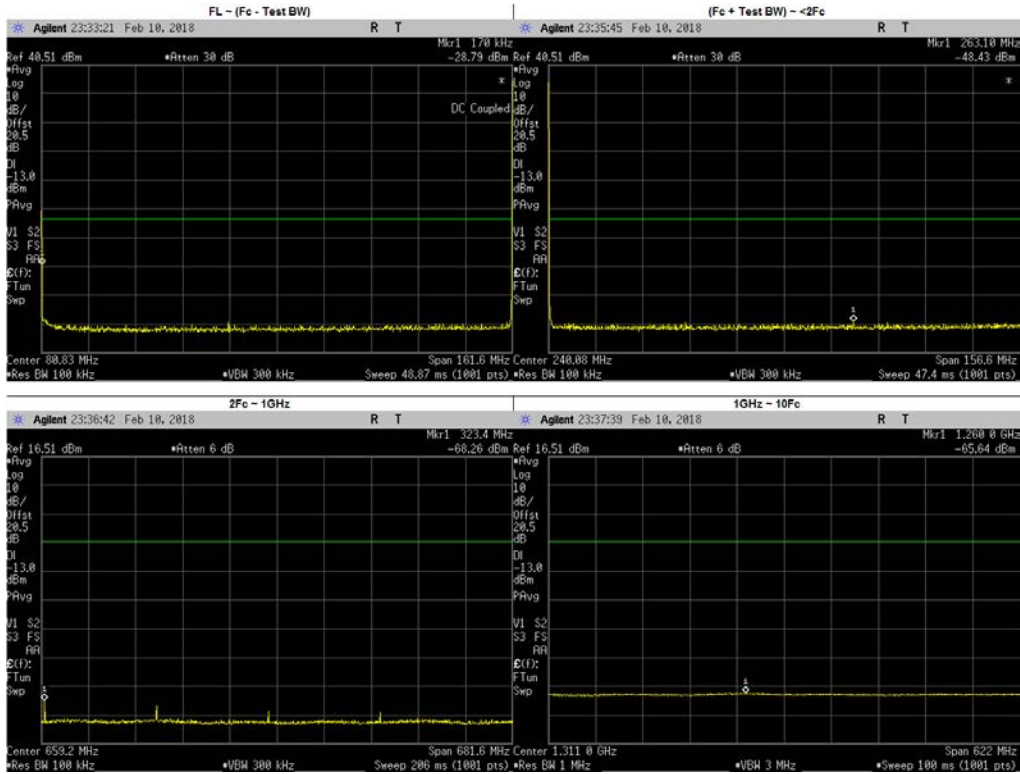

Frequency Range	Highest Spur Frequency (MHz)	Spurious Level (dBm)	Failing Limit (dBm)	Results
FL ~ (Fc - Test BW)	64.1782	-48.91	-13	PASS
(Fc + Test BW) ~ <2Fc	263.1045	-48.43	-13	PASS
2Fc ~ 1GHz	323.4000	-68.26	-13	PASS
	485.1000	-71.30	-13	PASS
	646.8000	-72.72	-13	PASS
	808.5000	-72.58	-13	PASS
	970.2000	-75.23	-13	PASS
1GHz ~ 10Fc	1259.9960	-65.64	-13	PASS
	1131.9000	-66.31	-13	PASS
	1293.6000	-66.28	-13	PASS
	1455.3000	-66.45	-13	PASS
	1617.0000	-66.24	-13	PASS

**Analog: 161.7 MHz, 25.0 kHz Channel Spacing, Low Power
 FCC Part 74, RSS 119**

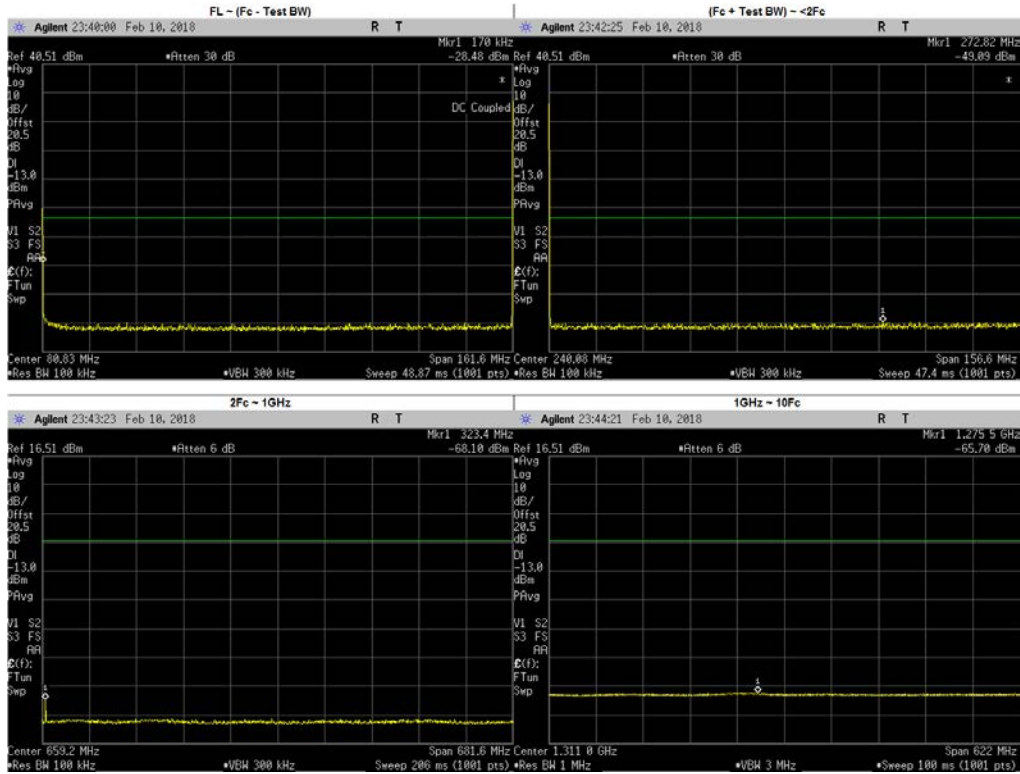

Frequency Range	Highest Spur Frequency (MHz)	Spurious Level (dBm)	Failing Limit (dBm)	Results
FL ~ (Fc - Test BW)	1.3021	-47.95	-13	PASS
(Fc + Test BW) ~ <2Fc	272.8165	-49.09	-13	PASS
2Fc ~ 1GHz	323.4000	-68.10	-13	PASS
	485.1000	-75.09	-13	PASS
	646.8000	-75.65	-13	PASS
	808.5000	-75.91	-13	PASS
	970.2000	-76.08	-13	PASS
1GHz ~ 10Fc	1275.5460	-65.70	-13	PASS
	1131.9000	-66.30	-13	PASS
	1293.6000	-66.46	-13	PASS
	1455.3000	-66.62	-13	PASS
	1617.0000	-66.14	-13	PASS

Analog: 173.3875 MHz, 25.0 kHz Channel Spacing, Max Power
RSS 119

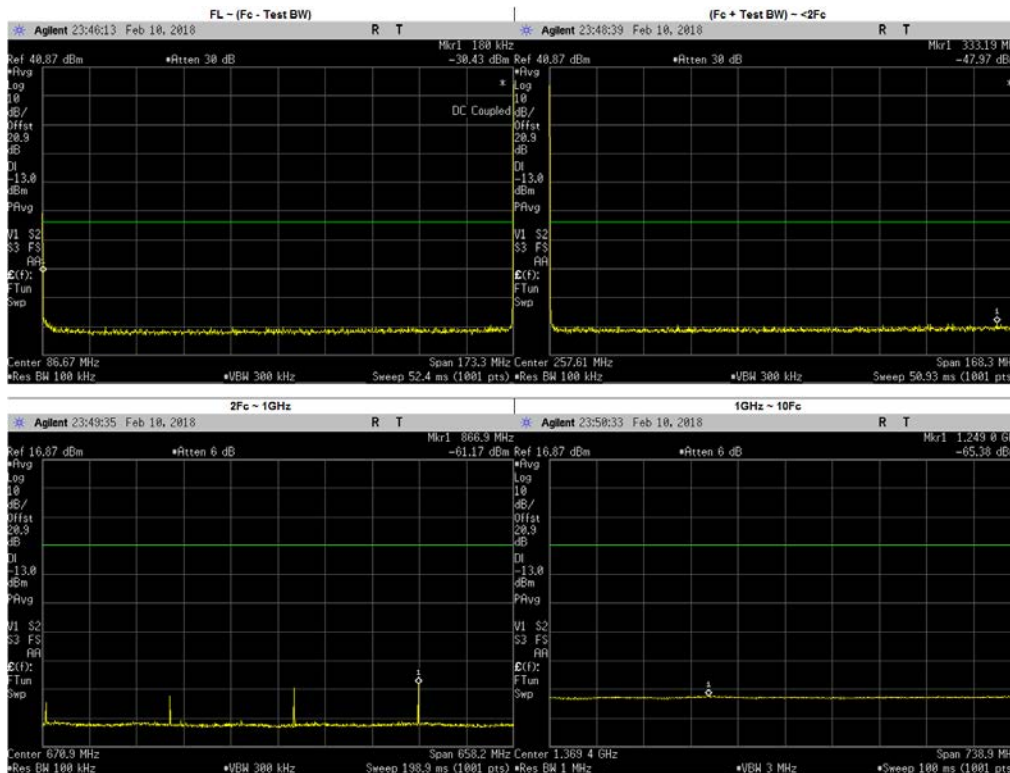

Frequency Range	Highest Spur Frequency (MHz)	Spurious Level (dBm)	Failing Limit (dBm)	Results
FL ~ (Fc - Test BW)	1.2223	-46.77	-13	PASS
(Fc + Test BW) ~ <2Fc	333.1901	-47.97	-13	PASS
2Fc ~ 1GHz	346.7750	-69.82	-13	PASS
	520.1625	-65.52	-13	PASS
	693.5500	-66.32	-13	PASS
	866.9375	-61.17	-13	PASS
1GHz ~ 10Fc	1249.0010	-65.38	-13	PASS
	1040.3250	-65.99	-13	PASS
	1213.7130	-65.91	-13	PASS
	1387.1000	-65.91	-13	PASS
	1560.4870	-66.10	-13	PASS
	1733.8750	-65.71	-13	PASS

**Analog: 157.77 MHz, 25.0 kHz Channel Spacing, Max Power
 FCC Part 22**

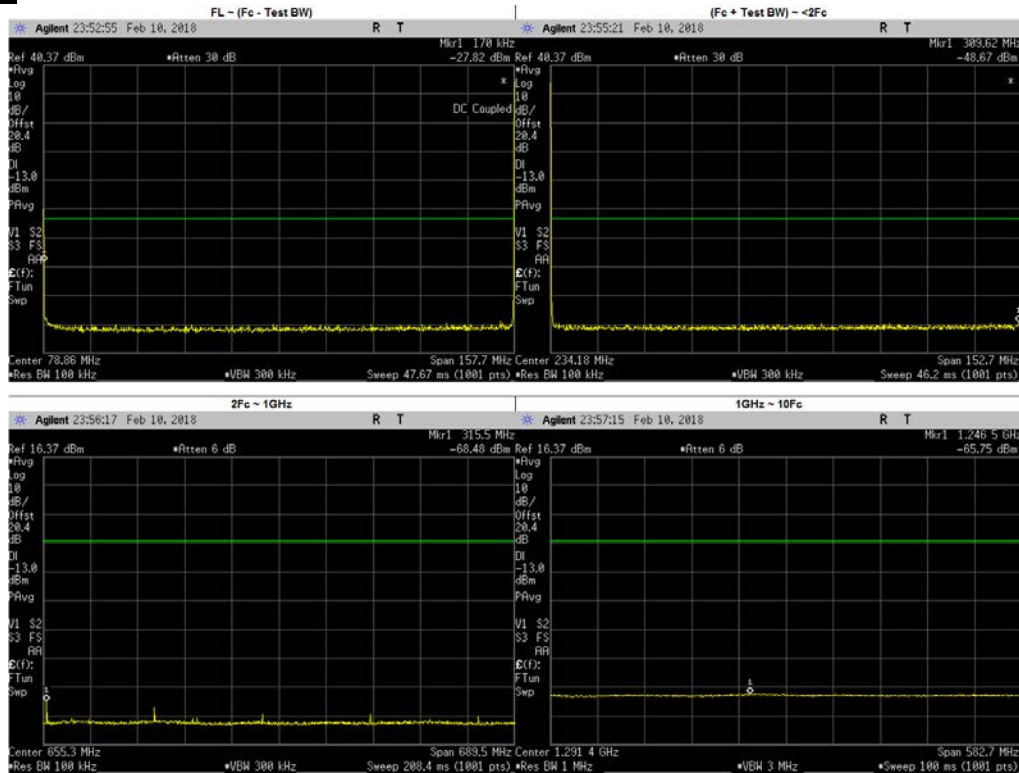

Frequency Range	Highest Spur Frequency (MHz)	Spurious Level (dBm)	Failing Limit (dBm)	Results
FL ~ (Fc - Test BW)	152.9832	-48.45	-13	PASS
(Fc + Test BW) ~ <2Fc	309.6237	-48.67	-13	PASS
2Fc ~ 1GHz	315.5400	-68.48	-13	PASS
	473.3100	-70.95	-13	PASS
	631.0800	-73.15	-13	PASS
	788.8500	-73.62	-13	PASS
	946.6200	-74.52	-13	PASS
1GHz ~ 10Fc	1246.4820	-65.75	-13	PASS
	1104.3900	-66.53	-13	PASS
	1262.1600	-66.03	-13	PASS
	1419.9300	-66.56	-13	PASS
	1577.7000	-66.55	-13	PASS

Analog: 157.77 MHz, 25.0 kHz Channel Spacing, Low Power
FCC Part 22

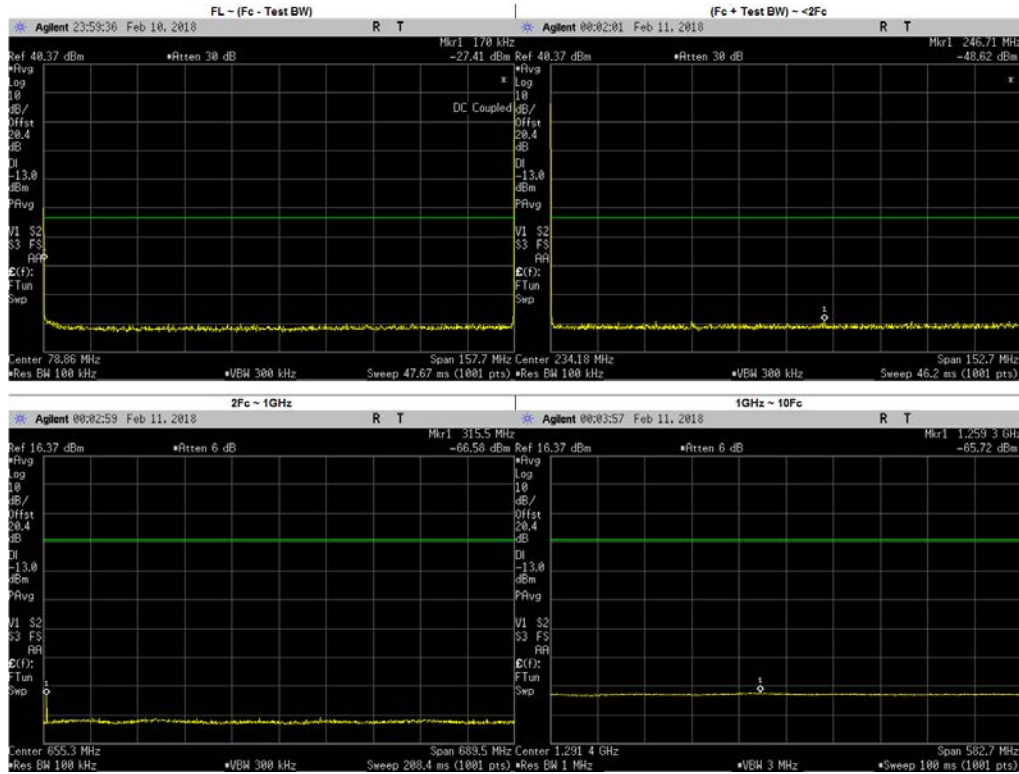

Frequency Range	Highest Spur Frequency (MHz)	Spurious Level (dBm)	Failing Limit (dBm)	Results
FL ~ (Fc - Test BW)	2.3746	-48.57	-13	PASS
(Fc + Test BW) ~ <2Fc	246.7054	-48.62	-13	PASS
2Fc ~ 1GHz	315.5400	-66.58	-13	PASS
	473.3100	-75.31	-13	PASS
	631.0800	-75.96	-13	PASS
	788.8500	-76.14	-13	PASS
	946.6200	-76.04	-13	PASS
1GHz ~ 10Fc	1259.3020	-65.72	-13	PASS
	1104.3900	-66.45	-13	PASS
	1262.1600	-66.04	-13	PASS
	1419.9300	-66.70	-13	PASS
	1577.7000	-66.55	-13	PASS

**Analog: 158.67 MHz, 25.0 kHz Channel Spacing, Max Power
 FCC Part 22**

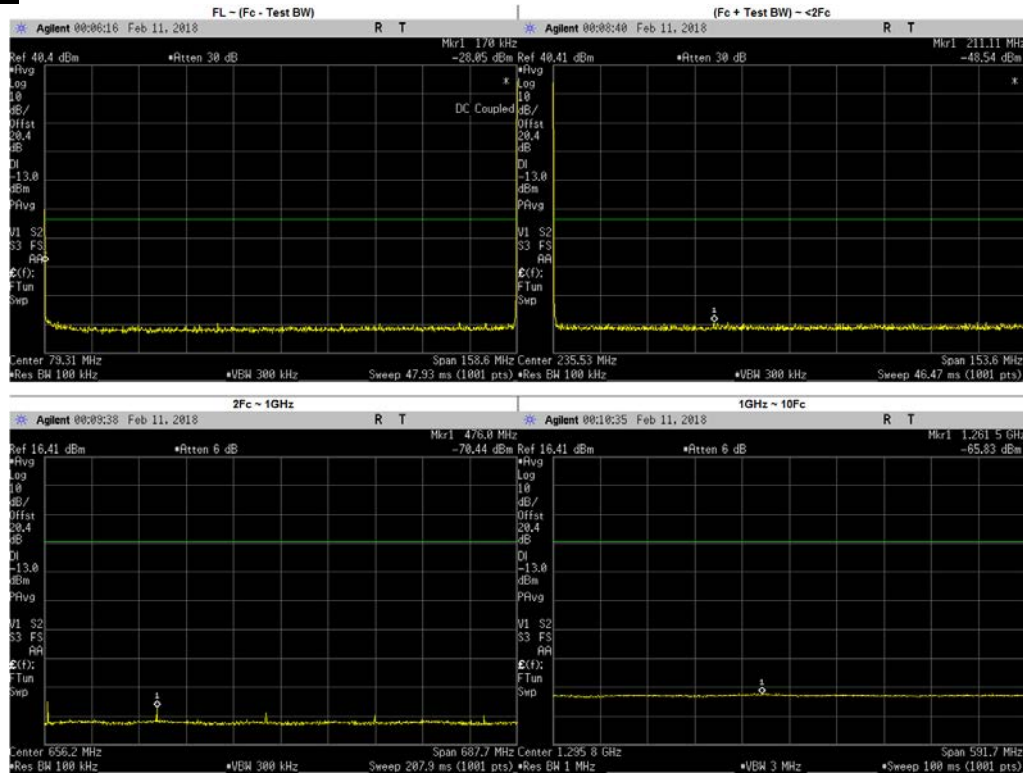

Frequency Range	Highest Spur Frequency (MHz)	Spurious Level (dBm)	Failing Limit (dBm)	Results
FL ~ (Fc - Test BW)	1.4364	-47.83	-13	PASS
(Fc + Test BW) ~ <2Fc	211.1081	-48.54	-13	PASS
2Fc ~ 1GHz	317.3400	-70.54	-13	PASS
	476.0100	-70.44	-13	PASS
	634.6800	-73.16	-13	PASS
	793.3500	-74.20	-13	PASS
	952.0200	-74.13	-13	PASS
1GHz ~ 10Fc	1261.5310	-65.83	-13	PASS
	1110.6900	-66.35	-13	PASS
	1269.3600	-65.97	-13	PASS
	1428.0300	-66.50	-13	PASS
	1586.7000	-66.48	-13	PASS

**Analog: 158.67 MHz, 25.0 kHz Channel Spacing, Low Power
 FCC Part 22**

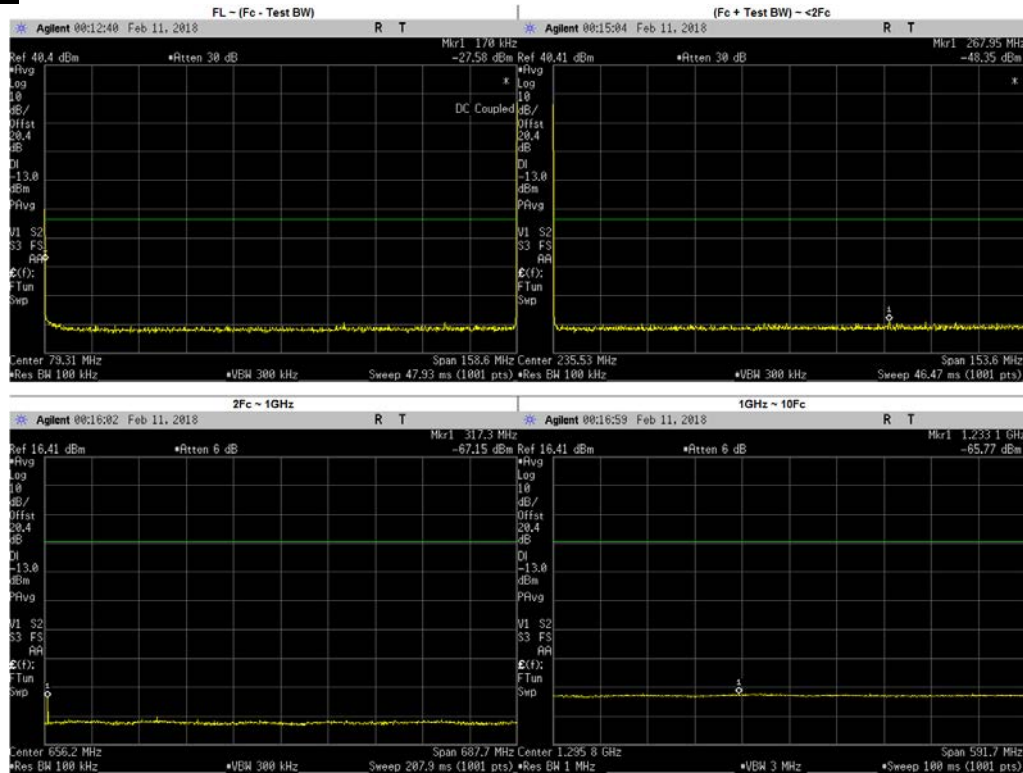

Frequency Range	Highest Spur Frequency (MHz)	Spurious Level (dBm)	Failing Limit (dBm)	Results
FL ~ (Fc - Test BW)	134.3478	-48.97	-13	PASS
(Fc + Test BW) ~ <2Fc	267.9454	-48.35	-13	PASS
2Fc ~ 1GHz	317.3400	-67.15	-13	PASS
	476.0100	-73.81	-13	PASS
	634.6800	-75.94	-13	PASS
	793.3500	-76.18	-13	PASS
	952.0200	-76.44	-13	PASS
1GHz ~ 10Fc	1233.1300	-65.77	-13	PASS
	1110.6900	-66.56	-13	PASS
	1269.3600	-66.17	-13	PASS
	1428.0300	-66.65	-13	PASS
	1586.7000	-66.43	-13	PASS

6.10.3. Test Result (Digital)

Digital: 138.0125 MHz, 12.5 kHz Channel Spacing, Max Power RSS 119(Not for FCC review)

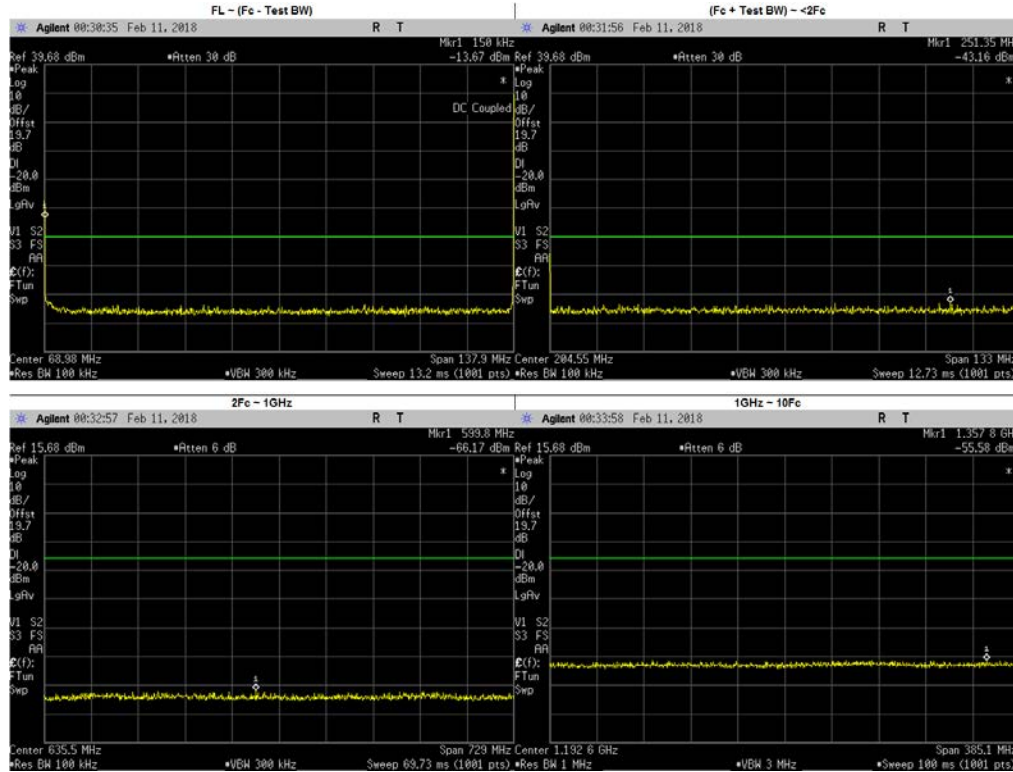

Frequency Range	Highest Spur Frequency (MHz)	Spurious Level (dBm)	Failing Limit (dBm)	Results
FL ~ (Fc - Test BW)	94.0895	-43.63	-20	PASS
(Fc + Test BW) ~ <2Fc	251.3474	-43.16	-20	PASS
2Fc ~ 1GHz	599.7927	-66.17	-20	PASS
	276.0250	-69.53	-20	PASS
	414.0375	-68.72	-20	PASS
	552.0500	-68.72	-20	PASS
	690.0625	-67.37	-20	PASS
	828.0750	-67.31	-20	PASS
1GHz ~ 10Fc	966.0875	-68.19	-20	PASS
	1357.7810	-55.58	-20	PASS
	1104.1000	-57.26	-20	PASS
	1242.1120	-56.84	-20	PASS
	1380.1250	-57.40	-20	PASS

Digital: 158.55 MHz, 12.5 kHz Channel Spacing, Max Power
FCC Part 22, 90, RSS 119

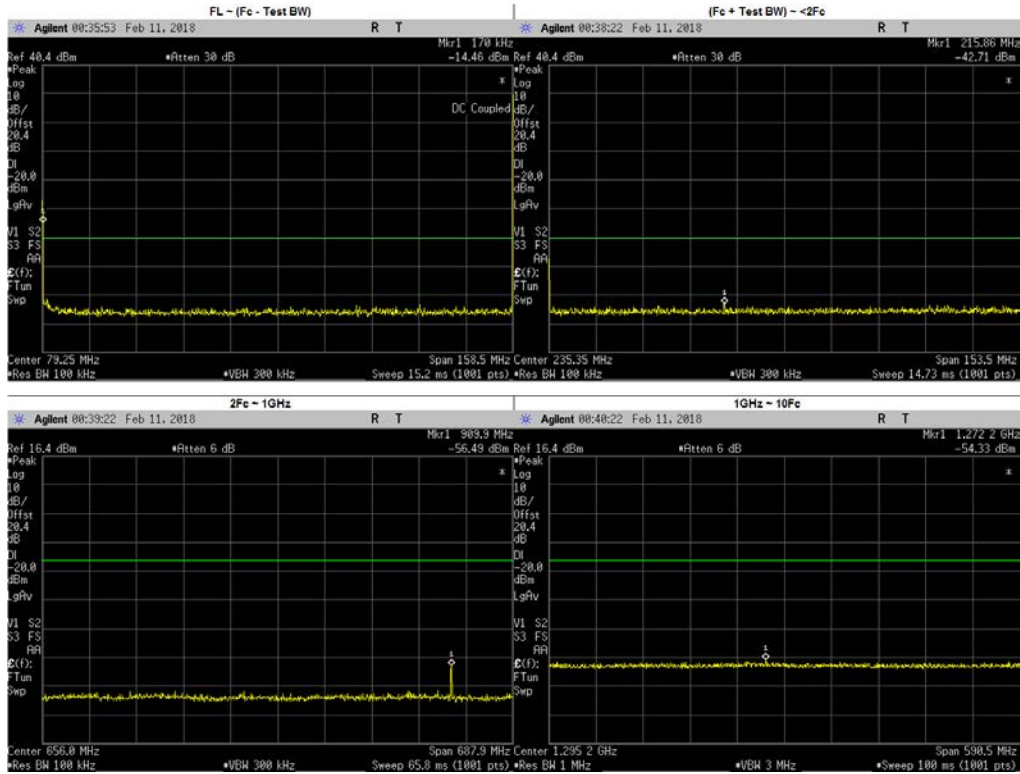

Frequency Range	Highest Spur Frequency (MHz)	Spurious Level (dBm)	Failing Limit (dBm)	Results
FL ~ (Fc - Test BW)	1.5939	-40.87	-20	PASS
(Fc + Test BW) ~ <2Fc	215.8590	-42.71	-20	PASS
2Fc ~ 1GHz	909.8851	-56.49	-20	PASS
	317.1000	-66.66	-20	PASS
	475.6500	-66.42	-20	PASS
	634.2000	-67.25	-20	PASS
	792.7500	-67.27	-20	PASS
	951.3000	-67.45	-20	PASS
1GHz ~ 10Fc	1272.2200	-54.33	-20	PASS
	1109.8500	-56.93	-20	PASS
	1268.4000	-56.40	-20	PASS
	1426.9500	-56.67	-20	PASS
	1585.5000	-56.22	-20	PASS

Digital: 158.55 MHz, 12.5 kHz Channel Spacing, Low Power
FCC Part 22, 90, RSS 119

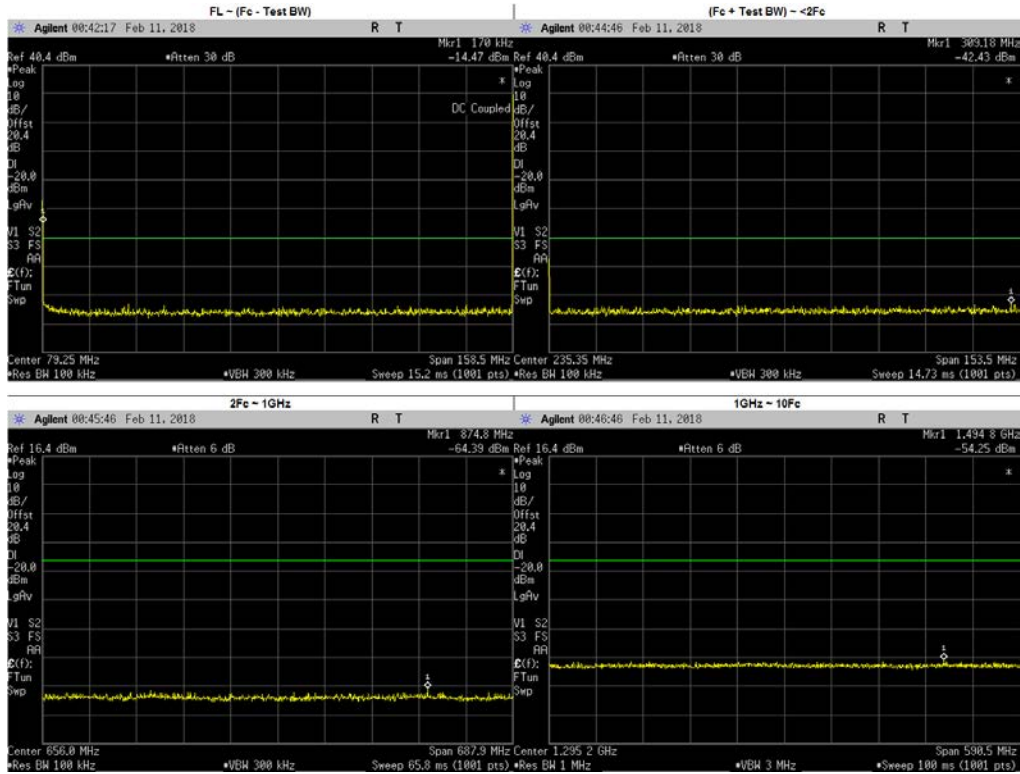

Frequency Range	Highest Spur Frequency (MHz)	Spurious Level (dBm)	Failing Limit (dBm)	Results
FL ~ (Fc - Test BW)	142.8043	-42.86	-20	PASS
(Fc + Test BW) ~ <2Fc	309.1836	-42.43	-20	PASS
2Fc ~ 1GHz	874.8022	-64.39	-20	PASS
	317.1000	-67.17	-20	PASS
	475.6500	-66.03	-20	PASS
	634.2000	-66.91	-20	PASS
	792.7500	-67.46	-20	PASS
	951.3000	-67.52	-20	PASS
1GHz ~ 10Fc	1494.8390	-54.25	-20	PASS
	1109.8500	-56.47	-20	PASS
	1268.4000	-55.55	-20	PASS
	1426.9500	-56.93	-20	PASS
	1585.5000	-56.60	-20	PASS

**Digital: 161.7 MHz, 12.5 kHz Channel Spacing, Max Power
 FCC Part 74, 90, RSS 119**

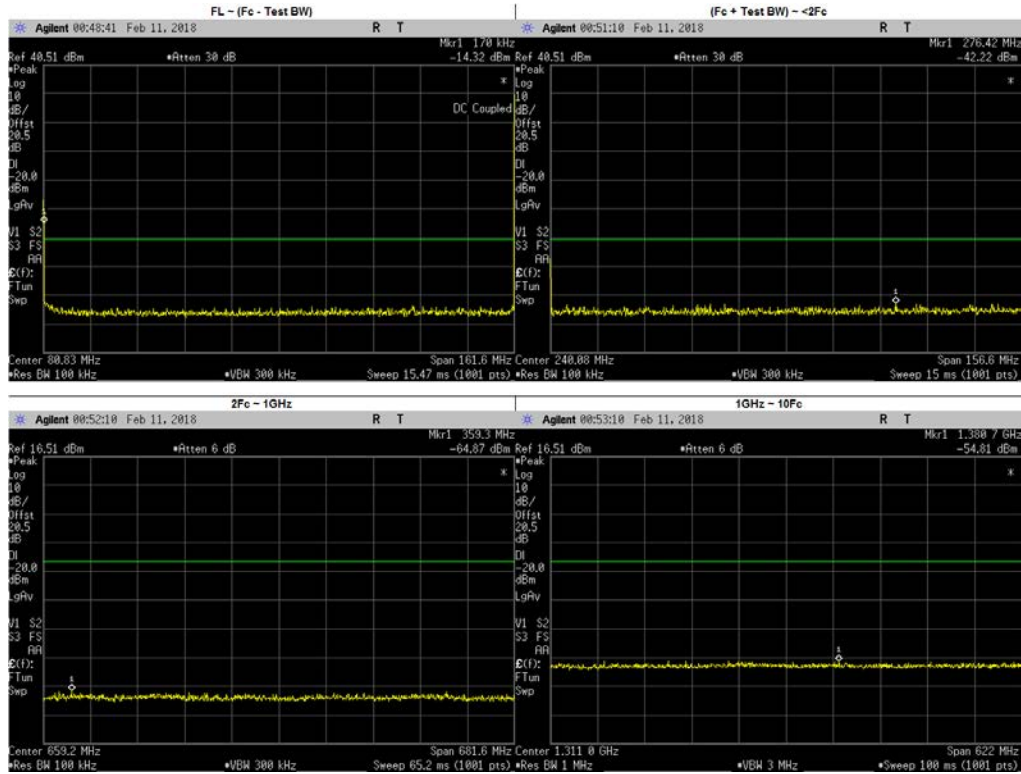

Frequency Range	Highest Spur Frequency (MHz)	Spurious Level (dBm)	Failing Limit (dBm)	Results
FL ~ (Fc - Test BW)	1.3021	-42.24	-20	PASS
(Fc + Test BW) ~ <2Fc	276.4193	-42.22	-20	PASS
2Fc ~ 1GHz	359.2960	-64.87	-20	PASS
	323.4000	-67.83	-20	PASS
	485.1000	-66.59	-20	PASS
	646.8000	-67.37	-20	PASS
	808.5000	-67.10	-20	PASS
	970.2000	-67.55	-20	PASS
1GHz ~ 10Fc	1380.6640	-54.81	-20	PASS
	1131.9000	-56.66	-20	PASS
	1293.6000	-55.77	-20	PASS
	1455.3000	-56.83	-20	PASS
	1617.0000	-56.26	-20	PASS

**Digital: 161.7 MHz, 12.5 kHz Channel Spacing, Low Power
 FCC Part 74, 90, RSS 119**

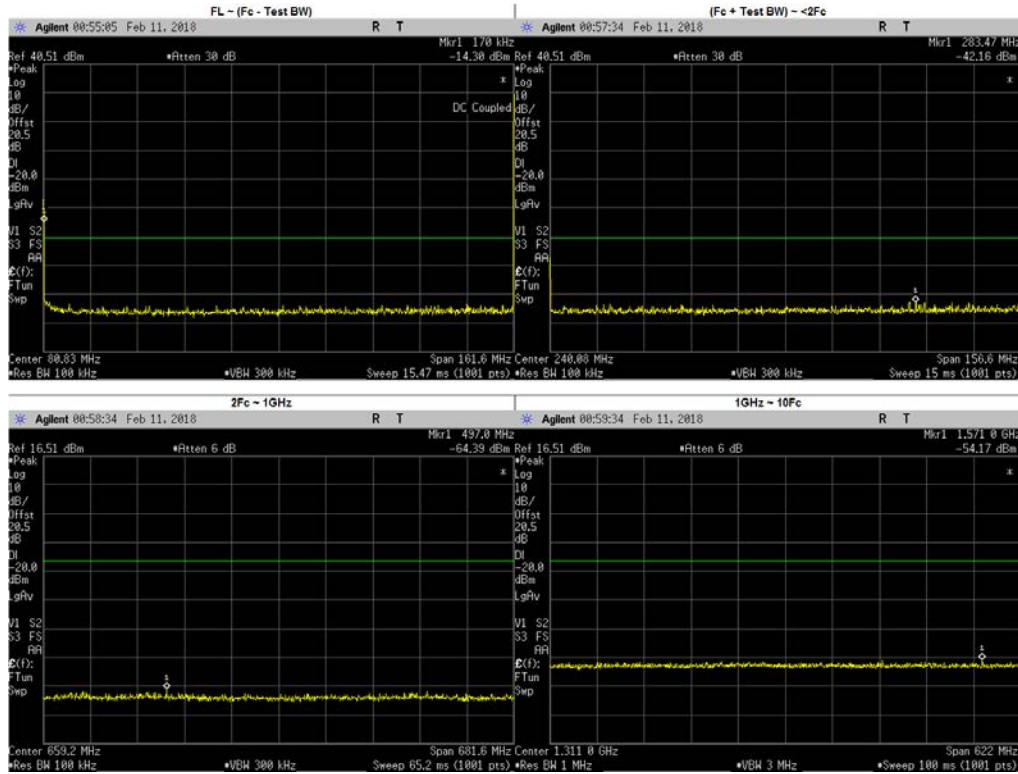

Frequency Range	Highest Spur Frequency (MHz)	Spurious Level (dBm)	Failing Limit (dBm)	Results
FL ~ (Fc - Test BW)	2.1103	-42.18	-20	PASS
(Fc + Test BW) ~ <2Fc	283.4683	-42.16	-20	PASS
2Fc ~ 1GHz	496.9792	-64.39	-20	PASS
	323.4000	-67.33	-20	PASS
	485.1000	-66.50	-20	PASS
	646.8000	-67.30	-20	PASS
	808.5000	-67.96	-20	PASS
	970.2000	-67.61	-20	PASS
1GHz ~ 10Fc	1570.9960	-54.17	-20	PASS
	1131.9000	-55.74	-20	PASS
	1293.6000	-56.65	-20	PASS
	1455.3000	-56.39	-20	PASS
	1617.0000	-55.89	-20	PASS

**Digital: 173.3875 MHz, 12.5 kHz Channel Spacing, Max Power
 FCC Part 90, RSS 119**

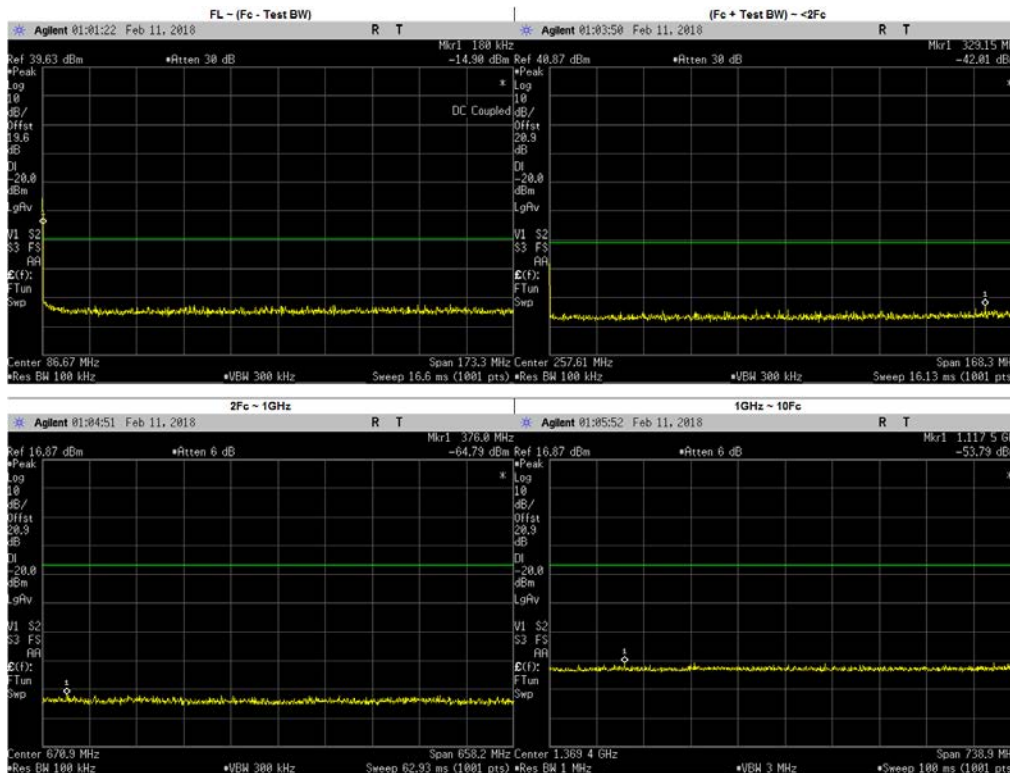

Frequency Range	Highest Spur Frequency (MHz)	Spurious Level (dBm)	Failing Limit (dBm)	Results
FL ~ (Fc - Test BW)	150.1066	-42.60	-20	PASS
(Fc + Test BW) ~ <2Fc	329.1501	-42.01	-20	PASS
2Fc ~ 1GHz	376.0027	-64.79	-20	PASS
	346.7750	-66.96	-20	PASS
	520.1625	-67.24	-20	PASS
	693.5500	-66.58	-20	PASS
	866.9375	-66.41	-20	PASS
1GHz ~ 10Fc	1117.4810	-53.79	-20	PASS
	1040.3250	-56.45	-20	PASS
	1213.7130	-55.87	-20	PASS
	1387.1000	-56.14	-20	PASS
	1560.4870	-56.08	-20	PASS
	1733.8750	-55.53	-20	PASS

**Digital: 157.77 MHz, 12.5 kHz Channel Spacing, Max Power
 FCC Part 22**

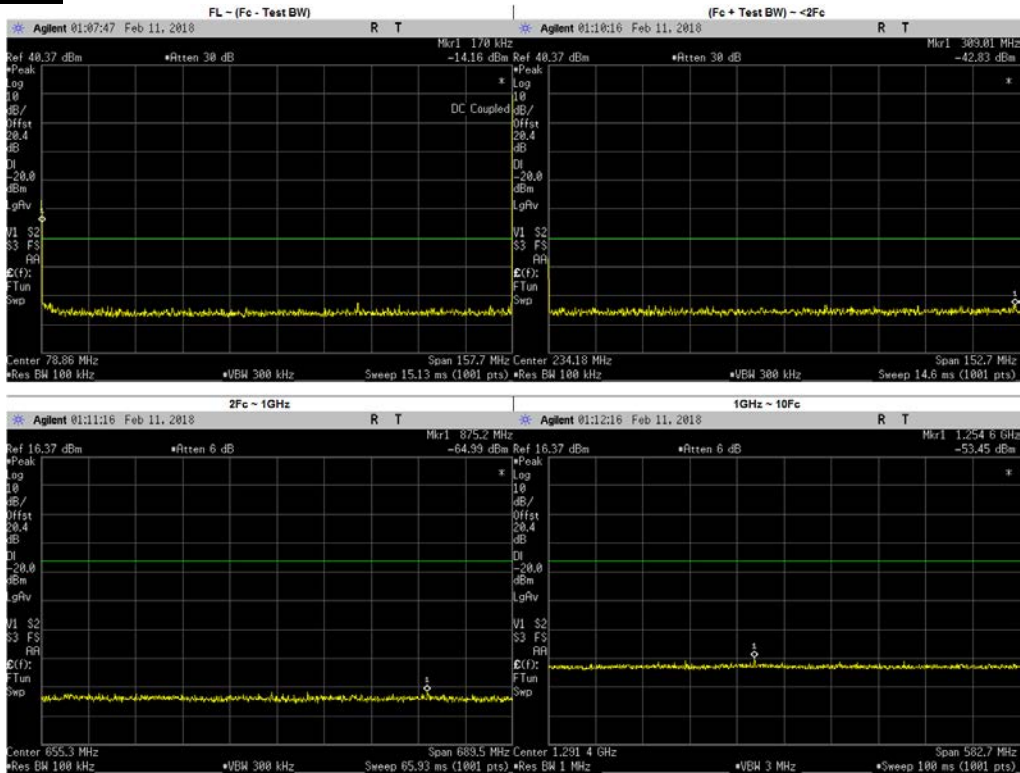

Frequency Range	Highest Spur Frequency (MHz)	Spurious Level (dBm)	Failing Limit (dBm)	Results
FL ~ (Fc - Test BW)	105.8293	-42.06	-20	PASS
(Fc + Test BW) ~ <2Fc	309.0129	-42.83	-20	PASS
2Fc ~ 1GHz	875.2077	-64.99	-20	PASS
	315.5400	-67.06	-20	PASS
	473.3100	-67.29	-20	PASS
	631.0800	-67.50	-20	PASS
	788.8500	-67.54	-20	PASS
	946.6200	-67.90	-20	PASS
1GHz ~ 10Fc	1254.6400	-53.45	-20	PASS
	1104.3900	-56.59	-20	PASS
	1262.1600	-56.56	-20	PASS
	1419.9300	-57.11	-20	PASS
	1577.7000	-56.88	-20	PASS

**Digital: 157.77 MHz, 12.5 kHz Channel Spacing, Low Power
 FCC Part 22**

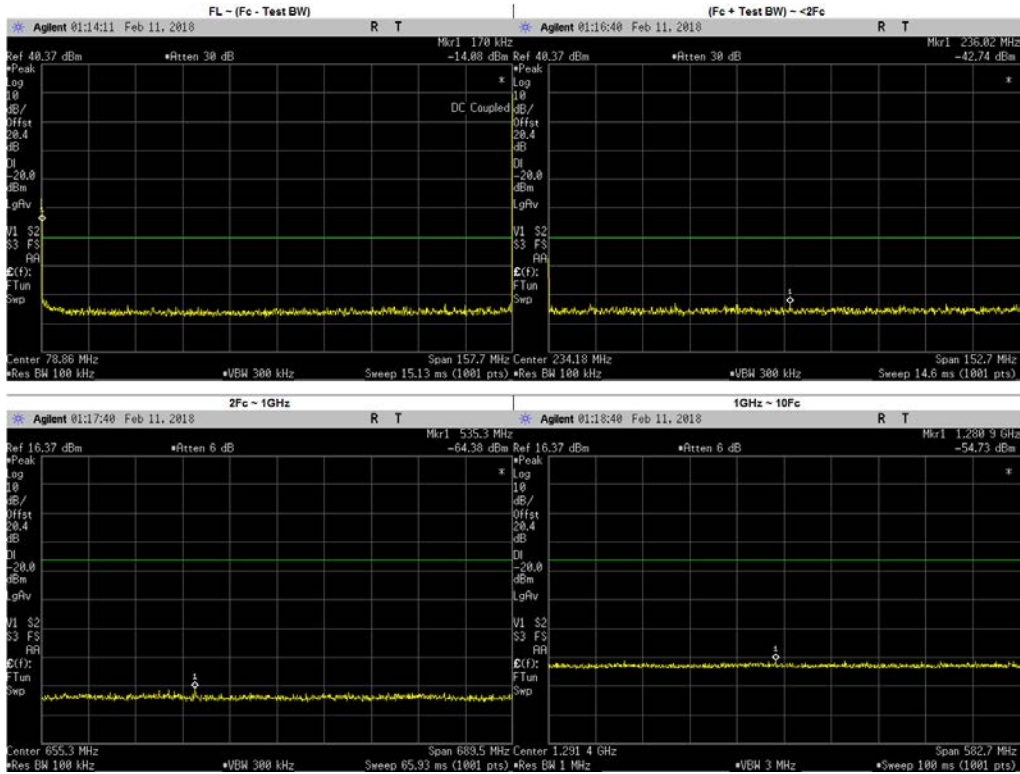

Frequency Range	Highest Spur Frequency (MHz)	Spurious Level (dBm)	Failing Limit (dBm)	Results
FL ~ (Fc - Test BW)	135.1625	-42.80	-20	PASS
(Fc + Test BW) ~ <2Fc	236.0154	-42.74	-20	PASS
2Fc ~ 1GHz	535.3040	-64.38	-20	PASS
	315.5400	-68.14	-20	PASS
	473.3100	-66.88	-20	PASS
	631.0800	-67.86	-20	PASS
	788.8500	-67.92	-20	PASS
1GHz ~ 10Fc	946.6200	-67.59	-20	PASS
	1280.8610	-54.73	-20	PASS
	1104.3900	-56.24	-20	PASS
	1262.1600	-55.64	-20	PASS
	1419.9300	-56.38	-20	PASS
	1577.7000	-56.09	-20	PASS

**Digital: 158.67 MHz, 12.5 kHz Channel Spacing, Max Power
 FCC Part 22**

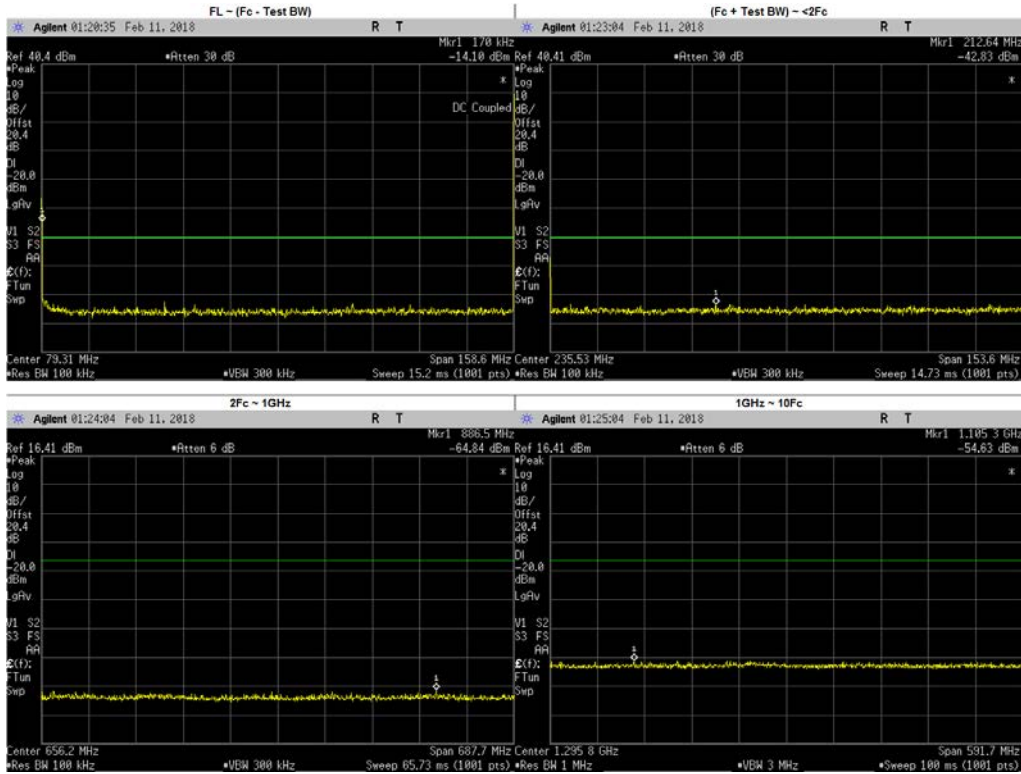

Frequency Range	Highest Spur Frequency (MHz)	Spurious Level (dBm)	Failing Limit (dBm)	Results
FL ~ (Fc - Test BW)	41.4050	-42.16	-20	PASS
(Fc + Test BW) ~ <2Fc	212.6443	-42.83	-20	PASS
2Fc ~ 1GHz	886.5361	-64.84	-20	PASS
	317.3400	-68.09	-20	PASS
	476.0100	-66.66	-20	PASS
	634.6800	-67.31	-20	PASS
	793.3500	-67.05	-20	PASS
	952.0200	-67.81	-20	PASS
1GHz ~ 10Fc	1105.3230	-54.63	-20	PASS
	1110.6900	-57.10	-20	PASS
	1269.3600	-56.24	-20	PASS
	1428.0300	-56.17	-20	PASS
	1586.7000	-56.45	-20	PASS

**Digital: 158.67 MHz, 12.5 kHz Channel Spacing, Low Power
 FCC Part 22**

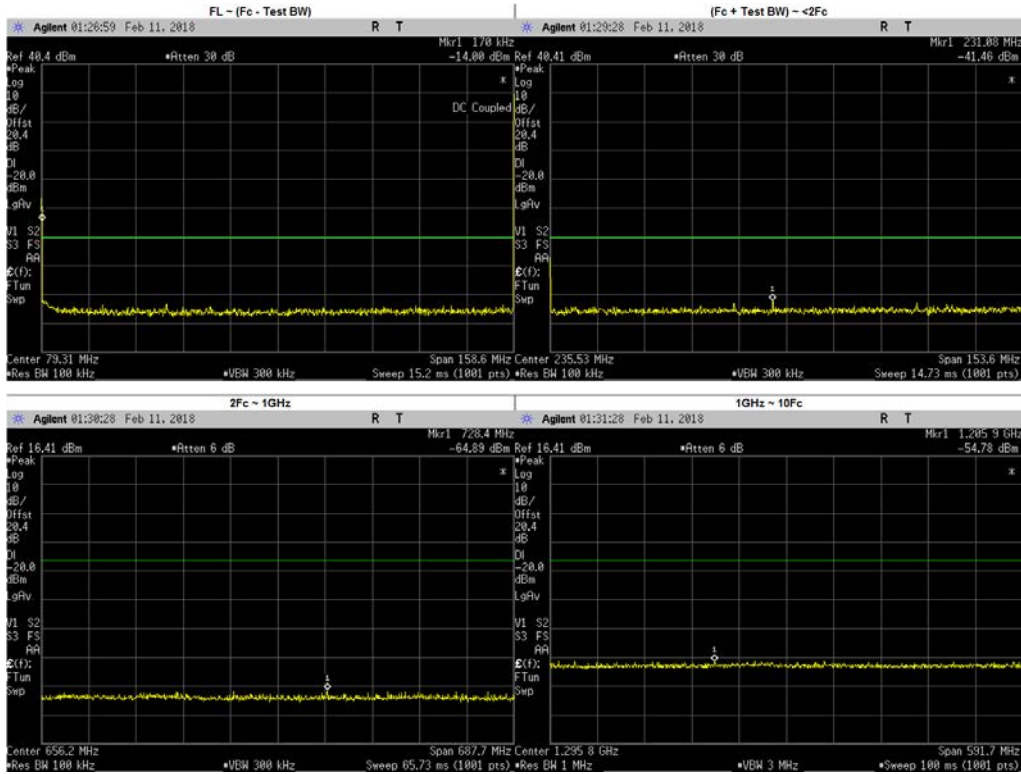

Frequency Range	Highest Spur Frequency (MHz)	Spurious Level (dBm)	Failing Limit (dBm)	Results
FL ~ (Fc - Test BW)	42.0394	-42.93	-20	PASS
(Fc + Test BW) ~ <2Fc	231.0780	-41.46	-20	PASS
2Fc ~ 1GHz	728.3743	-64.89	-20	PASS
	317.3400	-68.05	-20	PASS
	476.0100	-67.17	-20	PASS
	634.6800	-66.48	-20	PASS
	793.3500	-67.98	-20	PASS
	952.0200	-67.99	-20	PASS
1GHz ~ 10Fc	1205.9120	-54.78	-20	PASS
	1110.6900	-56.42	-20	PASS
	1269.3600	-56.38	-20	PASS
	1428.0300	-57.17	-20	PASS
	1586.7000	-55.87	-20	PASS

6.10.4. Test Limit

The power of any emission outside a licensee’s frequency block shall be attenuated below the transmitter power (P) by at least:

Channel Spacing	Part 22	Part 24D	Part 74	Part 80	Part 90 (UHF, VHF, 800, 900)	Part 90 (700)
12.5kHz	43 + log ₁₀ (P) (-13 dBm)	43 + log ₁₀ (P) (-13 dBm)	43 + log ₁₀ (P) (-13 dBm)	Not Applicable	50 + log ₁₀ (P) (-20 dBm)	43 + log ₁₀ (P) (-13 dBm)
25kHz		Not Applicable		43 + log ₁₀ (P) (-13 dBm)	43 + log ₁₀ (P) (-13 dBm)	43 + log ₁₀ (P) (-13 dBm)

6.11. Radiated Spurious Emission

6.11.1. Test Setup

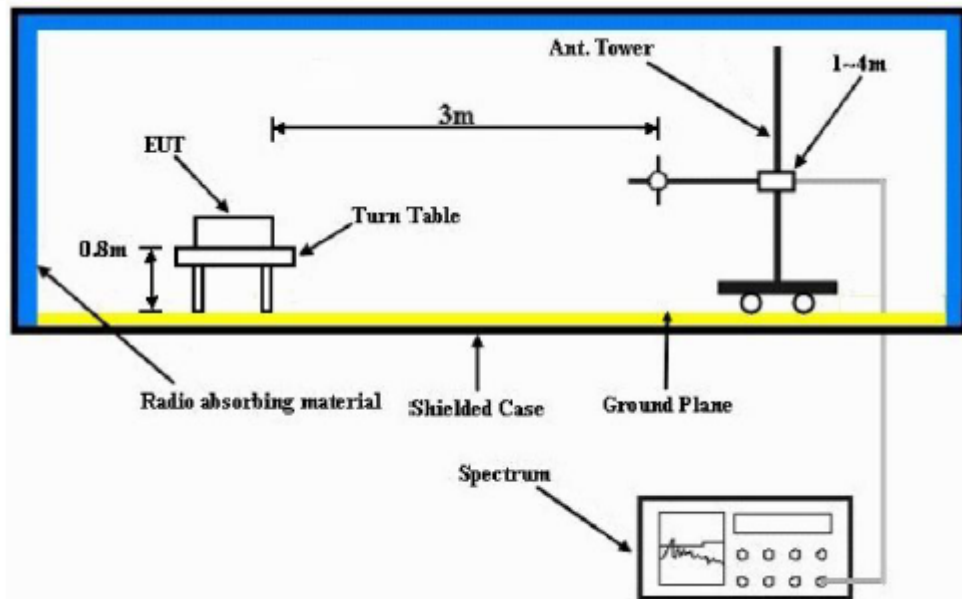

- 1) The Resolution Bandwidth for scanning Radiated Emission below 1 GHz is 100 kHz with Video Bandwidth = 300 kHz and Resolution Bandwidth for above 1 GHz is 1 MHz with Video Bandwidth = 3 MHz. Detector mode is positive peak.
- 2) In the semi- anechoic chamber, setup as illustrated above the DUT placed on the 0.8m height of Turn Table, rotated the table around 360 degrees to search the maximum radiation power and receiver antenna shall be rotated vertical and horizontal polarization and moved height from 1m to 4m to find the maximum polar radiated power. The “Read Value” is the spectrum reading the maximum power value.
- 3) The substitution antenna is substituted for DUT at the same position and signals generator (S.G) export the CW signal to the substitution antenna via a TX cable. The receiver antenna shall be rotated vertical and horizontal polarization and moved height from 1m to 4m to find the maximum radiation power. Record the power level of maximum radiation power from spectrum. So, the measured substitution value = Ref level of S.G + TX cables loss – Substituted Antenna Gain.
- 4) Final Radiated Spurious Emission = “Read Value” + Measured substitution value.

6.11.2. Test Result (Analog)

SAC Transmitter Radiated Emission:
Model Number: AAH56JDN9RA1AN **S/N: 871TUBN483** **SR:10463-EMC-00002**
Battery Part No: PMNN4493A **Accy Part No: NA**
Test Mode: TX Analog
138.012500 MHz **25 kHz** **6.000 Watt(s) /Max Power**

Frequency (MHz)	Limit	Horizontal Measured Emission Equiv Pwr Into Ideal Dipole (dBm)	Vertical Measured Emission Equiv Pwr Into ideal Dipole (dBm)
276.0250	-13.0000	-90.9454 **	-92.2914 **
414.0375	-13.0000	-88.2427 **	-89.3629 **
552.0500	-13.0000	-85.8670 **	-85.7624 **
690.0625	-13.0000	-85.9587 **	-85.1595 **
828.0750	-13.0000	-83.6032 **	-84.4283 **
966.0875	-13.0000	-82.0360 **	-82.5101 **
1104.1000	-13.0000	-62.8723 **	-62.9161 **
1242.1125	-13.0000	-61.8411 **	-62.4918 **
1380.1250	-13.0000	-61.4497 **	-61.6500 **

RADIATED SPURIOUS EMISSIONS

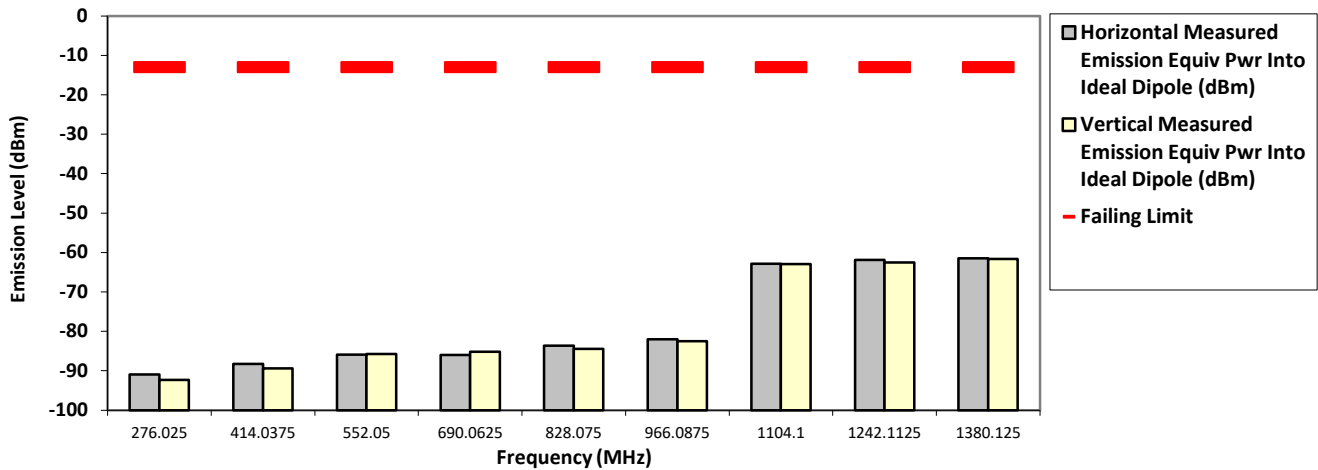

The data presented here was taken using the substitution method as found in the TIA/EIA-603E document.
 Motorola Penang EMC Lab - Test Performed by: Nazrin&Qawiman Mon, Feb 19, 2018
 Industry Canada: 109AK

Remarks: ** Indicates the spurious emission could not be detected due to noise limitations or ambient.

*Pursuant to CFR 47 Part 2.1057 (c), emissions attenuated more than 20 dB below the permissible limit are not reported
 Temp(Deg): 22.8 Hum(%RH): 64.3

System MU: 5.01 dB

Remarks:

Passed Results	Marginal Results	Failed Results
----------------	------------------	----------------

SAC Transmitter Radiated Emission:
Model Number: AAH56JDN9RA1AN **S/N: 871TUBN483** **SR:10463-EMC-00002**
Battery Part No: PMNN4493A **Test Mode: TX Analog** **Accy Part No: NA**
158.550000 MHz **25 kHz** **6.000 Watt(s) /Max Power**

Frequency (MHz)	Limit	Horizontal Measured Emission Equip Pwr Into Ideal Dipole (dBm)	Vertical Measured Emission Equip Pwr Into ideal Dipole (dBm)
317.1000	-13.0000	-89.8480 **	-89.5930 **
475.6500	-13.0000	-86.8104 **	-87.5061 **
634.2000	-13.0000	-85.5504 **	-85.1717 **
792.7500	-13.0000	-83.9956 **	-85.1143 **
951.3000	-13.0000	-82.6208 **	-83.4227 **
1109.8500	-13.0000	-62.0405 **	-62.0973 **
1268.4000	-13.0000	-60.0848 **	-60.1058 **
1426.9500	-13.0000	-61.6203 **	-61.9198 **
1585.5000	-13.0000	-59.8219 **	-60.8661 **

RADIATED SPURIOUS EMISSIONS

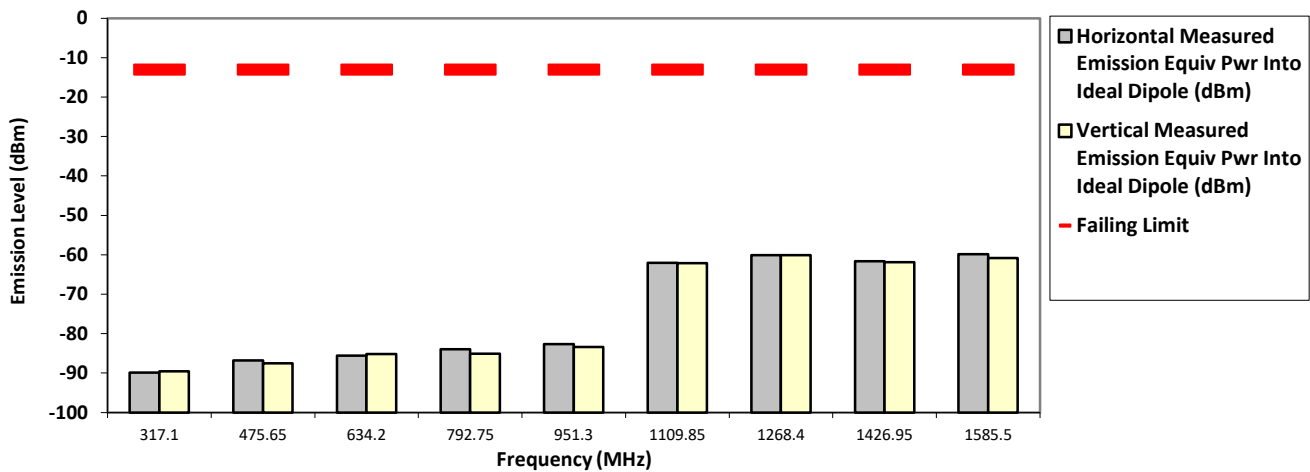

The data presented here was taken using the substitution method as found in the TIA/EIA-603E document.

Motorola Penang EMC Lab - Test Performed by: Nazrin&Qawiman

Mon, Feb 19, 2018

Industry Canada: 109AK

Remarks: ** Indicates the spurious emission could not be detected due to noise limitations or ambient.

*Pursuant to CFR 47 Part 2.1057 (c), emissions attenuated more than 20 dB below the permissible limit are not reported
 Temp(Deg): 22.8 Hum(%RH): 64.3

System MU: 5.01 dB

Remarks:

Passed Results	Marginal Results	Failed Results
----------------	------------------	----------------

SAC Transmitter Radiated Emission:
Model Number: AAH56JDN9RA1AN **S/N: 871TUBN483** **SR:10463-EMC-00002**
Battery Part No: PMNN4493A **Test Mode: TX Analog** **Accy Part No: NA**
158.550000 MHz **25 kHz** **1.000 Watt(s) /Low Power**

Frequency (MHz)	Limit	Horizontal Measured Emission Equip Pwr Into Ideal Dipole (dBm)	Vertical Measured Emission Equip Pwr Into ideal Dipole (dBm)
317.1000	-13.0000	-92.0056 **	-91.2712 **
475.6500	-13.0000	-87.8684 **	-87.5535 **
634.2000	-13.0000	-85.7609 **	-86.8005 **
792.7500	-13.0000	-85.0825 **	-82.4111 **
951.3000	-13.0000	-82.6257 **	-83.0811 **
1109.8500	-13.0000	-61.9697 **	-62.6848 **
1268.4000	-13.0000	-60.6192 **	-60.4225 **
1426.9500	-13.0000	-61.4230 **	-61.7899 **
1585.5000	-13.0000	-60.5420 **	-61.0878 **

RADIATED SPURIOUS EMISSIONS

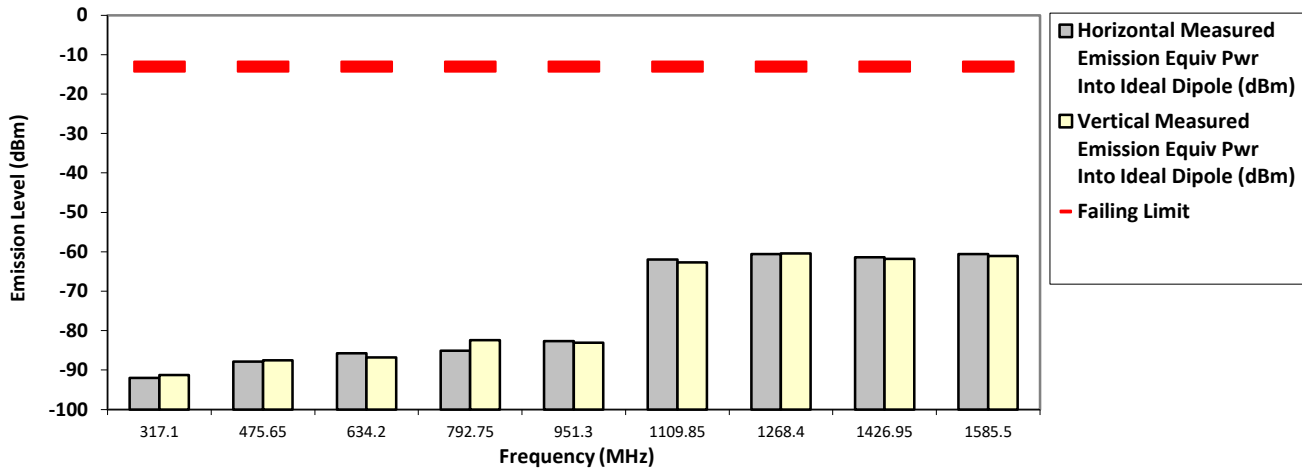

The data presented here was taken using the substitution method as found in the TIA/EIA-603E document.

Motorola Penang EMC Lab - Test Performed by: Nazrin&Qawiman

Mon, Feb 19, 2018

Industry Canada: 109AK

Remarks: ** Indicates the spurious emission could not be detected due to noise limitations or ambient.

*Pursuant to CFR 47 Part 2.1057 (c), emissions attenuated more than 20 dB below the permissible limit are not reported

Temp(Deg): 22.8 Hum(%RH): 64.3

System MU: 5.01 dB

Remarks:

Passed Results	Marginal Results	Failed Results
----------------	------------------	----------------

SAC Transmitter Radiated Emission:
Model Number: AAH56JDN9RA1AN **S/N: 871TUBN483** **SR:10463-EMC-00002**
Battery Part No: PMNN4493A **Test Mode: TX Analog** **Accy Part No: NA**
161.700000 MHz **25 kHz** **6.000 Watt(s) /Max Power**

Frequency (MHz)	Limit	Horizontal Measured Emission Equiv Pwr Into Ideal Dipole (dBm)	Vertical Measured Emission Equiv Pwr Into ideal Dipole (dBm)
323.4000	-13.0000	-91.9471 **	-91.5536 **
485.1000	-13.0000	-87.0088 **	-87.0735 **
646.8000	-13.0000	-86.0825 **	-85.9096 **
808.5000	-13.0000	-85.3486 **	-83.8154 **
970.2000	-13.0000	-81.0255 **	-81.9574 **
1131.9000	-13.0000	-62.4694 **	-62.1357 **
1293.6000	-13.0000	-61.9011 **	-61.9549 **
1455.3000	-13.0000	-61.6910 **	-61.2899 **
1617.0000	-13.0000	-61.0694 **	-60.6533 **

RADIATED SPURIOUS EMISSIONS

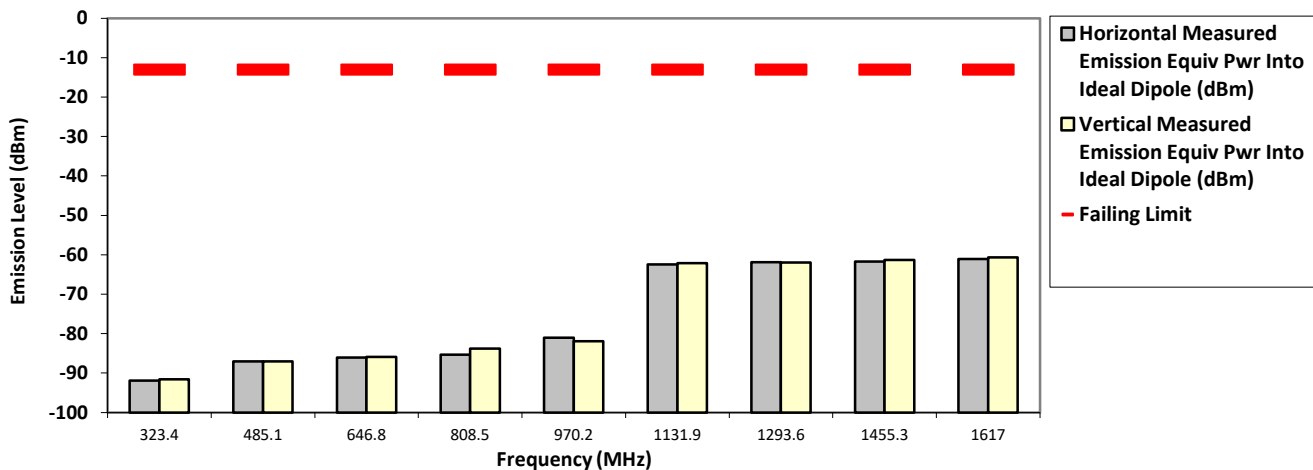

The data presented here was taken using the substitution method as found in the TIA/EIA-603E document.

Motorola Penang EMC Lab - Test Performed by: Nazrin&Qawiman

Mon, Feb 19, 2018

Industry Canada: 109AK

Remarks: ** Indicates the spurious emission could not be detected due to noise limitations or ambient.

*Pursuant to CFR 47 Part 2.1057 (c), emissions attenuated more than 20 dB below the permissible limit are not reported

Temp(Deg): 22.8 Hum(%RH): 64.3

System MU: 5.01 dB

Remarks:

Passed Results	Marginal Results	Failed Results
----------------	------------------	----------------

SAC Transmitter Radiated Emission:
Model Number: AAH56JDN9RA1AN **S/N: 871TUBN483** **SR:10463-EMC-00002**
Battery Part No: PMNN4493A **Test Mode: TX Analog** **Accy Part No: NA**
161.700000 MHz **25 kHz** **1.000 Watt(s) /Low Power**

Frequency (MHz)	Limit	Horizontal Measured Emission Equip Pwr Into Ideal Dipole (dBm)	Vertical Measured Emission Equip Pwr Into ideal Dipole (dBm)
323.4000	-13.0000	-90.3268 **	-91.5360 **
485.1000	-13.0000	-87.7035 **	-87.9995 **
646.8000	-13.0000	-85.3775 **	-86.5430 **
808.5000	-13.0000	-84.4009 **	-85.1080 **
970.2000	-13.0000	-82.3001 **	-83.7435 **
1131.9000	-13.0000	-62.5308 **	-61.2250 **
1293.6000	-13.0000	-60.8512 **	-60.9909 **
1455.3000	-13.0000	-61.8411 **	-62.0719 **
1617.0000	-13.0000	-61.6072 **	-60.5810 **

RADIATED SPURIOUS EMISSIONS

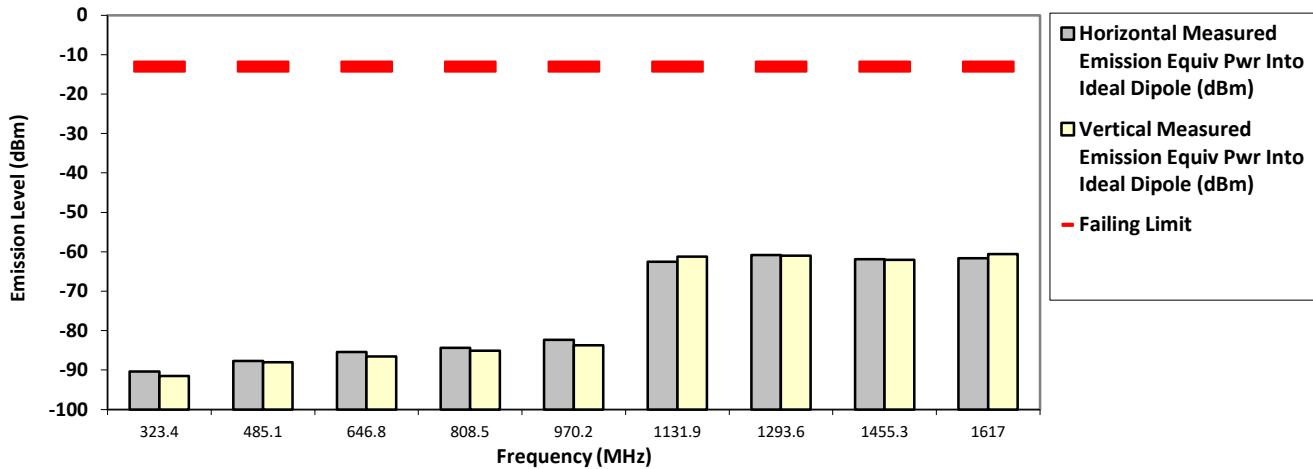

The data presented here was taken using the substitution method as found in the TIA/EIA-603E document.

Motorola Penang EMC Lab - Test Performed by: Nazrin&Qawiman

Mon, Feb 19, 2018

Industry Canada: 109AK

Remarks: ** Indicates the spurious emission could not be detected due to noise limitations or ambient.

*Pursuant to CFR 47 Part 2.1057 (c), emissions attenuated more than 20 dB below the permissible limit are not reported

Temp(Deg): 22.8 Hum(%RH): 64.3

System MU: 5.01 dB

Remarks:

Passed Results	Marginal Results	Failed Results
----------------	------------------	----------------

SAC Transmitter Radiated Emission:
Model Number: AAH56JDN9RA1AN **S/N: 871TUBN483** **SR:10463-EMC-00002**
Battery Part No: PMNN4493A **Test Mode: TX Analog** **Accy Part No: NA**
173.387500 MHz **25 kHz** **6.000 Watt(s) /Max Power**

Frequency (MHz)	Limit	Horizontal Measured Emission Equip Pwr Into Ideal Dipole (dBm)	Vertical Measured Emission Equip Pwr Into ideal Dipole (dBm)
346.7750	-13.0000	-90.8614 **	-90.1725 **
520.1625	-13.0000	-88.1285 **	-88.0721 **
693.5500	-13.0000	-86.8601 **	-86.6290 **
866.9375	-13.0000	-83.8969 **	-84.3210 **
1040.3250	-13.0000	-61.8406 **	-62.8529 **
1213.7125	-13.0000	-61.7903 **	-61.6559 **
1387.1000	-13.0000	-61.2735 **	-61.1101 **
1560.4875	-13.0000	-61.7151 **	-60.9013 **
1733.8750	-13.0000	-59.4116 **	-60.3001 **

RADIATED SPURIOUS EMISSIONS

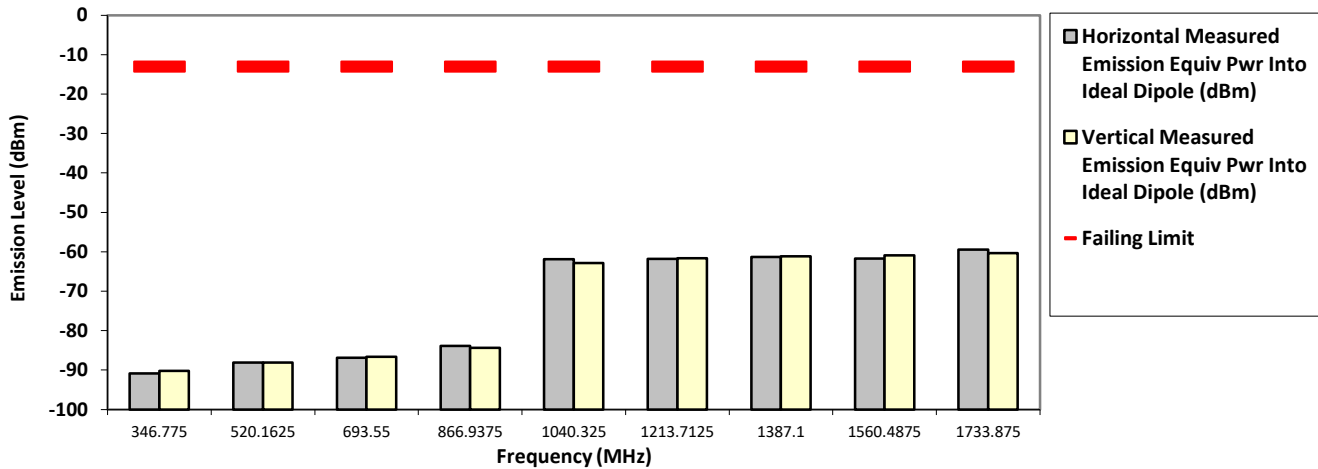

The data presented here was taken using the substitution method as found in the TIA/EIA-603E document.

Motorola Penang EMC Lab - Test Performed by: Nazrin&Qawiman

Mon, Feb 19, 2018

Industry Canada: 109AK

Remarks: ** Indicates the spurious emission could not be detected due to noise limitations or ambient.

*Pursuant to CFR 47 Part 2.1057 (c), emissions attenuated more than 20 dB below the permissible limit are not reported

Temp(Deg): 22.8 Hum(%RH): 64.3

System MU: 5.01 dB

Remarks:

Passed Results	Marginal Results	Failed Results
----------------	------------------	----------------

SAC Transmitter Radiated Emission:
Model Number: AAH56JDN9RA1AN **S/N: 871TUBN483** **SR:10463-EMC-00002**
Battery Part No: PMNN4493A **Test Mode: TX Analog** **Accy Part No: NA**
138.012500 MHz **25 kHz** **6.000 Watt(s) /Max Power**

Frequency (MHz)	Limit	Horizontal Measured Emission Equip Pwr Into Ideal Dipole (dBm)	Vertical Measured Emission Equip Pwr Into ideal Dipole (dBm)
276.0250	-13.0000	-90.9454 **	-92.2914 **
414.0375	-13.0000	-88.2427 **	-89.3629 **
552.0500	-13.0000	-85.8670 **	-85.7624 **
690.0625	-13.0000	-85.9587 **	-85.1595 **
828.0750	-13.0000	-83.6032 **	-84.4283 **
966.0875	-13.0000	-82.0360 **	-82.5101 **
1104.1000	-13.0000	-62.8723 **	-62.9161 **
1242.1125	-13.0000	-61.8411 **	-62.4918 **
1380.1250	-13.0000	-61.4497 **	-61.6500 **

RADIATED SPURIOUS EMISSIONS

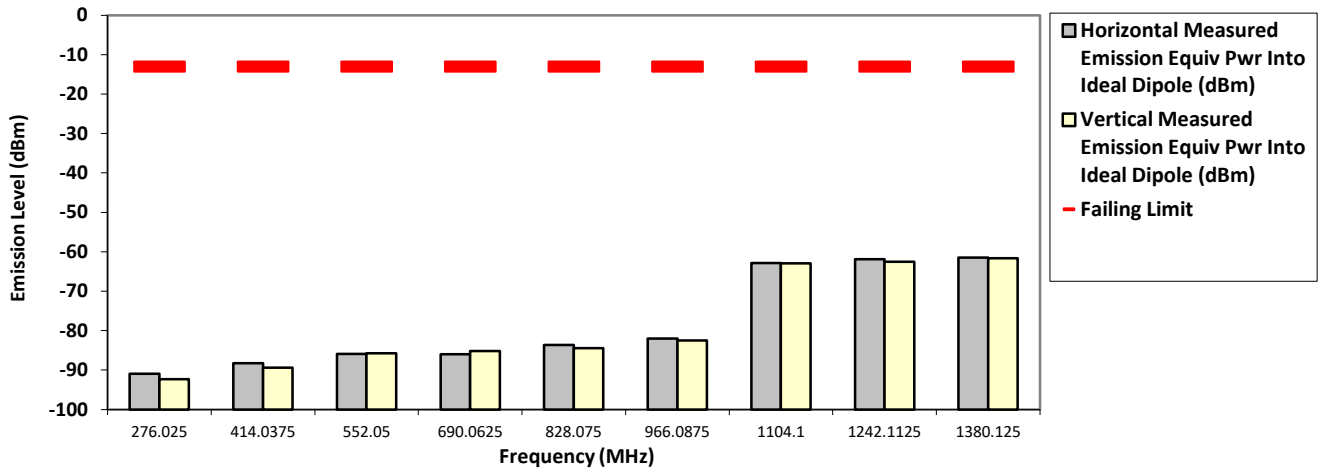

The data presented here was taken using the substitution method as found in the ANSI C63.26 document.

Motorola Penang EMC Lab - Test Performed by: Nazrin&Qawiman
 Industry Canada: 109AK

Mon, Feb 19, 2018

Remarks: ** Indicates the spurious emission could not be detected due to noise limitations or ambient.

*Pursuant to CFR 47 Part 2.1057 (c), emissions attenuated more than 20 dB below the permissible limit are not reported
 Temp(Deg): 22.8 Hum(%RH): 64.3

System MU: 5.01 dB

Remarks:

Passed Results	Marginal Results	Failed Results
----------------	------------------	----------------

SAC Transmitter Radiated Emission:
Model Number: AAH56JDN9RA1AN **S/N: 871TUBN483** **SR:10463-EMC-00002**
Battery Part No: PMNN4493A **Test Mode: TX Analog** **Accy Part No: NA**
158.550000 MHz **25 kHz** **6.000 Watt(s) /Max Power**

Frequency (MHz)	Limit	Horizontal Measured Emission Equip Pwr Into Ideal Dipole (dBm)	Vertical Measured Emission Equip Pwr Into ideal Dipole (dBm)
317.1000	-13.0000	-89.8480 **	-89.5930 **
475.6500	-13.0000	-86.8104 **	-87.5061 **
634.2000	-13.0000	-85.5504 **	-85.1717 **
792.7500	-13.0000	-83.9956 **	-85.1143 **
951.3000	-13.0000	-82.6208 **	-83.4227 **
1109.8500	-13.0000	-62.0405 **	-62.0973 **
1268.4000	-13.0000	-60.0848 **	-60.1058 **
1426.9500	-13.0000	-61.6203 **	-61.9198 **
1585.5000	-13.0000	-59.8219 **	-60.8661 **

RADIATED SPURIOUS EMISSIONS

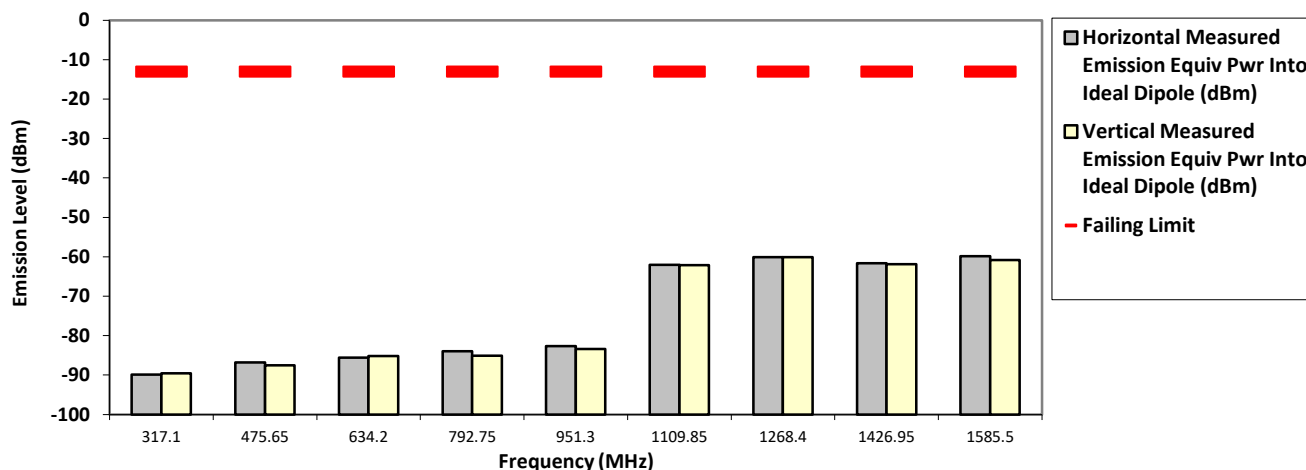

The data presented here was taken using the substitution method as found in the ANSI C63.26 document.

Motorola Penang EMC Lab - Test Performed by: Nazrin&Qawiman

Mon, Feb 19, 2018

Industry Canada: 109AK

Remarks: ** Indicates the spurious emission could not be detected due to noise limitations or ambient.

*Pursuant to CFR 47 Part 2.1057 (c), emissions attenuated more than 20 dB below the permissible limit are not reported
 Temp(Deg): 22.8 Hum(%RH): 64.3

System MU: 5.01 dB

Remarks:

Passed Results	Marginal Results	Failed Results
----------------	------------------	----------------

SAC Transmitter Radiated Emission:
Model Number: AAH56JDN9RA1AN **S/N: 871TUBN483** **SR:10463-EMC-00002**
Battery Part No: PMNN4493A **Test Mode: TX Analog** **Accy Part No: NA**
158.550000 MHz **25 kHz** **1.000 Watt(s) /Low Power**

Frequency (MHz)	Limit	Horizontal Measured Emission Equip Pwr Into Ideal Dipole (dBm)	Vertical Measured Emission Equip Pwr Into ideal Dipole (dBm)
317.1000	-13.0000	-92.0056 **	-91.2712 **
475.6500	-13.0000	-87.8684 **	-87.5535 **
634.2000	-13.0000	-85.7609 **	-86.8005 **
792.7500	-13.0000	-85.0825 **	-82.4111 **
951.3000	-13.0000	-82.6257 **	-83.0811 **
1109.8500	-13.0000	-61.9697 **	-62.6848 **
1268.4000	-13.0000	-60.6192 **	-60.4225 **
1426.9500	-13.0000	-61.4230 **	-61.7899 **
1585.5000	-13.0000	-60.5420 **	-61.0878 **

RADIATED SPURIOUS EMISSIONS

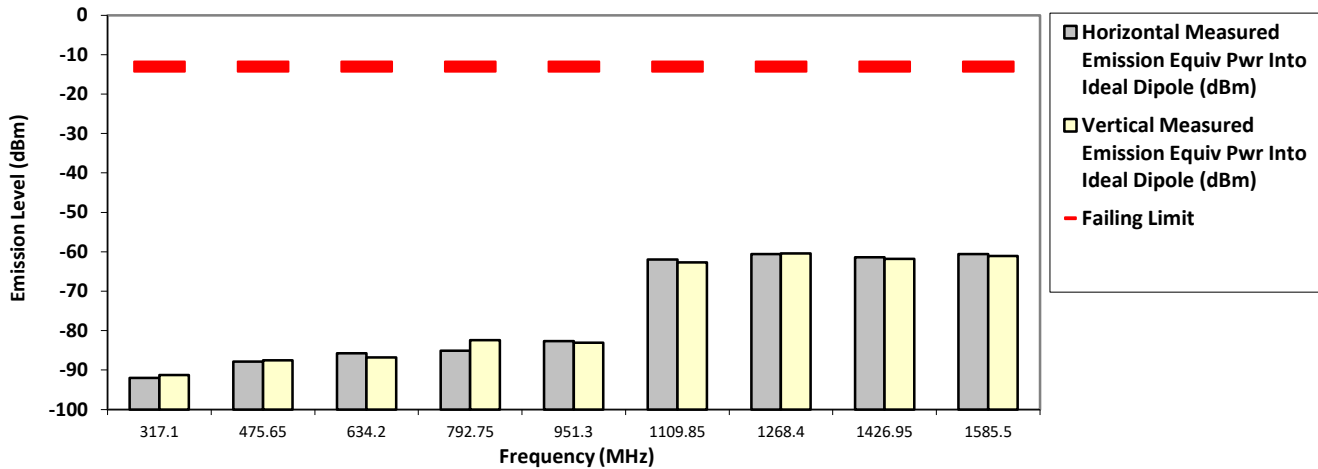

The data presented here was taken using the substitution method as found in the ANSI C63.26 document.

Motorola Penang EMC Lab - Test Performed by: Nazrin&Qawiman
 Industry Canada: 109AK

Mon, Feb 19, 2018

Remarks: ** Indicates the spurious emission could not be detected due to noise limitations or ambient.

*Pursuant to CFR 47 Part 2.1057 (c), emissions attenuated more than 20 dB below the permissible limit are not reported
 Temp(Deg): 22.8 Hum(%RH): 64.3

System MU: 5.01 dB

Remarks:

Passed Results	Marginal Results	Failed Results
----------------	------------------	----------------

SAC Transmitter Radiated Emission:
Model Number: AAH56JDN9RA1AN **S/N: 871TUBN483** **SR:10463-EMC-00002**
Battery Part No: PMNN4493A **Test Mode: TX Analog** **Accy Part No: NA**
173.387500 MHz **25 kHz** **6.000 Watt(s) /Max Power**

Frequency (MHz)	Limit	Horizontal Measured Emission Equip Pwr Into Ideal Dipole (dBm)	Vertical Measured Emission Equip Pwr Into ideal Dipole (dBm)
346.7750	-13.0000	-90.8614 **	-90.1725 **
520.1625	-13.0000	-88.1285 **	-88.0721 **
693.5500	-13.0000	-86.8601 **	-86.6290 **
866.9375	-13.0000	-83.8969 **	-84.3210 **
1040.3250	-13.0000	-61.8406 **	-62.8529 **
1213.7125	-13.0000	-61.7903 **	-61.6559 **
1387.1000	-13.0000	-61.2735 **	-61.1101 **
1560.4875	-13.0000	-61.7151 **	-60.9013 **
1733.8750	-13.0000	-59.4116 **	-60.3001 **

RADIATED SPURIOUS EMISSIONS

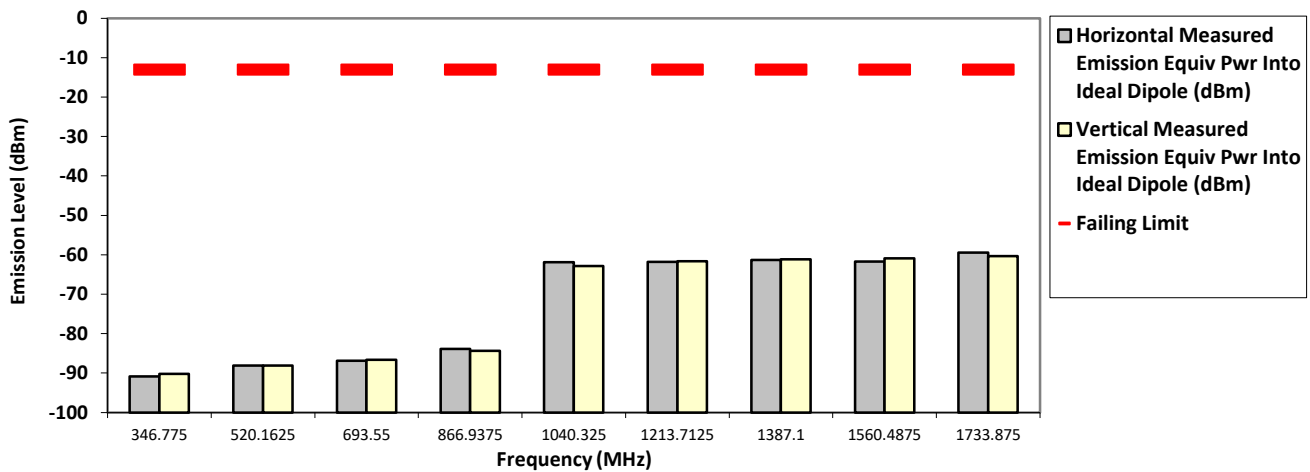

The data presented here was taken using the substitution method as found in the ANSI C63.26 document.

Motorola Penang EMC Lab - Test Performed by: Nazrin&Qawiman

Mon, Feb 19, 2018

Industry Canada: 109AK

Remarks: ** Indicates the spurious emission could not be detected due to noise limitations or ambient.

*Pursuant to CFR 47 Part 2.1057 (c), emissions attenuated more than 20 dB below the permissible limit are not reported
 Temp(Deg): 22.8 Hum(%RH): 64.3

System MU: 5.01 dB

Remarks:

Passed Results	Marginal Results	Failed Results
----------------	------------------	----------------

6.11.3. Test Result (Digital)

SAC Transmitter Radiated Emission:

Model Number: AAH56JDN9RA1AN

S/N: 871TUBN483

SR:10463-EMC-00002

Battery Part No: PMNN4493A

Accy Part No: NA

Test Mode: TX Digital

138.012500 MHz

12.5 kHz

6.000 Watt(s) /Max Power

Frequency (MHz)	Limit	Horizontal Measured Emission Equiv Pwr Into Ideal Dipole (dBm)	Vertical Measured Emission Equiv Pwr Into ideal Dipole (dBm)
276.0250	-20.0000	-91.3103 **	-91.1043 **
414.0375	-20.0000	-89.2643 **	-88.3669 **
552.0500	-20.0000	-85.5746 **	-86.2844 **
690.0625	-20.0000	-85.5100 **	-85.1346 **
828.0750	-20.0000	-84.9002 **	-84.3721 **
966.0875	-20.0000	-82.2295 **	-81.4528 **
1104.1000	-20.0000	-62.3465 **	-62.5216 **
1242.1125	-20.0000	-62.4920 **	-62.2733 **
1380.1250	-20.0000	-61.1395 **	-60.7567 **

RADIATED SPURIOUS EMISSIONS

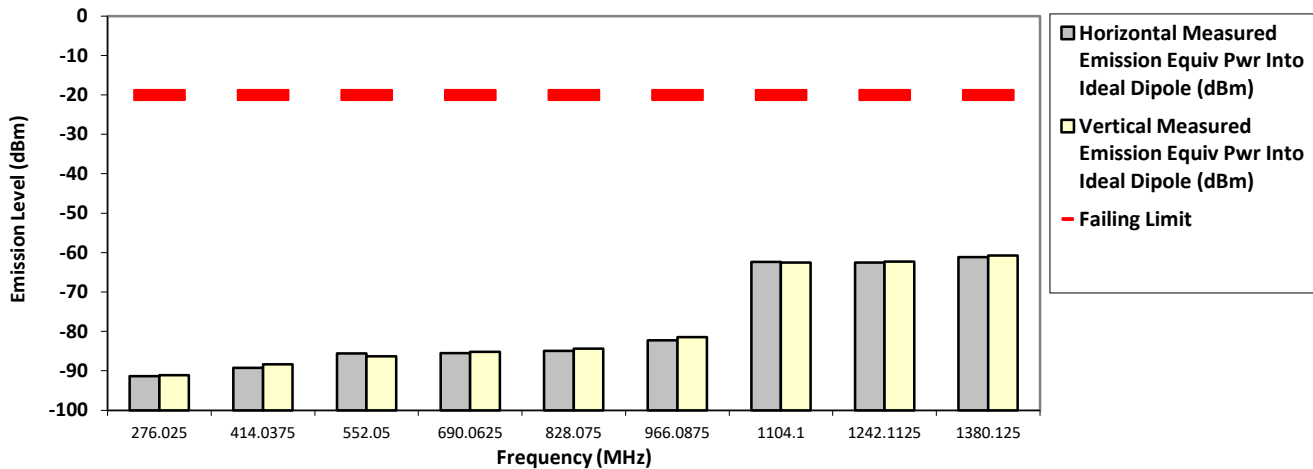

The data presented here was taken using the substitution method as found in the TIA/EIA-603E document.

Motorola Penang EMC Lab - Test Performed by: Nazrin&Qawiman

Tue, Feb 20, 2018

Industry Canada: 109AK

Remarks: ** Indicates the spurious emission could not be detected due to noise limitations or ambient.

*Pursuant to CFR 47 Part 2.1057 (c), emissions attenuated more than 20 dB below the permissible limit are not reported
 Temp(Deg): 22.8 Hum(%RH): 64.3

System MU: 5.01 dB

Remarks:	Passed Results	Marginal Results	Failed Results
----------	----------------	------------------	----------------

SAC Transmitter Radiated Emission:
Model Number: AAH56JDN9RA1AN **S/N: 871TUBN483** **SR:10463-EMC-00002**
Battery Part No: PMNN4493A **Test Mode: TX Digital** **Accy Part No: NA**
158.550000 MHz **12.5 kHz** **6.000 Watt(s) /Max Power**

Frequency (MHz)	Limit	Horizontal Measured Emission Equip Pwr Into Ideal Dipole (dBm)	Vertical Measured Emission Equip Pwr Into ideal Dipole (dBm)
317.1000	-20.0000	-91.9873 **	-91.3389 **
475.6500	-20.0000	-86.7266 **	-87.6887 **
634.2000	-20.0000	-84.9869 **	-86.3100 **
792.7500	-20.0000	-85.1143 **	-84.3354 **
951.3000	-20.0000	-82.7820 **	-81.7733 **
1109.8500	-20.0000	-62.4959 **	-62.9377 **
1268.4000	-20.0000	-61.6893 **	-61.6752 **
1426.9500	-20.0000	-60.8231 **	-60.4719 **
1585.5000	-20.0000	-59.0786 **	-61.0761 **

RADIATED SPURIOUS EMISSIONS

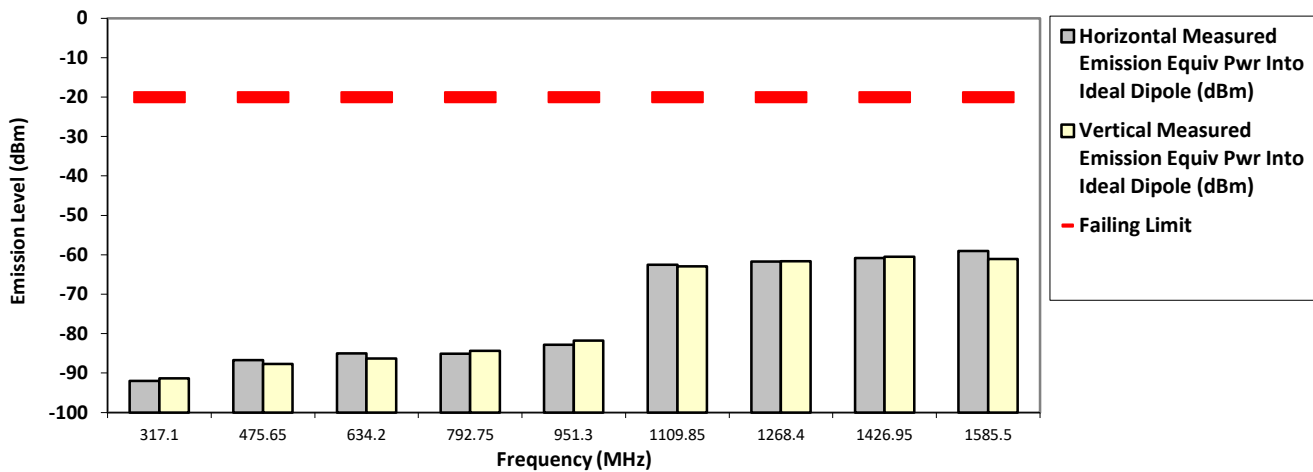

The data presented here was taken using the substitution method as found in the TIA/EIA-603E document.

Motorola Penang EMC Lab - Test Performed by: Nazrin&Qawiman

Tue, Feb 20, 2018

Industry Canada: 109AK

Remarks: ** Indicates the spurious emission could not be detected due to noise limitations or ambient.

*Pursuant to CFR 47 Part 2.1057 (c), emissions attenuated more than 20 dB below the permissible limit are not reported

Temp(Deg): 22.8 Hum(%RH): 64.3

System MU: 5.01 dB

Remarks:

Passed Results	Marginal Results	Failed Results
----------------	------------------	----------------

SAC Transmitter Radiated Emission:
Model Number: AAH56JDN9RA1AN **S/N: 871TUBN483** **SR:10463-EMC-00002**
Battery Part No: PMNN4493A **Test Mode: TX Digital** **Accy Part No: NA**
158.550000 MHz **12.5 kHz** **1.000 Watt(s) /Low Power**

Frequency (MHz)	Limit	Horizontal Measured Emission Equiv Pwr Into Ideal Dipole (dBm)	Vertical Measured Emission Equiv Pwr Into ideal Dipole (dBm)
317.1000	-20.0000	-91.3849 **	-90.1492 **
475.6500	-20.0000	-88.1654 **	-87.1069 **
634.2000	-20.0000	-84.5650 **	-85.3039 **
792.7500	-20.0000	-84.5502 **	-84.7824 **
951.3000	-20.0000	-82.9763 **	-82.5358 **
1109.8500	-20.0000	-60.6303 **	-62.3837 **
1268.4000	-20.0000	-61.3420 **	-61.5715 **
1426.9500	-20.0000	-61.8422 **	-62.2188 **
1585.5000	-20.0000	-61.6220 **	-60.3185 **

RADIATED SPURIOUS EMISSIONS

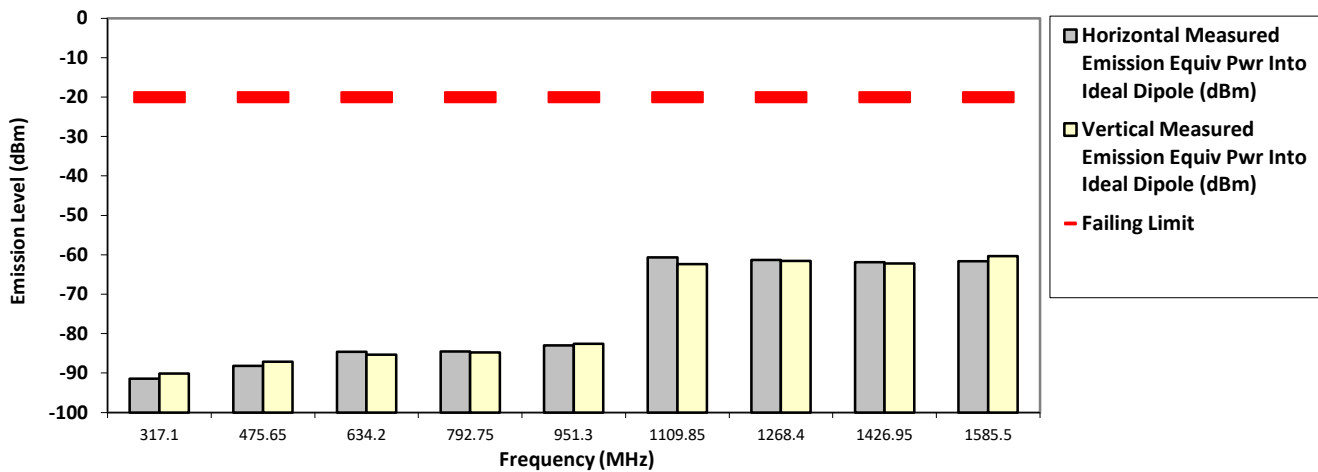

The data presented here was taken using the substitution method as found in the TIA/EIA-603E document.

Motorola Penang EMC Lab - Test Performed by: Nazrin&Qawiman

Tue, Feb 20, 2018

Industry Canada: 109AK

Remarks: ** Indicates the spurious emission could not be detected due to noise limitations or ambient.

*Pursuant to CFR 47 Part 2.1057 (c), emissions attenuated more than 20 dB below the permissible limit are not reported

Temp(Deg): 22.8 Hum(%RH): 64.3

System MU: 5.01 dB

Remarks:	Passed Results	Marginal Results	Failed Results
----------	----------------	------------------	----------------

SAC Transmitter Radiated Emission:
Model Number: AAH56JDN9RA1AN **S/N: 871TUBN483** **SR:10463-EMC-00002**
Battery Part No: PMNN4493A **Test Mode: TX Digital** **Accy Part No: NA**
161.700000 MHz **12.5 kHz** **6.000 Watt(s) /Max Power**

Frequency (MHz)	Limit	Horizontal Measured Emission Equip Pwr Into Ideal Dipole (dBm)	Vertical Measured Emission Equip Pwr Into ideal Dipole (dBm)
323.4000	-20.0000	-90.0343 **	-90.0506 **
485.1000	-20.0000	-85.9414 **	-88.0929 **
646.8000	-20.0000	-85.1547 **	-85.7484 **
808.5000	-20.0000	-84.6057 **	-84.9361 **
970.2000	-20.0000	-81.4059 **	-81.2249 **
1131.9000	-20.0000	-61.9049 **	-61.8879 **
1293.6000	-20.0000	-59.6752 **	-59.4405 **
1455.3000	-20.0000	-61.3001 **	-60.9972 **
1617.0000	-20.0000	-61.1855 **	-60.5104 **

RADIATED SPURIOUS EMISSIONS

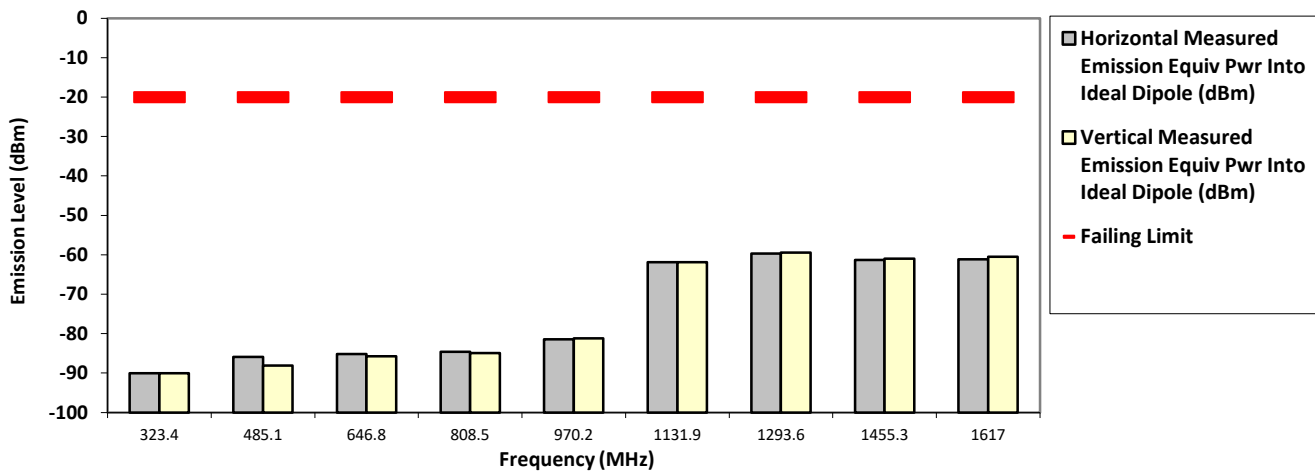

The data presented here was taken using the substitution method as found in the TIA/EIA-603E document.

Motorola Penang EMC Lab - Test Performed by: Nazrin&Qawiman

Tue, Feb 20, 2018

Industry Canada: 109AK

Remarks: ** Indicates the spurious emission could not be detected due to noise limitations or ambient.

*Pursuant to CFR 47 Part 2.1057 (c), emissions attenuated more than 20 dB below the permissible limit are not reported

Temp(Deg): 22.8 Hum(%RH): 64.3

System MU: 5.01 dB

Remarks:	Passed Results	Marginal Results	Failed Results
----------	----------------	------------------	----------------

SAC Transmitter Radiated Emission:
Model Number: AAH56JDN9RA1AN **S/N: 871TUBN483** **SR:10463-EMC-00002**
Battery Part No: PMNN4493A **Test Mode: TX Digital** **Accy Part No: NA**
161.700000 MHz **12.5 kHz** **1.000 Watt(s) /Low Power**

Frequency (MHz)	Limit	Horizontal Measured Emission Equip Pwr Into Ideal Dipole (dBm)	Vertical Measured Emission Equip Pwr Into ideal Dipole (dBm)
323.4000	-20.0000	-90.6437 **	-89.8389 **
485.1000	-20.0000	-87.4544 **	-88.4805 **
646.8000	-20.0000	-86.4657 **	-84.4120 **
808.5000	-20.0000	-84.7779 **	-84.8240 **
970.2000	-20.0000	-83.2453 **	-82.4726 **
1131.9000	-20.0000	-63.0914 **	-62.1829 **
1293.6000	-20.0000	-60.8741 **	-61.5009 **
1455.3000	-20.0000	-61.5170 **	-61.2855 **
1617.0000	-20.0000	-61.1245 **	-61.1934 **

RADIATED SPURIOUS EMISSIONS

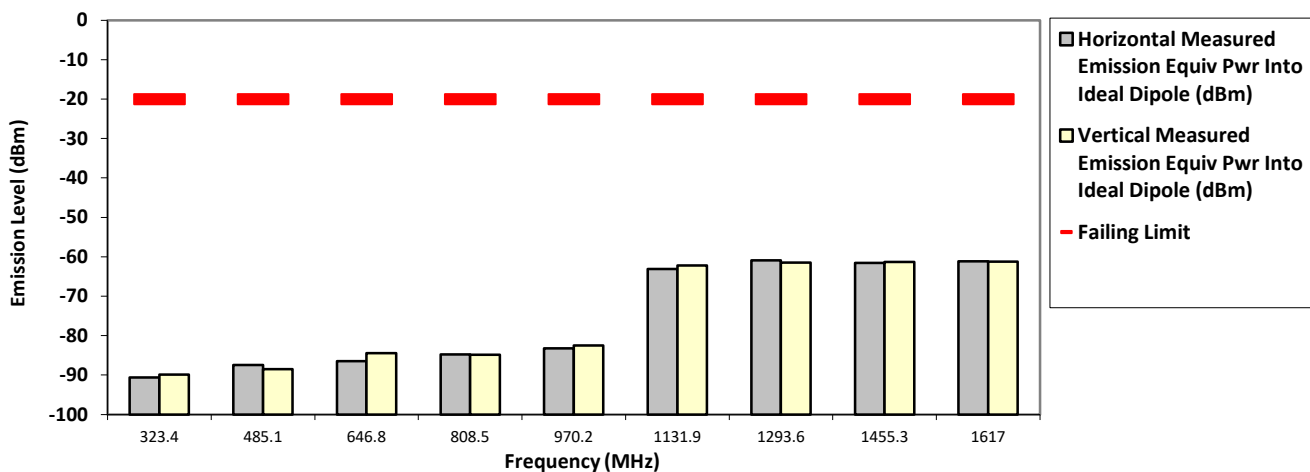

The data presented here was taken using the substitution method as found in the TIA/EIA-603E document.

Motorola Penang EMC Lab - Test Performed by: Nazrin&Qawiman

Tue, Feb 20, 2018

Industry Canada: 109AK

Remarks: ** Indicates the spurious emission could not be detected due to noise limitations or ambient.

*Pursuant to CFR 47 Part 2.1057 (c), emissions attenuated more than 20 dB below the permissible limit are not reported
 Temp(Deg): 22.8 Hum(%RH): 64.3

System MU: 5.01 dB

Remarks:

Passed Results	Marginal Results	Failed Results
----------------	------------------	----------------

SAC Transmitter Radiated Emission:
Model Number: AAH56JDN9RA1AN **S/N: 871TUBN483** **SR:10463-EMC-00002**
Battery Part No: PMNN4493A **Test Mode: TX Digital** **Accy Part No: NA**
173.387500 MHz **12.5 kHz** **6.000 Watt(s) /Max Power**

Frequency (MHz)	Limit	Horizontal Measured Emission Equip Pwr Into Ideal Dipole (dBm)	Vertical Measured Emission Equip Pwr Into ideal Dipole (dBm)
346.7750	-20.0000	-89.7545 **	-91.1434 **
520.1625	-20.0000	-86.8054 **	-87.3259 **
693.5500	-20.0000	-86.0976 **	-85.1745 **
866.9375	-20.0000	-83.5707 **	-84.1175 **
1040.3250	-20.0000	-62.9487 **	-62.1973 **
1213.7125	-20.0000	-62.3417 **	-62.3859 **
1387.1000	-20.0000	-61.7009 **	-61.4505 **
1560.4875	-20.0000	-60.8441 **	-60.8791 **
1733.8750	-20.0000	-60.5049 **	-60.8633 **

RADIATED SPURIOUS EMISSIONS

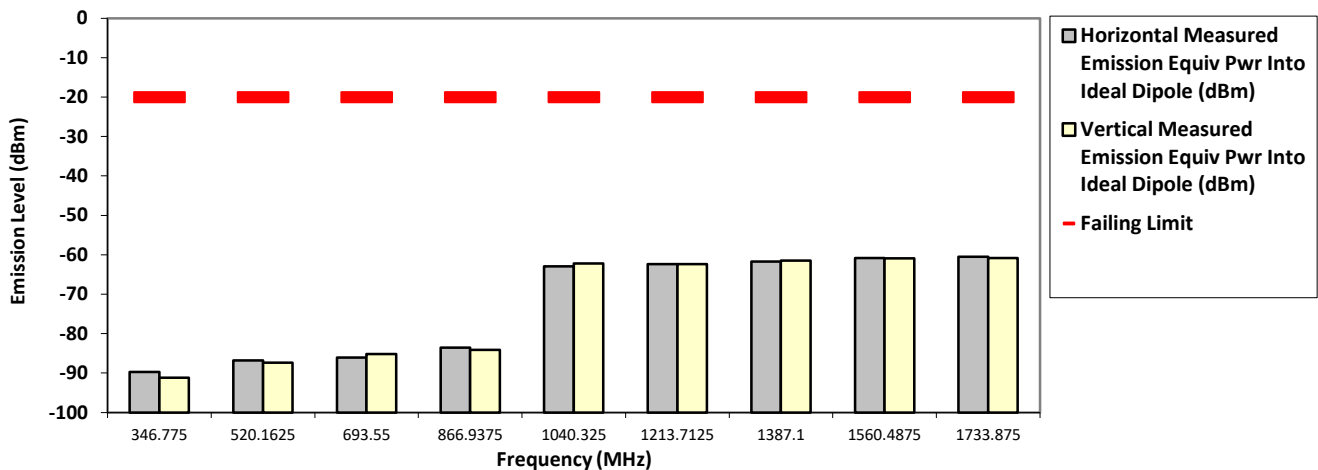

The data presented here was taken using the substitution method as found in the TIA/EIA-603E document.

Motorola Penang EMC Lab - Test Performed by: Nazrin&Qawiman

Tue, Feb 20, 2018

Industry Canada: 109AK

Remarks: ** Indicates the spurious emission could not be detected due to noise limitations or ambient.

*Pursuant to CFR 47 Part 2.1057 (c), emissions attenuated more than 20 dB below the permissible limit are not reported

Temp(Deg): 22.8 Hum(%RH): 64.3

System MU: 5.01 dB

Remarks:

Passed Results	Marginal Results	Failed Results
----------------	------------------	----------------

SAC Transmitter Radiated Emission:
Model Number: AAH56JDN9RA1AN **S/N: 871TUBN483** **SR:10463-EMC-00002**
Battery Part No: PMNN4493A **Test Mode: TX Digital** **Accy Part No: NA**
138.012500 MHz **12.5 kHz** **6.000 Watt(s) /Max Power**

Frequency (MHz)	Limit	Horizontal Measured Emission Equip Pwr Into Ideal Dipole (dBm)	Vertical Measured Emission Equip Pwr Into ideal Dipole (dBm)
276.0250	-20.0000	-91.3103 **	-91.1043 **
414.0375	-20.0000	-89.2643 **	-88.3669 **
552.0500	-20.0000	-85.5746 **	-86.2844 **
690.0625	-20.0000	-85.5100 **	-85.1346 **
828.0750	-20.0000	-84.9002 **	-84.3721 **
966.0875	-20.0000	-82.2295 **	-81.4528 **
1104.1000	-20.0000	-62.3465 **	-62.5216 **
1242.1125	-20.0000	-62.4920 **	-62.2733 **
1380.1250	-20.0000	-61.1395 **	-60.7567 **

RADIATED SPURIOUS EMISSIONS

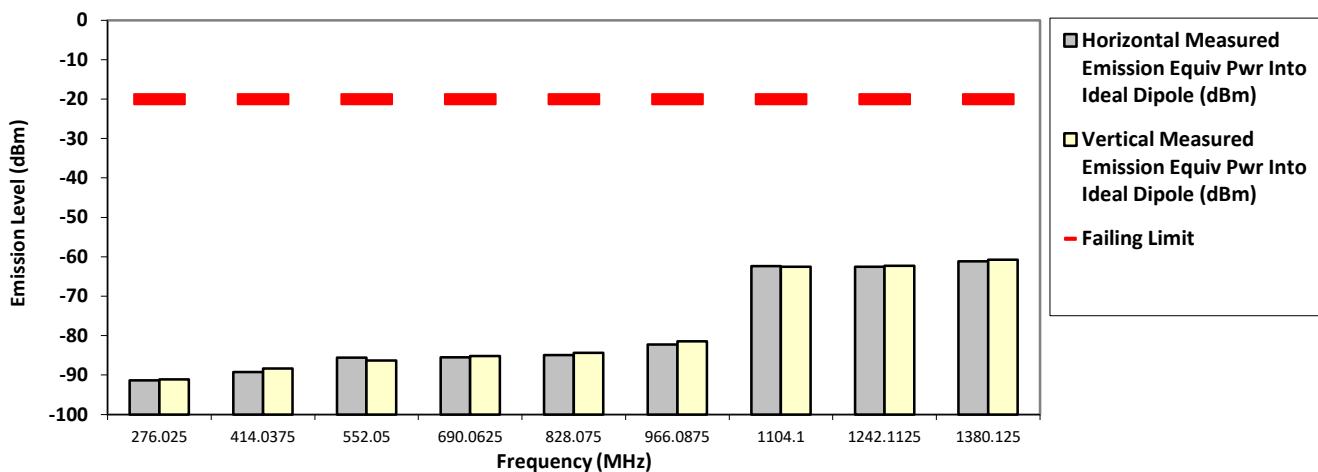

The data presented here was taken using the substitution method as found in the ANSI C63.26 document.

Motorola Penang EMC Lab - Test Performed by: Nazrin&Qawiman
 Industry Canada: 109AK

Tue, Feb 20, 2018

Remarks: ** Indicates the spurious emission could not be detected due to noise limitations or ambient.

*Pursuant to CFR 47 Part 2.1057 (c), emissions attenuated more than 20 dB below the permissible limit are not reported
 Temp(Deg): 22.8 Hum(%RH): 64.3

System MU: 5.01 dB

Remarks:	Passed Results	Marginal Results	Failed Results
----------	----------------	------------------	----------------

SAC Transmitter Radiated Emission:
Model Number: AAH56JDN9RA1AN **S/N: 871TUBN483** **SR:10463-EMC-00002**
Battery Part No: PMNN4493A **Test Mode: TX Digital** **Accy Part No: NA**
158.550000 MHz **12.5 kHz** **6.000 Watt(s) /Max Power**

Frequency (MHz)	Limit	Horizontal Measured Emission Equip Pwr Into Ideal Dipole (dBm)	Vertical Measured Emission Equip Pwr Into ideal Dipole (dBm)
317.1000	-20.0000	-91.9873 **	-91.3389 **
475.6500	-20.0000	-86.7266 **	-87.6887 **
634.2000	-20.0000	-84.9869 **	-86.3100 **
792.7500	-20.0000	-85.1143 **	-84.3354 **
951.3000	-20.0000	-82.7820 **	-81.7733 **
1109.8500	-20.0000	-62.4959 **	-62.9377 **
1268.4000	-20.0000	-61.6893 **	-61.6752 **
1426.9500	-20.0000	-60.8231 **	-60.4719 **
1585.5000	-20.0000	-59.0786 **	-61.0761 **

RADIATED SPURIOUS EMISSIONS

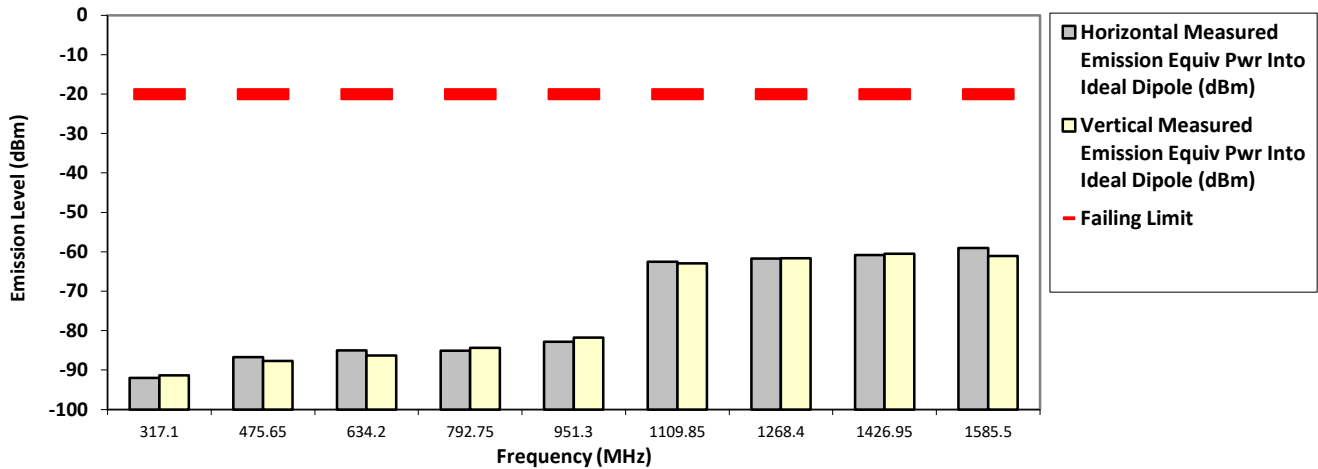

The data presented here was taken using the substitution method as found in the ANSI C63.26 document.

Motorola Penang EMC Lab - Test Performed by: Nazrin&Qawiman
 Industry Canada: 109AK

Tue, Feb 20, 2018

Remarks: ** Indicates the spurious emission could not be detected due to noise limitations or ambient.

*Pursuant to CFR 47 Part 2.1057 (c), emissions attenuated more than 20 dB below the permissible limit are not reported
 Temp(Deg): 22.8 Hum(%RH): 64.3

System MU: 5.01 dB

Remarks:	Passed Results	Marginal Results	Failed Results
----------	----------------	------------------	----------------

SAC Transmitter Radiated Emission:
Model Number: AAH56JDN9RA1AN **S/N: 871TUBN483** **SR:10463-EMC-00002**
Battery Part No: PMNN4493A **Test Mode: TX Digital** **Accy Part No: NA**
158.550000 MHz **12.5 kHz** **1.000 Watt(s) /Low Power**

Frequency (MHz)	Limit	Horizontal Measured Emission Equip Pwr Into Ideal Dipole (dBm)	Vertical Measured Emission Equip Pwr Into ideal Dipole (dBm)
317.1000	-20.0000	-91.3849 **	-90.1492 **
475.6500	-20.0000	-88.1654 **	-87.1069 **
634.2000	-20.0000	-84.5650 **	-85.3039 **
792.7500	-20.0000	-84.5502 **	-84.7824 **
951.3000	-20.0000	-82.9763 **	-82.5358 **
1109.8500	-20.0000	-60.6303 **	-62.3837 **
1268.4000	-20.0000	-61.3420 **	-61.5715 **
1426.9500	-20.0000	-61.8422 **	-62.2188 **
1585.5000	-20.0000	-61.6220 **	-60.3185 **

RADIATED SPURIOUS EMISSIONS

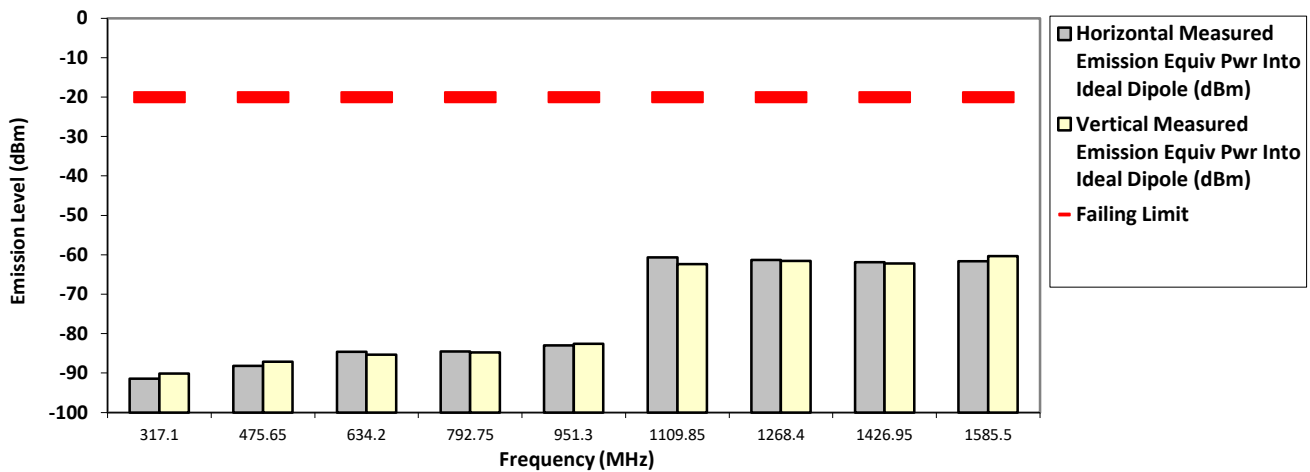

The data presented here was taken using the substitution method as found in the ANSI C63.26 document.

Motorola Penang EMC Lab - Test Performed by: Nazrin&Qawiman
 Industry Canada: 109AK

Tue, Feb 20, 2018

Remarks: ** Indicates the spurious emission could not be detected due to noise limitations or ambient.

*Pursuant to CFR 47 Part 2.1057 (c), emissions attenuated more than 20 dB below the permissible limit are not reported
 Temp(Deg): 22.8 Hum(%RH): 64.3

System MU: 5.01 dB

Remarks:

Passed Results	Marginal Results	Failed Results
----------------	------------------	----------------

SAC Transmitter Radiated Emission:
Model Number: AAH56JDN9RA1AN **S/N: 871TUBN483** **SR:10463-EMC-00002**
Battery Part No: PMNN4493A **Test Mode: TX Digital** **Accy Part No: NA**
173.387500 MHz **12.5 kHz** **6.000 Watt(s) /Max Power**

Frequency (MHz)	Limit	Horizontal Measured Emission Equip Pwr Into Ideal Dipole (dBm)	Vertical Measured Emission Equip Pwr Into ideal Dipole (dBm)
346.7750	-20.0000	-89.7545 **	-91.1434 **
520.1625	-20.0000	-86.8054 **	-87.3259 **
693.5500	-20.0000	-86.0976 **	-85.1745 **
866.9375	-20.0000	-83.5707 **	-84.1175 **
1040.3250	-20.0000	-62.9487 **	-62.1973 **
1213.7125	-20.0000	-62.3417 **	-62.3859 **
1387.1000	-20.0000	-61.7009 **	-61.4505 **
1560.4875	-20.0000	-60.8441 **	-60.8791 **
1733.8750	-20.0000	-60.5049 **	-60.8633 **

RADIATED SPURIOUS EMISSIONS

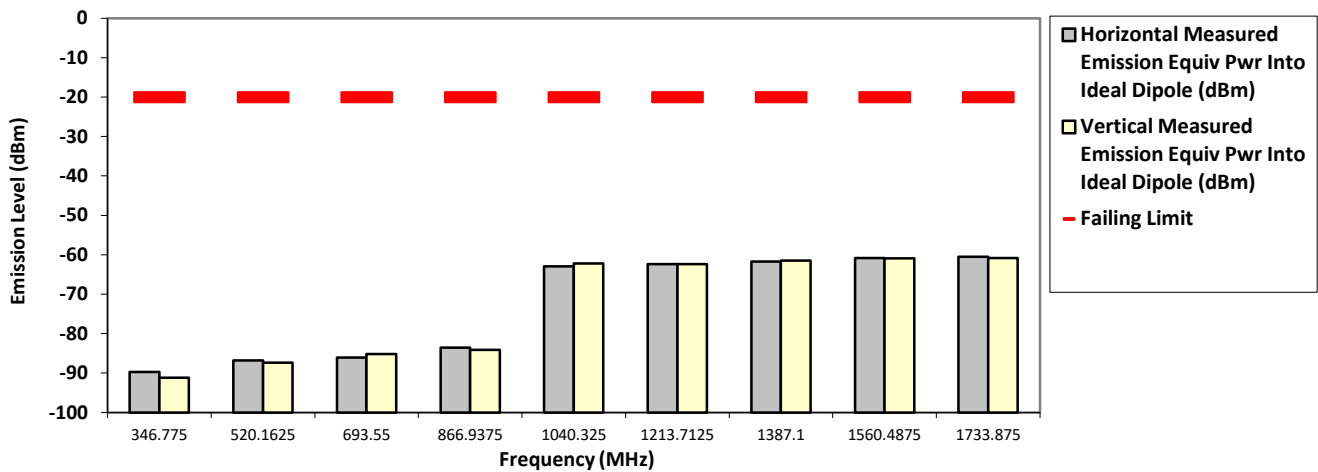

The data presented here was taken using the substitution method as found in the ANSI C63.26 document.

Motorola Penang EMC Lab - Test Performed by: Nazrin&Qawiman
 Industry Canada: 109AK

Tue, Feb 20, 2018

Remarks: ** Indicates the spurious emission could not be detected due to noise limitations or ambient.

*Pursuant to CFR 47 Part 2.1057 (c), emissions attenuated more than 20 dB below the permissible limit are not reported
 Temp(Deg): 22.8 Hum(%RH): 64.3

System MU: 5.01 dB

Remarks:

Passed Results	Marginal Results	Failed Results
----------------	------------------	----------------

6.11.4. Test Limit

Table below summarized the power of any emission outside a licensee’s frequency block shall be attenuated below the transmitter power (P) by at least

Channel Spacing	Part 22	Part 24D	Part 74	Part 80	Part 90 (UHF, VHF, 800, 900)	Part 90 (700)
12.5kHz	43 + log ₁₀ (P) (-13 dBm)	43 + log ₁₀ (P) (-13 dBm)	43 + log ₁₀ (P) (-13 dBm)	Not Applicable	50 + log ₁₀ (P) (-20 dBm)	43 + log ₁₀ (P) (-13 dBm)
25kHz		Not Applicable		43 + log ₁₀ (P) (-13 dBm)	43 + log ₁₀ (P) (-13 dBm)	43 + log ₁₀ (P) (-13 dBm)

Channel Spacing	RSS 134	RSS 182	RSS 119 (UHF, VHF, 800, 900)	RSS 119 (700)
12.5kHz	43 + log ₁₀ (P) (-13 dBm)	Not Applicable	50 + log ₁₀ (P) (-20 dBm)	43 + log ₁₀ (P) (-13 dBm)
25kHz	Not Applicable	43 + log ₁₀ (P) (-13 dBm)	43 + log ₁₀ (P) (-13 dBm)	43 + log ₁₀ (P) (-13 dBm)

6.12. Effective Radiated Power (ERP)

6.12.1. Test Setup

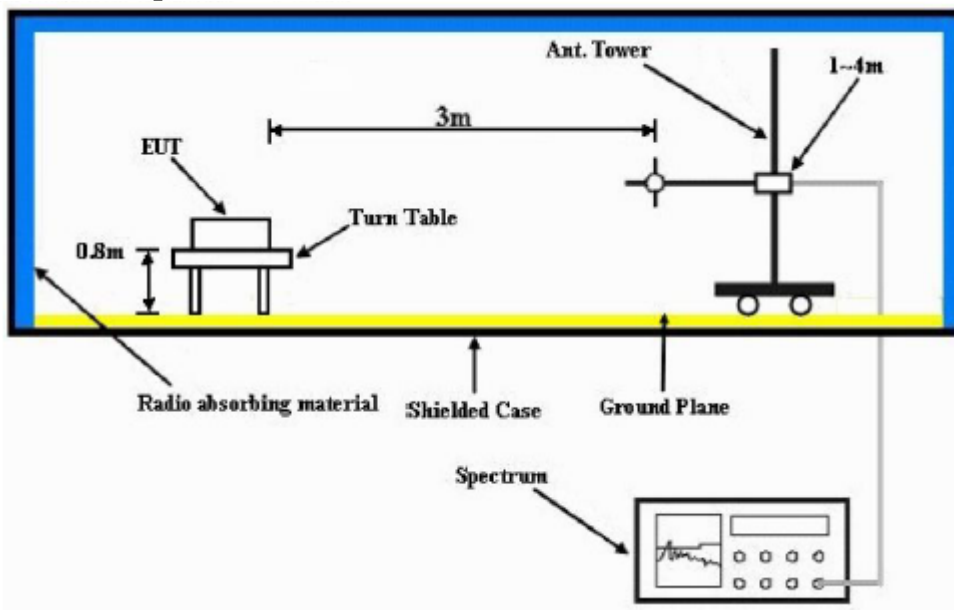

- 1) The Resolution Bandwidth for Equivalent Radiated Power (ERP) below 1 GHz is 100 kHz with Video Bandwidth = 300 kHz and Resolution Bandwidth for EIRP above 1 GHz is 1 MHz with Video Bandwidth = 3 MHz. Detector Mode is RMS.
- 2) In the semi-anechoic chamber, setup as illustrated above the DUT placed on the 0.8m height of Turn Table, rotated the table 45 degree each interval to search the maximum radiation power and receiver antenna shall be rotated vertical and horizontal polarization and moved height from 1m to 4m to find the maximum polar radiated power for each degree interval. The “Read Value” is the spectrum reading of maximum power value.
- 3) The substitution antenna is substituted for DUT at the same position and signals generator (S.G) export the CW signal to the substitution antenna via a TX cable. The receiver antenna shall be rotated vertical and horizontal polarization and moved height from 1m to 4m to find the maximum radiation power. Record the power level of maximum radiation power from spectrum. So, the Measured substitution value = Ref level of S.G + TX cables loss – Substituted Antenna Gain.

6.12.2. Test Result

NA → Not Applicable

6.12.3. Test Limit

The maximum output power of the transmitter for mobile stations is 100 watts (20 dB). Power is given in terms of effective radiated power (ERP).

6.13. GNSS (EIRP for 1559 - 1610MHz)

6.13.1. Test Setup

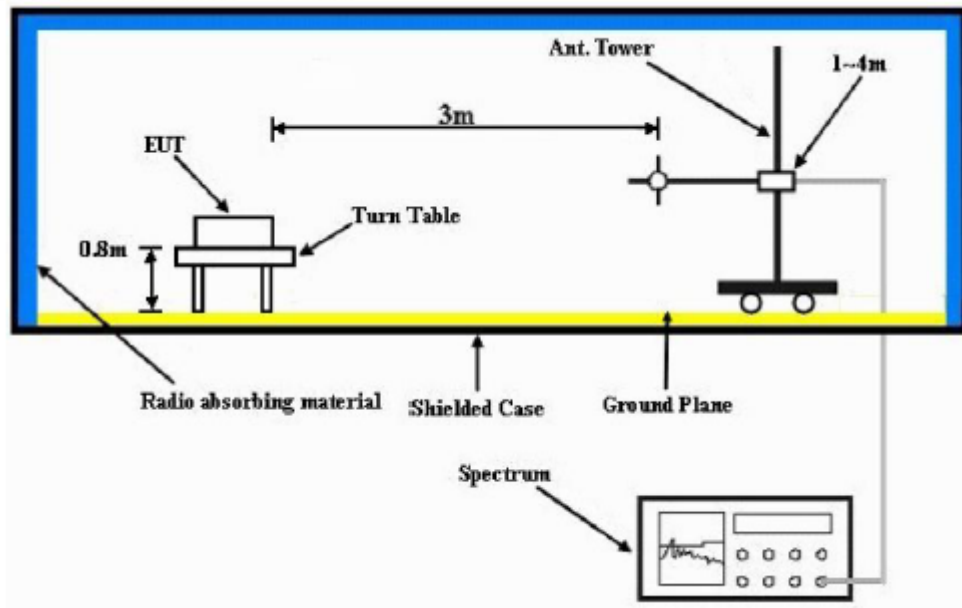

- 4) The Resolution Bandwidth for Equivalent Isotropically Radiated Power (EIRP) below 1 GHz is 100 kHz with Video Bandwidth = 300 kHz and Resolution Bandwidth for EIRP above 1 GHz is 1 MHz with Video Bandwidth = 3 MHz. Detector Mode is RMS.
- 5) In the semi-anechoic chamber, setup as illustrated above the DUT placed on the 0.8m height of Turn Table, rotated the table 45 degree each interval to search the maximum radiation power and receiver antenna shall be rotated vertical and horizontal polarization and moved height from 1m to 4m to find the maximum polar radiated power for each degree interval. The “Read Value” is the spectrum reading of maximum power value.
- 6) The substitution antenna is substituted for DUT at the same position and signals generator (S.G) export the CW signal to the substitution antenna via a TX cable. The receiver antenna shall be rotated vertical and horizontal polarization and moved height from 1m to 4m to find the maximum radiation power. Record the power level of maximum radiation power from spectrum. So, the Measured substitution value = Ref level of S.G + TX cables loss – Substituted Antenna Gain.
- 7) $EIRP = \text{“Read Value”} + \text{Measured substitution value} + 2.15$.

6.13.1. Test Result

NA → Not Applicable

6.13.2. Test Limit

For operations in the 758-775 MHz and 788-805 MHz bands, all emissions including harmonics in the band 1559-1610 MHz shall be limited to -70 dBW/MHz equivalent isotropically radiated power (EIRP) for wideband signals, and -80 dBW EIRP for discrete emissions of less than 700 Hz bandwidth.

~ End of Report ~