 <p>CERTIFICATE 2518.08</p> <p>MS ISO/IEC 17025 TESTING SAMM NO. 0825</p>
---	---

<p>MOTOROLA PENANG ADV. COMM. LABORATORY Motorola Solutions Malaysia SDN BHD, Plot 2A, Medan Bayan Lepas, Mukim 12 S.W.D, 11900 Bayan Lepas, Penang, Malaysia.</p>	<p>FCC / ISED TEST REPORT Report Revision : Rev.B</p>
---	--

<p>Date/s Tested : 3-JUN-2020 - 15-JUN-2020 Report Issue Date : 16-JUL-2020 Manufacturer : Motorola Solutions Malaysia SDN BHD Manufacturer Address : Plot 2A, Medan Bayan Lepas, Mukim 12 SWD, 11900 Bayan Lepas, Penang, Malaysia Requestor : CHEW LOOI WONG Product Type : Portable Product Version (PMN) : XPR 7550 IS Model Number (HVIN) : AAH56JDN9PA3AN (PMUD3254ABCNAA) Frequency Band : 136-174MHz Firmware Version (FVIN) : R02.10.10.0001 Max RF Output Power : 6Watts Applicant Name : Motorola Solutions Inc Applicant Address : 8000 West Sunrise Boulevard, Fort Lauderdale, Florida 33322 ISED Registrations : MY0001 FCC Registrations : 461337</p>	
--	--

The equipment was tested accordance to the requirement listed below:

<p>(LMR) FCC 47 CFR Part 2/ 22 / 74 / 80 / 90 ISED RSS-Gen Issue 5 / 119 Issue 12 / 182 Issue 5</p>	<p>PASS</p>
--	--------------------

This report shall not be reproduced without written approval from an officially designated representative of the Motorola Penang Adv. Comm. Laboratory. The results and statements contained in this report pertain only to the device(s) evaluated.

<p>Prepared By:</p> <div style="text-align: center; margin-top: 20px;">  </div> <hr style="width: 20%; margin: 0 auto;"/> <p>Aaron Goh Tong Wen Test Personnel</p>	<p>Approved Signatory:</p> <div style="text-align: center; margin-top: 20px;">  </div> <hr style="width: 20%; margin: 0 auto;"/> <p>Vincent Foong Chuen Kit Deputy Technical Manager</p>
--	--

Table of Contents

Report Revision History	3
1.0 General Information.....	4
2.0 Summary of Test Results.....	5
3.0 Measurement Uncertainty.....	6
4.0 Equipment List.....	7
5.0 Test Condition.....	10
5.1. Transmitter Test Conditions	10
6.0 Transmitter Test Parameters	11
6.1. RF Output Power	11
6.1.1. Test Setup.....	11
6.1.2. Test Result	11
6.2. Frequency Stability	12
6.2.1. Test Setup.....	12
6.2.2. Test Result	13
6.2.3. Test Limit.....	14
6.3. Audio Frequency Response	15
6.3.1. Test Setup.....	15
6.3.2. Test Result	16
6.3.3. Test Limit.....	17
6.4. Audio Low Pass Filter Response	18
6.4.1. Test Setup.....	18
6.4.2. Test Result	19
6.4.3. Test Limit.....	20
6.5. Modulation Limiting.....	21
6.5.1. Test Setup.....	21
6.5.2. Test Result	22
6.5.3. Test Limit.....	22
6.6. Occupied Bandwidth.....	23
6.6.1. Test Setup (Analog)	23
6.6.2. Test Result (Analog).....	24
6.6.3. Test Setup (Digital).....	30
6.6.4. Test Result (Digital).....	31
6.6.5. Test Limit.....	37
6.7. Band Edge Conducted Spurious Emission (Part 22)	38
6.7.1. Test Setup (Analog)	38
6.7.2. Test Result (Analog).....	39
6.7.3. Test Setup (Digital).....	40
6.7.4. Test Result (Digital).....	41
6.7.5. Test Limit.....	41
6.8. Transient Frequency Behavior.....	42
6.8.1. Test Setup.....	42
6.8.2. Test Result	43
6.8.3. Test Limit.....	45

6.9. Adjacent Channel Power..... 46

6.9.1. Test Setup (Analog) 46

6.9.2. Test Result 46

6.9.3. Test Setup (Digital)..... 47

6.9.4. Test Result 47

6.9.5. Test Limit..... 48

6.10. Conducted Spurious Emission 50

6.10.1. Test Setup..... 50

6.10.2. Test Result (Analog)..... 51

6.10.3. Test Result (Digital)..... 58

6.10.4. Test Limit..... 65

6.11. Radiated Spurious Emission 66

6.11.1. Test Setup..... 66

6.11.2. Test Result (Analog)..... 67

6.11.3. Test Result (Digital)..... 78

6.11.4. Test Limit..... 88

6.12. Effective Radiated Power (ERP) 89

6.12.1. Test Setup..... 89

6.12.2. Test Result 89

6.12.3. Test Limit..... 89

6.13. GNSS (EIRP for 1559 - 1610MHz)..... 90

6.13.1. Test Setup..... 90

6.13.1. Test Result 90

6.13.2. Test Limit..... 90

Report Revision History

Revision History	Description	Date	Originator
Rev. A	Initial Report	16-JUL-2020	Aaron Goh
Rev. B	Removed FXW emission designator	21-JUL-2020	Vincent Foong

1.0 General Information

EUT Description:

Technologies	Land Mobile Radio (LMR)
Modulation Type	Analog, 4FSK

The EUT contains following accessory devices and data cable:

Item	Brand	Model or P/N
VHF Wide Band Antenna (136-174MHz)	Motorola	PMAD4088B
BATT IMPRES LIION CSA157 IP68 2300T	Motorola	NNTN8386A

General Description of Applied Standards

The EUT is a RF Product. According to the specifications of the manufacturer, the EUT is to comply with the requirements of the following standards:

ANSI C63.4-2014

ANSI C63.26-2015

No modifications were done to the UUT to facilitate the tests in this report.

Deviation from standard

Not applicable as no deviation from standard test method

2.0 Summary of Test Results

FCC General Rules Part (47CFR)	ISED General Rules Part	Test Item	Result	Remarks	Serial number tested
2.1046, 90.541, 22.565, 74.461, 74.534, 80.215, 90,74,22	RSS-119	RF Power Output	Pass		627TWK0700
2.1055, 90.213, 22.355, 74.464, 74.561	RSS-119	Frequency Stability	Pass		627TWK0700
2.1047, 74.463, 80.213,80,90,22	RSS-119	Audio Frequency Response	Pass		627TWK0700
2.1047, 74.463, 80.213,80,90,22	RSS-119	Audio Low Pass Filter Response	Pass		627TWK0700
2.1047, 74.463, 80.213,80,90,22	RSS-119	Modulation limiting	Pass		627TWK0700
2.1049, 90.210, 22.359, 74.462, 74.535, 80.211(c), 80.211(f),74.462(c),22.359(b)	RSS-119	Occupied Bandwidth	Pass	16K0F3E-14.9975kHz 11K0F3E-9.8469kHz 7K60F1D/7K60FXD – 7.3535kHz 7K60F1E/7K60FXE - 7.5095kHz 7K60F1W -7.2829kHz	627TWK0700
22.359 (a), (b)	RSS-119	Band Edge Conducted Spurious Emission	Pass		627TWK0700
90.214	RSS-119	Transient Frequency Behavior	Pass		627TWK0700
-	-	Adjacent Channel Power	NA		
Low end of the band, Federal, Low end of part 90, 74D, 74H, 90, 22	RSS-119	Conducted Spurious Emissions	Pass	No spur detected (noise floor)	627TWK0700
Low end of the band, Federal, Low end of part 90, 74D, 74H, 90, 22	RSS-119	Radiated Spurious Emission	Pass	No spur detected (noise floor)	627TWK0679
-	-	GNSS (EIRP for 1559 – 1610MHz)	NA		
-	-	Effective Radiated Power (ERP)	NA		

NA → Not Applicable

3.0 Measurement Uncertainty

Measurement	Frequency	Expanded Uncertainty (k=1.96) (\pm dB)
AC Power Line Conducted Spurious Emission	150KHz ~ 30MHz	3.43
Radiated Emissions up to 1 GHz	30MHz ~ 200MHz	4.03
	200MHz ~ 1000MHz	4.03
Radiated Emissions above 1 GHz	1GHz ~ 18GHz	4.03
	18GHz ~ 25GHz	4.03

4.0 Equipment List

FCC Analog ATE#1: (SW version: 2.4.5 & FCC_Frequency Stability 1.0.3 rev.)

Description	Model	Serial Number	Calibration Date	Calibration Due Date
AUDIO ANALYZER	8903B	3729A17612	15-Nov-17	15-Nov-20
SIGNAL GENERATOR	2042	203002/956	20-Aug-19	20-Aug-20
MODULATION ANALYZER	8901B	3216A03949	9-Apr-19	9-Jul-20
DSA Dynamic Signal Analyzer	35670A	MY42506790	4-Apr-19	4-Jul-20
POWER SENSOR	E4412A	MY41502652	31-Jul-19	31-Jul-20
POWER METER	E4416A	GB41293747	19-Nov-18	19-Nov-20
POWER SUPPLY	6031A	3325A02771	13-Mar-20	13-Mar-21
CHAMBER	SH-641	92009188	6-Mar-20	6-Mar-21
N to N RF Cable # 1	M17/128-RG400	NA	NA	NA
BNC to N RF Cable # 1	RG 58	NA	NA	NA
BNC to BNC RF Cable # 1	RG 58	NA	NA	NA
BNC to BNC RF Cable # 2	RG 58	NA	NA	NA
BNC to BNC RF Cable # 3	RG 58	NA	NA	NA
BNC to BNC RF Cable # 4	RG 58	NA	NA	NA
BNC to BNC RF Cable # 5	RG 58	NA	NA	NA
BNC to BNC RF Cable # 6	RG 58	NA	NA	NA
BNC to BNC RF Cable # 7	RG 58	NA	NA	NA
N to SMA RF Cable # 1	RG 58	NA	NA	NA
N to SMA RF Cable # 2	RG 58	NA	NA	NA
N to SMA RF Cable # 3	RG 58	NA	NA	NA
Aeroflex Attenuator 30dB	49-30-34-LIM	NA	NA	NA

FCC Transient ATE #1: (SW version: FCC Transient ATE_R1.1.2)

Description	Model	Serial Number	Calibration Date	Calibration Due Date
POWER SUPPLY	6031A	2430A00146	5-Apr-19	5-Jul-20
POWER SENSOR	E4412A	MY41498918	31-Jul-19	31-Jul-20
POWER METER	E4416A	GB41293866	26-Feb-19	26-Feb-21
ATTENUATORS/SWITCH DRIVER	11713A	2508A10141	CNR	CNR
STEP ATTENUATOR/11dB	8494G	MY52300223	2-Aug-19	2-Aug-20
STEP ATTENUATOR/110dB	8496G	MY52000176	9-Aug-19	9-Aug-20
OSCILLOSCOPE	MSO8104A	MY45002372	17-Jun-19	17-Jun-20
AUDIO ANALYZER	8903B	3011A08952	5-Jul-19	5-Jul-20
AUDIO ANALYZER	8903B	3729A17409	4-Jul-19	4-Jul-20
MODULATION ANALYZER	8901B	3226A04052	3-Apr-19	3-Jul-20
SIGNAL GENERATOR	8657B	3427U06025	5-Apr-19	5-Jul-20
SPECTRUM ANALYZER	E4440A	MY48250517	1-Aug-19	1-Aug-20
N to N RF Cable # 1	SF126/11N/11N	NA	NA	NA
N to N RF Cable # 2	M17/128-RG400	NA	NA	NA
N to N RF Cable # 3	M17/128-RG400	NA	NA	NA
N to N RF Cable # 4	M17/128-RG400	NA	NA	NA
N to N RF Cable # 5	M17/128-RG400	NA	NA	NA
N to N RF Cable # 6	M17/128-RG400	NA	NA	NA
N to N RF Cable # 7	M17/128-RG400	NA	NA	NA
N to N RF Cable # 8	M17/128-RG400	NA	NA	NA
N to N RF Cable # 9	M17/128-RG400	NA	NA	NA
BNC to BNC RF Cable # 1	RG 58	NA	NA	NA
BNC to BNC RF Cable # 2	RG 58	NA	NA	NA
BNC to BNC RF Cable # 3	RG 58	NA	NA	NA
BNC to BNC RF Cable # 4	RG 58	NA	NA	NA
BNC to BNC RF Cable # 5	RG 58	NA	NA	NA
BNC to BNC RF Cable # 6	RG 58	NA	NA	NA
BNC to N RF Cable # 1	RG 58	NA	NA	NA
Aeroflex Attenuator 10dB	49-10-43-LIM	NA	NA	NA
Aeroflex Attenuator 10dB	33-10-34-LIM	NA	NA	NA
SWITCH CONTROL UNIT	3488A	2719A36210	CNR	CNR

CNR→Calibration Not Required

CONDUCTED SPUR EMISSION ATE # 1 (SW version: Conducted Spur ATE rev 1.23.02)

Description	Model	Serial Number	Calibration Date	Calibration Due Date
SWITCH CONTROL UNIT	3488A	2719A32735	CNR	CNR
SPECTRUM ANALYZER	E4445A	MY46181732	12-Mar-19	12-Mar-21
POWER SUPPLY	6032A	2723A02219	2-Jul-19	2-Jul-20
HIGH PASS FILTER SWITCH BOX	-	CS001	4-Jul-19	4-Jul-20
N to N RF Cable # 1	SF126/11N/11N	NA	NA	NA
N to N RF Cable # 2	SF126/11N/11N	NA	NA	NA
BNC to BNC RF Cable # 1	RG 58	NA	NA	NA
Aeroflex Attenuator 30dB	49-30-43-LIM	NA	NA	NA
Aeroflex Attenuator 10dB	33-10-34-LIM	NA	NA	NA

Radiated Emission Station

EMC Chamber 1

DESCRIPTION	MODEL	SERIAL NUMBER	CALIBRATION DATE	CALIBRATION DUE DATE
DRG HORN FREQ.	SAS-571	720	21-Mar-19	21-Mar-21
DRG HORN FREQ.	SAS-571	1143	14-Feb-19	14-Feb-21
POWER SUPPLY (0-60V / 0-50A, 1000W)	6032A	2615A01178	21-MAY-20	21-MAY-21
SIGNAL GENERATOR	SMB 100A	181117	8-Nov-18	8-Nov-21
EMI TEST RECEIVER	ESW44	101750	24-Jul-19	24-Jul-20
EMI TEST RECEIVER	ESIB26	100017	19-Jul-19	19-Jul-20
5m Semi-anechoic Chamber	S800-HX	J2308	No Cal. Req'd	No Cal. Req'd
BILOG ANTENNA	CBL6112D	30991	5-Aug-19	5-Aug-20
BILOG ANTENNA	CBL6112B	2950	8-Jul-19	8-Jul-21
DATA LOGGER	DSB	16372019	31-Oct-19	31-Oct-20
SYSTEM CONTROLLER	SC104V	050806-1	No Cal. Req'd	No Cal. Req'd
TURNTABLE FLUSH MOUNT 2M	FM2011	NA	No Cal. Req'd	No Cal. Req'd
ANTENNA POSITIONING TOWER	TLT2	NA	No Cal. Req'd	No Cal. Req'd
BROAD-BAND HORN ANTENNA	BBHA9170	BBHA9170143	23-Jun-19	23-Jun-20
18 - 40GHz PREAMPLIFIER	Miteq Hi Gain Sucoflex	001	No Cal. Req'd	No Cal. Req'd
PREAMPLIFIER	PAM-0118	269	24-May-19	24-May-22
LOOP ANTENNA	6502	00208416	5-Sep-19	5-Sep-20
Test Software	EMC_FCC_IC_Bluetooth_RE_Test			
Version	EMC FCC RE v1.6.2			

5.0 Test Condition

5.1. Transmitter Test Conditions

Test Item, (Channel Spacing)	Power (W)	Modulation	Test Frequency (MHz)	Tested By	Environmental conditions
RF Output Power	Low & Max	Analog	136.0125,138.0125,157.77, 158.55,158.67,161.7,173.3875	Aaron Goh	23.4°C, 50%RH
Frequency Stability	Max	Analog	158.55	Aaron Goh	25.1°C, 54.3%RH, 60.3°C, 50%RH, -30.1°C, 51.2%RH
Audio Frequency Response (12.5kHz / 25kHz)	Max	Analog	158.55	Aaron Goh	23.4°C, 50%RH
Audio Low Pass Filter Response (12.5kHz / 25kHz)	Max	Analog	158.55	Aaron Goh	23.4°C, 50%RH
Modulation limiting (12.5kHz / 25kHz)	Max	Analog	158.55	Aaron Goh	23.4°C, 50%RH
Occupied Bandwidth (12.5kHz / 20kHz / 25kHz)	Max	Analog, 4FSK	138.0125,158.55, 161.7,173.3875	Aaron Goh	23.4°C, 50%RH
Band Edge Conducted Spurious Emissions (Part 22) (12.5kHz / 20kHz / 25kHz)	Max	Analog, 4FSK	157.7,158.67	Aaron Goh	23.4°C, 50%RH
Transient Frequency Behavior (UHF & VHF Band) (12.5kHz / 25kHz)	Max	Analog, 4FSK	158.55	Aaron Goh	23.4°C, 50%RH
Adjacent Channel Power (700MHz Band) (12.5kHz / 25kHz)	Max	NA	NA	NA	NA
Conducted Spurious Emissions- (12.5kHz / 25kHz)	Low / Max	Analog, C4FM, Phase II	136.0125,138.0125, 158.55,161.7,173.3875	Aaron Goh	23.4°C, 50%RH
Radiated Spurious Emission (12.5kHz / 25kHz)	Low / Max	Analog, C4FM, Phase II	136.0125,138.0125, 158.55,161.7,173.3875	Nazrin&Qawiman	23.7°C, 69.4%RH
GNSS (EIRP for 1559 - 1610MHz) (12.5kHz / 25kHz)	Max	NA	NA	NA	NA
Effective Radiated Power (ERP) (12.5kHz / 25kHz)	Max	NA	NA	NA	NA

NA → Not Applicable

6.0 Transmitter Test Parameters

6.1. RF Output Power

6.1.1. Test Setup

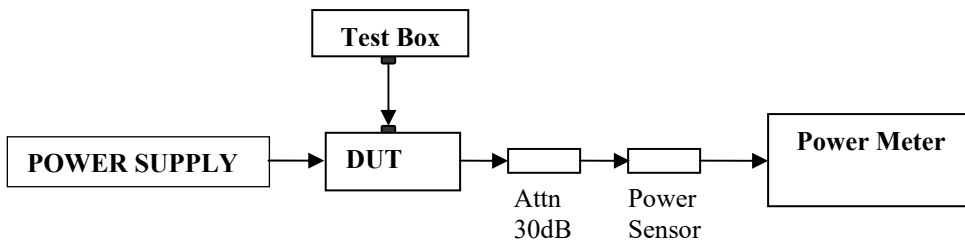

- 1) The DUT transmitter connected to Power Meter using the 30 dB attenuator and power sensor with above setup.
- 2) Path loss for the measurement included.
- 3) All the measurement was done at low, mid, high frequency for each band.
- 4) Record the power into the test report.

6.1.2. Test Result

Temperature	25°C				Remark
Voltage (V)	7.5V				
Frequency (MHz)	Low Power (W)	Current (A)	Max Power (W)	Current (A)	
136.0125	0.92	0.72	5.74	1.65	
138.01250	0.94	0.69	5.79	1.62	
157.77000	0.93	0.60	5.78	1.62	
158.55000	0.92	0.63	5.75	1.63	
158.55000	0.92	0.63	4.85	1.47	Part 80(5W)
158.67000	0.94	0.60	5.76	1.62	
161.70000	0.92	0.63	5.75	1.68	
173.38750	0.92	0.66	5.79	1.62	

6.2. Frequency Stability

6.2.1. Test Setup

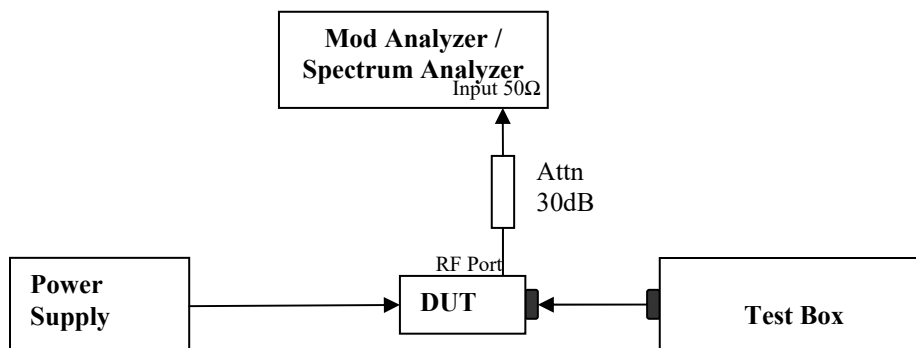

- 1) The DUT transmitter output port was connected to Modulation / Spectrum Analyzer.
- 2) Path loss for the measurement included.
- 3) Transmit the DUT and record the freq in MCF_{MHz} .
- 4) Test in 2 conditions:
 - Temperature: The frequency of the transmitter was measured from $-30^{\circ}C$ to $50^{\circ}C$.
 - Supply Voltage:
 - Mobile: The frequency of the transmitter was measured from 85% to 115% of the nominal operating input voltage.
 - Portable: The frequency of the transmitter was measured from nominal $\pm x\%$ as specified by the manufacturer
- 5) Calculate the ppm frequency error by the following:

$$ppm\ error = \left(\frac{MCF_{MHz}}{ACF_{MHz}} - 1 \right) * 10^6$$

Where: MCF_{MHz} is the Measured Carrier Frequency in MHz
 ACF_{MHz} is the Assigned Carrier Frequency in MHz

6.2.2. Test Result

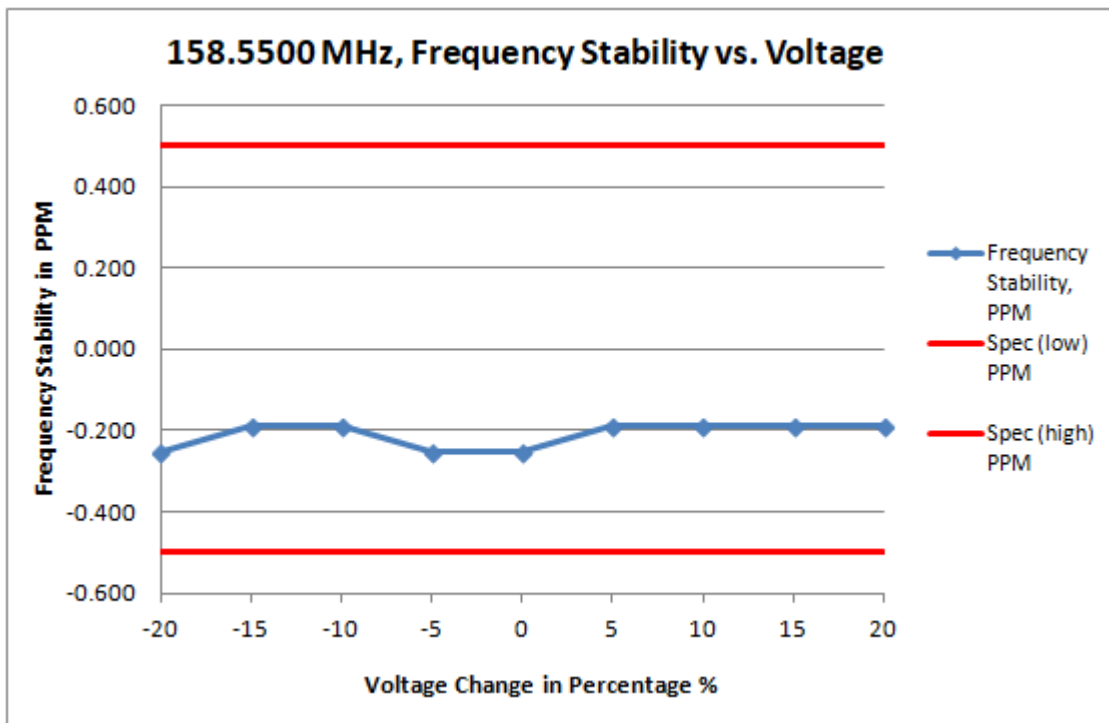

Frequency / Channel Spacing	158.5500 MHz / 12.5 kHz				
Temperature, °C	25				
Voltage %	Voltage, V	Frequency, MHz	Frequency Stability, PPM	Spec (low) PPM	Spec (high) PPM
-20	6.370	158.549960	-0.252	-0.500	0.500
-15	6.750	158.549970	-0.189	-0.500	0.500
-10	7.120	158.549970	-0.189	-0.500	0.500
-5	7.500	158.549960	-0.252	-0.500	0.500
0	7.870	158.549960	-0.252	-0.500	0.500
5	8.250	158.549970	-0.189	-0.500	0.500
10	8.620	158.549970	-0.189	-0.500	0.500
15	9.000	158.549970	-0.189	-0.500	0.500
20	9.000	158.549970	-0.189	-0.500	0.500

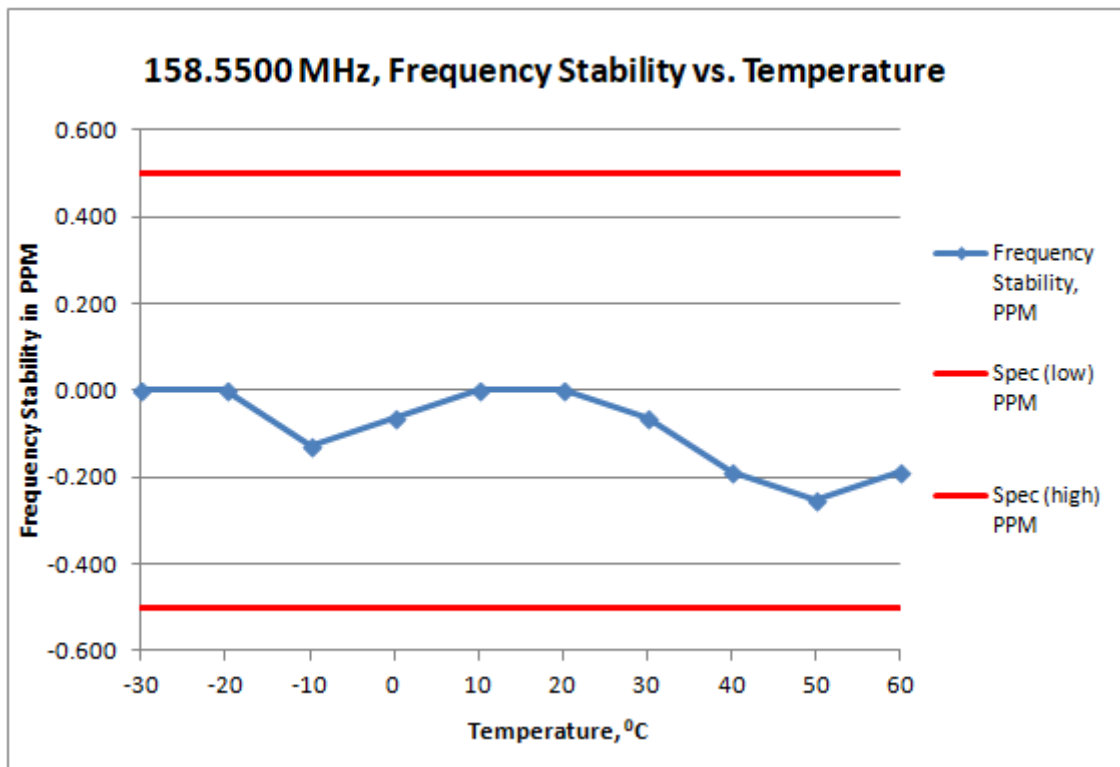

Frequency / Channel Spacing	158.5500 MHz / 12.5 kHz			
Voltage, V	7.5			
Temperature, °C	Frequency, MHz	Frequency Stability, PPM	Spec (low) PPM	Spec (high) PPM
-30	158.550000	0.000	-0.500	0.500
-20	158.550000	0.000	-0.500	0.500
-10	158.549980	-0.126	-0.500	0.500
0	158.549990	-0.063	-0.500	0.500
10	158.550000	0.000	-0.500	0.500
20	158.550000	0.000	-0.500	0.500
30	158.549990	-0.063	-0.500	0.500
40	158.549970	-0.189	-0.500	0.500
50	158.549960	-0.252	-0.500	0.500
60	158.549970	-0.189	-0.500	0.500

6.2.3. Test Limit

As per manufacturer declared spec +/- 0.5ppm

6.3. Audio Frequency Response

6.3.1. Test Setup

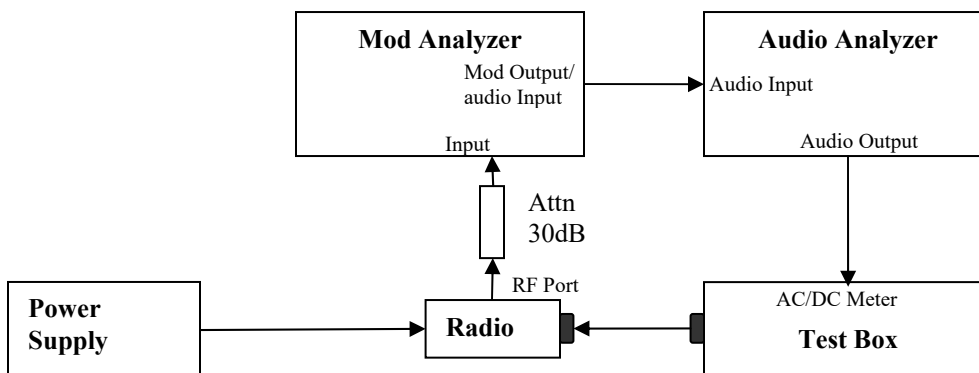

- 1) The DUT transmitter output port was connected to Modulation Analyzer.
- 2) Path loss for the measurement included.
- 3) Set the audio bandwidth filter to 15 kHz and 50 kHz.
- 4) Transmit the radio and set the audio analyzer to 1 kHz audio frequency and 20% of the Full rated system deviation.
- 5) On audio analyzer, set the rated level as reference to zero.
- 6) Vary the audio frequency from 300 Hz to 3 kHz. Record the change in dB on the audio analyzer.

6.3.2. Test Result

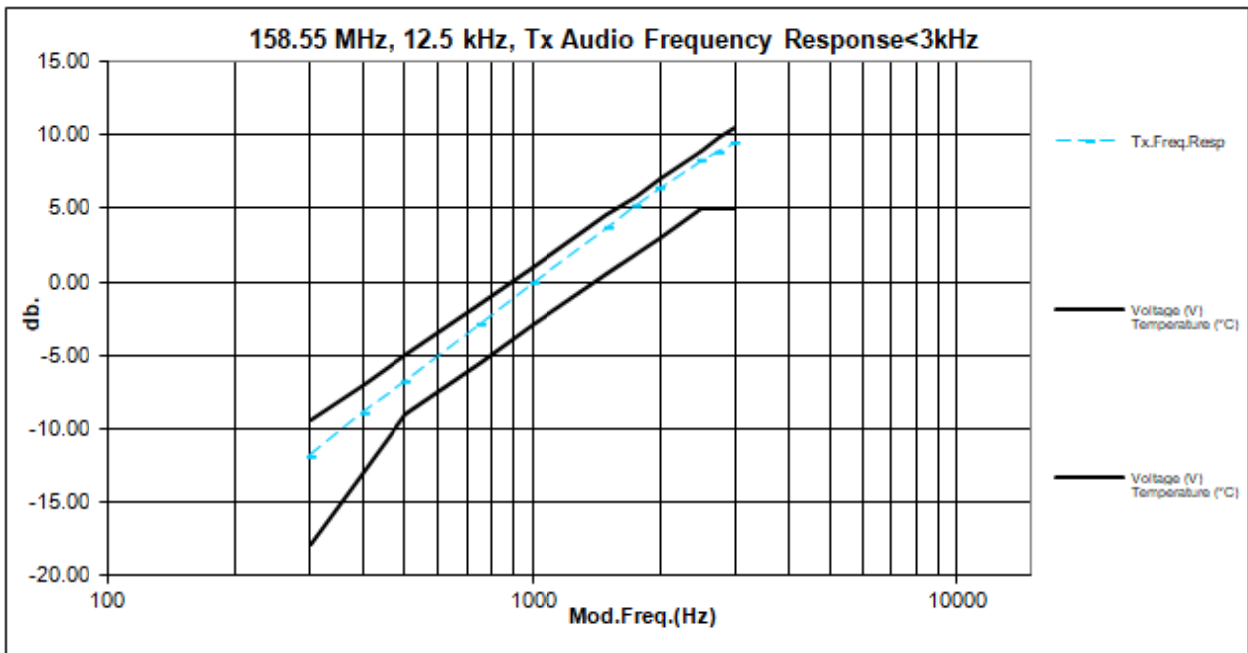
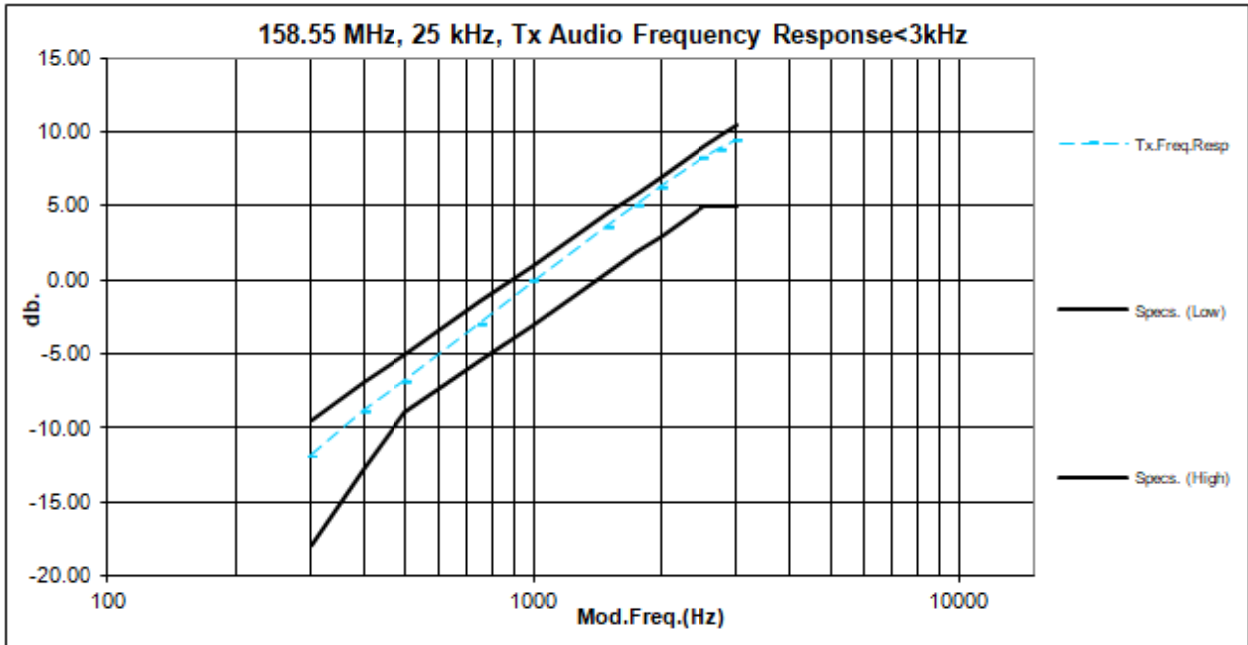

6.3.3. Test Limit

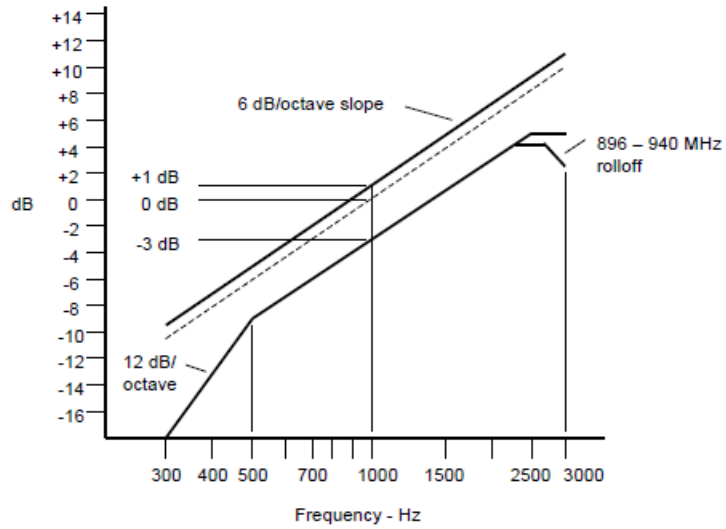

Note:

- o *There are additional 6 dB per octave attenuation is allowed from 2.5KHz to 3KHz in equipment 25MHz to 869MHz radio.*
- o *Additional 6 dB per octave attenuation is allowed from 2.3KHz to 2.7KHz & additional 12 dB per octave attenuation is allowed from 2.7KHz to 3KHz in equipment 896MHz to 940MHz radio.*

6.4. Audio Low Pass Filter Response

6.4.1. Test Setup

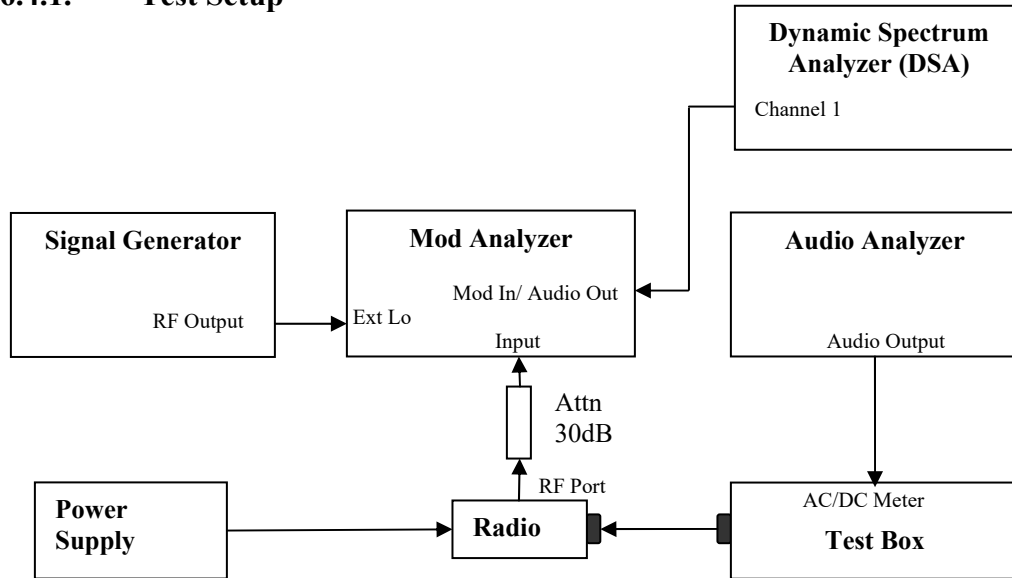

- 1) The DUT transmitter output port was connected to Modulation Analyzer.
- 2) Path loss for the measurement included.
- 3) Press 23.1SPCL on modulation analyzer to enable the external LO from Sigen.
- 4) Set the Sigen frequency to $F_c + 1.5$ MHz, RF output level to 0dBm without modulation.
- 5) Transmit the radio and set the audio analyzer to 1 kHz audio frequency and 60% of the Full rated system deviation.
- 6) Up the amplitude by 20dB.
- 7) On DSA, get the reference point to 0dB.
- 8) Vary the frequency on audio analyzer from 3 kHz to 20 kHz, record the audio tone from DSA.

6.4.2. Test Result

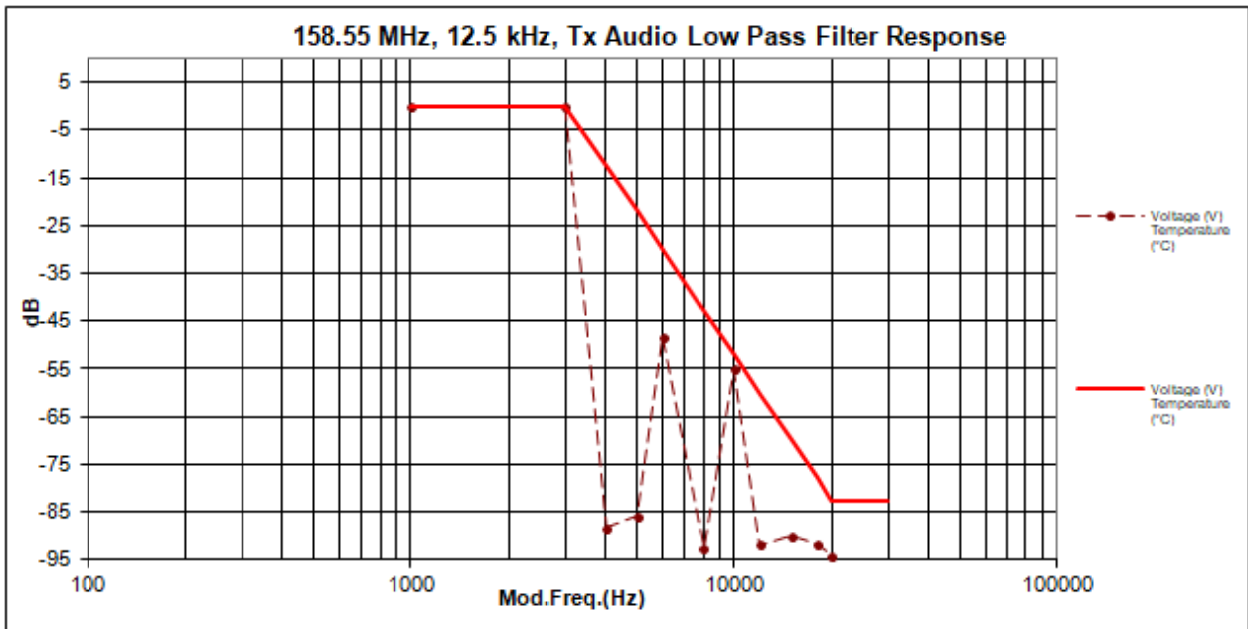
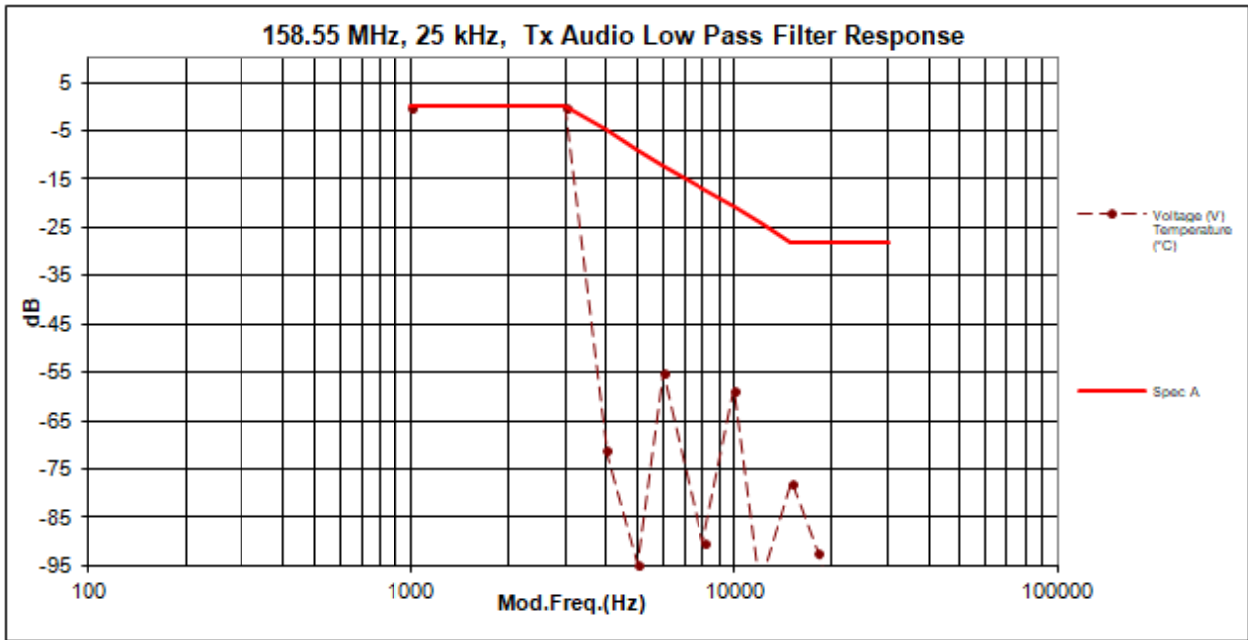

6.4.3. Test Limit

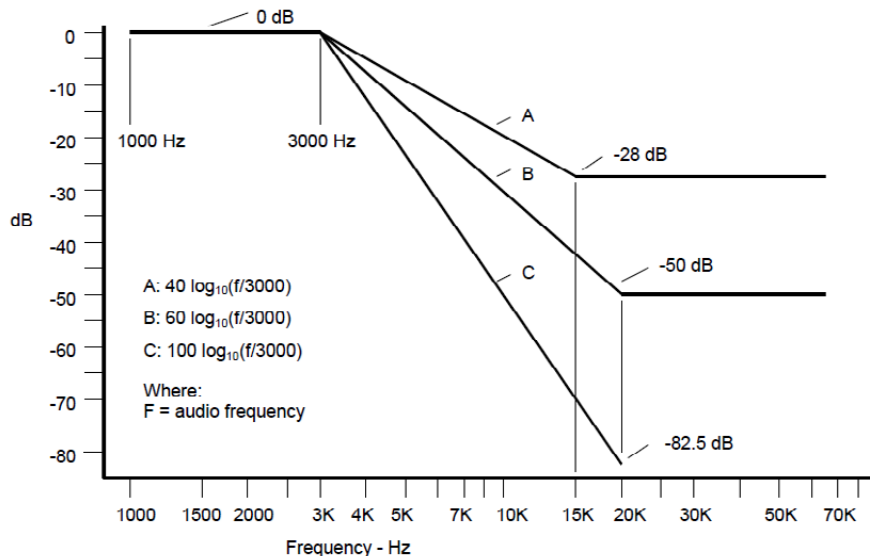

For audio frequencies above 3000 Hz, the audio response of the post limiter low-pass filter shall meet or exceed the following requirements:

- a) For equipment operating on 20, 25 or 30 kHz channel bandwidth in the 25 MHz to 174 MHz range:

At frequencies from 3000 Hz through 15,000 Hz the attenuation shall be greater than the attenuation at 1000 Hz by at least: $40 \log_{10}(f/3000)$ dB

where: f is the audio frequency in Hz.

At frequencies above 15,000 Hz, the attenuation shall be greater than the attenuation at 1000 Hz, by at least: 28 dB.

- b) For equipment operating with 25 kHz bandwidth channels between 406 and 512 MHz through 896 MHz, and between 929 MHz through 930 MHz:

At frequencies from 3000 Hz through 20,000 Hz, the attenuation shall be greater than the attenuation at 1000 Hz by at least: $60 \log_{10}(f/3000)$ dB

where: f is the audio frequency in Hz.

At frequencies above 20,000 Hz the attenuation shall be greater than the attenuation at 1000 Hz by at least: 50 dB.

- c) For equipment operating on channels between 896 MHz through 901 MHz, between 935 MHz through 940 MHz, and 12.5 or 15 kHz spaced channels in the frequency range 138-174 MHz and 406-512 MHz.

At frequencies from 3000 Hz through 20,000 Hz the attenuation shall be greater than the attenuation at 1000 Hz by at least: $100 \log_{10}(f/3000)$ dB

where: f is the audio frequency in Hz.

6.5. Modulation Limiting

6.5.1. Test Setup

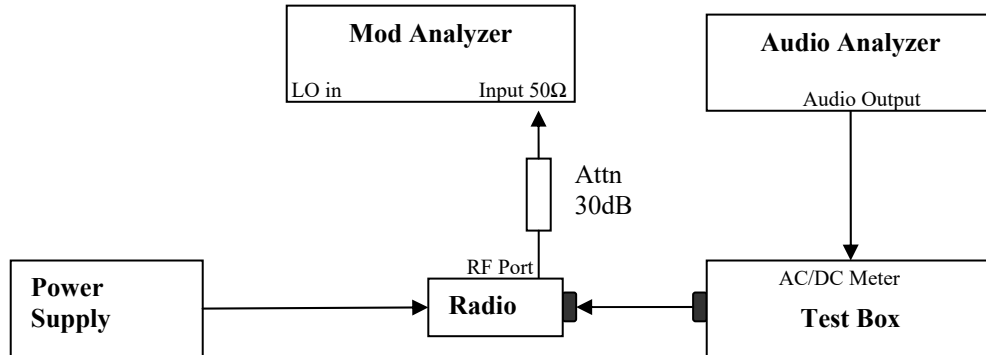

- 1) The DUT transmitter output port was connected to Modulation Analyzer.
- 2) Path loss for the measurement included.
- 3) Set the audio bandwidth filter to 15 kHz.
- 4) Transmit the radio and set the audio analyzer to 1 kHz audio frequency and 60% of the Full rated system deviation.
- 5) Record the frequency deviation as 0dB input level at 1kHz audio frequency.
- 6) Repeat the step and record the frequency deviation from -20 dB to 20dB by 5 dB increments and different audio freq 300 Hz, 2.5 kHz and 3 kHz.

6.5.2. Test Result

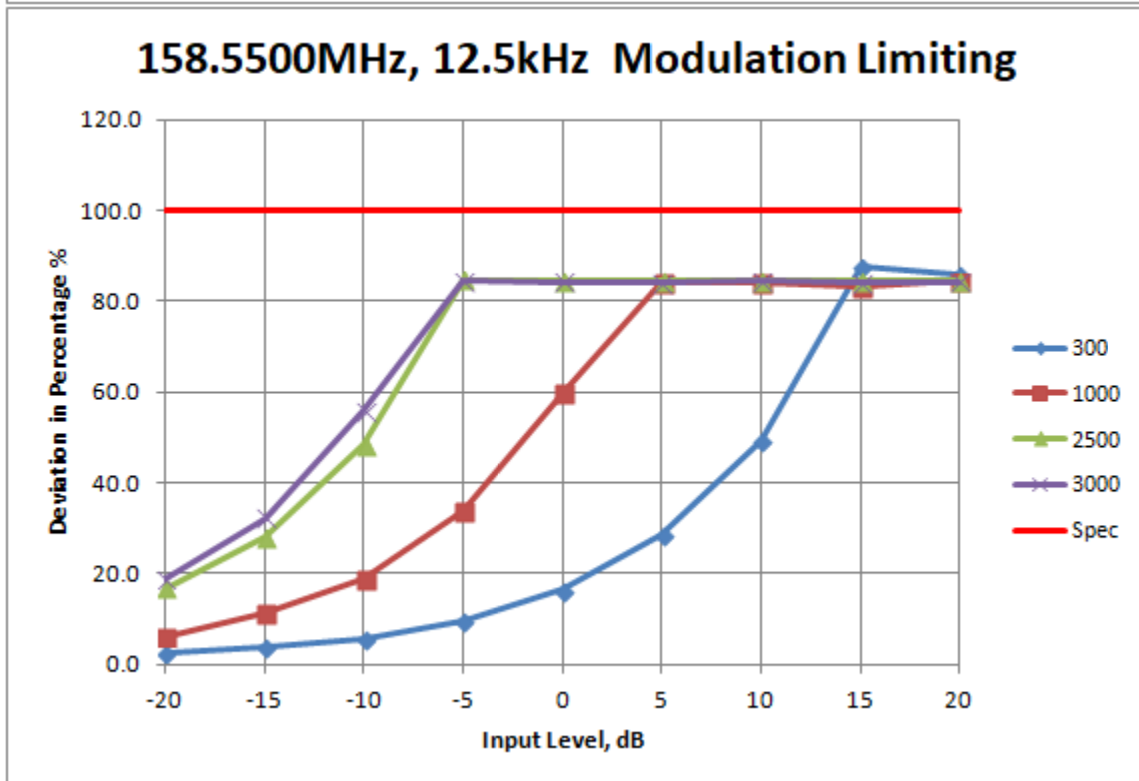
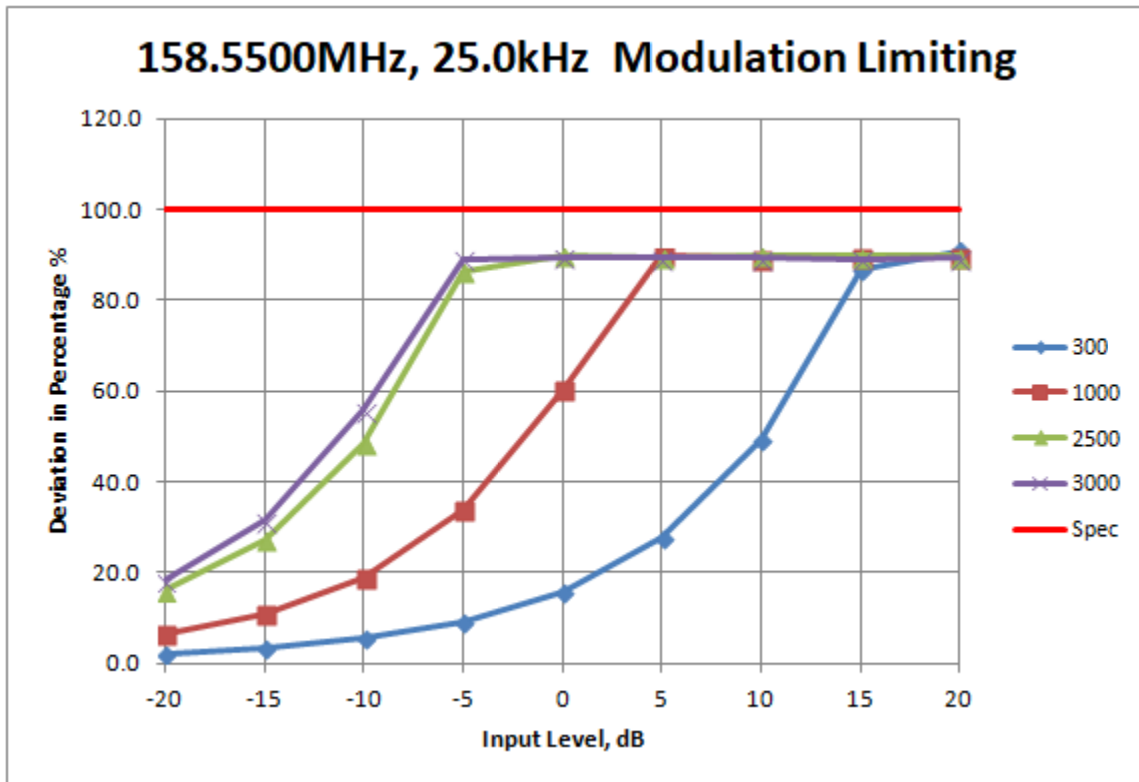

6.5.3. Test Limit

Modulation Limiting shall not exceed 100 percent.

6.6. Occupied Bandwidth

6.6.1. Test Setup (Analog)

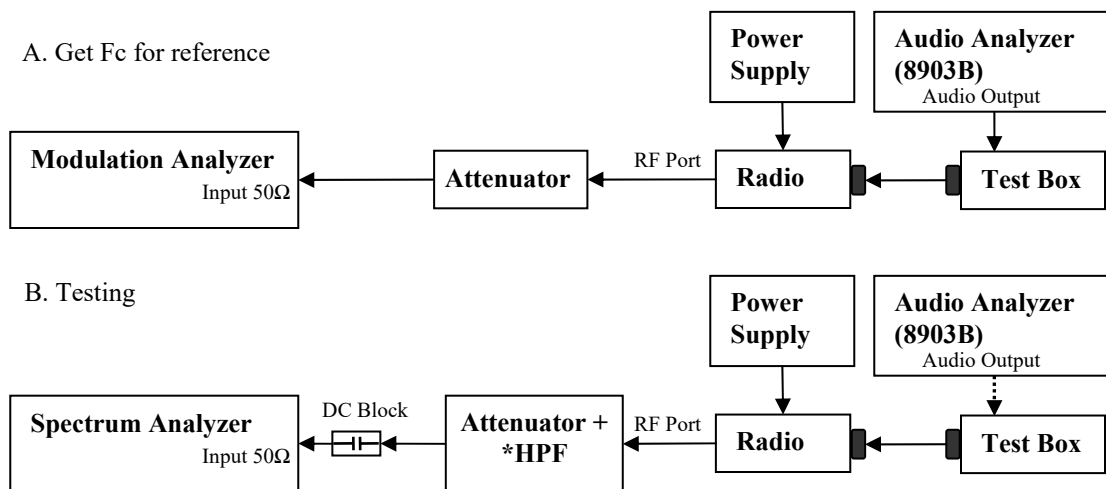

- 1) The DUT transmitter output port was connected to Modulation Analyzer.
- 2) Set the audio bandwidth filter to 15 kHz low pass filter and 50 kHz high pass filter.
- 3) Transmit the radio and set the audio analyzer to 2.5 kHz audio frequency and 50% of the rated deviation. Up the amplitude by 16 dB. Dekey the DUT.
- 4) Path loss for the measurement included.
- 5) Select the Occupied Bandwidth measurement for 99% Emissions Bandwidth Measurement.
- 6) Key in the Fc and Resolution Bandwidth (1 ~ 5 % of emission designator).
- 7) Transmit the DUT and record the occupied Bandwidth frequency.
- 8) Preset the spectrum analyzer for sideband spectrum measurement.
- 9) Set the span and Resolution Bandwidth (according to FCC/ ISED standard).
- 10) Save the screen shot as modulated signal
- 11) Remove the audio tone from audio analyzer to capture unmodulated signal.

* Only HPF added for Mask 80.211 measurement with attenuator.

6.6.2. Test Result (Analog)

Standard Audio Modulation (12.5 kHz Channelization, Analog Voice):

Emission Designator 11K0F3E

In this case, the maximum modulating frequency is 3.0 kHz with a 2.5 kHz deviation.

$$BW = 2(M+D) = 2*(3.0 \text{ kHz} + 2.5 \text{ kHz}) = 11 \text{ kHz} \Rightarrow 11K0$$

F3E portion of the designator indicates voice.

Therefore, the entire designator for 12.5 kHz channelization analog voice is 11K0F3E.

Standard Audio Modulation (25 kHz Channelization, Analog Voice):

Emission Designator 16K0F3E

In this case, the maximum modulating frequency is 3.0 kHz with a 2.5 kHz deviation.

$$BW = 2(M+D) = 2*(3.0 \text{ kHz} + 5 \text{ kHz}) = 16 \text{ kHz} \Rightarrow 16K0$$

F3E portion of the designator indicates voice.

Therefore, the entire designator for 12.5 kHz channelization analog voice is 16K0F3E.

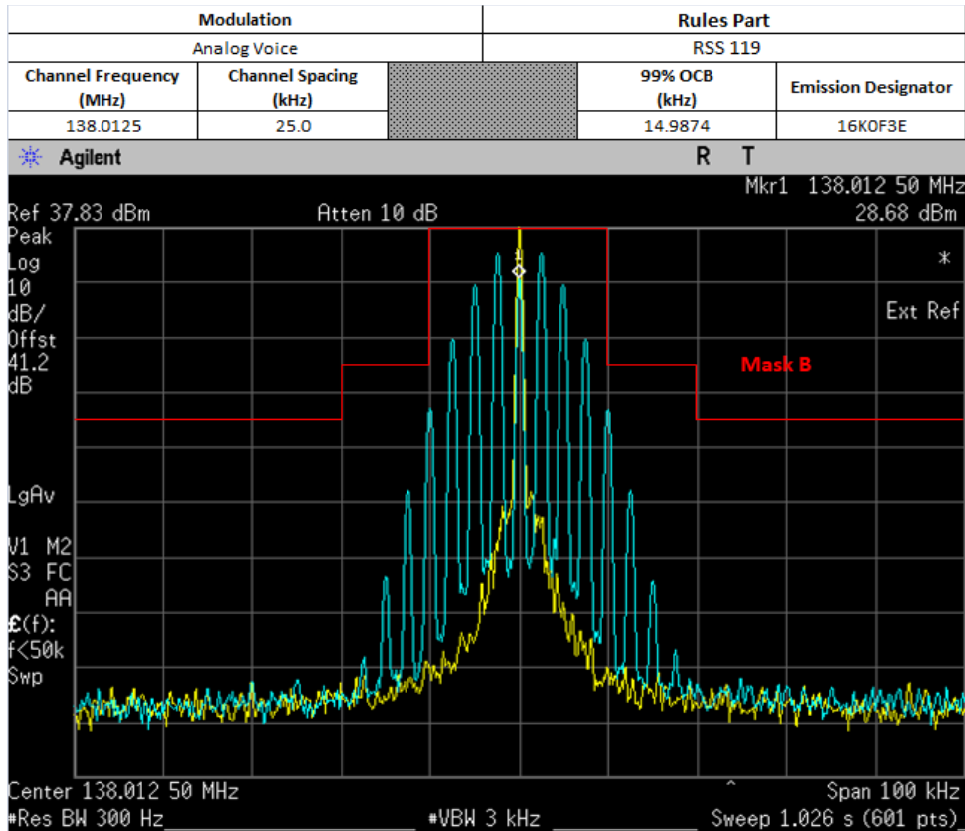

Not For FCC Review

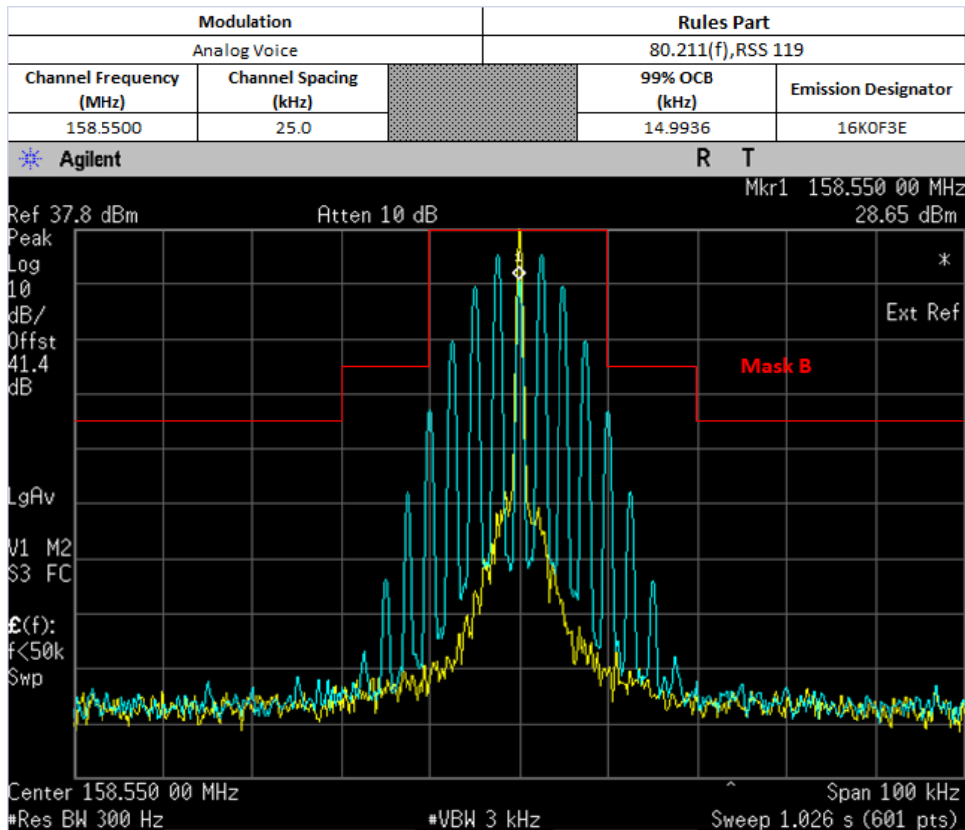

For Part80

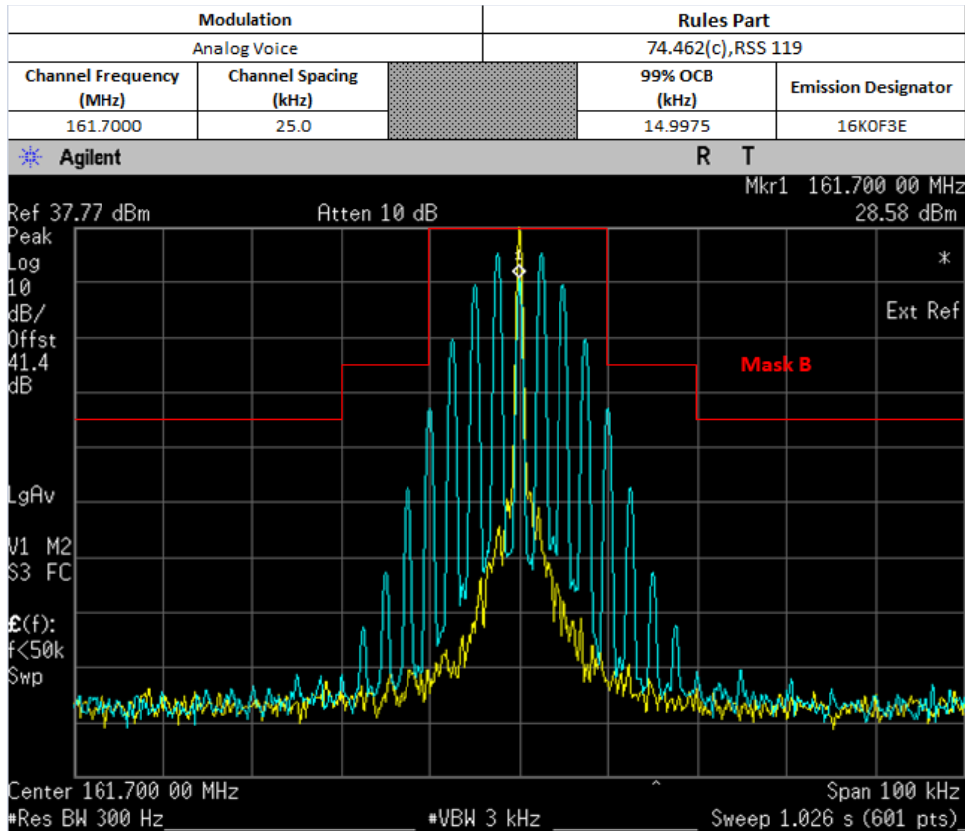

For Part74

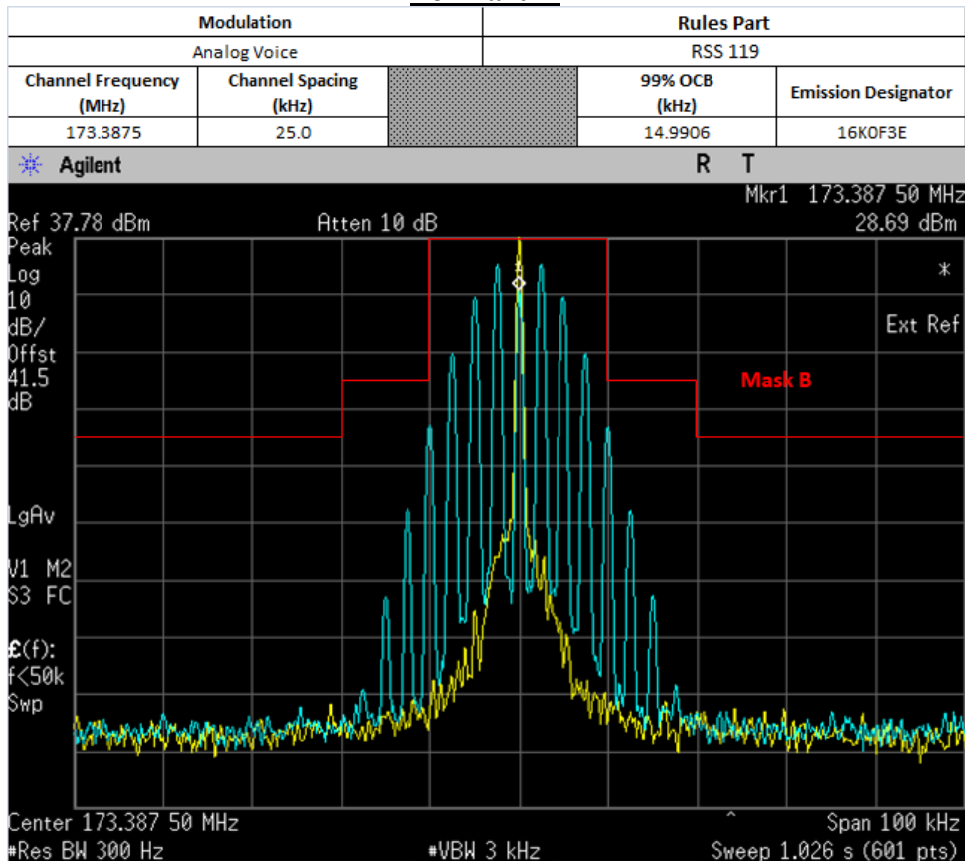

Not For FCC Review

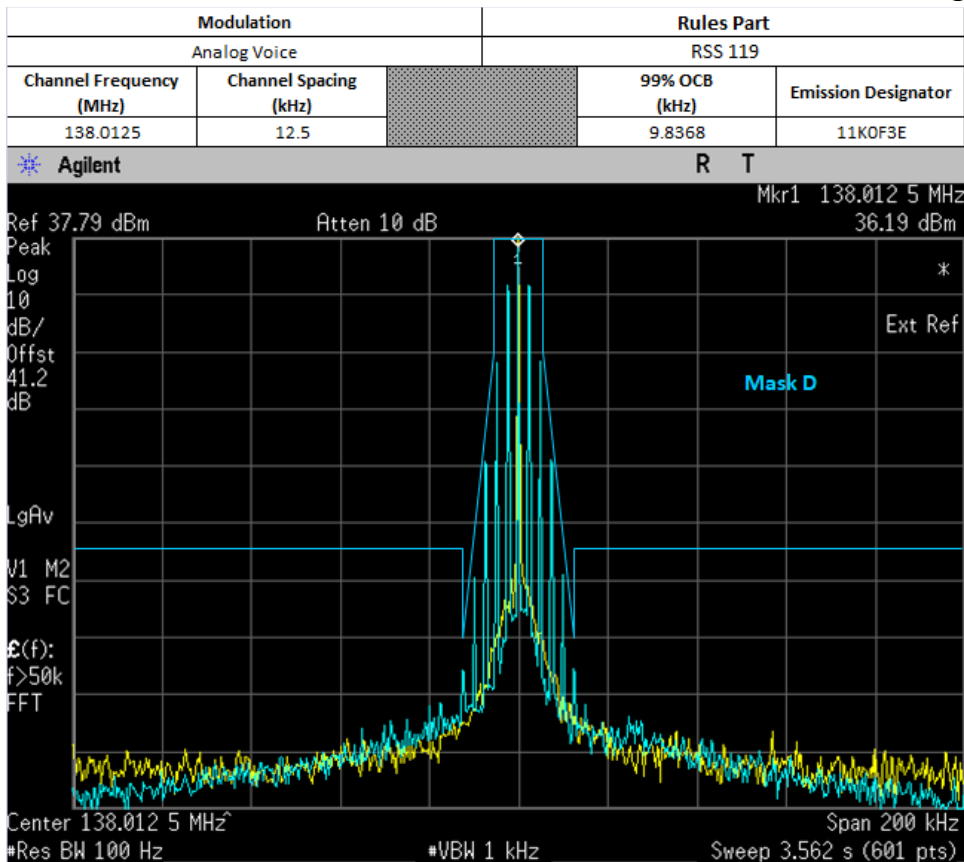

Not For FCC Review

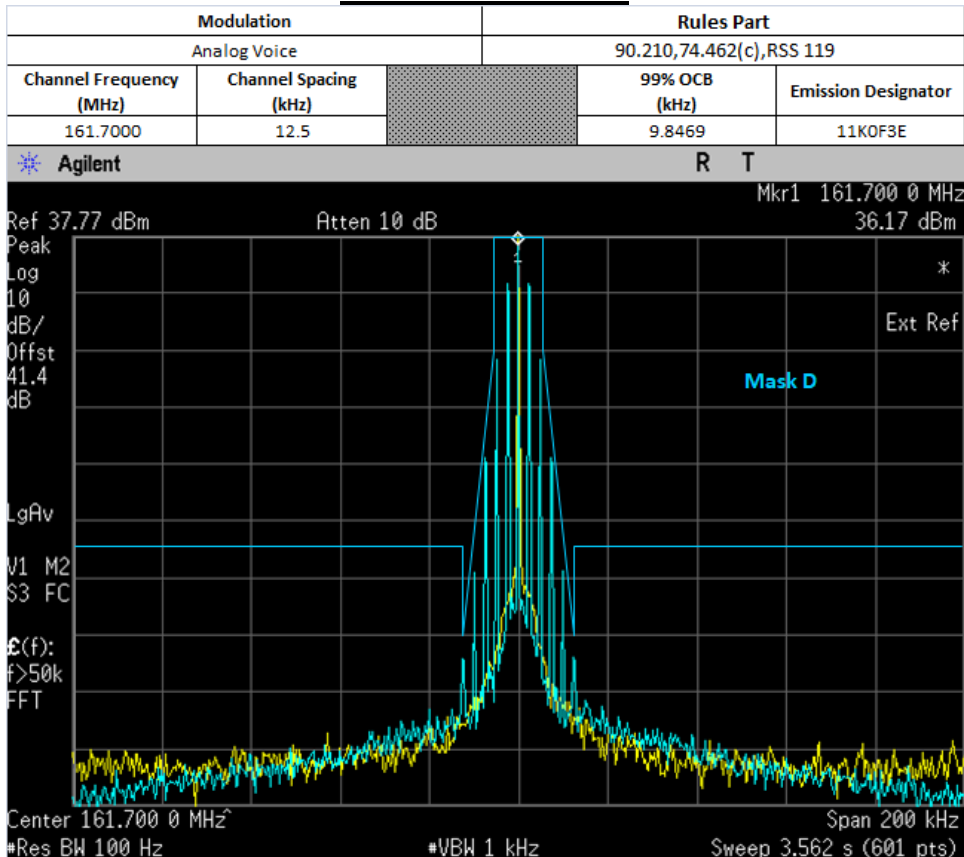

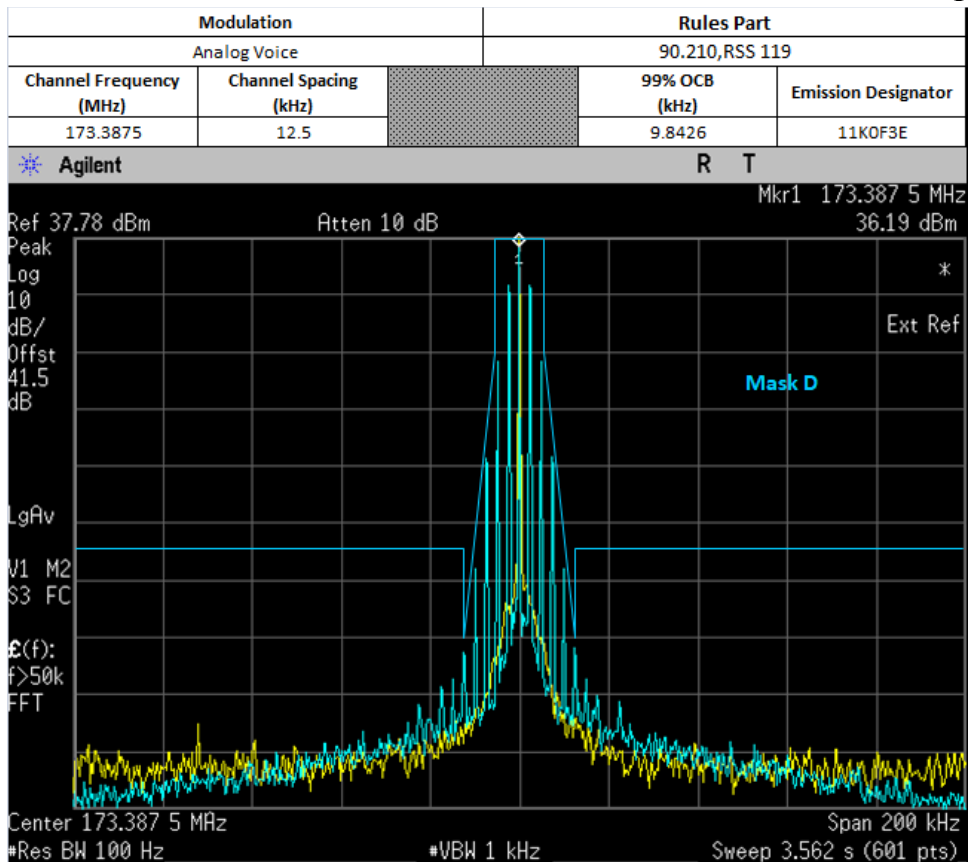

Not for FCC Review

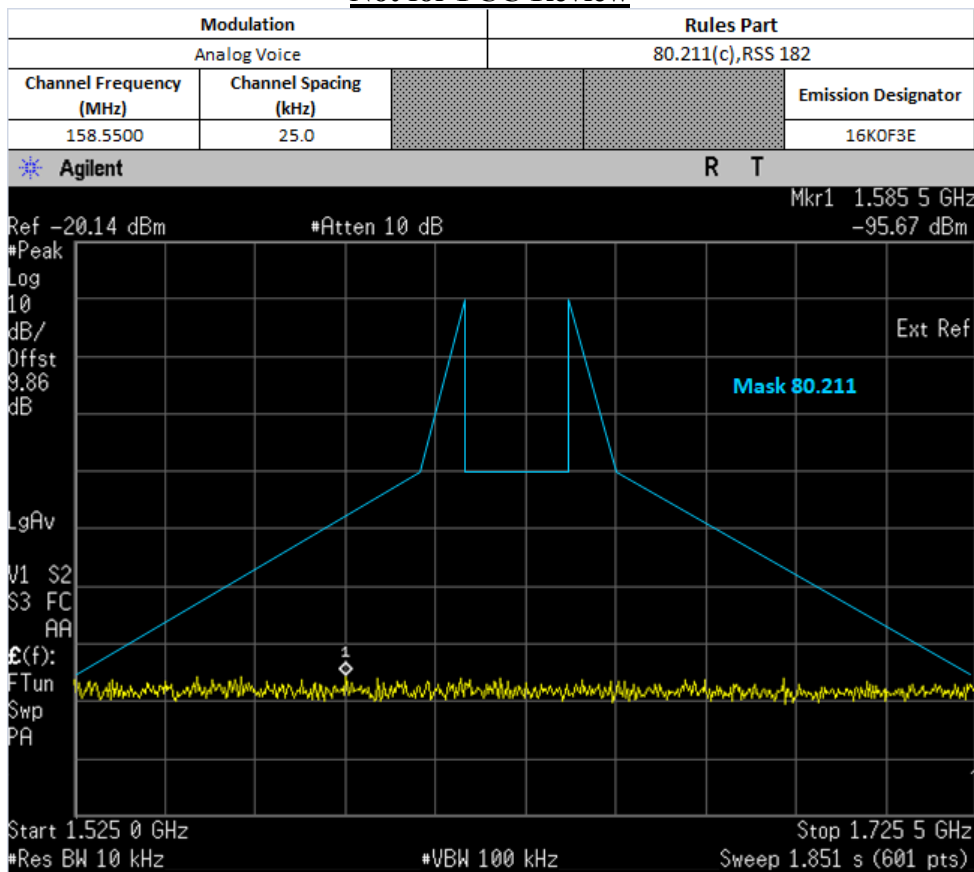

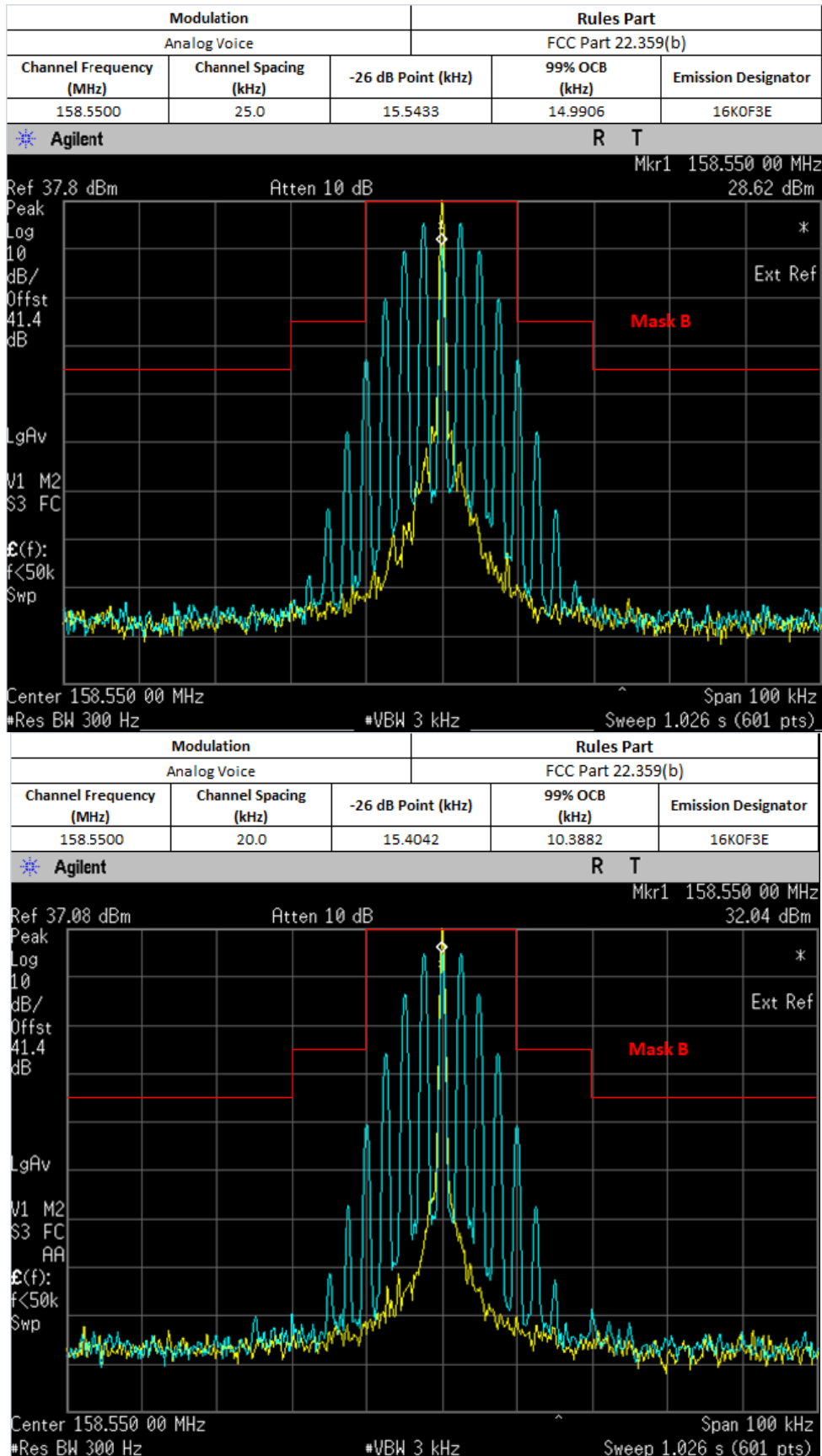

6.6.3. Test Setup (Digital)

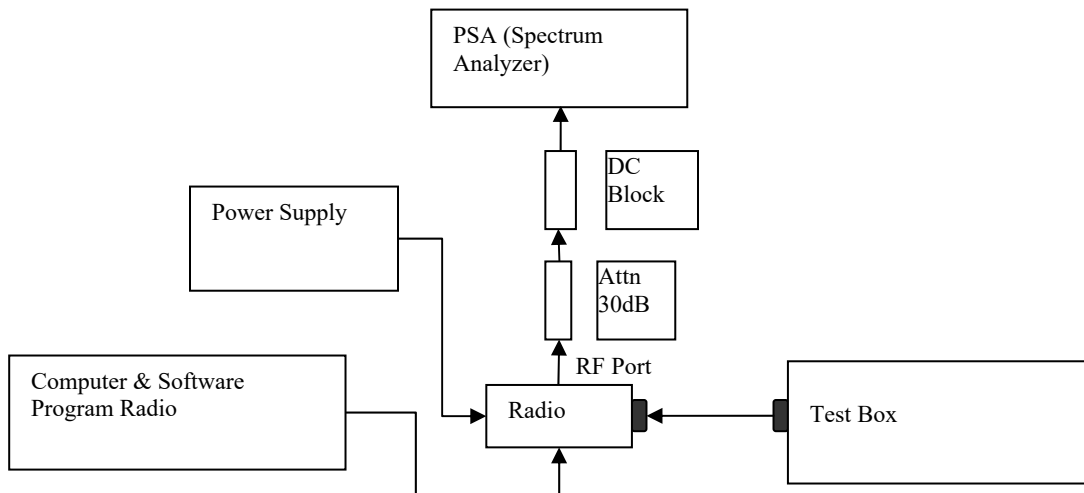

- 1) Program and set radio to operate in desire test frequency and digital mode with modulation. (*4FSK, C4FM or other digital modulation form).
- 2) Path loss for the measurement included.
- 3) Select the Occupied Bandwidth measurement for 99% Emissions Bandwidth Measurement.
- 4) Key in the Fc and Resolution Bandwidth (1 ~ 5 % of emission designator).
- 5) Transmit the DUT and record the occupied Bandwidth frequency.
- 6) Preset the spectrum analyzer for modulation emission spectrum measurement.
- 7) Set the span and Resolution Bandwidth (according to FCC/ ISED standard).
- 8) Capture the screen shot as modulated signal.

*Note:

- For Digital Modulation, 12.5 kHz Data F1D & FXD would be the same. Therefore only measurements with F1D modulation shown below.
- For Digital Modulation, 12.5 kHz Data F1E & FXE would be the same. Therefore only measurements with F1E modulation shown below.

6.6.4. Test Result (Digital)

Digital (12.5 kHz Channelization, Digital Voice/Data/Voice+Data):
 Emission Designator 7K60F1E/D/W

The 99% energy rule (title 47CFR 2.989) was used for digital mode and is more accurate than Carson's rule. It basically states that 99% of the modulation energy falls within X kHz, in this case, 7.60 kHz. Measurements were performed in accordance with TIA/EIA TSB102.CAAB Section 2.2.5.2. The emission mask was obtained from 47CFR 90.210(d).

F1E/D/W portion of the designator indicates digital voice/data/voice+data respectively.

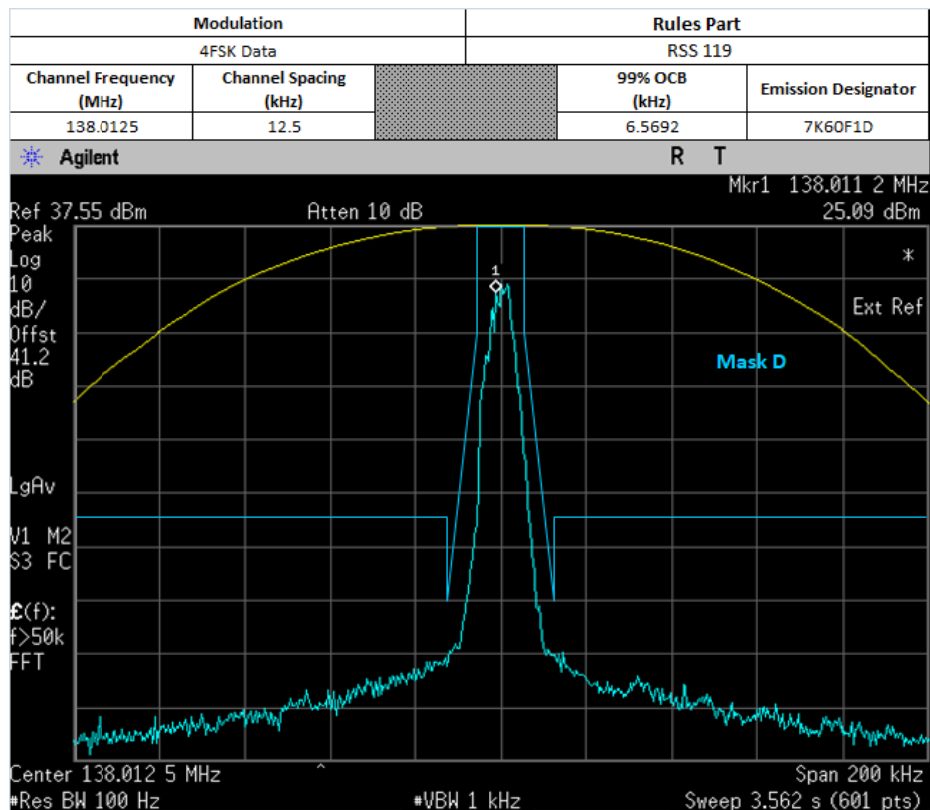

Not For FCC Review

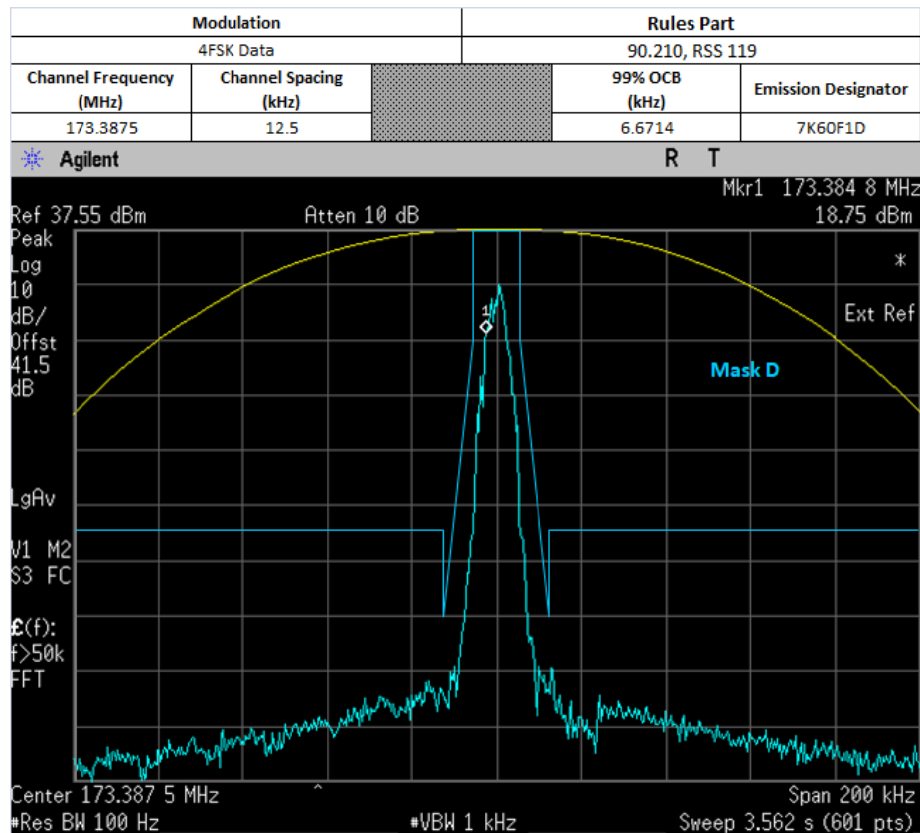
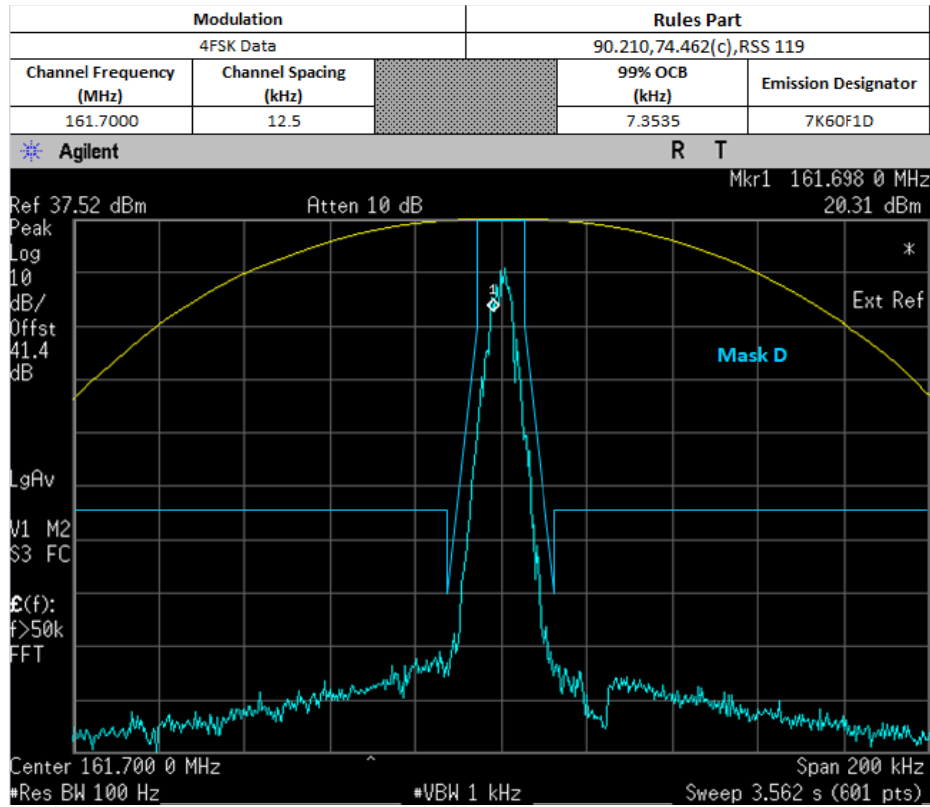

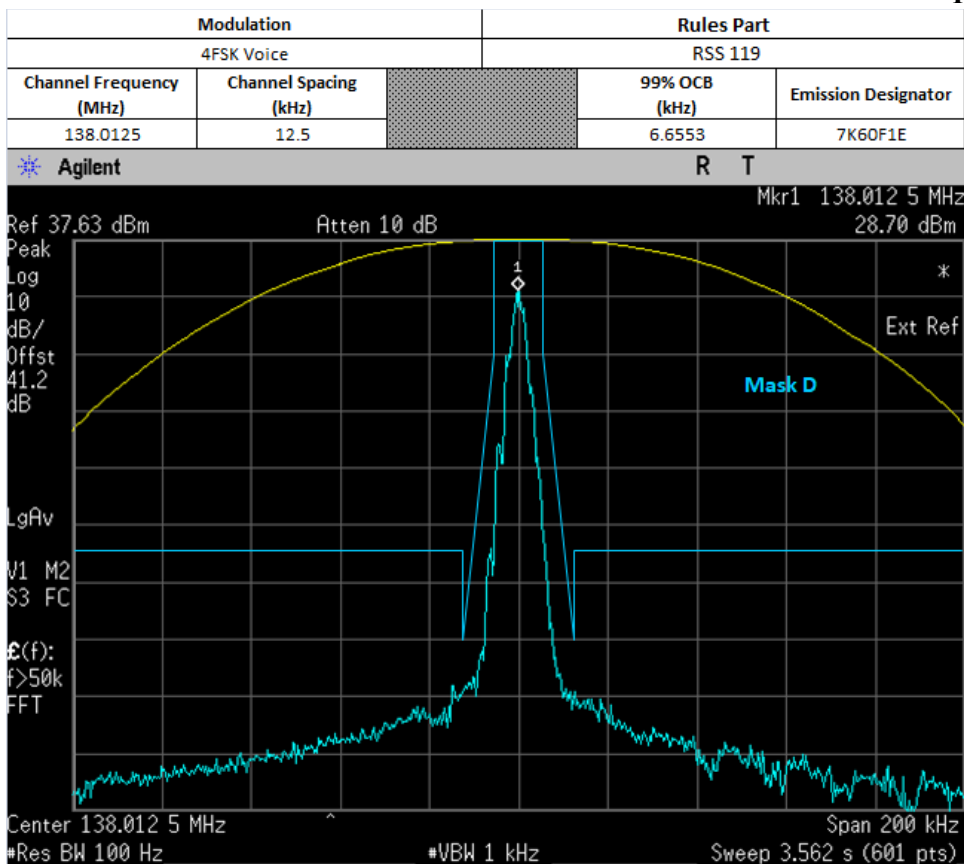

Not For FCC Review

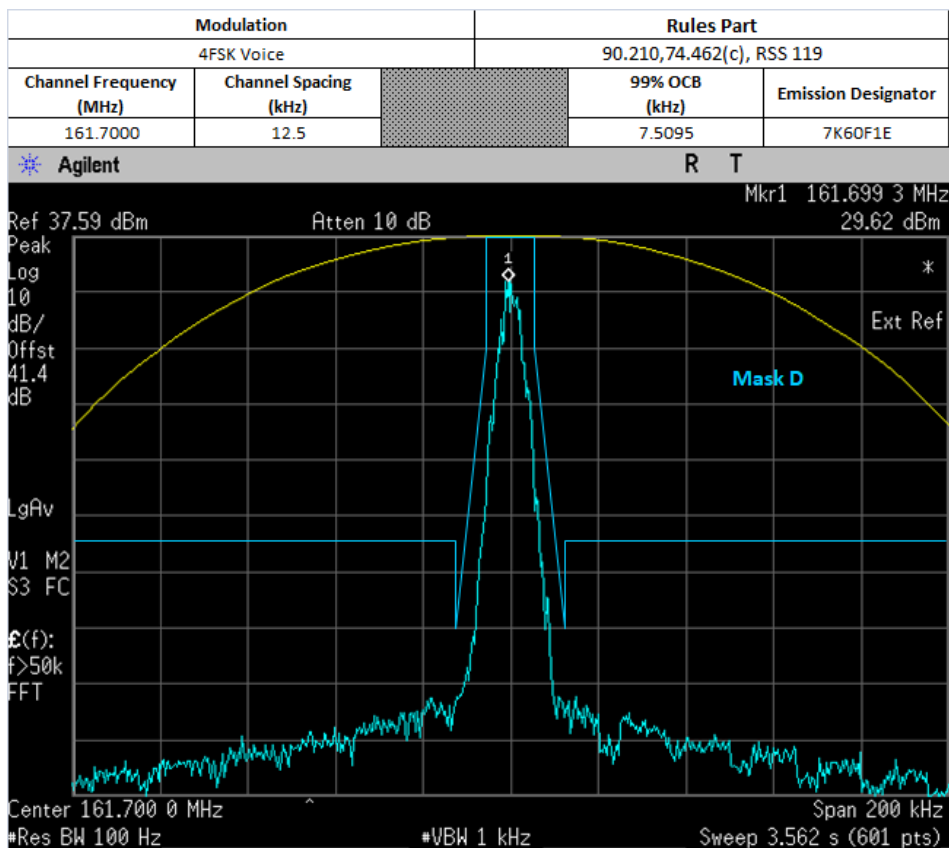

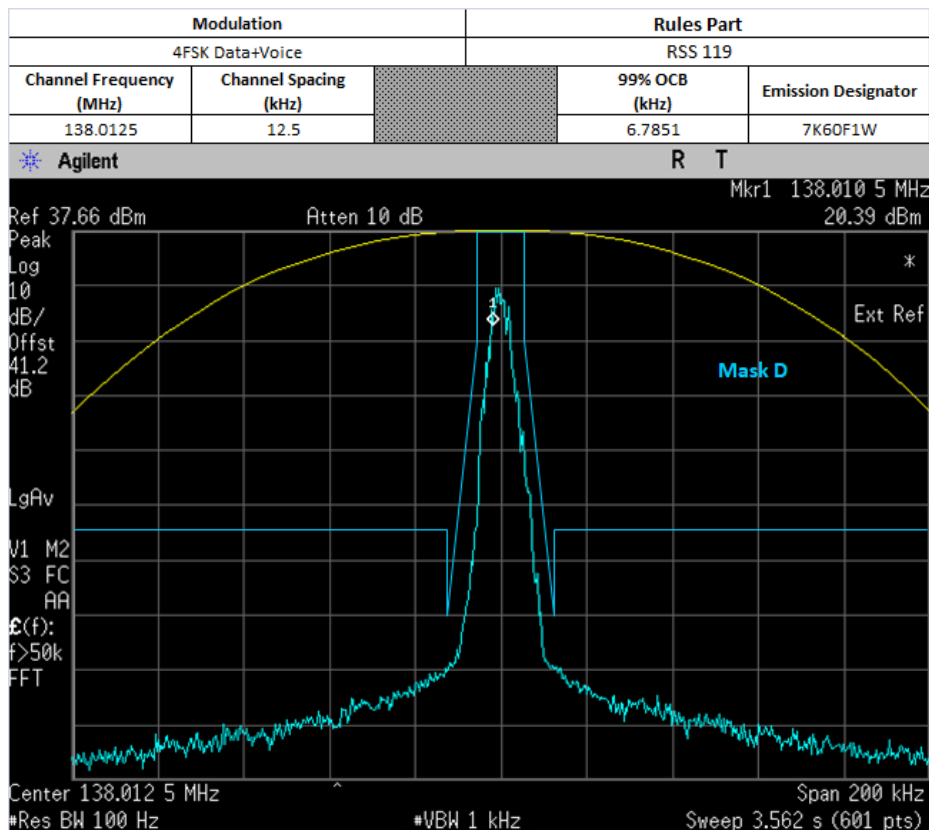
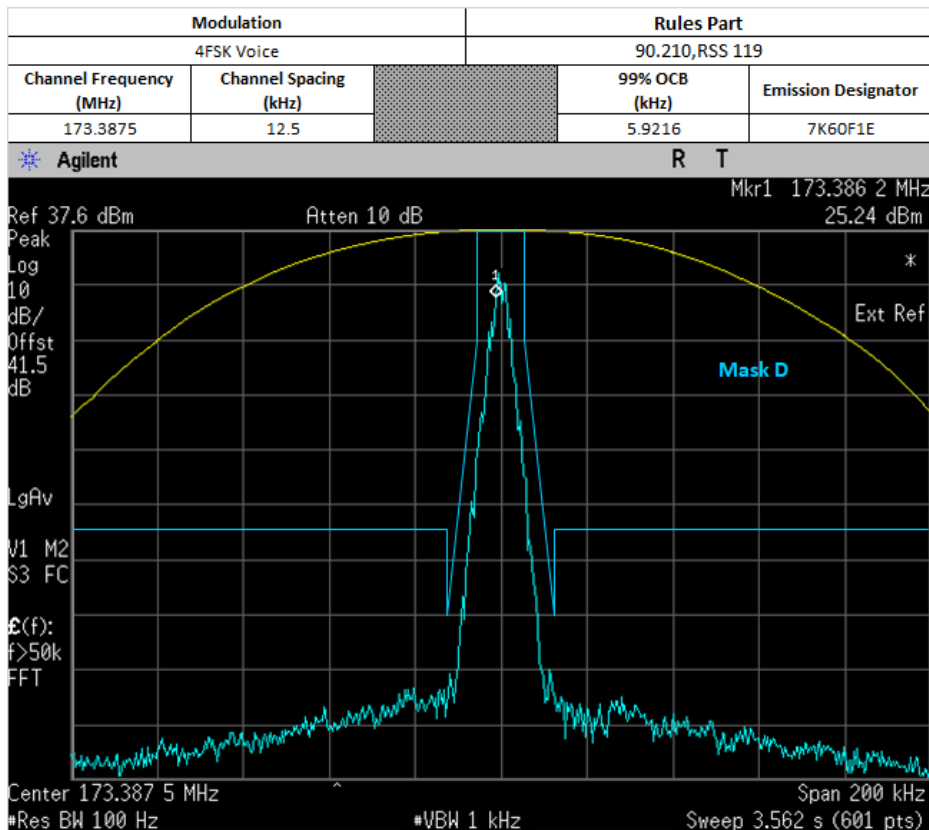

Not For FCC Review

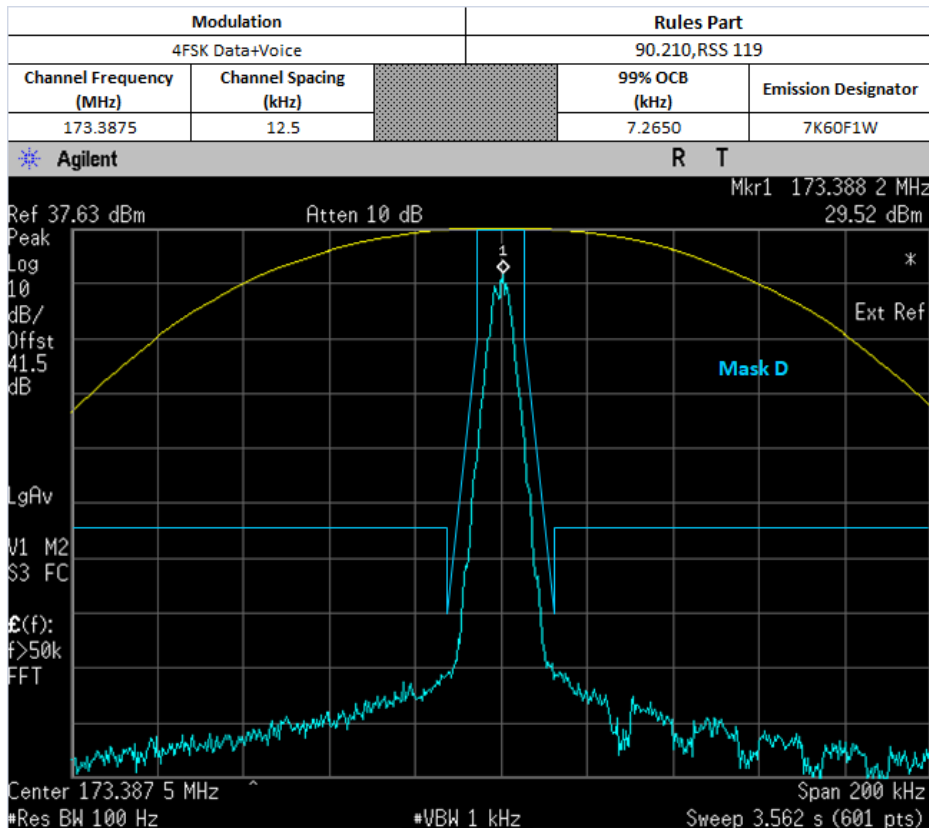
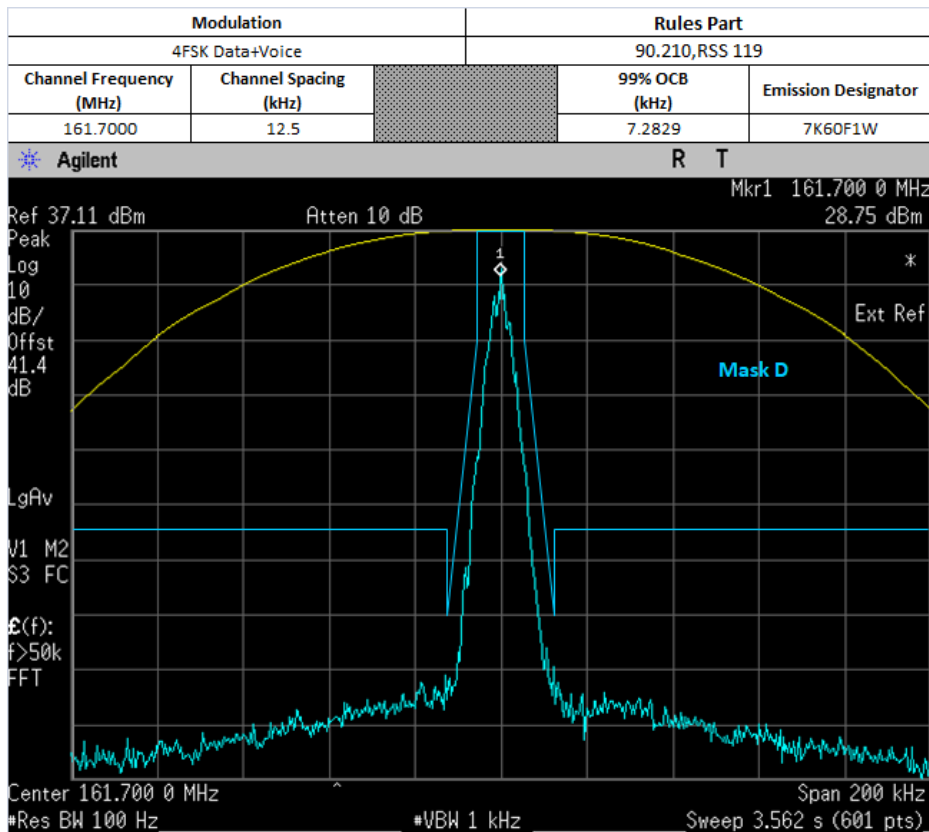

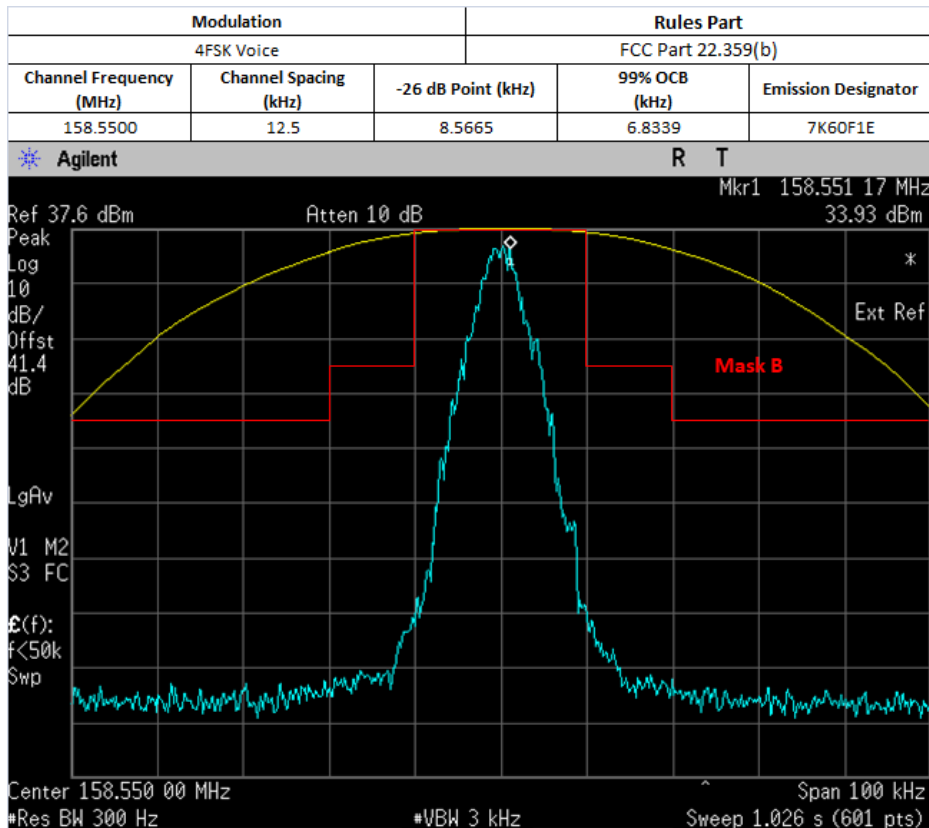
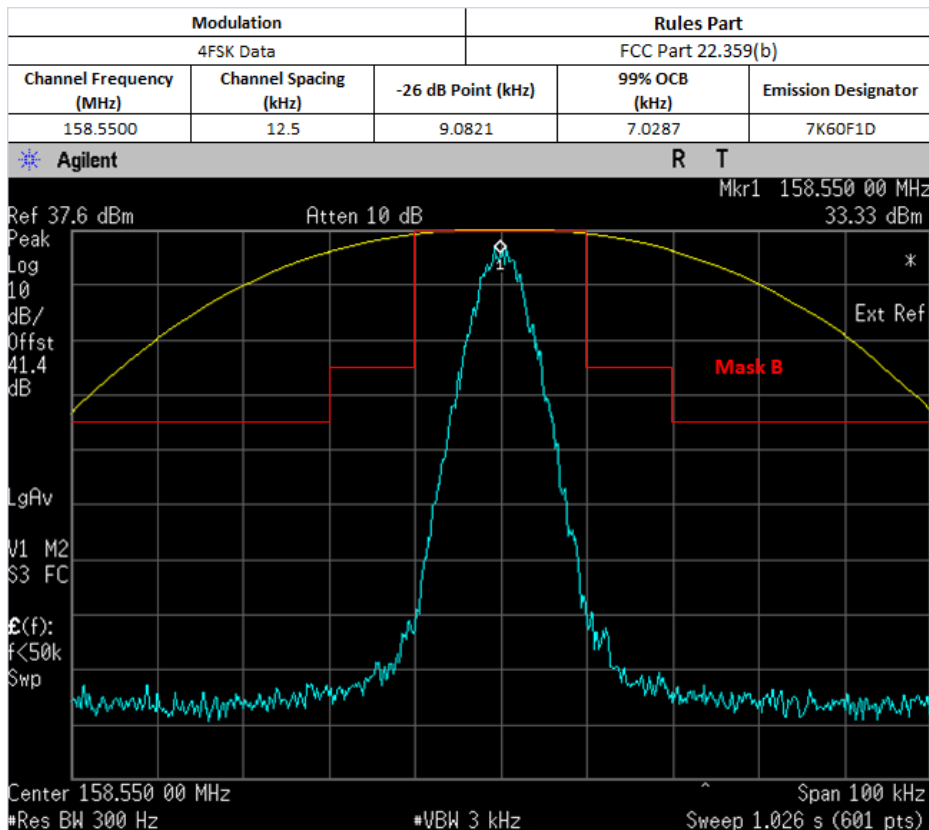

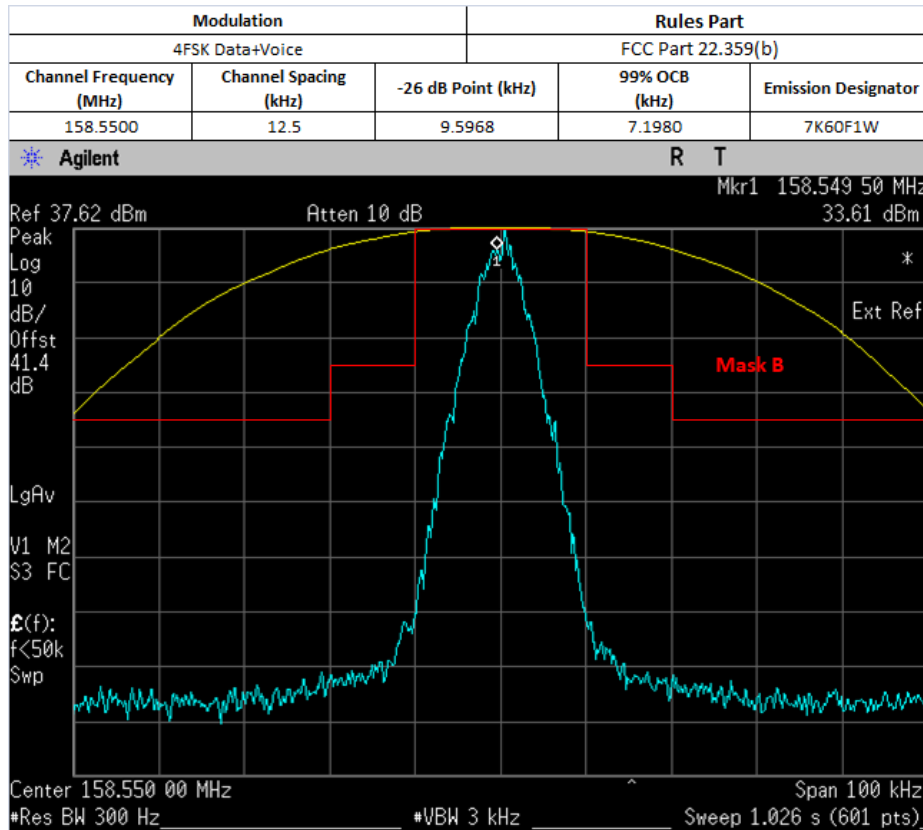

6.6.5. Test Limit

The 99% occupied bandwidth is the width of a frequency band such that, below the lower and above the upper frequency limits, the mean powers emitted are each equal to a specified percentage 0.5% of the total mean transmitted power.

6.7. Band Edge Conducted Spurious Emission (Part 22)

6.7.1. Test Setup (Analog)

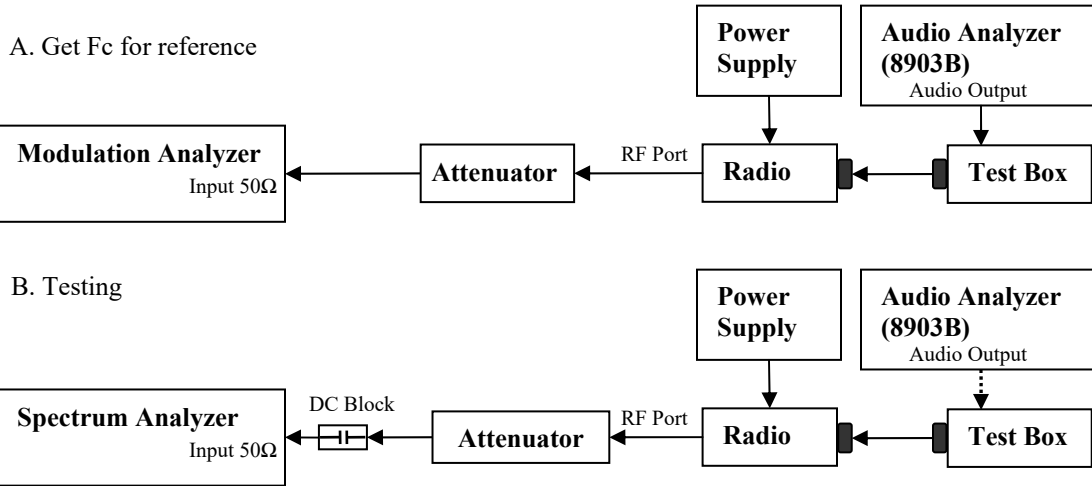

- 2) The DUT transmitter output port was connected to Modulation Analyzer.
- 3) Set the audio bandwidth filter to 15 kHz low pass filter and 50 kHz high pass filter.
- 4) Transmit the radio and set the audio analyzer to 2.5 kHz audio frequency and 50% of the rated deviation. Up the amplitude by 16 dB. Dekey the DUT.
- 5) Path loss for the measurement included.
- 6) Select the Occupied Bandwidth measurement for 99% and 26dB Emissions Bandwidth Measurement.
- 7) Key in the Fc and Resolution Bandwidth.
- 8) Transmit the DUT and record the occupied Bandwidth frequencies.
- 9) Preset the spectrum analyzer for band edge measurement.
- 10) The band edges of lowest and highest channels were measured.
- 11) Key in the Lowest and highest channel frequency, span is 60 kHz and Resolution Bandwidth is at least 1% of Emission Bandwidth.
- 12) Save the screen shot as modulated signal.
- 13) Remove the audio tone from audio analyzer to capture unmodulated signal.

*Note:

- For emission designator ending with F3E, 16K0F3E is the worst case and therefore only 16K0F3E will be shown.

6.7.2. Test Result (Analog)

MAX PWR

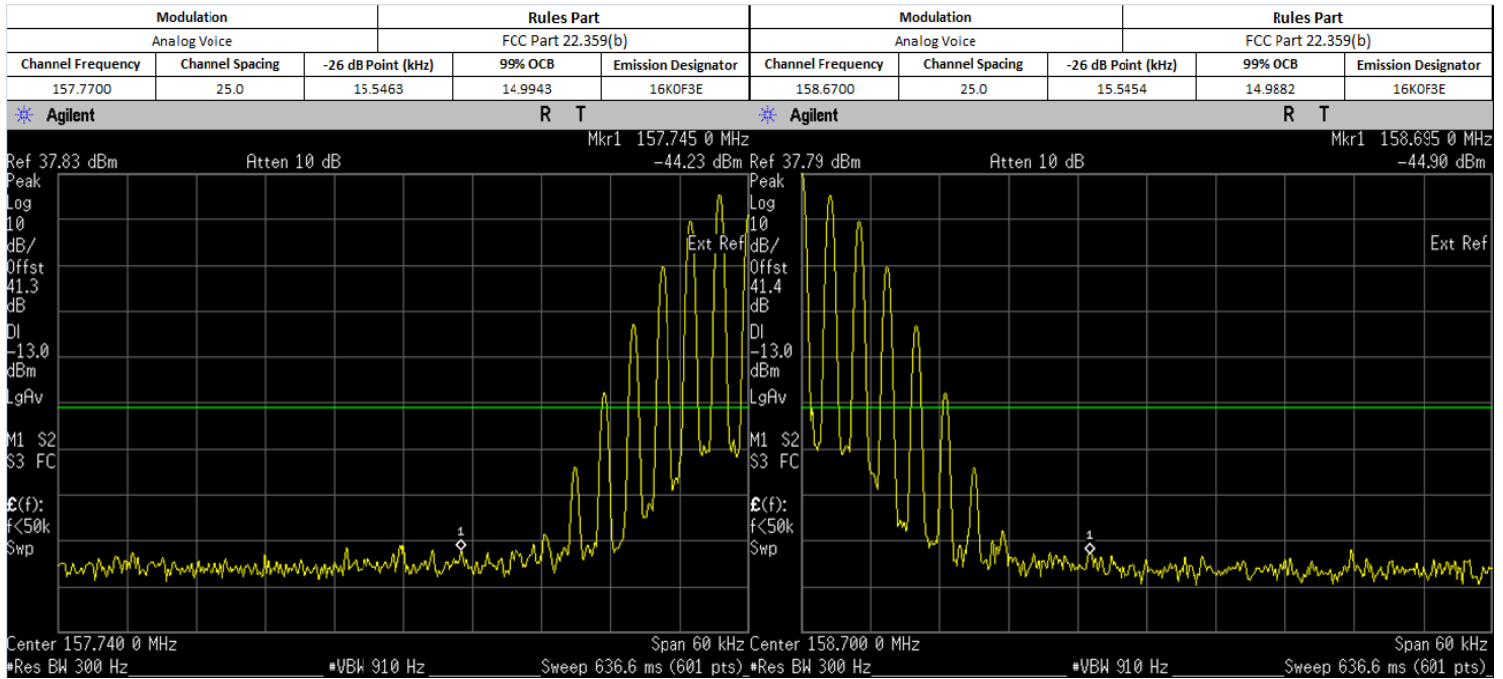

LOW PWR

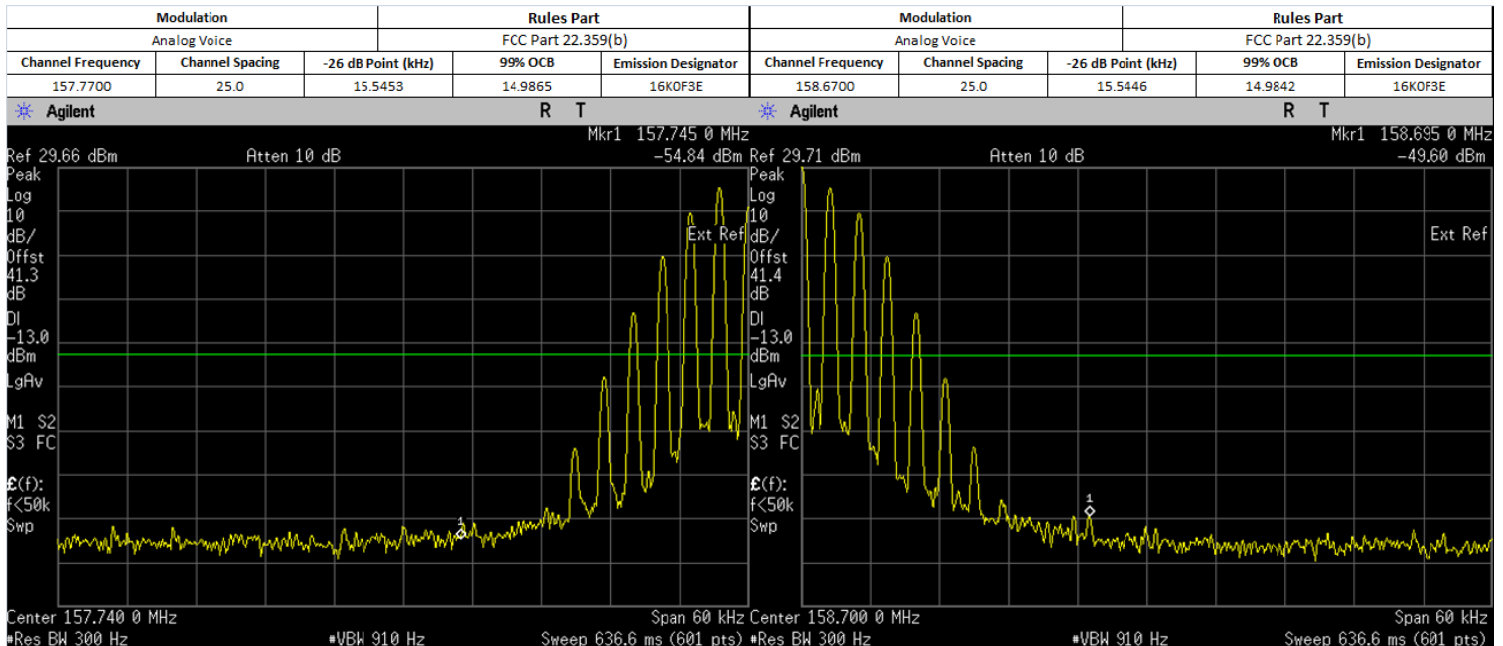

6.7.3. Test Setup (Digital)

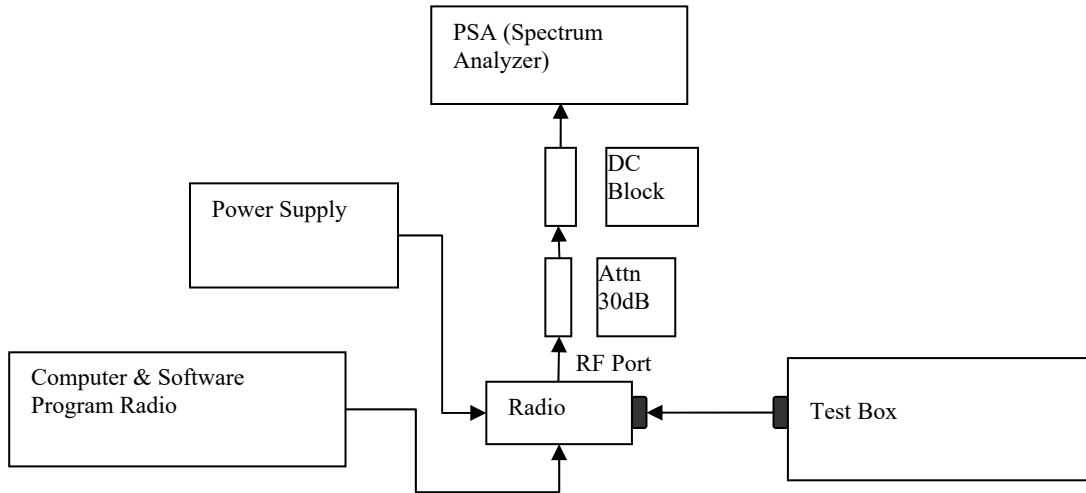

- 1) Program and set radio to operate in desire test frequency and digital mode with modulation. (*4FSK, C4FM or other digital modulation form).
- 2) Path loss for the measurement included.
- 3) Select the Occupied Bandwidth measurement for 99% and 26dB Emissions Bandwidth Measurement.
- 4) Key in the Fc and Resolution Bandwidth.
- 5) Transmit radio record the occupied Bandwidth frequencies.
- 6) Preset the spectrum analyzer for band edge measurement.
- 7) Key in the lowest and highest channels frequency, span is 60 kHz and Resolution Bandwidth is at least 1% of Emission Bandwidth.
- 8) Save the screen shot.

*Note:

- For Digital Modulation, 12.5 kHz Data F1D & FXD would be the same. Therefore only measurements with F1D modulation shown below.
- For Digital Modulation, 12.5 kHz Data F1E & FXE would be the same. Therefore only measurements with F1E modulation shown below.

6.7.4. Test Result (Digital)

MAX PWR

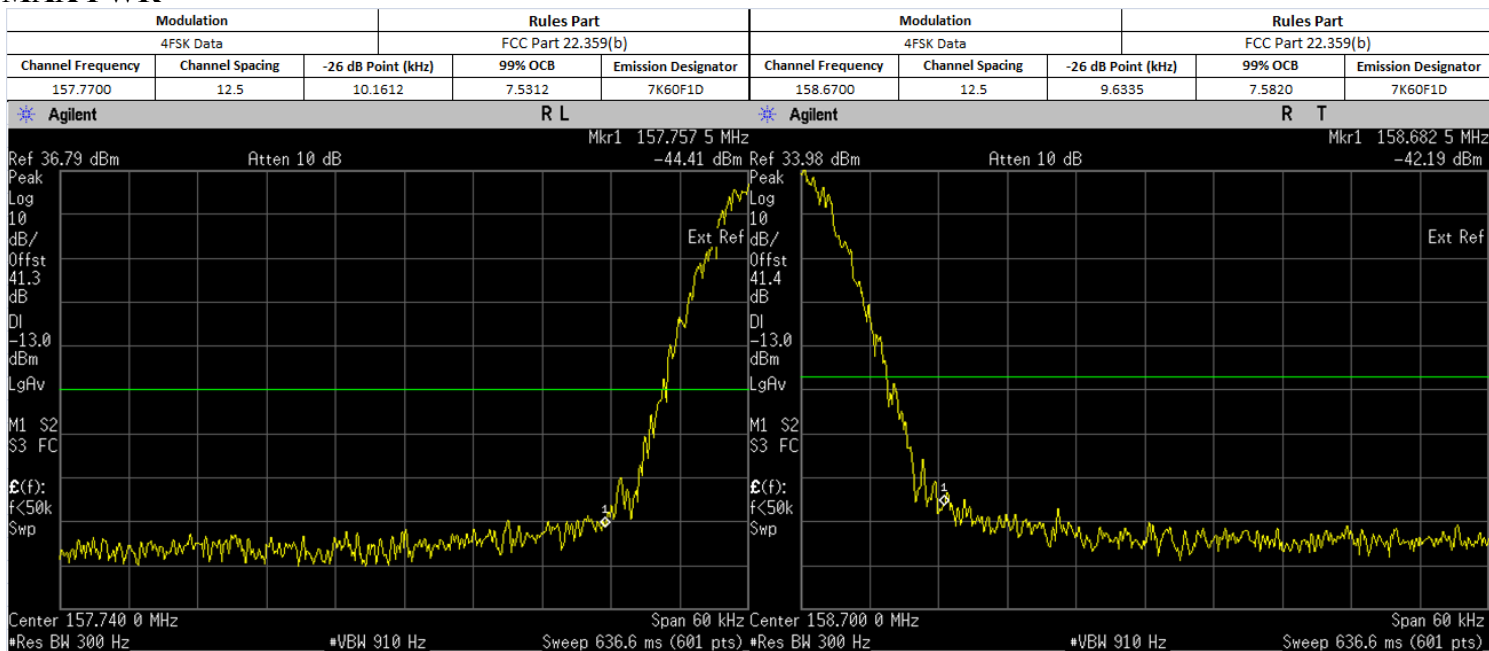

LOW PWR

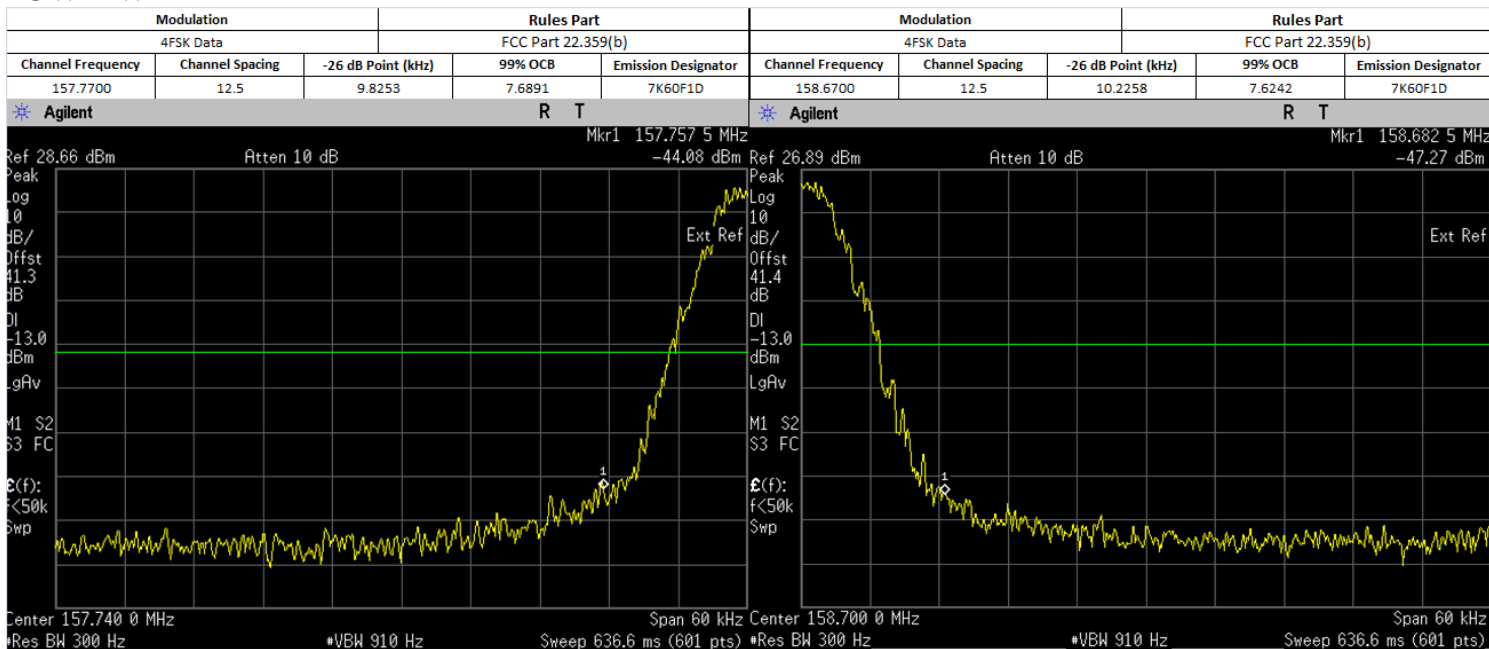

6.7.5. Test Limit

The power of any emission outside of the authorized operating frequency ranges must be attenuated below the transmitting power (P) by a factor of at least $43 + 10 \log(P)$ dB.

6.8. Transient Frequency Behavior

6.8.1. Test Setup

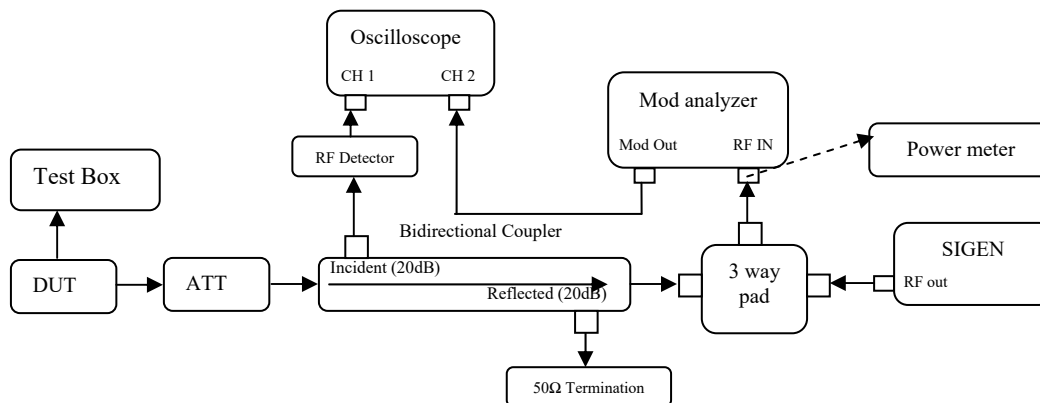

- 1) Connect the setup as figure above.
- 2) Path loss for the measurement included.
- 3) Set on Sigen with the assigned center frequency, internal 1 kHz FM tone.
FM Deviation: Analog 25kHz Channel Spacing = 25 kHz
Analog 12.5 kHz Channel Spacing = 12.5 kHz
C4FM = 12.5 kHz
- 4) Turn on 50 kHz high pass filter and 15 kHz low pass filter on modulation analyzer.
- 5) Supply sufficient attenuation ATT to provide the output power of $\leq -11\text{dBm}$ into power meter when DUT is keying up.
- 6) Note the power level on power meter and dekey the DUT.
- 7) Adjust the amplitude of the signal generator to the level power meter, maintained the amplitude throughout the rest of the measurement.
- 8) Connect the output to modulation analyzer.
- 9) Reduce 30dB attenuation and transmit the radio to get the trigger line.
- 10) Capture the screen shot for key-up (rising edge) and de-key (falling edge) mode.

6.8.2. Test Result

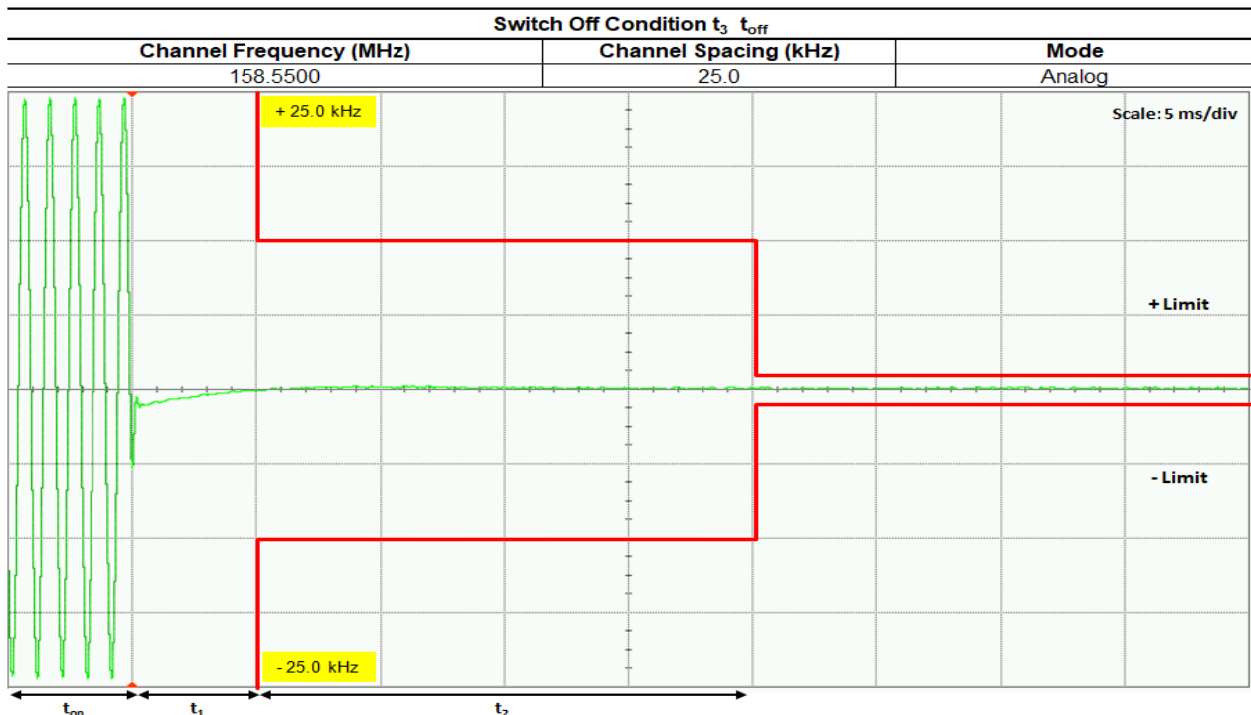
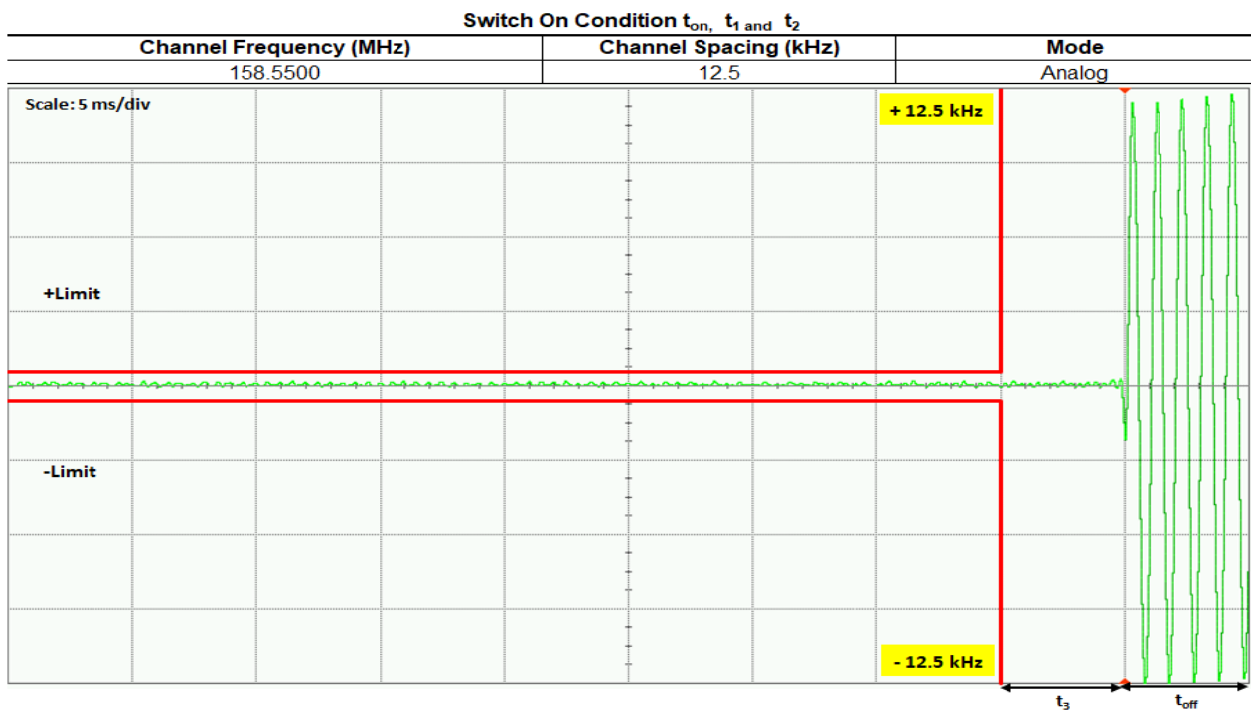

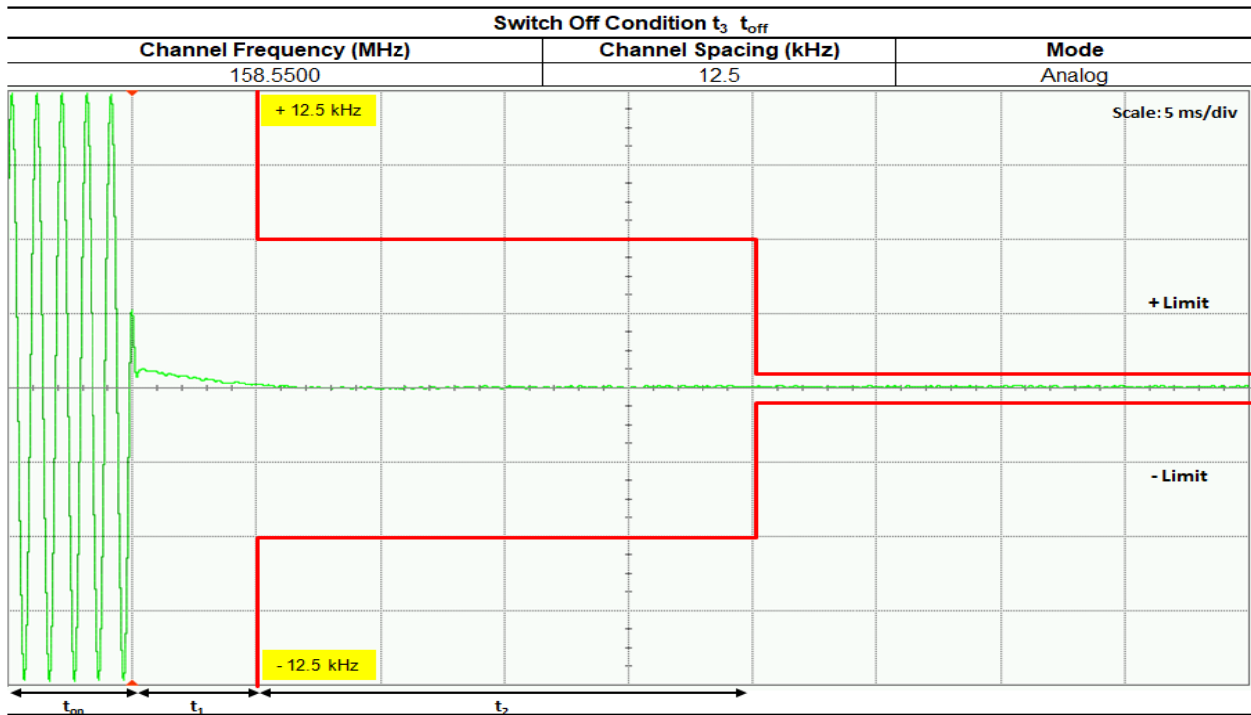
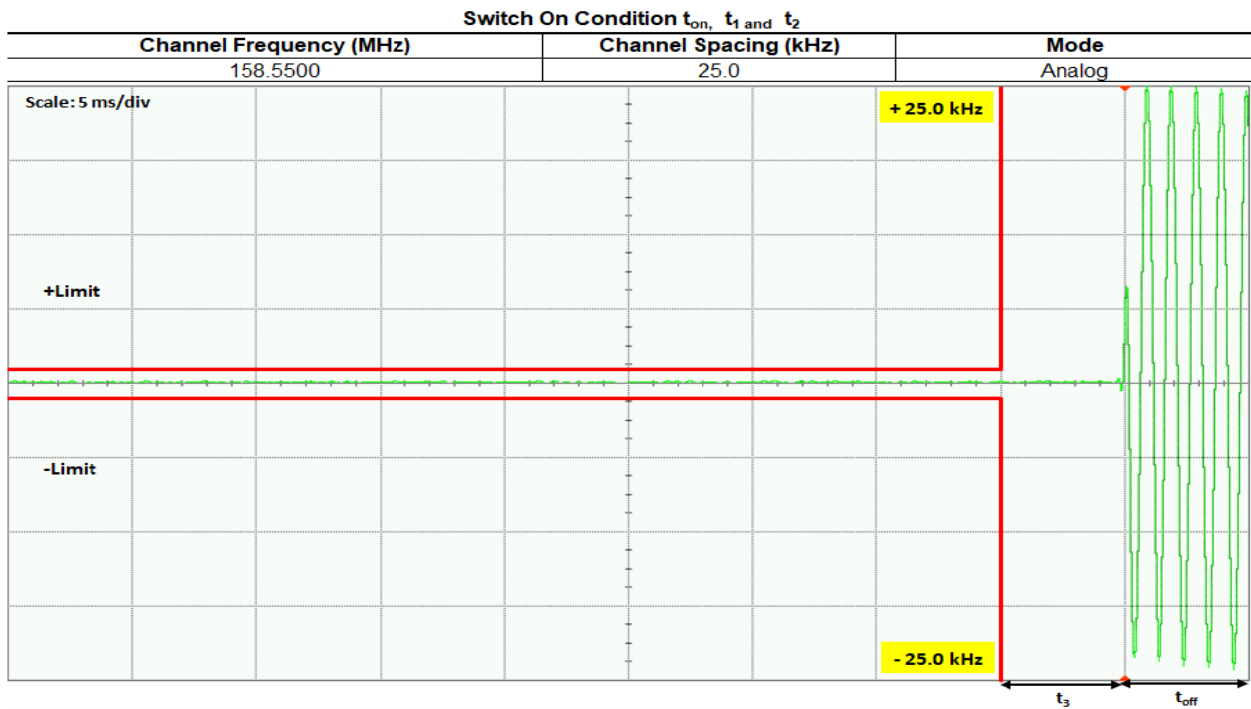

Not For FCC Review

6.8.3. Test Limit

Transmitters designed to operate in the 150-174 MHz and 421-512 MHz frequency bands must maintain transient frequencies within the maximum frequency difference limits during the time intervals indicated:

Time intervals ^{1 2}	Maximum frequency difference ³	All equipment	
		150 to 174 MHz	421 to 512 MHz
Transient Frequency Behavior for Equipment Designed to Operate on 25 kHz Channels			
t ₁ ⁴	±25.0 kHz	5.0 ms	10.0 ms
t ₂	±12.5 kHz	20.0 ms	25.0 ms
t ₃ ⁴	±25.0 kHz	5.0 ms	10.0 ms
Transient Frequency Behavior for Equipment Designed to Operate on 12.5 kHz Channels			
t ₁ ⁴	±12.5 kHz	5.0 ms	10.0 ms
t ₂	±6.25 kHz	20.0 ms	25.0 ms
t ₃ ⁴	±12.5 kHz	5.0 ms	10.0 ms
Transient Frequency Behavior for Equipment Designed to Operate on 6.25 kHz Channels			
t ₁ ⁴	±6.25 kHz	5.0 ms	10.0 ms
t ₂	±3.125 kHz	20.0 ms	25.0 ms
t ₃ ⁴	±6.25 kHz	5.0 ms	10.0 ms

¹ t_{on} is the instant when a 1 kHz test signal is completely suppressed, including any capture time due to phasing.

t₁ is the time period immediately following t_{on}.

t₂ is the time period immediately following t₁.

t₃ is the time period from the instant when the transmitter is turned off until t_{off}.

t_{off} is the instant when the 1 kHz test signal starts to rise.

² During the time from the end of t₂ to the beginning of t₃, the frequency difference must not exceed the limits specified in §90.213.

³ Difference between the actual transmitter frequency and the assigned transmitter frequency.

⁴ If the transmitter carrier output power rating is 6 watts or less, the frequency difference during this time period may exceed the maximum frequency difference for this time period.

6.9. Adjacent Channel Power

6.9.1. Test Setup (Analog)

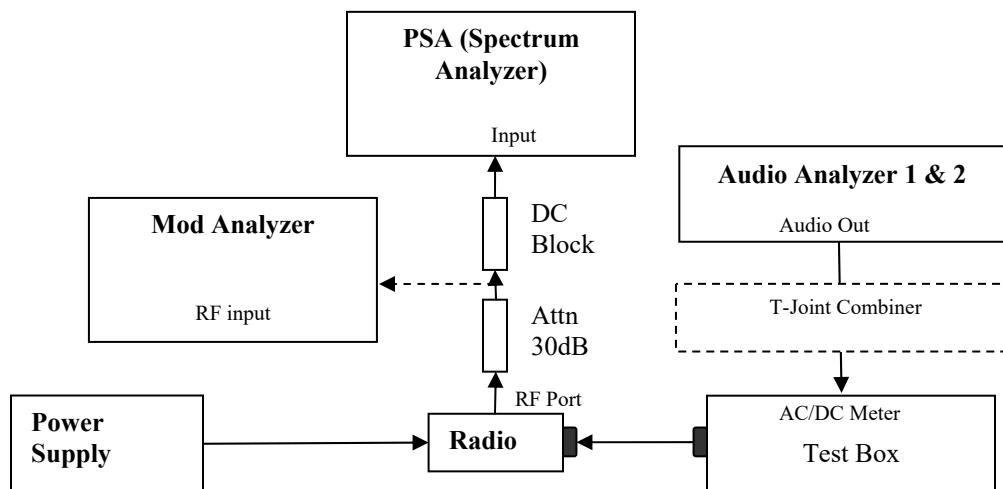

- 1) The DUT transmitter output port was connected to modulation analyzer.
- 2) Transmit the radio and turn on 1st audio analyzer with audio frequency 650Hz, 50% rated deviation, and record the amplitude value as AmpT1.
- 3) Turn off Audio analyzer 1 and turn on audio analyzer 2, set the audio frequency to 2.2 kHz and 50% deviation. Record the amplitude as AmpT2.
- 4) Turn both audio analyzers ON and up 10dB amplitude level.
- 5) Connect the output to PSA and set to assigned center frequency.
- 6) Set Span, Resolution Bandwidth and Video Bandwidth per rules part.
- 7) Transmit the radio and record the Adjacent Channel Power value in dBc.

6.9.2. Test Result

Not Applicable

6.9.3. Test Setup (Digital)

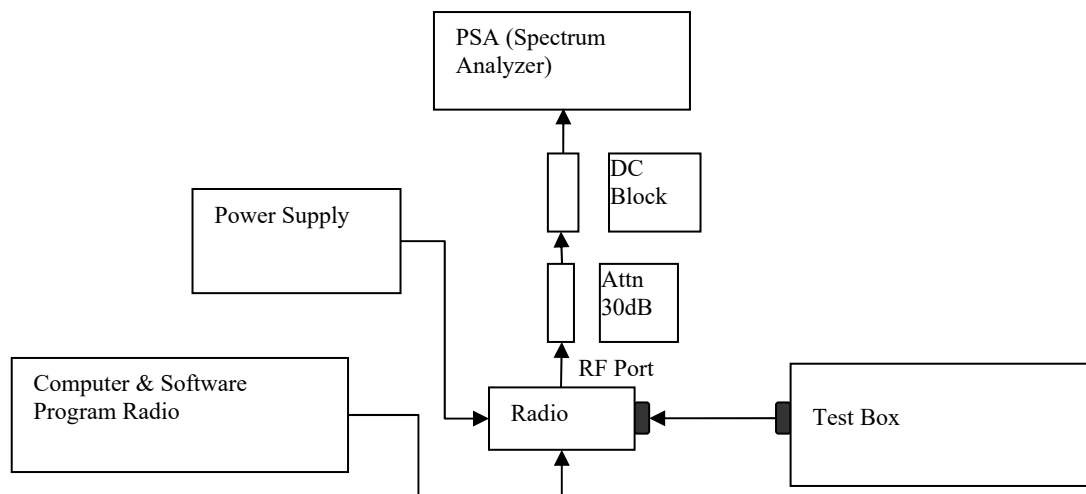

- 1) Program and set radio to operate in desire test frequency and digital mode with modulation. (4FSK, C4FM or other digital modulation form).
- 2) Prepare setup as per picture.
- 3) Turn on the ACP Measurement – Press Measure, ACP.
- 4) Set Span, Resolution Bandwidth and Video Bandwidth as per rules part.
- 5) Transmit the radio and record the Adjacent Channel Power value in dBc.

6.9.4. Test Result

Not Applicable

6.9.5. Test Limit

12.5 kHz MOBILE TRANSMITTER ACP REQUIREMENTS

Offset from center frequency (kHz)	Measurement bandwidth (kHz)	Maximum ACP relative (dBc)
9.375	6.25	-40
15.625	6.25	-60
21.875	6.25	-60
37.50	25.00	-60
62.50	25.00	-65
87.50	25.00	-65
150.00	100	-65
250.00	100	-65
350.00	100	-65
>400 to 12 MHz	30 (s)	-75
12 MHz to paired receive band	30 (s)	-75
In the paired receive band	30 (s)	-100

25 kHz MOBILE TRANSMITTER ACP REQUIREMENTS

Offset from center frequency (kHz)	Measurement bandwidth (kHz)	Maximum ACP relative (dBc)
15.625	6.25	-40
21.875	6.25	-60
37.50	25	-60
62.50	25	-65
87.50	25	-65
150.00	100	-65
250.00	100	-65
350.00	100	-65
>400 kHz to 12 MHz	30 (s)	-75
12 MHz to paired receive band	30 (s)	-75
In the paired receive band	30 (s)	-100

12.5 kHz BASE TRANSMITTER ACP REQUIREMENTS

Offset from center frequency (kHz)	Measurement bandwidth (kHz)	Maximum ACP (dBc)
9.375	6.25	-40
15.625	6.25	-60
21.875	6.25	-60
37.5	25	-60
62.5	25	-65
87.5	25	-65
150	100	-65
250	100	-65
350.00	100	-65
>400 kHz to 12 MHz	30 (s)	-80
12 MHz to paired receive band	30 (s)	-80
In the paired receive band	30 (s)	1-85

25 kHz BASE TRANSMITTER ACP REQUIREMENTS

Offset from center frequency (kHz)	Measurement bandwidth (kHz)	Maximum ACP (dBc)
15.625	6.25	-40
21.875	6.25	-60
37.5	25	-60
62.5	25	-65
87.5	25	-65
150	100	-65
250	100	-65
350	100.00	-65
>400 kHz to 12 MHz	30 (s)	-80
12 MHz to paired receive band	30 (s)	-80
In the paired receive band	30 (s)	1-85

6.10. Conducted Spurious Emission

6.10.1. Test Setup

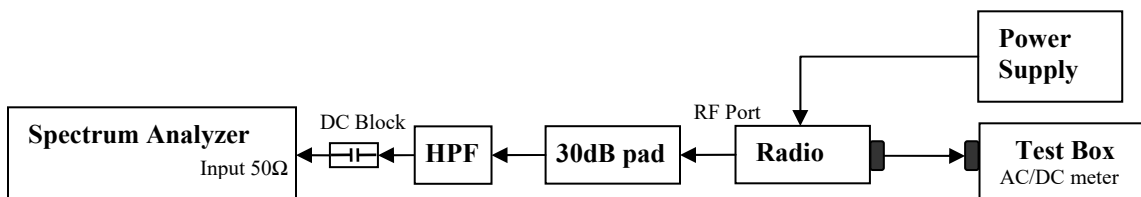

- 1) The DUT transmitter output port was connected to Spectrum Analyzer with above setup.
- 2) Program and set radio to operate in desire test frequency and mode. (Analog / digital modulation form).
- 3) Path loss for the measurement included.
- 4) Set the PSA Resolution Bandwidth as per rules part.
- 5) Set the Ref offset from the pathloss offset calibration file.
- 6) Adjust the center frequency of the spectrum analyzer for incremental coverage of the range from:
 - a. 9 KHz to $F_c - \text{Test Bandwidth}$
 - b. $F_c + \text{Test Bandwidth}$ to $2F_c - 5\text{MHz}$.
- 7) Key up the DUT, Peak Search the highest Spur and record the levels of spurious emissions
- 8) Dekey the DUT.
- 9) Turn On High Pass Filter path and Key up the DUT.
- 10) Adjust the PSA Freq for incremental coverage of range from $2F_c$ to $10F_c$
- 11) Key up the DUT and record the highest spur levels of spurious emissions.

6.10.2. Test Result (Analog)

Analog: 136.0125 MHz, 25.0kHz Channel Spacing, Max Power

RSS 119

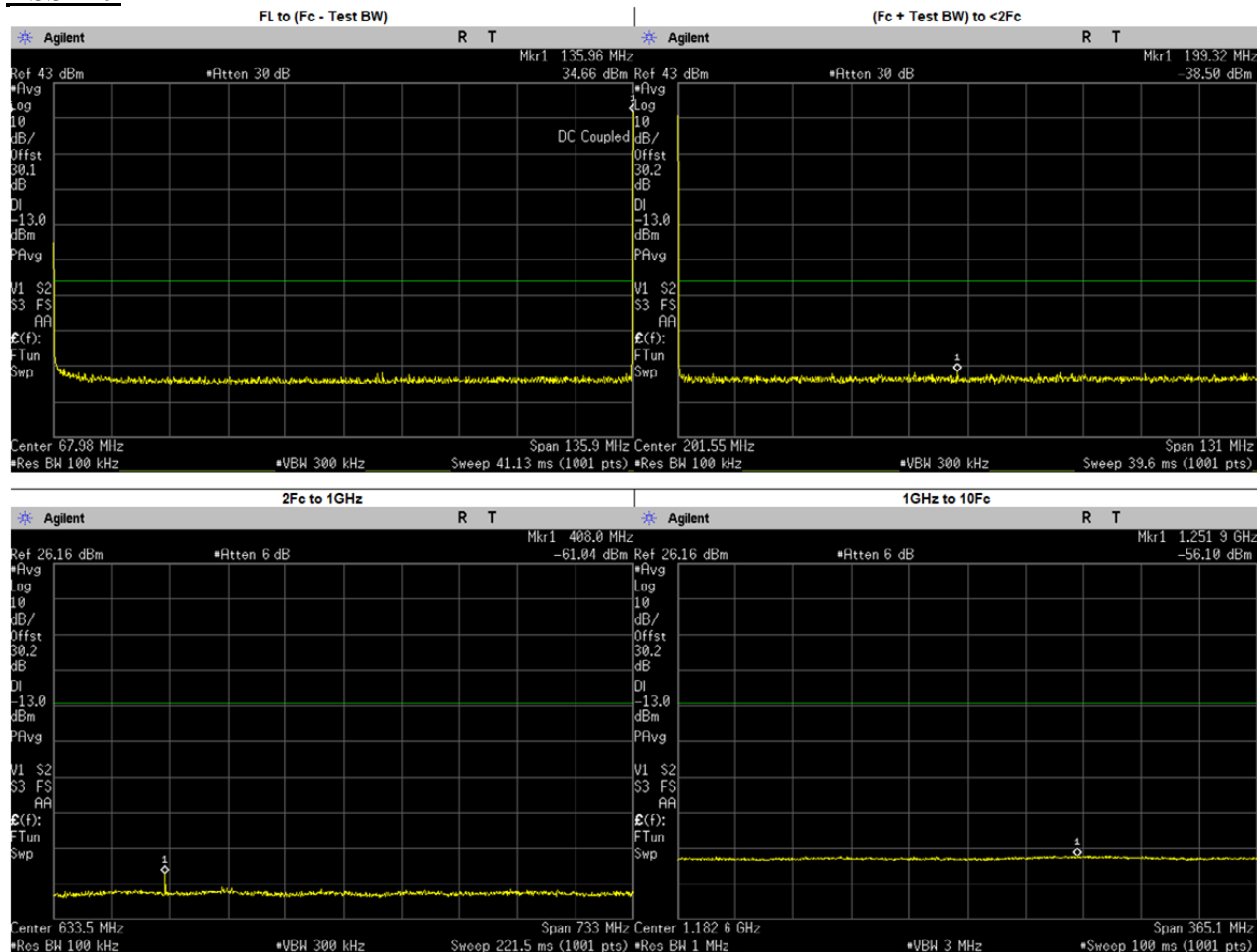

Frequency Range	Highest Spur Frequency (MHz)	Spurious Level (dBm)	Failing Limit (dBm)	Results
FL to (Fc - Test BW)	78.6700	-41.2500	-13.00	PASS
(Fc + Test BW) to <2Fc	199.3203	-38.5000	-13.00	PASS
2Fc to 1GHz	478.8548	-64.8300	-13.00	PASS
	272.0250	-66.5704	-13.00	PASS
	408.0375	-63.2341	-13.00	PASS
	544.0500	-67.0137	-13.00	PASS
	680.0625	-67.1165	-13.00	PASS
	816.0750	-66.4176	-13.00	PASS
	952.0875	-67.0245	-13.00	PASS
1GHz to 10Fc	1251.9360	-56.1000	-13.00	PASS
	1088.1000	-56.7403	-13.00	PASS
	1224.1120	-56.7610	-13.00	PASS
	1360.1250	-56.6976	-13.00	PASS

Analog: 138.0125 MHz, 25.0kHz Channel Spacing, Max Power
Not For FCC Review

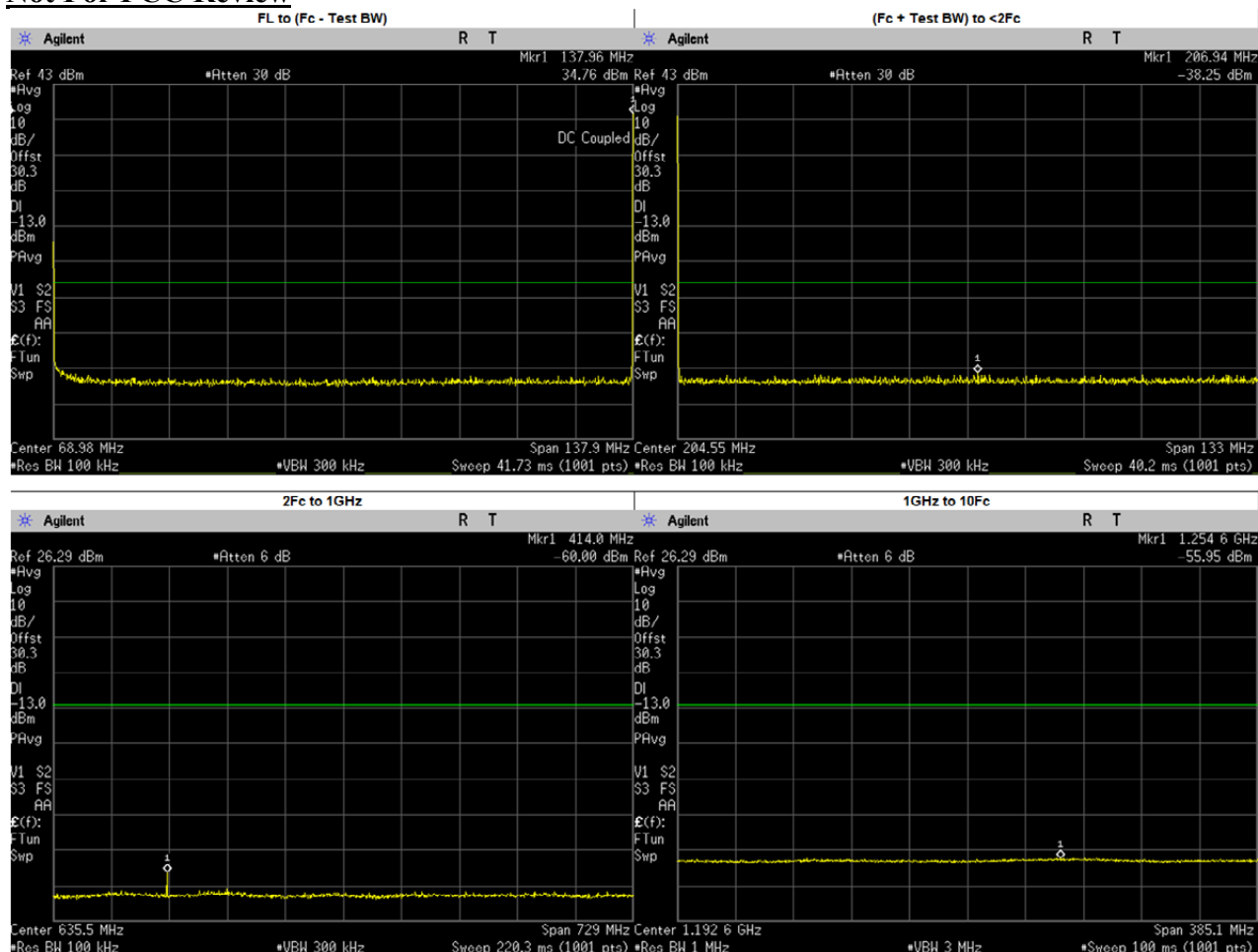

Frequency Range	Highest Spur Frequency (MHz)	Spurious Level (dBm)	Failing Limit (dBm)	Results
FL to (Fc - Test BW)	43.2100	-40.1200	-13.00	PASS
(Fc + Test BW) to <2Fc	206.9398	-38.2500	-13.00	PASS
2Fc to 1GHz	489.7175	-64.6600	-13.00	PASS
	276.0250	-65.9532	-13.00	PASS
	414.0375	-61.1992	-13.00	PASS
	552.0500	-66.5383	-13.00	PASS
	690.0625	-66.7024	-13.00	PASS
	828.0750	-66.2364	-13.00	PASS
	966.0875	-66.4674	-13.00	PASS
1GHz to 10Fc	1254.5680	-55.9500	-13.00	PASS
	1104.1000	-56.5559	-13.00	PASS
	1242.1120	-56.3474	-13.00	PASS
	1380.1250	-56.1837	-13.00	PASS

**Analog: 158.55 MHz, 25.0kHz Channel Spacing, Max Power
 For Part 22.80**

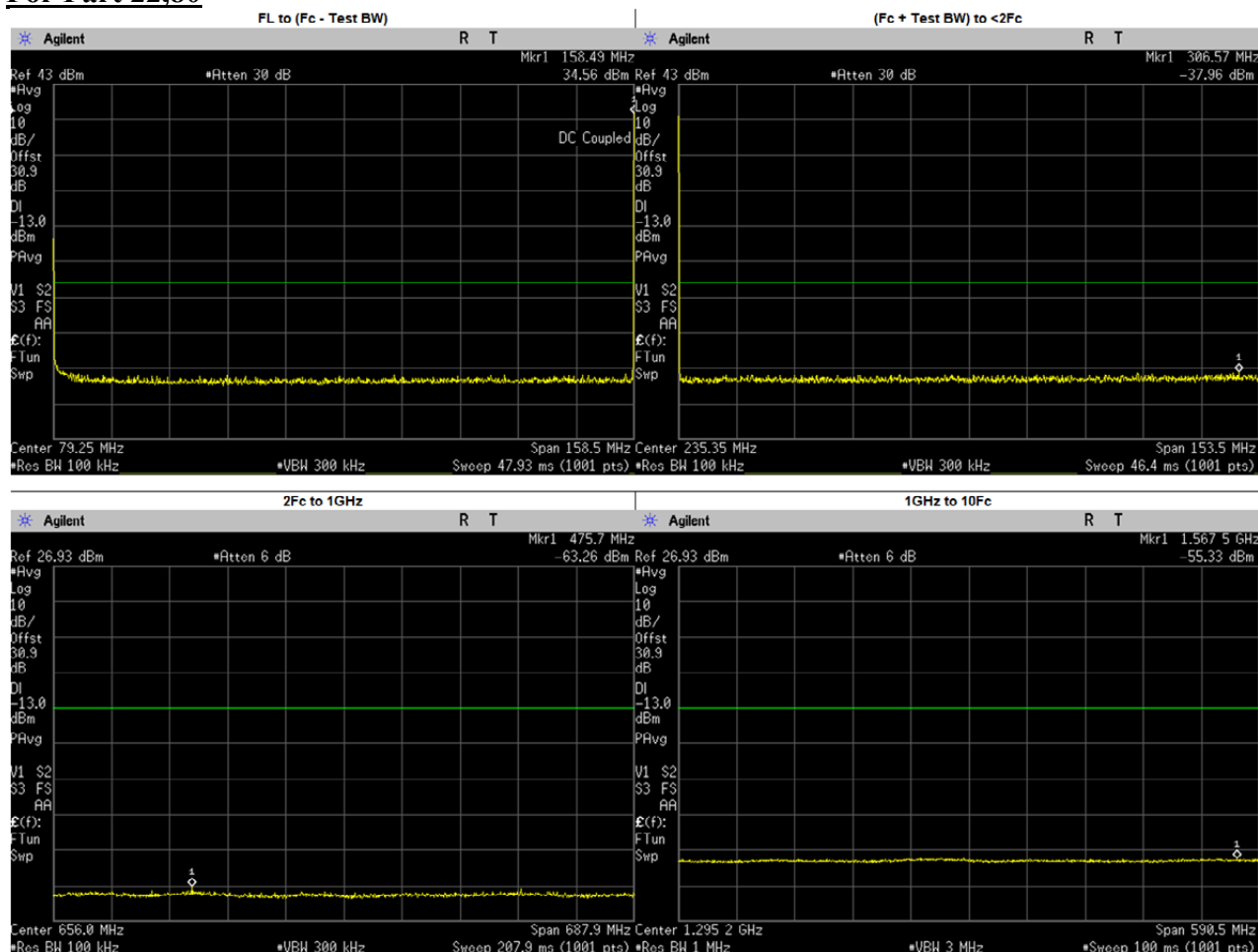

Frequency Range	Highest Spur Frequency (MHz)	Spurious Level (dBm)	Failing Limit (dBm)	Results
FL to (Fc - Test BW)	21.5300	-38.9800	-13.00	PASS
(Fc + Test BW) to <2Fc	306.5742	-37.9600	-13.00	PASS
2Fc to 1GHz	865.8595	-63.9700	-13.00	PASS
	317.1000	-65.8653	-13.00	PASS
	475.6500	-63.7306	-13.00	PASS
	634.2000	-65.9973	-13.00	PASS
	792.7500	-65.5189	-13.00	PASS
	951.3000	-65.4404	-13.00	PASS
1GHz to 10Fc	1567.4700	-55.3300	-13.00	PASS
	1109.8500	-55.8603	-13.00	PASS
	1268.4000	-55.5402	-13.00	PASS
	1426.9500	-55.7667	-13.00	PASS
	1585.5000	-55.8688	-13.00	PASS

**Analog: 158.55 MHz, 25.0kHz Channel Spacing, Low Power
 For Part 22.80**

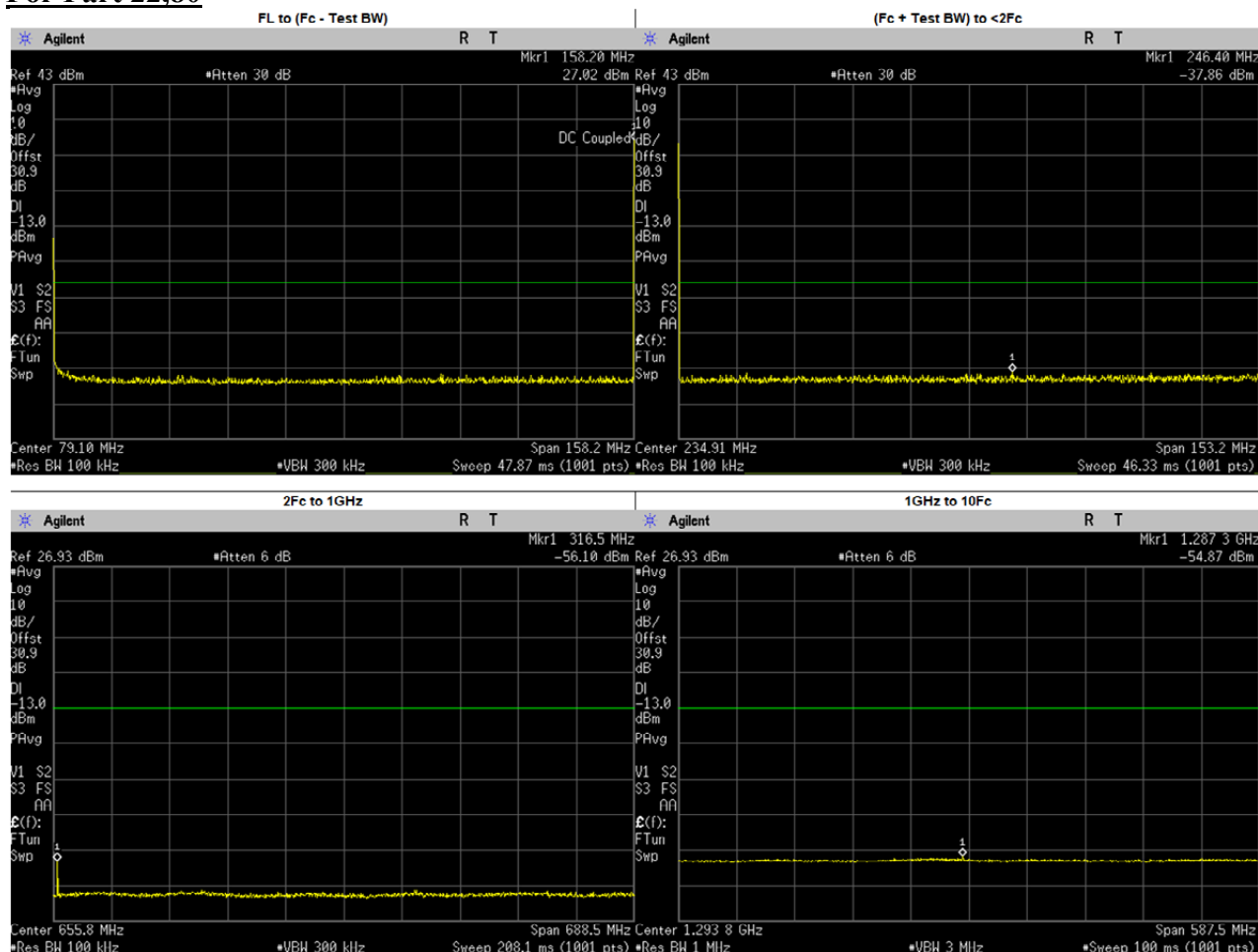

Frequency Range	Highest Spur Frequency (MHz)	Spurious Level (dBm)	Failing Limit (dBm)	Results
FL to (Fc - Test BW)	65.4200	-41.8900	-13.00	PASS
(Fc + Test BW) to <2Fc	246.4003	-37.8600	-13.00	PASS
2Fc to 1GHz	739.7508	-64.1300	-13.00	PASS
	316.5100	-58.6426	-13.00	PASS
	474.7650	-65.1107	-13.00	PASS
	633.0200	-65.8646	-13.00	PASS
	791.2750	-65.7364	-13.00	PASS
	949.5300	-65.8699	-13.00	PASS
1GHz to 10Fc	1287.3120	-54.8700	-13.00	PASS
	1107.7850	-55.8570	-13.00	PASS
	1266.0400	-55.5946	-13.00	PASS
	1424.2950	-56.0796	-13.00	PASS
	1582.5500	-55.6955	-13.00	PASS

Analog: 161.7 MHz, 25.0kHz Channel Spacing, Max Power
Part 74

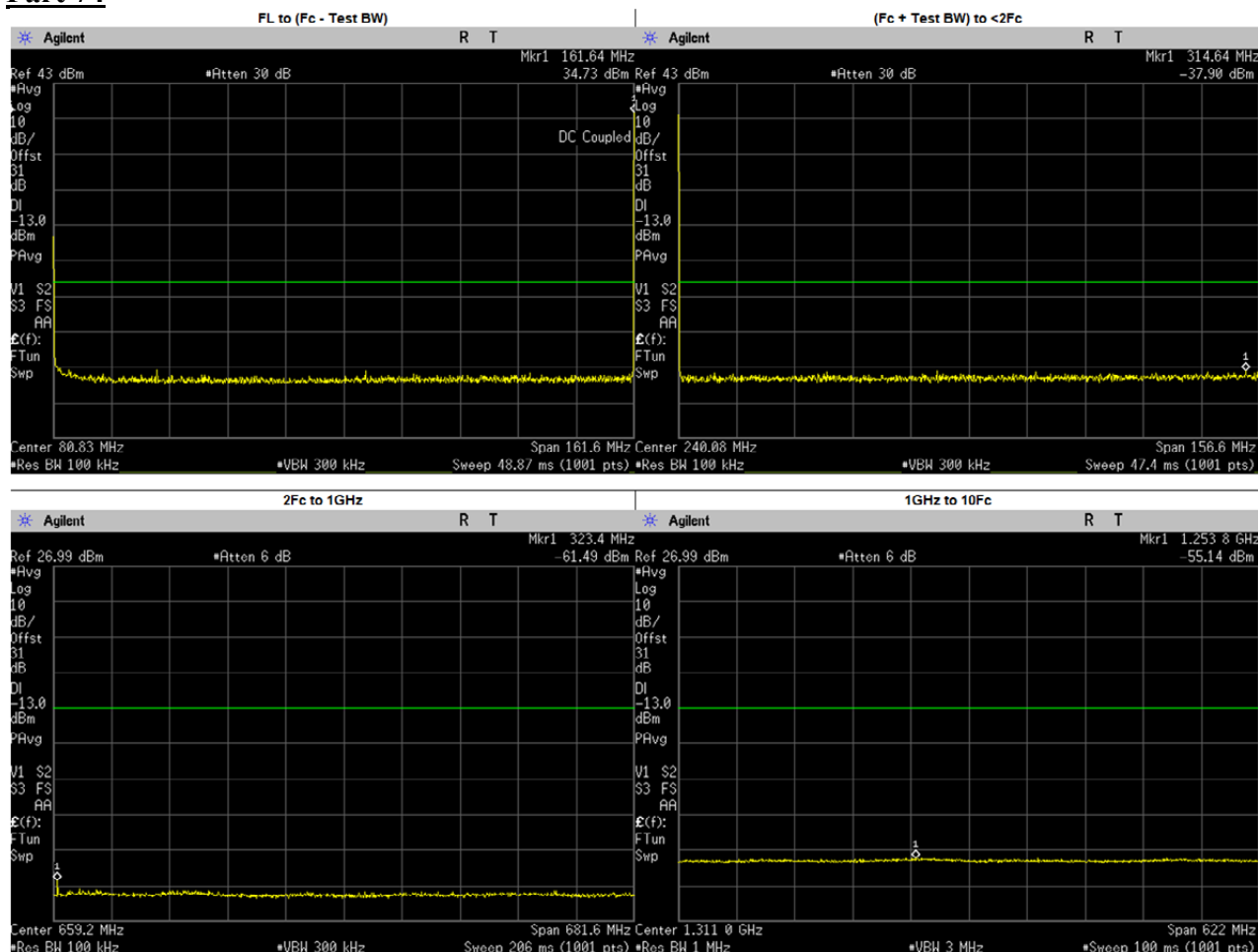

Frequency Range	Highest Spur Frequency (MHz)	Spurious Level (dBm)	Failing Limit (dBm)	Results
FL to (Fc - Test BW)	89.8500	-40.2600	-13.00	PASS
(Fc + Test BW) to <2Fc	314.6405	-37.9100	-13.00	PASS
2Fc to 1GHz	349.0720	-63.8000	-13.00	PASS
	323.4000	-62.8495	-13.00	PASS
	485.1000	-64.6940	-13.00	PASS
	646.8000	-65.2348	-13.00	PASS
	808.5000	-65.7363	-13.00	PASS
	970.2000	-65.8206	-13.00	PASS
1GHz to 10Fc	1253.7760	-55.1400	-13.00	PASS
	1131.9000	-56.0950	-13.00	PASS
	1293.6000	-55.9271	-13.00	PASS
	1455.3000	-55.9588	-13.00	PASS
	1617.0000	-55.9149	-13.00	PASS

Analog: 161.7 MHz, 25.0kHz Channel Spacing, Low Power
Part 74

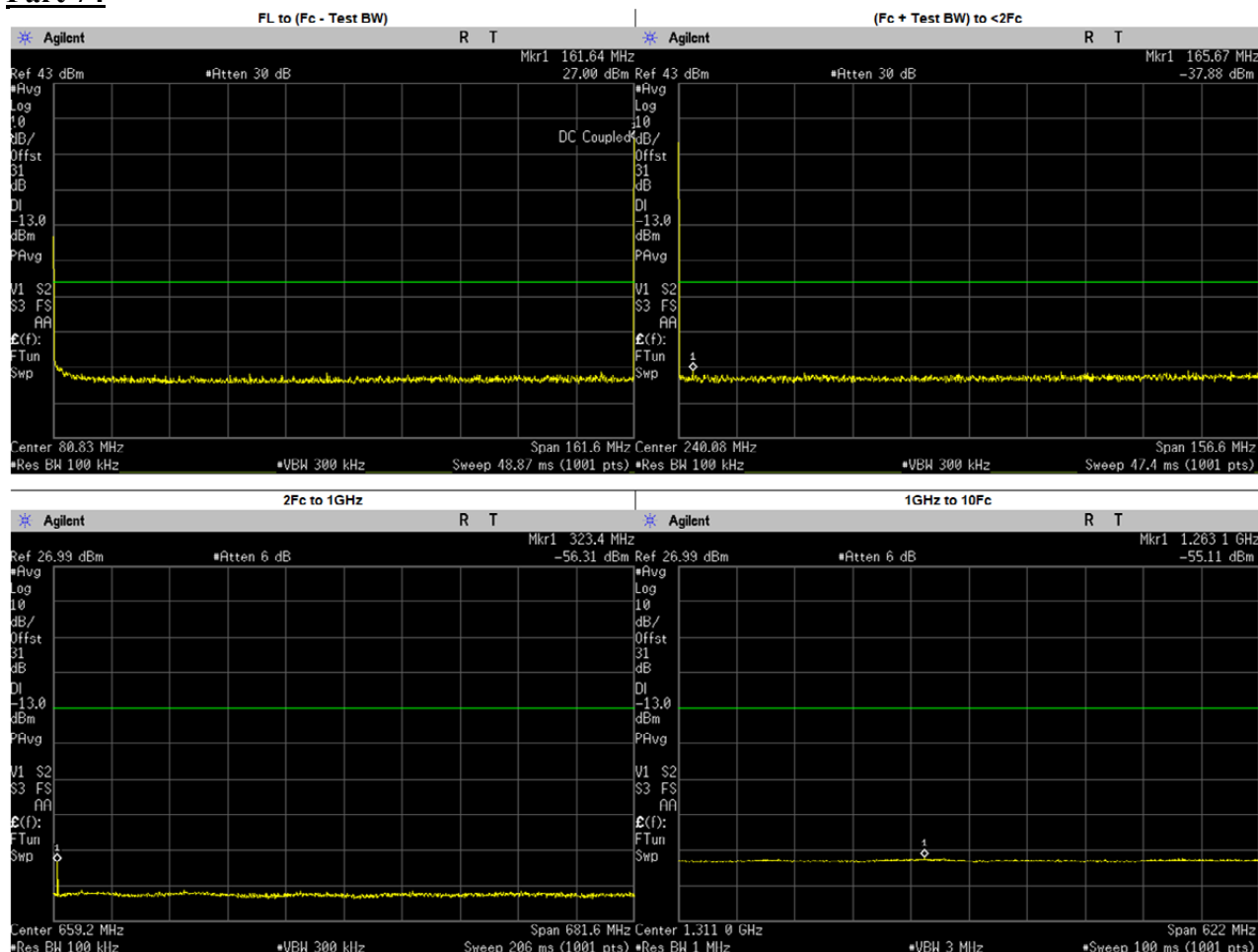

Frequency Range	Highest Spur Frequency (MHz)	Spurious Level (dBm)	Failing Limit (dBm)	Results
FL to (Fc - Test BW)	58.5600	-40.6300	-13.00	PASS
(Fc + Test BW) to <2Fc	165.6717	-37.8800	-13.00	PASS
2Fc to 1GHz	351.7984	-64.1500	-13.00	PASS
	323.4000	-59.5285	-13.00	PASS
	485.1000	-64.9625	-13.00	PASS
	646.8000	-65.4044	-13.00	PASS
	808.5000	-65.2299	-13.00	PASS
	970.2000	-65.6410	-13.00	PASS
1GHz to 10Fc	1263.1060	-55.1100	-13.00	PASS
	1131.9000	-56.1168	-13.00	PASS
	1293.6000	-55.7030	-13.00	PASS
	1455.3000	-55.7277	-13.00	PASS
	1617.0000	-55.6050	-13.00	PASS

Analog: 173.3875MHz, 25.0kHz Channel Spacing, Max Power
Not For FCC Review

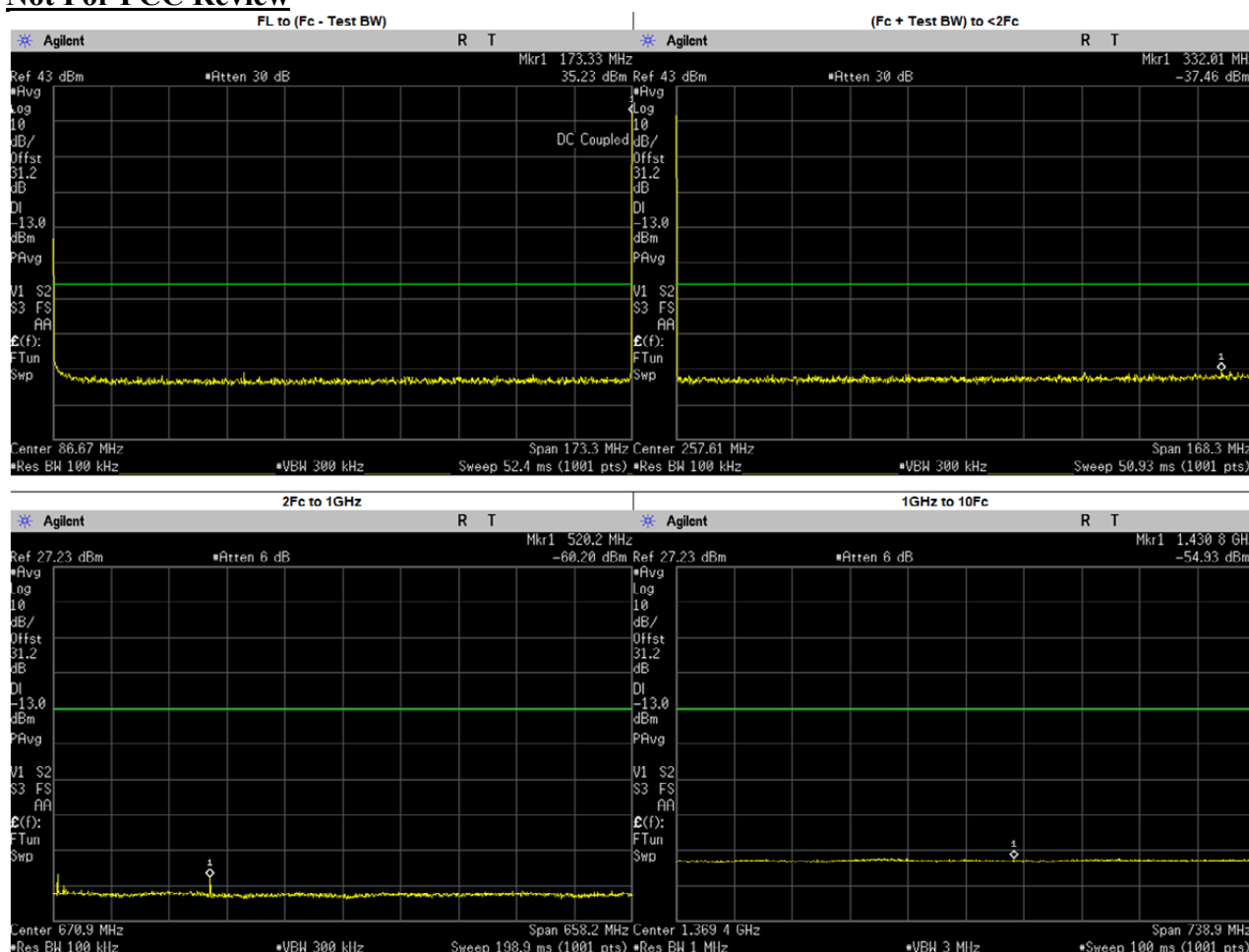

Frequency Range	Highest Spur Frequency (MHz)	Spurious Level (dBm)	Failing Limit (dBm)	Results
FL to (Fc - Test BW)	75.6300	-38.6900	-13.00	PASS
(Fc + Test BW) to <2Fc	332.0118	-37.4600	-13.00	PASS
2Fc to 1GHz	353.6230	-62.8100	-13.00	PASS
	346.7750	-61.3257	-13.00	PASS
	520.1625	-60.2594	-13.00	PASS
	693.5500	-65.4825	-13.00	PASS
	866.9375	-64.9761	-13.00	PASS
1GHz to 10Fc	1430.7640	-54.9300	-13.00	PASS
	1040.3250	-55.8290	-13.00	PASS
	1213.7130	-55.6501	-13.00	PASS
	1387.1000	-55.6058	-13.00	PASS
	1560.4870	-55.5591	-13.00	PASS
	1733.8750	-55.5617	-13.00	PASS

6.10.3. Test Result (Digital)

4FSK: 136.0125 MHz, 12.5 kHz Channel Spacing, Max Power

RSS 119

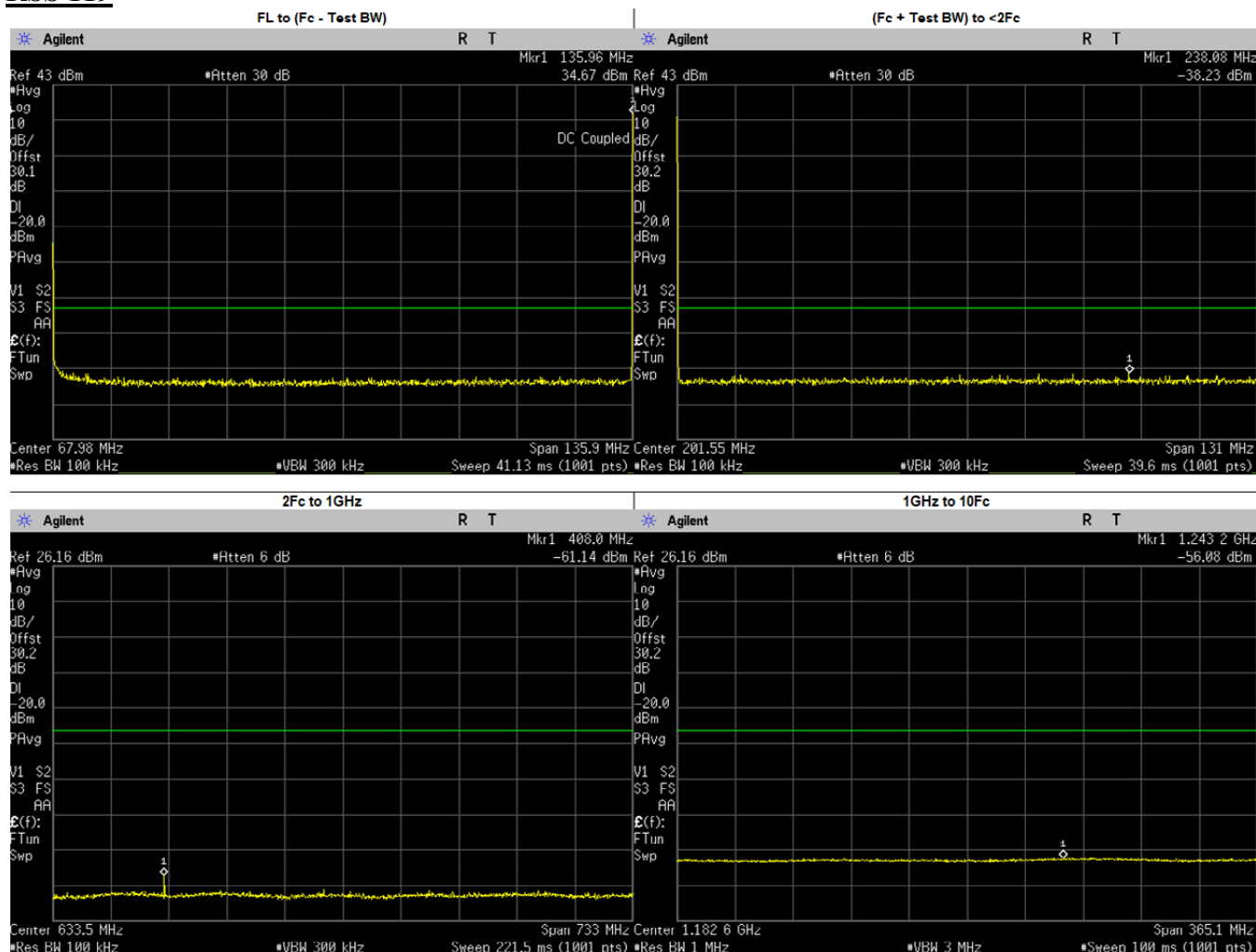

Frequency Range	Highest Spur Frequency (MHz)	Spurious Level (dBm)	Failing Limit (dBm)	Results
FL to (Fc - Test BW)	67.8900	-37.8900	-20.00	PASS
(Fc + Test BW) to <2Fc	238.0835	-38.2300	-20.00	PASS
2Fc to 1GHz	609.3243	-65.0100	-20.00	PASS
	272.0250	-66.4451	-20.00	PASS
	408.0375	-63.1806	-20.00	PASS
	544.0500	-66.9959	-20.00	PASS
	680.0625	-67.0125	-20.00	PASS
	816.0750	-66.6220	-20.00	PASS
	952.0875	-66.7756	-20.00	PASS
1GHz to 10Fc	1243.1730	-56.0800	-20.00	PASS
	1088.1000	-56.6361	-20.00	PASS
	1224.1120	-56.7821	-20.00	PASS
	1360.1250	-56.7247	-20.00	PASS

4FSK: 138.0125 MHz, 12.5 kHz Channel Spacing, Max Power
Not For FCC Review

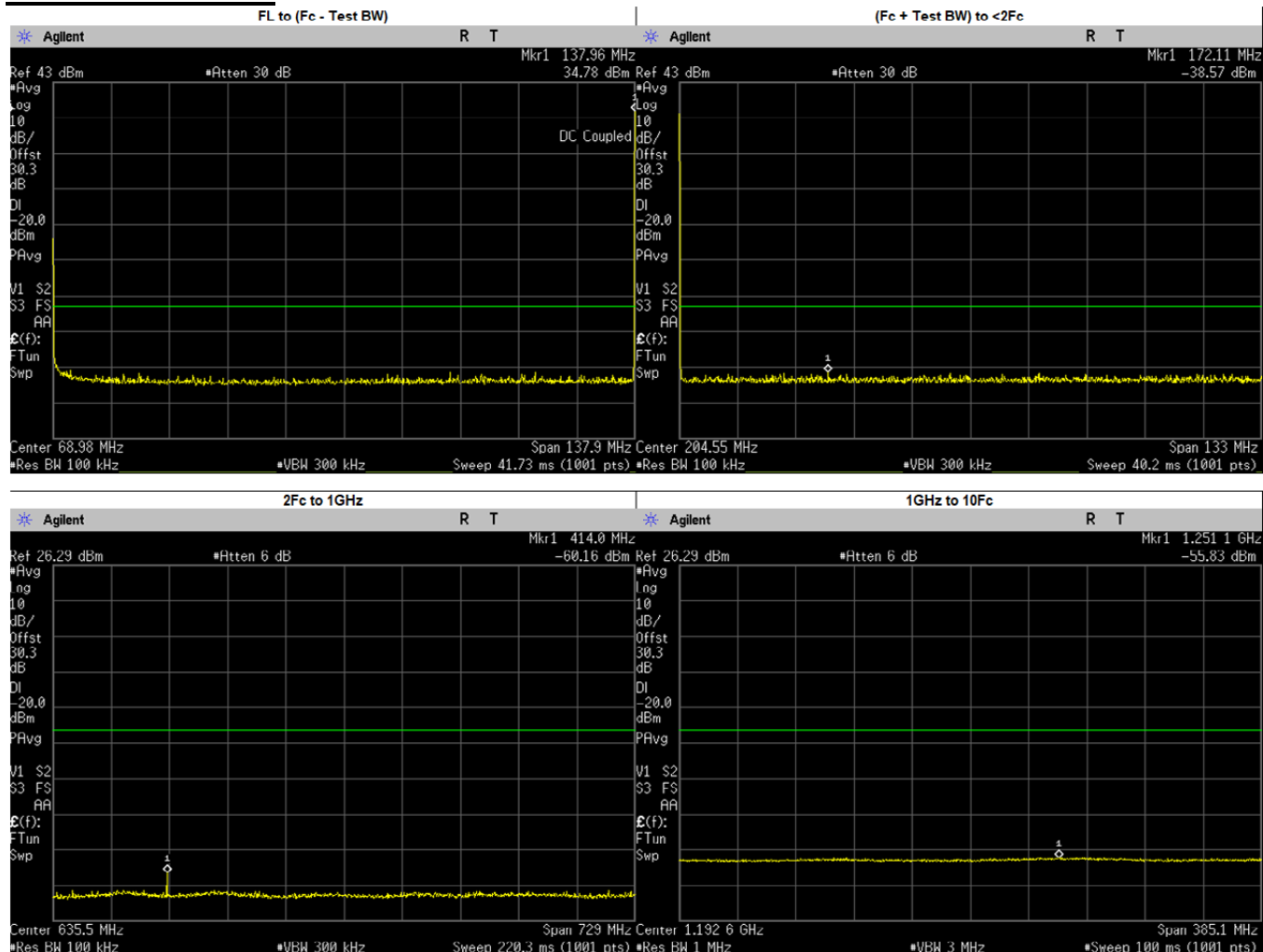

Frequency Range	Highest Spur Frequency (MHz)	Spurious Level (dBm)	Failing Limit (dBm)	Results
FL to (Fc - Test BW)	38.9600	-39.9600	-20.00	PASS
(Fc + Test BW) to <2Fc	172.1051	-38.5700	-20.00	PASS
2Fc to 1GHz	295.8102	-65.0300	-20.00	PASS
	276.0250	-65.8323	-20.00	PASS
	414.0375	-61.3744	-20.00	PASS
	552.0500	-66.7130	-20.00	PASS
	690.0625	-66.0403	-20.00	PASS
	828.0750	-66.3681	-20.00	PASS
	966.0875	-65.7080	-20.00	PASS
1GHz to 10Fc	1251.1010	-55.8300	-20.00	PASS
	1104.1000	-56.6242	-20.00	PASS
	1242.1120	-56.2899	-20.00	PASS
	1380.1250	-56.7666	-20.00	PASS

**4FSK: 158.55 MHz, 12.5 kHz Channel Spacing, Max Power
 FCC Part 22,80,90**

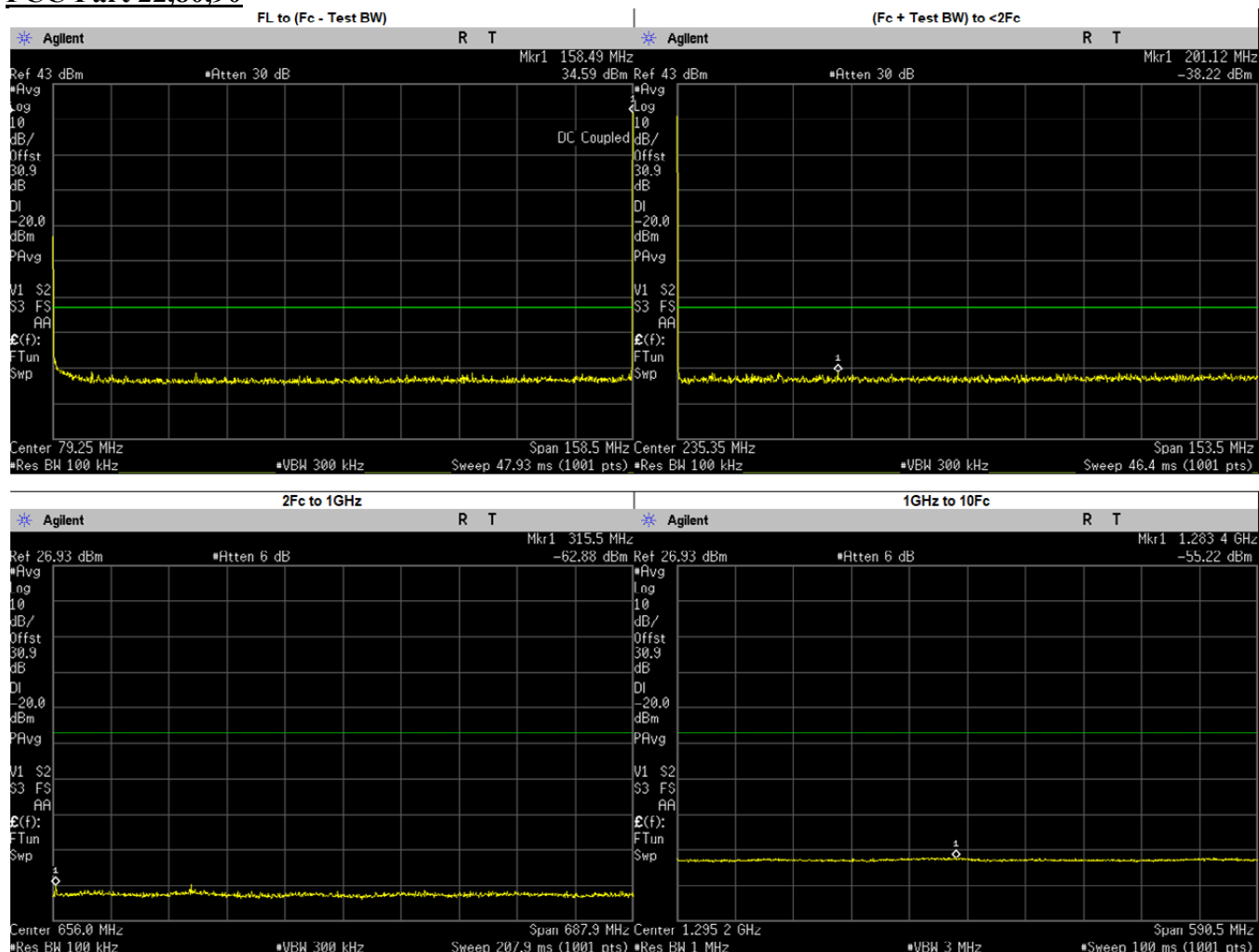

Frequency Range	Highest Spur Frequency (MHz)	Spurious Level (dBm)	Failing Limit (dBm)	Results
FL to (Fc - Test BW)	35.6900	-41.1000	-20.00	PASS
(Fc + Test BW) to <2Fc	201.1236	-38.2200	-20.00	PASS
2Fc to 1GHz	315.5395	-62.8800	-20.00	PASS
	317.1000	-65.5217	-20.00	PASS
	475.6500	-63.4292	-20.00	PASS
	634.2000	-65.8235	-20.00	PASS
	792.7500	-65.7494	-20.00	PASS
	951.3000	-65.9952	-20.00	PASS
1GHz to 10Fc	1283.4400	-55.2200	-20.00	PASS
	1109.8500	-55.8002	-20.00	PASS
	1268.4000	-55.6402	-20.00	PASS
	1426.9500	-55.9068	-20.00	PASS
	1585.5000	-55.9709	-20.00	PASS

**4FSK: 158.55 MHz, 12.5 kHz Channel Spacing, Max Power
 FCC Part 22.80.90**

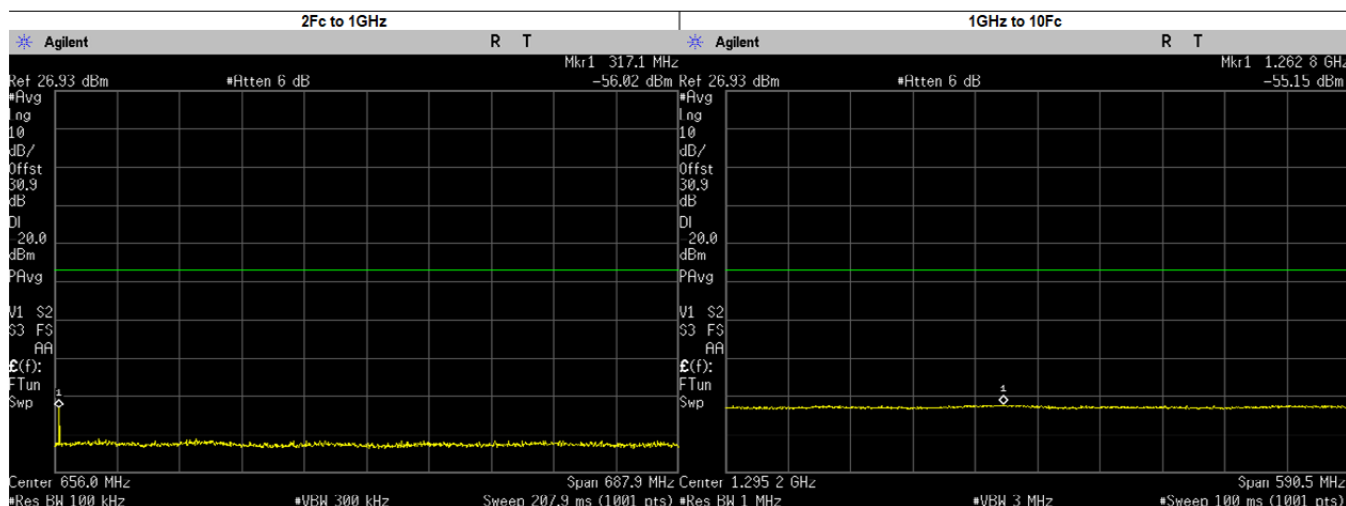
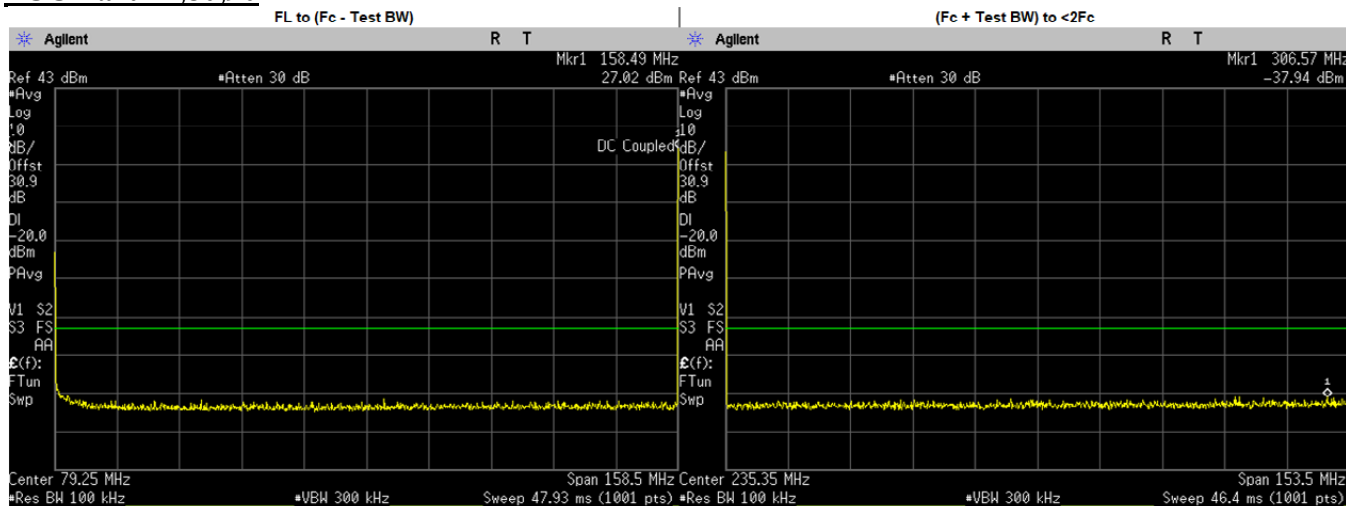

Frequency Range	Highest Spur Frequency (MHz)	Spurious Level (dBm)	Failing Limit (dBm)	Results
FL to (Fc - Test BW)	158.4900	-38.9600	-20.00	PASS
(Fc + Test BW) to <2Fc	306.5742	-37.9400	-20.00	PASS
2Fc to 1GHz	360.9409	-64.1500	-20.00	PASS
	317.1000	-58.5859	-20.00	PASS
	475.6500	-65.1710	-20.00	PASS
	634.2000	-65.5561	-20.00	PASS
	792.7500	-65.7189	-20.00	PASS
	951.3000	-65.8145	-20.00	PASS
1GHz to 10Fc	1262.7730	-55.1600	-20.00	PASS
	1109.8500	-55.7947	-20.00	PASS
	1268.4000	-55.6168	-20.00	PASS
	1426.9500	-55.9498	-20.00	PASS
	1585.5000	-55.8463	-20.00	PASS

4FSK: 161.7 MHz, 12.5 kHz Channel Spacing, Max Power
FCC Part 74, 90,RSS 119

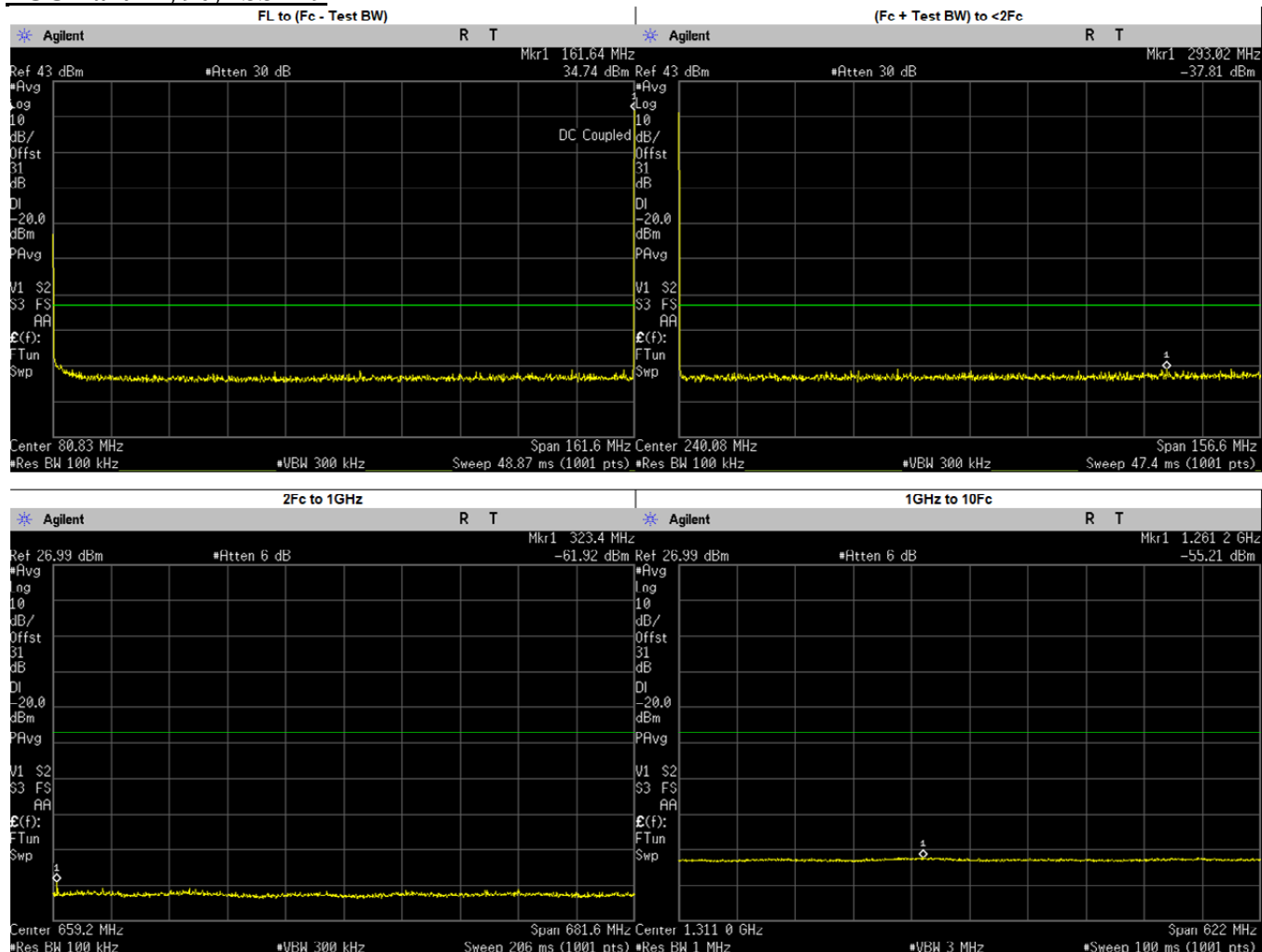

Frequency Range	Highest Spur Frequency (MHz)	Spurious Level (dBm)	Failing Limit (dBm)	Results
FL to (Fc - Test BW)	35.6900	-38.9800	-20.00	PASS
(Fc + Test BW) to <2Fc	293.0236	-37.8100	-20.00	PASS
2Fc to 1GHz	377.0176	-63.9300	-20.00	PASS
	323.4000	-63.1745	-20.00	PASS
	485.1000	-64.5548	-20.00	PASS
	646.8000	-65.6179	-20.00	PASS
	808.5000	-65.7695	-20.00	PASS
	970.2000	-65.6861	-20.00	PASS
1GHz to 10Fc	1261.2400	-55.2100	-20.00	PASS
	1131.9000	-55.9104	-20.00	PASS
	1293.6000	-55.8722	-20.00	PASS
	1455.3000	-55.9778	-20.00	PASS
	1617.0000	-55.8314	-20.00	PASS

4FSK: 161.7 MHz, 12.5 kHz Channel Spacing, Low Power
FCC Part 74, 90,RSS 119

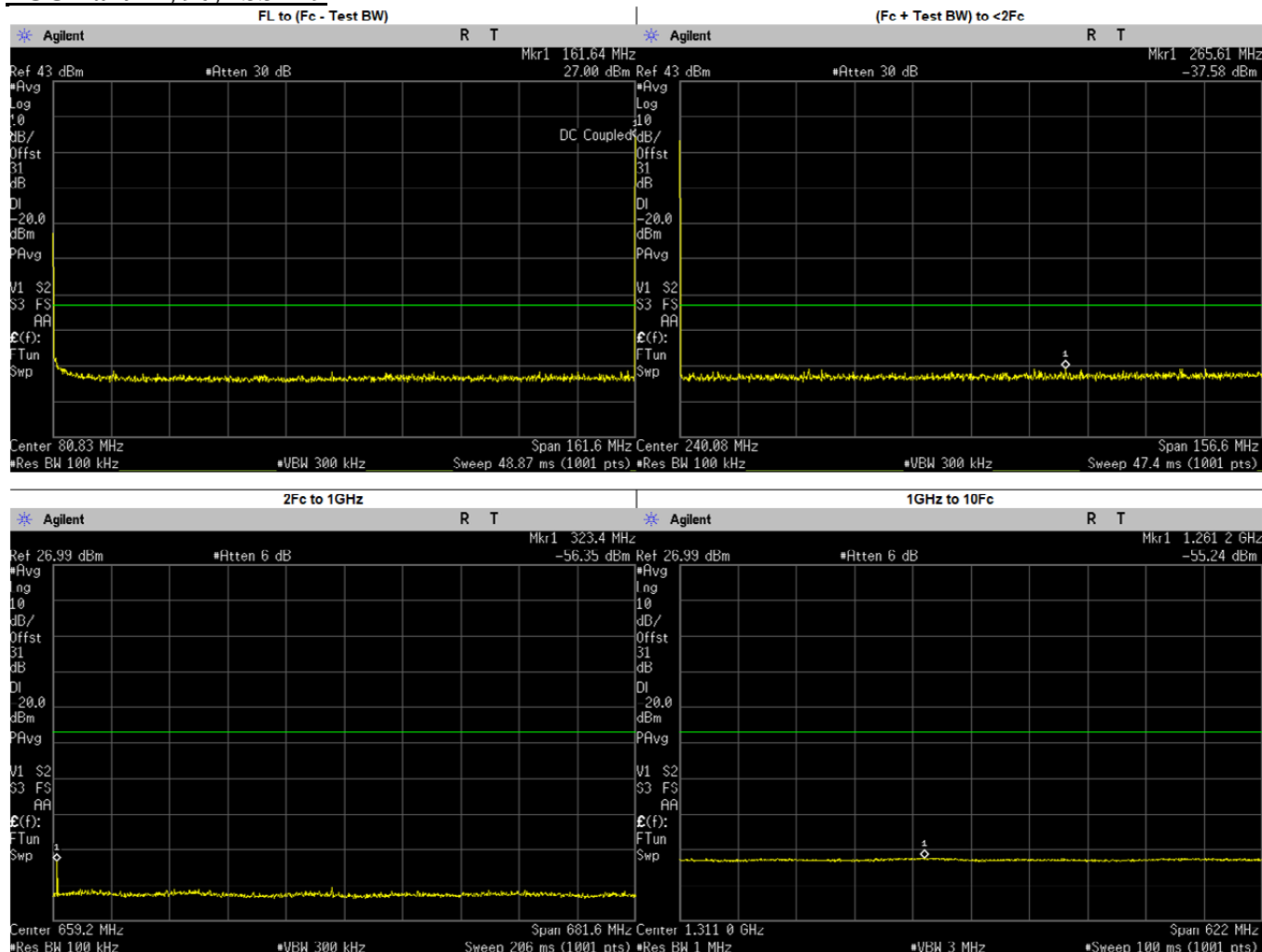

Frequency Range	Highest Spur Frequency (MHz)	Spurious Level (dBm)	Failing Limit (dBm)	Results
FL to (Fc - Test BW)	56.9600	-38.5200	-20.00	PASS
(Fc + Test BW) to <2Fc	265.6108	-37.5800	-20.00	PASS
2Fc to 1GHz	644.8864	-63.6500	-20.00	PASS
	323.4000	-59.4107	-20.00	PASS
	485.1000	-65.1840	-20.00	PASS
	646.8000	-65.6654	-20.00	PASS
	808.5000	-65.6610	-20.00	PASS
	970.2000	-65.5673	-20.00	PASS
1GHz to 10Fc	1261.2400	-55.2400	-20.00	PASS
	1131.9000	-55.8444	-20.00	PASS
	1293.6000	-55.8425	-20.00	PASS
	1455.3000	-56.0319	-20.00	PASS
	1617.0000	-56.0247	-20.00	PASS

**4FSK: 173.3875 MHz, 12.5 kHz Channel Spacing, Max Power
 FCC Part 90,RSS 119**

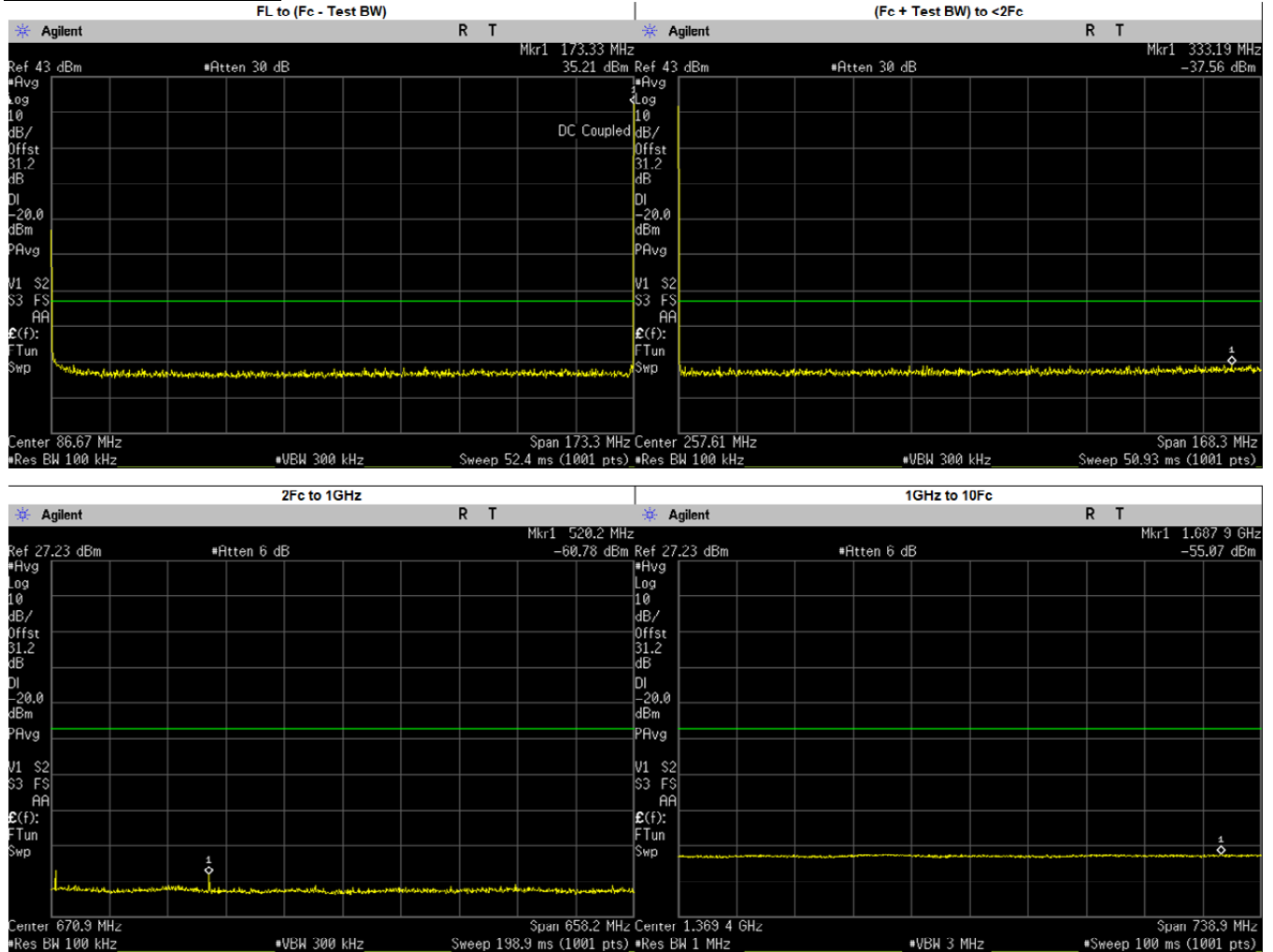

Frequency Range	Highest Spur Frequency (MHz)	Spurious Level (dBm)	Failing Limit (dBm)	Results
FL to (Fc - Test BW)	39.6900	-42.3100	-20.00	PASS
(Fc + Test BW) to <2Fc	333.1901	-37.5600	-20.00	PASS
2Fc to 1GHz	865.7221	-63.5100	-20.00	PASS
	346.7750	-61.3189	-20.00	PASS
	520.1625	-60.8283	-20.00	PASS
	693.5500	-65.7092	-20.00	PASS
	866.9375	-64.6029	-20.00	PASS
1GHz to 10Fc	1687.8930	-55.0700	-20.00	PASS
	1040.3250	-55.6773	-20.00	PASS
	1213.7130	-55.6736	-20.00	PASS
	1387.1000	-55.6809	-20.00	PASS
	1560.4870	-55.4960	-20.00	PASS
	1733.8750	-55.6827	-20.00	PASS

6.10.4. Test Limit

Table below summarized the power of any emission outside a licensee’s frequency block shall be attenuated below the transmitter power (P) by at least

Channel Spacing	Part 22	Part 24D	Part 74	Part 80	Part 90 (UHF, VHF, 800, 900)	Part 90 (700)
12.5kHz	43 + log ₁₀ (P) (-13 dBm)	43 + log ₁₀ (P) (-13 dBm)	43 + log ₁₀ (P) (-13 dBm)	Not Applicable	50 + log ₁₀ (P) (-20 dBm)	43 + log ₁₀ (P) (-13 dBm)
25kHz		Not Applicable		43 + log ₁₀ (P) (-13 dBm)	43 + log ₁₀ (P) (-13 dBm)	43 + log ₁₀ (P) (-13 dBm)

Channel Spacing	RSS 134	RSS 182	RSS 119 (UHF, VHF, 800, 900)	RSS 119 (700)
12.5kHz	43 + log ₁₀ (P) (-13 dBm)	Not Applicable	50 + log ₁₀ (P) (-20 dBm)	43 + log ₁₀ (P) (-13 dBm)
25kHz	Not Applicable	43 + log ₁₀ (P) (-13 dBm)	43 + log ₁₀ (P) (-13 dBm)	43 + log ₁₀ (P) (-13 dBm)

6.11. Radiated Spurious Emission

6.11.1. Test Setup

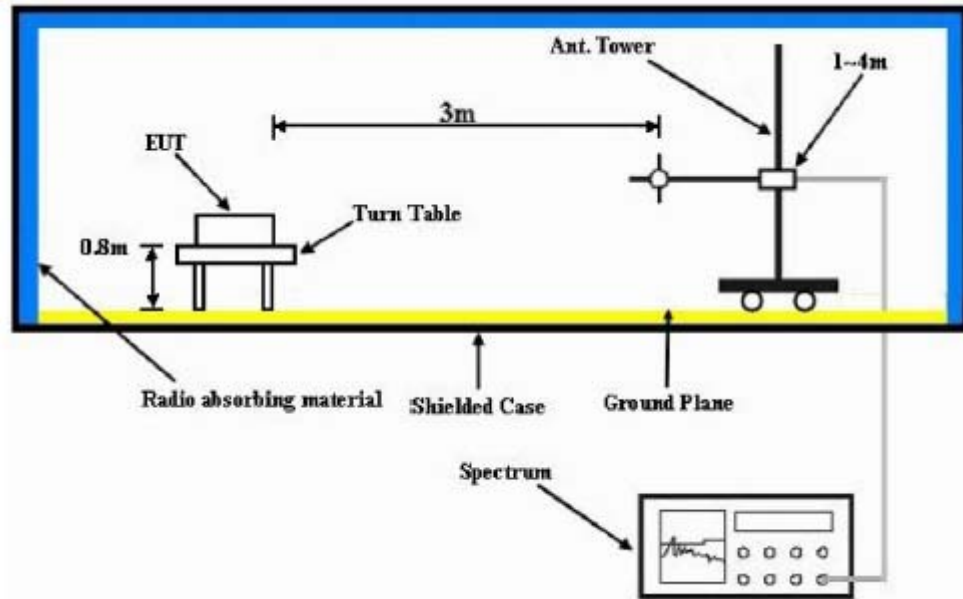

- 1) The Resolution Bandwidth for scanning Radiated Emission below 1 GHz is 100 kHz with Video Bandwidth = 300 kHz and Resolution Bandwidth for above 1 GHz is 1 MHz with Video Bandwidth = 3 MHz. Detector mode is positive peak.
- 2) In the semi- anechoic chamber, setup as illustrated above the DUT placed on the 0.8m height (for $F_c < 1\text{GHz}$) or 1.5m height (for $F_c > 1\text{GHz}$) of Turn Table, rotated the table around 360 degrees to search the maximum radiation power and receiver antenna shall be rotated vertical and horizontal polarization and moved height from 1m to 4m to find the maximum polar radiated power. The “Read Value” is the spectrum reading the maximum power value.
- 3) The substitution antenna is substituted for DUT at the same position and signals generator (S.G) export the CW signal to the substitution antenna via a TX cable. The receiver antenna shall be rotated vertical and horizontal polarization and moved height from 1m to 4m to find the maximum radiation power. Record the power level of maximum radiation power from spectrum. So, the measured substitution value = Ref level of S.G + TX cables loss – Substituted Antenna Gain.
- 4) Final Radiated Spurious Emission = “Read Value” + Measured substitution value.

SAC Transmitter Radiated Emission:

Model Number: AAH56JDN9PA3AN S/N: 627TWK0679 SR:21594-EMC-00005
 Battery Part No: NNTN8386A Test Mode: TX Analog Accy Part No: NA
 158.55000 MHz 25 kHz 1.000 Watt(s) /Low Power

Frequency (MHz)	Limit	Horizontal Measured Emission Equiv Pwr Into Ideal Dipole (dBm)	Vertical Measured Emission Equiv Pwr Into ideal Dipole (dBm)
317.1000	-13.0000	-97.3302 **	-97.8467 **
475.6500	-13.0000	-90.9249 **	-90.9354 **
634.2000	-13.0000	-89.3828 **	-89.7531 **
792.7500	-13.0000	-87.6258 **	-87.6154 **
951.3000	-13.0000	-85.2112 **	-85.5283 **
1109.8500	-13.0000	-62.8489 **	-61.0937 **
1268.4000	-13.0000	-61.8667 **	-61.7559 **
1426.9500	-13.0000	-60.6460 **	-62.0119 **
1585.5000	-13.0000	-59.8756 **	-60.0535 **

RADIATED SPURIOUS EMISSIONS

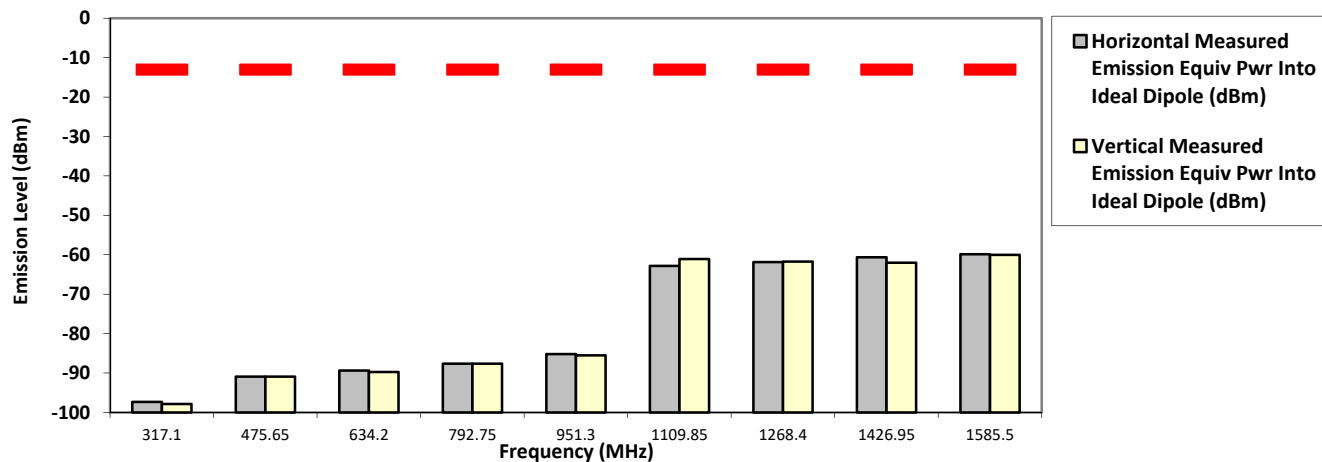

The data presented here was taken using the substitution method as found in the ANSI C63.26-2015 document.
 Motorola Penang EMC Lab - Test Performed by: Nazrin&Qawiman Wed, Jun 10, 2020

Remarks: ** Indicates the spurious emission could not be detected due to noise limitations or ambient.
 *Pursuant to CFR 47 Part 2.1057 (c), emissions attenuated more than 20 dB below the permissible limit are not reported
 Temp(Deg): 25.3 Hum(%RH): 70.2

System MU: 4.03 dB

Remarks:	Passed Results	Marginal Results	Failed Results
----------	----------------	------------------	----------------

SAC Transmitter Radiated Emission:

Model Number: AAH56JDN9PA3AN **S/N: 627TWK0679** **SR:21594-EMC-00005**
Battery Part No: NNTN8386A **Accy Part No: NA**
Test Mode: TX Analog
158.55000 MHz **25 kHz** **6.000 Watt(s) /Max Power**

Frequency (MHz)	Limit	Horizontal Measured Emission Equiv Pwr Into Ideal Dipole (dBm)	Vertical Measured Emission Equiv Pwr Into ideal Dipole (dBm)
317.1000	-13.0000	-97.0157 **	-97.0978 **
475.6500	-13.0000	-91.3122 **	-90.5361 **
634.2000	-13.0000	-88.3530 **	-88.1575 **
792.7500	-13.0000	-87.4720 **	-87.6164 **
951.3000	-13.0000	-86.3587 **	-85.9955 **
1109.8500	-13.0000	-62.6387 **	-61.4706 **
1268.4000	-13.0000	-60.7802 **	-61.7351 **
1426.9500	-13.0000	-61.5276 **	-62.0355 **
1585.5000	-13.0000	-60.1463 **	-60.3521 **

RADIATED SPURIOUS EMISSIONS

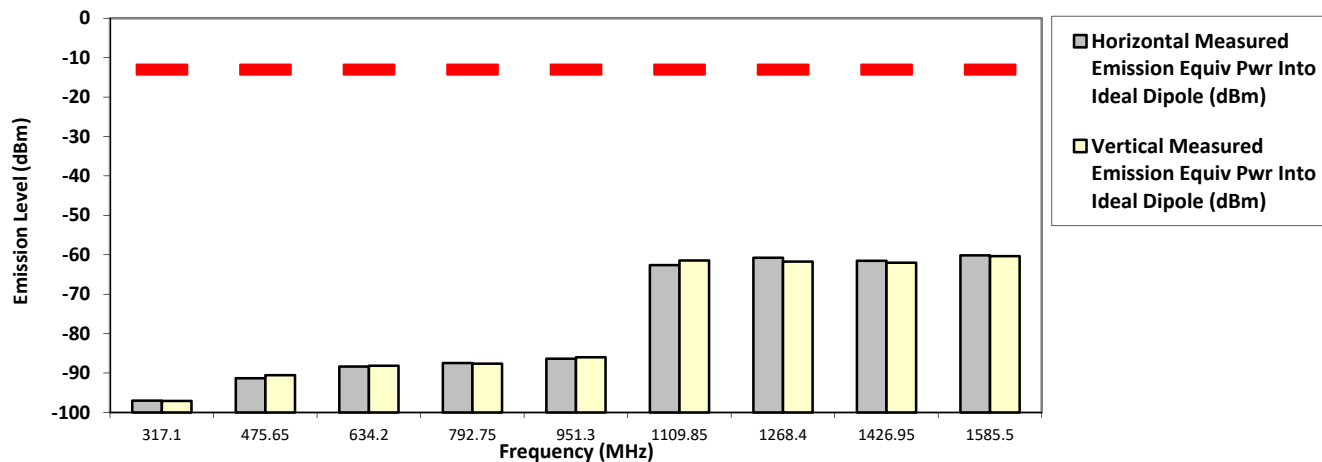

The data presented here was taken using the substitution method as found in the ANSI C63.26-2015 document.
 Motorola Penang EMC Lab - Test Performed by: Nazrin&Qawiman Wed, Jun 10, 2020

Remarks: ** Indicates the spurious emission could not be detected due to noise limitations or ambient.
 *Pursuant to CFR 47 Part 2.1057 (c), emissions attenuated more than 20 dB below the permissible limit are not reported
 Temp(Deg): 25.3 Hum(%RH): 70.2

System MU: 4.03 dB

Remarks:	Passed Results	Marginal Results	Failed Results
----------	----------------	------------------	----------------

SAC Transmitter Radiated Emission:

Model Number: AAH56JDN9PA3AN

S/N: 627TWK0679

SR:21594-EMC-00005

Battery Part No: NNTN8386A

Accy Part No: NA

161.70000 MHz

Test Mode: TX Analog
 25 kHz

1.000 Watt(s) /Low Power

Frequency (MHz)	Limit	Horizontal Measured Emission Equiv Pwr Into Ideal Dipole (dBm)	Vertical Measured Emission Equiv Pwr Into ideal Dipole (dBm)
323.4000	-13.0000	-97.4272 **	-96.9216 **
485.1000	-13.0000	-91.8312 **	-91.3529 **
646.8000	-13.0000	-89.2131 **	-88.9433 **
808.5000	-13.0000	-86.5774 **	-86.0587 **
970.2000	-13.0000	-85.4868 **	-85.7472 **
1131.9000	-13.0000	-62.0100 **	-63.3085 **
1293.6000	-13.0000	-62.1618 **	-62.4445 **
1455.3000	-13.0000	-61.4034 **	-61.5103 **
1617.0000	-13.0000	-59.9757 **	-59.5778 **

RADIATED SPURIOUS EMISSIONS

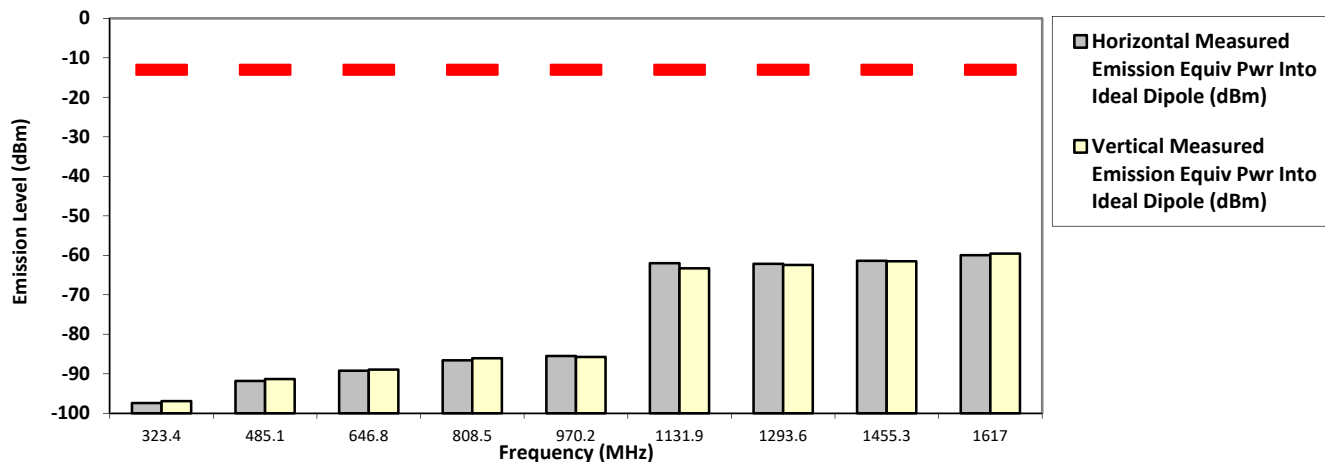

The data presented here was taken using the substitution method as found in the ANSI C63.26-2015 document.
 Motorola Penang EMC Lab - Test Performed by: Nazrin&Qawiman Wed, Jun 10, 2020

Remarks: ** Indicates the spurious emission could not be detected due to noise limitations or ambient.
 *Pursuant to CFR 47 Part 2.1057 (c), emissions attenuated more than 20 dB below the permissible limit are not reported
 Temp(Deg): 25.3 Hum(%RH): 70.2

System MU: 4.03 dB

Remarks:	Passed Results	Marginal Results	Failed Results
----------	----------------	------------------	----------------

SAC Transmitter Radiated Emission:

Model Number: AAH56JDN9PA3AN **S/N: 627TWK0679** **SR:21594-EMC-00005**
Battery Part No: NNTN8386A **Accy Part No: NA**
Test Mode: TX Analog
161.70000 MHz **25 kHz** **6.000 Watt(s) /Max Power**

Frequency (MHz)	Limit	Horizontal Measured Emission Equiv Pwr Into Ideal Dipole (dBm)	Vertical Measured Emission Equiv Pwr Into ideal Dipole (dBm)
323.4000	-13.0000	-97.7453 **	-97.5014 **
485.1000	-13.0000	-90.2548 **	-90.6449 **
646.8000	-13.0000	-89.7322 **	-88.0799 **
808.5000	-13.0000	-86.3507 **	-86.1689 **
970.2000	-13.0000	-85.1910 **	-86.0759 **
1131.9000	-13.0000	-61.9654 **	-62.4290 **
1293.6000	-13.0000	-61.7272 **	-61.5150 **
1455.3000	-13.0000	-61.7145 **	-61.2307 **
1617.0000	-13.0000	-59.2892 **	-60.0155 **

RADIATED SPURIOUS EMISSIONS

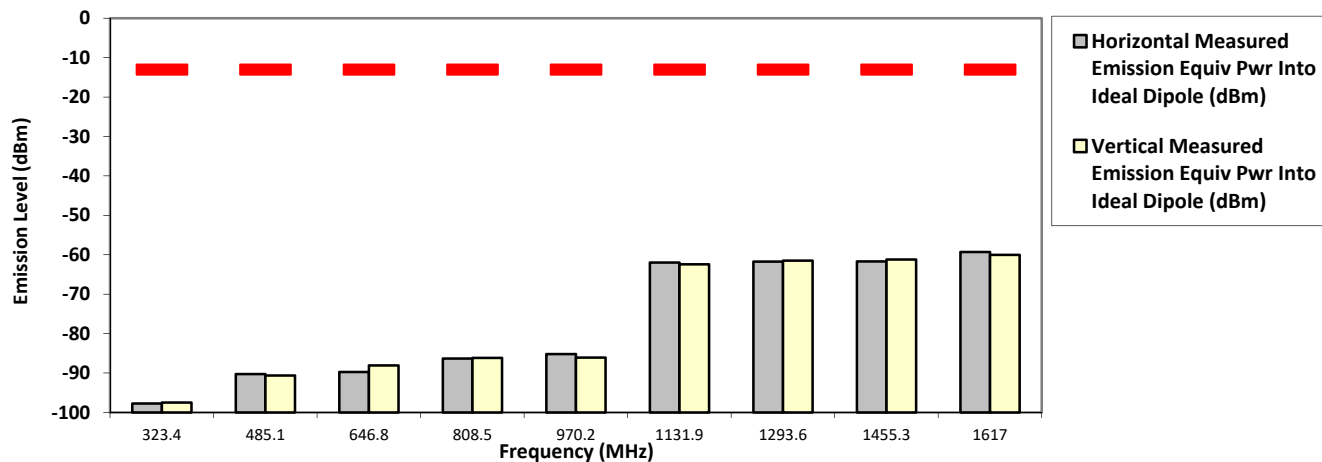

The data presented here was taken using the substitution method as found in the ANSI C63.26-2015 document.
 Motorola Penang EMC Lab - Test Performed by: Nazrin&Qawiman Wed, Jun 10, 2020

Remarks: ** Indicates the spurious emission could not be detected due to noise limitations or ambient.
 *Pursuant to CFR 47 Part 2.1057 (c), emissions attenuated more than 20 dB below the permissible limit are not reported
 Temp(Deg): 25.3 Hum(%RH): 70.2

System MU: 4.03 dB

Remarks: Passed Results Marginal Results Failed Results

SAC Transmitter Radiated Emission:

Model Number: AAH56JDN9PA3AN

S/N: 627TWK0679

SR:21594-EMC-00005

Battery Part No: NNTN8386A

Accy Part No: NA

173.387500 MHz

Test Mode: TX Analog
 25 kHz

1.000 Watt(s) /Low Power

Frequency (MHz)	Limit	Horizontal Measured Emission Equiv Pwr Into Ideal Dipole (dBm)	Vertical Measured Emission Equiv Pwr Into ideal Dipole (dBm)
346.7750	-13.0000	-96.4412 **	-96.4423 **
520.1625	-13.0000	-91.4330 **	-90.4893 **
693.5500	-13.0000	-88.1759 **	-89.1712 **
866.9375	-13.0000	-85.2773 **	-87.4006 **
1040.3250	-13.0000	-62.4841 **	-61.6640 **
1213.7125	-13.0000	-61.5409 **	-62.0230 **
1387.1000	-13.0000	-60.0719 **	-61.7739 **
1560.4875	-13.0000	-59.7157 **	-60.1808 **
1733.8750	-13.0000	-58.4178 **	-58.8028 **

RADIATED SPURIOUS EMISSIONS

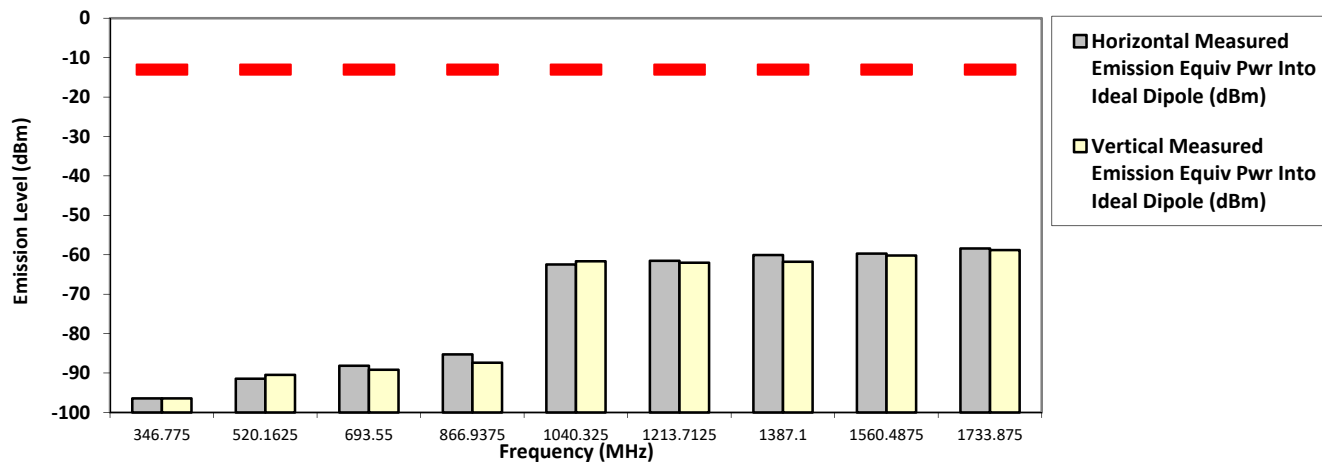

The data presented here was taken using the substitution method as found in the ANSI C63.26-2015 document.
 Motorola Penang EMC Lab - Test Performed by: Nazrin&Qawiman Wed, Jun 10, 2020

Remarks: ** Indicates the spurious emission could not be detected due to noise limitations or ambient.
 *Pursuant to CFR 47 Part 2.1057 (c), emissions attenuated more than 20 dB below the permissible limit are not reported
 Temp(Deg): 25.3 Hum(%RH): 70.2

System MU: 4.03 dB

Remarks:	Passed Results	Marginal Results	Failed Results
----------	----------------	------------------	----------------

SAC Transmitter Radiated Emission:

Model Number: AAH56JDN9PA3AN **S/N: 627TWK0679** **SR:21594-EMC-00005**
Battery Part No: NNTN8386A **Accy Part No: NA**
173.387500 MHz **Test Mode: TX Analog** **6.000 Watt(s) /Max Power**
25 kHz

Frequency (MHz)	Limit	Horizontal Measured Emission Equiv Pwr Into Ideal Dipole (dBm)	Vertical Measured Emission Equiv Pwr Into ideal Dipole (dBm)
346.7750	-13.0000	-94.7850 **	-97.0252 **
520.1625	-13.0000	-90.9603 **	-91.3860 **
693.5500	-13.0000	-88.5020 **	-89.1215 **
866.9375	-13.0000	-85.9826 **	-87.0533 **
1040.3250	-13.0000	-62.4660 **	-61.4567 **
1213.7125	-13.0000	-62.6589 **	-60.8015 **
1387.1000	-13.0000	-59.8276 **	-60.0891 **
1560.4875	-13.0000	-61.0606 **	-60.1394 **
1733.8750	-13.0000	-59.2240 **	-59.1494 **

RADIATED SPURIOUS EMISSIONS

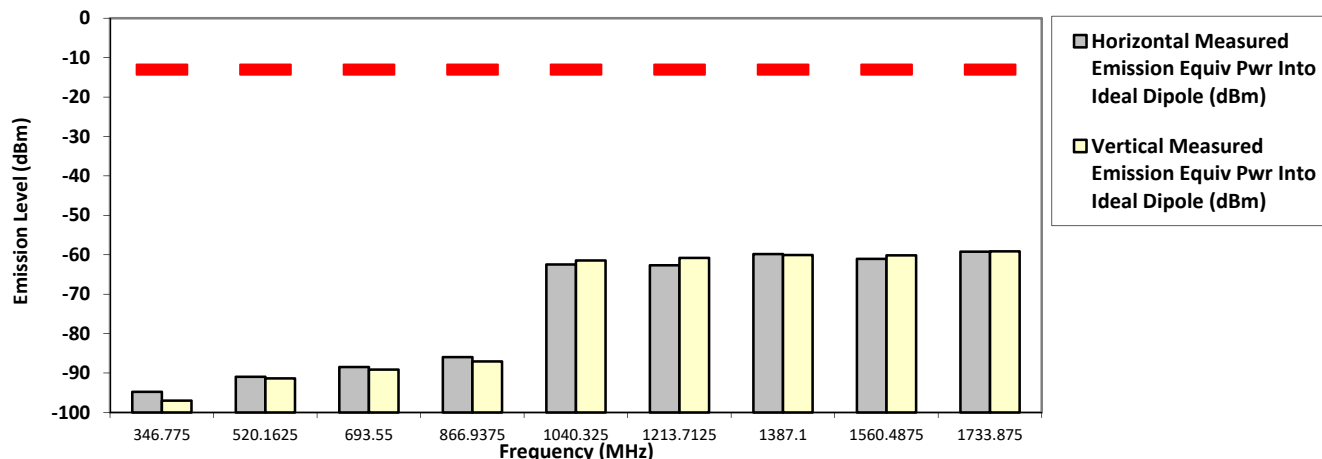

The data presented here was taken using the substitution method as found in the ANSI C63.26-2015 document.
 Motorola Penang EMC Lab - Test Performed by: Nazrin&Qawiman Wed, Jun 10, 2020

Remarks: ** Indicates the spurious emission could not be detected due to noise limitations or ambient.
 *Pursuant to CFR 47 Part 2.1057 (c), emissions attenuated more than 20 dB below the permissible limit are not reported
 Temp(Deg): 25.3 Hum(%RH): 70.2

System MU: 4.03 dB

Remarks: Passed Results Marginal Results Failed Results

SAC Transmitter Radiated Emission:

Model Number: AAH56JDN9PA3AN

S/N: 627TWK0679

SR:21594-EMC-00007

Battery Part No: NNTN8386A

Accy Part No: NNTN7616D-CF1

136.012500 MHz

**Test Mode: TX Analog
 25 kHz**

6.000 Watt(s) /Max Power

Frequency (MHz)	Limit	Horizontal Measured Emission Equiv Pwr Into Ideal Dipole (dBm)	Vertical Measured Emission Equiv Pwr Into ideal Dipole (dBm)
272.0250	-13.0000	-97.8393 **	-98.3427 **
408.0375	-13.0000	-94.2981 **	-94.1115 **
544.0500	-13.0000	-88.7395 **	-89.0699 **
680.0625	-13.0000	-88.2418 **	-88.1257 **
816.0750	-13.0000	-86.5939 **	-87.4154 **
952.0875	-13.0000	-84.8248 **	-84.9403 **
1088.1000	-13.0000	-61.0820 **	-59.0184 **
1224.1125	-13.0000	-61.4446 **	-60.5557 **
1360.1250	-13.0000	-60.8071 **	-60.3066 **

RADIATED SPURIOUS EMISSIONS

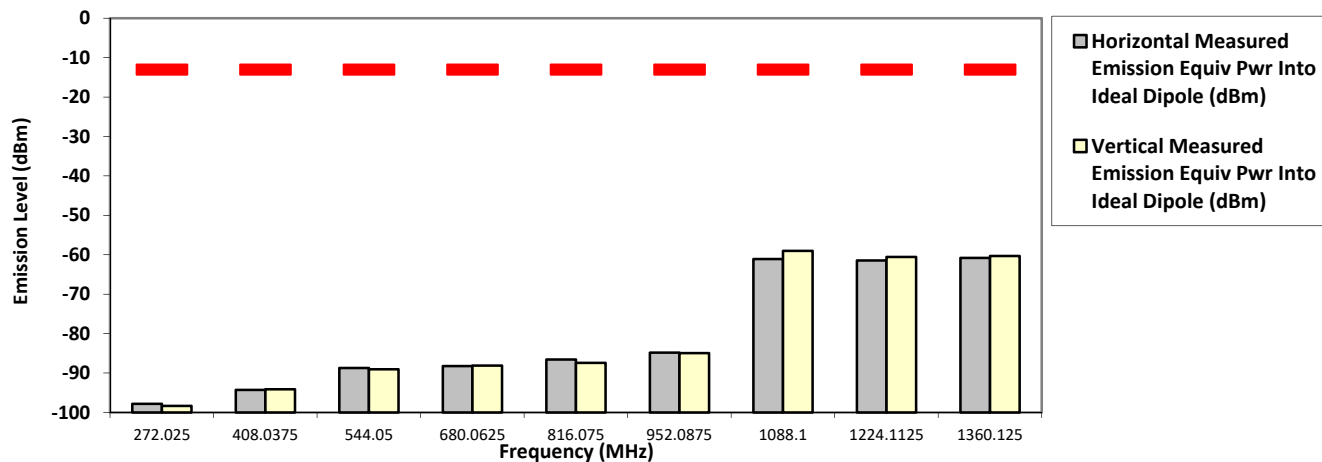

The data presented here was taken using the substitution method as found in the ANSI C63.26-2015 document.
 Motorola Penang EMC Lab - Test Performed by: Nazrin&Qawiman Fri, Jun 12, 2020

Remarks: ** Indicates the spurious emission could not be detected due to noise limitations or ambient.
 *Pursuant to CFR 47 Part 2.1057 (c), emissions attenuated more than 20 dB below the permissible limit are not reported
 Temp(Deg): 23.7 Hum(%RH): 69.4

System MU: 4.03 dB

Remarks:	Passed Results	Marginal Results	Failed Results
----------	----------------	------------------	----------------

SAC Transmitter Radiated Emission:
Model Number: AAH56JDN9PA3AN **S/N: 627TWK0679** **SR:21594-EMC-00005**
Battery Part No: NNTN8386A **Accy Part No: NA**
Test Mode: TX PCR Digital 4FSK
136.012500 MHz **12.5 kHz** **6.000 Watt(s) /Max Power**

Frequency (MHz)	Limit	Horizontal Measured Emission Equiv Pwr Into Ideal Dipole (dBm)	Vertical Measured Emission Equiv Pwr Into ideal Dipole (dBm)
272.0250	-20.0000	-99.1354 **	-97.8965 **
408.0375	-20.0000	-94.2534 **	-93.1257 **
544.0500	-20.0000	-89.2776 **	-88.8334 **
680.0625	-20.0000	-89.2708 **	-88.6930 **
816.0750	-20.0000	-86.2338 **	-86.7232 **
952.0875	-20.0000	-85.9651 **	-86.7145 **
1088.1000	-20.0000	-61.1485 **	-60.3119 **
1224.1125	-20.0000	-61.9418 **	-62.0541 **
1360.1250	-20.0000	-60.9082 **	-61.5387 **

RADIATED SPURIOUS EMISSIONS

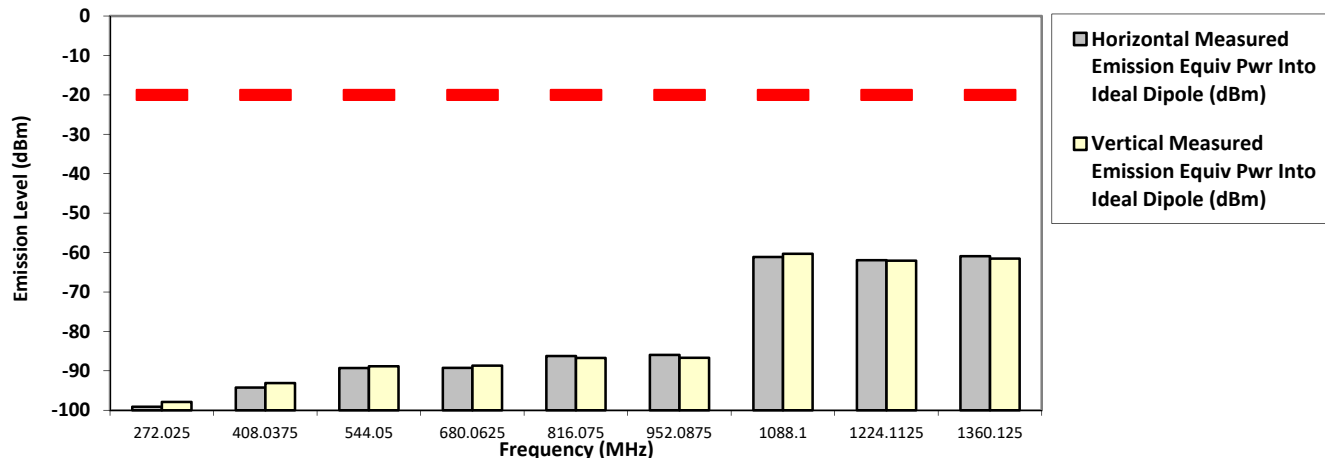

The data presented here was taken using the substitution method as found in the ANSI C63.26-2015 document.
 Motorola Penang EMC Lab - Test Performed by: Nazrin&Qawiman Wed, Jun 10, 2020

Remarks: ** Indicates the spurious emission could not be detected due to noise limitations or ambient.
 *Pursuant to CFR 47 Part 2.1057 (c), emissions attenuated more than 20 dB below the permissible limit are not reported
 Temp(Deg): 25.3 Hum(%RH): 70.2

System MU: 4.03 dB

Remarks:	Passed Results	Marginal Results	Failed Results
----------	----------------	------------------	----------------

SAC Transmitter Radiated Emission:

Model Number: AAH56JDN9PA3AN S/N: 627TWK0679 SR:21594-EMC-00005
 Battery Part No: NNTN8386A Accy Part No: NA
 Test Mode: TX PCR Digital 4FSK
 138.012500 MHz 12.5 kHz 1.000 Watt(s) /Low Power

Frequency (MHz)	Limit	Horizontal Measured Emission Equiv Pwr Into Ideal Dipole (dBm)	Vertical Measured Emission Equiv Pwr Into ideal Dipole (dBm)
276.0250	-20.0000	-98.8738 **	-97.9569 **
414.0375	-20.0000	-92.9179 **	-92.2569 **
552.0500	-20.0000	-87.8384 **	-87.9670 **
690.0625	-20.0000	-88.8487 **	-87.2714 **
828.0750	-20.0000	-87.1242 **	-86.7190 **
966.0875	-20.0000	-84.6357 **	-85.8335 **
1104.1000	-20.0000	-61.9665 **	-61.9289 **
1242.1125	-20.0000	-62.2760 **	-61.6729 **
1380.1250	-20.0000	-60.6044 **	-61.7495 **

RADIATED SPURIOUS EMISSIONS

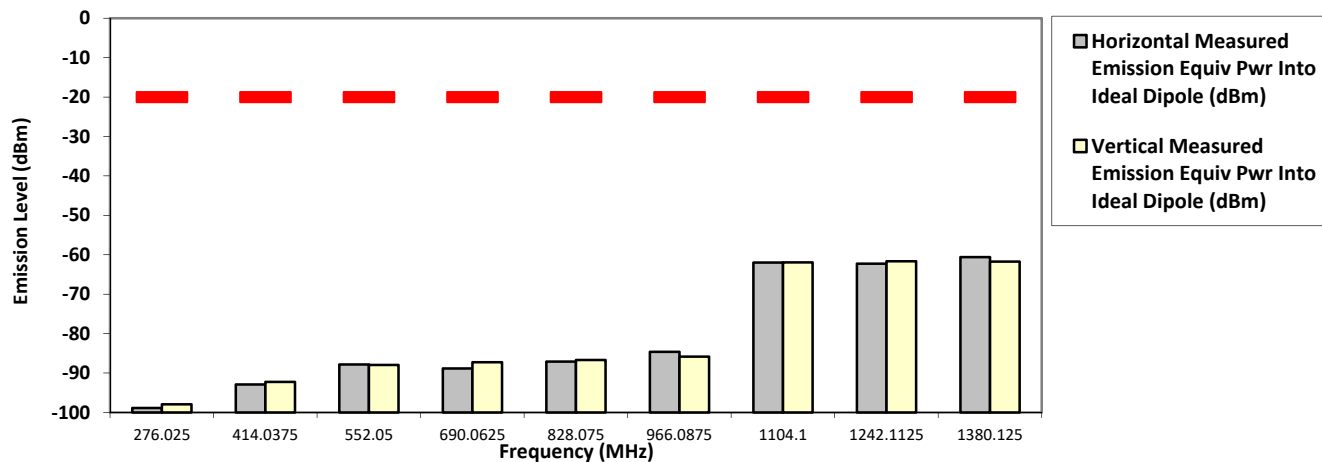

The data presented here was taken using the substitution method as found in the ANSI C63.26-2015 document.
 Motorola Penang EMC Lab - Test Performed by: Nazrin&Qawiman Wed, Jun 10, 2020

Remarks: ** Indicates the spurious emission could not be detected due to noise limitations or ambient.
 *Pursuant to CFR 47 Part 2.1057 (c), emissions attenuated more than 20 dB below the permissible limit are not reported
 Temp(Deg): 25.3 Hum(%RH): 70.2

System MU: 4.03 dB

Remarks:	Passed Results	Marginal Results	Failed Results
----------	----------------	------------------	----------------

SAC Transmitter Radiated Emission:

Model Number: AAH56JDN9PA3AN S/N: 627TWK0679 SR:21594-EMC-00005
 Battery Part No: NNTN8386A Accy Part No: NA
 Test Mode: TX PCR Digital 4FSK
 138.012500 MHz 12.5 kHz 6.000 Watt(s) /Max Power

Frequency (MHz)	Limit	Horizontal Measured Emission Equiv Pwr Into Ideal Dipole (dBm)	Vertical Measured Emission Equiv Pwr Into ideal Dipole (dBm)
276.0250	-20.0000	-98.0281 **	-97.7446 **
414.0375	-20.0000	-94.2278 **	-93.6389 **
552.0500	-20.0000	-87.9467 **	-88.4017 **
690.0625	-20.0000	-88.9687 **	-88.2985 **
828.0750	-20.0000	-85.5924 **	-87.7124 **
966.0875	-20.0000	-85.8806 **	-85.7073 **
1104.1000	-20.0000	-62.4999 **	-61.0452 **
1242.1125	-20.0000	-61.7145 **	-61.0203 **
1380.1250	-20.0000	-61.5544 **	-61.5402 **

RADIATED SPURIOUS EMISSIONS

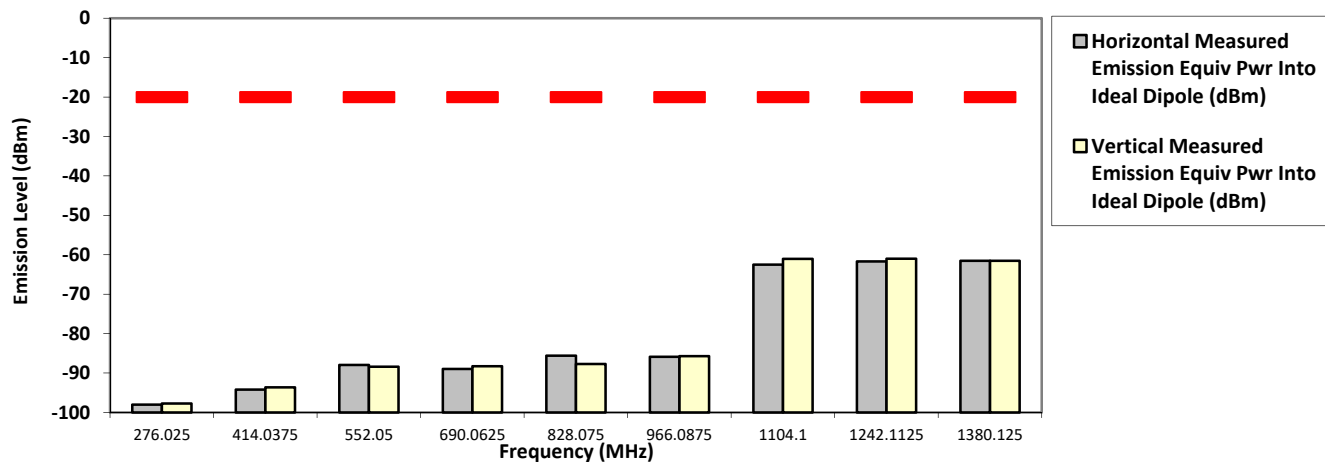

The data presented here was taken using the substitution method as found in the ANSI C63.26-2015 document.
 Motorola Penang EMC Lab - Test Performed by: Nazrin&Qawiman Wed, Jun 10, 2020

Remarks: ** Indicates the spurious emission could not be detected due to noise limitations or ambient.
 *Pursuant to CFR 47 Part 2.1057 (c), emissions attenuated more than 20 dB below the permissible limit are not reported
 Temp(Deg): 25.3 Hum(%RH): 70.2

System MU: 4.03 dB

Remarks:

Passed Results	Marginal Results	Failed Results
----------------	------------------	----------------

SAC Transmitter Radiated Emission:
Model Number: AAH56JDN9PA3AN **S/N: 627TWK0679** **SR:21594-EMC-00005**
Battery Part No: NNTN8386A **Accy Part No: NA**
Test Mode: TX PCR Digital 4FSK
158.550000 MHz **12.5 kHz** **1.000 Watt(s) /Low Power**

Frequency (MHz)	Limit	Horizontal Measured Emission Equip Pwr Into Ideal Dipole (dBm)	Vertical Measured Emission Equip Pwr Into ideal Dipole (dBm)
317.1000	-20.0000	-97.5189 **	-96.7103 **
475.6500	-20.0000	-91.7475 **	-91.8195 **
634.2000	-20.0000	-87.4775 **	-87.9712 **
792.7500	-20.0000	-87.3764 **	-87.8239 **
951.3000	-20.0000	-85.7682 **	-85.7305 **
1109.8500	-20.0000	-62.8257 **	-61.7459 **
1268.4000	-20.0000	-60.9336 **	-61.4835 **
1426.9500	-20.0000	-60.1537 **	-61.1531 **
1585.5000	-20.0000	-59.7046 **	-60.5062 **

RADIATED SPURIOUS EMISSIONS

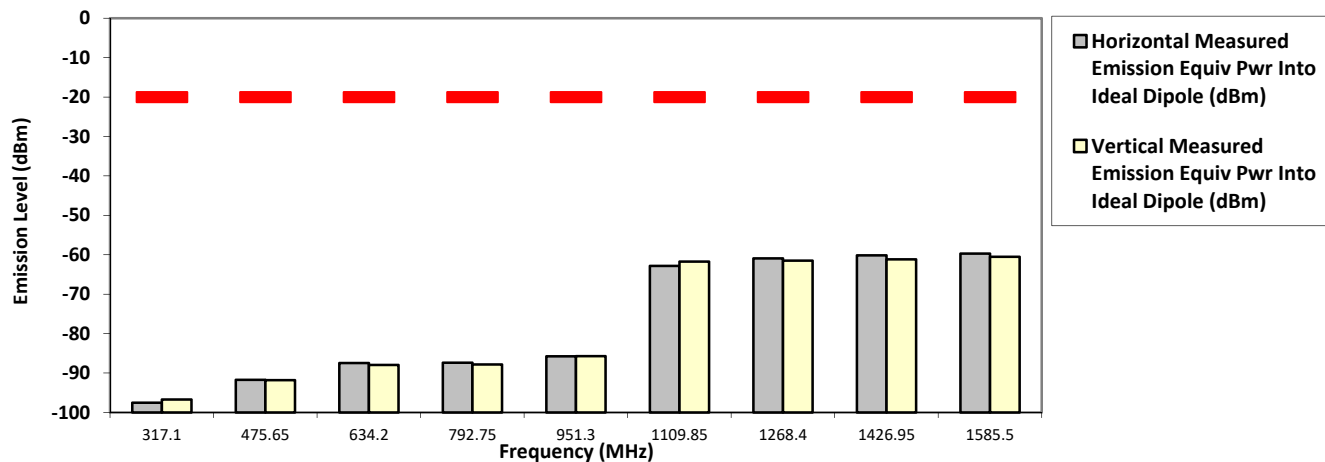

The data presented here was taken using the substitution method as found in the ANSI C63.26-2015 document.
 Motorola Penang EMC Lab - Test Performed by: Nazrin&Qawiman Wed, Jun 10, 2020

Remarks: ** Indicates the spurious emission could not be detected due to noise limitations or ambient.
 *Pursuant to CFR 47 Part 2.1057 (c), emissions attenuated more than 20 dB below the permissible limit are not reported
 Temp(Deg): 25.3 Hum(%RH): 70.2

System MU: 4.03 dB

Remarks: Passed Results Marginal Results Failed Results

SAC Transmitter Radiated Emission:

Model Number: AAH56JDN9PA3AN **S/N: 627TWK0679** **SR:21594-EMC-00005**
Battery Part No: NNTN8386A **Accy Part No: NA**
Test Mode: TX PCR Digital 4FSK
158.550000 MHz **12.5 kHz** **6.000 Watt(s) /Max Power**

Frequency (MHz)	Limit	Horizontal Measured Emission Equiv Pwr Into Ideal Dipole (dBm)	Vertical Measured Emission Equiv Pwr Into ideal Dipole (dBm)
317.1000	-20.0000	-97.4504 **	-96.5203 **
475.6500	-20.0000	-91.4653 **	-91.2759 **
634.2000	-20.0000	-89.9212 **	-86.5977 **
792.7500	-20.0000	-86.7451 **	-87.3834 **
951.3000	-20.0000	-86.1357 **	-85.5510 **
1109.8500	-20.0000	-61.7378 **	-62.1607 **
1268.4000	-20.0000	-61.8027 **	-61.7357 **
1426.9500	-20.0000	-62.0589 **	-61.3271 **
1585.5000	-20.0000	-60.6792 **	-60.1650 **

RADIATED SPURIOUS EMISSIONS

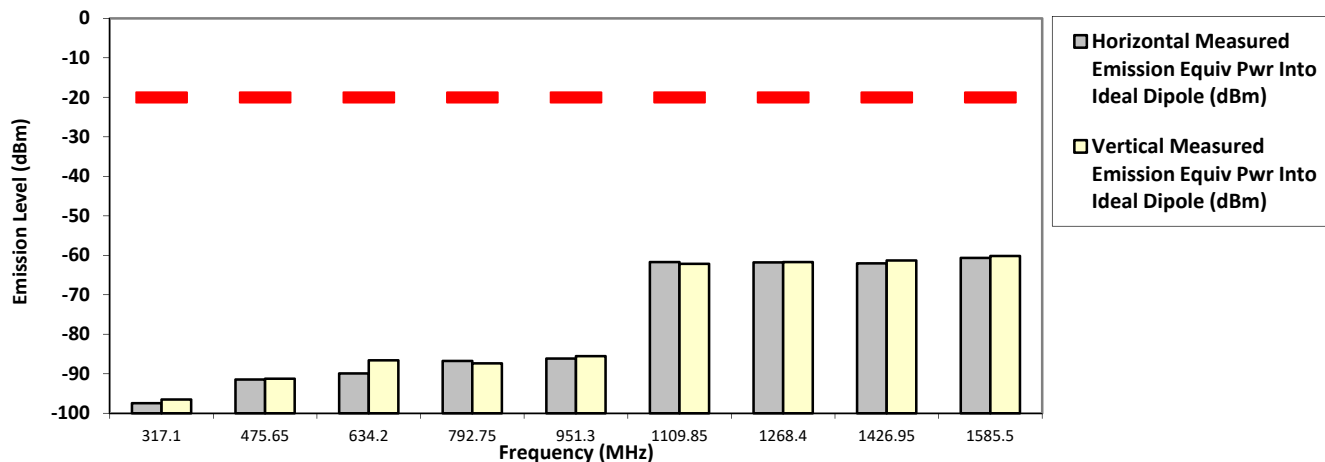

The data presented here was taken using the substitution method as found in the ANSI C63.26-2015 document.
 Motorola Penang EMC Lab - Test Performed by: Nazrin&Qawiman Wed, Jun 10, 2020

Remarks: ** Indicates the spurious emission could not be detected due to noise limitations or ambient.
 *Pursuant to CFR 47 Part 2.1057 (c), emissions attenuated more than 20 dB below the permissible limit are not reported
 Temp(Deg): 25.3 Hum(%RH): 70.2

System MU: 4.03 dB

Remarks:	Passed Results	Marginal Results	Failed Results
----------	----------------	------------------	----------------

SAC Transmitter Radiated Emission:

Model Number: AAH56JDN9PA3AN S/N: 627TWK0679 SR:21594-EMC-00005
 Battery Part No: NNTN8386A Accy Part No: NA
 Test Mode: TX PCR Digital 4FSK
 161.700000 MHz 12.5 kHz 1.000 Watt(s) /Low Power

Frequency (MHz)	Limit	Horizontal Measured Emission Equiv Pwr Into Ideal Dipole (dBm)	Vertical Measured Emission Equiv Pwr Into ideal Dipole (dBm)
323.4000	-20.0000	-97.4530 **	-97.4082 **
485.1000	-20.0000	-90.2472 **	-91.1290 **
646.8000	-20.0000	-88.4452 **	-89.2653 **
808.5000	-20.0000	-86.7945 **	-86.8042 **
970.2000	-20.0000	-85.1038 **	-85.3987 **
1131.9000	-20.0000	-61.8516 **	-61.7096 **
1293.6000	-20.0000	-62.0104 **	-61.7484 **
1455.3000	-20.0000	-60.8091 **	-61.8233 **
1617.0000	-20.0000	-60.5465 **	-59.5565 **

RADIATED SPURIOUS EMISSIONS

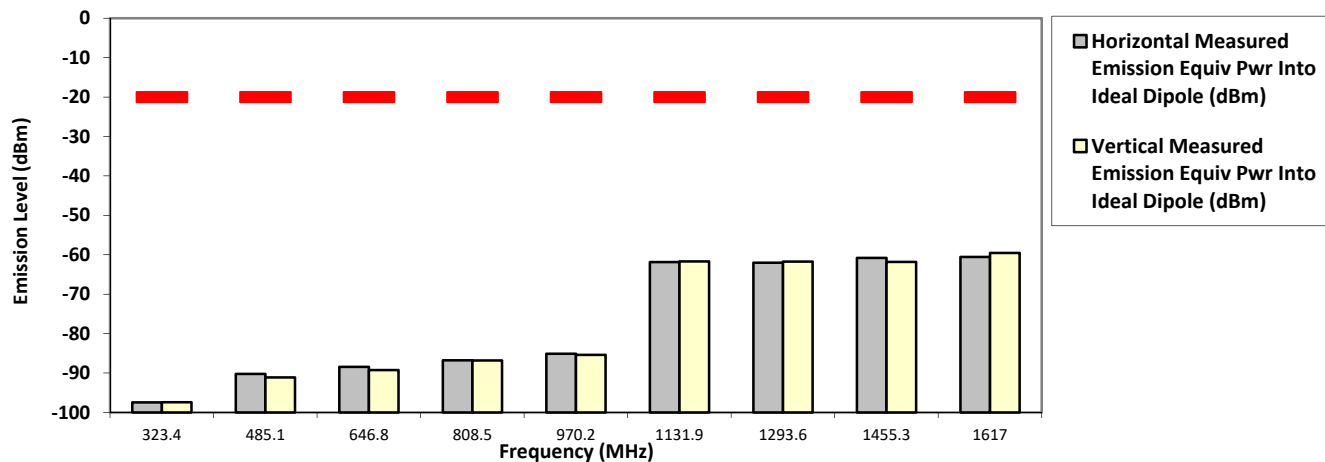

The data presented here was taken using the substitution method as found in the ANSI C63.26-2015 document.
 Motorola Penang EMC Lab - Test Performed by: Nazrin&Qawiman Wed, Jun 10, 2020

Remarks: ** Indicates the spurious emission could not be detected due to noise limitations or ambient.
 *Pursuant to CFR 47 Part 2.1057 (c), emissions attenuated more than 20 dB below the permissible limit are not reported
 Temp(Deg): 25.3 Hum(%RH): 70.2

System MU: 4.03 dB

Remarks: Passed Results Marginal Results Failed Results

SAC Transmitter Radiated Emission:

Model Number: AAH56JDN9PA3AN **S/N: 627TWK0679** **SR:21594-EMC-00005**
Battery Part No: NNTN8386A **Accy Part No: NA**
Test Mode: TX PCR Digital 4FSK
161.700000 MHz **12.5 kHz** **6.000 Watt(s) /Max Power**

Frequency (MHz)	Limit	Horizontal Measured Emission Equiv Pwr Into Ideal Dipole (dBm)	Vertical Measured Emission Equiv Pwr Into ideal Dipole (dBm)
323.4000	-20.0000	-98.1082 **	-96.7335 **
485.1000	-20.0000	-90.5890 **	-91.4412 **
646.8000	-20.0000	-88.7866 **	-88.2151 **
808.5000	-20.0000	-87.7661 **	-86.7031 **
970.2000	-20.0000	-84.9850 **	-85.6183 **
1131.9000	-20.0000	-61.4565 **	-61.7395 **
1293.6000	-20.0000	-60.5493 **	-61.4871 **
1455.3000	-20.0000	-61.2087 **	-61.5120 **
1617.0000	-20.0000	-58.8119 **	-60.0097 **

RADIATED SPURIOUS EMISSIONS

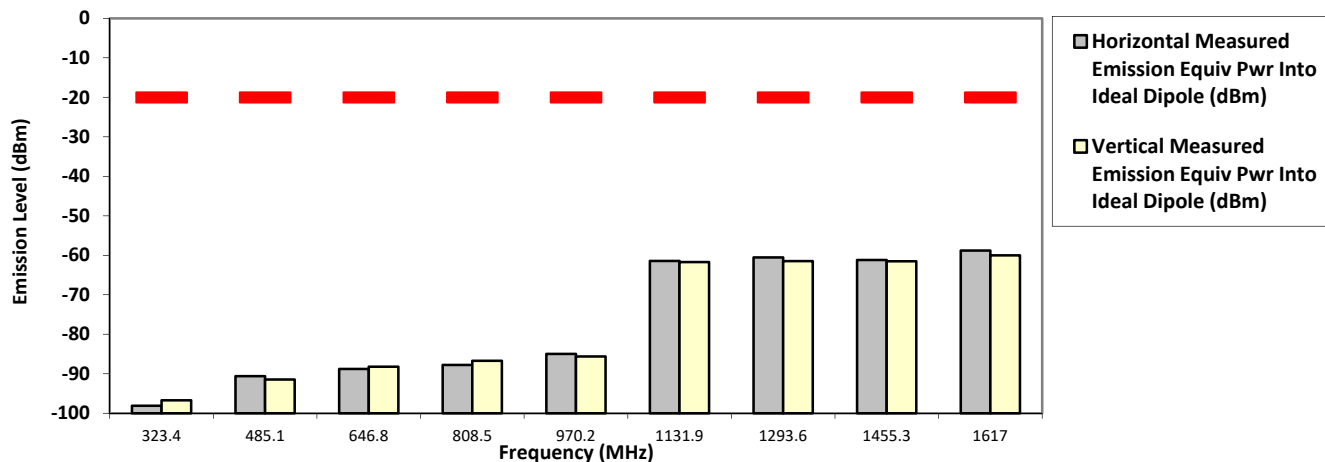

The data presented here was taken using the substitution method as found in the ANSI C63.26-2015 document.
 Motorola Penang EMC Lab - Test Performed by: Nazrin&Qawiman Wed, Jun 10, 2020

Remarks: ** Indicates the spurious emission could not be detected due to noise limitations or ambient.
 *Pursuant to CFR 47 Part 2.1057 (c), emissions attenuated more than 20 dB below the permissible limit are not reported
 Temp(Deg): 25.3 Hum(%RH): 70.2

System MU: 4.03 dB

Remarks:	Passed Results	Marginal Results	Failed Results
-----------------	----------------	------------------	----------------

SAC Transmitter Radiated Emission:

Model Number: AAH56JDN9PA3AN **S/N: 627TWK0679** **SR:21594-EMC-00005**
Battery Part No: NNTN8386A **Accy Part No: NA**
Test Mode: TX PCR Digital 4FSK
173.387500 MHz **12.5 kHz** **1.000 Watt(s) /Low Power**

Frequency (MHz)	Limit	Horizontal Measured Emission Equip Pwr Into Ideal Dipole (dBm)	Vertical Measured Emission Equip Pwr Into ideal Dipole (dBm)
346.7750	-20.0000	-95.3674 **	-96.7214 **
520.1625	-20.0000	-90.6371 **	-91.0605 **
693.5500	-20.0000	-88.5374 **	-87.8349 **
866.9375	-20.0000	-87.6512 **	-87.0247 **
1040.3250	-20.0000	-60.9421 **	-62.3124 **
1213.7125	-20.0000	-61.7852 **	-61.3319 **
1387.1000	-20.0000	-61.1628 **	-60.0521 **
1560.4875	-20.0000	-60.5558 **	-59.4111 **
1733.8750	-20.0000	-59.2323 **	-58.5501 **

RADIATED SPURIOUS EMISSIONS

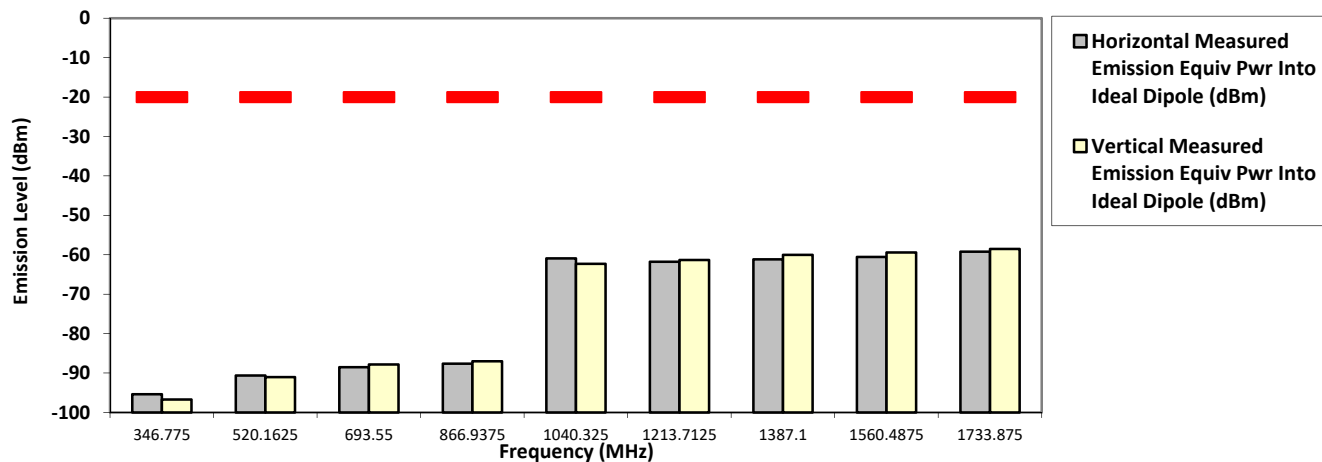

The data presented here was taken using the substitution method as found in the ANSI C63.26-2015 document.
 Motorola Penang EMC Lab - Test Performed by: Nazrin&Qawiman Wed, Jun 10, 2020

Remarks: ** Indicates the spurious emission could not be detected due to noise limitations or ambient.
 *Pursuant to CFR 47 Part 2.1057 (c), emissions attenuated more than 20 dB below the permissible limit are not reported
 Temp(Deg): 25.3 Hum(%RH): 70.2

System MU: 4.03 dB

Remarks: Passed Results Marginal Results Failed Results

SAC Transmitter Radiated Emission:

Model Number: AAH56JDN9PA3AN S/N: 627TWK0679 SR:21594-EMC-00005
 Battery Part No: NNTN8386A Accy Part No: NA
 Test Mode: TX PCR Digital 4FSK
 173.387500 MHz 12.5 kHz 6.000 Watt(s) /Max Power

Frequency (MHz)	Limit	Horizontal Measured Emission Equiv Pwr Into Ideal Dipole (dBm)	Vertical Measured Emission Equiv Pwr Into ideal Dipole (dBm)
346.7750	-20.0000	-94.9305 **	-96.3055 **
520.1625	-20.0000	-91.3175 **	-92.1518 **
693.5500	-20.0000	-89.0379 **	-89.0277 **
866.9375	-20.0000	-87.3447 **	-85.9613 **
1040.3250	-20.0000	-63.0239 **	-62.9969 **
1213.7125	-20.0000	-61.8858 **	-62.4437 **
1387.1000	-20.0000	-61.0098 **	-60.7820 **
1560.4875	-20.0000	-59.5831 **	-59.2136 **
1733.8750	-20.0000	-58.7944 **	-59.8387 **

RADIATED SPURIOUS EMISSIONS

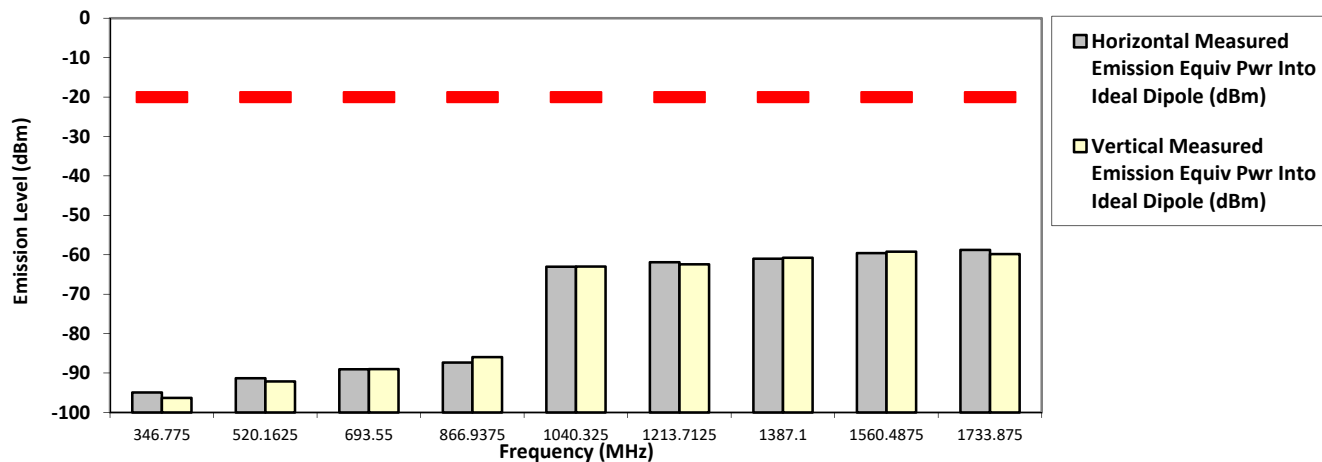

The data presented here was taken using the substitution method as found in the ANSI C63.26-2015 document.
 Motorola Penang EMC Lab - Test Performed by: Nazrin&Qawiman Wed, Jun 10, 2020

Remarks: ** Indicates the spurious emission could not be detected due to noise limitations or ambient.
 *Pursuant to CFR 47 Part 2.1057 (c), emissions attenuated more than 20 dB below the permissible limit are not reported
 Temp(Deg): 25.3 Hum(%RH): 70.2

System MU: 4.03 dB

Remarks:	Passed Results	Marginal Results	Failed Results
----------	----------------	------------------	----------------

6.11.4. Test Limit

Table below summarized the power of any emission outside a licensee’s frequency block shall be attenuated below the transmitter power (P) by at least

Channel Spacing	Part 22	Part 24D	Part 74	Part 80	Part 90 (UHF, VHF, 800, 900)	Part 90 (700)
12.5kHz	43 + log ₁₀ (P) (-13 dBm)	43 + log ₁₀ (P) (-13 dBm)	43 + log ₁₀ (P) (-13 dBm)	Not Applicable	50 + log ₁₀ (P) (-20 dBm)	43 + log ₁₀ (P) (-13 dBm)
25kHz		Not Applicable		43 + log ₁₀ (P) (-13 dBm)	43 + log ₁₀ (P) (-13 dBm)	

Channel Spacing	RSS 134	RSS 182	RSS 119 (UHF, VHF, 800, 900)	RSS 119 (700)
12.5kHz	43 + log ₁₀ (P) (-13 dBm)	Not Applicable	50 + log ₁₀ (P) (-20 dBm)	43 + log ₁₀ (P) (-13 dBm)
25kHz	Not Applicable	43 + log ₁₀ (P) (-13 dBm)	43 + log ₁₀ (P) (-13 dBm)	43 + log ₁₀ (P) (-13 dBm)

6.12. Effective Radiated Power (ERP)

6.12.1. Test Setup

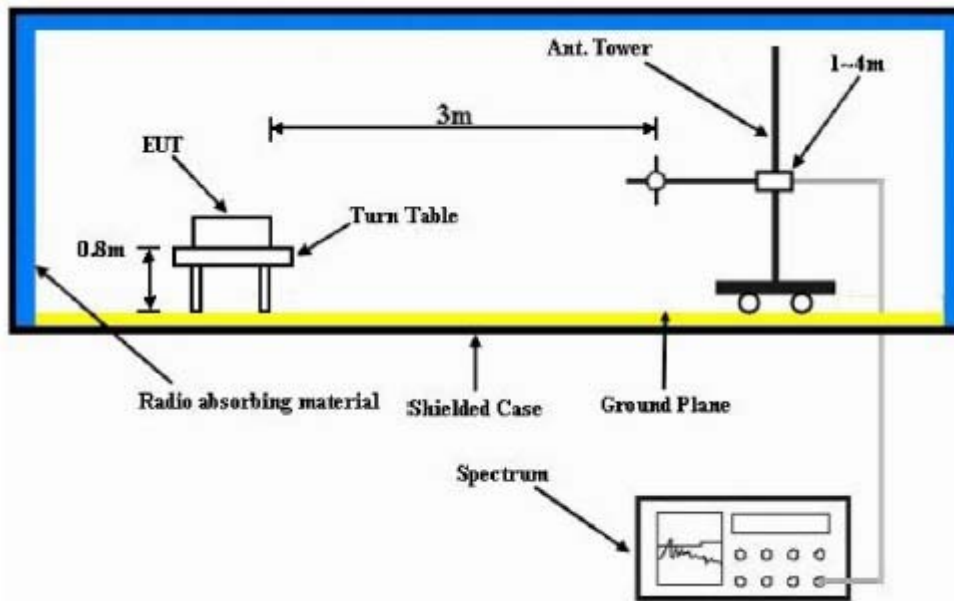

- 1) The Resolution Bandwidth for Equivalent Radiated Power (ERP) below 1 GHz is 100 kHz with Video Bandwidth = 300 kHz and Resolution Bandwidth for EIRP above 1 GHz is 1 MHz with Video Bandwidth = 3 MHz. Detector Mode is RMS.
- 2) In the semi-anechoic chamber, setup as illustrated above the DUT placed on the 0.8m height (for $f_c < 1\text{GHz}$) or 1.5m (for $f_c > 1\text{GHz}$) of Turn Table, rotated the table 45 degree each interval to search the maximum radiation power and receiver antenna shall be rotated vertical and horizontal polarization and moved height from 1m to 4m to find the maximum polar radiated power for each degree interval. The “Read Value” is the spectrum reading of maximum power value.
- 3) The substitution antenna is substituted for DUT at the same position and signals generator (S.G) export the CW signal to the substitution antenna via a TX cable. The receiver antenna shall be rotated vertical and horizontal polarization and moved height from 1m to 4m to find the maximum radiation power. Record the power level of maximum radiation power from spectrum. So, the Measured substitution value = Ref level of S.G + TX cables loss – Substituted Antenna Gain.

6.12.2. Test Result

Not Applicable

6.12.3. Test Limit

The maximum output power of the transmitter for mobile stations is 100 watts (20 dB). Power is given in terms of effective radiated power (ERP).

6.13. GNSS (EIRP for 1559 - 1610MHz)

6.13.1. Test Setup

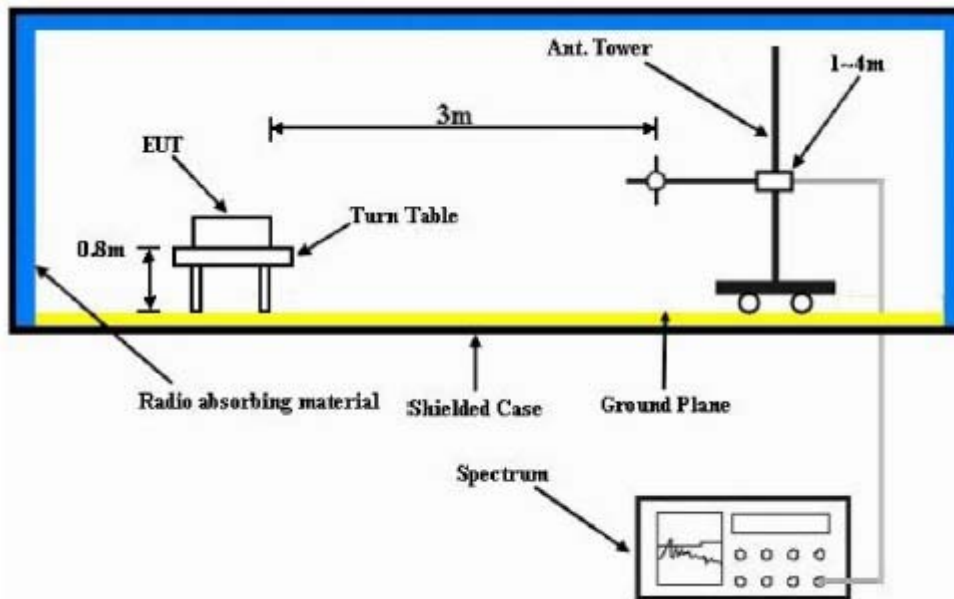

- 4) The Resolution Bandwidth for Equivalent Isotropically Radiated Power (EIRP) below 1 GHz is 100 kHz with Video Bandwidth = 300 kHz and Resolution Bandwidth for EIRP above 1 GHz is 1 MHz with Video Bandwidth = 3 MHz. Detector Mode is RMS.
- 5) In the semi-anechoic chamber, setup as illustrated above the DUT placed on the 0.8m height of Turn Table, rotated the table 45 degree each interval to search the maximum radiation power and receiver antenna shall be rotated vertical and horizontal polarization and moved height from 1m to 4m to find the maximum polar radiated power for each degree interval. The “Read Value” is the spectrum reading of maximum power value.
- 6) The substitution antenna is substituted for DUT at the same position and signals generator (S.G) export the CW signal to the substitution antenna via a TX cable. The receiver antenna shall be rotated vertical and horizontal polarization and moved height from 1m to 4m to find the maximum radiation power. Record the power level of maximum radiation power from spectrum. So, the Measured substitution value = Ref level of S.G + TX cables loss – Substituted Antenna Gain.
- 7) $EIRP = \text{“Read Value”} + \text{Measured substitution value} + 2.15$.

6.13.1. Test Result

Not Applicable

6.13.2. Test Limit

For operations in the 758-775 MHz and 788-805 MHz bands, all emissions including harmonics in the band 1559-1610 MHz shall be limited to -70 dBW/MHz equivalent isotropically radiated power (EIRP) for wideband signals, and -80 dBW EIRP for discrete emissions of less than 700 Hz bandwidth.

~ End of Test Report ~