



# FCC RADIO TEST REPORT

**FCC ID** : ACJFZN1E  
**Equipment** : Tablet Computer  
**Brand Name** : Panasonic  
**Model Name** : FZ-N1KB  
**Marketing Name** : FZ-N1  
**Applicant** : Panasonic Corporation of North America  
Two Riverfront Plaza, 9th Floor, Newark, NJ  
07102-5490  
**Manufacturer** : Panasonic Mobile Communications Co., Ltd.  
600 Saedo-cho, Tsuzuki-ku, Yokohama City  
224-8539, Japan  
**Standard** : FCC Part 15 Subpart C §15.247

The product was received on Apr. 22, 2020 and testing was started from Apr. 24, 2020 and completed on May 22, 2020. We, SPORTON INTERNATIONAL INC., EMC & Wireless Communications Laboratory, would like to declare that the tested sample has been evaluated in accordance with the test procedures and has been in compliance with the applicable technical standards.

The report must not be used by the client to claim product certification, approval, or endorsement by TAF or any agency of government.

The test results in this report apply exclusively to the tested model / sample. Without written approval of SPORTON INTERNATIONAL INC. EMC & Wireless Communications Laboratory, the test report shall not be reproduced except in full.

*Louis Wu*

Approved by: Louis Wu

**SPORTON INTERNATIONAL INC. EMC & Wireless Communications Laboratory**

No. 52, Huaya 1st Rd., Guishan Dist., Taoyuan City, Taiwan (R.O.C.)



## Table of Contents

History of this test report.....	3
Summary of Test Result.....	4
<b>1 General Description .....</b>	<b>5</b>
1.1 Product Feature of Equipment Under Test.....	5
1.2 Modification of EUT .....	5
1.3 Testing Location .....	6
1.4 Applicable Standards.....	6
<b>2 Test Configuration of Equipment Under Test .....</b>	<b>7</b>
2.1 Carrier Frequency and Channel .....	7
2.2 Test Mode.....	8
2.3 Connection Diagram of Test System.....	9
2.4 Support Unit used in test configuration and system .....	10
2.5 EUT Operation Test Setup .....	10
2.6 Measurement Results Explanation Example.....	10
<b>3 Test Result .....</b>	<b>11</b>
3.1 6dB and 99% Bandwidth Measurement .....	11
3.2 Output Power Measurement.....	13
3.3 Power Spectral Density Measurement .....	14
3.4 Conducted Band Edges and Spurious Emission Measurement .....	16
3.5 Radiated Band Edges and Spurious Emission Measurement .....	30
3.6 AC Conducted Emission Measurement.....	34
3.7 Antenna Requirements .....	36
<b>4 List of Measuring Equipment.....</b>	<b>37</b>
<b>5 Uncertainty of Evaluation .....</b>	<b>39</b>
<b>Appendix A. Conducted Test Results</b>	
<b>Appendix B. AC Conducted Emission Test Result</b>	
<b>Appendix C. Radiated Spurious Emission</b>	
<b>Appendix D. Radiated Spurious Emission Plots</b>	
<b>Appendix E. Duty Cycle Plots</b>	
<b>Appendix F. Setup Photographs</b>	





### Summary of Test Result

Report Clause	Ref Std. Clause	Test Items	Result (PASS/FAIL)	Remark
3.1	15.247(a)(2)	6dB Bandwidth	Pass	-
3.1	2.1049	99% Occupied Bandwidth	Reporting only	-
3.2	15.247(b)	Power Output Measurement	Pass	-
3.3	15.247(e)	Power Spectral Density	Pass	-
3.4	15.247(d)	Conducted Band Edges	Pass	-
		Conducted Spurious Emission	Pass	-
3.5	15.247(d)	Radiated Band Edges and Radiated Spurious Emission	Pass	Under limit 5.80 dB at 2483.500 MHz
3.6	15.207	AC Conducted Emission	Pass	Under limit 15.65 dB at 0.183 MHz
3.7	15.203 & 15.247(b)	Antenna Requirement	Pass	-

**Declaration of Conformity:**

The test results with all measurement uncertainty excluded are presented in accordance with the regulation limits or requirements declared by manufacturers.

**Comments and Explanations:**

The declared of product specification for EUT presented in the report are provided by the manufacturer, and the manufacturer takes all the responsibilities for the accuracy of product specification.

**Reviewed by: Wii Chang**

**Report Producer: Celery Wei**



# 1 General Description

## 1.1 Product Feature of Equipment Under Test

WCDMA/LTE, Bluetooth, Wi-Fi 2.4GHz 802.11b/g/n/ac, Wi-Fi 5GHz 802.11a/n/ac, NFC, and GNSS.

Product Specification subjective to this standard	
<b>Antenna Type</b>	WWAN: Fixed Internal Antenna WLAN: Monopole Antenna Bluetooth: Monopole Antenna GPS / Glonass: Monopole Antenna NFC: Loop Antenna

Accessories Information		
<b>Cradle</b>	<b>Brand Name</b>	Panasonic
	<b>Model Name</b>	FZ-VEBN111A
<b>AC Adapter 1</b>	<b>Brand Name</b>	Panasonic
	<b>Model Name</b>	CF-AA6413A
<b>AC Adapter 2</b>	<b>Brand Name</b>	Panasonic
	<b>Model Name</b>	FZ-AAE184EM
<b>USB Cable 1</b>	<b>Brand Name</b>	Panasonic
	<b>Model Name</b>	K2KYYYY00221
<b>USB Cable 2</b>	<b>Brand Name</b>	N/A
	<b>Model Name</b>	SPA-US15
<b>Battery</b>	<b>Brand Name</b>	Panasonic
	<b>Model Name</b>	FZ-VZSUN110U

## 1.2 Modification of EUT

No modifications are made to the EUT during all test items.



### 1.3 Testing Location

<b>Test Site</b>	SPORTON INTERNATIONAL INC. EMC & Wireless Communications Laboratory	
<b>Test Site Location</b>	No.52, Huaya 1st Rd., Guishan Dist., Taoyuan City, Taiwan (R.O.C.) TEL: +886-3-327-3456 FAX: +886-3-328-4978	
<b>Test Site No.</b>	<b>Sporton Site No.</b>	
	TH05-HY	CO05-HY

**Note:** The test site complies with ANSI C63.4 2014 requirement.

<b>Test Site</b>	SPORTON INTERNATIONAL INC. EMC & Wireless Communications Laboratory	
<b>Test Site Location</b>	No.58, Aly. 75, Ln. 564, Wenhua 3rd, Rd., Guishan Dist., Taoyuan City, Taiwan (R.O.C.) TEL: +886-3-327-0868 FAX: +886-3-327-0855	
<b>Test Site No.</b>	<b>Sporton Site No.</b>	
	03CH15-HY	

**Note:** The test site complies with ANSI C63.4 2014 requirement.

FCC designation No.: TW1190 and TW0007

### 1.4 Applicable Standards

According to the specifications of the manufacturer, the EUT must comply with the requirements of the following standards:

- ♦ FCC Part 15 Subpart C §15.247
- ♦ FCC KDB Publication No. 558074 D01 DTS Meas. Guidance v05r02
- ♦ FCC KDB 414788 D01 Radiated Test Site v01r01.
- ♦ ANSI C63.10-2013

**Remark:**

1. All test items were verified and recorded according to the standards and without any deviation during the test.
2. This EUT has also been tested and complied with the requirements of FCC Part 15, Subpart B, recorded in a separate test report.
3. The TAF code is not including all the FCC KDB listed without accreditation.



## 2 Test Configuration of Equipment Under Test

- a. The EUT has been associated with peripherals and configuration operated in a manner tended to maximize its emission characteristics in a typical application. Frequency range investigated: conduction emission (150 kHz to 30 MHz), radiation emission (9 kHz to the 10th harmonic of the highest fundamental frequency or to 40 GHz, whichever is lower). For radiated measurement, pre-scanned in three orthogonal panels, X, Y, Z. The worst cases (Z plane) were recorded in this report.
  
- b. AC power line Conducted Emission was tested under maximum output power.

### 2.1 Carrier Frequency and Channel

Frequency Band	Channel	Freq. (MHz)	Channel	Freq. (MHz)
2400-2483.5 MHz	1	2412	7	2442
	2	2417	8	2447
	3	2422	9	2452
	4	2427	10	2457
	5	2432	11	2462
	6	2437		



## 2.2 Test Mode

Final test modes are considering the modulation and worse data rates as below table.

Modulation	Data Rate
802.11b	1 Mbps
802.11g	6 Mbps
802.11n HT20	MCS0
802.11ac VHT20 (Covered by HT20)	MCS0

Test Cases	
AC Conducted Emission	Mode 1 :WCDMA Band V Idle + Bluetooth Link + WLAN (2.4GHz) Link + Camera (Front) + Earphone + Battery + USB Cable 1 (Charging from Adapter 2)
<b>Remark:</b> For Radiated Test Cases, the tests were performed with Adapter 2, USB Cable 1.	

Ch. #	2400-2483.5 MHz		
	802.11b	802.11g	802.11n HT20
Low	01	01	01
	-	02	02
Middle	06	06	06
High	-	10	10
	11	11	11

**Remark:** For radiation spurious emission, the final modulation and the worst data rate was reference the max RF conducted power.

## 2.3 Connection Diagram of Test System

<AC Conducted Emission Mode>

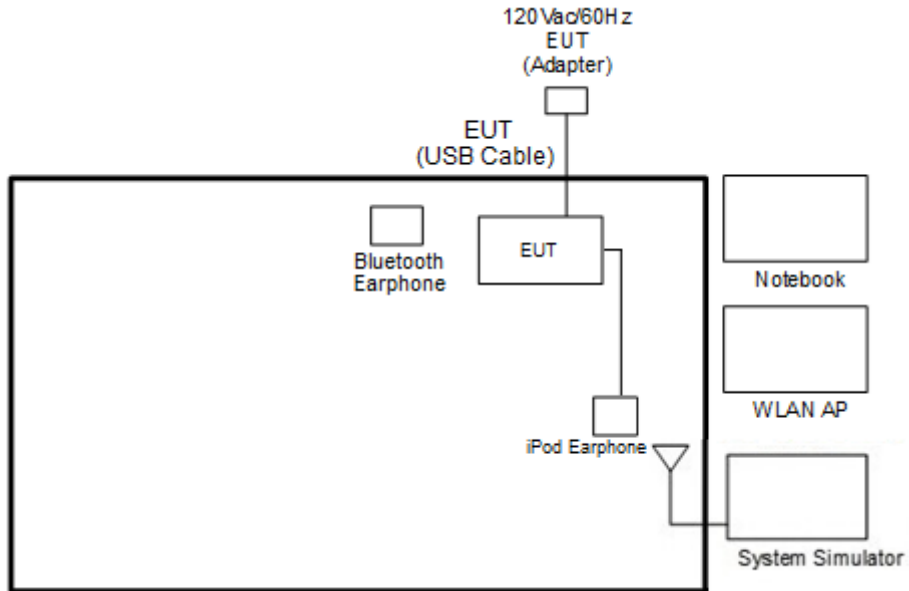

<WLAN Tx Mode >

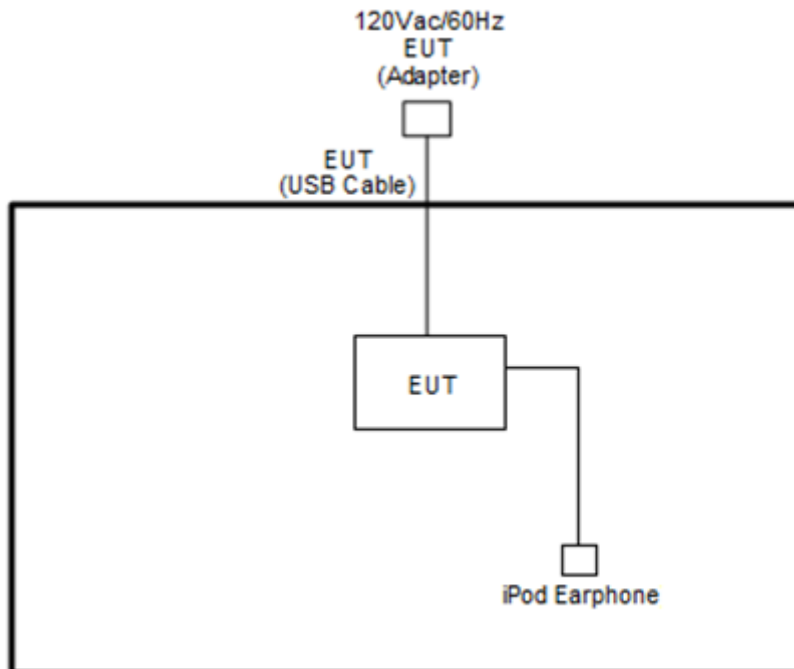

## 2.4 Support Unit used in test configuration and system

Item	Equipment	Trade Name	Model Name	FCC ID	Data Cable	Power Cord
1.	System Simulator	Anritsu	MT8820C	N/A	N/A	Unshielded, 1.8 m
2.	Notebook	Dell	Latitude 3400	FCC DoC	N/A	AC I/P : Unshielded, 1.2m DC O/P : Shielded, 1.8m
3.	Bluetooth Earphone	Sony Ericsson	MW600	PY7DDA-2029	N/A	N/A
4.	WLAN AP	ASUS	RT-AC66U	MSQ-RTAC66U	N/A	Unshielded, 1.8 m
5.	SD Card	SanDisk	MicroSD HC	FCC DoC	N/A	N/A
6.	iPod Earphone	Apple	N/A	Verification	Unshielded, 1.0 m	N/A

## 2.5 EUT Operation Test Setup

The RF test items, utility “QRCT3 V3.0.303.0” was installed in Notebook which was programmed in order to make the EUT get into the engineering modes to provide channel selection, power level, data rate and the application type and for continuous transmitting signals.

## 2.6 Measurement Results Explanation Example

**For all conducted test items:**

The offset level is set in the spectrum analyzer to compensate the RF cable loss and attenuator factor between EUT conducted output port and spectrum analyzer. With the offset compensation, the spectrum analyzer reading level is exactly the EUT RF output level.

Example:

The spectrum analyzer offset is derived from RF cable loss and attenuator factor.

*Offset = RF cable loss + attenuator factor.*

Following shows an offset computation example with cable loss 4.2 dB and 10dB attenuator.

*Offset(dB) = RF cable loss(dB) + attenuator factor(dB).*

= 4.2 + 10 = 14.2 (dB)

### 3 Test Result

#### 3.1 6dB and 99% Bandwidth Measurement

##### 3.1.1 Limit of 6dB and 99% Bandwidth

The minimum 6 dB bandwidth shall be at least 500 kHz.

##### 3.1.2 Measuring Instruments

See list of measuring equipment of this test report.

##### 3.1.3 Test Procedures

1. The testing follows the ANSI C63.10 Section 6.9.3 (OBW) and 11.8.1 (6dB BW).
2. The RF output of EUT was connected to the spectrum analyzer by RF cable and attenuator. The path loss was compensated to the results for each measurement.
3. Set to the maximum power setting and enable the EUT transmit continuously.
4. Make the measurement with the spectrum analyzer's resolution bandwidth (RBW) = 100 kHz. Set the Video bandwidth (VBW) = 300 kHz. In order to make an accurate measurement. The 6 dB bandwidth must be greater than 500 kHz.
5. For 99% Bandwidth Measurement, the spectrum analyzer's resolution bandwidth (RBW) is set 1-5% of the emission bandwidth and set the Video bandwidth (VBW)  $\geq 3 * RBW$ .
6. Measure and record the results in the test report.

##### 3.1.4 Test Setup

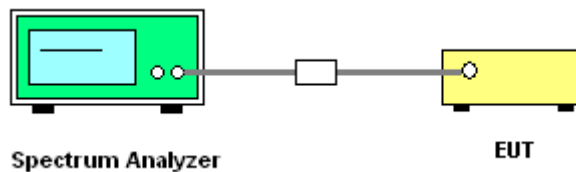



### 3.1.5 Test Result of 6dB and 99% Occupied Bandwidth

Please refer to Appendix A.

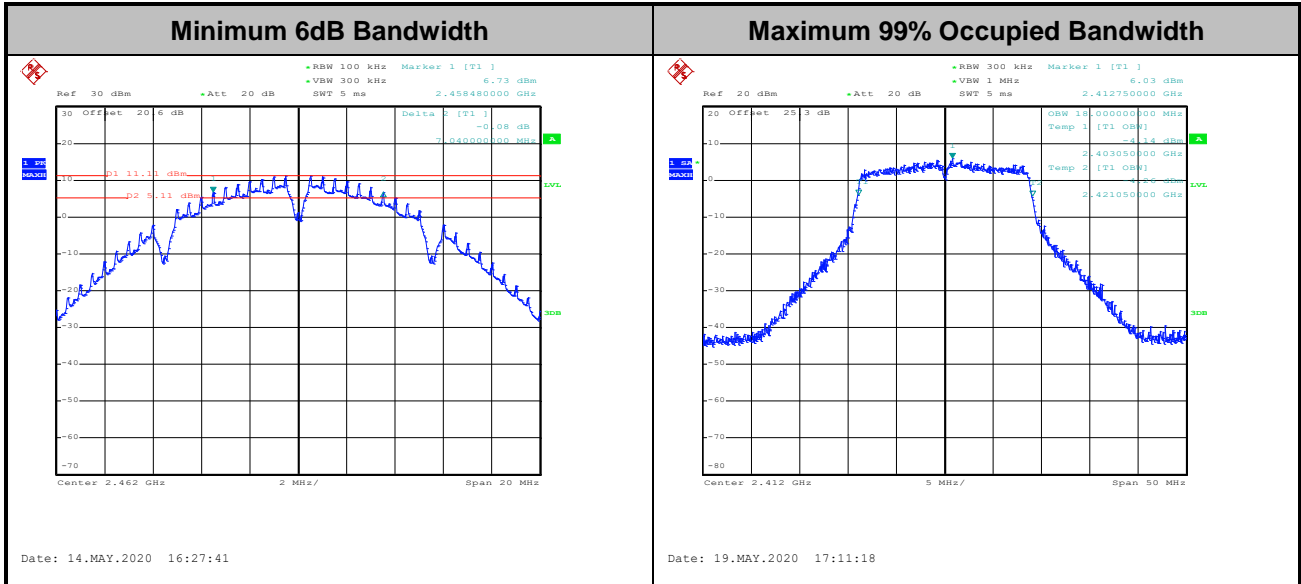

Note: The occupied channel bandwidth is maintained within the band of operation for all of the modulations.

## 3.2 Output Power Measurement

### 3.2.1 Limit of Output Power

For systems using digital modulation in the 2400-2483.5MHz, the limit for output power is 30dBm. If transmitting antenna with directional gain greater than 6dBi is used, the peak output power from the intentional radiator shall be reduced below the above stated value by the amount in dB that the directional gain of the antenna exceeds 6 dBi. In case of point-to-point operation, the limit has to be reduced by 1dB for every 3dB that the directional gain of the antenna exceeds 6dBi.

### 3.2.2 Measuring Instruments

See list of measuring equipment of this test report.

### 3.2.3 Test Procedures

1. For Average Power, the testing follows ANSI C63.10 Section 11.9.2.3.2 Method AVGPM-G
2. The RF output of EUT was connected to the power meter by RF cable and attenuator. The path loss was compensated to the results for each measurement.
3. Set to the maximum power setting and enable the EUT transmit continuously.
4. Measure the conducted output power and record the results in the test report.

### 3.2.4 Test Setup

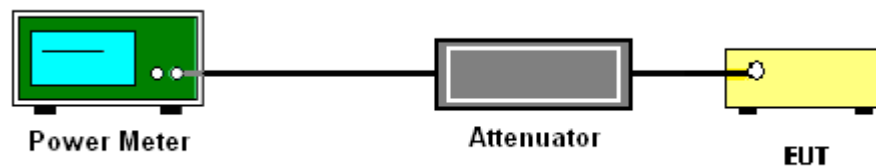

### 3.2.5 Test Result of Average Output Power

Please refer to Appendix A.



### **3.3 Power Spectral Density Measurement**

#### **3.3.1 Limit of Power Spectral Density**

The peak power spectral density shall not be greater than 8dBm in any 3kHz band at any time interval of continuous transmission.

#### **3.3.2 Measuring Instruments**

See list of measuring equipment of this test report.

#### **3.3.3 Test Procedures**

1. The testing follows the ANSI C63.10 Section 11.10.2 Method PKPSD.
2. The RF output of EUT was connected to the spectrum analyzer by RF cable and attenuator. The path loss was compensated to the results for each measurement.
3. Set to the maximum power setting and enable the EUT transmit continuously.
4. Make the measurement with the spectrum analyzer's resolution bandwidth (RBW) = 3 kHz. Video bandwidth VBW = 10 kHz In order to make an accurate measurement, set the span to 1.5 times DTS Channel Bandwidth. (6dB BW)
5. Detector = peak, Sweep time = auto couple, Trace mode = max hold, Allow trace to fully stabilize. Use the peak marker function to determine the maximum power level.
6. Measure and record the results in the test report.

### 3.3.4 Test Setup

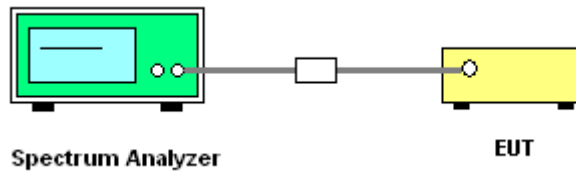

### 3.3.5 Test Result of Power Spectral Density

Please refer to Appendix A.

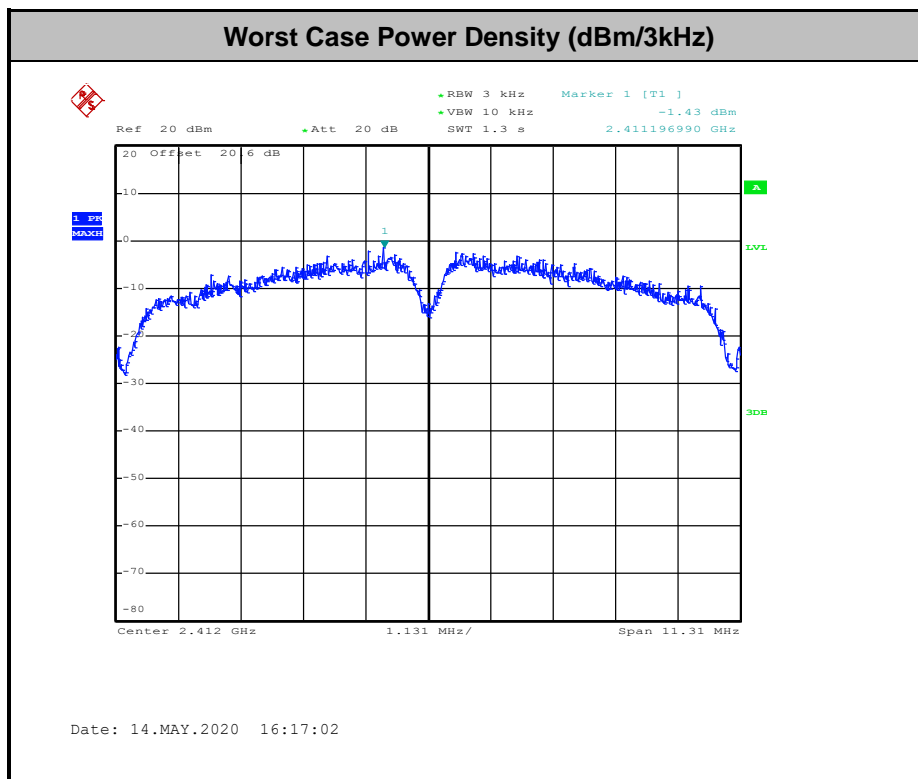

## 3.4 Conducted Band Edges and Spurious Emission Measurement

### 3.4.1 Limit of Conducted Band Edges and Spurious Emission Measurement

In any 100 kHz bandwidth outside of the authorized frequency band, the emissions which fall in the non-restricted bands shall be attenuated at least 20 dB / 30dB relative to the maximum PSD level in 100 kHz by RF conducted measurement.

### 3.4.2 Measuring Instruments

See list of measuring equipment of this test report.

### 3.4.3 Test Procedures

1. The testing follows the ANSI C63.10 Section 11.11.3 Emission level measurement.
2. The RF output of EUT was connected to the spectrum analyzer by RF cable and attenuator. The path loss was compensated to the results for each measurement.
3. Set to the maximum power setting and enable the EUT transmit continuously.
4. Set RBW = 100 kHz, VBW=300 kHz, Peak Detector. Unwanted Emissions measured in any 100 kHz bandwidth outside of the authorized frequency band shall be attenuated by at least 20 dB relative to the maximum in-band peak PSD level in 100 kHz when maximum peak conducted output power procedure is used. If the transmitter complies with the conducted power limits based on the use of RMS averaging over a time interval, the attenuation required under this paragraph shall be 30 dB instead of 20 dB per 15.247(d).
5. Measure and record the results in the test report.
6. The RF fundamental frequency should be excluded against the limit line in the operating frequency band.

### 3.4.4 Test Setup

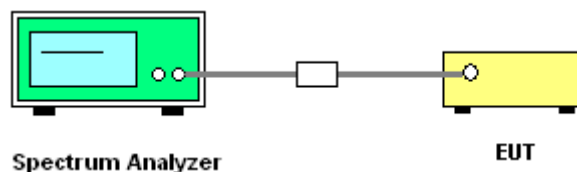



3.4.5 Test Result of Conducted Band Edges and Spurious Emission

Test Engineer :	Eason Huang and Sylvia Li	Temperature :	21~24°C
		Relative Humidity :	51~54%

Number of TX = 1, Ant. 1 (Measured)

Test Mode :	802.11b	Test Channel :	01
-------------	---------	----------------	----

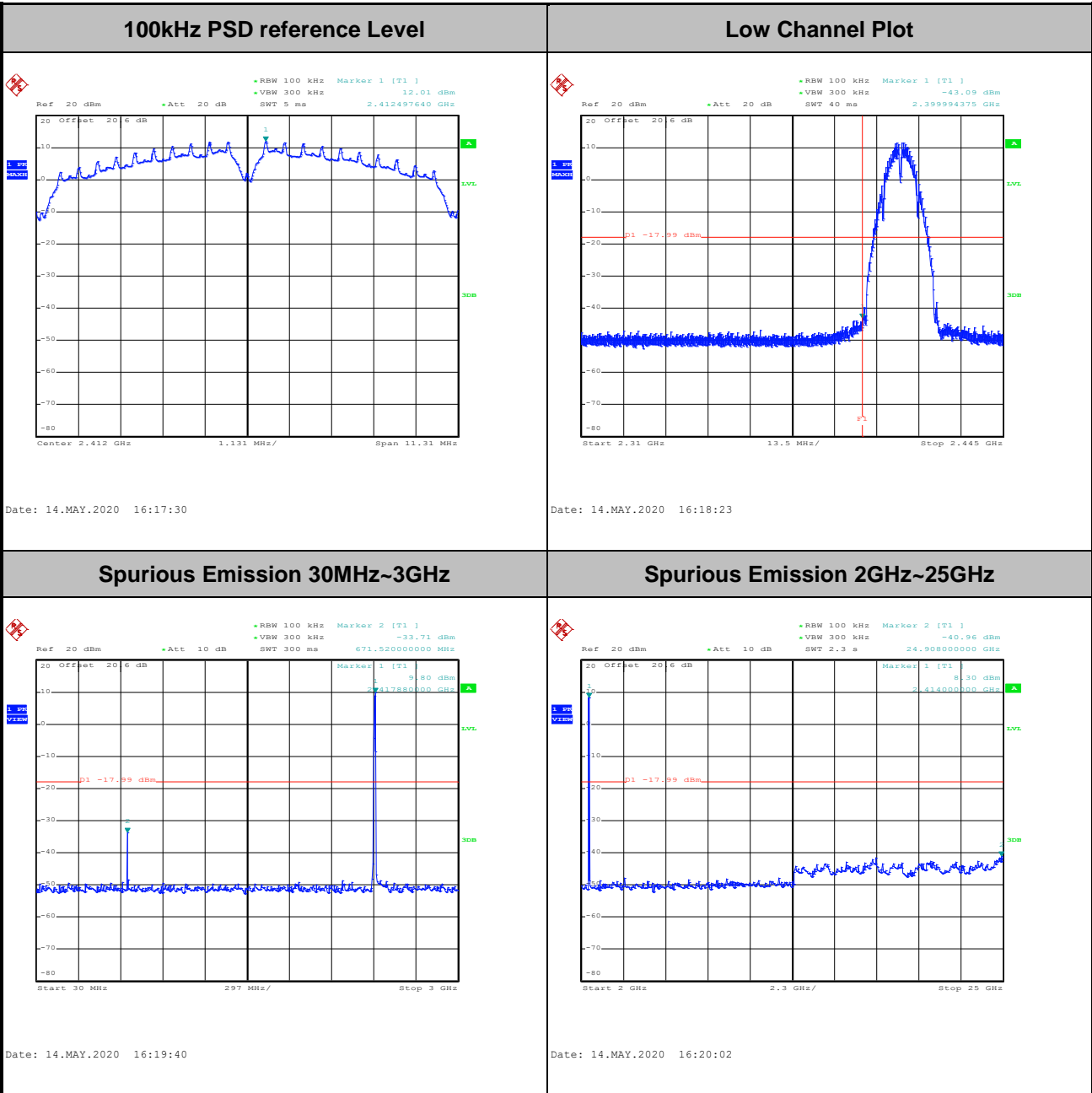



Test Mode :	802.11b	Test Channel :	06
-------------	---------	----------------	----

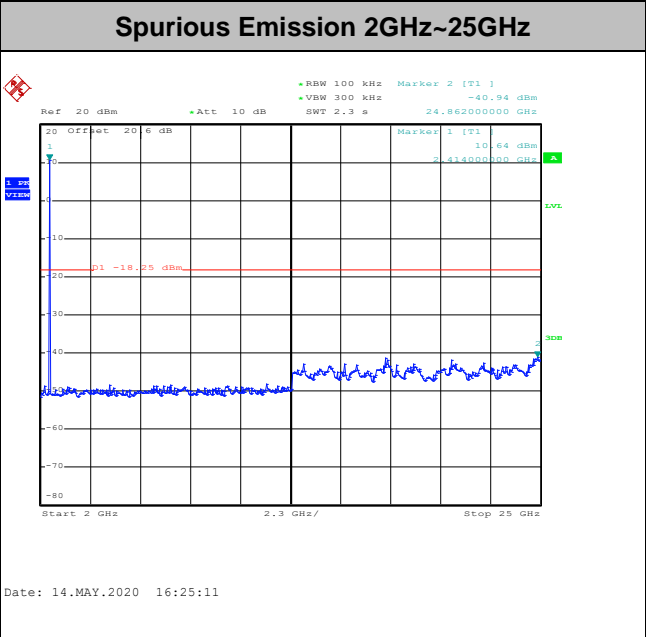
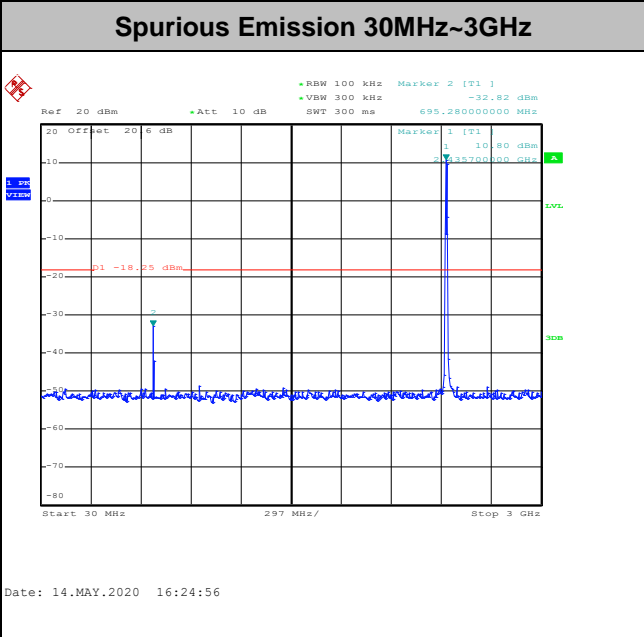
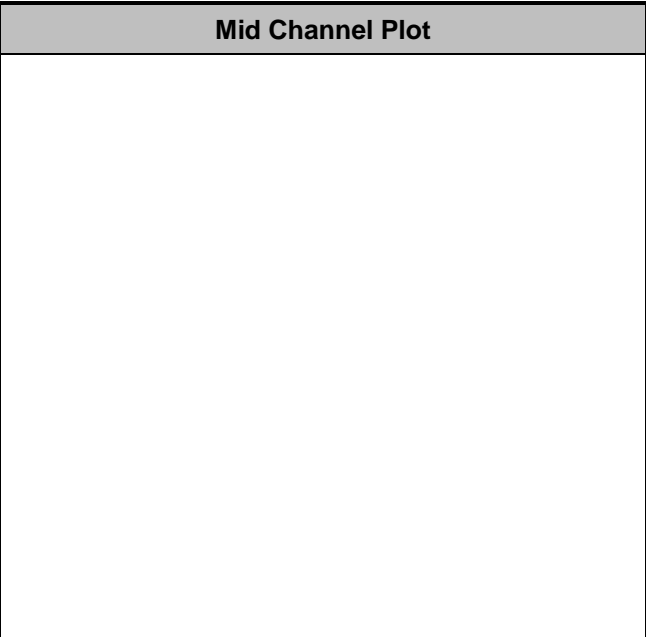
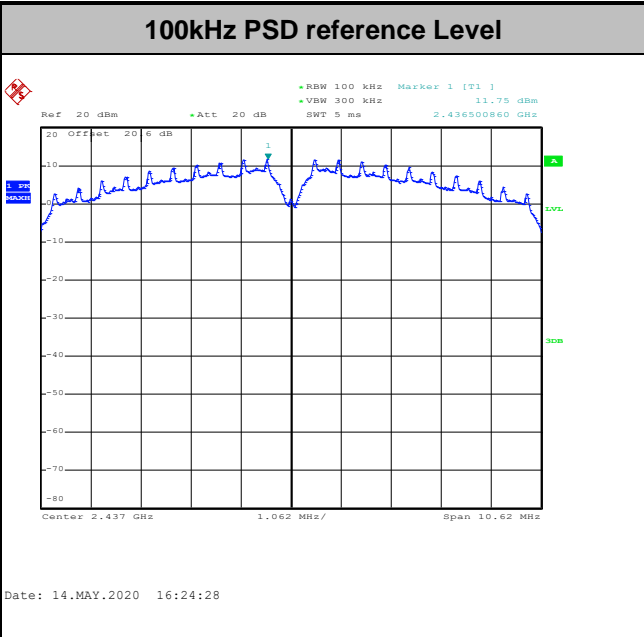



Test Mode :	802.11b	Test Channel :	11
-------------	---------	----------------	----

<b>100kHz PSD reference Level</b>	<b>High Channel Plot</b>
-----------------------------------	--------------------------

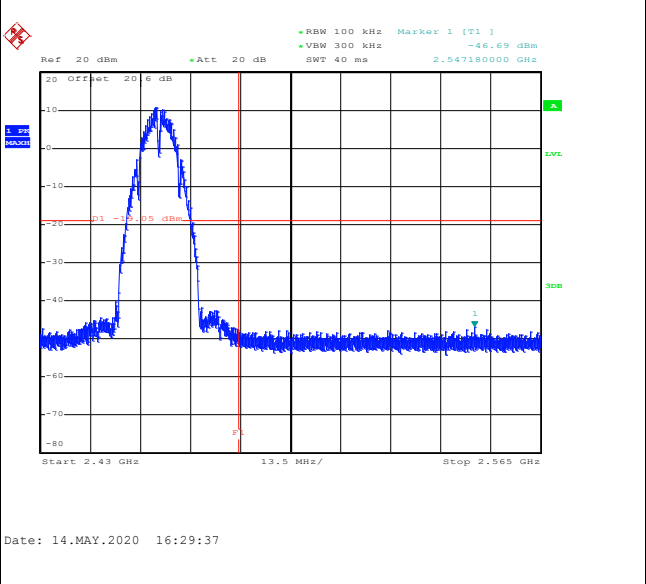
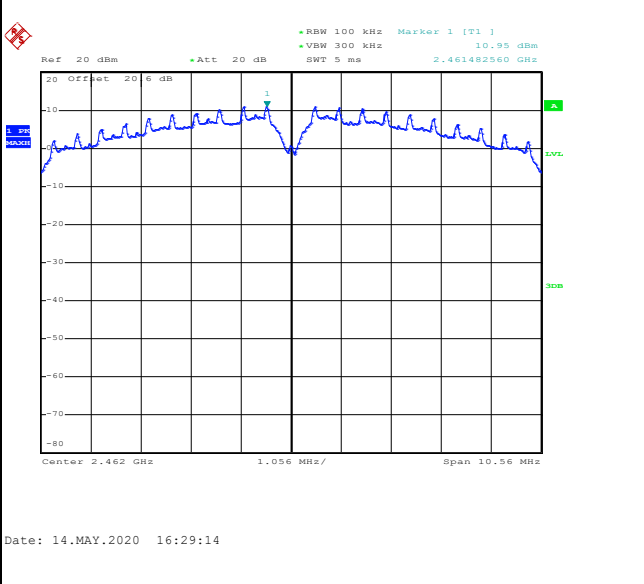

<b>Spurious Emission 30MHz~3GHz</b>	<b>Spurious Emission 2GHz~25GHz</b>
-------------------------------------	-------------------------------------

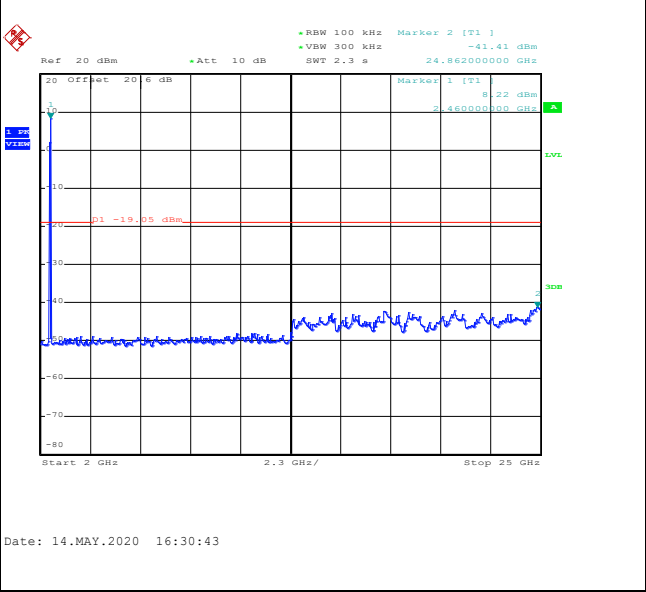
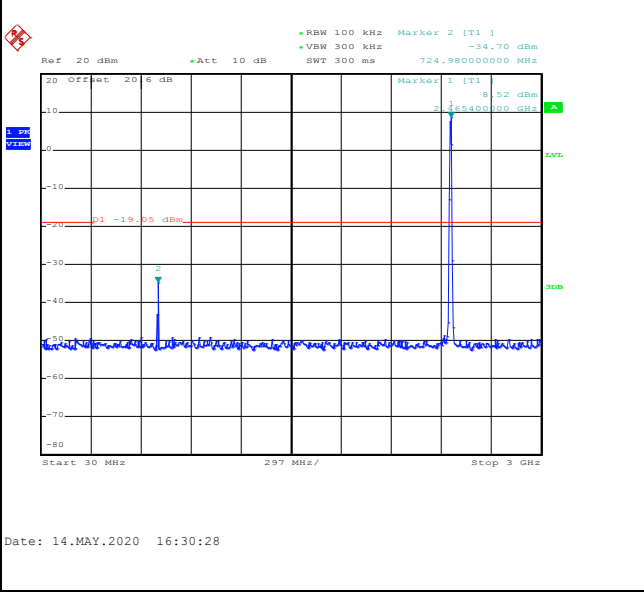



Test Mode :	802.11g	Test Channel :	01
-------------	---------	----------------	----

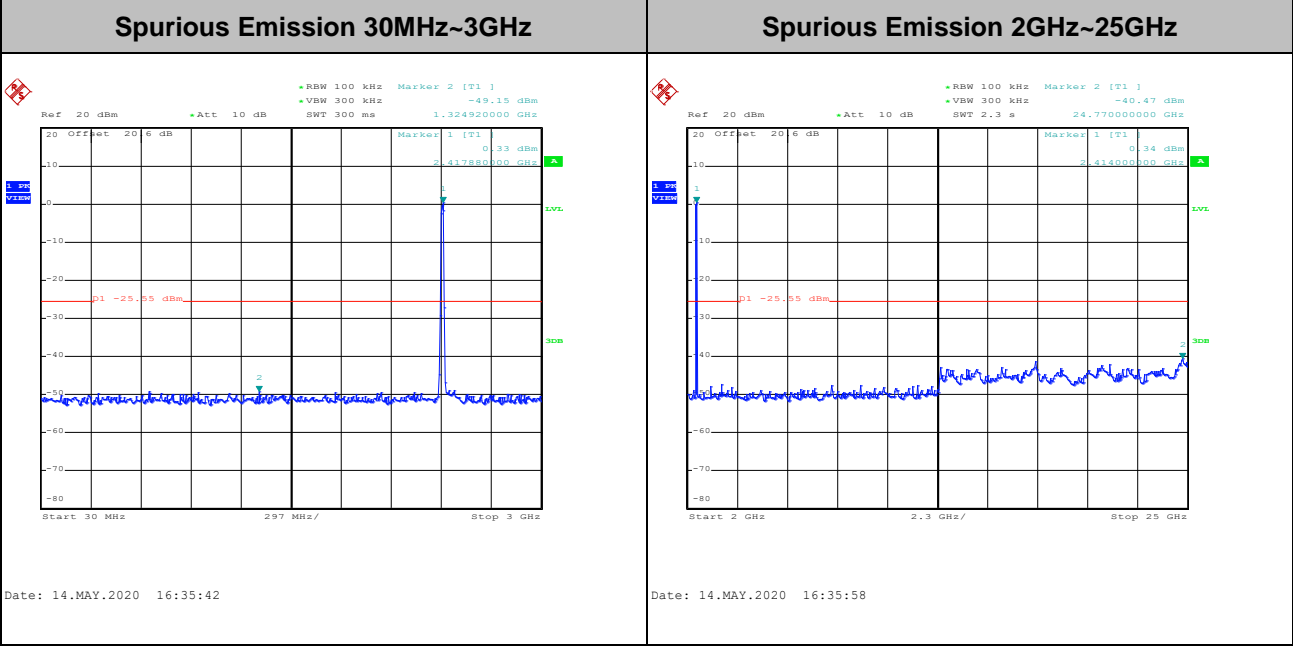
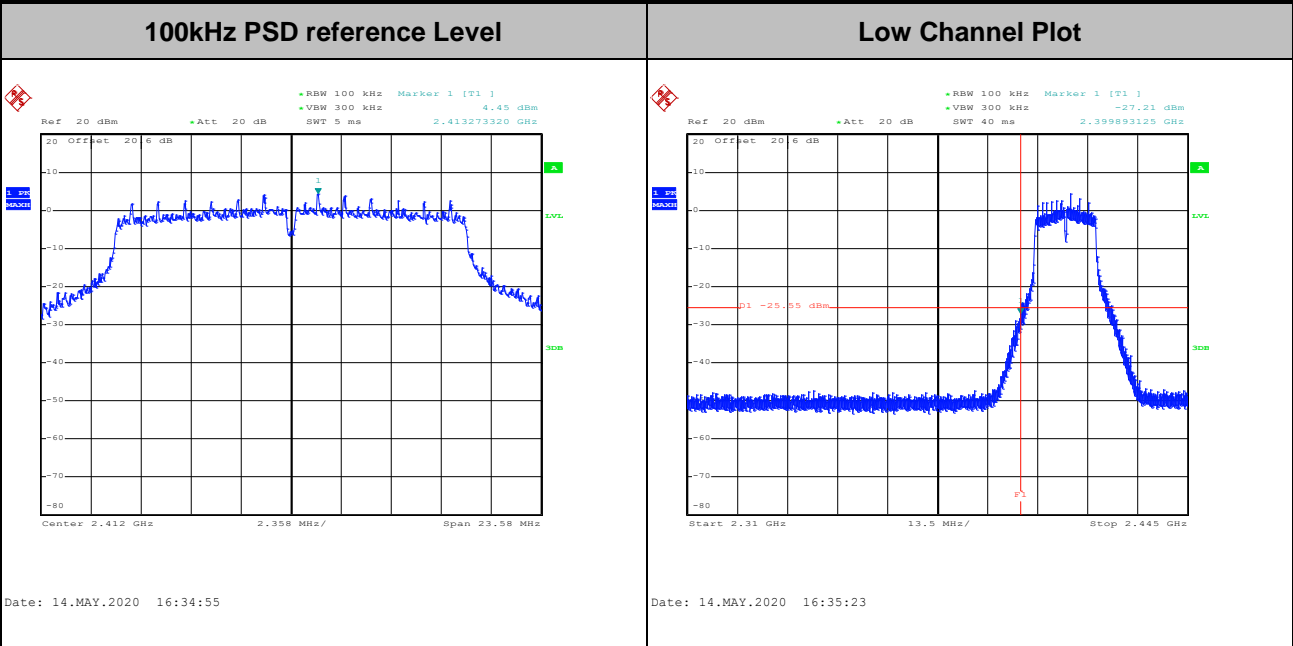



Test Mode :	802.11g	Test Channel :	02
-------------	---------	----------------	----

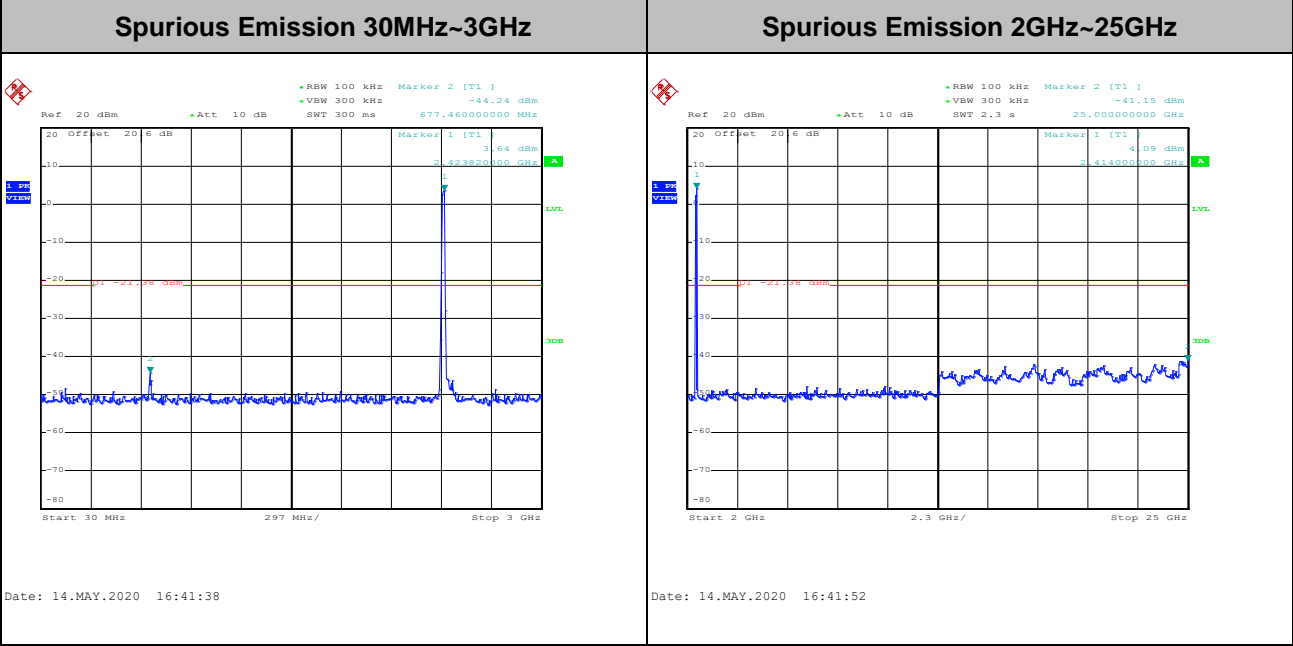
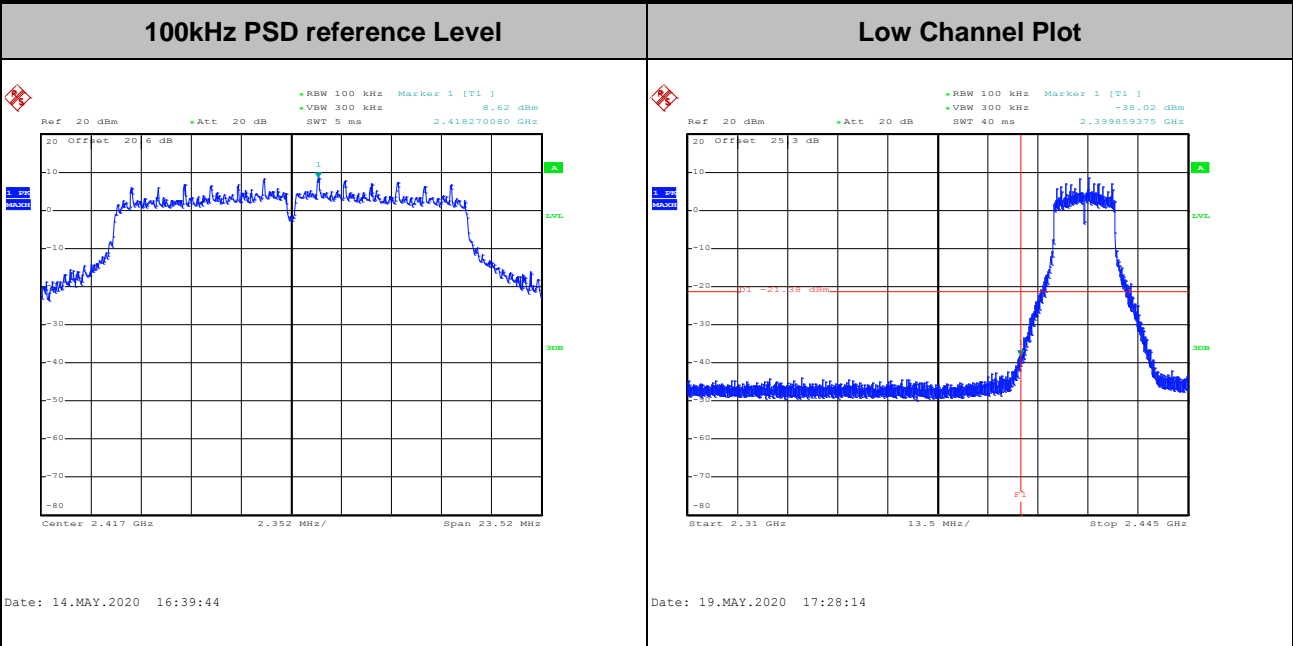



Test Mode :	802.11g	Test Channel :	06
-------------	---------	----------------	----

<b>100kHz PSD reference Level</b>	<b>Mid Channel Plot</b>
-----------------------------------	-------------------------

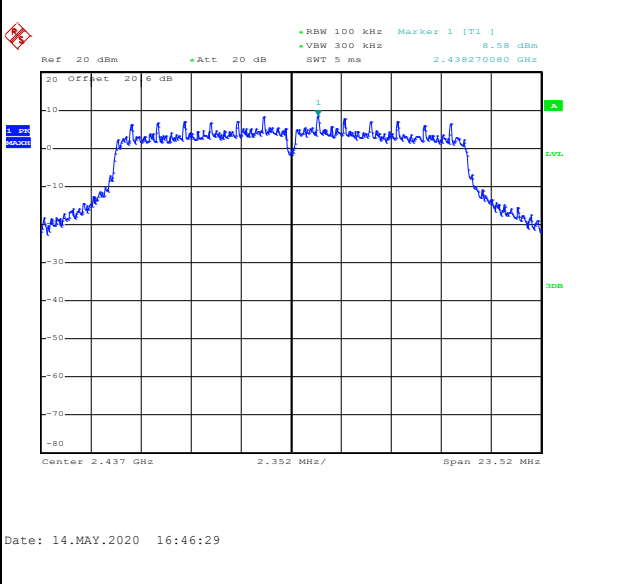

<b>Spurious Emission 30MHz~3GHz</b>	<b>Spurious Emission 2GHz~25GHz</b>
-------------------------------------	-------------------------------------

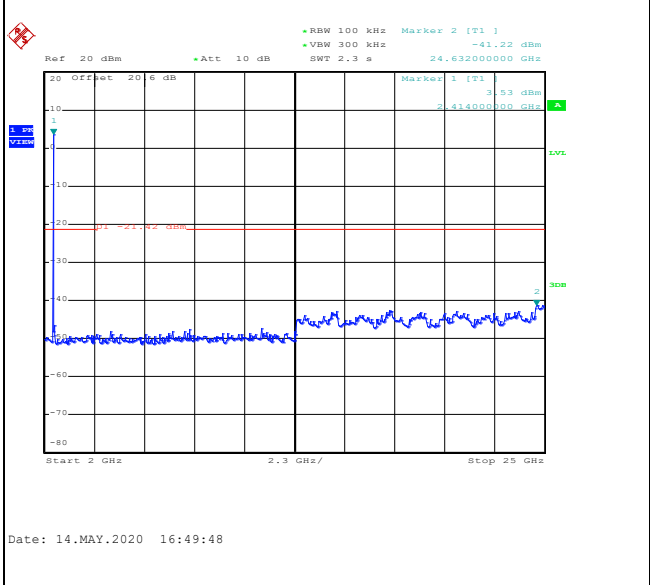
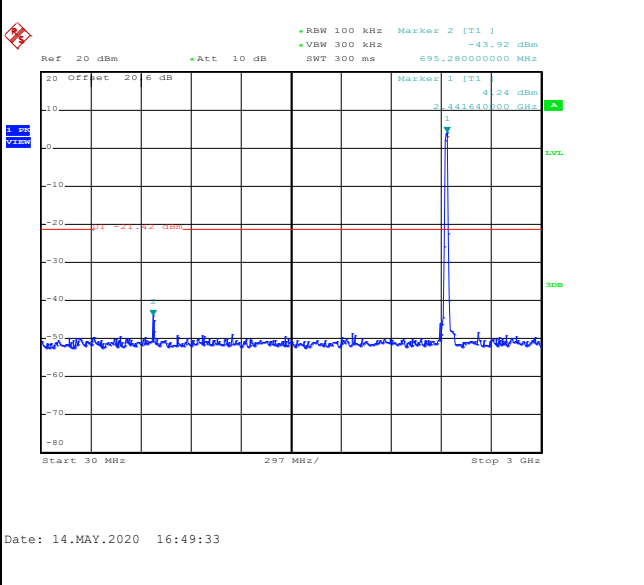



Test Mode :	802.11g	Test Channel :	10
-------------	---------	----------------	----

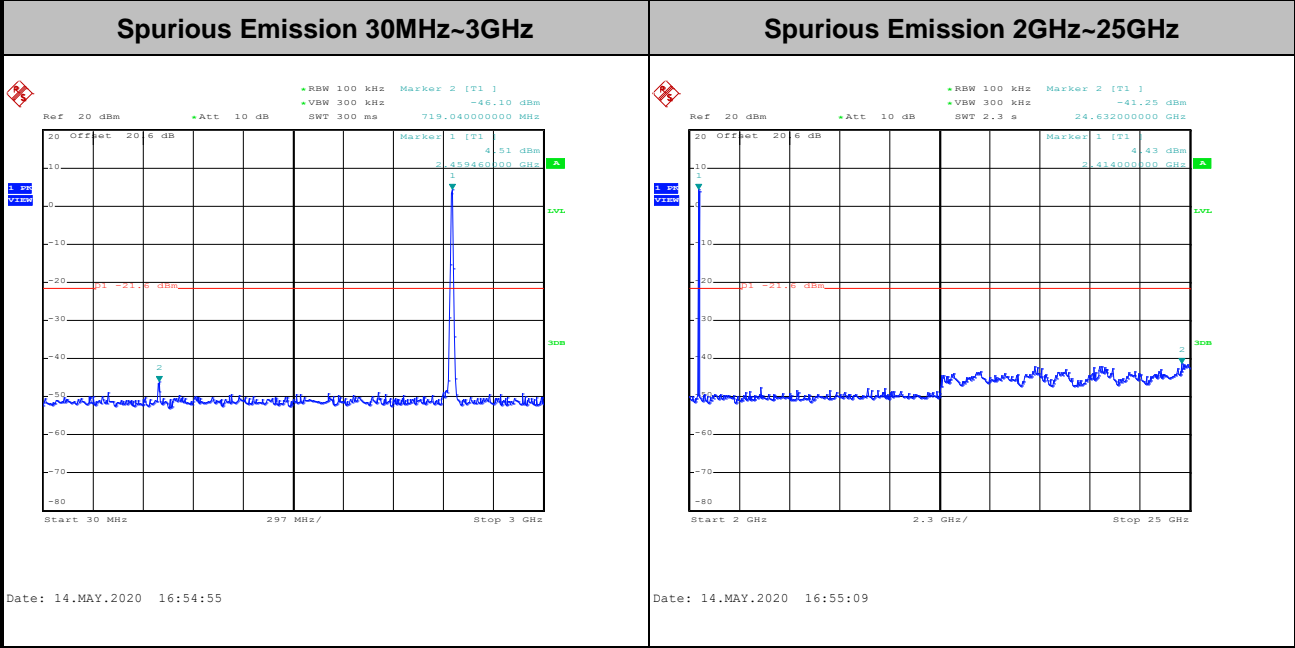
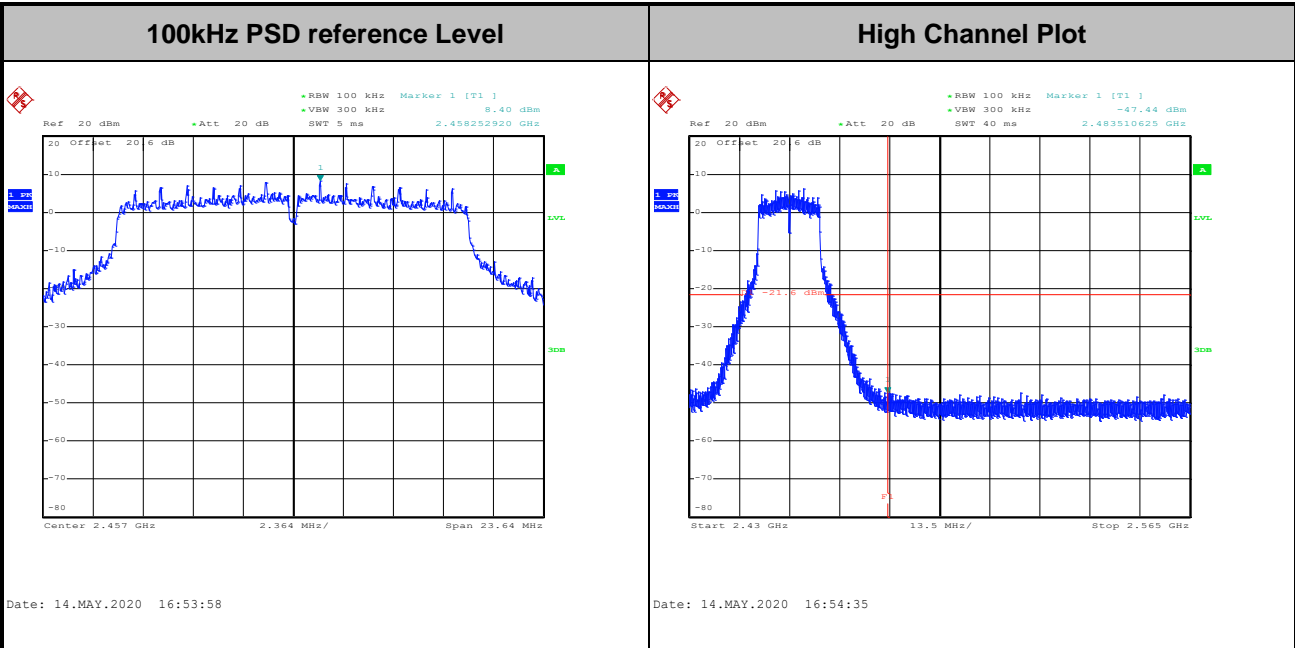



Test Mode :	802.11g	Test Channel :	11
-------------	---------	----------------	----

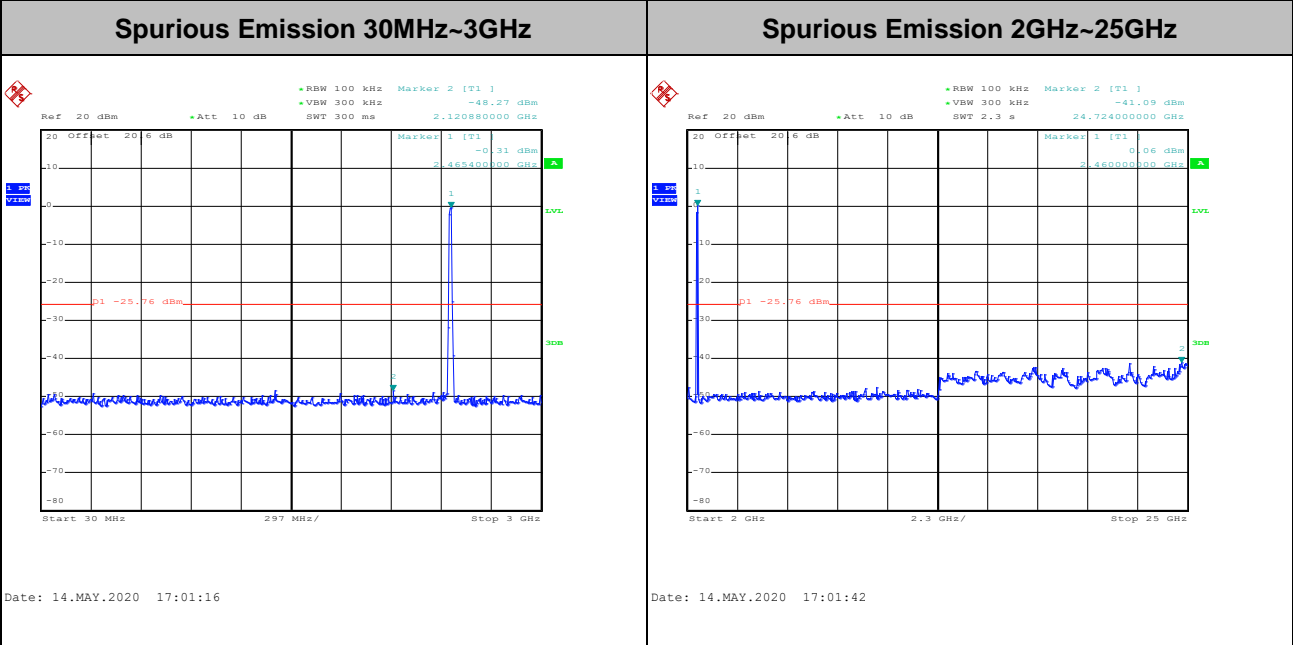
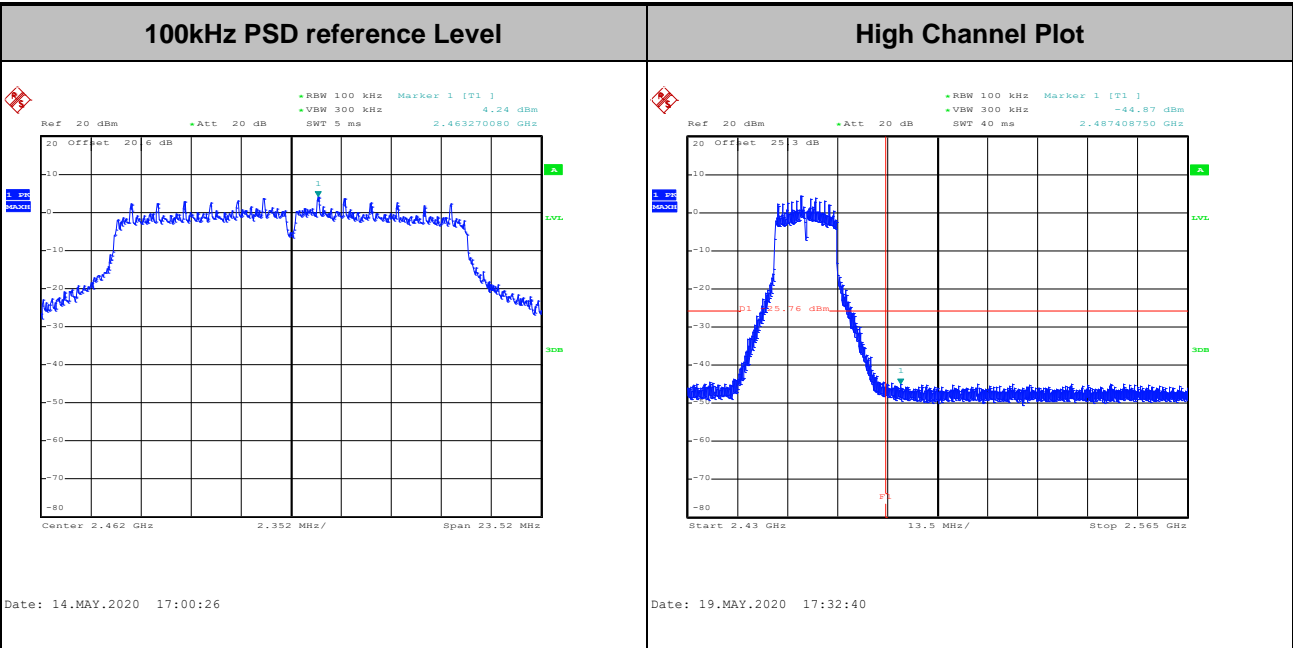



Test Mode :	802.11n HT20	Test Channel :	01
-------------	--------------	----------------	----

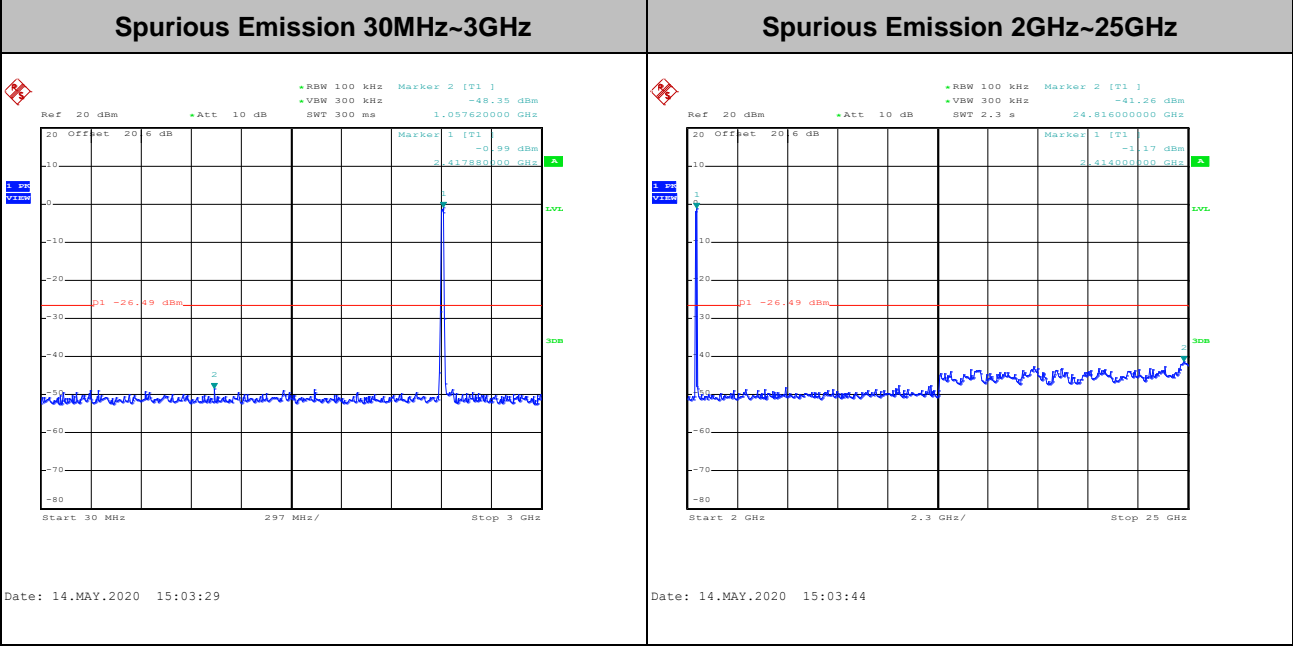
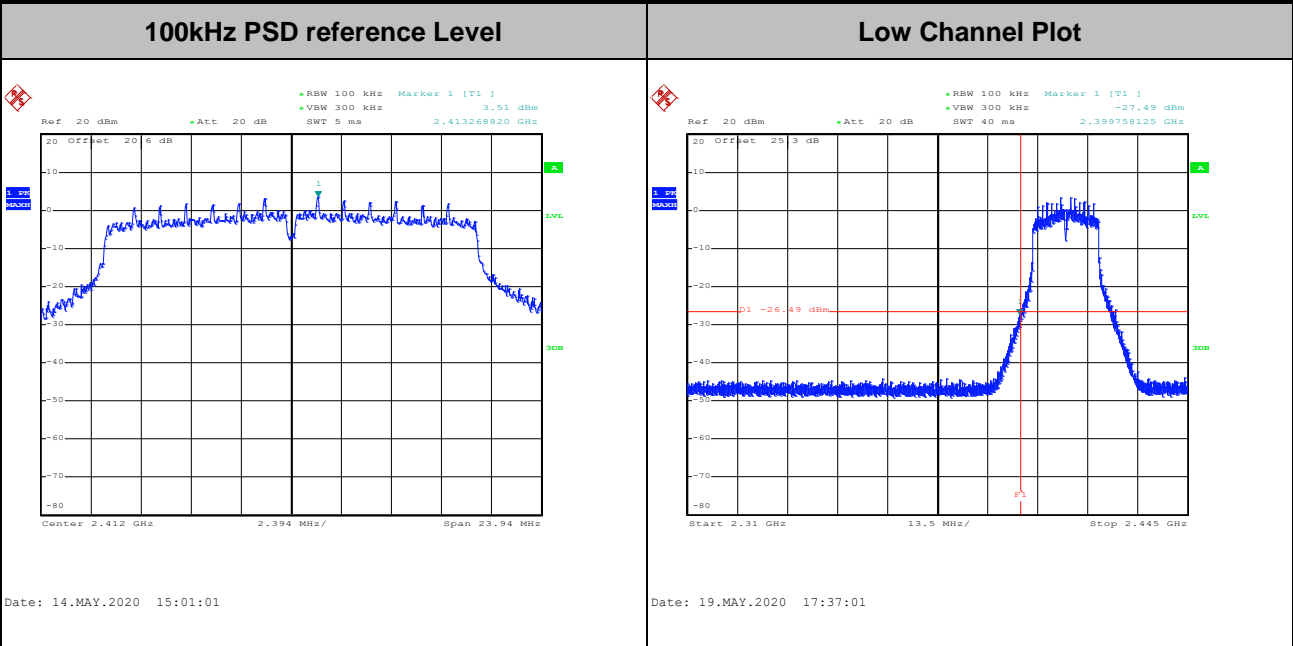



Test Mode :	802.11n HT20	Test Channel :	02
-------------	--------------	----------------	----

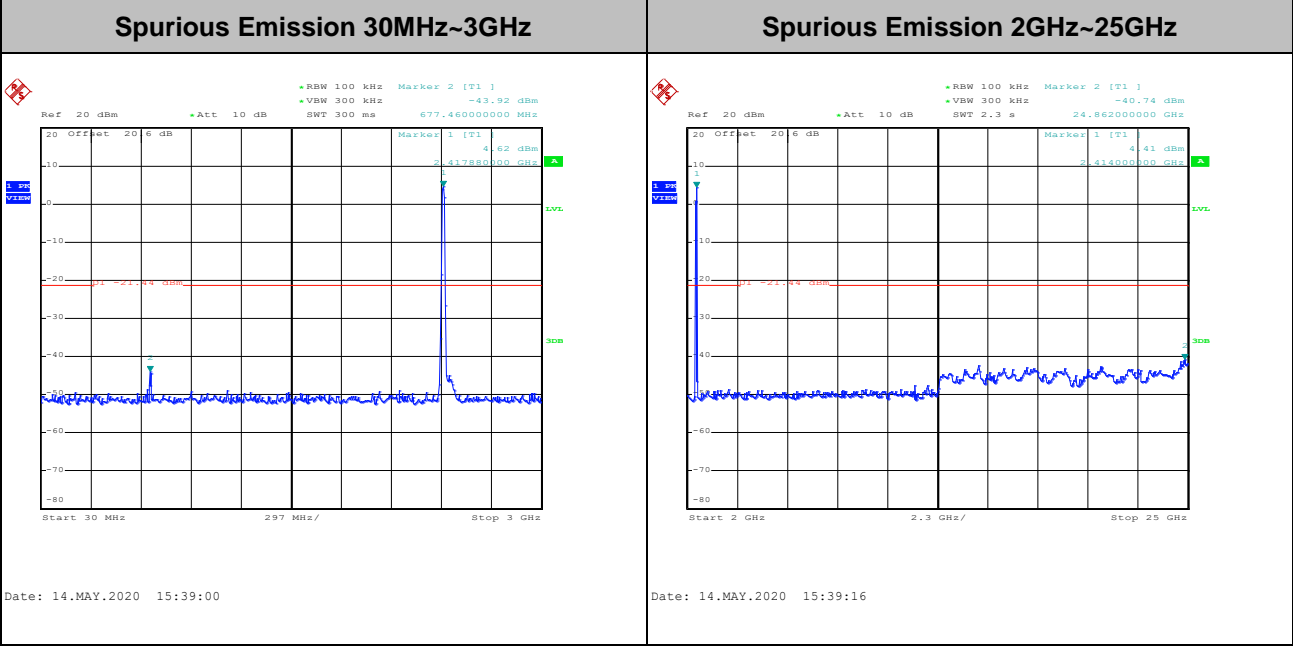
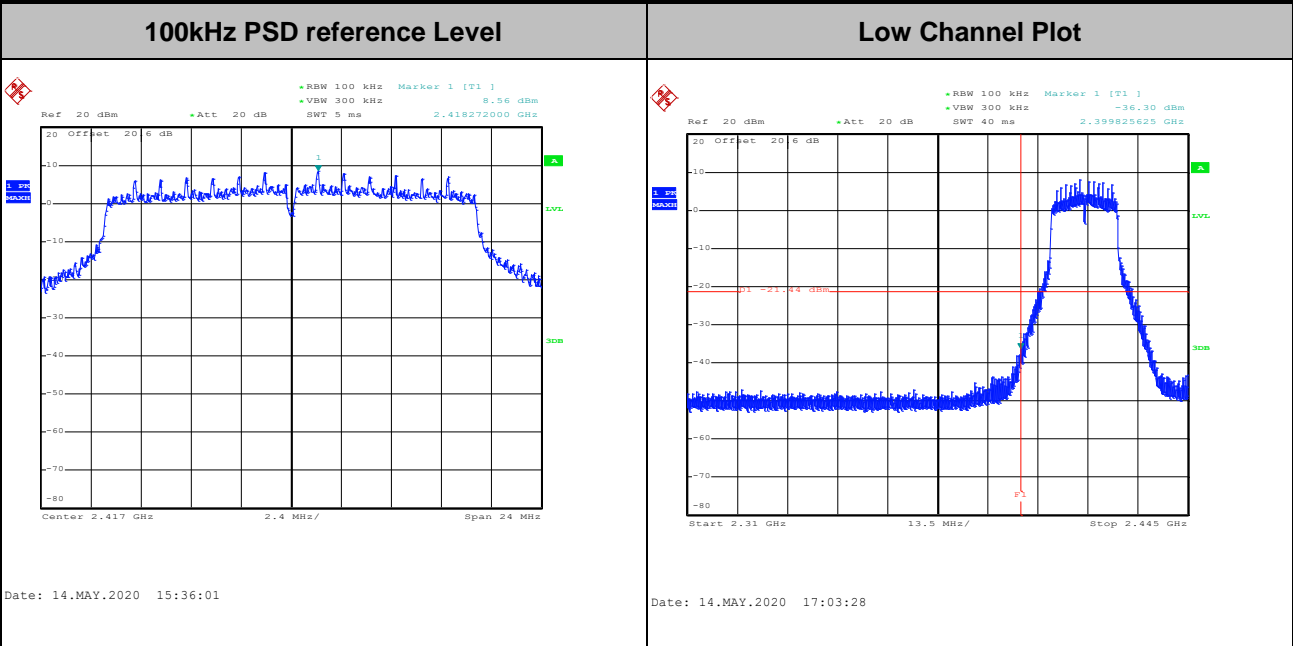



Test Mode :	802.11n HT20	Test Channel :	06
-------------	--------------	----------------	----

<b>100kHz PSD reference Level</b>	<b>Mid Channel Plot</b>
-----------------------------------	-------------------------

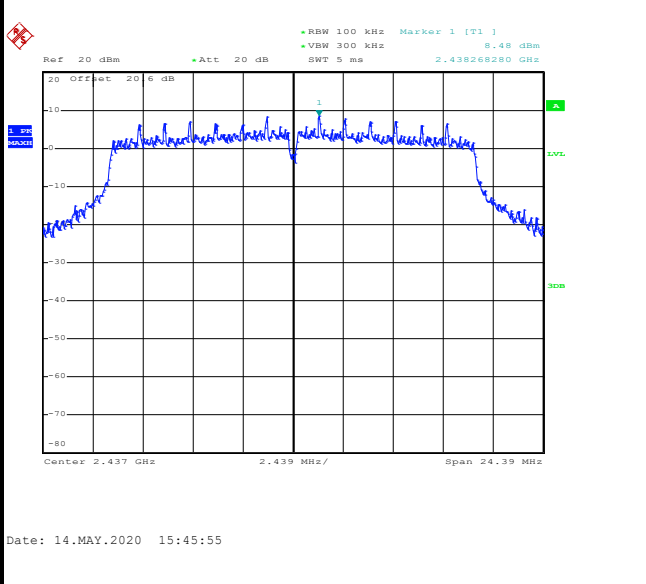

<b>Spurious Emission 30MHz~3GHz</b>	<b>Spurious Emission 2GHz~25GHz</b>
-------------------------------------	-------------------------------------

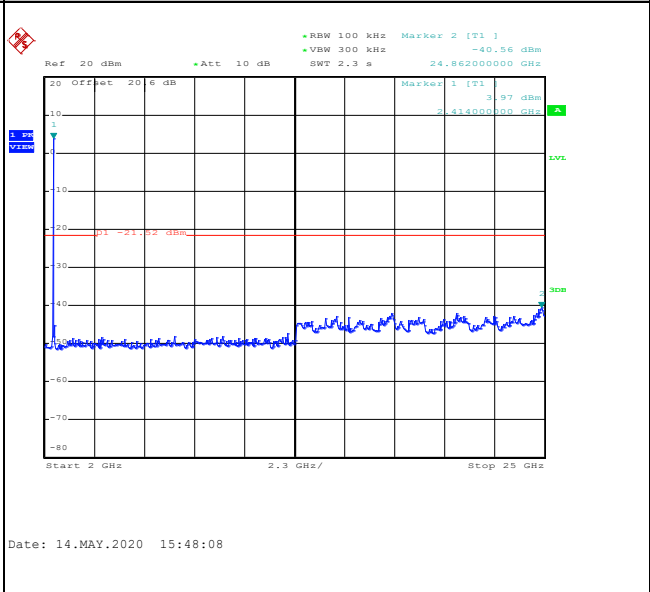
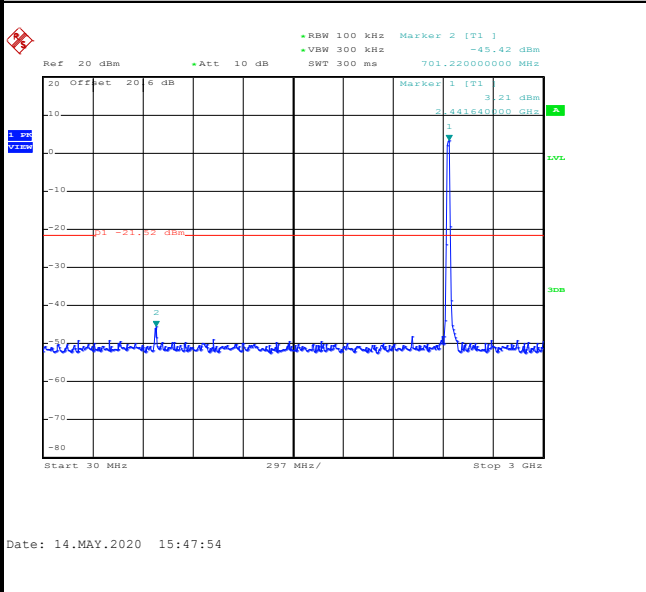



Test Mode :	802.11n HT20	Test Channel :	10
-------------	--------------	----------------	----

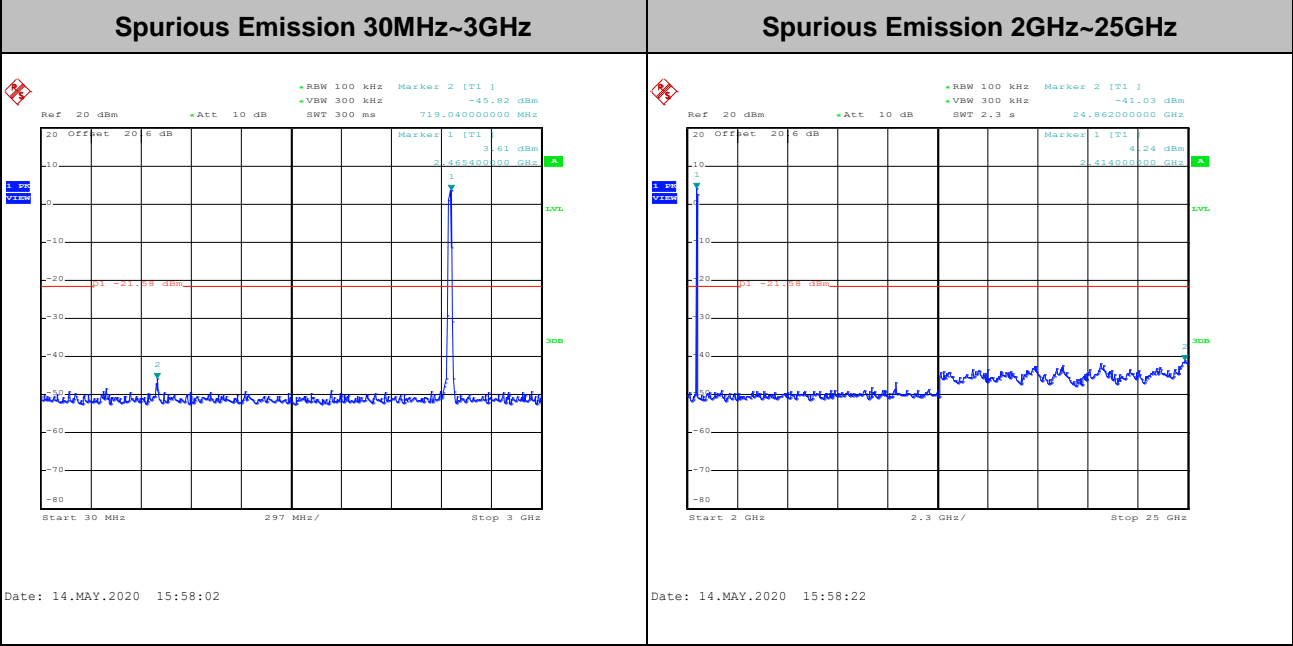
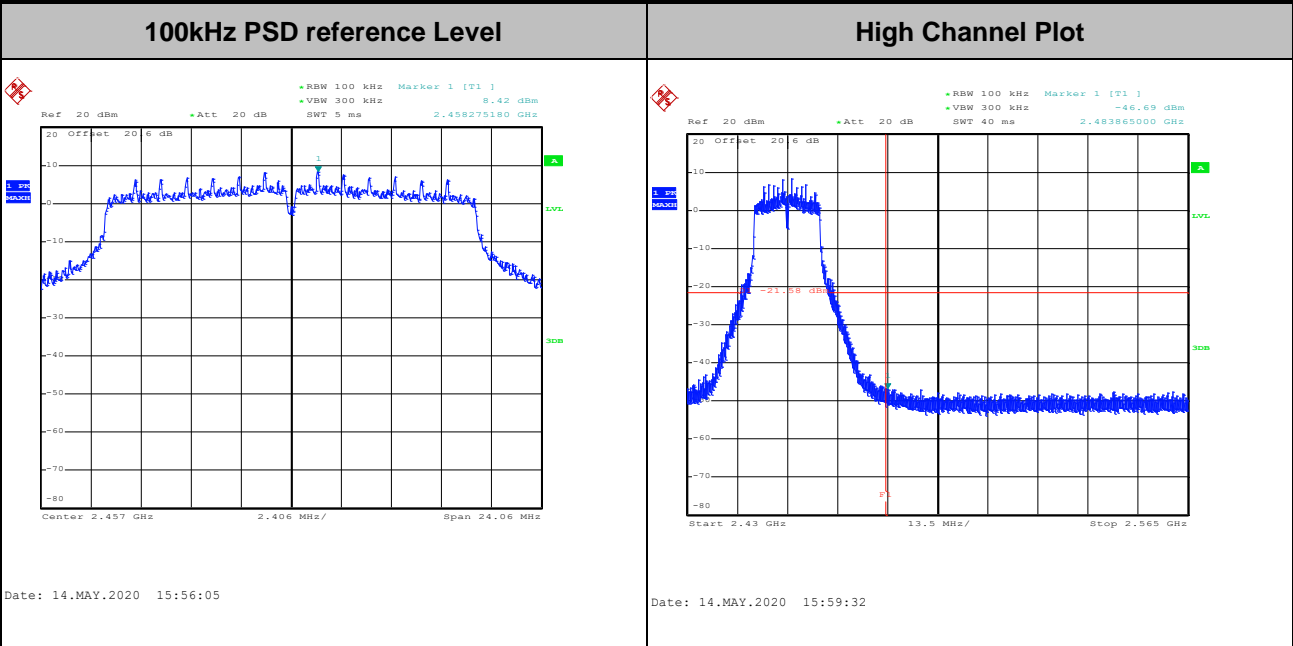



Test Mode :	802.11n HT20	Test Channel :	11
-------------	--------------	----------------	----

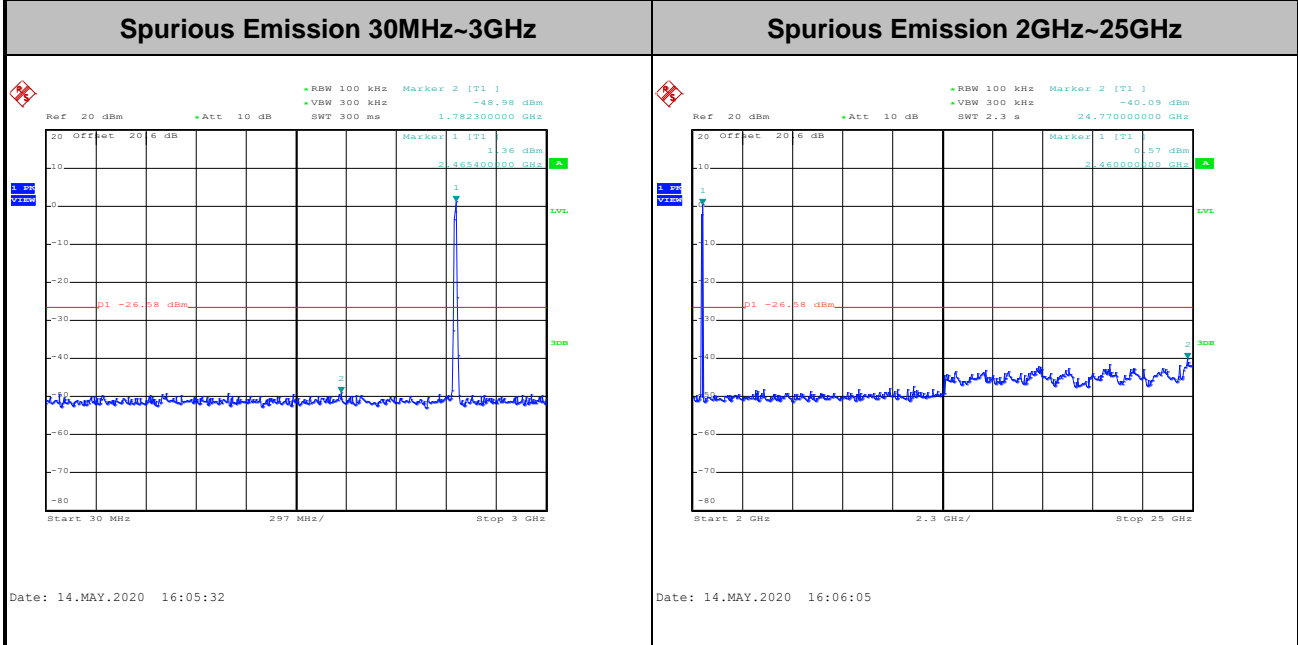
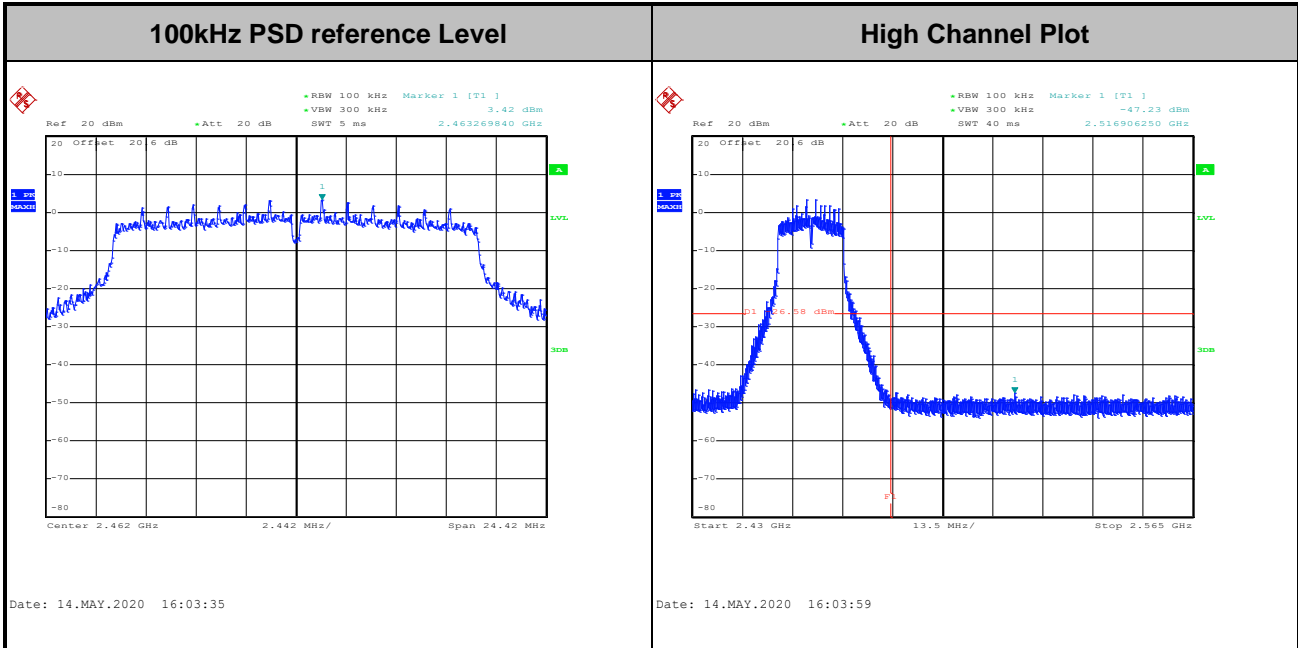



### 3.5 Radiated Band Edges and Spurious Emission Measurement

#### 3.5.1 Limit of Radiated band edge and Spurious Emission Measurement

In any 100 kHz bandwidth outside the intentional radiator frequency band, all harmonics/spurious must be at least 20 dB below the highest emission level within the authorized band. If the output power of this device was measured by spectrum analyzer, the attenuation under this paragraph shall be 30 dB instead of 20 dB. In addition, radiated emissions which fall in the restricted bands must also comply with the limits as below.

Frequency (MHz)	Field Strength (microvolts/meter)	Measurement Distance (meters)
0.009 – 0.490	2400/F(kHz)	300
0.490 – 1.705	24000/F(kHz)	30
1.705 – 30.0	30	30
30 – 88	100	3
88 – 216	150	3
216 - 960	200	3
Above 960	500	3

#### 3.5.2 Measuring Instruments

See list of measuring equipment of this test report.



### 3.5.3 Test Procedures

1. The testing follows the ANSI C63.10 Section 11.12.1 Radiated emission measurements.
2. The EUT was arranged to its worst case and then tune the antenna tower (from 1 m to 4 m) and turntable (from 0 degree to 360 degrees) to find the maximum reading. A pre-amp and a high pass filter are used for the test in order to get better signal level.
3. The EUT was placed on a turntable with 0.8 meter for frequency below 1GHz and 1.5 meter for frequency above 1GHz respectively above ground.
4. The EUT was set 3 meters from the interference receiving antenna, which was mounted on the top of a variable height antenna tower.
5. Corrected Reading: Antenna Factor + Cable Loss + Read Level - Preamp Factor = Level
6. For testing below 1GHz, if the emission level of the EUT in peak mode was 3 dB lower than the limit specified, then peak values of EUT will be reported, otherwise, the emissions will be repeated one by one using the CISPR quasi-peak method and reported.
7. For testing above 1GHz, the emission level of the EUT in peak mode was 20dB lower than average limit (that means the emission level in average mode also complies with the limit in average mode), then peak values of EUT will be reported, otherwise, the emissions will be measured in average mode again and reported.
8. Use the following spectrum analyzer settings:
  - (1) Span shall wide enough to fully capture the emission being measured;
  - (2) Set RBW=100 kHz for  $f < 1$  GHz;  $VBW \geq RBW$ ; Sweep = auto; Detector function = peak; Trace = max hold;
  - (3) Set RBW = 1 MHz, VBW= 3MHz for  $f \geq 1$  GHz for peak measurement.  
For average measurement:
    - $VBW = 10$  Hz, when duty cycle is no less than 98 percent.
    - $VBW \geq 1/T$ , when duty cycle is less than 98 percent where T is the minimum transmission duration over which the transmitter is on and is transmitting at its maximum power control level for the tested mode of operation.

### 3.5.4 Test Setup

For radiated emissions below 30MHz

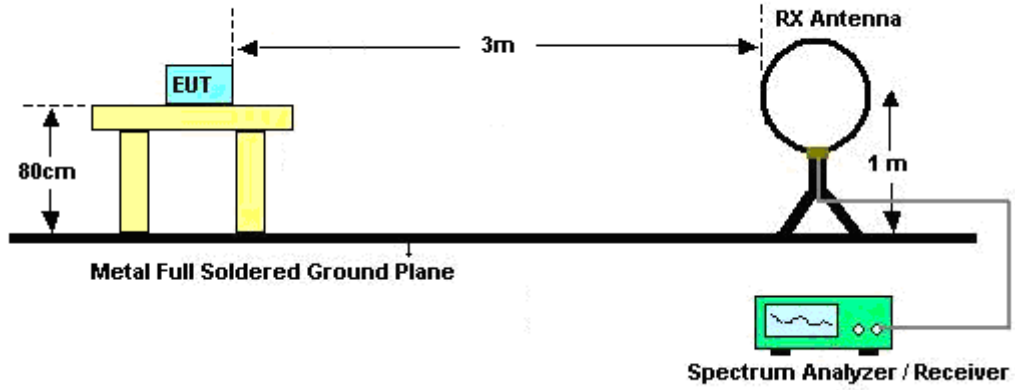

For radiated emissions from 30MHz to 1GHz

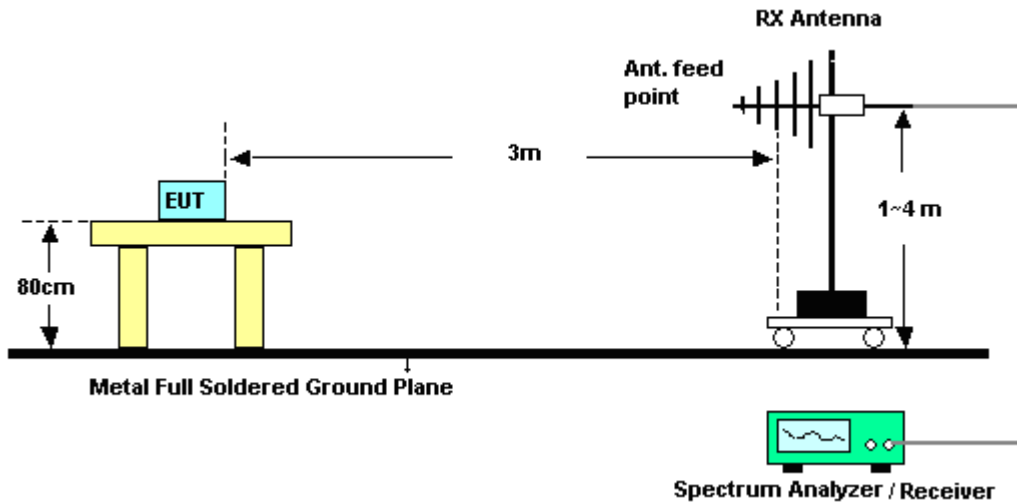

For radiated emissions above 1GHz

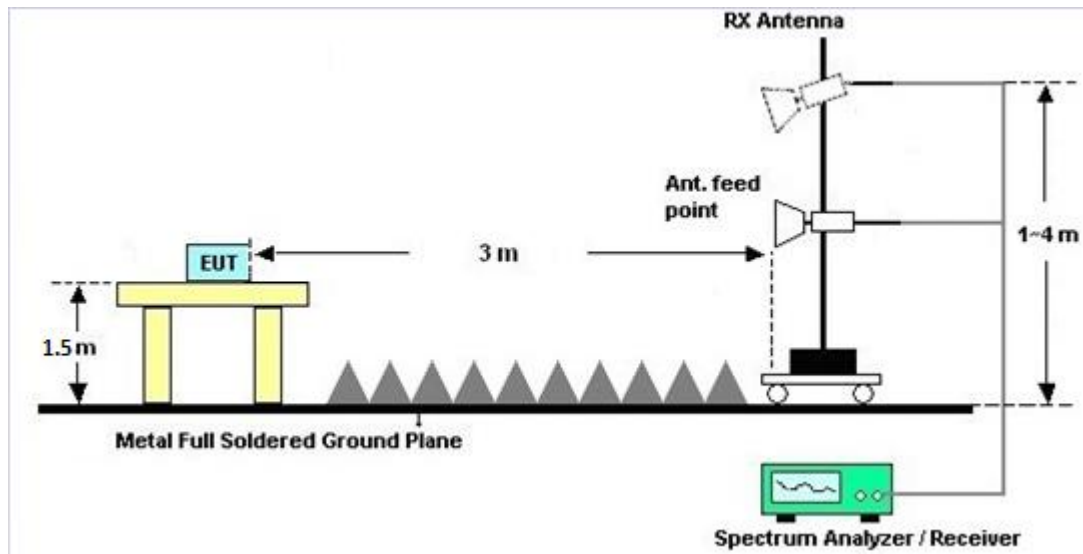

### 3.5.5 Test Results of Radiated Spurious Emissions (9kHz ~ 30MHz)

The low frequency, which started from 9 kHz to 30MHz, was pre-scanned and the result which was 20dB lower than the limit line was not reported.

There is a comparison data of both open-field test site and alternative test site - semi-Anechoic chamber according to 414788 D01 Radiated Test Site v01r01, and the result came out very similar.

### 3.5.6 Test Result of Radiated Spurious at Band Edges

Please refer to Appendix C and D.

### 3.5.7 Duty Cycle

Please refer to Appendix E.

### 3.5.8 Test Result of Radiated Spurious Emission (30MHz ~ 10<sup>th</sup> Harmonic)

Please refer to Appendix C and D.

### 3.6 AC Conducted Emission Measurement

#### 3.6.1 Limit of AC Conducted Emission

For equipment that is designed to be connected to the public utility (AC) power line, the radio frequency voltage that is conducted back onto the AC power line on any frequency or frequencies within the band 150 kHz to 30 MHz shall not exceed the limits in the following table.

Frequency of Emission (MHz)	Conducted Limit (dB $\mu$ V)	
	Quasi-Peak	Average
0.15-0.5	66 to 56*	56 to 46*
0.5-5	56	46
5-30	60	50

\*Decreases with the logarithm of the frequency.

#### 3.6.2 Measuring Instruments

See list of measuring equipment of this test report.

#### 3.6.3 Test Procedures

1. The EUT was placed 0.4 meter from the conducting wall of the shielding room, and it was kept at least 80 centimeters from any other grounded conducting surface.
2. Connect EUT to the power mains through a line impedance stabilization network (LISN).
3. All the support units are connecting to the other LISN.
4. The LISN provides 50 ohm coupling impedance for the measuring instrument.
5. The FCC states that a 50 ohm, 50 microhenry LISN should be used.
6. Both sides of AC line were checked for maximum conducted interference.
7. The frequency range from 150 kHz to 30 MHz was searched.
8. Set the test-receiver system to Peak Detect Function and specified bandwidth (IF bandwidth = 9kHz) with Maximum Hold Mode.

### 3.6.4 Test Setup

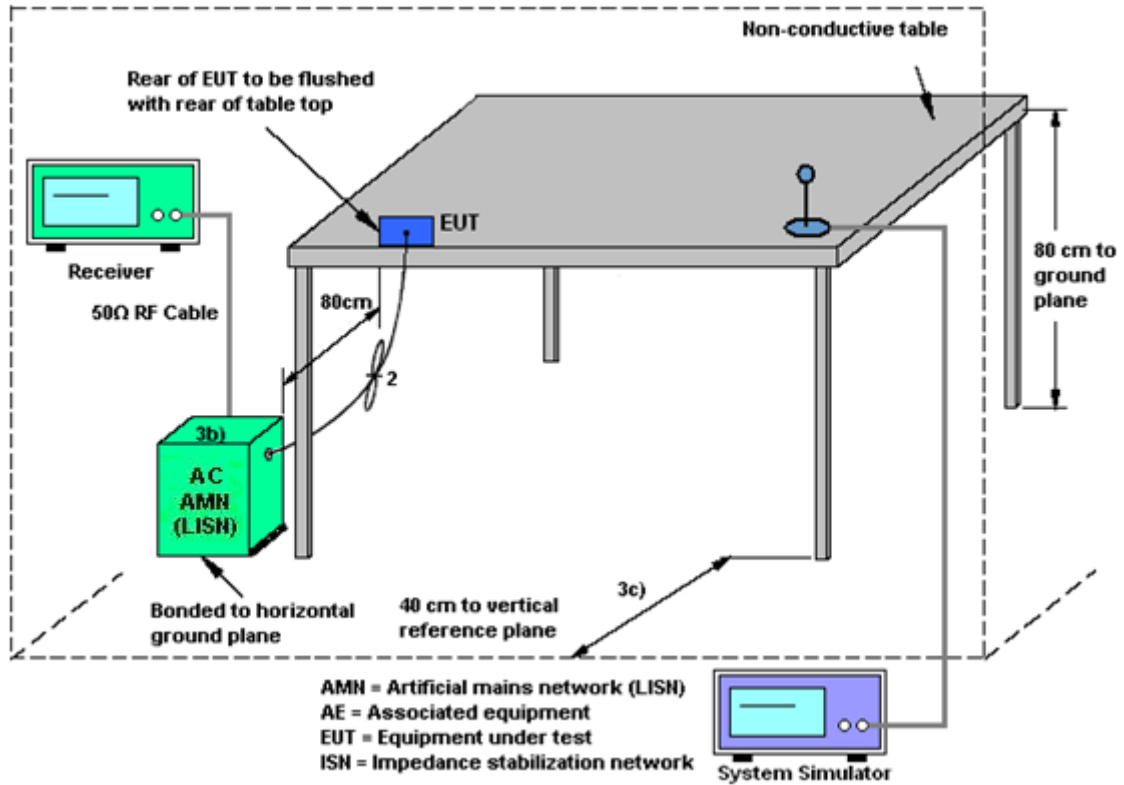

### 3.6.5 Test Result of AC Conducted Emission

Please refer to Appendix B.



## **3.7 Antenna Requirements**

### **3.7.1 Standard Applicable**

If directional gain of transmitting Antennas is greater than 6dBi, the power shall be reduced by the same level in dB comparing to gain minus 6dBi. The use of a permanently attached Antenna or of an Antenna that uses a unique coupling to the intentional radiator shall be considered sufficient to comply with the rule.

### **3.7.2 Antenna Anti-Replacement Construction**

An embedded-in antenna design is used.

### **3.7.3 Antenna Gain**

The antenna peak gain of EUT is less than 6 dBi. Therefore, it is not necessary to reduce maximum peak output power limit.



## 4 List of Measuring Equipment

Instrument	Manufacturer	Model No.	Serial No.	Characteristics	Calibration Date	Test Date	Due Date	Remark
Loop Antenna	Rohde & Schwarz	HFH2-Z2	100488	9 kHz~30 MHz	Jan. 09, 2020	May 01, 2020~ May 22, 2020	Jan. 08, 2021	Radiation (03CH15-HY)
Bilog Antenna	TESEQ	CBL6111D&0 0800N1D01N- 06	41912&05	30MHz to 1GHz	Feb. 09, 2020	May 01, 2020~ May 22, 2020	Feb. 08, 2021	Radiation (03CH15-HY)
Horn Antenna	SCHWARZBECK	BBHA 9120 D	9120D-211 4	1-18GHz	Jul. 31, 2019	May 01, 2020~ May 22, 2020	Jul. 30, 2020	Radiation (03CH15-HY)
SHF-EHF Horn Antenna	SCHWARZBECK	BBHA 9170	BBHA9170 584	18GHz- 40GHz	Dec. 10, 2019	May 01, 2020~ May 22, 2020	Dec. 09, 2020	Radiation (03CH15-HY)
Amplifier	SONOMA	310N	363440	9kHz~1GHz	Dec. 27, 2019	May 01, 2020~ May 22, 2020	Dec. 26, 2020	Radiation (03CH15-HY)
Preamplifier	Jet-Power	JPA0118-55-3 03	171000180 0055007	1GHz~18GHz	Mar. 31, 2020	May 01, 2020~ May 22, 2020	Mar. 30, 2021	Radiation (03CH15-HY)
Preamplifier	Keysight	83017A	MY532701 95	1GHz~26.5GHz	Aug. 23, 2019	May 01, 2020~ May 22, 2020	Aug. 22, 2020	Radiation (03CH15-HY)
Preamplifier	EMEC	EM18G40G	060715	18GHz ~ 40GHz	Dec. 13, 2019	May 01, 2020~ May 22, 2020	Dec. 12, 2020	Radiation (03CH15-HY)
EMI Test Receiver	Keysight	N9038A (MXE)	MY541300 85	20MHz~8.4GHz	Nov. 01, 2019	May 01, 2020~ May 22, 2020	Oct. 31, 2020	Radiation (03CH15-HY)
EMI Test Receiver	Rohde & Schwarz	ESU26	100390	20Hz~26.5GHz	Feb. 25, 2020	May 01, 2020~ May 22, 2020	Feb. 24, 2021	Radiation (03CH15-HY)
Antenna Mast	ChainTek	MBS-520-1	N/A	1m~4m	N/A	May 01, 2020~ May 22, 2020	N/A	Radiation (03CH15-HY)
Turn Table	ChainTek	T-200-S-1	N/A	0~360 Degree	N/A	May 01, 2020~ May 22, 2020	N/A	Radiation (03CH15-HY)
Software	Audix	E3 6.2009-8-24(k 5)	RK-00045 1	N/A	N/A	May 01, 2020~ May 22, 2020	N/A	Radiation (03CH15-HY)
RF Cable	HUBER + SUHNER	SUCOFLEX 104	MY36980/ 4	30M-18G	Apr. 14, 2020	May 01, 2020~ May 22, 2020	Apr. 13, 2021	Radiation (03CH15-HY)
RF Cable	HUBER + SUHNER	SUCOFLEX 104	MY9838/4 PE	30M-18G	Apr. 14, 2020	May 01, 2020~ May 22, 2020	Apr. 13, 2021	Radiation (03CH15-HY)
RF Cable	HUBER + SUHNER	SUCOFLEX 104	MY802430 /4	30M~18GHz	Apr. 14, 2020	May 01, 2020~ May 22, 2020	Apr. 13, 2021	Radiation (03CH15-HY)
RF Cable	HUBER + SUHNER	SUCOFLEX 102	505134/2	30MHz-40GHz	Feb. 25, 2020	May 01, 2020~ May 22, 2020	Feb. 24, 2021	Radiation (03CH15-HY)
RF Cable	HUBER + SUHNER	SUCOFLEX 102	800740/2	30MHz-40GHz	Feb. 25, 2020	May 01, 2020~ May 22, 2020	Feb. 24, 2021	Radiation (03CH15-HY)
Filter	Wainwright	WLK4-1000-1 530-8000-40S S	SN4	1.53G Low Pass	Jul. 04, 2019	May 01, 2020~ May 22, 2020	Jul. 03, 2020	Radiation (03CH15-HY)
Filter	Wainwright	WHKX12-270 0-3000-18000 -60ST	SN4	3GHz High Pass Filter	Sep. 17, 2019	May 01, 2020~ May 22, 2020	Sep. 16, 2020	Radiation (03CH15-HY)



Instrument	Manufacturer	Model No.	Serial No.	Characteristics	Calibration Date	Test Date	Due Date	Remark
Hygrometer	Testo	608-H2	41410069	N/A	Jun. 17, 2019	Apr. 24, 2020~ May 19, 2020	Jun. 16, 2020	Conducted (TH05-HY)
Power Sensor	DARE	RPR3006W	16I00054SN O10	10MHz~6GHz	Dec. 23, 2019	Apr. 24, 2020~ May 19, 2020	Dec. 22, 2020	Conducted (TH05-HY)
Spectrum Analyzer	Rohde & Schwarz	FSP40	100055	9kHz-40GHz	Aug. 14, 2019	Apr. 24, 2020~ May 19, 2020	Aug. 13, 2020	Conducted (TH05-HY)
Switch Control Manframe	Burgeon	ETF-058	EC1300484	N/A	Aug. 22, 2019	Apr. 24, 2020~ May 19, 2020	Aug. 21, 2020	Conducted (TH05-HY)
AC Power Source	ChainTek	APC-1000 W	N/A	N/A	N/A	Apr. 28, 2020	N/A	Conduction (CO05-HY)
EMI Test Receiver	Rohde & Schwarz	ESR3	102388	9kHz~3.6GHz	Nov. 15, 2019	Apr. 28, 2020	Nov. 14, 2020	Conduction (CO05-HY)
Hygrometer	Testo	608-H1	34913912	N/A	Nov. 07, 2019	Apr. 28, 2020	Nov. 06, 2020	Conduction (CO05-HY)
LISN	Rohde & Schwarz	ENV216	100080	9kHz~30MHz	Nov. 20, 2019	Apr. 28, 2020	Nov. 19, 2020	Conduction (CO05-HY)
Software	Rohde & Schwarz	EMC32 V10.30	N/A	N/A	N/A	Apr. 28, 2020	N/A	Conduction (CO05-HY)
LF Cable	HUBER + SUHNER	RG-214/U	LF01	N/A	Jan. 02, 2020	Apr. 28, 2020	Jan. 01, 2021	Conduction (CO05-HY)
Pulse Limiter	Rohde & Schwarz	ESH3-Z2	100851	N/A	Jan. 02, 2020	Apr. 28, 2020	Jan. 01, 2021	Conduction (CO05-HY)



## 5 Uncertainty of Evaluation

### Uncertainty of Conducted Emission Measurement (150kHz ~ 30MHz)

Measuring Uncertainty for a Level of Confidence of 95% ( $U = 2Uc(y)$ )	2.3
---	-----

### Uncertainty of Radiated Emission Measurement (30 MHz ~ 1000 MHz)

Measuring Uncertainty for a Level of Confidence of 95% ( $U = 2Uc(y)$ )	5.0
---	-----

### Uncertainty of Radiated Emission Measurement (1000 MHz ~ 18000 MHz)

Measuring Uncertainty for a Level of Confidence of 95% ( $U = 2Uc(y)$ )	5.4
---	-----

### Uncertainty of Radiated Emission Measurement (18000 MHz ~ 40000 MHz)

Measuring Uncertainty for a Level of Confidence of 95% ( $U = 2Uc(y)$ )	5.0
---	-----

**Appendix A. Test Result of Conducted Test Items**

Test Engineer:	Eason Huang/Sylvia Li	Temperature:	21~24	°C
Test Date:	2020/4/24~2020/05/19	Relative Humidity:	51~54	%

**TEST RESULTS DATA**  
**6dB and 99% Occupied Bandwidth**

2.4GHz Band Single Antenna										
Mod.	Data Rate	NTX	CH.	Freq. (MHz)	99% Occupied BW (MHz)		6dB BW (MHz)		6dB BW Limit (MHz)	Pass/Fail
					Ant1	Ant2	Ant1	Ant2		
11b	1Mbps	1	1	2412	12.65	-	7.54	-	0.50	Pass
11b	1Mbps	1	6	2437	12.65	-	7.08	-	0.50	Pass
11b	1Mbps	1	11	2462	12.65	-	7.04	-	0.50	Pass
11g	6Mbps	1	1	2412	16.85	-	15.72	-	0.50	Pass
11g	6Mbps	1	2	2417	16.85	-	15.68	-	0.50	Pass
11g	6Mbps	1	6	2437	16.85	-	15.68	-	0.50	Pass
11g	6Mbps	1	10	2457	16.90	-	15.76	-	0.50	Pass
11g	6Mbps	1	11	2462	16.90	-	15.68	-	0.50	Pass
HT20	MCS0	1	1	2412	18.00	-	15.96	-	0.50	Pass
HT20	MCS0	1	2	2417	18.00	-	16.00	-	0.50	Pass
HT20	MCS0	1	6	2437	18.00	-	16.26	-	0.50	Pass
HT20	MCS0	1	10	2457	17.95	-	16.04	-	0.50	Pass
HT20	MCS0	1	11	2462	18.00	-	16.28	-	0.50	Pass

**TEST RESULTS DATA**  
**Average Output Power**

2.4GHz Band Single Antenna																
Mod.	Data Rate	NTX	CH.	Freq. (MHz)	Average Conducted Power (dBm)			Conducted Power Limit (dBm)		DG (dBi)		EIRP Power (dBm)		EIRP Power Limit (dBm)		Pass /Fail
					Ant1	Ant2	SUM	Ant1	Ant2	Ant1	Ant2	Ant1	Ant2	Ant1	Ant2	
11b	1Mbps	1	1	2412	19.40	-		30.00	-	2.00	-	21.40	-	36.00	-	Pass
11b	1Mbps	1	6	2437	19.40	-		30.00	-	2.00	-	21.40	-	36.00	-	Pass
11b	1Mbps	1	11	2462	19.10	-		30.00	-	2.00	-	21.10	-	36.00	-	Pass
11g	6Mbps	1	1	2412	14.20	-		30.00	-	2.00	-	16.20	-	36.00	-	Pass
11g	6Mbps	1	2	2417	18.40	-		30.00	-	2.00	-	20.40	-	36.00	-	Pass
11g	6Mbps	1	6	2437	18.20	-		30.00	-	2.00	-	20.20	-	36.00	-	Pass
11g	6Mbps	1	10	2457	18.50	-		30.00	-	2.00	-	20.50	-	36.00	-	Pass
11g	6Mbps	1	11	2462	14.30	-		30.00	-	2.00	-	16.30	-	36.00	-	Pass
HT20	MCS0	1	1	2412	13.20	-		30.00	-	2.00	-	15.20	-	36.00	-	Pass
HT20	MCS0	1	2	2417	18.20	-		30.00	-	2.00	-	20.20	-	36.00	-	Pass
HT20	MCS0	1	6	2437	18.30	-		30.00	-	2.00	-	20.30	-	36.00	-	Pass
HT20	MCS0	1	10	2457	18.30	-		30.00	-	2.00	-	20.30	-	36.00	-	Pass
HT20	MCS0	1	11	2462	13.30	-		30.00	-	2.00	-	15.30	-	36.00	-	Pass
VHT20	MCS0	1	1	2412	13.10	-		30.00	-	2.00	-	15.10	-	36.00	-	Pass
VHT20	MCS0	1	2	2417	18.10	-		30.00	-	2.00	-	20.10	-	36.00	-	Pass
VHT20	MCS0	1	6	2437	18.20	-		30.00	-	2.00	-	20.20	-	36.00	-	Pass
VHT20	MCS0	1	10	2457	18.20	-		30.00	-	2.00	-	20.20	-	36.00	-	Pass
VHT20	MCS0	1	11	2462	13.20	-		30.00	-	2.00	-	15.20	-	36.00	-	Pass

Note: Measured power (dBm) has offset with cable loss.

**TEST RESULTS DATA**  
**Peak Power Spectral Density**

2.4GHz Band Single Antenna												
Mod.	Data Rate	NTX	CH.	Freq. (MHz)	Peak PSD (dBm/3kHz)			DG (dBi)		Peak PSD Limit (dBm/3kHz)		Pass/Fail
					Ant1	Ant2	Worse + 3.01	Ant1	Ant2	Ant1	Ant2	
11b	1Mbps	1	1	2412	-1.43	-		2.00	-	8.00	-	Pass
11b	1Mbps	1	6	2437	-2.07	-		2.00	-	8.00	-	Pass
11b	1Mbps	1	11	2462	-2.19	-		2.00	-	8.00	-	Pass
11g	6Mbps	1	1	2412	-10.86	-		2.00	-	8.00	-	Pass
11g	6Mbps	1	2	2417	-5.36	-		2.00	-	8.00	-	Pass
11g	6Mbps	1	6	2437	-5.56	-		2.00	-	8.00	-	Pass
11g	6Mbps	1	10	2457	-5.58	-		2.00	-	8.00	-	Pass
11g	6Mbps	1	11	2462	-9.88	-		2.00	-	8.00	-	Pass
HT20	MCS0	1	1	2412	-11.76	-		2.00	-	8.00	-	Pass
HT20	MCS0	1	2	2417	-6.32	-		2.00	-	8.00	-	Pass
HT20	MCS0	1	6	2437	-6.85	-		2.00	-	8.00	-	Pass
HT20	MCS0	1	10	2457	-7.32	-		2.00	-	8.00	-	Pass
HT20	MCS0	1	11	2462	-12.39	-		2.00	-	8.00	-	Pass

Measured power density (dBm) has offset with cable loss.



## Appendix B. AC Conducted Emission Test Results

Test Engineer :	Tom Lee	Temperature :	21~23°C
		Relative Humidity :	40~43%

# EUT Information

Report NO : 042038  
 Test Mode : Mode 1  
 Test Voltage : 120Vac/60Hz  
 Phase : Line

Full Spectrum

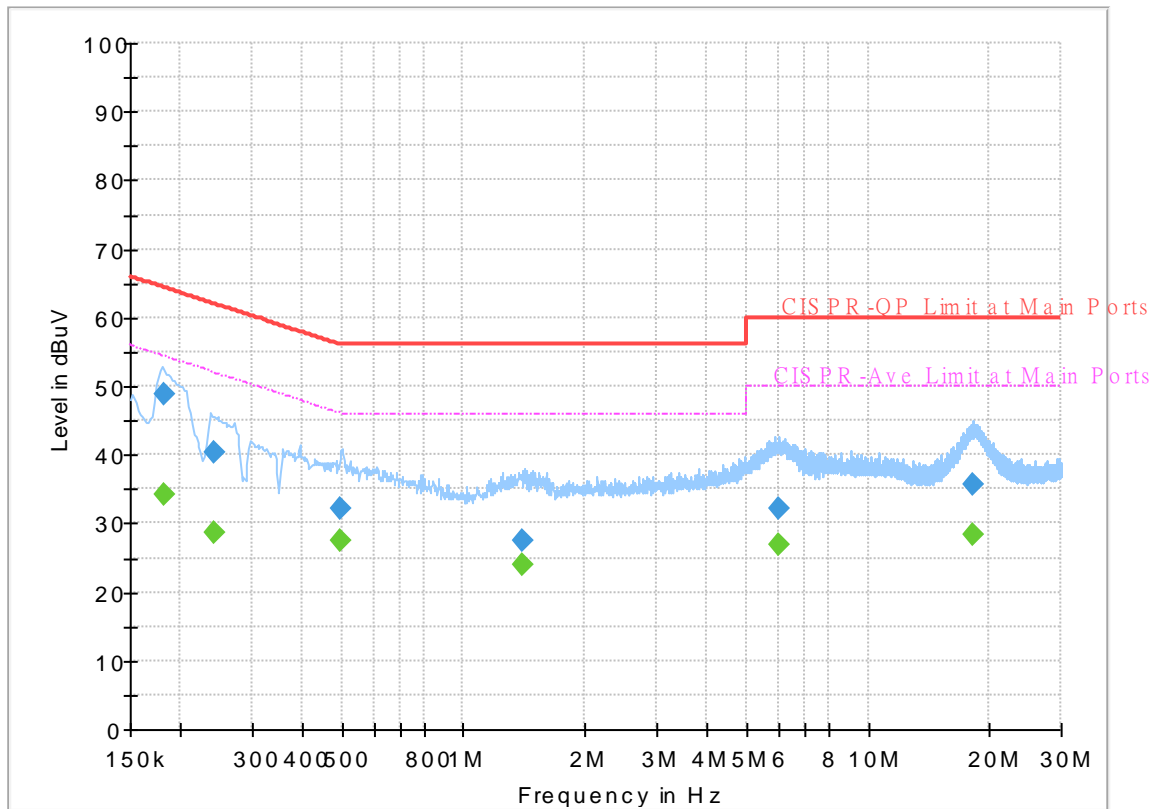

## Final\_Result

Frequency (MHz)	QuasiPeak (dBuV)	CAverage (dBuV)	Limit (dBuV)	Margin (dB)	Line	Filter	Corr. (dB)
0.182940	---	34.18	54.35	20.17	L1	OFF	19.6
0.182940	48.70	---	64.35	15.65	L1	OFF	19.6
0.242250	---	28.58	52.02	23.44	L1	OFF	19.6
0.242250	40.27	---	62.02	21.75	L1	OFF	19.6
0.498750	---	27.44	46.02	18.58	L1	OFF	19.6
0.498750	32.08	---	56.02	23.94	L1	OFF	19.6
1.405500	---	23.88	46.00	22.12	L1	OFF	19.6
1.405500	27.61	---	56.00	28.39	L1	OFF	19.6
6.033750	---	26.89	50.00	23.11	L1	OFF	19.9
6.033750	32.28	---	60.00	27.72	L1	OFF	19.9
18.260250	---	28.29	50.00	21.71	L1	OFF	20.3
18.260250	35.55	---	60.00	24.45	L1	OFF	20.3

# EUT Information

Report NO : 042038  
 Test Mode : Mode 1  
 Test Voltage : 120Vac/60Hz  
 Phase : Neutral

Full Spectrum

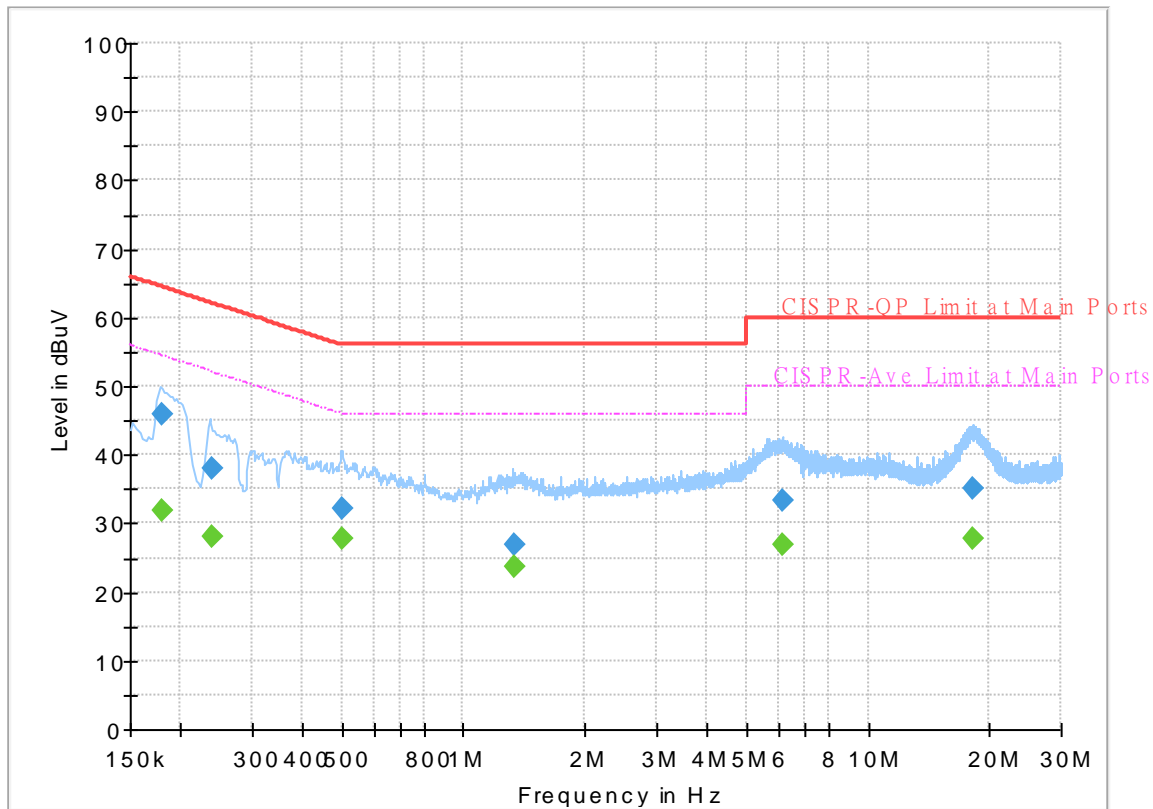

## Final Result

Frequency (MHz)	QuasiPeak (dBuV)	CAverage (dBuV)	Limit (dBuV)	Margin (dB)	Line	Filter	Corr. (dB)
0.179340	---	31.79	54.52	22.73	N	OFF	19.6
0.179340	45.92	---	64.52	18.60	N	OFF	19.6
0.238200	---	28.18	52.16	23.98	N	OFF	19.6
0.238200	38.10	---	62.16	24.06	N	OFF	19.6
0.502440	---	27.90	46.00	18.10	N	OFF	19.6
0.502440	32.21	---	56.00	23.79	N	OFF	19.6
1.331250	---	23.71	46.00	22.29	N	OFF	19.6
1.331250	26.82	---	56.00	29.18	N	OFF	19.6
6.126000	---	26.94	50.00	23.06	N	OFF	19.9
6.126000	33.32	---	60.00	26.68	N	OFF	19.9
18.240810	---	27.66	50.00	22.34	N	OFF	20.3
18.240810	35.06	---	60.00	24.94	N	OFF	20.3



### Appendix C. Radiated Spurious Emission

Test Engineer :	Leo Lee, Mancy Chou and Bigshow Wang	Temperature :	22.1~23.1°C
		Relative Humidity :	55~56%

**2.4GHz 2400~2483.5MHz**  
**WIFI 802.11b (Band Edge @ 3m)**

WIFI Ant.	Note	Frequency	Level	Over Limit	Limit Line	Read Level	Antenna Factor	Path Loss	Preamp Factor	Ant Pos	Table Pos	Peak Avg.	Pol.
1		( MHz )	( dBμV/m )	( dB )	( dBμV/m )	( dBμV )	( dB/m )	( dB )	( dB )	( cm )	( deg )	( P/A )	( H/V )
802.11b CH 01 2412MHz		2348.955	56.91	-17.09	74	42.81	28	17.27	31.17	115	288	P	H
		2390	45.03	-8.97	54	31.07	27.76	17.35	31.15	115	288	A	H
	*	2412	108.43	-	-	94.49	27.68	17.39	31.13	115	288	P	H
	*	2412	105.48	-	-	91.54	27.68	17.39	31.13	115	288	A	H
		2341.815	55.74	-18.26	74	41.64	28.02	17.25	31.17	100	265	P	V
		2390	45.05	-8.95	54	31.09	27.76	17.35	31.15	100	265	A	V
	*	2412	107.39	-	-	93.45	27.68	17.39	31.13	100	265	P	V
	*	2412	104.28	-	-	90.34	27.68	17.39	31.13	100	265	A	V
802.11b CH 06 2437MHz		2321.84	57.08	-16.92	74	42.99	28.06	17.21	31.18	111	289	P	H
		2390	44.95	-9.05	54	30.99	27.76	17.35	31.15	111	289	A	H
	*	2437	110.05	-	-	96.11	27.63	17.43	31.12	111	289	P	H
	*	2437	106.98	-	-	93.04	27.63	17.43	31.12	111	289	A	H
		2483.98	55.93	-18.07	74	41.98	27.53	17.52	31.1	111	289	P	H
		2485.96	45.15	-8.85	54	31.2	27.53	17.52	31.1	111	289	A	H
		2326.48	56.96	-17.04	74	42.87	28.05	17.22	31.18	100	266	P	V
		2343.6	44.92	-9.08	54	30.83	28.01	17.25	31.17	100	266	A	V
	*	2437	109.8	-	-	95.86	27.63	17.43	31.12	100	266	P	V
	*	2437	106.72	-	-	92.78	27.63	17.43	31.12	100	266	A	V
		2488.66	56.29	-17.71	74	42.34	27.52	17.53	31.1	100	266	P	V
		2485.96	45.09	-8.91	54	31.14	27.53	17.52	31.1	100	266	A	V



<b>802.11b</b> <b>CH 11</b> <b>2462MHz</b>	*	2462	108.72	-	-	94.77	27.58	17.48	31.11	105	289	P	H
	*	2462	105.54	-	-	91.59	27.58	17.48	31.11	105	289	A	H
		2484.16	56.6	-17.4	74	42.65	27.53	17.52	31.1	105	289	P	H
		2483.52	45.59	-8.41	54	31.64	27.53	17.52	31.1	105	289	A	H
	*	2462	107.36	-	-	93.41	27.58	17.48	31.11	100	266	P	V
	*	2462	104.22	-	-	90.27	27.58	17.48	31.11	100	266	A	V
		2493.76	56.27	-17.73	74	42.31	27.51	17.54	31.09	100	266	P	V
		2483.64	45.42	-8.58	54	31.47	27.53	17.52	31.1	100	266	A	V
<b>Remark</b>	1. No other spurious found. 2. All results are PASS against Peak and Average limit line.												



2.4GHz 2400~2483.5MHz
WIFI 802.11b (Harmonic @ 3m)

Table with 14 columns: WIFI Ant. 1, Note, Frequency (MHz), Level (dBµV/m), Over Limit (dB), Limit Line (dBµV/m), Read Level (dBµV), Antenna Factor (dB/m), Path Loss (dB), Preamp Factor (dB), Ant Pos (cm), Table Pos (deg), Peak Avg. (P/A), Pol. (H/V). Rows include data for CH 01 (2412MHz) and CH 06 (2437MHz) and CH 11 (2462MHz).



**2.4GHz 2400~2483.5MHz  
WIFI 802.11g (Band Edge @ 3m)**

WIFI Ant. 1	Note	Frequency ( MHz )	Level ( dBμV/m )	Over Limit ( dB )	Limit Line ( dBμV/m )	Read Level ( dBμV )	Antenna Factor ( dB/m )	Path Loss ( dB )	Preamp Factor ( dB )	Ant Pos ( cm )	Table Pos ( deg )	Peak Avg. ( P/A )	Pol. ( H/V )
802.11g CH 01 2412MHz		2389.905	61.06	-12.94	74	47.1	27.76	17.35	31.15	268	50	P	H
		2390	47.43	-6.57	54	33.47	27.76	17.35	31.15	268	50	A	H
	*	2412	112.25	-	-	98.31	27.68	17.39	31.13	268	50	P	H
	*	2412	104.81	-	-	90.87	27.68	17.39	31.13	268	50	A	H
		2389.38	58.18	-15.82	74	44.22	27.76	17.35	31.15	304	91	P	V
		2388.96	46.4	-7.6	54	32.43	27.77	17.35	31.15	304	91	A	V
	*	2412	108.04	-	-	94.1	27.68	17.39	31.13	304	91	P	V
	*	2412	100.48	-	-	86.54	27.68	17.39	31.13	304	91	A	V
802.11g CH 02 2417MHz		2389.94	59.82	-14.18	74	45.86	27.76	17.35	31.15	262	50	P	H
		2389.94	46.3	-7.7	54	32.34	27.76	17.35	31.15	262	50	A	H
	*	2417	112.22	38.22	74	98.28	27.67	17.4	31.13	262	50	P	H
	*	2417	104.8	50.8	54	90.86	27.67	17.4	31.13	262	50	A	H
		2387.98	58.14	-15.86	74	44.18	27.77	17.34	31.15	304	92	P	V
		2388.96	45.99	-8.01	54	32.02	27.77	17.35	31.15	304	92	A	V
	*	2417	108.49	34.49	74	94.55	27.67	17.4	31.13	304	92	P	V
	*	2417	100.57	46.57	54	86.63	27.67	17.4	31.13	304	92	A	V
802.11g CH 06 2437MHz		2389.84	58.17	-15.83	74	44.21	27.76	17.35	31.15	290	49	P	H
		2389.68	46.27	-7.73	54	32.31	27.76	17.35	31.15	290	49	A	H
	*	2437	113.07	-	-	99.13	27.63	17.43	31.12	290	49	P	H
	*	2437	105.22	-	-	91.28	27.63	17.43	31.12	290	49	A	H
		2483.71	63.18	-10.82	74	49.23	27.53	17.52	31.1	290	49	P	H
		2483.8	47.77	-6.23	54	33.82	27.53	17.52	31.1	290	49	A	H
		2313.52	56.41	-17.59	74	42.33	28.07	17.19	31.18	326	90	P	V
		2336.08	45.8	-8.2	54	31.7	28.03	17.24	31.17	326	90	A	V
	*	2437	108.52	-	-	94.58	27.63	17.43	31.12	326	90	P	V
	*	2437	100.98	-	-	87.04	27.63	17.43	31.12	326	90	A	V
		2486.23	59.89	-14.11	74	45.94	27.53	17.52	31.1	326	90	P	V
		2486.41	46.61	-7.39	54	32.66	27.53	17.52	31.1	326	90	A	V



<b>802.11g</b> <b>CH 10</b> <b>2457MHz</b>	*	2457	112.72	-	-	98.77	27.59	17.47	31.11	286	48	P	H
	*	2457	104.81	-	-	90.86	27.59	17.47	31.11	286	48	A	H
		2483.98	64.27	-9.73	74	50.32	27.53	17.52	31.1	286	48	P	H
		2483.5	48.2	-5.8	54	34.25	27.53	17.52	31.1	286	48	A	H
	*	2457	108.02	-	-	94.07	27.59	17.47	31.11	293	89	P	V
	*	2457	100.23	-	-	86.28	27.59	17.47	31.11	293	89	A	V
		2485.24	60.49	-13.51	74	46.54	27.53	17.52	31.1	293	89	P	V
		2483.62	46.64	-7.36	54	32.69	27.53	17.52	31.1	293	89	A	V
<b>802.11g</b> <b>CH 11</b> <b>2462MHz</b>	*	2462	108.43	-	-	94.48	27.58	17.48	31.11	286	48	P	H
	*	2462	100.66	-	-	86.71	27.58	17.48	31.11	286	48	A	H
		2484.76	61.09	-12.91	74	47.14	27.53	17.52	31.1	286	48	P	H
		2483.56	47.14	-6.86	54	33.19	27.53	17.52	31.1	286	48	A	H
	*	2462	104	-	-	90.05	27.58	17.48	31.11	293	91	P	V
	*	2462	96.41	-	-	82.46	27.58	17.48	31.11	293	91	A	V
		2485.44	58.74	-15.26	74	44.79	27.53	17.52	31.1	293	91	P	V
		2483.52	46.45	-7.55	54	32.5	27.53	17.52	31.1	293	91	A	V
<b>Remark</b>	1. No other spurious found. 2. All results are PASS against Peak and Average limit line.												



**2.4GHz 2400~2483.5MHz  
WIFI 802.11g (Harmonic @ 3m)**

WIFI Ant. 1	Note	Frequency ( MHz )	Level ( dBμV/m )	Over Limit ( dB )	Limit Line ( dBμV/m )	Read Level ( dBμV )	Antenna Factor ( dB/m )	Path Loss ( dB )	Preamp Factor ( dB )	Ant Pos ( cm )	Table Pos ( deg )	Peak Avg. ( P/A )	Pol. ( H/V )
802.11g CH 01 2412MHz		4824	40.84	-33.16	74	57.2	31.25	10.67	58.28	100	0	P	H
		4824	40.44	-33.56	74	56.8	31.25	10.67	58.28	100	0	P	V
802.11g CH 02 2417MHz		4834	41.16	-32.84	74	57.49	31.27	10.68	58.28	100	0	P	H
		7251	44.79	-29.21	74	54.3	36.5	12.46	58.47	100	0	P	H
		4834	40.19	-33.81	74	56.52	31.27	10.68	58.28	100	0	P	V
802.11g CH 06 2437MHz		7251	44.99	-29.01	74	54.5	36.5	12.46	58.47	100	0	P	V
		4874	38.88	-35.12	74	55.18	31.25	10.72	58.27	100	0	P	H
		7311	45.35	-28.65	74	54.78	36.52	12.56	58.51	100	0	P	H
		4874	39.28	-34.72	74	55.58	31.25	10.72	58.27	100	0	P	V
802.11g CH 10 2457MHz		7311	44.34	-29.66	74	53.77	36.52	12.56	58.51	100	0	P	V
		4914	41.27	-32.73	74	57.5	31.28	10.76	58.27	100	0	P	H
		7371	44.67	-29.33	74	54.05	36.52	12.65	58.55	100	0	P	H
		4914	39.9	-34.1	74	56.13	31.28	10.76	58.27	100	0	P	V
802.11g CH 11 2462MHz		7371	45.18	-28.82	74	54.56	36.52	12.65	58.55	100	0	P	V
		4924	40.9	-33.1	74	57.06	31.34	10.77	58.27	100	0	P	H
		7386	45.7	-28.3	74	55.13	36.46	12.67	58.56	100	0	P	H
		4924	40.83	-33.17	74	56.99	31.34	10.77	58.27	100	0	P	V
Remark		7386	44.92	-29.08	74	54.35	36.46	12.67	58.56	100	0	P	V
	1. No other spurious found. 2. All results are PASS against Peak and Average limit line.												



**2.4GHz 2400~2483.5MHz  
WIFI 802.11n HT20 (Band Edge @ 3m)**

WIFI Ant. 1	Note	Frequency ( MHz )	Level ( dBμV/m )	Over Limit ( dB )	Limit Line ( dBμV/m )	Read Level ( dBμV )	Antenna Factor ( dB/m )	Path Loss ( dB )	Preamp Factor ( dB )	Ant Pos ( cm )	Table Pos ( deg )	Peak Avg. (P/A)	Pol. (H/V)
802.11n HT20 CH 01 2412MHz		2333.625	56.83	-17.17	74	42.74	28.03	17.23	31.17	132	288	P	H
		2388.54	46.16	-7.84	54	32.2	27.77	17.34	31.15	132	288	A	H
	*	2412	104.55	-	-	90.61	27.68	17.39	31.13	132	288	P	H
	*	2412	96.4	-	-	82.46	27.68	17.39	31.13	132	288	A	H
		2389.17	56.69	-17.31	74	42.73	27.76	17.35	31.15	122	266	P	V
		2317.56	46.06	-7.94	54	31.98	28.06	17.2	31.18	122	266	A	V
	*	2412	104.15	-	-	90.21	27.68	17.39	31.13	122	266	P	V
	*	2412	95.06	-	-	81.12	27.68	17.39	31.13	122	266	A	V
802.11n HT20 CH 02 2417MHz		2339.6	55.63	-18.37	74	41.53	28.02	17.25	31.17	141	310	P	H
		2390	46.18	-7.82	54	32.22	27.76	17.35	31.15	141	310	A	H
	*	2417	111.39	-	-	97.45	27.67	17.4	31.13	141	310	P	H
	*	2417	102.26	-	-	88.32	27.67	17.4	31.13	141	310	A	H
		2485.6	56.33	-17.67	74	42.38	27.53	17.52	31.1	141	310	P	H
		2483.53	46.37	-7.63	54	32.42	27.53	17.52	31.1	141	310	A	H
		2388.4	57	-17	74	43.04	27.77	17.34	31.15	107	265	P	V
		2390	46.03	-7.97	54	32.07	27.76	17.35	31.15	107	265	A	V
	*	2417	108.93	-	-	94.99	27.67	17.4	31.13	107	265	P	V
	*	2417	100.45	-	-	86.51	27.67	17.4	31.13	107	265	A	V
		2487.94	55.57	-18.43	74	41.63	27.52	17.52	31.1	107	265	P	V
		2484.61	46.16	-7.84	54	32.21	27.53	17.52	31.1	107	265	A	V



<b>802.11n</b> <b>HT20</b> <b>CH 06</b> <b>2437MHz</b>		2350.64	55.69	-18.31	74	41.58	28	17.27	31.16	110	308	P	H
		2389.2	46.15	-7.85	54	32.19	27.76	17.35	31.15	110	308	A	H
	*	2437	111.44	-	-	97.5	27.63	17.43	31.12	110	308	P	H
	*	2437	102.07	-	-	88.13	27.63	17.43	31.12	110	308	A	H
		2484.61	62.1	-11.9	74	48.15	27.53	17.52	31.1	110	308	P	H
		2483.71	47.02	-6.98	54	33.07	27.53	17.52	31.1	110	308	A	H
		2389.84	56.68	-17.32	74	42.72	27.76	17.35	31.15	100	267	P	V
		2343.6	46.05	-7.95	54	31.96	28.01	17.25	31.17	100	267	A	V
	*	2437	111.09	-	-	97.15	27.63	17.43	31.12	100	267	P	V
	*	2437	102.31	-	-	88.37	27.63	17.43	31.12	100	267	A	V
		2484.43	60.8	-13.2	74	46.85	27.53	17.52	31.1	100	267	P	V
		2486.95	46.88	-7.12	54	32.93	27.53	17.52	31.1	100	267	A	V
<b>802.11n</b> <b>HT20</b> <b>CH 10</b> <b>2457MHz</b>		2319.44	56.32	-17.68	74	42.23	28.06	17.21	31.18	139	305	P	H
		2335.92	45.94	-8.06	54	31.84	28.03	17.24	31.17	139	305	A	H
	*	2457	110.14	-	-	96.19	27.59	17.47	31.11	139	305	P	H
	*	2457	101.02	-	-	87.07	27.59	17.47	31.11	139	305	A	H
		2486.05	61.82	-12.18	74	47.87	27.53	17.52	31.1	139	305	P	H
		2483.62	47.16	-6.84	54	33.21	27.53	17.52	31.1	139	305	A	H
		2329.84	56.12	-17.88	74	42.03	28.04	17.23	31.18	100	267	P	V
		2344.4	45.97	-8.03	54	31.87	28.01	17.26	31.17	100	267	A	V
	*	2457	109.88	-	-	95.93	27.59	17.47	31.11	100	267	P	V
	*	2457	100.45	-	-	86.5	27.59	17.47	31.11	100	267	A	V
		2485.96	60.85	-13.15	74	46.9	27.53	17.52	31.1	100	267	P	V
		2484.07	47.11	-6.89	54	33.16	27.53	17.52	31.1	100	267	A	V



<b>802.11n</b> <b>HT20</b> <b>CH 11</b> <b>2462MHz</b>	*	2462	104.94	-	-	90.99	27.58	17.48	31.11	127	308	P	H
	*	2462	96.51	-	-	82.56	27.58	17.48	31.11	127	308	A	H
		2484.52	58.11	-15.89	74	44.16	27.53	17.52	31.1	127	308	P	H
		2483.72	46.68	-7.32	54	32.73	27.53	17.52	31.1	127	308	A	H
	*	2462	103.66	-	-	89.71	27.58	17.48	31.11	117	266	P	V
	*	2462	95.37	-	-	81.42	27.58	17.48	31.11	117	266	A	V
		2485.68	58.18	-15.82	74	44.23	27.53	17.52	31.1	117	266	P	V
		2483.52	46.42	-7.58	54	32.47	27.53	17.52	31.1	117	266	A	V
<b>Remark</b>	1. No other spurious found. 2. All results are PASS against Peak and Average limit line.												



**2.4GHz 2400~2483.5MHz  
WIFI 802.11n HT20 (Harmonic @ 3m)**

WIFI Ant. 1	Note	Frequency ( MHz )	Level ( dBμV/m )	Over Limit ( dB )	Limit Line ( dBμV/m )	Read Level ( dBμV )	Antenna Factor ( dB/m )	Path Loss ( dB )	Preamp Factor ( dB )	Ant Pos ( cm )	Table Pos ( deg )	Peak Avg. ( P/A )	Pol. ( H/V )
802.11n HT20 CH 01 2412MHz		4824	40.77	-33.23	74	57.13	31.25	10.67	58.28	100	0	P	H
		4824	40.72	-33.28	74	57.08	31.25	10.67	58.28	100	0	P	V
802.11n HT20 CH 02 2417MHz		4834	39.93	-34.07	74	56.26	31.27	10.68	58.28	100	0	P	H
		7251	44.93	-29.07	74	54.44	36.5	12.46	58.47	100	0	P	H
		4834	39.5	-34.5	74	55.83	31.27	10.68	58.28	100	0	P	V
		7251	45.38	-28.62	74	54.89	36.5	12.46	58.47	100	0	P	V
802.11n HT20 CH 06 2437MHz		4874	39.37	-34.63	74	55.67	31.25	10.72	58.27	100	0	P	H
		7311	44.82	-29.18	74	54.25	36.52	12.56	58.51	100	0	P	H
		4874	39.45	-34.55	74	55.75	31.25	10.72	58.27	100	0	P	V
		7311	44.88	-29.12	74	54.31	36.52	12.56	58.51	100	0	P	V
802.11n HT20 CH 10 2457MHz		4914	39.87	-34.13	74	56.1	31.28	10.76	58.27	100	0	P	H
		7371	44.95	-29.05	74	54.33	36.52	12.65	58.55	100	0	P	H
		4914	40.73	-33.27	74	56.96	31.28	10.76	58.27	100	0	P	V
		7371	45.48	-28.52	74	54.86	36.52	12.65	58.55	100	0	P	V
802.11n HT20 CH 11 2462MHz		4924	39.61	-34.39	74	55.77	31.34	10.77	58.27	100	0	P	H
		7386	45.04	-28.96	74	54.47	36.46	12.67	58.56	100	0	P	H
		4924	39.91	-34.09	74	56.07	31.34	10.77	58.27	100	0	P	V
		7386	45.17	-28.83	74	54.6	36.46	12.67	58.56	100	0	P	V
Remark	1. No other spurious found. 2. All results are PASS against Peak and Average limit line.												



Emission below 1GHz
2.4GHz WIFI 802.11b (LF)

Table with 14 columns: WIFI, Note, Frequency, Level, Over, Limit, Read, Antenna, Path, Preamp, Ant, Table, Peak, Pol. It contains 12 rows of test data for 2.4GHz WIFI 802.11b LF and a Remark section at the bottom.



Emission below 1GHz
2.4GHz WIFI 802.11g (LF)

Table with 14 columns: WIFI, Note, Frequency, Level, Over, Limit, Read, Antenna, Path, Preamp, Ant, Table, Peak, Pol. It contains 12 rows of test data for 2.4GHz WIFI 802.11g LF and a Remark section at the bottom.



**Note symbol**

*	<b>Fundamental Frequency</b> which can be ignored. However, the level of any unwanted emissions shall not exceed the level of the fundamental frequency.
!	Test result is <b>over limit</b> line.
P/A	<b>Peak</b> or <b>Average</b>
H/V	<b>Horizontal</b> or <b>Vertical</b>



A calculation example for radiated spurious emission is shown as below:

WIFI	Note	Frequency	Level	Over	Limit	Read	Antenna	Path	Preamp	Ant	Table	Peak	Pol.
Ant.				Limit	Line	Level	Factor	Loss	Factor	Pos	Pos	Avg.	
1		( MHz )	( dBμV/m )	( dB )	( dBμV/m )	( dBμV )	( dB/m )	( dB )	( dB )	( cm )	( deg )	( P/A )	( H/V )
802.11b		2390	55.45	-18.55	74	54.51	32.22	4.58	35.86	103	308	P	H
CH 01													
2412MHz		2390	43.54	-10.46	54	42.6	32.22	4.58	35.86	103	308	A	H

1. Path Loss(dB) = Cable loss(dB) + Filter loss(dB) + Attenuator loss(dB)
2. Level(dBμV/m) =  
Antenna Factor(dB/m) + Path Loss(dB) + Read Level(dBμV) - Preamp Factor(dB)
3. Over Limit(dB) = Level(dBμV/m) – Limit Line(dBμV/m)

**For Peak Limit @ 2390MHz:**

1. Level(dBμV/m)  
= Antenna Factor(dB/m) + Path Loss(dB) + Read Level(dBμV) - Preamp Factor(dB)  
= 32.22(dB/m) + 4.58(dB) + 54.51(dBμV) – 35.86 (dB)  
= 55.45 (dBμV/m)
2. Over Limit(dB)  
= Level(dBμV/m) – Limit Line(dBμV/m)  
= 55.45(dBμV/m) – 74(dBμV/m)  
= -18.55(dB)

**For Average Limit @ 2390MHz:**

1. Level(dBμV/m)  
= Antenna Factor(dB/m) + Path Loss(dB) + Read Level(dBμV) - Preamp Factor(dB)  
= 32.22(dB/m) + 4.58(dB) + 42.6(dBμV) – 35.86 (dB)  
= 43.54 (dBμV/m)
2. Over Limit(dB)  
= Level(dBμV/m) – Limit Line(dBμV/m)  
= 43.54(dBμV/m) – 54(dBμV/m)  
= -10.46(dB)

Both peak and average measured complies with the limit line, so test result is “PASS”.



## Appendix D. Radiated Spurious Emission Plots

Test Engineer :	Leo Lee, Mancy Chou and Bigshow Wang	Temperature :	22.1~23.1°C
		Relative Humidity :	55~56%

### Note symbol

-L	Low channel location
-R	High channel location

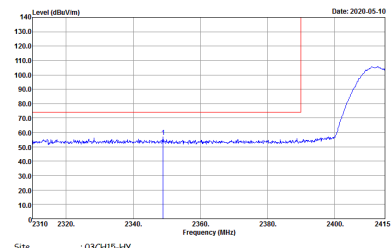
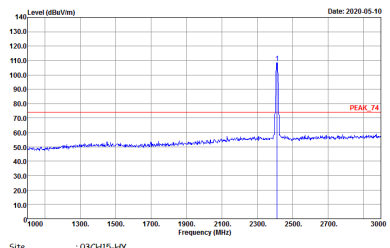
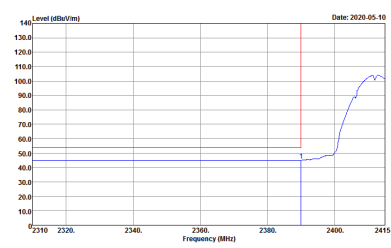
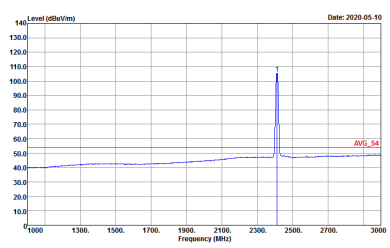

2.4GHz 2400~2483.5MHz  
WIFI 802.11b (Band Edge @ 3m)

WIFI	2.4GHz 2400~2483.5MHz Band Edge @ 3m	
ANT	802.11b CH01 2412MHz	
1	Horizontal	Fundamental
Peak	 <p>Site : 03CH15-HY Condition : PEAK_BE_74 3m 91200_15_1620 HORIZONTAL Detector : Peak Project : 042038</p>	 <p>Site : 03CH15-HY Condition : PEAK_74 3m 91200_15_1620 HORIZONTAL Detector : Peak Project : 042038</p>
Avg.	 <p>Site : 03CH15-HY Condition : AVG_BE_54 3m 91200_15_1620 HORIZONTAL Detector : Peak Project : 042038</p>	 <p>Site : 03CH15-HY Condition : AVG_54 3m 91200_15_1620 HORIZONTAL Detector : Peak Project : 042038</p>

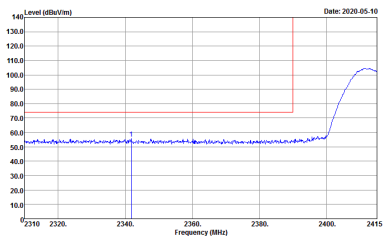
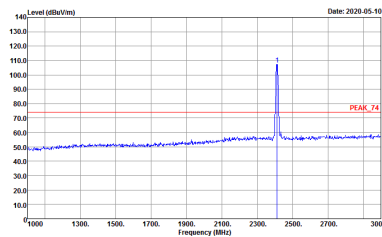
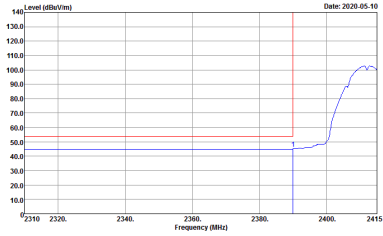
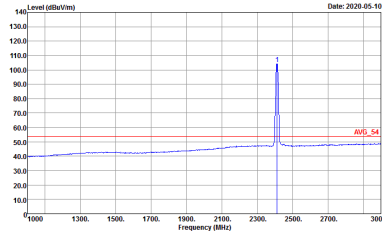

WIFI	2.4GHz 2400~2483.5MHz Band Edge @ 3m	
ANT	802.11b CH01 2412MHz	
1	Vertical	Fundamental
Peak	 <p>Date: 2020-05-10</p> <p>Site : 03CH15-HY            Condition : PEAK_BE_74 3m 91200_15_1620 VERTICAL            : RBW:1000.000KHz VBW:3000.000KHz SWT:Auto            Detector : Peak            Project : 042038</p>	 <p>Date: 2020-05-10</p> <p>Site : 03CH15-HY            Condition : PEAK_74 3m 91200_15_1620 VERTICAL            : RBW:1000.000KHz VBW:3000.000KHz SWT:Auto            Detector : Peak            Project : 042038</p>
Avg.	 <p>Date: 2020-05-10</p> <p>Site : 03CH15-HY            Condition : AVG_BE_54 3m 91200_15_1620 VERTICAL            : RBW:1000.000KHz VBW:3000.000KHz SWT:Auto            Detector : Peak            Project : 042038</p>	 <p>Date: 2020-05-10</p> <p>Site : 03CH15-HY            Condition : AVG_54 3m 91200_15_1620 VERTICAL            : RBW:1000.000KHz VBW:3000.000KHz SWT:Auto            Detector : Peak            Project : 042038</p>

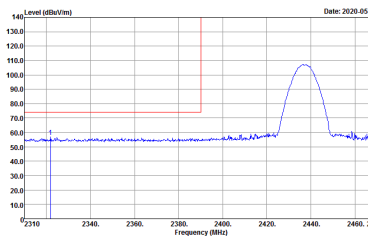
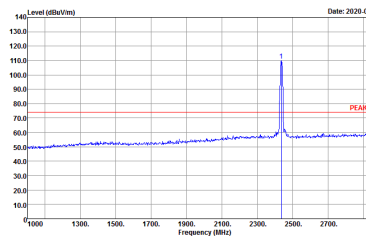
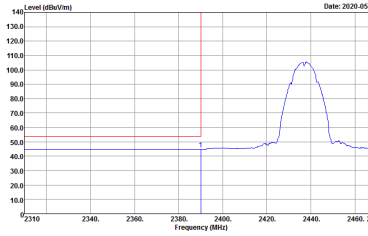
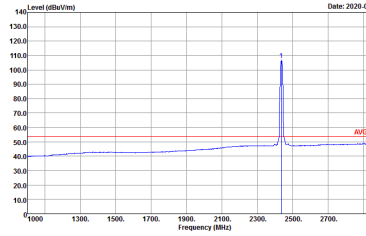

WIFI	2.4GHz 2400~2483.5MHz Band Edge @ 3m	
ANT	802.11b CH06 2437MHz - L	
1	Horizontal	Fundamental
Peak	 <p>Date: 2020-05-10</p> <p>Site : 03CH15-HY            Condition : PEAK_BE_74 3m 91200_15_1620 HORIZONTAL            : RBW:1000.000KHz VBW:3000.000KHz SWT:Auto            Detector : Peak            Project : 042038</p>	 <p>Date: 2020-05-10</p> <p>Site : 03CH15-HY            Condition : PEAK_74 3m 91200_15_1620 HORIZONTAL            : RBW:1000.000KHz VBW:3000.000KHz SWT:Auto            Detector : Peak            Project : 042038</p>
Avg.	 <p>Date: 2020-05-10</p> <p>Site : 03CH15-HY            Condition : AVG_BE_54 3m 91200_15_1620 HORIZONTAL            : RBW:1000.000KHz VBW:0.010KHz SWT:Auto            Detector : Peak            Project : 042038</p>	 <p>Date: 2020-05-10</p> <p>Site : 03CH15-HY            Condition : AVG_54 3m 91200_15_1620 HORIZONTAL            : RBW:1000.000KHz VBW:0.010KHz SWT:Auto            Detector : Peak            Project : 042038</p>

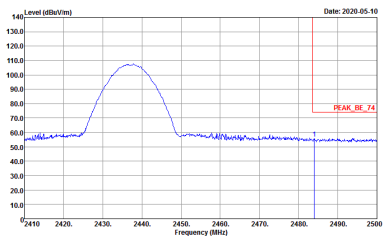
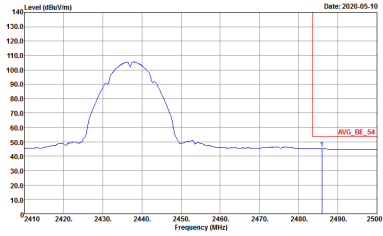

WIFI	2.4GHz 2400~2483.5MHz Band Edge @ 3m	
ANT	802.11b CH06 2437MHz - R	
1	Horizontal	Fundamental
<p><b>Peak</b></p>	 <p>Site : 03CH15-HY            Condition : PEAK_BE_74 3m 91200_15_1620 HORIZONTAL            Detector : Peak            Project : 042038</p>	<p>Left blank</p>
<p><b>Avg.</b></p>	 <p>Site : 03CH15-HY            Condition : AVG_BE_54 3m 91200_15_1620 HORIZONTAL            Detector : Peak            Project : 042038</p>	<p>Left blank</p>



WIFI	2.4GHz 2400~2483.5MHz Band Edge @ 3m	
ANT	802.11b CH06 2437MHz - L	
1	Vertical	Fundamental
<b>Peak</b>	<p>Site : 03CH15-HY Condition : PEAK_BE_74 3m 91200_15_1620 VERTICAL Detector : RBW:1000.000KHz VBW:3000.000KHz SWT:Auto Project : Peak Project : 042038</p>	<p>Site : 03CH15-HY Condition : PEAK_74 3m 91200_15_1620 VERTICAL Detector : RBW:1000.000KHz VBW:3000.000KHz SWT:Auto Project : Peak Project : 042038</p>
<b>Avg.</b>	<p>Site : 03CH15-HY Condition : AVG_BE_54 3m 91200_15_1620 VERTICAL Detector : RBW:1000.000KHz VBW:0.010KHz SWT:Auto Project : Peak Project : 042038</p>	<p>Site : 03CH15-HY Condition : AVG_54 3m 91200_15_1620 VERTICAL Detector : RBW:1000.000KHz VBW:0.010KHz SWT:Auto Project : Peak Project : 042038</p>

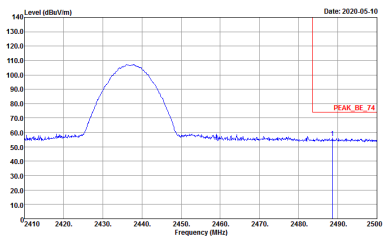
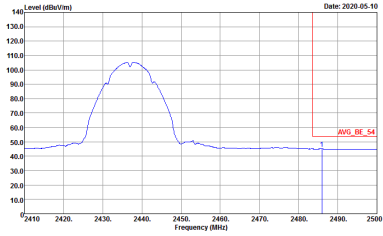

WIFI	2.4GHz 2400~2483.5MHz Band Edge @ 3m	
ANT	802.11b CH06 2437MHz - R	
1	Vertical	Fundamental
Peak	 <p>Site : 03CH15-HY            Condition : PEAK_BE_74 3m 91200_15_1620 VERTICAL            Detector : Peak            Project : 042038</p>	Left blank
Avg.	 <p>Site : 03CH15-HY            Condition : AVG_BE_54 3m 91200_15_1620 VERTICAL            Detector : Peak            Project : 042038</p>	Left blank

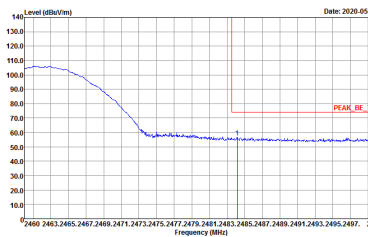
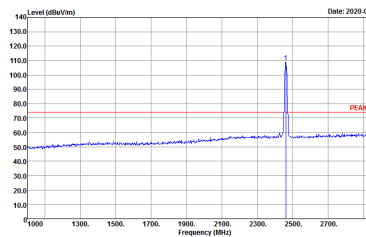
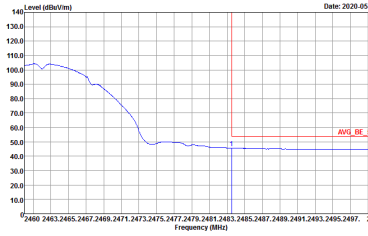
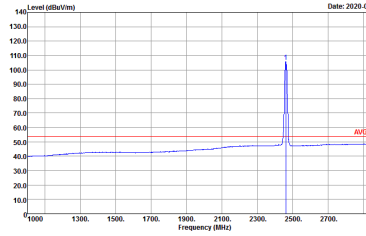

WIFI	2.4GHz 2400~2483.5MHz Band Edge @ 3m	
ANT	802.11b CH11 2462MHz	
1	Horizontal	Fundamental
Peak	 <p>Date: 2020-05-10</p> <p>Site : 03CH15-HY            Condition : PEAK_BE_74 3m 91200_15_1620 HORIZONTAL            RBW:1000.000KHz VBW:3000.000KHz SWT:Auto            Detector : Peak            Project : 042038</p>	 <p>Date: 2020-05-10</p> <p>Site : 03CH15-HY            Condition : PEAK_74 3m 91200_15_1620 HORIZONTAL            RBW:1000.000KHz VBW:3000.000KHz SWT:Auto            Detector : Peak            Project : 042038</p>
Avg.	 <p>Date: 2020-05-10</p> <p>Site : 03CH15-HY            Condition : AVG_BE_54 3m 91200_15_1620 HORIZONTAL            RBW:1000.000KHz VBW:0.010KHz SWT:Auto            Detector : Peak            Project : 042038</p>	 <p>Date: 2020-05-10</p> <p>Site : 03CH15-HY            Condition : AVG_54 3m 91200_15_1620 HORIZONTAL            RBW:1000.000KHz VBW:0.010KHz SWT:Auto            Detector : Peak            Project : 042038</p>

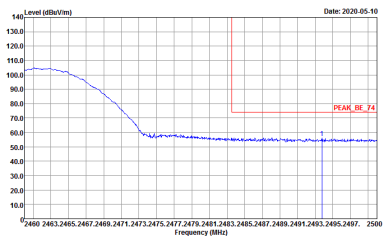
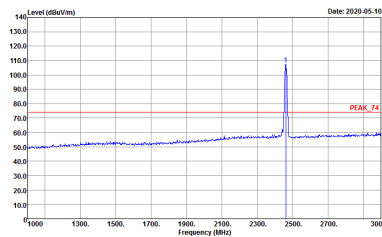
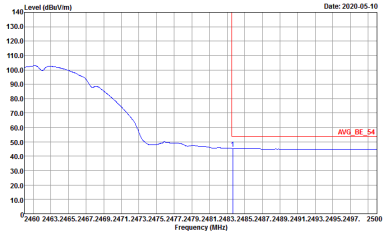
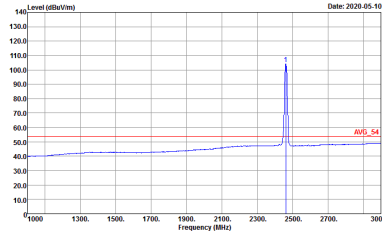

WIFI	2.4GHz 2400~2483.5MHz Band Edge @ 3m	
ANT	802.11b CH11 2462MHz	
1	Vertical	Fundamental
Peak	 <p>Date: 2020-05-10</p> <p>Site : 03CH15-HY            Condition : PEAK_BE_74 3m 91200_15_1620 VERTICAL            : RBW:1000.000KHz VBW:3000.000KHz SWT:Auto            Detector : Peak            Project : 042038</p>	 <p>Date: 2020-05-10</p> <p>Site : 03CH15-HY            Condition : PEAK_74 3m 91200_15_1620 VERTICAL            : RBW:1000.000KHz VBW:3000.000KHz SWT:Auto            Detector : Peak            Project : 042038</p>
Avg.	 <p>Date: 2020-05-10</p> <p>Site : 03CH15-HY            Condition : AVG_BE_54 3m 91200_15_1620 VERTICAL            : RBW:1000.000KHz VBW:0.010KHz SWT:Auto            Detector : Peak            Project : 042038</p>	 <p>Date: 2020-05-10</p> <p>Site : 03CH15-HY            Condition : AVG_54 3m 91200_15_1620 VERTICAL            : RBW:1000.000KHz VBW:0.010KHz SWT:Auto            Detector : Peak            Project : 042038</p>

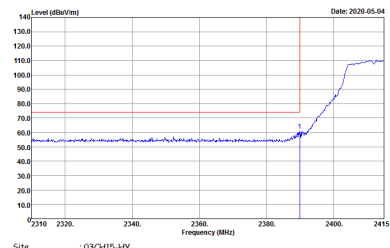
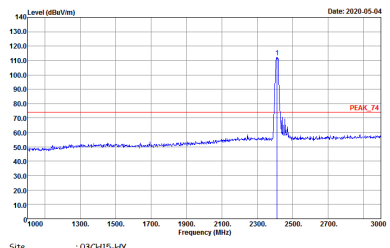
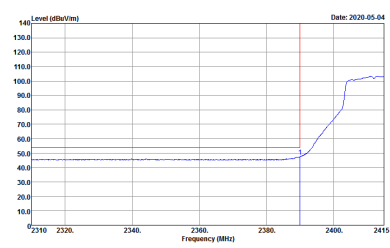
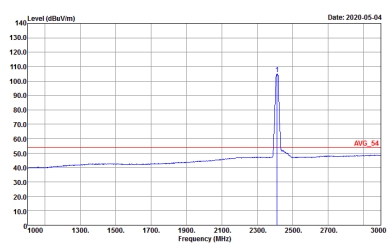

2.4GHz 2400~2483.5MHz  
WIFI 802.11g (Band Edge @ 3m)

WIFI	2.4GHz 2400~2483.5MHz Band Edge @ 3m	
ANT	802.11g CH01 2412MHz	
1	Horizontal	Fundamental
Peak	 <p>Site : 03CH15-HY Condition : PEAK_BE_74 3m 91200_15_1620 HORIZONTAL Detector : Peak Project : 042038</p>	 <p>Site : 03CH15-HY Condition : PEAK_74 3m 91200_15_1620 HORIZONTAL Detector : Peak Project : 042038</p>
Avg.	 <p>Site : 03CH15-HY Condition : AVG_BE_54 3m 91200_15_1620 HORIZONTAL Detector : Peak Project : 042038</p>	 <p>Site : 03CH15-HY Condition : AVG_54 3m 91200_15_1620 HORIZONTAL Detector : Peak Project : 042038</p>

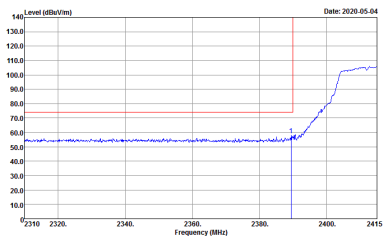
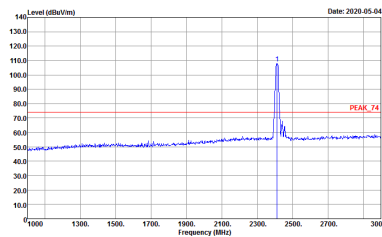
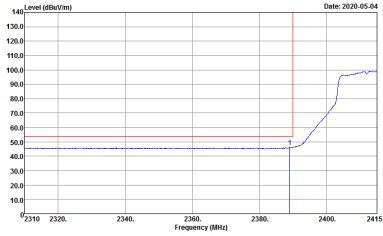
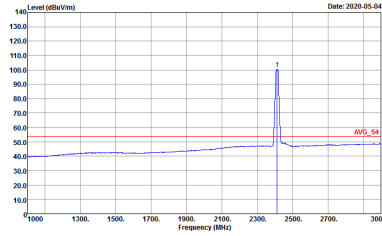

WIFI	2.4GHz 2400~2483.5MHz Band Edge @ 3m	
ANT	802.11g CH01 2412MHz	
1	Vertical	Fundamental
Peak	 <p>Site : 03CH15-HY            Condition : PEAK_BE_74 3m 91200_15_1620 VERTICAL            Detector : Peak            Project : 042038</p>	 <p>Site : 03CH15-HY            Condition : PEAK_74 3m 91200_15_1620 VERTICAL            Detector : Peak            Project : 042038</p>
Avg.	 <p>Site : 03CH15-HY            Condition : AVG_BE_54 3m 91200_15_1620 VERTICAL            Detector : Peak            Project : 042038</p>	 <p>Site : 03CH15-HY            Condition : AVG_54 3m 91200_15_1620 VERTICAL            Detector : Peak            Project : 042038</p>

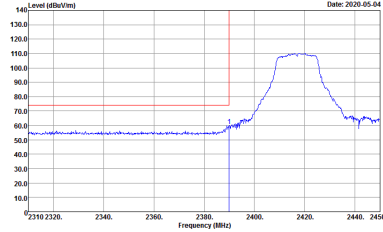
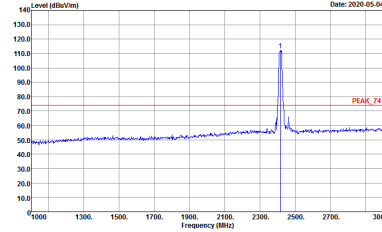
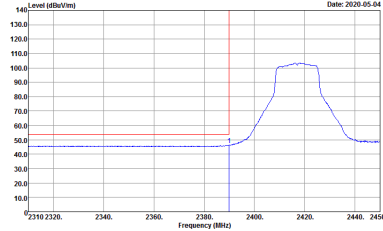
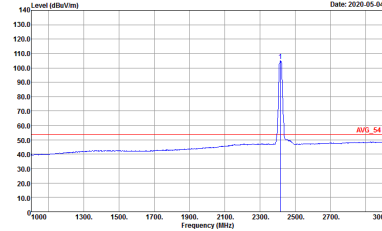

WIFI	2.4GHz 2400~2483.5MHz Band Edge @ 3m	
ANT	802.11g CH02 2417MHz	
1	Horizontal	Fundamental
Peak	 <p>Site : 03CH15-HY            Condition : PEAK_BE_74 3m 91200_15_1620 HORIZONTAL            Detector : Peak            Project : 042038</p>	 <p>Site : 03CH15-HY            Condition : PEAK_74 3m 91200_15_1620 HORIZONTAL            Detector : Peak            Project : 042038</p>
Avg.	 <p>Site : 03CH15-HY            Condition : AVG_BE_54 3m 91200_15_1620 HORIZONTAL            Detector : Peak            Project : 042038</p>	 <p>Site : 03CH15-HY            Condition : AVG_54 3m 91200_15_1620 HORIZONTAL            Detector : Peak            Project : 042038</p>



WIFI	2.4GHz 2400~2483.5MHz Band Edge @ 3m	
ANT	802.11g CH02 2417MHz	
1	Vertical	Fundamental
<b>Peak</b>	<p>Site : 03CH15-HY            Condition : PEAK_BE_74 3m 91200_15_1620 VERTICAL            RBW:1000.000KHz VBW:3000.000KHz SWT:Auto            Detector : Peak            Project : 042038</p>	<p>Site : 03CH15-HY            Condition : PEAK_74 3m 91200_15_1620 VERTICAL            RBW:1000.000KHz VBW:3000.000KHz SWT:Auto            Detector : Peak            Project : 042038</p>
<b>Avg.</b>	<p>Site : 03CH15-HY            Condition : AVG_BE_54 3m 91200_15_1620 VERTICAL            RBW:1000.000KHz VBW:1000KHz SWT:Auto            Detector : Peak            Project : 042038</p>	<p>Site : 03CH15-HY            Condition : AVG_54 3m 91200_15_1620 VERTICAL            RBW:1000.000KHz VBW:1000KHz SWT:Auto            Detector : Peak            Project : 042038</p>

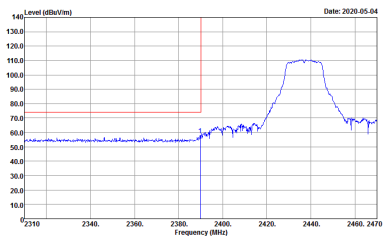
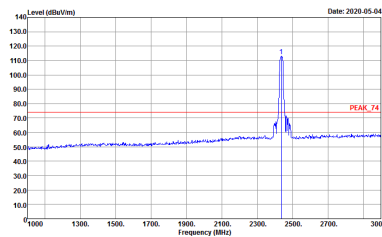
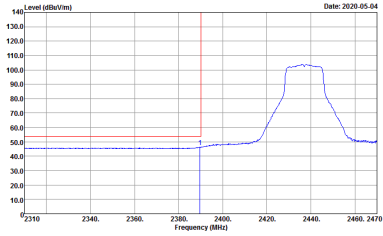
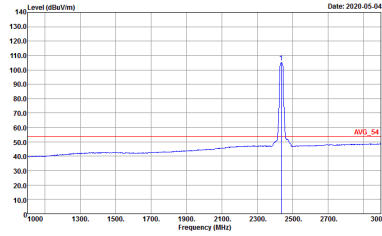

WIFI	2.4GHz 2400~2483.5MHz Band Edge @ 3m	
ANT	802.11g CH06 2437MHz - L	
1	Horizontal	Fundamental
Peak	 <p>Site : 03CH15-HY            Condition : PEAK_BE_74 3m 91200_15_1620 HORIZONTAL            Detector : Peak            Project : 042038</p>	 <p>Site : 03CH15-HY            Condition : PEAK_74 3m 91200_15_1620 HORIZONTAL            Detector : Peak            Project : 042038</p>
Avg.	 <p>Site : 03CH15-HY            Condition : AVG_BE_54 3m 91200_15_1620 HORIZONTAL            Detector : Peak            Project : 042038</p>	 <p>Site : 03CH15-HY            Condition : AVG_54 3m 91200_15_1620 HORIZONTAL            Detector : Peak            Project : 042038</p>

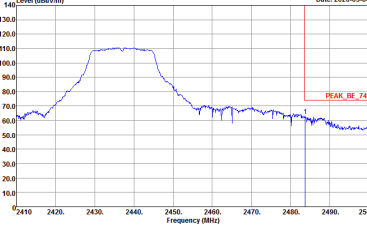
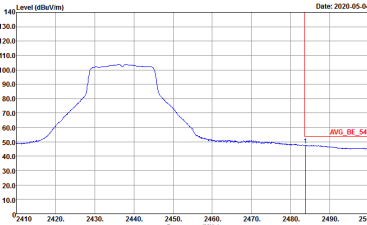

WIFI	2.4GHz 2400~2483.5MHz Band Edge @ 3m	
ANT	802.11g CH06 2437MHz - R	
1	Horizontal	Fundamental
Peak	 <p>Site : 03CH15-HY  Condition : PEAK_BE_74 3m 91200_15_1620 HORIZONTAL  Detector : Peak  Project : 042038</p>	Left blank
Avg.	 <p>Site : 03CH15-HY  Condition : AVG_BE_54 3m 91200_15_1620 HORIZONTAL  Detector : Peak  Project : 042038</p>	Left blank



WIFI	2.4GHz 2400~2483.5MHz Band Edge @ 3m	
ANT	802.11g CH06 2437MHz - L	
1	Vertical	Fundamental
<b>Peak</b>	<p>Site : 03CH15-HY            Condition : PEAK_BE_74 3m 91200_15_1620 VERTICAL            : RBW:1000.000KHz VBW:3000.000KHz SWT:Auto            Detector : Peak            Project : 042038</p>	<p>Site : 03CH15-HY            Condition : PEAK_74 3m 91200_15_1620 VERTICAL            : RBW:1000.000KHz VBW:3000.000KHz SWT:Auto            Detector : Peak            Project : 042038</p>
	<p>Site : 03CH15-HY            Condition : AVG_BE_54 3m 91200_15_1620 VERTICAL            : RBW:1000.000KHz VBW:1000KHz SWT:Auto            Detector : Peak            Project : 042038</p>	<p>Site : 03CH15-HY            Condition : AVG_54 3m 91200_15_1620 VERTICAL            : RBW:1000.000KHz VBW:1000KHz SWT:Auto            Detector : Peak            Project : 042038</p>
<b>Avg.</b>		

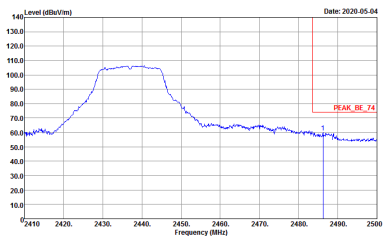
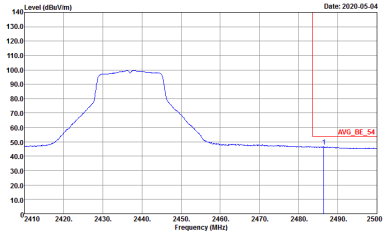

WIFI	2.4GHz 2400~2483.5MHz Band Edge @ 3m	
ANT	802.11g CH06 2437MHz - R	
1	Vertical	Fundamental
<p><b>Peak</b></p>	 <p>Site : 03CH15-HY            Condition : PEAK_BE_74 3m 91200_15_1620 VERTICAL            Detector : Peak            Project : 042038</p>	<p>Left Blank</p>
<p><b>Avg.</b></p>	 <p>Site : 03CH15-HY            Condition : AVG_BE_54 3m 91200_15_1620 VERTICAL            Detector : Peak            Project : 042038</p>	<p>Left Blank</p>

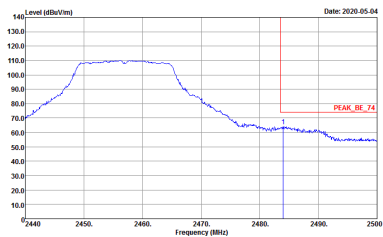
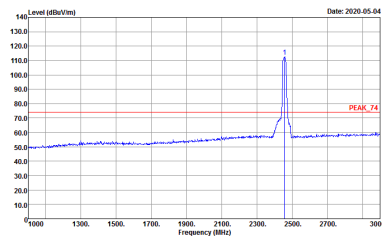
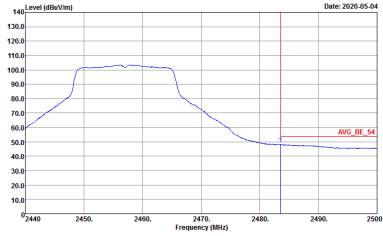
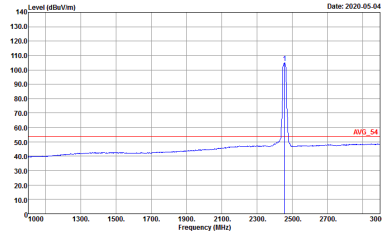

WIFI	2.4GHz 2400~2483.5MHz Band Edge @ 3m	
ANT	802.11g CH10 2457MHz	
1	Horizontal	Fundamental
Peak	 <p>Date: 2020-05-04</p> <p>Site : 03CH15-HY            Condition : PEAK_BE_74 3m 91200_15_1620 HORIZONTAL            RBW:1000.000KHz VBW:3000.000KHz SWT:Auto            Detector : Peak            Project : 042038</p>	 <p>Date: 2020-05-04</p> <p>Site : 03CH15-HY            Condition : PEAK_74 3m 91200_15_1620 HORIZONTAL            RBW:1000.000KHz VBW:3000.000KHz SWT:Auto            Detector : Peak            Project : 042038</p>
Avg.	 <p>Date: 2020-05-04</p> <p>Site : 03CH15-HY            Condition : AVG_BE_54 3m 91200_15_1620 HORIZONTAL            RBW:1000.000KHz VBW:1000KHz SWT:Auto            Detector : Peak            Project : 042038</p>	 <p>Date: 2020-05-04</p> <p>Site : 03CH15-HY            Condition : AVG_54 3m 91200_15_1620 HORIZONTAL            RBW:1000.000KHz VBW:1000KHz SWT:Auto            Detector : Peak            Project : 042038</p>

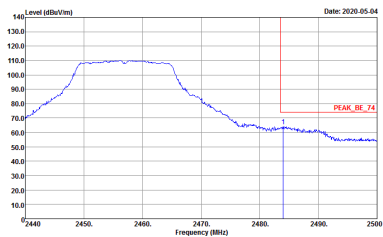
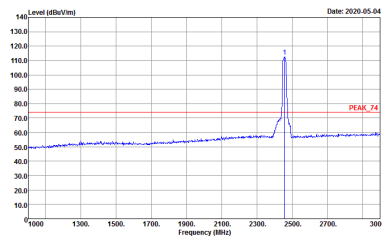
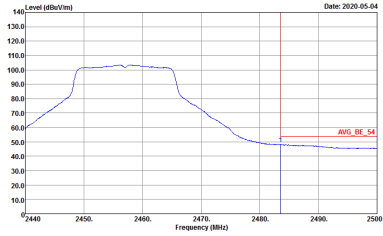
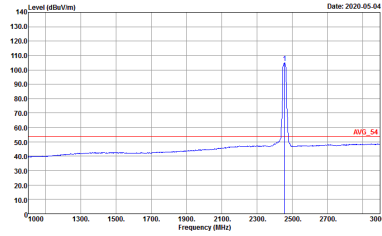

WIFI	2.4GHz 2400~2483.5MHz Band Edge @ 3m	
ANT	802.11g CH10 2457MHz	
1	Vertical	Fundamental
Peak	 <p>Site : 03CH15-HY            Condition : PEAK_BE_74 3m 91200_15_1620 HORIZONTAL            Detector : Peak            Project : 042038</p>	 <p>Site : 03CH15-HY            Condition : PEAK_74 3m 91200_15_1620 HORIZONTAL            Detector : Peak            Project : 042038</p>
Avg.	 <p>Site : 03CH15-HY            Condition : AVG_BE_54 3m 91200_15_1620 HORIZONTAL            Detector : Peak            Project : 042038</p>	 <p>Site : 03CH15-HY            Condition : AVG_54 3m 91200_15_1620 HORIZONTAL            Detector : Peak            Project : 042038</p>

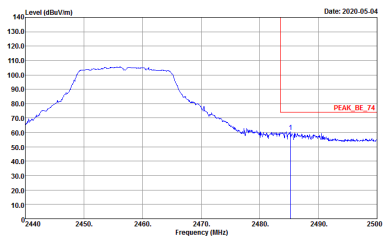
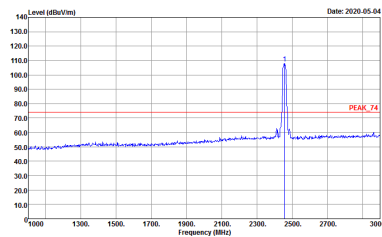
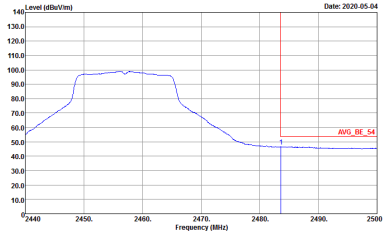
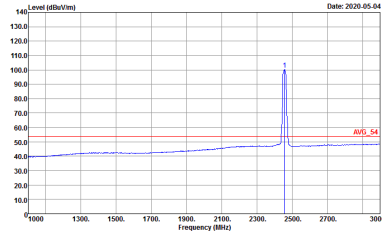

WIFI	2.4GHz 2400~2483.5MHz Band Edge @ 3m	
ANT	802.11g CH11 2462MHz	
1	Horizontal	Fundamental
Peak	 <p>Site : 03CH15-HY            Condition : PEAK_BE_74 3m 91200_15_1620 VERTICAL            Detector : Peak            Project : 042038</p>	 <p>Site : 03CH15-HY            Condition : PEAK_74 3m 91200_15_1620 VERTICAL            Detector : Peak            Project : 042038</p>
Avg.	 <p>Site : 03CH15-HY            Condition : AVG_BE_54 3m 91200_15_1620 VERTICAL            Detector : Peak            Project : 042038</p>	 <p>Site : 03CH15-HY            Condition : AVG_54 3m 91200_15_1620 VERTICAL            Detector : Peak            Project : 042038</p>

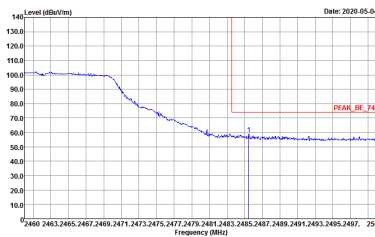
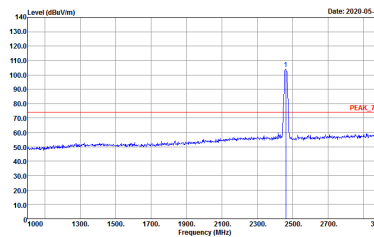
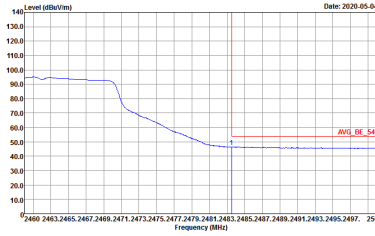
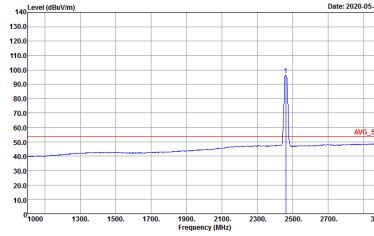

WIFI	2.4GHz 2400~2483.5MHz Band Edge @ 3m	
ANT	802.11g CH11 2462MHz	
1	Vertical	Fundamental
Peak	 <p>Site : 03CH15-HY            Condition : PEAK_BE_74 3m 91200_15_1620 VERTICAL            RBW:1000.000KHz VBW:3000.000KHz SWT:Auto            Detector : Peak            Project : 042038</p>	 <p>Site : 03CH15-HY            Condition : PEAK_74 3m 91200_15_1620 VERTICAL            RBW:1000.000KHz VBW:3000.000KHz SWT:Auto            Detector : Peak            Project : 042038</p>
Avg.	 <p>Site : 03CH15-HY            Condition : AVG_BE_54 3m 91200_15_1620 VERTICAL            RBW:1000.000KHz VBW:1000KHz SWT:Auto            Detector : Peak            Project : 042038</p>	 <p>Site : 03CH15-HY            Condition : AVG_54 3m 91200_15_1620 VERTICAL            RBW:1000.000KHz VBW:1000KHz SWT:Auto            Detector : Peak            Project : 042038</p>



**2.4GHz 2400~2483.5MHz**  
**WIFI 802.11n HT20 (Band Edge @ 3m)**

WIFI	2.4GHz 2400~2483.5MHz Band Edge @ 3m	
ANT	802.11n HT20 CH01 2412MHz	
1	Horizontal	Fundamental
<b>Peak</b>	<p>Site : 03CH15-HY            Condition : PEAK_BE_74 3m 91200_15_1620 HORIZONTAL            RBW:1000.000KHz VBW:3000.000KHz SWT:Auto            Detector : Peak            Project : 042038</p>	<p>Site : 03CH15-HY            Condition : PEAK_74 3m 91200_15_1620 HORIZONTAL            RBW:1000.000KHz VBW:3000.000KHz SWT:Auto            Detector : Peak            Project : 042038</p>
<b>Avg.</b>	<p>Site : 03CH15-HY            Condition : AVG_BE_54 3m 91200_15_1620 HORIZONTAL            RBW:1000.000KHz VBW:1.000KHz SWT:Auto            Detector : Peak            Project : 042038</p>	<p>Site : 03CH15-HY            Condition : AVG_54 3m 91200_15_1620 HORIZONTAL            RBW:1000.000KHz VBW:1.000KHz SWT:Auto            Detector : Peak            Project : 042038</p>

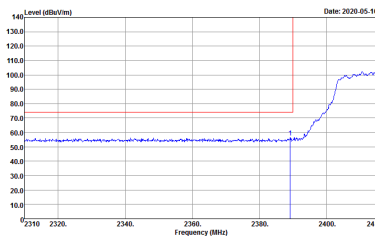
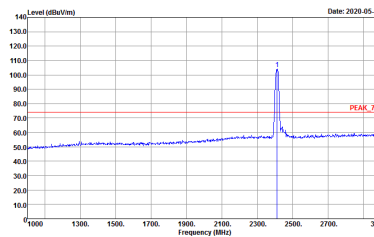
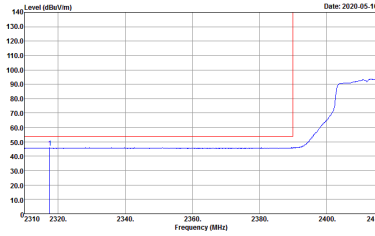
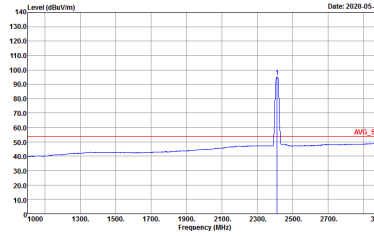

WIFI	2.4GHz 2400~2483.5MHz Band Edge @ 3m	
ANT	802.11n HT20 CH01 2412MHz	
1	Vertical	Fundamental
Peak	 <p>Date: 2020-05-10</p> <p>Site : 03CH15-HY            Condition : PEAK_BE_74 3m 91200_15_1620 VERTICAL            : RBW:1000.000KHz VBW:3000.000KHz SWT:Auto            Detector : Peak            Project : 042038</p>	 <p>Date: 2020-05-10</p> <p>Site : 03CH15-HY            Condition : PEAK_74 3m 91200_15_1620 VERTICAL            : RBW:1000.000KHz VBW:3000.000KHz SWT:Auto            Detector : Peak            Project : 042038</p>
Avg.	 <p>Date: 2020-05-10</p> <p>Site : 03CH15-HY            Condition : AVG_BE_54 3m 91200_15_1620 VERTICAL            : RBW:1000.000KHz VBW:1000KHz SWT:Auto            Detector : Peak            Project : 042038</p>	 <p>Date: 2020-05-10</p> <p>Site : 03CH15-HY            Condition : AVG_54 3m 91200_15_1620 VERTICAL            : RBW:1000.000KHz VBW:1000KHz SWT:Auto            Detector : Peak            Project : 042038</p>

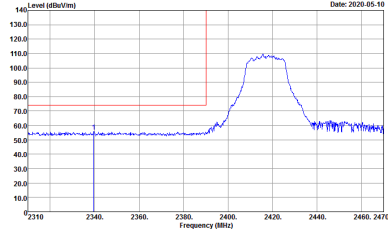
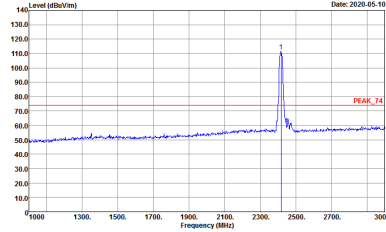
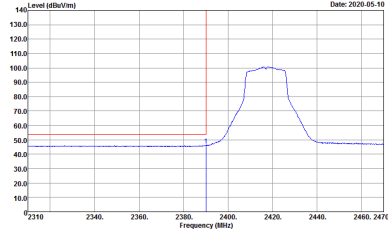
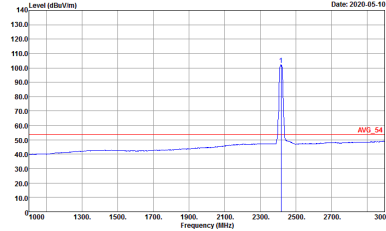

WIFI	2.4GHz 2400~2483.5MHz Band Edge @ 3m	
ANT	802.11n HT20 CH02 2417MHz	
1	Horizontal	Fundamental
Peak	 <p>Site : 03CH15-HY            Condition : PEAK_BE_74 3m 91200_15_1620 HORIZONTAL            Detector : Peak            Project : 042038</p>	 <p>Site : 03CH15-HY            Condition : PEAK_74 3m 91200_15_1620 HORIZONTAL            Detector : Peak            Project : 042038</p>
Avg.	 <p>Site : 03CH15-HY            Condition : AVG_BE_54 3m 91200_15_1620 HORIZONTAL            Detector : Peak            Project : 042038</p>	 <p>Site : 03CH15-HY            Condition : AVG_54 3m 91200_15_1620 HORIZONTAL            Detector : Peak            Project : 042038</p>

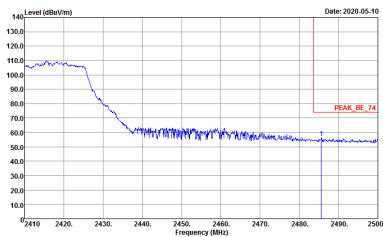
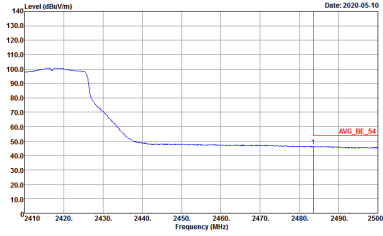

WIFI	2.4GHz 2400~2483.5MHz Band Edge @ 3m	
ANT	802.11n HT20 CH02 2417MHz - R	
1	Horizontal	Fundamental
Peak	 <p>Site : 03CH15-HY            Condition : PEAK_BE_74 3m 91200_15_1620 HORIZONTAL            RBW:1000.000KHz VBW:3000.000KHz SWF:Auto            Detector : Peak            Project : 042038</p>	Left blank
Avg.	 <p>Site : 03CH15-HY            Condition : AVG_BE_54 3m 91200_15_1620 HORIZONTAL            RBW:1000.000KHz VBW:1.000KHz SWF:Auto            Detector : Peak            Project : 042038</p>	Left blank



WIFI	2.4GHz 2400~2483.5MHz Band Edge @ 3m	
ANT	802.11n HT20 CH02 2417MHz	
1	Vertical	Fundamental
<b>Peak</b>	<p>Site : 03CH15-HY            Condition : PEAK_BE_74 3m 91200_15_1620 VERTICAL            Detector : Peak            Project : 042038</p>	<p>Site : 03CH15-HY            Condition : PEAK_74 3m 91200_15_1620 VERTICAL            Detector : Peak            Project : 042038</p>
<b>Avg.</b>	<p>Site : 03CH15-HY            Condition : AVG_BE_54 3m 91200_15_1620 VERTICAL            Detector : Peak            Project : 042038</p>	<p>Site : 03CH15-HY            Condition : AVG_54 3m 91200_15_1620 VERTICAL            Detector : Peak            Project : 042038</p>

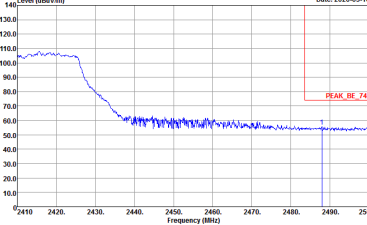
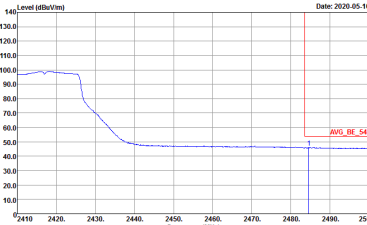

WIFI	2.4GHz 2400~2483.5MHz Band Edge @ 3m	
ANT	802.11n HT20 CH02 2417MHz - R	
1	Vertical	Fundamental
Peak	 <p>Site : 03CH15-HY            Condition : PEAK_BE_74 3m 91200_15_1620 VERTICAL            Detector : Peak            Project : 042038</p>	Left Blank
Avg.	 <p>Site : 03CH15-HY            Condition : AVG_BE_54 3m 91200_15_1620 VERTICAL            Detector : Peak            Project : 042038</p>	Left Blank

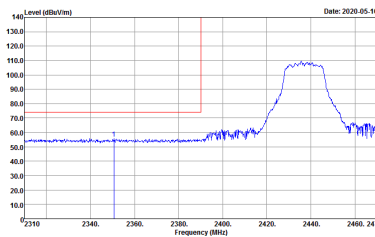
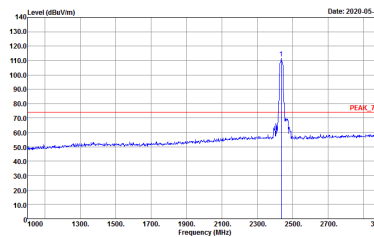
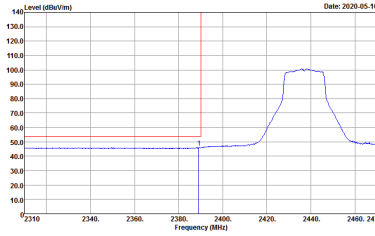
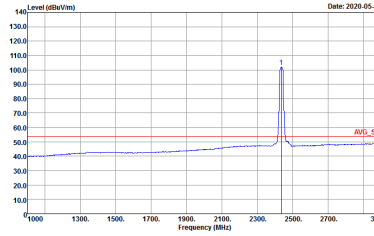

WIFI	2.4GHz 2400~2483.5MHz Band Edge @ 3m	
ANT	802.11n HT20 CH06 2437MHz - L	
1	Horizontal	Fundamental
Peak	 <p>Date: 2020-05-10</p> <p>Site : 03CH15-HY            Condition : PEAK_BE_74 3m 91200_15_1620 HORIZONTAL            : RBW:1000.000KHz VBW:3000.000KHz SWT:Auto            Detector : Peak            Project : 042038</p>	 <p>Date: 2020-05-10</p> <p>Site : 03CH15-HY            Condition : PEAK_74 3m 91200_15_1620 HORIZONTAL            : RBW:1000.000KHz VBW:3000.000KHz SWT:Auto            Detector : Peak            Project : 042038</p>
Avg.	 <p>Date: 2020-05-10</p> <p>Site : 03CH15-HY            Condition : AVG_BE_54 3m 91200_15_1620 HORIZONTAL            : RBW:1000.000KHz VBW:1000KHz SWT:Auto            Detector : Peak            Project : 042038</p>	 <p>Date: 2020-05-10</p> <p>Site : 03CH15-HY            Condition : AVG_54 3m 91200_15_1620 HORIZONTAL            : RBW:1000.000KHz VBW:1000KHz SWT:Auto            Detector : Peak            Project : 042038</p>

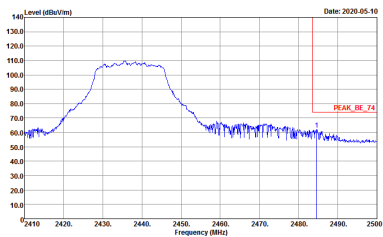
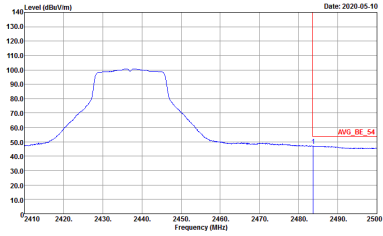

WIFI	2.4GHz 2400~2483.5MHz Band Edge @ 3m	
ANT	802.11n HT20 CH06 2437MHz - R	
1	Horizontal	Fundamental
Peak	 <p>           Site : 03CH15-HY            Condition : PEAK_BE_74 3m 91200_15_1620 HORIZONTAL            Detector : Peak            Project : 042038         </p>	Left blank
Avg.	 <p>           Site : 03CH15-HY            Condition : AVG_BE_54 3m 91200_15_1620 HORIZONTAL            Detector : Peak            Project : 042038         </p>	Left blank

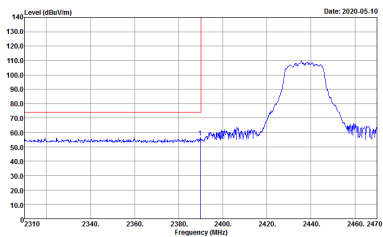
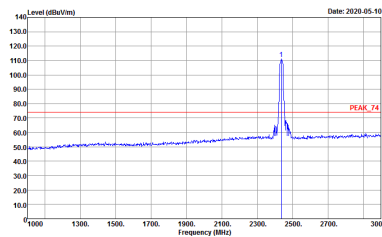
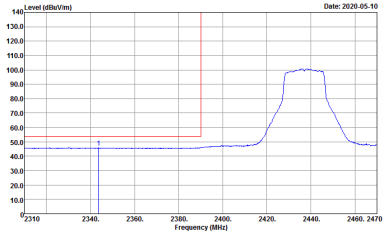
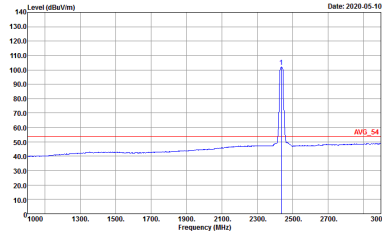

WIFI	2.4GHz 2400~2483.5MHz Band Edge @ 3m	
ANT	802.11n HT20 CH06 2437MHz - L	
1	Vertical	Fundamental
Peak	 <p>Site : 03CH15-HY            Condition : PEAK_BE_74 3m 91200_15_1620 VERTICAL            : RBW:1000.000KHz VBW:3000.000KHz SWT:Auto            Detector : Peak            Project : 042038</p>	 <p>Site : 03CH15-HY            Condition : PEAK_74 3m 91200_15_1620 VERTICAL            : RBW:1000.000KHz VBW:3000.000KHz SWT:Auto            Detector : Peak            Project : 042038</p>
Avg.	 <p>Site : 03CH15-HY            Condition : AVG_BE_54 3m 91200_15_1620 VERTICAL            : RBW:1000.000KHz VBW:1000KHz SWT:Auto            Detector : Peak            Project : 042038</p>	 <p>Site : 03CH15-HY            Condition : AVG_54 3m 91200_15_1620 VERTICAL            : RBW:1000.000KHz VBW:1000KHz SWT:Auto            Detector : Peak            Project : 042038</p>

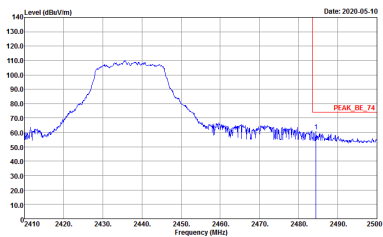
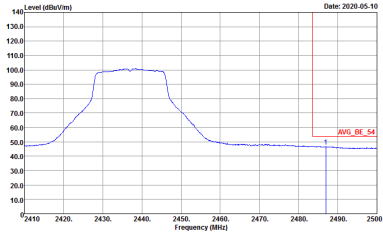

WIFI	2.4GHz 2400~2483.5MHz Band Edge @ 3m	
ANT	802.11n HT20 CH06 2437MHz - R	
1	Vertical	Fundamental
Peak	 <p>           Site : 03CH15-HY            Condition : PEAK_BE_74 3m 9120D_15_1620 VERTICAL            Detector : Peak            Project : 042038         </p>	Left Blank
Avg.	 <p>           Site : 03CH15-HY            Condition : AVG_BE_54 3m 9120D_15_1620 VERTICAL            Detector : Peak            Project : 042038         </p>	Left Blank

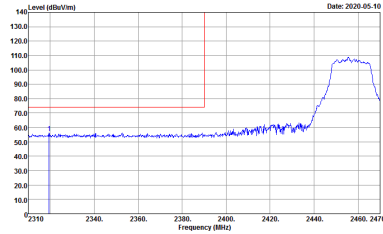
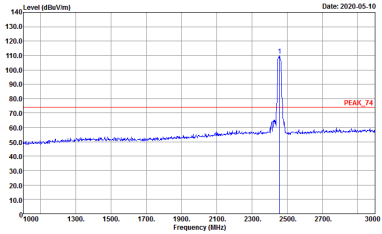
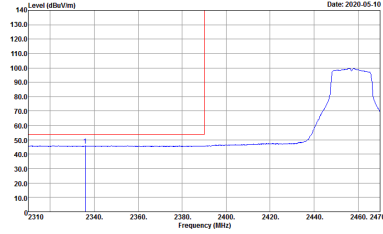
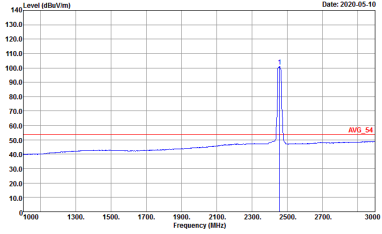

WIFI	2.4GHz 2400~2483.5MHz Band Edge @ 3m	
ANT	802.11n HT20 CH010 2457MHz - L	
1	Horizontal	Fundamental
<b>Peak</b>	 <p>Site : 03CH15-HY            Condition : PEAK_BE_74 3m 91200_15_1620 HORIZONTAL            Detector : Peak            Project : 042038</p>	 <p>Site : 03CH15-HY            Condition : PEAK_74 3m 91200_15_1620 HORIZONTAL            Detector : Peak            Project : 042038</p>
<b>Avg.</b>	 <p>Site : 03CH15-HY            Condition : AVG_BE_54 3m 91200_15_1620 HORIZONTAL            Detector : Peak            Project : 042038</p>	 <p>Site : 03CH15-HY            Condition : AVG_54 3m 91200_15_1620 HORIZONTAL            Detector : Peak            Project : 042038</p>

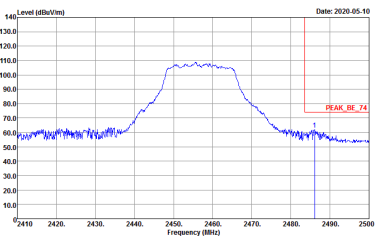
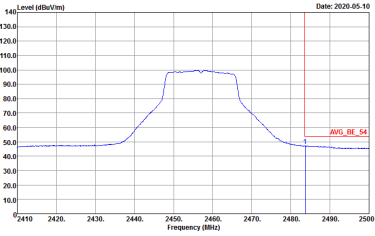

WIFI	2.4GHz 2400~2483.5MHz Band Edge @ 3m	
ANT	802.11n HT20 CH10 2457MHz - R	
1	Horizontal	Fundamental
<p><b>Peak</b></p>	 <p>           Site : 03CH15-HY            Condition : PEAK_BE_74 3m 91200_15_1620 HORIZONTAL            Detector : Peak            Project : 042038         </p>	<p>Left blank</p>
<p><b>Avg.</b></p>	 <p>           Site : 03CH15-HY            Condition : AVG_BE_54 3m 91200_15_1620 HORIZONTAL            Detector : Peak            Project : 042038         </p>	<p>Left blank</p>



WIFI	2.4GHz 2400~2483.5MHz Band Edge @ 3m	
ANT	802.11n HT20 CH10 2457MHz - L	
1	Vertical	Fundamental
<b>Peak</b>	<p>Site : 03CH15-HY            Condition : PEAK_BE_74 3m 91200_15_1620 VERTICAL            Detector : Peak            Project : 042038</p>	<p>Site : 03CH15-HY            Condition : PEAK_74 3m 91200_15_1620 VERTICAL            Detector : Peak            Project : 042038</p>
<b>Avg.</b>	<p>Site : 03CH15-HY            Condition : AVG_BE_54 3m 91200_15_1620 VERTICAL            Detector : Peak            Project : 042038</p>	<p>Site : 03CH15-HY            Condition : AVG_54 3m 91200_15_1620 VERTICAL            Detector : Peak            Project : 042038</p>

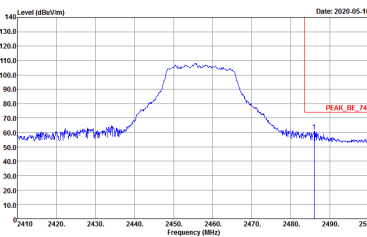
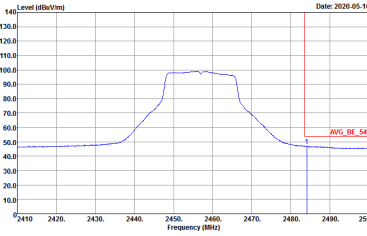

WIFI	2.4GHz 2400~2483.5MHz Band Edge @ 3m	
ANT	802.11n HT20 CH10 2457MHz - R	
1	Vertical	Fundamental
<p><b>Peak</b></p>	 <p>Site : 03CH15-HY            Condition : PEAK_BE_74 3m 91200_15_1620 VERTICAL            Detector : Peak            Project : 042038</p>	<p>Left Blank</p>
<p><b>Avg.</b></p>	 <p>Site : 03CH15-HY            Condition : AVG_BE_54 3m 91200_15_1620 VERTICAL            Detector : Peak            Project : 042038</p>	<p>Left Blank</p>

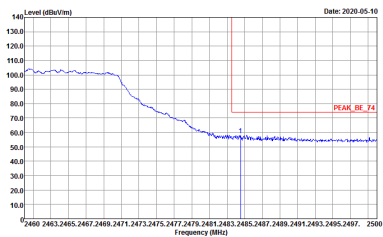
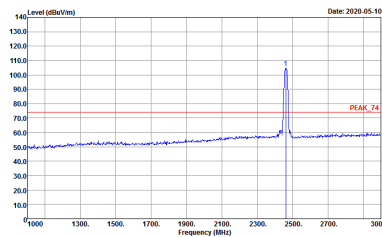
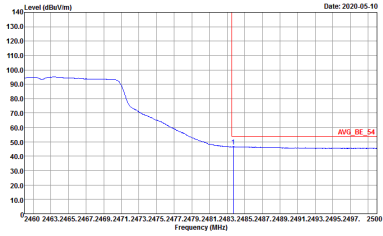
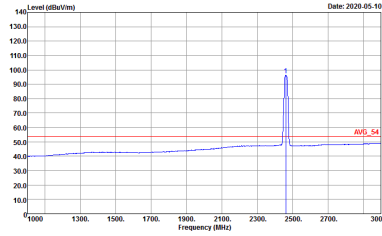

WIFI	2.4GHz 2400~2483.5MHz Band Edge @ 3m	
ANT	802.11n HT20 CH11 2462MHz	
1	Horizontal	Fundamental
Peak	 <p>Site : 03CH15-HY            Condition : PEAK_BE_74 3m 91200_15_1620 HORIZONTAL            : RBW:1000.000KHz VBW:3000.000KHz SWT:Auto            Detector : Peak            Project : 042038</p>	 <p>Site : 03CH15-HY            Condition : PEAK_74 3m 91200_15_1620 HORIZONTAL            : RBW:1000.000KHz VBW:3000.000KHz SWT:Auto            Detector : Peak            Project : 042038</p>
Avg.	 <p>Site : 03CH15-HY            Condition : AVG_BE_54 3m 91200_15_1620 HORIZONTAL            : RBW:1000.000KHz VBW:1000KHz SWT:Auto            Detector : Peak            Project : 042038</p>	 <p>Site : 03CH15-HY            Condition : AVG_54 3m 91200_15_1620 HORIZONTAL            : RBW:1000.000KHz VBW:1000KHz SWT:Auto            Detector : Peak            Project : 042038</p>

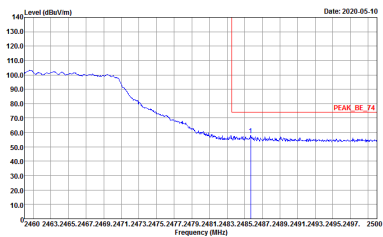
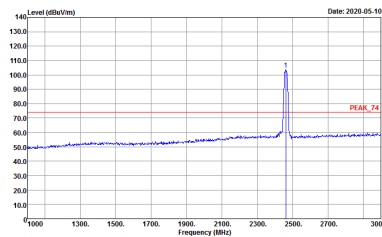
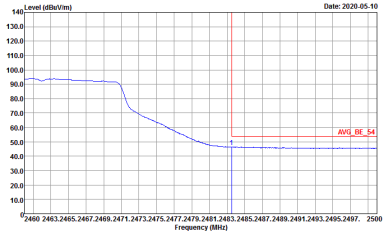
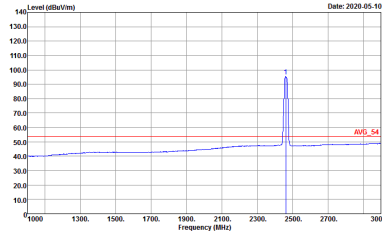

WIFI	2.4GHz 2400~2483.5MHz Fundamental @ 3m	
ANT	802.11n HT20 CH11 2462MHz	
1	Vertical	Fundamental
Peak	 <p>Site : 03CH15-HY            Condition : PEAK_BE_74 3m 91200_15_1620 VERTICAL            RBW:1000.000KHz VBW:3000.000KHz SWT:Auto            Detector : Peak            Project : 042038</p>	 <p>Site : 03CH15-HY            Condition : PEAK_74 3m 91200_15_1620 VERTICAL            RBW:1000.000KHz VBW:3000.000KHz SWT:Auto            Detector : Peak            Project : 042038</p>
Avg.	 <p>Site : 03CH15-HY            Condition : AVG_BE_54 3m 91200_15_1620 VERTICAL            RBW:1000.000KHz VBW:1000KHz SWT:Auto            Detector : Peak            Project : 042038</p>	 <p>Site : 03CH15-HY            Condition : AVG_54 3m 91200_15_1620 VERTICAL            RBW:1000.000KHz VBW:1000KHz SWT:Auto            Detector : Peak            Project : 042038</p>



**2.4GHz 2400~2483.5MHz**  
**WIFI 802.11b (Harmonic @ 3m)**

<b>WIFI</b>	<b>2.4GHz 2400~2483.5MHz Harmonic @ 3m</b>	
<b>ANT</b>	<b>802.11b CH01 2412MHz</b>	
<b>1</b>	<b>Horizontal</b>	<b>Vertical</b>
<b>Peak</b> <b>Avg.</b>	<p>Site : 03CH15-11Y          Condition : PEAK_74 3m 91200_15_1620 HORIZONTAL          Detector : Peak          Project : 042038</p>	<p>Site : 03CH15-11Y          Condition : PEAK_74 3m 91200_15_1620 VERTICAL          Detector : Peak          Project : 042038</p>



WIFI	2.4GHz 2400~2483.5MHz Harmonic @ 3m	
ANT	802.11b CH06 2437MHz	
1	Horizontal	Vertical
Peak Avg.	<p>Site : 03CH15-11Y Condition : PEAK_74 3m 91200_15_1620 HORIZONTAL Detector : Peak Project : 042038</p>	<p>Site : 03CH15-11Y Condition : PEAK_74 3m 91200_15_1620 VERTICAL Detector : Peak Project : 042038</p>



WIFI	2.4GHz 2400~2483.5MHz Harmonic @ 3m	
ANT	802.11b CH11 2462MHz	
1	Horizontal	Vertical
Peak Avg.	<p>Site : 03CH15-11Y Condition : PEAK_74 3m 91200_15_1620 HORIZONTAL Detector : Peak Project : 042038</p>	<p>Site : 03CH15-11Y Condition : PEAK_74 3m 91200_15_1620 VERTICAL Detector : Peak Project : 042038</p>



**2.4GHz 2400~2483.5MHz**  
**WIFI 802.11g (Harmonic @ 3m)**

WIFI	2.4GHz 2400~2483.5MHz Harmonic @ 3m	
ANT	802.11g CH01 2412MHz	
1	Horizontal	Vertical
<b>Peak</b>  <b>Avg.</b>	<p>Site : 03CH15-HY            Condition : PEAK_74 3m 91200_15_1620 HORIZONTAL            Detector : Peak            Project : 042038</p>	<p>Site : 03CH15-HY            Condition : PEAK_74 3m 91200_15_1620 VERTICAL            Detector : Peak            Project : 042038</p>



WIFI	2.4GHz 2400~2483.5MHz Harmonic @ 3m	
ANT	802.11g CH02 2417MHz	
1	Horizontal	Vertical
<p>Peak</p> <p>Avg.</p>	<p>Site : 03CH15-11Y          Condition : PEAK_74 3m 91200_15_1620 HORIZONTAL          Detector : Peak          Project : 042038</p>	<p>Site : 03CH15-11Y          Condition : PEAK_74 3m 91200_15_1620 VERTICAL          Detector : Peak          Project : 042038</p>



WIFI	2.4GHz 2400~2483.5MHz Harmonic @ 3m	
ANT	802.11g CH06 2437MHz	
1	Horizontal	Vertical
<p>Peak</p> <p>Avg.</p>	<p>Site : 03CH15-11Y Condition : PEAK_74 3m 91200_15_1620 HORIZONTAL Detector : Peak Project : 042038</p>	<p>Site : 03CH15-11Y Condition : PEAK_74 3m 91200_15_1620 VERTICAL Detector : Peak Project : 042038</p>



WIFI	2.4GHz 2400~2483.5MHz Harmonic @ 3m	
ANT	802.11g CH10 2457MHz	
1	Horizontal	Vertical
Peak Avg.	<p>Site : 03CH15-11Y Condition : PEAK_74 3m 91200_15_1620 HORIZONTAL Detector : Peak Project : 042038</p>	<p>Site : 03CH15-11Y Condition : PEAK_74 3m 91200_15_1620 VERTICAL Detector : Peak Project : 042038</p>



WIFI	2.4GHz 2400~2483.5MHz Harmonic @ 3m	
ANT	802.11g CH11 2462MHz	
1	Horizontal	Vertical
<p>Peak</p> <p>Avg.</p>	<p>Site : 03CH15-11Y          Condition : PEAK_74 3m 91200_15_1620 HORIZONTAL          Detector : Peak          Project : 042038</p>	<p>Site : 03CH15-11Y          Condition : PEAK_74 3m 91200_15_1620 VERTICAL          Detector : Peak          Project : 042038</p>



2.4GHz 2400~2483.5MHz
WIFI 802.11n HT20 (Harmonic @ 3m)

Table with 2 columns: Horizontal and Vertical. Each column contains a graph of Level (dBuV/m) vs Frequency (MHz) and associated test parameters like Site, Condition, Detector, and Project.



WIFI	2.4GHz 2400~2483.5MHz Harmonic @ 3m	
ANT	802.11n HT20 CH02 2417MHz	
1	Horizontal	Vertical
<b>Peak</b> <b>Avg.</b>	<p>Site : 03CH15-11Y Condition : PEAK_74 3m 9120D_15_1620 HORIZONTAL Detector : Peak Project : 042038</p>	<p>Site : 03CH15-11Y Condition : PEAK_74 3m 9120D_15_1620 VERTICAL Detector : Peak Project : 042038</p>



WIFI	2.4GHz 2400~2483.5MHz Harmonic @ 3m	
ANT	802.11n HT20 CH06 2437MHz	
1	Horizontal	Vertical
Peak Avg.	<p>Site : 03CH15-11Y Condition : PEAK_74 3m 91200_15_1620 HORIZONTAL Detector : Peak Project : 042038</p>	<p>Site : 03CH15-11Y Condition : PEAK_74 3m 91200_15_1620 VERTICAL Detector : Peak Project : 042038</p>



WIFI	2.4GHz 2400~2483.5MHz Harmonic @ 3m	
ANT	802.11n HT20 CH10 2457MHz	
1	Horizontal	Vertical
Peak Avg.	<p>Site : 03CH15-11Y Condition : PEAK_74 3m 9120D_15_1620 HORIZONTAL Detector : Peak Project : 042038</p>	<p>Site : 03CH15-11Y Condition : PEAK_74 3m 9120D_15_1620 VERTICAL Detector : Peak Project : 042038</p>

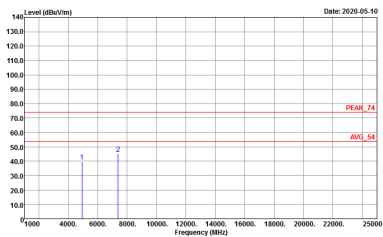
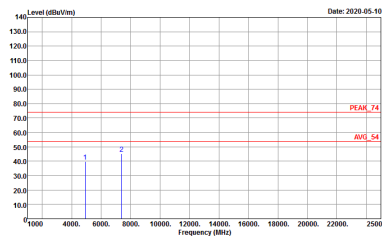

WIFI	2.4GHz 2400~2483.5MHz Harmonic @ 3m	
ANT	802.11n HT20 CH11 2462MHz	
1	Horizontal	Vertical
<p>Peak</p> <p>Avg.</p>	 <p>Site : 03CH15-11Y          Condition : PEAK_74 3m 91200_15_1620 HORIZONTAL          Detector : Peak          Project : 042038</p>	 <p>Site : 03CH15-11Y          Condition : PEAK_74 3m 91200_15_1620 VERTICAL          Detector : Peak          Project : 042038</p>



Emission below 1GHz  
2.4GHz WIFI 802.11b (LF)

WIFI	2.4GHz 2400~2483.5MHz	
ANT	802.11b LF	
1	Horizontal	Vertical
QP / Peak	<p>Site : 03CH15-HY Condition : QP 3m BTL06_15_41912 HORIZONTAL Detector : Peak Project : 042038</p>	<p>Site : 03CH15-HY Condition : QP 3m BTL06_15_41912 VERTICAL Detector : Peak Project : 042038</p>



Emission below 1GHz  
2.4GHz WIFI 802.11g (LF)

WIFI	2.4GHz 2400~2483.5MHz	
ANT	802.11g LF	
1	Horizontal	Vertical
QP / Peak	<p>Site : 03CH15-HY Condition : QP 3m BTL06_15_41912 HORIZONTAL Detector : Peak Project : 042038</p>	<p>Site : 03CH15-HY Condition : QP 3m BTL06_15_41912 VERTICAL Detector : Peak Project : 042038</p>



### Appendix E. Duty Cycle Plots

Band	Duty Cycle(%)	T(us)	1/T(kHz)	VBW Setting	Duty Factor(dB)
802.11b	98.97	-	-	10Hz	0.04
802.11g	94.75	2075	0.48	1kHz	0.23
2.4GHz 802.11n HT20	94.13	1925	0.52	1kHz	0.26

#### 802.11b

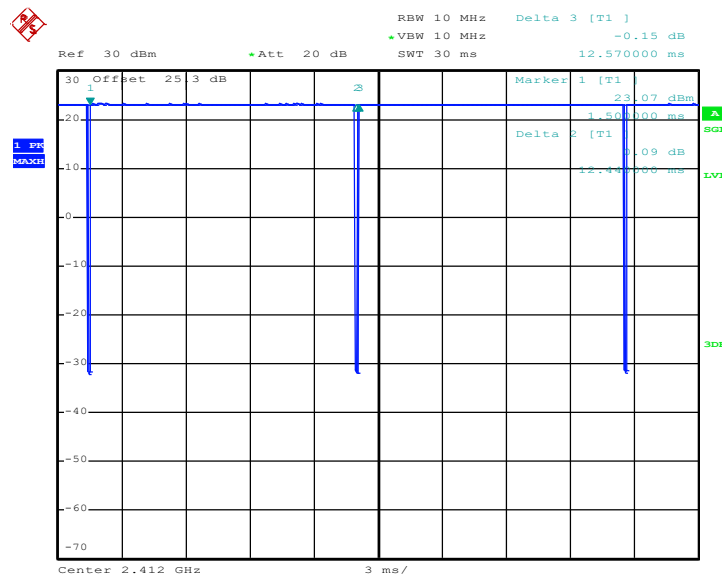

Date: 24.APR.2020 11:10:32



### 802.11g

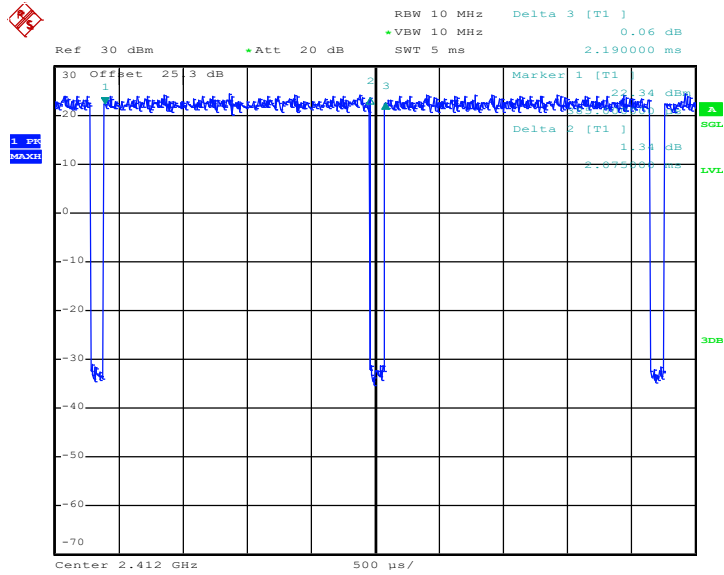

Date: 24.APR.2020 11:12:51

### 802.11n HT20

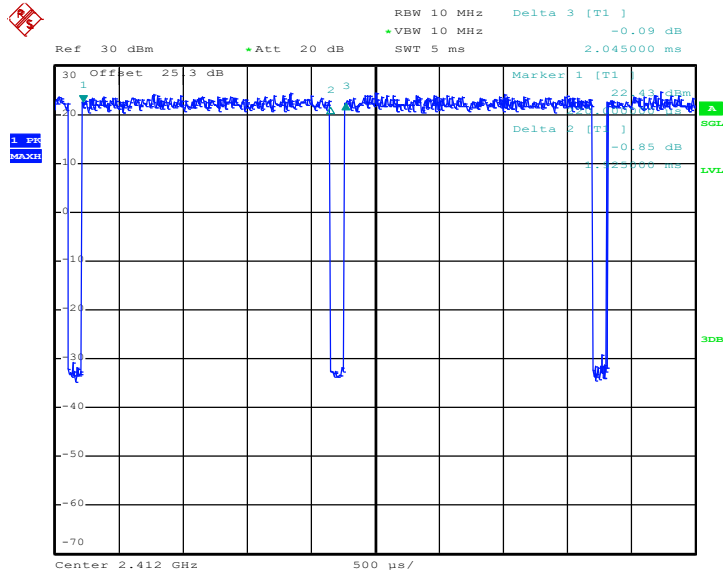

Date: 24.APR.2020 11:13:57