

15.3 Calibration Certificate for E-Field Probe EX3DV4 - SN 3922

**Calibration Laboratory of
Schmid & Partner
Engineering AG**
Zeughausstrasse 43, 8004 Zurich, Switzerland



S Schweizerischer Kalibrierdienst
C Service suisse d'étalonnage
S Servizio svizzero di taratura
S Swiss Calibration Service

Accredited by the Swiss Accreditation Service (SAS)
The Swiss Accreditation Service is one of the signatories to the EA
Multilateral Agreement for the recognition of calibration certificates

Accreditation No.: **SCS 0108**

Client **UL Japan (Vitec)**

Certificate No: **EX3-3922_Nov17**

CALIBRATION CERTIFICATE

Object: **EX3DV4 - SN:3922**

Calibration procedure(s): **QA CAL-01.v9, QA CAL-14.v4, QA CAL-23.v5, QA CAL-25.v6
Calibration procedure for dosimetric E-field probes**

Calibration date: **November 15, 2017**

This calibration certificate documents the traceability to national standards, which realize the physical units of measurements (SI).
The measurements and the uncertainties with confidence probability are given on the following pages and are part of the certificate.

All calibrations have been conducted in the closed laboratory facility; environment temperature (22 ± 3)°C and humidity < 70%.

Calibration Equipment used (M&TE critical for calibration)

Primary Standards	ID	Cal Date (Certificate No.)	Scheduled Calibration
Power meter NRP	SN: 104778	04-Apr-17 (No. 217-02521/02522)	Apr-18
Power sensor NRP-Z91	SN: 103244	04-Apr-17 (No. 217-02521)	Apr-18
Power sensor NRP-Z91	SN: 103245	04-Apr-17 (No. 217-02525)	Apr-18
Reference 20 dB Attenuator	SN: S5277 (20x)	07-Apr-17 (No. 217-02528)	Apr-18
Reference Probe ES3DV2	SN: 3013	31-Dec-16 (No. ES3-3013_Dec16)	Dec-17
DAE4	SN: 660	7-Dec-16 (No. DAE4-660_Dec16)	Dec-17
Secondary Standards	ID	Check Date (in house)	Scheduled Check
Power meter E4419B	SN: GB41293874	06-Apr-16 (in house check Jun-16)	In house check: Jun-18
Power sensor E4412A	SN: MY41498087	06-Apr-16 (in house check Jun-16)	In house check: Jun-18
Power sensor E4412A	SN: 000110210	06-Apr-16 (in house check Jun-16)	In house check: Jun-18
RF generator HP 8648C	SN: US3642U01700	04-Aug-99 (in house check Jun-16)	In house check: Jun-18
Network Analyzer HP 8753E	SN: US37390585	18-Oct-01 (in house check Oct-17)	In house check: Oct-18

	Name	Function	Signature
Calibrated by:	Jeton Kastrati	Laboratory Technician	
Approved by:	Katja Pokovic	Technical Manager	

Issued: November 15, 2017

This calibration certificate shall not be reproduced except in full without written approval of the laboratory.



Accredited by the Swiss Accreditation Service (SAS)
The Swiss Accreditation Service is one of the signatories to the EA
Multilateral Agreement for the recognition of calibration certificates

Accreditation No.: SCS 0108

Glossary:

TSL	tissue simulating liquid
NORM _{x,y,z}	sensitivity in free space
ConvF	sensitivity in TSL / NORM _{x,y,z}
DCP	diode compression point
CF	crest factor (1/duty_cycle) of the RF signal
A, B, C, D	modulation dependent linearization parameters
Polarization ϕ	ϕ rotation around probe axis
Polarization ϑ	ϑ rotation around an axis that is in the plane normal to probe axis (at measurement center), i.e., $\vartheta = 0$ is normal to probe axis
Connector Angle	information used in DASY system to align probe sensor X to the robot coordinate system

Calibration is Performed According to the Following Standards:

- a) IEEE Std 1528-2013, "IEEE Recommended Practice for Determining the Peak Spatial-Averaged Specific Absorption Rate (SAR) in the Human Head from Wireless Communications Devices: Measurement Techniques", June 2013
- b) IEC 62209-1, "Measurement procedure for the assessment of Specific Absorption Rate (SAR) from hand-held and body-mounted devices used next to the ear (frequency range of 300 MHz to 6 GHz)", July 2016
- c) IEC 62209-2, "Procedure to determine the Specific Absorption Rate (SAR) for wireless communication devices used in close proximity to the human body (frequency range of 30 MHz to 6 GHz)", March 2010
- d) KDB 865664, "SAR Measurement Requirements for 100 MHz to 6 GHz"

Methods Applied and Interpretation of Parameters:

- *NORM_{x,y,z}*: Assessed for E-field polarization $\vartheta = 0$ ($f \leq 900$ MHz in TEM-cell; $f > 1800$ MHz: R22 waveguide). *NORM_{x,y,z}* are only intermediate values, i.e., the uncertainties of *NORM_{x,y,z}* does not affect the E^2 -field uncertainty inside TSL (see below *ConvF*).
- *NORM(f)_{x,y,z}* = *NORM_{x,y,z}* * *frequency_response* (see Frequency Response Chart). This linearization is implemented in DASY4 software versions later than 4.2. The uncertainty of the frequency response is included in the stated uncertainty of *ConvF*.
- *DCP_{x,y,z}*: DCP are numerical linearization parameters assessed based on the data of power sweep with CW signal (no uncertainty required). DCP does not depend on frequency nor media.
- *PAR*: PAR is the Peak to Average Ratio that is not calibrated but determined based on the signal characteristics
- *A_{x,y,z}; B_{x,y,z}; C_{x,y,z}; D_{x,y,z}; VR_{x,y,z}*: *A, B, C, D* are numerical linearization parameters assessed based on the data of power sweep for specific modulation signal. The parameters do not depend on frequency nor media. *VR* is the maximum calibration range expressed in RMS voltage across the diode.
- *ConvF and Boundary Effect Parameters*: Assessed in flat phantom using E-field (or Temperature Transfer Standard for $f \leq 800$ MHz) and inside waveguide using analytical field distributions based on power measurements for $f > 800$ MHz. The same setups are used for assessment of the parameters applied for boundary compensation (alpha, depth) of which typical uncertainty values are given. These parameters are used in DASY4 software to improve probe accuracy close to the boundary. The sensitivity in TSL corresponds to *NORM_{x,y,z}* * *ConvF* whereby the uncertainty corresponds to that given for *ConvF*. A frequency dependent *ConvF* is used in DASY version 4.4 and higher which allows extending the validity from ± 50 MHz to ± 100 MHz.
- *Spherical isotropy (3D deviation from isotropy)*: in a field of low gradients realized using a flat phantom exposed by a patch antenna.
- *Sensor Offset*: The sensor offset corresponds to the offset of virtual measurement center from the probe tip (on probe axis). No tolerance required.
- *Connector Angle*: The angle is assessed using the information gained by determining the *NORM_x* (no uncertainty required).

Probe EX3DV4

SN:3922

Manufactured: March 8, 2013
Calibrated: November 15, 2017

Calibrated for DASY/EASY Systems
(Note: non-compatible with DASY2 system!)

DASY/EASY - Parameters of Probe: EX3DV4 - SN:3922

Basic Calibration Parameters

	Sensor X	Sensor Y	Sensor Z	Unc (k=2)
Norm ($\mu\text{V}/(\text{V}/\text{m})^2$) ^A	0.64	0.56	0.59	$\pm 10.1\%$
DCP (mV) ^B	97.5	100.2	99.5	

Modulation Calibration Parameters

UID	Communication System Name		A dB	B dB $\sqrt{\mu\text{V}}$	C	D dB	VR mV	Unc ^E (k=2)
0	CW	X	0.0	0.0	1.0	0.00	138.9	$\pm 3.3\%$
		Y	0.0	0.0	1.0		156.7	
		Z	0.0	0.0	1.0		150.2	

Note: For details on UID parameters see Appendix.

Sensor Model Parameters

	C1 fF	C2 fF	α V^{-1}	T1 $\text{ms}\cdot\text{V}^{-2}$	T2 $\text{ms}\cdot\text{V}^{-1}$	T3 ms	T4 V^{-2}	T5 V^{-1}	T6
X	52.39	393.1	35.88	23.89	0.589	5.1	0.252	0.526	1.011
Y	35.86	267.6	35.63	13.74	0.000	5.1	0.550	0.302	1.008
Z	51.43	386.8	35.82	22.06	0.49	5.1	0.521	0.493	1.011

The reported uncertainty of measurement is stated as the standard uncertainty of measurement multiplied by the coverage factor $k=2$, which for a normal distribution corresponds to a coverage probability of approximately 95%.

^A The uncertainties of Norm X,Y,Z do not affect the E^2 -field uncertainty inside TSL (see Pages 5 and 6).

^B Numerical linearization parameter: uncertainty not required.

^E Uncertainty is determined using the max. deviation from linear response applying rectangular distribution and is expressed for the square of the field value.

DASY/EASY - Parameters of Probe: EX3DV4 - SN:3922

Calibration Parameter Determined in Head Tissue Simulating Media

f (MHz) ^c	Relative Permittivity ^F	Conductivity (S/m) ^F	ConvF X	ConvF Y	ConvF Z	Alpha ^G	Depth (mm) ^G	Unc (k=2)
2300	39.5	1.67	7.97	7.97	7.97	0.32	0.86	± 12.0 %
2450	39.2	1.80	7.49	7.49	7.49	0.44	0.83	± 12.0 %
5200	36.0	4.86	5.61	5.61	5.61	0.35	1.80	± 13.1 %
5250	35.9	4.71	5.57	5.57	5.57	0.35	1.80	± 13.1 %
5300	35.9	4.76	5.46	5.46	5.46	0.35	1.80	± 13.1 %
5500	35.6	4.96	5.05	5.05	5.05	0.40	1.80	± 13.1 %
5600	35.5	5.07	4.85	4.85	4.85	0.40	1.80	± 13.1 %
5750	35.4	5.22	5.15	5.15	5.15	0.40	1.80	± 13.1 %
5800	35.3	5.27	5.10	5.10	5.10	0.40	1.80	± 13.1 %

^c Frequency validity above 300 MHz of ± 100 MHz only applies for DASY v4.4 and higher (see Page 2), else it is restricted to ± 50 MHz. The uncertainty is the RSS of the ConvF uncertainty at calibration frequency and the uncertainty for the indicated frequency band. Frequency validity below 300 MHz is ± 10, 25, 40, 50 and 70 MHz for ConvF assessments at 30, 64, 128, 150 and 220 MHz respectively. Above 5 GHz frequency validity can be extended to ± 110 MHz.

^F At frequencies below 3 GHz, the validity of tissue parameters (ϵ and σ) can be relaxed to ± 10% if liquid compensation formula is applied to measured SAR values. At frequencies above 3 GHz, the validity of tissue parameters (ϵ and σ) is restricted to ± 5%. The uncertainty is the RSS of the ConvF uncertainty for indicated target tissue parameters.

^G Alpha/Depth are determined during calibration. SPEAG warrants that the remaining deviation due to the boundary effect after compensation is always less than ± 1% for frequencies below 3 GHz and below ± 2% for frequencies between 3-6 GHz at any distance larger than half the probe tip diameter from the boundary.

DASY/EASY - Parameters of Probe: EX3DV4 - SN:3922

Calibration Parameter Determined in Body Tissue Simulating Media

f (MHz) ^c	Relative Permittivity ^F	Conductivity (S/m) ^F	ConvF X	ConvF Y	ConvF Z	Alpha ^G	Depth ^G (mm)	Unc (k=2)
835	55.2	0.97	10.27	10.27	10.27	0.50	0.84	± 12.0 %
1900	53.3	1.52	8.07	8.07	8.07	0.43	0.82	± 12.0 %
2300	52.9	1.81	7.92	7.92	7.92	0.36	0.83	± 12.0 %
2450	52.7	1.95	7.68	7.68	7.68	0.33	0.86	± 12.0 %
5250	48.9	5.36	5.05	5.05	5.05	0.35	1.90	± 13.1 %
5600	48.5	5.77	4.29	4.29	4.29	0.45	1.90	± 13.1 %
5750	48.3	5.94	4.46	4.46	4.46	0.45	1.90	± 13.1 %

^c Frequency validity above 300 MHz of ± 100 MHz only applies for DASY v4.4 and higher (see Page 2), else it is restricted to ± 50 MHz. The uncertainty is the RSS of the ConvF uncertainty at calibration frequency and the uncertainty for the indicated frequency band. Frequency validity below 300 MHz is ± 10, 25, 40, 50 and 70 MHz for ConvF assessments at 30, 64, 128, 150 and 220 MHz respectively. Above 5 GHz frequency validity can be extended to ± 110 MHz.

^F At frequencies below 3 GHz, the validity of tissue parameters (ϵ and σ) can be relaxed to ± 10% if liquid compensation formula is applied to measured SAR values. At frequencies above 3 GHz, the validity of tissue parameters (ϵ and σ) is restricted to ± 5%. The uncertainty is the RSS of the ConvF uncertainty for indicated target tissue parameters.

^G Alpha/Depth are determined during calibration. SPEAG warrants that the remaining deviation due to the boundary effect after compensation is always less than ± 1% for frequencies below 3 GHz and below ± 2% for frequencies between 3-6 GHz at any distance larger than half the probe tip diameter from the boundary.

Frequency Response of E-Field (TEM-Cell: ifi110 EXX, Waveguide: R22)

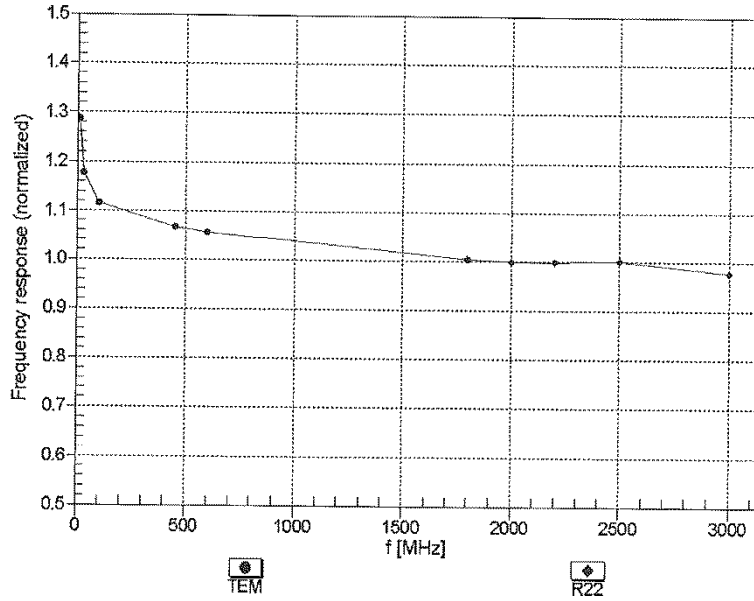

Uncertainty of Frequency Response of E-field: $\pm 6.3\%$ ($k=2$)

Receiving Pattern (ϕ), $\theta = 0^\circ$

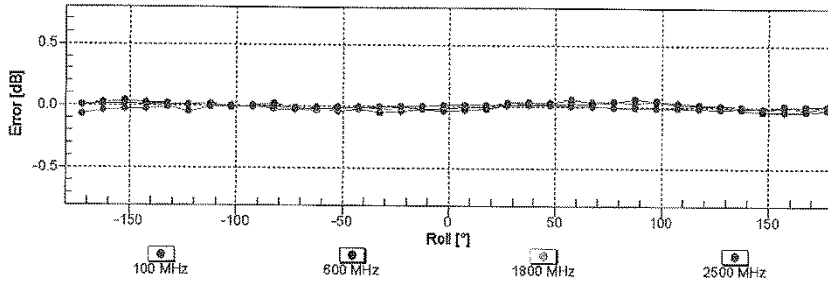
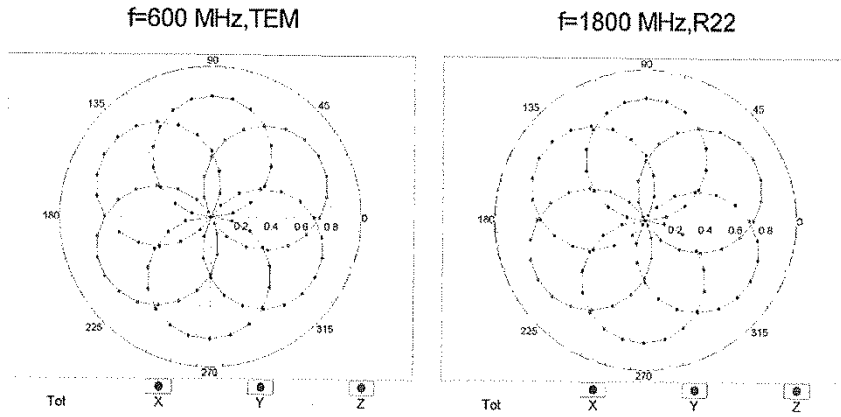

Uncertainty of Axial Isotropy Assessment: $\pm 0.5\%$ ($k=2$)

Dynamic Range $f(SAR_{head})$ (TEM cell, $f_{eval} = 1900$ MHz)

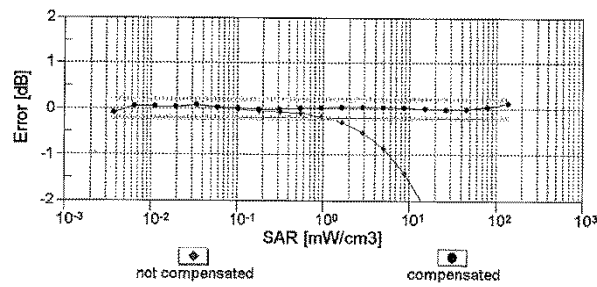
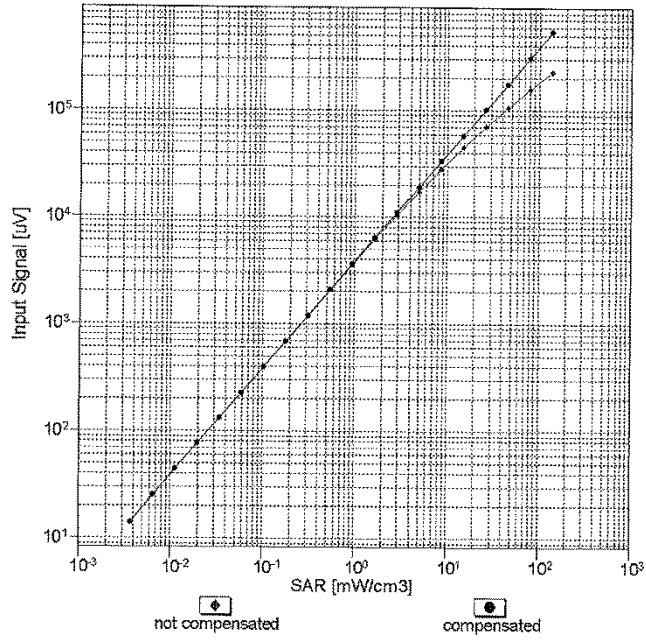

Uncertainty of Linearity Assessment: $\pm 0.6\%$ (k=2)

Conversion Factor Assessment

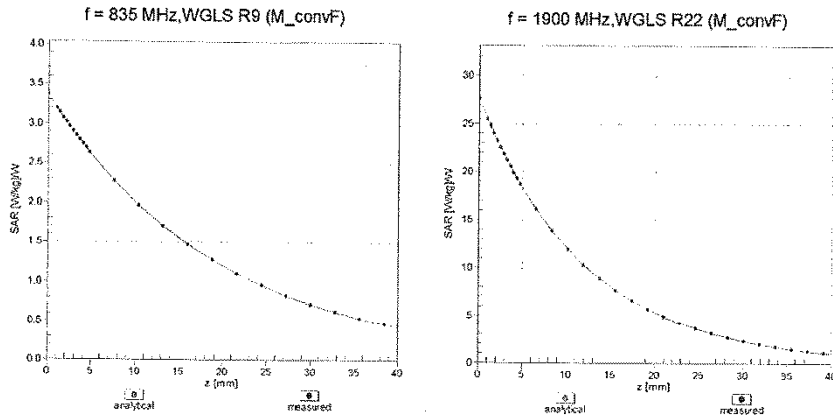

Deviation from Isotropy in Liquid Error (ϕ, θ), f = 900 MHz

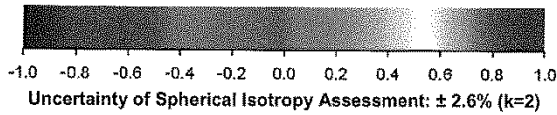
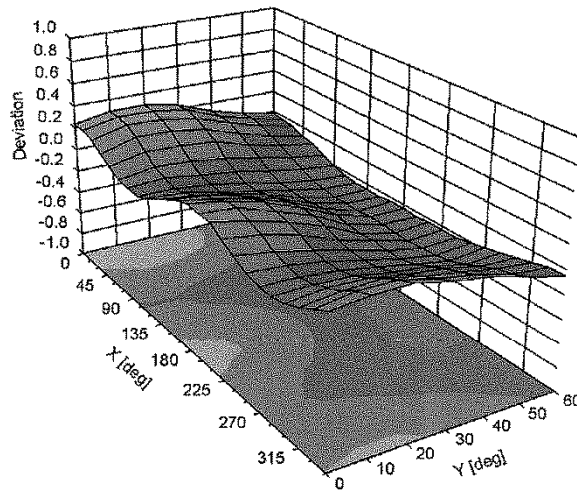

DASY/EASY - Parameters of Probe: EX3DV4 - SN:3922**Other Probe Parameters**

Sensor Arrangement	Triangular
Connector Angle (°)	107.5
Mechanical Surface Detection Mode	enabled
Optical Surface Detection Mode	disabled
Probe Overall Length	337 mm
Probe Body Diameter	10 mm
Tip Length	9 mm
Tip Diameter	2.5 mm
Probe Tip to Sensor X Calibration Point	1 mm
Probe Tip to Sensor Y Calibration Point	1 mm
Probe Tip to Sensor Z Calibration Point	1 mm
Recommended Measurement Distance from Surface	1.4 mm

Appendix: Modulation Calibration Parameters

UID	Communication System Name		A dB	B dB μ V	C	D dB	VR mV	Max Unc ^E (k=2)
0	CW	X	0.00	0.00	1.00	0.00	138.9	± 3.3 %
		Y	0.00	0.00	1.00		156.7	
		Z	0.00	0.00	1.00		150.2	
10010- CAA	SAR Validation (Square, 100ms, 10ms)	X	10.22	82.63	17.60	10.00	20.0	± 9.6 %
		Y	2.16	66.68	10.08		20.0	
		Z	4.90	74.46	14.49		20.0	
10011- CAB	UMTS-FDD (WCDMA)	X	1.00	66.46	14.75	0.00	150.0	± 9.6 %
		Y	1.04	88.80	15.85		150.0	
		Z	0.87	63.70	12.66		150.0	
10012- CAB	IEEE 802.11b WIFI 2.4 GHz (DSSS, 1 Mbps)	X	1.22	64.08	15.31	0.41	150.0	± 9.6 %
		Y	1.16	64.51	15.70		150.0	
		Z	1.15	62.70	14.01		150.0	
10013- CAB	IEEE 802.11g WIFI 2.4 GHz (DSSS- OFDM, 6 Mbps)	X	4.97	66.75	17.19	1.46	150.0	± 9.6 %
		Y	4.73	67.05	17.30		150.0	
		Z	4.91	66.44	16.86		150.0	
10021- DAC	GSM-FDD (TDMA, GMSK)	X	100.00	117.75	29.60	9.39	50.0	± 9.6 %
		Y	100.00	114.38	26.81		50.0	
		Z	100.00	116.87	28.94		50.0	
10023- DAC	GPRS-FDD (TDMA, GMSK, TN 0)	X	100.00	117.53	29.54	9.57	50.0	± 9.6 %
		Y	100.00	113.42	26.41		50.0	
		Z	100.00	116.65	28.87		50.0	
10024- DAC	GPRS-FDD (TDMA, GMSK, TN 0-1)	X	100.00	115.80	27.84	6.56	60.0	± 9.6 %
		Y	100.00	116.45	26.88		60.0	
		Z	100.00	114.31	26.94		60.0	
10025- DAC	EDGE-FDD (TDMA, 8PSK, TN 0)	X	6.40	82.36	32.51	12.57	50.0	± 9.6 %
		Y	12.81	114.09	48.03		50.0	
		Z	5.39	77.56	30.20		50.0	
10026- DAC	EDGE-FDD (TDMA, 8PSK, TN 0-1)	X	18.99	108.74	38.49	9.56	60.0	± 9.6 %
		Y	11.32	102.88	38.36		60.0	
		Z	14.13	101.58	36.03		60.0	
10027- DAC	GPRS-FDD (TDMA, GMSK, TN 0-1-2)	X	100.00	115.92	27.20	4.80	80.0	± 9.6 %
		Y	100.00	120.51	27.95		80.0	
		Z	100.00	113.62	25.95		80.0	
10028- DAC	GPRS-FDD (TDMA, GMSK, TN 0-1-2-3)	X	100.00	117.17	27.09	3.55	100.0	± 9.6 %
		Y	100.00	126.29	29.71		100.0	
		Z	100.00	113.65	25.34		100.0	
10029- DAC	EDGE-FDD (TDMA, 8PSK, TN 0-1-2)	X	10.01	92.59	31.63	7.80	80.0	± 9.6 %
		Y	5.95	85.21	30.10		80.0	
		Z	8.19	88.00	29.77		80.0	
10030- CAA	IEEE 802.15.1 Bluetooth (GFSK, DH1)	X	100.00	114.35	26.78	5.30	70.0	± 9.6 %
		Y	100.00	115.18	25.91		70.0	
		Z	100.00	112.41	25.69		70.0	
10031- CAA	IEEE 802.15.1 Bluetooth (GFSK, DH3)	X	100.00	117.60	25.92	1.88	100.0	± 9.6 %
		Y	100.00	125.73	27.92		100.0	
		Z	100.00	110.37	22.69		100.0	

10032-CAA	IEEE 802.15.1 Bluetooth (GFSK, DH5)	X	100.00	122.85	27.11	1.17	100.0	± 9.6 %
		Y	100.00	140.20	32.41		100.0	
		Z	100.00	110.46	21.87		100.0	
10033-CAA	IEEE 802.15.1 Bluetooth (PI/4-DQPSK, DH1)	X	100.00	128.60	34.99	5.30	70.0	± 9.6 %
		Y	100.00	128.81	34.01		70.0	
		Z	37.13	112.00	30.59		70.0	
10034-CAA	IEEE 802.15.1 Bluetooth (PI/4-DQPSK, DH3)	X	7.99	90.28	23.14	1.88	100.0	± 9.6 %
		Y	30.82	107.13	26.05		100.0	
		Z	3.26	76.76	18.03		100.0	
10035-CAA	IEEE 802.15.1 Bluetooth (PI/4-DQPSK, DH5)	X	3.43	79.39	19.22	1.17	100.0	± 9.6 %
		Y	5.34	85.34	19.82		100.0	
		Z	1.95	70.85	15.34		100.0	
10036-CAA	IEEE 802.15.1 Bluetooth (8-DPSK, DH1)	X	100.00	128.98	35.17	5.30	70.0	± 9.6 %
		Y	100.00	129.40	34.27		70.0	
		Z	71.70	122.79	33.35		70.0	
10037-CAA	IEEE 802.15.1 Bluetooth (8-DPSK, DH3)	X	7.27	88.99	22.70	1.88	100.0	± 9.6 %
		Y	18.21	100.58	24.40		100.0	
		Z	3.09	76.13	17.76		100.0	
10038-CAA	IEEE 802.15.1 Bluetooth (8-DPSK, DH5)	X	3.51	80.00	19.55	1.17	100.0	± 9.6 %
		Y	5.56	86.30	20.09		100.0	
		Z	1.96	71.12	15.55		100.0	
10039-CAB	CDMA2000 (1xRTT, RC1)	X	1.76	70.90	15.48	0.00	150.0	± 9.6 %
		Y	1.46	70.33	13.57		150.0	
		Z	1.29	66.18	12.76		150.0	
10042-CAB	IS-54 / IS-136 FDD (TDMA/FDM, PI/4-DQPSK, Halfrate)	X	100.00	113.36	26.88	7.78	50.0	± 9.6 %
		Y	100.00	110.28	24.34		50.0	
		Z	100.00	112.04	26.05		50.0	
10044-CAA	IS-91/EIA/TIA-553 FDD (FDMA, FM)	X	0.00	96.52	4.05	0.00	150.0	± 9.6 %
		Y	0.00	110.36	5.41		150.0	
		Z	0.02	107.42	7.74		150.0	
10048-CAA	DECT (TDD, TDMA/FDM, GFSK, Full Slot, 24)	X	100.00	120.47	31.99	13.80	25.0	± 9.6 %
		Y	100.00	110.06	26.00		25.0	
		Z	100.00	119.90	31.42		25.0	
10049-CAA	DECT (TDD, TDMA/FDM, GFSK, Double Slot, 12)	X	100.00	117.30	29.67	10.79	40.0	± 9.6 %
		Y	1374.02	140.45	31.34		40.0	
		Z	100.00	116.43	29.00		40.0	
10056-CAA	UMTS-TDD (TD-SCDMA, 1.28 Mcps)	X	100.00	125.96	34.92	9.03	50.0	± 9.6 %
		Y	100.00	125.07	33.36		50.0	
		Z	100.00	125.75	34.63		50.0	
10058-DAC	EDGE-FDD (TDMA, 8PSK, TN 0-1-2-3)	X	6.96	84.61	27.79	6.55	100.0	± 9.6 %
		Y	4.48	78.52	26.30		100.0	
		Z	5.96	81.17	26.23		100.0	
10059-CAB	IEEE 802.11b WiFi 2.4 GHz (DSSS, 2 Mbps)	X	1.31	65.73	16.21	0.61	110.0	± 9.6 %
		Y	1.21	65.92	16.54		110.0	
		Z	1.21	63.90	14.69		110.0	
10060-CAB	IEEE 802.11b WiFi 2.4 GHz (DSSS, 5.5 Mbps)	X	100.00	134.97	34.84	1.30	110.0	± 9.6 %
		Y	100.00	144.62	38.35		110.0	
		Z	5.26	89.72	22.60		110.0	

10061-CAB	IEEE 802.11b WiFi 2.4 GHz (DSSS, 11 Mbps)	X	7.25	94.27	26.93	2.04	110.0	± 9.6 %
		Y	5.44	94.48	27.93		110.0	
		Z	3.47	81.01	21.88		110.0	
10062-CAB	IEEE 802.11a/h WiFi 5 GHz (OFDM, 6 Mbps)	X	4.75	66.65	16.54	0.49	100.0	± 9.6 %
		Y	4.51	66.93	16.63		100.0	
		Z	4.68	66.30	16.18		100.0	
10063-CAB	IEEE 802.11a/h WiFi 5 GHz (OFDM, 9 Mbps)	X	4.78	66.78	16.66	0.72	100.0	± 9.6 %
		Y	4.53	67.06	16.76		100.0	
		Z	4.70	66.42	16.30		100.0	
10064-CAB	IEEE 802.11a/h WiFi 5 GHz (OFDM, 12 Mbps)	X	5.08	67.08	16.91	0.86	100.0	± 9.6 %
		Y	4.78	67.26	16.96		100.0	
		Z	5.01	66.74	16.58		100.0	
10065-CAB	IEEE 802.11a/h WiFi 5 GHz (OFDM, 18 Mbps)	X	4.96	67.04	17.06	1.21	100.0	± 9.6 %
		Y	4.66	67.16	17.09		100.0	
		Z	4.89	66.69	16.71		100.0	
10066-CAB	IEEE 802.11a/h WiFi 5 GHz (OFDM, 24 Mbps)	X	4.99	67.10	17.25	1.46	100.0	± 9.6 %
		Y	4.67	67.18	17.27		100.0	
		Z	4.92	66.75	16.91		100.0	
10067-CAB	IEEE 802.11a/h WiFi 5 GHz (OFDM, 36 Mbps)	X	5.29	67.24	17.70	2.04	100.0	± 9.6 %
		Y	4.97	67.49	17.80		100.0	
		Z	5.22	66.94	17.39		100.0	
10068-CAB	IEEE 802.11a/h WiFi 5 GHz (OFDM, 48 Mbps)	X	5.37	67.42	18.00	2.55	100.0	± 9.6 %
		Y	5.00	67.43	17.99		100.0	
		Z	5.29	67.10	17.68		100.0	
10069-CAB	IEEE 802.11a/h WiFi 5 GHz (OFDM, 54 Mbps)	X	5.44	67.37	18.17	2.67	100.0	± 9.6 %
		Y	5.07	67.46	18.19		100.0	
		Z	5.37	67.07	17.87		100.0	
10071-CAB	IEEE 802.11g WiFi 2.4 GHz (DSSS/OFDM, 9 Mbps)	X	5.08	66.89	17.54	1.99	100.0	± 9.6 %
		Y	4.83	67.15	17.64		100.0	
		Z	5.02	66.59	17.22		100.0	
10072-CAB	IEEE 802.11g WiFi 2.4 GHz (DSSS/OFDM, 12 Mbps)	X	5.09	67.31	17.81	2.30	100.0	± 9.6 %
		Y	4.80	67.45	17.88		100.0	
		Z	5.02	66.97	17.47		100.0	
10073-CAB	IEEE 802.11g WiFi 2.4 GHz (DSSS/OFDM, 18 Mbps)	X	5.17	67.53	18.18	2.83	100.0	± 9.6 %
		Y	4.87	67.68	18.27		100.0	
		Z	5.09	67.18	17.84		100.0	
10074-CAB	IEEE 802.11g WiFi 2.4 GHz (DSSS/OFDM, 24 Mbps)	X	5.16	67.47	18.37	3.30	100.0	± 9.6 %
		Y	4.87	67.63	18.45		100.0	
		Z	5.08	67.11	18.03		100.0	
10075-CAB	IEEE 802.11g WiFi 2.4 GHz (DSSS/OFDM, 36 Mbps)	X	5.22	67.70	18.76	3.82	90.0	± 9.6 %
		Y	4.89	67.67	18.74		90.0	
		Z	5.14	67.33	18.42		90.0	
10076-CAB	IEEE 802.11g WiFi 2.4 GHz (DSSS/OFDM, 48 Mbps)	X	5.22	67.45	18.86	4.15	90.0	± 9.6 %
		Y	4.92	67.52	18.92		90.0	
		Z	5.14	67.09	18.53		90.0	
10077-CAB	IEEE 802.11g WiFi 2.4 GHz (DSSS/OFDM, 54 Mbps)	X	5.24	67.51	18.95	4.30	90.0	± 9.6 %
		Y	4.95	67.62	19.04		90.0	
		Z	5.16	67.15	18.62		90.0	

10081-CAB	CDMA2000 (1xRTT, RC3)	X	0.84	65.40	12.52	0.00	150.0	± 9.6 %
		Y	0.65	64.57	10.44		150.0	
		Z	0.70	62.59	10.41		150.0	
10082-CAB	IS-54 / IS-136 FDD (TDMA/FDM, PI/4-DQPSK, Fullrate)	X	1.00	60.00	5.34	4.77	80.0	± 9.6 %
		Y	0.65	60.00	4.11		80.0	
		Z	0.94	60.00	5.13		80.0	
10090-DAC	GPRS-FDD (TDMA, GMSK, TN 0-4)	X	100.00	115.85	27.88	6.56	60.0	± 9.6 %
		Y	100.00	116.50	26.92		60.0	
		Z	100.00	114.37	26.98		60.0	
10097-CAB	UMTS-FDD (HSDPA)	X	1.80	67.04	15.39	0.00	150.0	± 9.6 %
		Y	1.85	68.99	15.97		150.0	
		Z	1.64	65.18	14.00		150.0	
10098-CAB	UMTS-FDD (HSUPA, Subtest 2)	X	1.76	66.99	15.35	0.00	150.0	± 9.6 %
		Y	1.81	68.96	15.96		150.0	
		Z	1.60	65.10	13.94		150.0	
10099-DAC	EDGE-FDD (TDMA, 8PSK, TN 0-4)	X	19.16	108.92	38.55	9.58	60.0	± 9.6 %
		Y	11.50	103.26	38.49		60.0	
		Z	14.26	101.76	36.08		60.0	
10100-CAD	LTE-FDD (SC-FDMA, 100% RB, 20 MHz, QPSK)	X	3.12	69.96	16.46	0.00	150.0	± 9.6 %
		Y	3.02	70.58	16.94		150.0	
		Z	2.84	68.15	15.30		150.0	
10101-CAD	LTE-FDD (SC-FDMA, 100% RB, 20 MHz, 16-QAM)	X	3.26	67.34	15.80	0.00	150.0	± 9.6 %
		Y	3.11	67.60	16.01		150.0	
		Z	3.13	66.43	15.09		150.0	
10102-CAD	LTE-FDD (SC-FDMA, 100% RB, 20 MHz, 64-QAM)	X	3.37	67.32	15.90	0.00	150.0	± 9.6 %
		Y	3.21	67.57	16.09		150.0	
		Z	3.24	66.46	15.22		150.0	
10103-CAD	LTE-TDD (SC-FDMA, 100% RB, 20 MHz, QPSK)	X	8.33	79.69	22.08	3.98	65.0	± 9.6 %
		Y	6.84	79.07	22.31		65.0	
		Z	7.34	77.47	21.06		65.0	
10104-CAD	LTE-TDD (SC-FDMA, 100% RB, 20 MHz, 16-QAM)	X	7.64	76.60	21.68	3.98	65.0	± 9.6 %
		Y	6.15	74.98	21.35		65.0	
		Z	7.10	75.26	20.98		65.0	
10105-CAD	LTE-TDD (SC-FDMA, 100% RB, 20 MHz, 64-QAM)	X	7.36	75.84	21.68	3.98	65.0	± 9.6 %
		Y	5.92	74.03	21.23		65.0	
		Z	6.77	74.27	20.87		65.0	
10108-CAE	LTE-FDD (SC-FDMA, 100% RB, 10 MHz, QPSK)	X	2.74	69.16	16.27	0.00	150.0	± 9.6 %
		Y	2.61	69.95	16.79		150.0	
		Z	2.49	67.37	15.08		150.0	
10109-CAE	LTE-FDD (SC-FDMA, 100% RB, 10 MHz, 16-QAM)	X	2.92	67.14	15.70	0.00	150.0	± 9.6 %
		Y	2.76	67.60	15.89		150.0	
		Z	2.78	66.11	14.90		150.0	
10110-CAE	LTE-FDD (SC-FDMA, 100% RB, 5 MHz, QPSK)	X	2.23	68.18	15.87	0.00	150.0	± 9.6 %
		Y	2.10	69.29	16.34		150.0	
		Z	2.02	66.33	14.57		150.0	
10111-CAE	LTE-FDD (SC-FDMA, 100% RB, 5 MHz, 16-QAM)	X	2.63	67.80	15.96	0.00	150.0	± 9.6 %
		Y	2.51	68.87	16.15		150.0	
		Z	2.45	66.39	14.92		150.0	

10112-CAE	LTE-FDD (SC-FDMA, 100% RB, 10 MHz, 64-QAM)	X	3.05	67.14	15.76	0.00	150.0	± 9.6 %
		Y	2.88	67.64	15.95		150.0	
		Z	2.91	66.18	15.00		150.0	
10113-CAE	LTE-FDD (SC-FDMA, 100% RB, 5 MHz, 64-QAM)	X	2.78	67.94	16.10	0.00	150.0	± 9.6 %
		Y	2.65	69.02	16.27		150.0	
		Z	2.60	66.61	15.11		150.0	
10114-CAB	IEEE 802.11n (HT Greenfield, 13.5 Mbps, BPSK)	X	5.16	67.08	16.36	0.00	150.0	± 9.6 %
		Y	4.94	67.18	16.47		150.0	
		Z	5.09	66.75	16.02		150.0	
10115-CAB	IEEE 802.11n (HT Greenfield, 81 Mbps, 16-QAM)	X	5.49	67.32	16.49	0.00	150.0	± 9.6 %
		Y	5.19	67.25	16.50		150.0	
		Z	5.41	66.99	16.16		150.0	
10116-CAB	IEEE 802.11n (HT Greenfield, 135 Mbps, 64-QAM)	X	5.27	67.31	16.40	0.00	150.0	± 9.6 %
		Y	5.03	67.38	16.49		150.0	
		Z	5.19	66.96	16.06		150.0	
10117-CAB	IEEE 802.11n (HT Mixed, 13.5 Mbps, BPSK)	X	5.14	67.00	16.33	0.00	150.0	± 9.6 %
		Y	4.94	67.14	16.46		150.0	
		Z	5.06	66.66	16.00		150.0	
10118-CAB	IEEE 802.11n (HT Mixed, 81 Mbps, 16-QAM)	X	5.56	67.51	16.58	0.00	150.0	± 9.6 %
		Y	5.26	67.44	16.60		150.0	
		Z	5.49	67.17	16.26		150.0	
10119-CAB	IEEE 802.11n (HT Mixed, 135 Mbps, 64-QAM)	X	5.24	67.24	16.37	0.00	150.0	± 9.6 %
		Y	5.02	67.37	16.50		150.0	
		Z	5.16	66.89	16.04		150.0	
10140-CAD	LTE-FDD (SC-FDMA, 100% RB, 15 MHz, 16-QAM)	X	3.41	67.32	15.83	0.00	150.0	± 9.6 %
		Y	3.24	67.60	16.01		150.0	
		Z	3.28	66.48	15.15		150.0	
10141-CAD	LTE-FDD (SC-FDMA, 100% RB, 15 MHz, 64-QAM)	X	3.53	67.42	16.00	0.00	150.0	± 9.6 %
		Y	3.36	67.74	16.19		150.0	
		Z	3.40	66.61	15.35		150.0	
10142-CAD	LTE-FDD (SC-FDMA, 100% RB, 3 MHz, QPSK)	X	2.00	68.09	15.56	0.00	150.0	± 9.6 %
		Y	1.87	69.35	15.72		150.0	
		Z	1.78	65.96	14.09		150.0	
10143-CAD	LTE-FDD (SC-FDMA, 100% RB, 3 MHz, 16-QAM)	X	2.48	68.45	15.72	0.00	150.0	± 9.6 %
		Y	2.33	69.45	15.38		150.0	
		Z	2.25	66.57	14.42		150.0	
10144-CAD	LTE-FDD (SC-FDMA, 100% RB, 3 MHz, 64-QAM)	X	2.28	66.39	14.23	0.00	150.0	± 9.6 %
		Y	1.98	66.31	13.31		150.0	
		Z	2.12	65.05	13.21		150.0	
10145-CAE	LTE-FDD (SC-FDMA, 100% RB, 1.4 MHz, QPSK)	X	1.30	65.44	12.36	0.00	150.0	± 9.6 %
		Y	0.79	61.72	8.33		150.0	
		Z	1.12	63.18	10.71		150.0	
10146-CAE	LTE-FDD (SC-FDMA, 100% RB, 1.4 MHz, 16-QAM)	X	2.64	70.08	14.27	0.00	150.0	± 9.6 %
		Y	1.12	61.74	7.81		150.0	
		Z	2.13	66.87	12.42		150.0	
10147-CAE	LTE-FDD (SC-FDMA, 100% RB, 1.4 MHz, 64-QAM)	X	3.51	73.94	16.07	0.00	150.0	± 9.6 %
		Y	1.20	62.39	8.26		150.0	
		Z	2.49	68.91	13.52		150.0	

10149-CAD	LTE-FDD (SC-FDMA, 50% RB, 20 MHz, 16-QAM)	X	2.93	67.20	15.74	0.00	150.0	± 9.6 %
		Y	2.77	67.66	15.94		150.0	
		Z	2.79	66.16	14.94		150.0	
10150-CAD	LTE-FDD (SC-FDMA, 50% RB, 20 MHz, 64-QAM)	X	3.06	67.19	15.80	0.00	150.0	± 9.6 %
		Y	2.89	67.70	16.00		150.0	
		Z	2.92	66.22	15.04		150.0	
10151-CAD	LTE-TDD (SC-FDMA, 50% RB, 20 MHz, QPSK)	X	9.10	82.72	23.34	3.98	65.0	± 9.6 %
		Y	7.77	83.35	24.03		65.0	
		Z	7.87	80.11	22.17		65.0	
10152-CAD	LTE-TDD (SC-FDMA, 50% RB, 20 MHz, 16-QAM)	X	7.25	76.84	21.53	3.98	65.0	± 9.6 %
		Y	5.77	75.38	21.12		65.0	
		Z	6.65	75.29	20.73		65.0	
10153-CAD	LTE-TDD (SC-FDMA, 50% RB, 20 MHz, 64-QAM)	X	7.68	77.84	22.31	3.98	65.0	± 9.6 %
		Y	6.19	76.52	21.97		65.0	
		Z	7.06	76.27	21.51		65.0	
10154-CAE	LTE-FDD (SC-FDMA, 50% RB, 10 MHz, QPSK)	X	2.27	68.60	16.13	0.00	150.0	± 9.6 %
		Y	2.14	69.66	16.57		150.0	
		Z	2.05	66.63	14.78		150.0	
10155-CAE	LTE-FDD (SC-FDMA, 50% RB, 10 MHz, 16-QAM)	X	2.63	67.80	15.97	0.00	150.0	± 9.6 %
		Y	2.51	68.91	16.18		150.0	
		Z	2.45	66.40	14.93		150.0	
10156-CAE	LTE-FDD (SC-FDMA, 50% RB, 5 MHz, QPSK)	X	1.85	68.17	15.39	0.00	150.0	± 9.6 %
		Y	1.69	69.14	15.17		150.0	
		Z	1.62	65.76	13.75		150.0	
10157-CAE	LTE-FDD (SC-FDMA, 50% RB, 5 MHz, 16-QAM)	X	2.12	66.91	14.29	0.00	150.0	± 9.6 %
		Y	1.79	66.54	13.00		150.0	
		Z	1.92	65.19	13.05		150.0	
10158-CAE	LTE-FDD (SC-FDMA, 50% RB, 10 MHz, 64-QAM)	X	2.79	68.00	16.14	0.00	150.0	± 9.6 %
		Y	2.66	69.10	16.32		150.0	
		Z	2.61	66.65	15.15		150.0	
10159-CAE	LTE-FDD (SC-FDMA, 50% RB, 5 MHz, 64-QAM)	X	2.23	67.39	14.59	0.00	150.0	± 9.6 %
		Y	1.87	66.87	13.20		150.0	
		Z	2.01	65.56	13.30		150.0	
10160-CAD	LTE-FDD (SC-FDMA, 50% RB, 15 MHz, QPSK)	X	2.74	68.23	16.07	0.00	150.0	± 9.6 %
		Y	2.64	69.20	16.55		150.0	
		Z	2.55	66.80	15.05		150.0	
10161-CAD	LTE-FDD (SC-FDMA, 50% RB, 15 MHz, 16-QAM)	X	2.95	67.11	15.74	0.00	150.0	± 9.6 %
		Y	2.78	67.68	15.88		150.0	
		Z	2.81	66.11	14.94		150.0	
10162-CAD	LTE-FDD (SC-FDMA, 50% RB, 15 MHz, 64-QAM)	X	3.06	67.24	15.84	0.00	150.0	± 9.6 %
		Y	2.89	67.90	16.02		150.0	
		Z	2.92	66.26	15.07		150.0	
10166-CAE	LTE-FDD (SC-FDMA, 50% RB, 1.4 MHz, QPSK)	X	3.70	69.58	19.27	3.01	150.0	± 9.6 %
		Y	3.28	69.68	19.46		150.0	
		Z	3.63	69.00	18.75		150.0	
10167-CAE	LTE-FDD (SC-FDMA, 50% RB, 1.4 MHz, 16-QAM)	X	4.55	72.43	19.74	3.01	150.0	± 9.6 %
		Y	3.95	72.87	20.04		150.0	
		Z	4.44	71.75	19.18		150.0	

10168-CAE	LTE-FDD (SC-FDMA, 50% RB, 1.4 MHz, 64-QAM)	X	5.04	74.67	21.06	3.01	150.0	± 9.6 %
		Y	4.45	75.52	21.56		150.0	
		Z	4.90	73.87	20.45		150.0	
10169-CAD	LTE-FDD (SC-FDMA, 1 RB, 20 MHz, QPSK)	X	3.13	69.42	19.23	3.01	150.0	± 9.6 %
		Y	2.65	68.12	18.80		150.0	
		Z	3.07	68.78	18.63		150.0	
10170-CAD	LTE-FDD (SC-FDMA, 1 RB, 20 MHz, 16-QAM)	X	4.32	75.44	21.61	3.01	150.0	± 9.6 %
		Y	3.45	73.89	21.21		150.0	
		Z	4.18	74.42	20.85		150.0	
10171-AAD	LTE-FDD (SC-FDMA, 1 RB, 20 MHz, 64-QAM)	X	3.55	71.24	18.84	3.01	150.0	± 9.6 %
		Y	2.88	70.12	18.52		150.0	
		Z	3.46	70.45	18.18		150.0	
10172-CAD	LTE-TDD (SC-FDMA, 1 RB, 20 MHz, QPSK)	X	22.91	110.27	34.84	6.02	65.0	± 9.6 %
		Y	8.26	96.77	32.08		65.0	
		Z	13.81	99.89	31.52		65.0	
10173-CAD	LTE-TDD (SC-FDMA, 1 RB, 20 MHz, 16-QAM)	X	55.63	121.17	35.70	6.02	65.0	± 9.6 %
		Y	30.82	118.44	36.12		65.0	
		Z	32.47	110.93	32.74		65.0	
10174-CAD	LTE-TDD (SC-FDMA, 1 RB, 20 MHz, 64-QAM)	X	39.54	113.02	32.93	6.02	65.0	± 9.6 %
		Y	23.05	110.98	33.34		65.0	
		Z	23.65	103.70	30.13		65.0	
10175-CAE	LTE-FDD (SC-FDMA, 1 RB, 10 MHz, QPSK)	X	3.09	69.10	18.97	3.01	150.0	± 9.6 %
		Y	2.62	67.88	18.58		150.0	
		Z	3.03	68.48	18.39		150.0	
10176-CAE	LTE-FDD (SC-FDMA, 1 RB, 10 MHz, 16-QAM)	X	4.33	75.46	21.62	3.01	150.0	± 9.6 %
		Y	3.46	73.91	21.22		150.0	
		Z	4.19	74.44	20.86		150.0	
10177-CAG	LTE-FDD (SC-FDMA, 1 RB, 5 MHz, QPSK)	X	3.12	69.26	19.08	3.01	150.0	± 9.6 %
		Y	2.64	67.99	18.65		150.0	
		Z	3.06	68.63	18.48		150.0	
10178-CAE	LTE-FDD (SC-FDMA, 1 RB, 5 MHz, 16-QAM)	X	4.28	75.20	21.48	3.01	150.0	± 9.6 %
		Y	3.44	73.78	21.14		150.0	
		Z	4.14	74.21	20.73		150.0	
10179-CAE	LTE-FDD (SC-FDMA, 1 RB, 10 MHz, 64-QAM)	X	3.90	73.22	20.10	3.01	150.0	± 9.6 %
		Y	3.15	71.97	19.77		150.0	
		Z	3.78	72.29	19.37		150.0	
10180-CAE	LTE-FDD (SC-FDMA, 1 RB, 5 MHz, 64-QAM)	X	3.54	71.16	18.79	3.01	150.0	± 9.6 %
		Y	2.88	70.08	18.49		150.0	
		Z	3.45	70.36	18.13		150.0	
10181-CAD	LTE-FDD (SC-FDMA, 1 RB, 15 MHz, QPSK)	X	3.11	69.24	19.07	3.01	150.0	± 9.6 %
		Y	2.63	67.97	18.65		150.0	
		Z	3.05	68.61	18.48		150.0	
10182-CAD	LTE-FDD (SC-FDMA, 1 RB, 15 MHz, 16-QAM)	X	4.27	75.18	21.47	3.01	150.0	± 9.6 %
		Y	3.43	73.75	21.13		150.0	
		Z	4.14	74.19	20.72		150.0	
10183-AAC	LTE-FDD (SC-FDMA, 1 RB, 15 MHz, 64-QAM)	X	3.53	71.14	18.78	3.01	150.0	± 9.6 %
		Y	2.88	70.06	18.48		150.0	
		Z	3.44	70.36	18.12		150.0	

10184-CAD	LTE-FDD (SC-FDMA, 1 RB, 3 MHz, QPSK)	X	3.12	69.29	19.09	3.01	150.0	± 9.6 %
		Y	2.64	68.01	18.67		150.0	
		Z	3.06	68.65	18.50		150.0	
10185-CAD	LTE-FDD (SC-FDMA, 1 RB, 3 MHz, 16-QAM)	X	4.29	75.25	21.51	3.01	150.0	± 9.6 %
		Y	3.45	73.82	21.16		150.0	
		Z	4.16	74.26	20.76		150.0	
10186-AAD	LTE-FDD (SC-FDMA, 1 RB, 3 MHz, 64-QAM)	X	3.55	71.20	18.81	3.01	150.0	± 9.6 %
		Y	2.89	70.12	18.52		150.0	
		Z	3.46	70.42	18.15		150.0	
10187-CAE	LTE-FDD (SC-FDMA, 1 RB, 1.4 MHz, QPSK)	X	3.13	69.33	19.15	3.01	150.0	± 9.6 %
		Y	2.65	68.08	18.74		150.0	
		Z	3.07	68.70	18.55		150.0	
10188-CAE	LTE-FDD (SC-FDMA, 1 RB, 1.4 MHz, 16-QAM)	X	4.44	75.95	21.90	3.01	150.0	± 9.6 %
		Y	3.54	74.36	21.49		150.0	
		Z	4.29	74.91	21.13		150.0	
10189-AAE	LTE-FDD (SC-FDMA, 1 RB, 1.4 MHz, 64-QAM)	X	3.63	71.64	19.09	3.01	150.0	± 9.6 %
		Y	2.95	70.50	18.77		150.0	
		Z	3.53	70.83	18.42		150.0	
10193-CAB	IEEE 802.11n (HT Greenfield, 6.5 Mbps, BPSK)	X	4.57	66.49	16.08	0.00	150.0	± 9.6 %
		Y	4.36	66.85	16.18		150.0	
		Z	4.49	66.12	15.71		150.0	
10194-CAB	IEEE 802.11n (HT Greenfield, 39 Mbps, 16-QAM)	X	4.74	66.82	16.20	0.00	150.0	± 9.6 %
		Y	4.50	67.09	16.31		150.0	
		Z	4.67	66.44	15.83		150.0	
10195-CAB	IEEE 802.11n (HT Greenfield, 65 Mbps, 64-QAM)	X	4.79	66.85	16.22	0.00	150.0	± 9.6 %
		Y	4.53	67.11	16.33		150.0	
		Z	4.71	66.47	15.85		150.0	
10196-CAB	IEEE 802.11n (HT Mixed, 6.5 Mbps, BPSK)	X	4.57	66.56	16.11	0.00	150.0	± 9.6 %
		Y	4.34	66.85	16.17		150.0	
		Z	4.50	66.18	15.73		150.0	
10197-CAB	IEEE 802.11n (HT Mixed, 39 Mbps, 16-QAM)	X	4.76	66.84	16.21	0.00	150.0	± 9.6 %
		Y	4.51	67.10	16.32		150.0	
		Z	4.68	66.46	15.84		150.0	
10198-CAB	IEEE 802.11n (HT Mixed, 65 Mbps, 64-QAM)	X	4.79	66.86	16.23	0.00	150.0	± 9.6 %
		Y	4.53	67.11	16.33		150.0	
		Z	4.71	66.49	15.86		150.0	
10219-CAB	IEEE 802.11n (HT Mixed, 7.2 Mbps, BPSK)	X	4.52	66.57	16.07	0.00	150.0	± 9.6 %
		Y	4.29	66.89	16.14		150.0	
		Z	4.45	66.18	15.68		150.0	
10220-CAB	IEEE 802.11n (HT Mixed, 43.3 Mbps, 16-QAM)	X	4.75	66.82	16.21	0.00	150.0	± 9.6 %
		Y	4.50	67.06	16.31		150.0	
		Z	4.68	66.44	15.84		150.0	
10221-CAB	IEEE 802.11n (HT Mixed, 72.2 Mbps, 64-QAM)	X	4.80	66.80	16.22	0.00	150.0	± 9.6 %
		Y	4.54	67.05	16.32		150.0	
		Z	4.72	66.43	15.85		150.0	
10222-CAB	IEEE 802.11n (HT Mixed, 15 Mbps, BPSK)	X	5.11	67.01	16.33	0.00	150.0	± 9.6 %
		Y	4.91	67.12	16.44		150.0	
		Z	5.04	66.66	15.99		150.0	

10223-CAB	IEEE 802.11n (HT Mixed, 90 Mbps, 16-QAM)	X	5.42	67.19	16.44	0.00	150.0	± 9.6 %
		Y	5.17	67.31	16.55		150.0	
		Z	5.35	66.87	16.13		150.0	
10224-CAB	IEEE 802.11n (HT Mixed, 150 Mbps, 64-QAM)	X	5.16	67.12	16.31	0.00	150.0	± 9.6 %
		Y	4.95	67.23	16.43		150.0	
		Z	5.08	66.77	15.97		150.0	
10225-CAB	UMTS-FDD (HSPA+)	X	2.83	65.90	15.26	0.00	150.0	± 9.6 %
		Y	2.64	66.43	15.06		150.0	
		Z	2.73	65.11	14.56		150.0	
10226-CAA	LTE-TDD (SC-FDMA, 1 RB, 1.4 MHz, 16-QAM)	X	63.57	123.88	36.49	6.02	65.0	± 9.6 %
		Y	35.48	121.38	37.00		65.0	
		Z	36.12	113.06	33.42		65.0	
10227-CAA	LTE-TDD (SC-FDMA, 1 RB, 1.4 MHz, 64-QAM)	X	51.61	117.88	34.29	6.02	65.0	± 9.6 %
		Y	38.44	120.37	35.86		65.0	
		Z	31.38	108.65	31.57		65.0	
10228-CAA	LTE-TDD (SC-FDMA, 1 RB, 1.4 MHz, QPSK)	X	28.51	115.16	36.33	6.02	65.0	± 9.6 %
		Y	9.53	100.12	33.25		65.0	
		Z	17.50	104.98	33.15		65.0	
10229-CAB	LTE-TDD (SC-FDMA, 1 RB, 3 MHz, 16-QAM)	X	56.02	121.29	35.74	6.02	65.0	± 9.6 %
		Y	31.08	118.56	36.15		65.0	
		Z	32.73	111.05	32.78		65.0	
10230-CAB	LTE-TDD (SC-FDMA, 1 RB, 3 MHz, 64-QAM)	X	46.07	115.69	33.64	6.02	65.0	± 9.6 %
		Y	32.82	117.30	34.98		65.0	
		Z	28.59	106.87	31.00		65.0	
10231-CAB	LTE-TDD (SC-FDMA, 1 RB, 3 MHz, QPSK)	X	26.24	113.32	35.73	6.02	65.0	± 9.6 %
		Y	9.00	98.78	32.73		65.0	
		Z	16.41	103.56	32.64		65.0	
10232-CAD	LTE-TDD (SC-FDMA, 1 RB, 5 MHz, 16-QAM)	X	56.00	121.29	35.74	6.02	65.0	± 9.6 %
		Y	31.03	118.56	36.15		65.0	
		Z	32.69	111.04	32.78		65.0	
10233-CAD	LTE-TDD (SC-FDMA, 1 RB, 5 MHz, 64-QAM)	X	45.99	115.67	33.63	6.02	65.0	± 9.6 %
		Y	32.61	117.20	34.96		65.0	
		Z	28.53	106.85	30.99		65.0	
10234-CAD	LTE-TDD (SC-FDMA, 1 RB, 5 MHz, QPSK)	X	24.41	111.60	35.12	6.02	65.0	± 9.6 %
		Y	8.65	97.77	32.27		65.0	
		Z	15.51	102.25	32.12		65.0	
10235-CAD	LTE-TDD (SC-FDMA, 1 RB, 10 MHz, 16-QAM)	X	56.25	121.39	35.77	6.02	65.0	± 9.6 %
		Y	31.20	118.68	36.19		65.0	
		Z	32.77	111.11	32.80		65.0	
10236-CAD	LTE-TDD (SC-FDMA, 1 RB, 10 MHz, 64-QAM)	X	46.86	115.97	33.70	6.02	65.0	± 9.6 %
		Y	33.64	117.72	35.08		65.0	
		Z	28.97	107.08	31.05		65.0	
10237-CAD	LTE-TDD (SC-FDMA, 1 RB, 10 MHz, QPSK)	X	26.45	113.52	35.78	6.02	65.0	± 9.6 %
		Y	9.02	98.88	32.77		65.0	
		Z	16.46	103.69	32.68		65.0	
10238-CAD	LTE-TDD (SC-FDMA, 1 RB, 15 MHz, 16-QAM)	X	55.98	121.30	35.74	6.02	65.0	± 9.6 %
		Y	30.96	118.55	36.15		65.0	
		Z	32.64	111.03	32.77		65.0	

10239-CAD	LTE-TDD (SC-FDMA, 1 RB, 15 MHz, 64-QAM)	X	45.90	115.66	33.63	6.02	65.0	± 9.6 %
		Y	32.42	117.13	34.95		65.0	
		Z	28.45	106.82	30.99		65.0	
10240-CAD	LTE-TDD (SC-FDMA, 1 RB, 15 MHz, QPSK)	X	26.33	113.44	35.76	6.02	65.0	± 9.6 %
		Y	9.00	98.85	32.76		65.0	
		Z	16.42	103.62	32.66		65.0	
10241-CAA	LTE-TDD (SC-FDMA, 50% RB, 1.4 MHz, 16-QAM)	X	10.07	84.89	27.17	6.98	65.0	± 9.6 %
		Y	8.48	85.82	27.97		65.0	
		Z	9.42	83.49	26.49		65.0	
10242-CAA	LTE-TDD (SC-FDMA, 50% RB, 1.4 MHz, 64-QAM)	X	9.62	83.89	26.70	6.98	65.0	± 9.6 %
		Y	8.07	84.80	27.50		65.0	
		Z	8.78	81.98	25.82		65.0	
10243-CAA	LTE-TDD (SC-FDMA, 50% RB, 1.4 MHz, QPSK)	X	7.49	79.90	26.00	6.98	65.0	± 9.6 %
		Y	6.06	79.30	26.24		65.0	
		Z	6.89	78.08	25.09		65.0	
10244-CAB	LTE-TDD (SC-FDMA, 50% RB, 3 MHz, 16-QAM)	X	9.99	83.65	22.16	3.98	65.0	± 9.6 %
		Y	5.92	76.90	18.09		65.0	
		Z	8.32	80.61	20.83		65.0	
10245-CAB	LTE-TDD (SC-FDMA, 50% RB, 3 MHz, 64-QAM)	X	9.55	82.63	21.73	3.98	65.0	± 9.6 %
		Y	5.48	75.50	17.46		65.0	
		Z	8.04	79.78	20.46		65.0	
10246-CAB	LTE-TDD (SC-FDMA, 50% RB, 3 MHz, QPSK)	X	10.75	87.85	23.54	3.98	65.0	± 9.6 %
		Y	7.46	84.12	21.21		65.0	
		Z	7.49	81.97	21.23		65.0	
10247-CAD	LTE-TDD (SC-FDMA, 50% RB, 5 MHz, 16-QAM)	X	7.05	78.53	20.82	3.98	65.0	± 9.6 %
		Y	5.10	75.52	18.72		65.0	
		Z	6.05	75.99	19.59		65.0	
10248-CAD	LTE-TDD (SC-FDMA, 50% RB, 5 MHz, 64-QAM)	X	6.88	77.62	20.43	3.98	65.0	± 9.6 %
		Y	4.87	74.30	18.18		65.0	
		Z	6.00	75.32	19.29		65.0	
10249-CAD	LTE-TDD (SC-FDMA, 50% RB, 5 MHz, QPSK)	X	12.17	90.46	25.25	3.98	65.0	± 9.6 %
		Y	11.28	92.21	25.40		65.0	
		Z	8.74	84.78	23.07		65.0	
10250-CAD	LTE-TDD (SC-FDMA, 50% RB, 10 MHz, 16-QAM)	X	7.83	80.37	23.01	3.98	65.0	± 9.6 %
		Y	6.20	79.06	22.43		65.0	
		Z	6.92	78.10	21.92		65.0	
10251-CAD	LTE-TDD (SC-FDMA, 50% RB, 10 MHz, 64-QAM)	X	7.19	77.51	21.51	3.98	65.0	± 9.6 %
		Y	5.63	75.97	20.72		65.0	
		Z	6.50	75.72	20.60		65.0	
10252-CAD	LTE-TDD (SC-FDMA, 50% RB, 10 MHz, QPSK)	X	10.60	87.58	25.11	3.98	65.0	± 9.6 %
		Y	9.46	89.47	26.06		65.0	
		Z	8.47	83.54	23.47		65.0	
10253-CAD	LTE-TDD (SC-FDMA, 50% RB, 15 MHz, 16-QAM)	X	7.03	76.14	21.26	3.98	65.0	± 9.6 %
		Y	5.67	74.89	20.81		65.0	
		Z	6.47	74.67	20.48		65.0	
10254-CAD	LTE-TDD (SC-FDMA, 50% RB, 15 MHz, 64-QAM)	X	7.44	77.09	21.97	3.98	65.0	± 9.6 %
		Y	6.03	75.88	21.53		65.0	
		Z	6.86	75.60	21.19		65.0	

10255-CAD	LTE-TDD (SC-FDMA, 50% RB, 15 MHz, QPSK)	X	8.54	81.84	23.25	3.98	65.0	± 9.6 %
		Y	7.24	82.29	23.80		65.0	
		Z	7.45	79.36	22.12		65.0	
10256-CAA	LTE-TDD (SC-FDMA, 100% RB, 1.4 MHz, 16-QAM)	X	8.24	79.99	19.83	3.98	65.0	± 9.6 %
		Y	3.52	69.17	13.46		65.0	
		Z	6.74	76.91	18.43		65.0	
10257-CAA	LTE-TDD (SC-FDMA, 100% RB, 1.4 MHz, 64-QAM)	X	7.70	78.55	19.18	3.98	65.0	± 9.6 %
		Y	3.29	67.96	12.77		65.0	
		Z	6.41	75.78	17.88		65.0	
10258-CAA	LTE-TDD (SC-FDMA, 100% RB, 1.4 MHz, QPSK)	X	8.06	82.58	20.92	3.98	65.0	± 9.6 %
		Y	3.74	73.03	15.71		65.0	
		Z	5.75	77.43	18.76		65.0	
10259-CAB	LTE-TDD (SC-FDMA, 100% RB, 3 MHz, 16-QAM)	X	7.35	79.15	21.58	3.98	65.0	± 9.6 %
		Y	5.61	77.14	20.18		65.0	
		Z	6.39	76.75	20.41		65.0	
10260-CAB	LTE-TDD (SC-FDMA, 100% RB, 3 MHz, 64-QAM)	X	7.30	78.71	21.41	3.98	65.0	± 9.6 %
		Y	5.54	76.53	19.91		65.0	
		Z	6.40	76.43	20.30		65.0	
10261-CAB	LTE-TDD (SC-FDMA, 100% RB, 3 MHz, QPSK)	X	10.52	87.84	24.75	3.98	65.0	± 9.6 %
		Y	9.43	89.34	25.09		65.0	
		Z	8.09	83.22	22.89		65.0	
10262-CAD	LTE-TDD (SC-FDMA, 100% RB, 5 MHz, 16-QAM)	X	7.81	80.31	22.96	3.98	65.0	± 9.6 %
		Y	6.18	78.97	22.37		65.0	
		Z	6.91	78.04	21.88		65.0	
10263-CAD	LTE-TDD (SC-FDMA, 100% RB, 5 MHz, 64-QAM)	X	7.18	77.49	21.51	3.98	65.0	± 9.6 %
		Y	5.62	75.94	20.71		65.0	
		Z	6.49	75.70	20.59		65.0	
10264-CAD	LTE-TDD (SC-FDMA, 100% RB, 5 MHz, QPSK)	X	10.47	87.33	25.00	3.98	65.0	± 9.6 %
		Y	9.30	89.13	25.91		65.0	
		Z	8.38	83.33	23.37		65.0	
10265-CAD	LTE-TDD (SC-FDMA, 100% RB, 10 MHz, 16-QAM)	X	7.24	76.84	21.54	3.98	65.0	± 9.6 %
		Y	5.77	75.38	21.12		65.0	
		Z	6.64	75.29	20.73		65.0	
10266-CAD	LTE-TDD (SC-FDMA, 100% RB, 10 MHz, 64-QAM)	X	7.68	77.82	22.30	3.98	65.0	± 9.6 %
		Y	6.19	76.50	21.96		65.0	
		Z	7.06	76.26	21.50		65.0	
10267-CAD	LTE-TDD (SC-FDMA, 100% RB, 10 MHz, QPSK)	X	9.08	82.67	23.32	3.98	65.0	± 9.6 %
		Y	7.74	83.27	24.00		65.0	
		Z	7.85	80.06	22.15		65.0	
10268-CAD	LTE-TDD (SC-FDMA, 100% RB, 15 MHz, 16-QAM)	X	7.73	76.25	21.66	3.98	65.0	± 9.6 %
		Y	6.29	74.83	21.35		65.0	
		Z	7.22	75.02	21.00		65.0	
10269-CAD	LTE-TDD (SC-FDMA, 100% RB, 15 MHz, 64-QAM)	X	7.63	75.72	21.50	3.98	65.0	± 9.6 %
		Y	6.26	74.33	21.17		65.0	
		Z	7.17	74.56	20.87		65.0	
10270-CAD	LTE-TDD (SC-FDMA, 100% RB, 15 MHz, QPSK)	X	8.16	78.72	21.94	3.98	65.0	± 9.6 %
		Y	6.83	78.36	22.23		65.0	
		Z	7.42	77.03	21.11		65.0	

10274-CAB	UMTS-FDD (HSUPA, Subtest 5, 3GPP Rel8.10)	X	2.59	66.15	15.11	0.00	150.0	± 9.6 %
		Y	2.50	67.14	15.17		150.0	
		Z	2.47	65.19	14.30		150.0	
10275-CAB	UMTS-FDD (HSUPA, Subtest 5, 3GPP Rel8.4)	X	1.59	67.24	15.20	0.00	150.0	± 9.6 %
		Y	1.59	68.96	15.86		150.0	
		Z	1.41	65.03	13.61		150.0	
10277-CAA	PHS (QPSK)	X	2.88	63.88	9.19	9.03	50.0	± 9.6 %
		Y	1.50	60.00	5.26		50.0	
		Z	2.57	63.07	8.53		50.0	
10278-CAA	PHS (QPSK, BW 884MHz, Rolloff 0.5)	X	13.64	88.52	22.50	9.03	50.0	± 9.6 %
		Y	3.82	70.53	13.80		50.0	
		Z	9.48	83.22	20.46		50.0	
10279-CAA	PHS (QPSK, BW 884MHz, Rolloff 0.38)	X	13.81	88.65	22.60	9.03	50.0	± 9.6 %
		Y	3.97	70.94	13.86		50.0	
		Z	9.68	83.45	20.60		50.0	
10290-AAB	CDMA2000, RC1, SO55, Full Rate	X	1.45	68.11	13.95	0.00	150.0	± 9.6 %
		Y	1.04	66.23	11.42		150.0	
		Z	1.16	64.74	11.79		150.0	
10291-AAB	CDMA2000, RC3, SO55, Full Rate	X	0.83	65.20	12.40	0.00	150.0	± 9.6 %
		Y	0.64	64.34	10.30		150.0	
		Z	0.69	62.48	10.33		150.0	
10292-AAB	CDMA2000, RC3, SO32, Full Rate	X	1.00	68.65	14.50	0.00	150.0	± 9.6 %
		Y	1.04	70.68	13.62		150.0	
		Z	0.74	63.90	11.44		150.0	
10293-AAB	CDMA2000, RC3, SO3, Full Rate	X	1.42	73.67	17.19	0.00	150.0	± 9.6 %
		Y	4.51	88.63	20.36		150.0	
		Z	0.87	65.86	12.87		150.0	
10295-AAB	CDMA2000, RC1, SO3, 1/8th Rate 25 fr.	X	13.04	92.10	27.12	9.03	50.0	± 9.6 %
		Y	89.47	123.70	34.18		50.0	
		Z	10.40	88.04	25.54		50.0	
10297-AAC	LTE-FDD (SC-FDMA, 50% RB, 20 MHz, QPSK)	X	2.75	69.26	16.34	0.00	150.0	± 9.6 %
		Y	2.62	70.06	16.86		150.0	
		Z	2.50	67.45	15.14		150.0	
10298-AAC	LTE-FDD (SC-FDMA, 50% RB, 3 MHz, QPSK)	X	1.59	67.33	14.16	0.00	150.0	± 9.6 %
		Y	1.21	65.83	12.02		150.0	
		Z	1.36	64.73	12.38		150.0	
10299-AAC	LTE-FDD (SC-FDMA, 50% RB, 3 MHz, 16-QAM)	X	3.25	72.49	16.21	0.00	150.0	± 9.6 %
		Y	1.86	66.60	11.67		150.0	
		Z	2.67	69.25	14.40		150.0	
10300-AAC	LTE-FDD (SC-FDMA, 50% RB, 3 MHz, 64-QAM)	X	2.29	66.76	12.86	0.00	150.0	± 9.6 %
		Y	1.34	62.41	8.77		150.0	
		Z	2.09	65.32	11.82		150.0	
10301-AAA	IEEE 802.16e WiMAX (29:18, 5ms, 10MHz, QPSK, PUSC)	X	4.98	65.86	17.65	4.17	50.0	± 9.6 %
		Y	4.63	66.36	17.72		50.0	
		Z	4.82	65.17	17.13		50.0	
10302-AAA	IEEE 802.16e WiMAX (29:18, 5ms, 10MHz, QPSK, PUSC, 3 CTRL symbols)	X	5.45	66.44	18.35	4.96	50.0	± 9.6 %
		Y	5.06	66.66	18.26		50.0	
		Z	5.34	65.98	17.96		50.0	

10303-AAA	IEEE 802.16e WiMAX (31:15, 5ms, 10MHz, 64QAM, PUSC)	X	5.22	66.18	18.24	4.96	50.0	± 9.6 %
		Y	4.81	66.31	18.06		50.0	
		Z	5.11	65.69	17.82		50.0	
10304-AAA	IEEE 802.16e WiMAX (29:18, 5ms, 10MHz, 64QAM, PUSC)	X	5.00	65.94	17.66	4.17	50.0	± 9.6 %
		Y	4.64	66.23	17.57		50.0	
		Z	4.89	65.44	17.24		50.0	
10305-AAA	IEEE 802.16e WiMAX (31:15, 10ms, 10MHz, 64QAM, PUSC, 15 symbols)	X	4.85	68.97	20.43	6.02	35.0	± 9.6 %
		Y	4.24	68.22	19.36		35.0	
		Z	4.63	67.91	19.70		35.0	
10306-AAA	IEEE 802.16e WiMAX (29:18, 10ms, 10MHz, 64QAM, PUSC, 18 symbols)	X	5.05	67.46	19.74	6.02	35.0	± 9.6 %
		Y	4.55	67.22	19.12		35.0	
		Z	4.90	66.76	19.19		35.0	
10307-AAA	IEEE 802.16e WiMAX (29:18, 10ms, 10MHz, QPSK, PUSC, 18 symbols)	X	4.98	67.80	19.78	6.02	35.0	± 9.6 %
		Y	4.43	67.25	19.02		35.0	
		Z	4.82	67.00	19.19		35.0	
10308-AAA	IEEE 802.16e WiMAX (29:18, 10ms, 10MHz, 16QAM, PUSC)	X	4.97	68.02	19.93	6.02	35.0	± 9.6 %
		Y	4.41	67.51	19.19		35.0	
		Z	4.79	67.20	19.32		35.0	
10309-AAA	IEEE 802.16e WiMAX (29:18, 10ms, 10MHz, 16QAM, AMC 2x3, 18 symbols)	X	5.12	67.73	19.90	6.02	35.0	± 9.6 %
		Y	4.57	67.33	19.23		35.0	
		Z	4.97	67.01	19.35		35.0	
10310-AAA	IEEE 802.16e WiMAX (29:18, 10ms, 10MHz, QPSK, AMC 2x3, 18 symbols)	X	5.01	67.57	19.73	6.02	35.0	± 9.6 %
		Y	4.50	67.29	19.11		35.0	
		Z	4.85	66.84	19.17		35.0	
10311-AAC	LTE-FDD (SC-FDMA, 100% RB, 15 MHz, QPSK)	X	3.10	68.61	16.02	0.00	150.0	± 9.6 %
		Y	2.98	69.21	16.47		150.0	
		Z	2.83	66.90	14.91		150.0	
10313-AAA	iDEN 1:3	X	9.28	84.22	20.34	6.99	70.0	± 9.6 %
		Y	9.97	89.26	22.12		70.0	
		Z	5.73	77.83	17.93		70.0	
10314-AAA	iDEN 1:6	X	20.75	102.60	29.12	10.00	30.0	± 9.6 %
		Y	21.78	109.37	31.63		30.0	
		Z	8.22	87.81	24.52		30.0	
10315-AAB	IEEE 802.11b WiFi 2.4 GHz (DSSS, 1 Mbps, 96pc duty cycle)	X	1.11	63.72	15.07	0.17	150.0	± 9.6 %
		Y	1.07	64.37	15.57		150.0	
		Z	1.04	62.32	13.71		150.0	
10316-AAB	IEEE 802.11g WiFi 2.4 GHz (ERP-OFDM, 6 Mbps, 96pc duty cycle)	X	4.64	66.61	16.27	0.17	150.0	± 9.6 %
		Y	4.40	66.89	16.37		150.0	
		Z	4.57	66.24	15.90		150.0	
10317-AAB	IEEE 802.11a WiFi 5 GHz (OFDM, 6 Mbps, 96pc duty cycle)	X	4.64	66.61	16.27	0.17	150.0	± 9.6 %
		Y	4.40	66.89	16.37		150.0	
		Z	4.57	66.24	15.90		150.0	
10400-AAC	IEEE 802.11ac WiFi (20MHz, 64-QAM, 99pc duty cycle)	X	4.74	66.87	16.19	0.00	150.0	± 9.6 %
		Y	4.46	67.12	16.30		150.0	
		Z	4.66	66.49	15.82		150.0	
10401-AAC	IEEE 802.11ac WiFi (40MHz, 64-QAM, 99pc duty cycle)	X	5.42	67.04	16.34	0.00	150.0	± 9.6 %
		Y	5.12	66.91	16.31		150.0	
		Z	5.35	66.74	16.04		150.0	

10402-AAC	IEEE 802.11ac WiFi (80MHz, 64-QAM, 99pc duty cycle)	X	5.69	67.43	16.39	0.00	150.0	± 9.6 %
		Y	5.46	67.44	16.46		150.0	
		Z	5.61	67.12	16.09		150.0	
10403-AAB	CDMA2000 (1xEV-DO, Rev. 0)	X	1.45	68.11	13.95	0.00	115.0	± 9.6 %
		Y	1.04	66.23	11.42		115.0	
		Z	1.16	64.74	11.79		115.0	
10404-AAB	CDMA2000 (1xEV-DO, Rev. A)	X	1.45	68.11	13.95	0.00	115.0	± 9.6 %
		Y	1.04	66.23	11.42		115.0	
		Z	1.16	64.74	11.79		115.0	
10406-AAB	CDMA2000, RC3, SO32, SCH0, Full Rate	X	93.39	124.85	32.36	0.00	100.0	± 9.6 %
		Y	100.00	121.95	29.73		100.0	
		Z	15.83	96.62	24.47		100.0	
10410-AAC	LTE-TDD (SC-FDMA, 1 RB, 10 MHz, QPSK, UL Subframe=2,3,4,7,8,9)	X	100.00	125.09	32.32	3.23	80.0	± 9.6 %
		Y	100.00	132.61	34.49		80.0	
		Z	100.00	123.35	31.39		80.0	
10415-AAA	IEEE 802.11b WiFi 2.4 GHz (DSSS, 1 Mbps, 99pc duty cycle)	X	1.01	62.61	14.33	0.00	150.0	± 9.6 %
		Y	0.99	63.47	14.91		150.0	
		Z	0.96	61.45	13.07		150.0	
10416-AAA	IEEE 802.11g WiFi 2.4 GHz (ERP-OFDM, 6 Mbps, 99pc duty cycle)	X	4.57	66.53	16.14	0.00	150.0	± 9.6 %
		Y	4.35	66.84	16.25		150.0	
		Z	4.50	66.15	15.77		150.0	
10417-AAA	IEEE 802.11a/h WiFi 5 GHz (OFDM, 6 Mbps, 99pc duty cycle)	X	4.57	66.53	16.14	0.00	150.0	± 9.6 %
		Y	4.35	66.84	16.25		150.0	
		Z	4.50	66.15	15.77		150.0	
10418-AAA	IEEE 802.11g WiFi 2.4 GHz (DSSS-OFDM, 6 Mbps, 99pc duty cycle, Long preamble)	X	4.56	66.67	16.15	0.00	150.0	± 9.6 %
		Y	4.35	67.06	16.31		150.0	
		Z	4.48	66.28	15.77		150.0	
10419-AAA	IEEE 802.11g WiFi 2.4 GHz (DSSS-OFDM, 6 Mbps, 99pc duty cycle, Short preamble)	X	4.58	66.63	16.16	0.00	150.0	± 9.6 %
		Y	4.36	66.98	16.29		150.0	
		Z	4.50	66.25	15.78		150.0	
10422-AAA	IEEE 802.11n (HT Greenfield, 7.2 Mbps, BPSK)	X	4.70	66.64	16.17	0.00	150.0	± 9.6 %
		Y	4.47	66.95	16.30		150.0	
		Z	4.63	66.27	15.81		150.0	
10423-AAA	IEEE 802.11n (HT Greenfield, 43.3 Mbps, 16-QAM)	X	4.88	66.97	16.30	0.00	150.0	± 9.6 %
		Y	4.59	67.21	16.39		150.0	
		Z	4.80	66.60	15.93		150.0	
10424-AAA	IEEE 802.11n (HT Greenfield, 72.2 Mbps, 64-QAM)	X	4.79	66.92	16.27	0.00	150.0	± 9.6 %
		Y	4.53	67.17	16.37		150.0	
		Z	4.71	66.54	15.90		150.0	
10425-AAA	IEEE 802.11n (HT Greenfield, 15 Mbps, BPSK)	X	5.38	67.25	16.44	0.00	150.0	± 9.6 %
		Y	5.14	67.33	16.54		150.0	
		Z	5.31	66.92	16.12		150.0	
10426-AAA	IEEE 802.11n (HT Greenfield, 90 Mbps, 16-QAM)	X	5.39	67.25	16.44	0.00	150.0	± 9.6 %
		Y	5.16	67.42	16.58		150.0	
		Z	5.31	66.92	16.12		150.0	

10427-AAA	IEEE 802.11n (HT Greenfield, 150 Mbps, 64-QAM)	X	5.40	67.24	16.44	0.00	150.0	± 9.6 %
		Y	5.12	67.21	16.47		150.0	
		Z	5.33	66.92	16.12		150.0	
10430-AAB	LTE-FDD (OFDMA, 5 MHz, E-TM 3.1)	X	4.28	70.44	18.07	0.00	150.0	± 9.6 %
		Y	4.14	71.87	18.16		150.0	
		Z	4.07	69.38	17.29		150.0	
10431-AAB	LTE-FDD (OFDMA, 10 MHz, E-TM 3.1)	X	4.26	67.04	16.14	0.00	150.0	± 9.6 %
		Y	3.97	67.47	16.15		150.0	
		Z	4.16	66.54	15.68		150.0	
10432-AAB	LTE-FDD (OFDMA, 15 MHz, E-TM 3.1)	X	4.56	66.94	16.21	0.00	150.0	± 9.6 %
		Y	4.29	67.26	16.30		150.0	
		Z	4.47	66.52	15.81		150.0	
10433-AAB	LTE-FDD (OFDMA, 20 MHz, E-TM 3.1)	X	4.81	66.95	16.29	0.00	150.0	± 9.6 %
		Y	4.54	67.20	16.39		150.0	
		Z	4.73	66.57	15.92		150.0	
10434-AAA	W-CDMA (BS Test Model 1, 64 DPCH)	X	4.37	71.26	18.05	0.00	150.0	± 9.6 %
		Y	4.23	72.71	17.94		150.0	
		Z	4.10	69.95	17.16		150.0	
10435-AAC	LTE-TDD (SC-FDMA, 1 RB, 20 MHz, QPSK, UL Subframe=2,3,4,7,8,9)	X	100.00	124.88	32.22	3.23	80.0	± 9.6 %
		Y	100.00	132.33	34.36		80.0	
		Z	100.00	123.15	31.29		80.0	
10447-AAB	LTE-FDD (OFDMA, 5 MHz, E-TM 3.1, Clipping 44%)	X	3.55	67.01	15.50	0.00	150.0	± 9.6 %
		Y	3.22	67.33	15.04		150.0	
		Z	3.42	66.26	14.87		150.0	
10448-AAB	LTE-FDD (OFDMA, 10 MHz, E-TM 3.1, Clipping 44%)	X	4.09	66.82	16.00	0.00	150.0	± 9.6 %
		Y	3.84	67.27	16.03		150.0	
		Z	4.00	66.30	15.52		150.0	
10449-AAB	LTE-FDD (OFDMA, 15 MHz, E-TM 3.1, Clipping 44%)	X	4.36	66.77	16.11	0.00	150.0	± 9.6 %
		Y	4.13	67.11	16.20		150.0	
		Z	4.28	66.32	15.69		150.0	
10450-AAB	LTE-FDD (OFDMA, 20 MHz, E-TM 3.1, Clipping 44%)	X	4.56	66.71	16.14	0.00	150.0	± 9.6 %
		Y	4.34	66.98	16.25		150.0	
		Z	4.48	66.31	15.75		150.0	
10451-AAA	W-CDMA (BS Test Model 1, 64 DPCH, Clipping 44%)	X	3.45	67.20	15.16	0.00	150.0	± 9.6 %
		Y	3.02	67.10	14.30		150.0	
		Z	3.30	66.32	14.46		150.0	
10456-AAA	IEEE 802.11ac WiFi (160MHz, 64-QAM, 99pc duty cycle)	X	6.24	67.82	16.61	0.00	150.0	± 9.6 %
		Y	6.06	67.84	16.69		150.0	
		Z	6.17	67.55	16.33		150.0	
10457-AAA	UMTS-FDD (DC-HSDPA)	X	3.81	65.16	15.84	0.00	150.0	± 9.6 %
		Y	3.70	65.58	15.98		150.0	
		Z	3.75	64.81	15.45		150.0	
10458-AAA	CDMA2000 (1xEV-DO, Rev. B, 2 carriers)	X	4.00	70.43	17.44	0.00	150.0	± 9.6 %
		Y	3.69	71.08	16.66		150.0	
		Z	3.75	69.12	16.52		150.0	
10459-AAA	CDMA2000 (1xEV-DO, Rev. B, 3 carriers)	X	5.12	68.09	18.07	0.00	150.0	± 9.6 %
		Y	4.73	68.62	17.62		150.0	
		Z	4.97	67.45	17.56		150.0	

10460-AAA	UMTS-FDD (WCDMA, AMR)	X	0.86	66.87	15.37	0.00	150.0	± 9.6 %
		Y	0.95	70.33	17.05		150.0	
		Z	0.72	63.56	12.85		150.0	
10461-AAA	LTE-TDD (SC-FDMA, 1 RB, 1.4 MHz, QPSK, UL Subframe=2,3,4,7,8,9)	X	100.00	130.48	34.84	3.29	80.0	± 9.6 %
		Y	100.00	140.16	37.94		80.0	
		Z	100.00	127.51	33.38		80.0	
10462-AAA	LTE-TDD (SC-FDMA, 1 RB, 1.4 MHz, 16-QAM, UL Subframe=2,3,4,7,8,9)	X	100.00	112.24	26.23	3.23	80.0	± 9.6 %
		Y	100.00	110.13	24.11		80.0	
		Z	67.10	104.99	23.84		80.0	
10463-AAA	LTE-TDD (SC-FDMA, 1 RB, 1.4 MHz, 64-QAM, UL Subframe=2,3,4,7,8,9)	X	100.00	108.27	24.36	3.23	80.0	± 9.6 %
		Y	6.18	79.22	15.32		80.0	
		Z	7.19	79.40	16.50		80.0	
10464-AAA	LTE-TDD (SC-FDMA, 1 RB, 3 MHz, QPSK, UL Subframe=2,3,4,7,8,9)	X	100.00	128.35	33.68	3.23	80.0	± 9.6 %
		Y	100.00	137.42	36.46		80.0	
		Z	100.00	125.21	32.15		80.0	
10465-AAA	LTE-TDD (SC-FDMA, 1 RB, 3 MHz, 16-QAM, UL Subframe=2,3,4,7,8,9)	X	100.00	111.56	25.90	3.23	80.0	± 9.6 %
		Y	100.00	109.13	23.66		80.0	
		Z	21.07	92.23	20.67		80.0	
10466-AAA	LTE-TDD (SC-FDMA, 1 RB, 3 MHz, 64-QAM, UL Subframe=2,3,4,7,8,9)	X	100.00	107.63	24.06	3.23	80.0	± 9.6 %
		Y	2.43	70.85	12.64		80.0	
		Z	4.66	74.87	14.99		80.0	
10467-AAC	LTE-TDD (SC-FDMA, 1 RB, 5 MHz, QPSK, UL Subframe=2,3,4,7,8,9)	X	100.00	128.63	33.81	3.23	80.0	± 9.6 %
		Y	100.00	137.88	36.66		80.0	
		Z	100.00	125.47	32.26		80.0	
10468-AAC	LTE-TDD (SC-FDMA, 1 RB, 5 MHz, 16-QAM, UL Subframe=2,3,4,7,8,9)	X	100.00	111.77	26.00	3.23	80.0	± 9.6 %
		Y	100.00	109.52	23.83		80.0	
		Z	27.11	95.03	21.41		80.0	
10469-AAC	LTE-TDD (SC-FDMA, 1 RB, 5 MHz, 64-QAM, UL Subframe=2,3,4,7,8,9)	X	100.00	107.65	24.07	3.23	80.0	± 9.6 %
		Y	2.53	71.21	12.76		80.0	
		Z	4.72	75.01	15.04		80.0	
10470-AAC	LTE-TDD (SC-FDMA, 1 RB, 10 MHz, QPSK, UL Subframe=2,3,4,7,8,9)	X	100.00	128.68	33.82	3.23	80.0	± 9.6 %
		Y	100.00	137.95	36.68		80.0	
		Z	100.00	125.51	32.27		80.0	
10471-AAC	LTE-TDD (SC-FDMA, 1 RB, 10 MHz, 16-QAM, UL Subframe=2,3,4,7,8,9)	X	100.00	111.71	25.97	3.23	80.0	± 9.6 %
		Y	100.00	109.41	23.78		80.0	
		Z	26.88	94.90	21.36		80.0	
10472-AAC	LTE-TDD (SC-FDMA, 1 RB, 10 MHz, 64-QAM, UL Subframe=2,3,4,7,8,9)	X	100.00	107.59	24.03	3.23	80.0	± 9.6 %
		Y	2.45	70.92	12.65		80.0	
		Z	4.68	74.91	14.99		80.0	
10473-AAC	LTE-TDD (SC-FDMA, 1 RB, 15 MHz, QPSK, UL Subframe=2,3,4,7,8,9)	X	100.00	128.64	33.80	3.23	80.0	± 9.6 %
		Y	100.00	137.92	36.66		80.0	
		Z	100.00	125.47	32.26		80.0	
10474-AAC	LTE-TDD (SC-FDMA, 1 RB, 15 MHz, 16-QAM, UL Subframe=2,3,4,7,8,9)	X	100.00	111.72	25.97	3.23	80.0	± 9.6 %
		Y	100.00	109.42	23.78		80.0	
		Z	26.23	94.65	21.30		80.0	
10475-AAC	LTE-TDD (SC-FDMA, 1 RB, 15 MHz, 64-QAM, UL Subframe=2,3,4,7,8,9)	X	100.00	107.61	24.04	3.23	80.0	± 9.6 %
		Y	2.42	70.81	12.61		80.0	
		Z	4.63	74.81	14.96		80.0	

10477-AAC	LTE-TDD (SC-FDMA, 1 RB, 20 MHz, 16-QAM, UL Subframe=2,3,4,7,8,9)	X	100.00	111.52	25.87	3.23	80.0	± 9.6 %
		Y	100.00	109.08	23.63		80.0	
		Z	21.80	92.57	20.74		80.0	
10478-AAC	LTE-TDD (SC-FDMA, 1 RB, 20 MHz, 64-QAM, UL Subframe=2,3,4,7,8,9)	X	100.00	107.54	24.01	3.23	80.0	± 9.6 %
		Y	2.34	70.48	12.48		80.0	
		Z	4.57	74.66	14.90		80.0	
10479-AAA	LTE-TDD (SC-FDMA, 50% RB, 1.4 MHz, QPSK, UL Subframe=2,3,4,7,8,9)	X	21.05	102.62	28.79	3.23	80.0	± 9.6 %
		Y	100.00	130.18	35.05		80.0	
		Z	8.79	88.04	24.08		80.0	
10480-AAA	LTE-TDD (SC-FDMA, 50% RB, 1.4 MHz, 16-QAM, UL Subframe=2,3,4,7,8,9)	X	31.10	101.37	26.40	3.23	80.0	± 9.6 %
		Y	100.00	115.77	28.24		80.0	
		Z	10.81	85.97	21.62		80.0	
10481-AAA	LTE-TDD (SC-FDMA, 50% RB, 1.4 MHz, 64-QAM, UL Subframe=2,3,4,7,8,9)	X	23.43	96.25	24.59	3.23	80.0	± 9.6 %
		Y	100.00	112.73	26.77		80.0	
		Z	8.90	82.56	20.16		80.0	
10482-AAA	LTE-TDD (SC-FDMA, 50% RB, 3 MHz, QPSK, UL Subframe=2,3,4,7,8,9)	X	4.87	78.15	19.51	2.23	80.0	± 9.6 %
		Y	4.24	77.89	18.18		80.0	
		Z	2.92	70.65	16.24		80.0	
10483-AAA	LTE-TDD (SC-FDMA, 50% RB, 3 MHz, 16-QAM, UL Subframe=2,3,4,7,8,9)	X	10.85	86.14	22.05	2.23	80.0	± 9.6 %
		Y	5.65	77.21	17.13		80.0	
		Z	5.95	77.30	18.74		80.0	
10484-AAA	LTE-TDD (SC-FDMA, 50% RB, 3 MHz, 64-QAM, UL Subframe=2,3,4,7,8,9)	X	9.22	83.60	21.23	2.23	80.0	± 9.6 %
		Y	4.45	74.14	16.03		80.0	
		Z	5.48	75.91	18.23		80.0	
10485-AAC	LTE-TDD (SC-FDMA, 50% RB, 5 MHz, QPSK, UL Subframe=2,3,4,7,8,9)	X	4.88	78.37	20.46	2.23	80.0	± 9.6 %
		Y	4.98	81.42	21.09		80.0	
		Z	3.27	71.98	17.62		80.0	
10486-AAC	LTE-TDD (SC-FDMA, 50% RB, 5 MHz, 16-QAM, UL Subframe=2,3,4,7,8,9)	X	4.14	72.53	17.76	2.23	80.0	± 9.6 %
		Y	3.42	71.82	16.50		80.0	
		Z	3.25	68.80	15.87		80.0	
10487-AAC	LTE-TDD (SC-FDMA, 50% RB, 5 MHz, 64-QAM, UL Subframe=2,3,4,7,8,9)	X	4.09	71.98	17.52	2.23	80.0	± 9.6 %
		Y	3.30	70.93	16.10		80.0	
		Z	3.27	68.50	15.73		80.0	
10488-AAC	LTE-TDD (SC-FDMA, 50% RB, 10 MHz, QPSK, UL Subframe=2,3,4,7,8,9)	X	4.71	76.07	20.18	2.23	80.0	± 9.6 %
		Y	4.06	76.75	20.65		80.0	
		Z	3.64	71.70	18.11		80.0	
10489-AAC	LTE-TDD (SC-FDMA, 50% RB, 10 MHz, 16-QAM, UL Subframe=2,3,4,7,8,9)	X	4.12	71.10	18.27	2.23	80.0	± 9.6 %
		Y	3.59	71.27	18.18		80.0	
		Z	3.59	68.70	16.94		80.0	
10490-AAC	LTE-TDD (SC-FDMA, 50% RB, 10 MHz, 64-QAM, UL Subframe=2,3,4,7,8,9)	X	4.20	70.81	18.16	2.23	80.0	± 9.6 %
		Y	3.64	70.93	18.02		80.0	
		Z	3.69	68.58	16.91		80.0	
10491-AAC	LTE-TDD (SC-FDMA, 50% RB, 15 MHz, QPSK, UL Subframe=2,3,4,7,8,9)	X	4.67	73.62	19.32	2.23	80.0	± 9.6 %
		Y	3.94	73.47	19.55		80.0	
		Z	3.91	70.58	17.78		80.0	
10492-AAC	LTE-TDD (SC-FDMA, 50% RB, 15 MHz, 16-QAM, UL Subframe=2,3,4,7,8,9)	X	4.37	69.92	18.03	2.23	80.0	± 9.6 %
		Y	3.77	69.63	17.93		80.0	
		Z	3.96	68.18	17.01		80.0	

10493-AAC	LTE-TDD (SC-FDMA, 50% RB, 15 MHz, 64-QAM, UL Subframe=2,3,4,7,8,9)	X	4.43	69.73	17.96	2.23	80.0	± 9.6 %
		Y	3.81	69.42	17.83		80.0	
		Z	4.03	68.08	16.99		80.0	
10494-AAC	LTE-TDD (SC-FDMA, 50% RB, 20 MHz, QPSK, UL Subframe=2,3,4,7,8,9)	X	5.23	75.62	19.94	2.23	80.0	± 9.6 %
		Y	4.39	75.38	20.21		80.0	
		Z	4.21	71.94	18.18		80.0	
10495-AAC	LTE-TDD (SC-FDMA, 50% RB, 20 MHz, 16-QAM, UL Subframe=2,3,4,7,8,9)	X	4.43	70.42	18.26	2.23	80.0	± 9.6 %
		Y	3.80	69.92	18.16		80.0	
		Z	3.99	68.56	17.19		80.0	
10496-AAC	LTE-TDD (SC-FDMA, 50% RB, 20 MHz, 64-QAM, UL Subframe=2,3,4,7,8,9)	X	4.49	70.03	18.13	2.23	80.0	± 9.6 %
		Y	3.85	69.57	18.02		80.0	
		Z	4.08	68.33	17.13		80.0	
10497-AAA	LTE-TDD (SC-FDMA, 100% RB, 1.4 MHz, QPSK, UL Subframe=2,3,4,7,8,9)	X	3.69	73.99	17.05	2.23	80.0	± 9.6 %
		Y	1.69	65.87	11.88		80.0	
		Z	2.22	67.13	13.87		80.0	
10498-AAA	LTE-TDD (SC-FDMA, 100% RB, 1.4 MHz, 16-QAM, UL Subframe=2,3,4,7,8,9)	X	2.44	65.88	12.63	2.23	80.0	± 9.6 %
		Y	1.16	60.00	7.66		80.0	
		Z	1.89	62.82	10.87		80.0	
10499-AAA	LTE-TDD (SC-FDMA, 100% RB, 1.4 MHz, 64-QAM, UL Subframe=2,3,4,7,8,9)	X	2.33	65.07	12.12	2.23	80.0	± 9.6 %
		Y	1.18	60.00	7.48		80.0	
		Z	1.85	62.36	10.50		80.0	
10500-AAA	LTE-TDD (SC-FDMA, 100% RB, 3 MHz, QPSK, UL Subframe=2,3,4,7,8,9)	X	4.64	76.82	20.15	2.23	80.0	± 9.6 %
		Y	4.39	78.97	20.75		80.0	
		Z	3.37	71.60	17.73		80.0	
10501-AAA	LTE-TDD (SC-FDMA, 100% RB, 3 MHz, 16-QAM, UL Subframe=2,3,4,7,8,9)	X	4.12	71.88	17.92	2.23	80.0	± 9.6 %
		Y	3.59	72.06	17.33		80.0	
		Z	3.41	68.79	16.30		80.0	
10502-AAA	LTE-TDD (SC-FDMA, 100% RB, 3 MHz, 64-QAM, UL Subframe=2,3,4,7,8,9)	X	4.17	71.65	17.77	2.23	80.0	± 9.6 %
		Y	3.59	71.67	17.07		80.0	
		Z	3.47	68.69	16.20		80.0	
10503-AAC	LTE-TDD (SC-FDMA, 100% RB, 5 MHz, QPSK, UL Subframe=2,3,4,7,8,9)	X	4.65	75.83	20.08	2.23	80.0	± 9.6 %
		Y	4.00	76.48	20.53		80.0	
		Z	3.60	71.52	18.02		80.0	
10504-AAC	LTE-TDD (SC-FDMA, 100% RB, 5 MHz, 16-QAM, UL Subframe=2,3,4,7,8,9)	X	4.10	71.00	18.21	2.23	80.0	± 9.6 %
		Y	3.56	71.15	18.11		80.0	
		Z	3.57	68.61	16.89		80.0	
10505-AAC	LTE-TDD (SC-FDMA, 100% RB, 5 MHz, 64-QAM, UL Subframe=2,3,4,7,8,9)	X	4.17	70.71	18.10	2.23	80.0	± 9.6 %
		Y	3.61	70.82	17.96		80.0	
		Z	3.67	68.49	16.86		80.0	
10506-AAC	LTE-TDD (SC-FDMA, 100% RB, 10 MHz, QPSK, UL Subframe=2,3,4,7,8,9)	X	5.18	75.44	19.86	2.23	80.0	± 9.6 %
		Y	4.34	75.20	20.13		80.0	
		Z	4.18	71.80	18.11		80.0	
10507-AAC	LTE-TDD (SC-FDMA, 100% RB, 10 MHz, 16-QAM, UL Subframe=2,3,4,7,8,9)	X	4.42	70.36	18.22	2.23	80.0	± 9.6 %
		Y	3.78	69.86	18.12		80.0	
		Z	3.98	68.50	17.15		80.0	

10508-AAC	LTE-TDD (SC-FDMA, 100% RB, 10 MHz, 64-QAM, UL Subframe=2,3,4,7,8,9)	X	4.47	69.96	18.08	2.23	80.0	± 9.6 %
		Y	3.84	69.49	17.97		80.0	
		Z	4.06	68.27	17.09		80.0	
10509-AAC	LTE-TDD (SC-FDMA, 100% RB, 15 MHz, QPSK, UL Subframe=2,3,4,7,8,9)	X	5.29	73.44	19.06	2.23	80.0	± 9.6 %
		Y	4.51	72.94	19.20		80.0	
		Z	4.55	70.83	17.74		80.0	
10510-AAC	LTE-TDD (SC-FDMA, 100% RB, 15 MHz, 16-QAM, UL Subframe=2,3,4,7,8,9)	X	4.86	69.84	18.07	2.23	80.0	± 9.6 %
		Y	4.19	69.10	17.93		80.0	
		Z	4.49	68.38	17.21		80.0	
10511-AAC	LTE-TDD (SC-FDMA, 100% RB, 15 MHz, 64-QAM, UL Subframe=2,3,4,7,8,9)	X	4.89	69.51	17.97	2.23	80.0	± 9.6 %
		Y	4.24	68.83	17.84		80.0	
		Z	4.54	68.15	17.16		80.0	
10512-AAC	LTE-TDD (SC-FDMA, 100% RB, 20 MHz, QPSK, UL Subframe=2,3,4,7,8,9)	X	5.76	75.57	19.74	2.23	80.0	± 9.6 %
		Y	4.84	74.92	19.86		80.0	
		Z	4.72	72.21	18.14		80.0	
10513-AAC	LTE-TDD (SC-FDMA, 100% RB, 20 MHz, 16-QAM, UL Subframe=2,3,4,7,8,9)	X	4.78	70.25	18.23	2.23	80.0	± 9.6 %
		Y	4.09	69.35	18.06		80.0	
		Z	4.37	68.63	17.29		80.0	
10514-AAC	LTE-TDD (SC-FDMA, 100% RB, 20 MHz, 64-QAM, UL Subframe=2,3,4,7,8,9)	X	4.76	69.71	18.06	2.23	80.0	± 9.6 %
		Y	4.10	68.87	17.89		80.0	
		Z	4.39	68.24	17.19		80.0	
10515-AAA	IEEE 802.11b WiFi 2.4 GHz (DSSS, 2 Mbps, 99pc duty cycle)	X	0.97	62.76	14.36	0.00	150.0	± 9.6 %
		Y	0.95	63.70	14.99		150.0	
		Z	0.92	61.51	13.03		150.0	
10516-AAA	IEEE 802.11b WiFi 2.4 GHz (DSSS, 5.5 Mbps, 99pc duty cycle)	X	0.54	67.78	15.81	0.00	150.0	± 9.6 %
		Y	0.74	75.39	19.60		150.0	
		Z	0.42	62.99	12.11		150.0	
10517-AAA	IEEE 802.11b WiFi 2.4 GHz (DSSS, 11 Mbps, 99pc duty cycle)	X	0.81	64.33	14.78	0.00	150.0	± 9.6 %
		Y	0.81	65.99	15.86		150.0	
		Z	0.73	62.24	12.86		150.0	
10518-AAA	IEEE 802.11a/h WiFi 5 GHz (OFDM, 9 Mbps, 99pc duty cycle)	X	4.56	66.60	16.12	0.00	150.0	± 9.6 %
		Y	4.34	66.95	16.24		150.0	
		Z	4.49	66.22	15.74		150.0	
10519-AAA	IEEE 802.11a/h WiFi 5 GHz (OFDM, 12 Mbps, 99pc duty cycle)	X	4.76	66.85	16.24	0.00	150.0	± 9.6 %
		Y	4.49	67.11	16.33		150.0	
		Z	4.68	66.47	15.87		150.0	
10520-AAA	IEEE 802.11a/h WiFi 5 GHz (OFDM, 18 Mbps, 99pc duty cycle)	X	4.61	66.81	16.16	0.00	150.0	± 9.6 %
		Y	4.34	67.05	16.25		150.0	
		Z	4.52	66.41	15.77		150.0	
10521-AAA	IEEE 802.11a/h WiFi 5 GHz (OFDM, 24 Mbps, 99pc duty cycle)	X	4.54	66.81	16.15	0.00	150.0	± 9.6 %
		Y	4.28	67.02	16.23		150.0	
		Z	4.46	66.39	15.75		150.0	
10522-AAA	IEEE 802.11a/h WiFi 5 GHz (OFDM, 36 Mbps, 99pc duty cycle)	X	4.60	66.87	16.22	0.00	150.0	± 9.6 %
		Y	4.33	67.14	16.32		150.0	
		Z	4.51	66.46	15.83		150.0	

10523-AAA	IEEE 802.11a/h WiFi 5 GHz (OFDM, 48 Mbps, 99pc duty cycle)	X	4.47	66.74	16.07	0.00	150.0	± 9.6 %
		Y	4.26	67.16	16.26		150.0	
		Z	4.39	66.32	15.67		150.0	
10524-AAA	IEEE 802.11a/h WiFi 5 GHz (OFDM, 54 Mbps, 99pc duty cycle)	X	4.54	66.79	16.19	0.00	150.0	± 9.6 %
		Y	4.28	67.11	16.32		150.0	
		Z	4.46	66.38	15.80		150.0	
10525-AAA	IEEE 802.11ac WiFi (20MHz, MCS0, 99pc duty cycle)	X	4.52	65.84	15.78	0.00	150.0	± 9.6 %
		Y	4.32	66.22	15.94		150.0	
		Z	4.43	65.43	15.39		150.0	
10526-AAA	IEEE 802.11ac WiFi (20MHz, MCS1, 99pc duty cycle)	X	4.69	66.22	15.93	0.00	150.0	± 9.6 %
		Y	4.44	66.50	16.06		150.0	
		Z	4.60	65.79	15.53		150.0	
10527-AAA	IEEE 802.11ac WiFi (20MHz, MCS2, 99pc duty cycle)	X	4.61	66.18	15.87	0.00	150.0	± 9.6 %
		Y	4.37	66.47	16.00		150.0	
		Z	4.52	65.74	15.47		150.0	
10528-AAA	IEEE 802.11ac WiFi (20MHz, MCS3, 99pc duty cycle)	X	4.63	66.19	15.90	0.00	150.0	± 9.6 %
		Y	4.38	66.49	16.03		150.0	
		Z	4.54	65.76	15.50		150.0	
10529-AAA	IEEE 802.11ac WiFi (20MHz, MCS4, 99pc duty cycle)	X	4.63	66.19	15.90	0.00	150.0	± 9.6 %
		Y	4.38	66.49	16.03		150.0	
		Z	4.54	65.76	15.50		150.0	
10531-AAA	IEEE 802.11ac WiFi (20MHz, MCS6, 99pc duty cycle)	X	4.63	66.31	15.92	0.00	150.0	± 9.6 %
		Y	4.35	66.51	16.01		150.0	
		Z	4.53	65.85	15.50		150.0	
10532-AAA	IEEE 802.11ac WiFi (20MHz, MCS7, 99pc duty cycle)	X	4.48	66.16	15.85	0.00	150.0	± 9.6 %
		Y	4.23	66.37	15.94		150.0	
		Z	4.39	65.69	15.43		150.0	
10533-AAA	IEEE 802.11ac WiFi (20MHz, MCS8, 99pc duty cycle)	X	4.64	66.23	15.89	0.00	150.0	± 9.6 %
		Y	4.39	66.57	16.04		150.0	
		Z	4.55	65.79	15.49		150.0	
10534-AAA	IEEE 802.11ac WiFi (40MHz, MCS0, 99pc duty cycle)	X	5.16	66.33	15.97	0.00	150.0	± 9.6 %
		Y	4.94	66.44	16.08		150.0	
		Z	5.08	65.97	15.63		150.0	
10535-AAA	IEEE 802.11ac WiFi (40MHz, MCS1, 99pc duty cycle)	X	5.22	66.49	16.04	0.00	150.0	± 9.6 %
		Y	4.98	66.57	16.14		150.0	
		Z	5.14	66.12	15.69		150.0	
10536-AAA	IEEE 802.11ac WiFi (40MHz, MCS2, 99pc duty cycle)	X	5.09	66.45	16.00	0.00	150.0	± 9.6 %
		Y	4.87	66.58	16.12		150.0	
		Z	5.01	66.06	15.64		150.0	
10537-AAA	IEEE 802.11ac WiFi (40MHz, MCS3, 99pc duty cycle)	X	5.15	66.42	15.99	0.00	150.0	± 9.6 %
		Y	4.94	66.57	16.12		150.0	
		Z	5.07	66.05	15.64		150.0	
10538-AAA	IEEE 802.11ac WiFi (40MHz, MCS4, 99pc duty cycle)	X	5.25	66.46	16.05	0.00	150.0	± 9.6 %
		Y	5.00	66.53	16.14		150.0	
		Z	5.16	66.09	15.71		150.0	
10540-AAA	IEEE 802.11ac WiFi (40MHz, MCS6, 99pc duty cycle)	X	5.17	66.45	16.06	0.00	150.0	± 9.6 %
		Y	4.93	66.49	16.14		150.0	
		Z	5.09	66.08	15.71		150.0	

10541-AAA	IEEE 802.11ac WiFi (40MHz, MCS7, 99pc duty cycle)	X	5.15	66.33	16.00	0.00	150.0	± 9.6 %
		Y	4.91	66.41	16.08		150.0	
		Z	5.07	65.97	15.65		150.0	
10542-AAA	IEEE 802.11ac WiFi (40MHz, MCS8, 99pc duty cycle)	X	5.30	66.40	16.05	0.00	150.0	± 9.6 %
		Y	5.07	66.50	16.14		150.0	
		Z	5.22	66.06	15.71		150.0	
10543-AAA	IEEE 802.11ac WiFi (40MHz, MCS9, 99pc duty cycle)	X	5.38	66.44	16.08	0.00	150.0	± 9.6 %
		Y	5.14	66.58	16.21		150.0	
		Z	5.30	66.10	15.76		150.0	
10544-AAA	IEEE 802.11ac WiFi (80MHz, MCS0, 99pc duty cycle)	X	5.46	66.46	15.97	0.00	150.0	± 9.6 %
		Y	5.28	66.51	16.06		150.0	
		Z	5.38	66.12	15.65		150.0	
10545-AAA	IEEE 802.11ac WiFi (80MHz, MCS1, 99pc duty cycle)	X	5.65	66.85	16.12	0.00	150.0	± 9.6 %
		Y	5.46	66.95	16.24		150.0	
		Z	5.57	66.50	15.79		150.0	
10546-AAA	IEEE 802.11ac WiFi (80MHz, MCS2, 99pc duty cycle)	X	5.53	66.68	16.05	0.00	150.0	± 9.6 %
		Y	5.31	66.63	16.09		150.0	
		Z	5.45	66.33	15.72		150.0	
10547-AAA	IEEE 802.11ac WiFi (80MHz, MCS3, 99pc duty cycle)	X	5.61	66.72	16.06	0.00	150.0	± 9.6 %
		Y	5.39	66.75	16.15		150.0	
		Z	5.52	66.37	15.73		150.0	
10548-AAA	IEEE 802.11ac WiFi (80MHz, MCS4, 99pc duty cycle)	X	5.85	67.61	16.48	0.00	150.0	± 9.6 %
		Y	5.53	67.36	16.43		150.0	
		Z	5.74	67.19	16.11		150.0	
10550-AAA	IEEE 802.11ac WiFi (80MHz, MCS6, 99pc duty cycle)	X	5.56	66.68	16.05	0.00	150.0	± 9.6 %
		Y	5.37	66.83	16.21		150.0	
		Z	5.47	66.33	15.73		150.0	
10551-AAA	IEEE 802.11ac WiFi (80MHz, MCS7, 99pc duty cycle)	X	5.56	66.73	16.04	0.00	150.0	± 9.6 %
		Y	5.31	66.60	16.05		150.0	
		Z	5.48	66.38	15.72		150.0	
10552-AAA	IEEE 802.11ac WiFi (80MHz, MCS8, 99pc duty cycle)	X	5.48	66.53	15.95	0.00	150.0	± 9.6 %
		Y	5.29	66.63	16.07		150.0	
		Z	5.40	66.19	15.63		150.0	
10553-AAA	IEEE 802.11ac WiFi (80MHz, MCS9, 99pc duty cycle)	X	5.57	66.58	16.01	0.00	150.0	± 9.6 %
		Y	5.34	66.57	16.07		150.0	
		Z	5.49	66.24	15.69		150.0	
10554-AAB	IEEE 802.11ac WiFi (160MHz, MCS0, 99pc duty cycle)	X	5.86	66.83	16.07	0.00	150.0	± 9.6 %
		Y	5.70	66.84	16.14		150.0	
		Z	5.79	66.51	15.76		150.0	
10555-AAB	IEEE 802.11ac WiFi (160MHz, MCS1, 99pc duty cycle)	X	5.99	67.12	16.19	0.00	150.0	± 9.6 %
		Y	5.79	67.06	16.23		150.0	
		Z	5.91	66.79	15.88		150.0	
10556-AAB	IEEE 802.11ac WiFi (160MHz, MCS2, 99pc duty cycle)	X	6.01	67.16	16.20	0.00	150.0	± 9.6 %
		Y	5.83	67.17	16.28		150.0	
		Z	5.93	66.83	15.90		150.0	
10557-AAB	IEEE 802.11ac WiFi (160MHz, MCS3, 99pc duty cycle)	X	5.98	67.09	16.19	0.00	150.0	± 9.6 %
		Y	5.79	67.04	16.23		150.0	
		Z	5.90	66.76	15.88		150.0	

10558-AAB	IEEE 802.11ac WiFi (160MHz, MCS4, 99pc duty cycle)	X	6.03	67.25	16.28	0.00	150.0	± 9.6 %
		Y	5.80	67.10	16.28		150.0	
		Z	5.95	66.91	15.97		150.0	
10560-AAB	IEEE 802.11ac WiFi (160MHz, MCS6, 99pc duty cycle)	X	6.03	67.11	16.25	0.00	150.0	± 9.6 %
		Y	5.82	67.03	16.28		150.0	
		Z	5.95	66.79	15.95		150.0	
10561-AAB	IEEE 802.11ac WiFi (160MHz, MCS7, 99pc duty cycle)	X	5.95	67.06	16.26	0.00	150.0	± 9.6 %
		Y	5.75	67.02	16.31		150.0	
		Z	5.87	66.74	15.96		150.0	
10562-AAB	IEEE 802.11ac WiFi (160MHz, MCS8, 99pc duty cycle)	X	6.08	67.46	16.46	0.00	150.0	± 9.6 %
		Y	5.80	67.18	16.39		150.0	
		Z	5.99	67.10	16.14		150.0	
10563-AAB	IEEE 802.11ac WiFi (160MHz, MCS9, 99pc duty cycle)	X	6.37	67.91	16.64	0.00	150.0	± 9.6 %
		Y	5.90	67.15	16.34		150.0	
		Z	6.25	67.49	16.29		150.0	
10564-AAA	IEEE 802.11g WiFi 2.4 GHz (DSSS-OFDM, 9 Mbps, 99pc duty cycle)	X	4.89	66.71	16.30	0.46	150.0	± 9.6 %
		Y	4.66	66.99	16.40		150.0	
		Z	4.82	66.37	15.96		150.0	
10565-AAA	IEEE 802.11g WiFi 2.4 GHz (DSSS-OFDM, 12 Mbps, 99pc duty cycle)	X	5.13	67.16	16.62	0.46	150.0	± 9.6 %
		Y	4.85	67.38	16.70		150.0	
		Z	5.06	66.82	16.28		150.0	
10566-AAA	IEEE 802.11g WiFi 2.4 GHz (DSSS-OFDM, 18 Mbps, 99pc duty cycle)	X	4.96	67.01	16.44	0.46	150.0	± 9.6 %
		Y	4.69	67.21	16.51		150.0	
		Z	4.89	66.65	16.09		150.0	
10567-AAA	IEEE 802.11g WiFi 2.4 GHz (DSSS-OFDM, 24 Mbps, 99pc duty cycle)	X	4.99	67.40	16.79	0.46	150.0	± 9.6 %
		Y	4.72	67.59	16.87		150.0	
		Z	4.91	67.01	16.42		150.0	
10568-AAA	IEEE 802.11g WiFi 2.4 GHz (DSSS-OFDM, 36 Mbps, 99pc duty cycle)	X	4.88	66.78	16.21	0.46	150.0	± 9.6 %
		Y	4.59	66.97	16.28		150.0	
		Z	4.80	66.43	15.86		150.0	
10569-AAA	IEEE 802.11g WiFi 2.4 GHz (DSSS-OFDM, 48 Mbps, 99pc duty cycle)	X	4.94	67.48	16.84	0.46	150.0	± 9.6 %
		Y	4.72	67.83	17.02		150.0	
		Z	4.86	67.08	16.47		150.0	
10570-AAA	IEEE 802.11g WiFi 2.4 GHz (DSSS-OFDM, 54 Mbps, 99pc duty cycle)	X	4.98	67.32	16.77	0.46	150.0	± 9.6 %
		Y	4.71	67.60	16.90		150.0	
		Z	4.90	66.95	16.41		150.0	
10571-AAA	IEEE 802.11b WiFi 2.4 GHz (DSSS, 1 Mbps, 90pc duty cycle)	X	1.22	64.72	15.64	0.46	130.0	± 9.6 %
		Y	1.15	65.06	16.01		130.0	
		Z	1.14	63.13	14.22		130.0	
10572-AAA	IEEE 802.11b WiFi 2.4 GHz (DSSS, 2 Mbps, 90pc duty cycle)	X	1.24	65.31	16.00	0.46	130.0	± 9.6 %
		Y	1.16	65.69	16.41		130.0	
		Z	1.15	63.54	14.48		130.0	
10573-AAA	IEEE 802.11b WiFi 2.4 GHz (DSSS, 5.5 Mbps, 90pc duty cycle)	X	2.25	65.40	22.87	0.46	130.0	± 9.6 %
		Y	6.32	106.96	30.28		130.0	
		Z	0.93	70.33	16.00		130.0	
10574-AAA	IEEE 802.11b WiFi 2.4 GHz (DSSS, 11 Mbps, 90pc duty cycle)	X	1.38	71.07	18.84	0.46	130.0	± 9.6 %
		Y	1.33	72.52	19.89		130.0	
		Z	1.13	66.91	16.12		130.0	

10575-AAA	IEEE 802.11g WiFi 2.4 GHz (DSSS-OFDM, 6 Mbps, 90pc duty cycle)	X	4.69	66.54	16.38	0.46	130.0	± 9.6 %
		Y	4.45	66.81	16.47		130.0	
		Z	4.62	66.19	16.03		130.0	
10576-AAA	IEEE 802.11g WiFi 2.4 GHz (DSSS-OFDM, 9 Mbps, 90pc duty cycle)	X	4.72	66.70	16.45	0.46	130.0	± 9.6 %
		Y	4.48	67.01	16.55		130.0	
		Z	4.64	66.34	16.08		130.0	
10577-AAA	IEEE 802.11g WiFi 2.4 GHz (DSSS-OFDM, 12 Mbps, 90pc duty cycle)	X	4.93	67.00	16.62	0.46	130.0	± 9.6 %
		Y	4.64	67.23	16.69		130.0	
		Z	4.85	66.64	16.26		130.0	
10578-AAA	IEEE 802.11g WiFi 2.4 GHz (DSSS-OFDM, 18 Mbps, 90pc duty cycle)	X	4.82	67.16	16.72	0.46	130.0	± 9.6 %
		Y	4.55	67.37	16.79		130.0	
		Z	4.74	66.77	16.34		130.0	
10579-AAA	IEEE 802.11g WiFi 2.4 GHz (DSSS-OFDM, 24 Mbps, 90pc duty cycle)	X	4.59	66.46	16.04	0.46	130.0	± 9.6 %
		Y	4.31	66.60	16.08		130.0	
		Z	4.51	66.09	15.67		130.0	
10580-AAA	IEEE 802.11g WiFi 2.4 GHz (DSSS-OFDM, 36 Mbps, 90pc duty cycle)	X	4.64	66.48	16.06	0.46	130.0	± 9.6 %
		Y	4.34	66.67	16.11		130.0	
		Z	4.56	66.12	15.70		130.0	
10581-AAA	IEEE 802.11g WiFi 2.4 GHz (DSSS-OFDM, 48 Mbps, 90pc duty cycle)	X	4.72	67.20	16.66	0.46	130.0	± 9.6 %
		Y	4.46	67.48	16.79		130.0	
		Z	4.64	66.79	16.27		130.0	
10582-AAA	IEEE 802.11g WiFi 2.4 GHz (DSSS-OFDM, 54 Mbps, 90pc duty cycle)	X	4.54	66.22	15.83	0.46	130.0	± 9.6 %
		Y	4.24	66.38	15.88		130.0	
		Z	4.46	65.86	15.47		130.0	
10583-AAA	IEEE 802.11a/h WiFi 5 GHz (OFDM, 6 Mbps, 90pc duty cycle)	X	4.69	66.54	16.38	0.46	130.0	± 9.6 %
		Y	4.45	66.81	16.47		130.0	
		Z	4.62	66.19	16.03		130.0	
10584-AAA	IEEE 802.11a/h WiFi 5 GHz (OFDM, 9 Mbps, 90pc duty cycle)	X	4.72	66.70	16.45	0.46	130.0	± 9.6 %
		Y	4.48	67.01	16.55		130.0	
		Z	4.64	66.34	16.08		130.0	
10585-AAA	IEEE 802.11a/h WiFi 5 GHz (OFDM, 12 Mbps, 90pc duty cycle)	X	4.93	67.00	16.62	0.46	130.0	± 9.6 %
		Y	4.64	67.23	16.69		130.0	
		Z	4.85	66.64	16.26		130.0	
10586-AAA	IEEE 802.11a/h WiFi 5 GHz (OFDM, 18 Mbps, 90pc duty cycle)	X	4.82	67.16	16.72	0.46	130.0	± 9.6 %
		Y	4.55	67.37	16.79		130.0	
		Z	4.74	66.77	16.34		130.0	
10587-AAA	IEEE 802.11a/h WiFi 5 GHz (OFDM, 24 Mbps, 90pc duty cycle)	X	4.59	66.46	16.04	0.46	130.0	± 9.6 %
		Y	4.31	66.60	16.08		130.0	
		Z	4.51	66.09	15.67		130.0	
10588-AAA	IEEE 802.11a/h WiFi 5 GHz (OFDM, 36 Mbps, 90pc duty cycle)	X	4.64	66.48	16.06	0.46	130.0	± 9.6 %
		Y	4.34	66.67	16.11		130.0	
		Z	4.56	66.12	15.70		130.0	
10589-AAA	IEEE 802.11a/h WiFi 5 GHz (OFDM, 48 Mbps, 90pc duty cycle)	X	4.72	67.20	16.66	0.46	130.0	± 9.6 %
		Y	4.46	67.48	16.79		130.0	
		Z	4.64	66.79	16.27		130.0	
10590-AAA	IEEE 802.11a/h WiFi 5 GHz (OFDM, 54 Mbps, 90pc duty cycle)	X	4.54	66.22	15.83	0.46	130.0	± 9.6 %
		Y	4.24	66.38	15.88		130.0	
		Z	4.46	65.86	15.47		130.0	

10591-AAA	IEEE 802.11n (HT Mixed, 20MHz, MCS0, 90pc duty cycle)	X	4.84	66.60	16.48	0.46	130.0	± 9.6 %
		Y	4.61	66.88	16.58		130.0	
		Z	4.78	66.27	16.14		130.0	
10592-AAA	IEEE 802.11n (HT Mixed, 20MHz, MCS1, 90pc duty cycle)	X	5.00	66.94	16.61	0.46	130.0	± 9.6 %
		Y	4.72	67.17	16.70		130.0	
		Z	4.93	66.60	16.27		130.0	
10593-AAA	IEEE 802.11n (HT Mixed, 20MHz, MCS2, 90pc duty cycle)	X	4.92	66.86	16.50	0.46	130.0	± 9.6 %
		Y	4.64	67.05	16.57		130.0	
		Z	4.85	66.51	16.15		130.0	
10594-AAA	IEEE 802.11n (HT Mixed, 20MHz, MCS3, 90pc duty cycle)	X	4.98	67.02	16.65	0.46	130.0	± 9.6 %
		Y	4.70	67.22	16.73		130.0	
		Z	4.90	66.67	16.30		130.0	
10595-AAA	IEEE 802.11n (HT Mixed, 20MHz, MCS4, 90pc duty cycle)	X	4.95	66.98	16.55	0.46	130.0	± 9.6 %
		Y	4.67	67.21	16.65		130.0	
		Z	4.87	66.62	16.20		130.0	
10596-AAA	IEEE 802.11n (HT Mixed, 20MHz, MCS5, 90pc duty cycle)	X	4.88	66.97	16.55	0.46	130.0	± 9.6 %
		Y	4.60	67.18	16.64		130.0	
		Z	4.81	66.61	16.19		130.0	
10597-AAA	IEEE 802.11n (HT Mixed, 20MHz, MCS6, 90pc duty cycle)	X	4.83	66.88	16.44	0.46	130.0	± 9.6 %
		Y	4.55	67.05	16.50		130.0	
		Z	4.76	66.51	16.08		130.0	
10598-AAA	IEEE 802.11n (HT Mixed, 20MHz, MCS7, 90pc duty cycle)	X	4.82	67.12	16.70	0.46	130.0	± 9.6 %
		Y	4.54	67.27	16.75		130.0	
		Z	4.73	66.73	16.32		130.0	
10599-AAA	IEEE 802.11n (HT Mixed, 40MHz, MCS0, 90pc duty cycle)	X	5.50	67.15	16.68	0.46	130.0	± 9.6 %
		Y	5.28	67.31	16.81		130.0	
		Z	5.44	66.86	16.38		130.0	
10600-AAA	IEEE 802.11n (HT Mixed, 40MHz, MCS1, 90pc duty cycle)	X	5.64	67.56	16.86	0.46	130.0	± 9.6 %
		Y	5.38	67.66	16.96		130.0	
		Z	5.56	67.23	16.54		130.0	
10601-AAA	IEEE 802.11n (HT Mixed, 40MHz, MCS2, 90pc duty cycle)	X	5.53	67.32	16.75	0.46	130.0	± 9.6 %
		Y	5.29	67.45	16.87		130.0	
		Z	5.46	67.01	16.44		130.0	
10602-AAA	IEEE 802.11n (HT Mixed, 40MHz, MCS3, 90pc duty cycle)	X	5.62	67.31	16.67	0.46	130.0	± 9.6 %
		Y	5.38	67.49	16.81		130.0	
		Z	5.55	67.02	16.37		130.0	
10603-AAA	IEEE 802.11n (HT Mixed, 40MHz, MCS4, 90pc duty cycle)	X	5.71	67.66	16.97	0.46	130.0	± 9.6 %
		Y	5.45	67.77	17.09		130.0	
		Z	5.64	67.34	16.66		130.0	
10604-AAA	IEEE 802.11n (HT Mixed, 40MHz, MCS5, 90pc duty cycle)	X	5.51	67.11	16.68	0.46	130.0	± 9.6 %
		Y	5.33	67.40	16.88		130.0	
		Z	5.44	66.82	16.39		130.0	
10605-AAA	IEEE 802.11n (HT Mixed, 40MHz, MCS6, 90pc duty cycle)	X	5.62	67.42	16.84	0.46	130.0	± 9.6 %
		Y	5.37	67.54	16.95		130.0	
		Z	5.55	67.12	16.53		130.0	
10606-AAA	IEEE 802.11n (HT Mixed, 40MHz, MCS7, 90pc duty cycle)	X	5.39	66.86	16.42	0.46	130.0	± 9.6 %
		Y	5.16	66.99	16.54		130.0	
		Z	5.32	66.55	16.12		130.0	

10607-AAA	IEEE 802.11ac WiFi (20MHz, MCS0, 90pc duty cycle)	X	4.68	65.91	16.10	0.46	130.0	± 9.6 %
		Y	4.46	66.25	16.24		130.0	
		Z	4.60	65.53	15.73		130.0	
10608-AAA	IEEE 802.11ac WiFi (20MHz, MCS1, 90pc duty cycle)	X	4.87	66.32	16.26	0.46	130.0	± 9.6 %
		Y	4.60	66.58	16.39		130.0	
		Z	4.78	65.92	15.89		130.0	
10609-AAA	IEEE 802.11ac WiFi (20MHz, MCS2, 90pc duty cycle)	X	4.76	66.17	16.11	0.46	130.0	± 9.6 %
		Y	4.50	66.43	16.22		130.0	
		Z	4.67	65.77	15.73		130.0	
10610-AAA	IEEE 802.11ac WiFi (20MHz, MCS3, 90pc duty cycle)	X	4.81	66.33	16.27	0.46	130.0	± 9.6 %
		Y	4.55	66.59	16.38		130.0	
		Z	4.72	65.92	15.89		130.0	
10611-AAA	IEEE 802.11ac WiFi (20MHz, MCS4, 90pc duty cycle)	X	4.73	66.14	16.12	0.46	130.0	± 9.6 %
		Y	4.46	66.39	16.23		130.0	
		Z	4.64	65.73	15.74		130.0	
10612-AAA	IEEE 802.11ac WiFi (20MHz, MCS5, 90pc duty cycle)	X	4.74	66.29	16.16	0.46	130.0	± 9.6 %
		Y	4.45	66.53	16.28		130.0	
		Z	4.65	65.87	15.77		130.0	
10613-AAA	IEEE 802.11ac WiFi (20MHz, MCS6, 90pc duty cycle)	X	4.74	66.18	16.05	0.46	130.0	± 9.6 %
		Y	4.45	66.34	16.12		130.0	
		Z	4.65	65.77	15.67		130.0	
10614-AAA	IEEE 802.11ac WiFi (20MHz, MCS7, 90pc duty cycle)	X	4.68	66.37	16.28	0.46	130.0	± 9.6 %
		Y	4.41	66.56	16.36		130.0	
		Z	4.59	65.93	15.88		130.0	
10615-AAA	IEEE 802.11ac WiFi (20MHz, MCS8, 90pc duty cycle)	X	4.73	65.97	15.90	0.46	130.0	± 9.6 %
		Y	4.46	66.25	16.01		130.0	
		Z	4.64	65.58	15.63		130.0	
10616-AAA	IEEE 802.11ac WiFi (40MHz, MCS0, 90pc duty cycle)	X	5.33	66.42	16.30	0.46	130.0	± 9.6 %
		Y	5.09	66.51	16.39		130.0	
		Z	5.25	66.08	15.97		130.0	
10617-AAA	IEEE 802.11ac WiFi (40MHz, MCS1, 90pc duty cycle)	X	5.39	66.56	16.34	0.46	130.0	± 9.6 %
		Y	5.13	66.64	16.44		130.0	
		Z	5.31	66.22	16.01		130.0	
10618-AAA	IEEE 802.11ac WiFi (40MHz, MCS2, 90pc duty cycle)	X	5.28	66.59	16.37	0.46	130.0	± 9.6 %
		Y	5.05	66.71	16.49		130.0	
		Z	5.19	66.23	16.03		130.0	
10619-AAA	IEEE 802.11ac WiFi (40MHz, MCS3, 90pc duty cycle)	X	5.30	66.41	16.22	0.46	130.0	± 9.6 %
		Y	5.07	66.54	16.34		130.0	
		Z	5.22	66.06	15.88		130.0	
10620-AAA	IEEE 802.11ac WiFi (40MHz, MCS4, 90pc duty cycle)	X	5.39	66.47	16.30	0.46	130.0	± 9.6 %
		Y	5.14	66.53	16.38		130.0	
		Z	5.32	66.13	15.97		130.0	
10621-AAA	IEEE 802.11ac WiFi (40MHz, MCS5, 90pc duty cycle)	X	5.39	66.57	16.46	0.46	130.0	± 9.6 %
		Y	5.14	66.62	16.54		130.0	
		Z	5.31	66.23	16.14		130.0	
10622-AAA	IEEE 802.11ac WiFi (40MHz, MCS6, 90pc duty cycle)	X	5.39	66.72	16.53	0.46	130.0	± 9.6 %
		Y	5.13	66.72	16.59		130.0	
		Z	5.31	66.37	16.19		130.0	

10623-AAA	IEEE 802.11ac WiFi (40MHz, MCS7, 90pc duty cycle)	X	5.27	66.26	16.18	0.46	130.0	± 9.6 %
		Y	5.02	66.29	16.24		130.0	
		Z	5.20	65.93	15.86		130.0	
10624-AAA	IEEE 802.11ac WiFi (40MHz, MCS8, 90pc duty cycle)	X	5.47	66.46	16.34	0.46	130.0	± 9.6 %
		Y	5.22	66.54	16.42		130.0	
		Z	5.39	66.14	16.03		130.0	
10625-AAA	IEEE 802.11ac WiFi (40MHz, MCS9, 90pc duty cycle)	X	5.84	67.45	16.88	0.46	130.0	± 9.6 %
		Y	5.30	66.86	16.55		130.0	
		Z	5.75	67.07	16.54		130.0	
10626-AAA	IEEE 802.11ac WiFi (80MHz, MCS0, 90pc duty cycle)	X	5.61	66.48	16.25	0.46	130.0	± 9.6 %
		Y	5.42	66.52	16.34		130.0	
		Z	5.54	66.18	15.95		130.0	
10627-AAA	IEEE 802.11ac WiFi (80MHz, MCS1, 90pc duty cycle)	X	5.85	67.01	16.48	0.46	130.0	± 9.6 %
		Y	5.65	67.12	16.61		130.0	
		Z	5.77	66.68	16.17		130.0	
10628-AAA	IEEE 802.11ac WiFi (80MHz, MCS2, 90pc duty cycle)	X	5.65	66.59	16.21	0.46	130.0	± 9.6 %
		Y	5.42	66.51	16.24		130.0	
		Z	5.58	66.27	15.90		130.0	
10629-AAA	IEEE 802.11ac WiFi (80MHz, MCS3, 90pc duty cycle)	X	5.74	66.69	16.24	0.46	130.0	± 9.6 %
		Y	5.52	66.70	16.33		130.0	
		Z	5.66	66.36	15.94		130.0	
10630-AAA	IEEE 802.11ac WiFi (80MHz, MCS4, 90pc duty cycle)	X	6.17	68.13	16.97	0.46	130.0	± 9.6 %
		Y	5.75	67.80	16.79		130.0	
		Z	6.05	67.69	16.60		130.0	
10631-AAA	IEEE 802.11ac WiFi (80MHz, MCS5, 90pc duty cycle)	X	6.08	67.96	17.07	0.46	130.0	± 9.6 %
		Y	5.72	67.60	16.96		130.0	
		Z	5.97	67.56	16.72		130.0	
10632-AAA	IEEE 802.11ac WiFi (80MHz, MCS6, 90pc duty cycle)	X	5.82	67.08	16.65	0.46	130.0	± 9.6 %
		Y	5.65	67.28	16.83		130.0	
		Z	5.74	66.75	16.33		130.0	
10633-AAA	IEEE 802.11ac WiFi (80MHz, MCS7, 90pc duty cycle)	X	5.72	66.76	16.32	0.46	130.0	± 9.6 %
		Y	5.45	66.59	16.31		130.0	
		Z	5.64	66.44	16.01		130.0	
10634-AAA	IEEE 802.11ac WiFi (80MHz, MCS8, 90pc duty cycle)	X	5.70	66.79	16.39	0.46	130.0	± 9.6 %
		Y	5.47	66.77	16.45		130.0	
		Z	5.63	66.46	16.08		130.0	
10635-AAA	IEEE 802.11ac WiFi (80MHz, MCS9, 90pc duty cycle)	X	5.59	66.14	15.80	0.46	130.0	± 9.6 %
		Y	5.34	66.06	15.83		130.0	
		Z	5.52	65.85	15.51		130.0	
10636-AAB	IEEE 802.11ac WiFi (160MHz, MCS0, 90pc duty cycle)	X	6.02	66.86	16.35	0.46	130.0	± 9.6 %
		Y	5.86	66.86	16.41		130.0	
		Z	5.95	66.56	16.06		130.0	
10637-AAB	IEEE 802.11ac WiFi (160MHz, MCS1, 90pc duty cycle)	X	6.17	67.22	16.51	0.46	130.0	± 9.6 %
		Y	5.97	67.16	16.55		130.0	
		Z	6.10	66.91	16.22		130.0	
10638-AAB	IEEE 802.11ac WiFi (160MHz, MCS2, 90pc duty cycle)	X	6.18	67.20	16.48	0.46	130.0	± 9.6 %
		Y	6.00	67.24	16.57		130.0	
		Z	6.10	66.90	16.19		130.0	

10639-AAB	IEEE 802.11ac WiFi (160MHz, MCS3, 90pc duty cycle)	X	6.16	67.17	16.51	0.46	130.0	± 9.6 %
		Y	5.95	67.10	16.54		130.0	
		Z	6.08	66.87	16.22		130.0	
10640-AAB	IEEE 802.11ac WiFi (160MHz, MCS4, 90pc duty cycle)	X	6.17	67.19	16.46	0.46	130.0	± 9.6 %
		Y	5.92	67.01	16.44		130.0	
		Z	6.09	66.88	16.17		130.0	
10641-AAB	IEEE 802.11ac WiFi (160MHz, MCS5, 90pc duty cycle)	X	6.20	67.05	16.41	0.46	130.0	± 9.6 %
		Y	6.01	67.09	16.50		130.0	
		Z	6.13	66.77	16.13		130.0	
10642-AAB	IEEE 802.11ac WiFi (160MHz, MCS6, 90pc duty cycle)	X	6.25	67.34	16.72	0.46	130.0	± 9.6 %
		Y	6.03	67.26	16.75		130.0	
		Z	6.18	67.04	16.43		130.0	
10643-AAB	IEEE 802.11ac WiFi (160MHz, MCS7, 90pc duty cycle)	X	6.08	67.01	16.45	0.46	130.0	± 9.6 %
		Y	5.88	66.98	16.51		130.0	
		Z	6.01	66.71	16.17		130.0	
10644-AAB	IEEE 802.11ac WiFi (160MHz, MCS8, 90pc duty cycle)	X	6.26	67.55	16.75	0.46	130.0	± 9.6 %
		Y	5.94	67.16	16.62		130.0	
		Z	6.17	67.22	16.44		130.0	
10645-AAB	IEEE 802.11ac WiFi (160MHz, MCS9, 90pc duty cycle)	X	6.68	68.35	17.09	0.46	130.0	± 9.6 %
		Y	6.07	67.21	16.61		130.0	
		Z	6.55	67.93	16.75		130.0	
10646-AAD	LTE-TDD (SC-FDMA, 1 RB, 5 MHz, QPSK, UL Subframe=2,7)	X	50.85	132.52	44.24	9.30	60.0	± 9.6 %
		Y	20.70	121.95	43.56		60.0	
		Z	29.84	120.12	40.73		60.0	
10647-AAC	LTE-TDD (SC-FDMA, 1 RB, 20 MHz, QPSK, UL Subframe=2,7)	X	42.76	129.31	43.55	9.30	60.0	± 9.6 %
		Y	15.62	115.37	41.74		60.0	
		Z	25.56	117.23	40.05		60.0	
10648-AAA	CDMA2000 (1x Advanced)	X	0.70	63.25	10.84	0.00	150.0	± 9.6 %
		Y	0.49	61.73	8.31		150.0	
		Z	0.62	61.44	9.27		150.0	
10652-AAB	LTE-TDD (OFDMA, 5 MHz, E-TM 3.1, Clipping 44%)	X	3.96	67.79	17.06	2.23	80.0	± 9.6 %
		Y	3.56	66.00	16.93		80.0	
		Z	3.68	66.46	16.20		80.0	
10653-AAB	LTE-TDD (OFDMA, 10 MHz, E-TM 3.1, Clipping 44%)	X	4.44	66.99	17.10	2.23	80.0	± 9.6 %
		Y	4.02	66.80	16.97		80.0	
		Z	4.23	66.09	16.47		80.0	
10654-AAB	LTE-TDD (OFDMA, 15 MHz, E-TM 3.1, Clipping 44%)	X	4.40	66.63	17.09	2.23	80.0	± 9.6 %
		Y	4.01	66.32	16.96		80.0	
		Z	4.21	65.79	16.49		80.0	
10655-AAB	LTE-TDD (OFDMA, 20 MHz, E-TM 3.1, Clipping 44%)	X	4.45	66.63	17.12	2.23	80.0	± 9.6 %
		Y	4.08	66.20	16.98		80.0	
		Z	4.27	65.81	16.53		80.0	

⁶ Uncertainty is determined using the max. deviation from linear response applying rectangular distribution and is expressed for the square of the field value.