



FCC TEST REPORT (BLUETOOTH)

REPORT NO.: RF120309C35-3
MODEL NO.: FZ-A1BDAAAAM
FCC ID: ACJ9TGFZ-A13
RECEIVED: Dec. 21, 2011
TESTED: Mar. 02 ~ Mar. 22, 2012 and
May 24, 2012
ISSUED: May 31, 2012

APPLICANT: Panasonic Corporation of North America

ADDRESS: One Panasonic Way, 4B-8 Secaucus, NJ 07094

ISSUED BY: Bureau Veritas Consumer Products Services
(H.K.) Ltd., Taoyuan Branch

LAB ADDRESS: No. 47, 14th Ling, Chia Pau Vil., Lin Kou Dist.,
New Taipei City, Taiwan (R.O.C)

TEST LOCATION: No. 19, Hwa Ya 2nd Rd, Wen Hwa Tsuen,
Kwei Shan Hsiang, Taoyuan Hsien 333,
Taiwan, R.O.C.

This report should not be used by the client to claim product certification, approval, or endorsement by TAF or any government agencies.



This report is for your exclusive use. Any copying or replication of this report to or for any other person or entity, or use of our name or trademark, is permitted only with our prior written permission. This report sets forth our findings solely with respect to the test samples identified herein. The results set forth in this report are not indicative or representative of the quality or characteristics of the lot from which a test sample was taken or any similar or identical product unless specifically and expressly noted. Our report includes all of the tests requested by you and the results thereof based upon the information that you provided to us. You have 60 days from date of issuance of this report to notify us of any material error or omission caused by our negligence, provided, however, that such notice shall be in writing and shall specifically address the issue you wish to raise. A failure to raise such issue within the prescribed time shall constitute your unqualified acceptance of the completeness of this report, the tests conducted and the correctness of the report contents. Unless specific mention, the uncertainty of measurement has been explicitly taken into account to declare the compliance or non-compliance to the specification

Table of Contents

RELEASE CONTROL RECORD	4
1. CERTIFICATION.....	5
2. SUMMARY OF TEST RESULTS.....	6
2.1 MEASUREMENT UNCERTAINTY	6
3. GENERAL INFORMATION	7
3.1 GENERAL DESCRIPTION OF EUT.....	7
3.2 DESCRIPTION OF TEST MODES.....	8
3.2.1 CONFIGURATION OF SYSTEM UNDER TEST	11
3.2.2 TEST MODE APPLICABILITY AND TESTED CHANNEL DETAIL.....	9
3.3 GENERAL DESCRIPTION OF APPLIED STANDARDS.....	11
3.4 DESCRIPTION OF SUPPORT UNITS	11
4. TEST TYPES AND RESULTS.....	12
4.1 RADIATED EMISSION MEASUREMENT	12
4.1.1 LIMITS OF RADIATED EMISSION AND BANDEDGE MEASUREMENT	12
4.1.2 TEST INSTRUMENTS	13
4.1.3 TEST PROCEDURES.....	14
4.1.4 DEVIATION FROM TEST STANDARD	14
4.1.5 TEST SETUP	15
4.1.6 EUT OPERATING CONDITIONS.....	15
4.1.7 TEST RESULTS.....	16
4.2 CONDUCTED EMISSION MEASUREMENT	22
4.2.1 LIMITS OF CONDUCTED EMISSION MEASUREMENT	22
4.2.2 TEST INSTRUMENTS	22
4.2.3 TEST PROCEDURES.....	23
4.2.4 DEVIATION FROM TEST STANDARD	23
4.2.5 TEST SETUP	24
4.2.6 EUT OPERATING CONDITIONS.....	24
4.2.7 TEST RESULTS.....	25
4.3 NUMBER OF HOPPING FREQUENCY USED	27
4.3.1 LIMIT OF HOPPING FREQUENCY USED.....	27
4.3.2 TEST SETUP	27
4.3.3 TEST INSTRUMENTS	27
4.3.4 TEST PROCEDURES.....	27
4.3.5 DEVIATION FROM TEST STANDARD	27
4.3.6 TEST RESULTS.....	27
4.4 DWELL TIME ON EACH CHANNEL	29
4.4.1 LIMIT OF DWELL TIME USED	29
4.4.2 TEST SETUP	29
4.4.3 TEST INSTRUMENTS	29
4.4.4 TEST PROCEDURES.....	29
4.4.5 DEVIATION FROM TEST STANDARD	29
4.4.6 TEST RESULTS.....	30
4.5 CHANNEL BANDWIDTH	42
4.5.1 LIMITS OF CHANNEL BANDWIDTH	42
4.5.2 TEST SETUP	42
4.5.3 TEST INSTRUMENTS	42
4.5.4 TEST PROCEDURE	42



4.5.5	DEVIATION FROM TEST STANDARD	42
4.5.6	EUT OPERATING CONDITION	42
4.5.7	TEST RESULTS.....	43
4.6	HOPPING CHANNEL SEPARATION	46
4.6.1	LIMIT OF HOPPING CHANNEL SEPARATION	46
4.6.2	TEST SETUP	46
4.6.3	TEST INSTRUMENTS	46
4.6.4	TEST PROCEDURES.....	46
4.6.5	DEVIATION FROM TEST STANDARD	46
4.6.6	TEST RESULTS.....	47
4.7	MAXIMUM OUTPUT POWER.....	49
4.7.1	LIMITS OF MAXIMUM OUTPUT POWER MEASUREMENT	49
4.7.2	TEST SETUP	49
4.7.3	TEST INSTRUMENTS	49
4.7.4	TEST PROCEDURES.....	49
4.7.5	DEVIATION FROM TEST STANDARD	49
4.7.6	EUT OPERATING CONDITION	49
4.7.7	TEST RESULTS.....	50
4.8	BAND EDGES MEASUREMENT	52
4.8.1	LIMITS OF BAND EDGES MEASUREMENT	52
4.8.2	TEST INSTRUMENTS	52
4.8.3	TEST PROCEDURE	52
4.8.4	DEVIATION FROM TEST STANDARD	52
4.8.5	EUT OPERATING CONDITION	52
4.8.6	TEST RESULTS.....	52
5.	PHOTOGRAPHS OF THE TEST CONFIGURATION	56
6.	INFORMATION ON THE TESTING LABORATORIES	57
7.	APPENDIX A - MODIFICATIONS RECORDERS FOR ENGINEERING CHANGES TO THE EUT BY THE LAB	58



A D T

RELEASE CONTROL RECORD

ISSUE NO.	REASON FOR CHANGE	DATE ISSUED
RF120309C35-3	Original release	May 31, 2012



1. CERTIFICATION

PRODUCT: Tablet PC

MODEL: FZ-A1BDAAAAM

BRAND: Panasonic

APPLICANT: Panasonic Corporation of North America

TESTED: Mar. 02 ~ Mar. 22, 2012 and May 24, 2012

TEST SAMPLE: Engineering Sample

STANDARDS: **FCC Part 15, Subpart C (Section 15.247)**
ANSI C63.10-2009

The above equipment (Model: FZ-A1BDAAAAM) has been tested by **Bureau Veritas Consumer Products Services (H.K.) Ltd., Taoyuan Branch**, and found compliance with the requirement of the above standards. The test record, data evaluation & Equipment Under Test (EUT) configurations represented herein are true and accurate accounts of the measurements of the sample's EMC characteristics under the conditions specified in this report.

PREPARED BY : Ivonne Wu , **DATE** : May 31, 2012
Ivonne Wu / Senior Specialist

APPROVED BY : Gary Chang , **DATE** : May 31, 2012
Gary Chang / Technical Manager

2. SUMMARY OF TEST RESULTS

The EUT has been tested according to the following specifications:

APPLIED STANDARD: FCC Part 15, Subpart C			
STANDARD SECTION	TEST TYPE AND LIMIT	RESULT	REMARK
15.207	AC Power Conducted Emission	PASS	Meet the requirement of limit. Minimum passing margin is -3.62dB at 0.18125MHz.
15.247(a)(1) (iii)	Number of Hopping Frequency Used Spec.: At least 15 channels	PASS	Meet the requirement of limit.
15.247(a)(1) (iii)	Dwell Time on Each Channel Spec.: Max. 0.4 second within 31.6 second	PASS	Meet the requirement of limit.
15.247(a)(1)	1. Hopping Channel Separation Spec. : Min. 25 kHz or $\frac{2}{3} \times 20$ dB bandwidth, whichever is greater 2. Spectrum Bandwidth of a Frequency Hopping Sequence Spread Spectrum System	PASS	Meet the requirement of limit.
15.247(b)	Maximum Output Power Spec.: max. 21dBm	PASS	Meet the requirement of limit.
15.247(d)	Transmitter Radiated Emissions Spec.: Table 15.209	PASS	Meet the requirement of limit. Minimum passing margin is -3.03dB at 35.67MHz.
15.247(d)	Band Edge Measurement	PASS	Meet the requirement of limit.
15.203	Antenna Requirement	PASS	No antenna connector is used.

NOTE: If The Frequency Hopping System operating in 2400-2483.5MHz band and the output power less than 125mW. The hopping channel carrier frequencies separated by a minimum of 25kHz or two-thirds of the 20dB bandwidth of hopping channel whichever is greater.

2.1 MEASUREMENT UNCERTAINTY

Where relevant, the following measurement uncertainty levels have been estimated for tests performed on the EUT as specified in CISPR 16-4-2:

MEASUREMENT	FREQUENCY	UNCERTAINTY
Conducted emissions	9kHz~30MHz	2.44 dB
Radiated emissions	30MHz ~ 200MHz	3.34 dB
	200MHz ~1000MHz	3.35 dB
	1GHz ~ 18GHz	2.26 dB
	18GHz ~ 40GHz	1.94 dB

This uncertainty represents an expanded uncertainty expressed at approximately the 95% confidence level using a coverage factor of k=2.



A D T

3. GENERAL INFORMATION

3.1 GENERAL DESCRIPTION OF EUT

EUT	Tablet PC
MODEL NO.	FZ-A1BDAAAAM
POWER SUPPLY	12Vdc (adapter) 7.4Vdc (battery)
MODULATION TYPE	GFSK, $\pi/4$ -DQPSK, 8DPSK
TRANSFER RATE	1/2/3Mbps
OPERATING FREQUENCY	2402 ~ 2480MHz
NUMBER OF CHANNEL	79
CHANNEL SPACING	1MHz
OUTPUT POWER	1.014mW
ANTENNA TYPE	PIFA antenna with 2.44dBi gain
ANTENNA CONNECTOR	NA
I/O PORTS	Refer to users' manual
DATA CABLE	NA
ACCESSORY DEVICES	Refer to Note as below

NOTE:

1. The EUT contains following accessory devices.

ITEM	BRAND	MODEL	SPECIFICATION
Adapter	JRC	NJD-9370	Input: 100-240Vac, 50/60Hz , 0.5A~0.3A Output: 12Vdc, 2A Power line: 0.7m non-shielded cable without core
Battery	SANYO	2UF484462-3-T0775	Rating: 7.4Vdc Type: Li-ion
LCD Panel	Hannstar	HSD100PXN1	--
Main Camera	D-Max Technology	HAC-001502-W1A	--
2 nd Camera	D-Max Technology	HAC-002103-W1A	--

2. The above EUT information is declared by manufacturer and for more detailed features description, please refer to the manufacturer's specifications or User's Manual.

3.2 DESCRIPTION OF TEST MODES

For Bluetooth EDR:

79 channels are provided to this EUT:

CHANNEL	FREQ. (MHz)	CHANNEL	FREQ. (MHz)	CHANNEL	FREQ. (MHz)	CHANNEL	FREQ. (MHz)
0	2402	20	2422	40	2442	60	2462
1	2403	21	2423	41	2443	61	2463
2	2404	22	2424	42	2444	62	2464
3	2405	23	2425	43	2445	63	2465
4	2406	24	2426	44	2446	64	2466
5	2407	25	2427	45	2447	65	2467
6	2408	26	2428	46	2448	66	2468
7	2409	27	2429	47	2449	67	2469
8	2410	28	2430	48	2450	68	2470
9	2411	29	2431	49	2451	69	2471
10	2412	30	2432	50	2452	70	2472
11	2413	31	2433	51	2453	71	2473
12	2414	32	2434	52	2454	72	2474
13	2415	33	2435	53	2455	73	2475
14	2416	34	2436	54	2456	74	2476
15	2417	35	2437	55	2457	75	2477
16	2418	36	2438	56	2458	76	2478
17	2419	37	2439	57	2459	77	2479
18	2420	38	2440	58	2460	78	2480
19	2421	39	2441	59	2461		

3.2.1 TEST MODE APPLICABILITY AND TESTED CHANNEL DETAIL

EUT CONFIGURE MODE	APPLICABLE TO			DESCRIPTION
	RE	PLC	APCM	
-	√	√	√	-

Where **RE:** Radiated Emission

PLC: Power Line Conducted Emission

APCM: Antenna Port Conducted Measurement

NOTE:

1. For radiated emission test, pre-tested GFSK, $\pi/4$ -DQPSK, 8DPSK modulation type and found GFSK was the worse, therefore chosen for the final test and presented in the test report.
2. The EUT had been pre-tested on the positioned of each 3 axis. The worst case was found when positioned on **X-plane**.

RADIATED EMISSION TEST:

- Pre-Scan has been conducted to determine the worst-case mode from all possible combinations between available modulations, antenna ports (if EUT with antenna diversity architecture) and packet type.
- Following channel(s) was (were) selected for the final test as listed below.

EUT CONFIGURE MODE	AVAILABLE CHANNEL	TESTED CHANNEL	MODULATION TYPE	PACKET TYPE
-	0 to 78	0, 39, 78	GFSK	DH5

POWER LINE CONDUCTED EMISSION TEST:

- Pre-Scan has been conducted to determine the worst-case mode from all possible combinations between available modulations, antenna ports (if EUT with antenna diversity architecture), and packet types.
- Following channel(s) was (were) selected for the final test as listed below.

EUT CONFIGURE MODE	AVAILABLE CHANNEL	TESTED CHANNEL	MODULATION TYPE	PACKET TYPE
-	0 to 78	0	GFSK	DH5

ANTENNA PORT CONDUCTED MEASUREMENT:

- This item includes all test value of each mode, but only includes spectrum plot of worst value of each mode.
- Pre-Scan has been conducted to determine the worst-case mode from all possible combinations between available modulations, antenna ports (if EUT with antenna diversity architecture), and packet types.
- Following channel(s) was (were) selected for the final test as listed below.

EUT CONFIGURE MODE	AVAILABLE CHANNEL	TESTED CHANNEL	MODULATION TYPE	PACKET TYPE
-	0 to 78	0, 39, 78	GFSK	DH5
-	0 to 78	0, 39, 78	$\pi/4$ -DQPSK	DH5
-	0 to 78	0, 39, 78	8DPSK	DH5

TEST CONDITION:

APPLICABLE TO	ENVIRONMENTAL CONDITIONS	INPUT POWER	TESTED BY
RE	25deg. C, 65%RH	120Vac, 60Hz	Kay Wu
PLC	25deg. C, 67%RH	120Vac, 60Hz	Scott Yang
APCM	25deg. C, 50%RH	120Vac, 60Hz	Phoenix Chen

3.3 DESCRIPTION OF SUPPORT UNITS

The EUT has been tested as an independent unit together with other necessary accessories or support units.

3.3.1 CONFIGURATION OF SYSTEM UNDER TEST

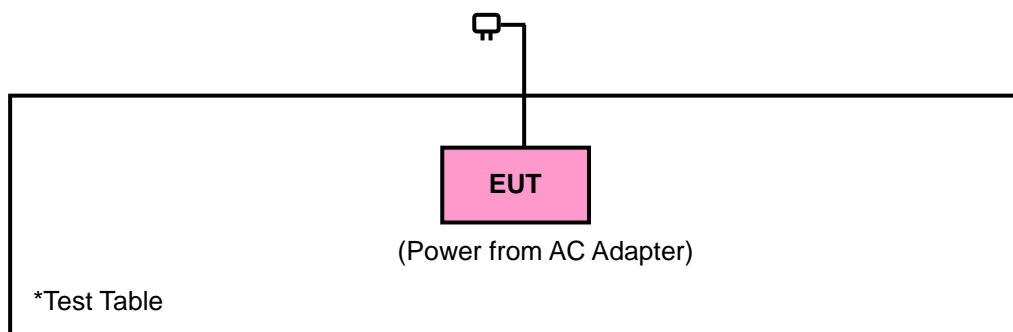

3.4 GENERAL DESCRIPTION OF APPLIED STANDARDS

The EUT is a RF Product. According to the specifications of the manufacturer, it must comply with the requirements of the following standards:

FCC Part 15, Subpart C. (15.247)

ANSI C63.10-2009

All test items have been performed and recorded as per the above standards.

NOTE: The EUT is also considered as a kind of computer peripheral, because the connection to computer is necessary for typical use. It has been verified to comply with the requirements of FCC Part 15, Subpart B, Class B (DoC). The test report has been issued separately.

4. TEST TYPES AND RESULTS

4.1 RADIATED EMISSION MEASUREMENT

4.1.1 LIMITS OF RADIATED EMISSION AND BANDEDGE MEASUREMENT

Radiated emissions which fall in the restricted bands must comply with the radiated emission limits specified as below table. Other emissions shall be at least 20dB below the highest level of the desired power:

FREQUENCIES (MHz)	FIELD STRENGTH (microvolts/meter)	MEASUREMENT DISTANCE (meters)
0.009 ~ 0.490	2400/F(kHz)	300
0.490 ~ 1.705	24000/F(kHz)	30
1.705 ~ 30.0	30	30
30 ~ 88	100	3
88 ~ 216	150	3
216 ~ 960	200	3
Above 960	500	3

NOTE:

1. The lower limit shall apply at the transition frequencies.
2. Emission level (dBuV/m) = 20 log Emission level (uV/m).
3. As shown in 15.35(b), for frequencies above 1000MHz, the field strength limits are based on average detector, however, the peak field strength of any emission shall not exceed the maximum permitted average limits, specified above by more than 20dB under any condition of modulation.

4.1.2 TEST INSTRUMENTS

DESCRIPTION & MANUFACTURER	MODEL NO.	SERIAL NO.	DATE OF CALIBRATION	DUE DATE OF CALIBRATION
Test Receiver Agilent	N9038A	MY51210203	Dec. 22, 2011	Dec. 21, 2012
Spectrum Analyzer ROHDE & SCHWARZ	FSU43	101261	Dec. 21, 2011	Dec. 20, 2012
BILOG Antenna SCHWARZBECK	VULB9168	9168-472	Dec. 20, 2011	Dec. 19, 2012
HORN Antenna SCHWARZBECK	BBHA 9120 D	9120D-969	Dec. 20, 2011	Dec. 19, 2012
HORN Antenna SCHWARZBECK	BBHA 9170	9170-480	Dec. 20, 2011	Dec. 19, 2012
Preamplifier EMCI	EMC 012645	980115	Dec. 30, 2011	Dec. 29, 2012
Preamplifier EMCI	EMC 330H	980112	Dec. 30, 2011	Dec. 29, 2012
RF signal cable HUBER+SUHNNER	SUCOFLEX 104	309219/4	Oct. 21, 2011	Oct. 20, 2012
RF signal cable HUBER+SUHNNER	SUCOFLEX 104	250130/4	Jan. 02, 2012	Jan. 01, 2013
RF signal cable Worken	RG-213	NA	Jan. 02, 2012	Jan. 01, 2013
Software	E3 6.120103	NA	NA	NA
Antenna Tower MF	MFA-440H	NA	NA	NA
Turn Table MF	MFT-201SS	NA	NA	NA
Antenna Tower & Turn Table Controller MF	MF-7802	NA	NA	NA

- NOTE:**
1. The calibration interval of the above test instruments is 12 months and the calibrations are traceable to NML/ROC and NIST/USA.
 2. The test was performed in HwaYa Chamber 9.
 3. The horn antenna and HP preamplifier (model: 8449B) are used only for the measurement of emission frequency above 1GHz if tested.
 4. The FCC Site Registration No. is 460141.
 5. The IC Site Registration No. is IC 7450F-4.

4.1.3 TEST PROCEDURES

- a. The EUT was placed on the top of a rotating table 0.8 meters above the ground at a 3 meter semi-anechoic chamber. The table was rotated 360 degrees to determine the position of the highest radiation.
- b. The EUT was set 3 meters away from the interference-receiving antenna, which was mounted on the top of a variable-height antenna tower.
- c. The antenna is a broadband antenna, and its height is varied from one meter to four meters above the ground to determine the maximum value of the field strength. Both horizontal and vertical polarizations of the antenna are set to make the measurement.
- d. For each suspected emission, the EUT was arranged to its worst case and then the antenna was tuned to heights from 1 meter to 4 meters and the rotatable table was turned from 0 degrees to 360 degrees to find the maximum reading.
- e. The test-receiver system was set to Peak Detect Function and Specified Bandwidth with Maximum Hold Mode.
- f. If the emission level of the EUT in peak mode was lower than the limit specified, then testing could be stopped and the peak values of the EUT would be reported. Otherwise the emissions would be re-tested one by one using peak, quasi-peak or average method as specified and then reported in a data sheet.

NOTE:

1. The resolution bandwidth and video bandwidth of test receiver/spectrum analyzer is 120kHz for Quasi-peak detection at frequency below 1GHz.
2. The resolution bandwidth of test receiver/spectrum analyzer is 1 MHz and video bandwidth is 3MHz for Peak detection at frequency above 1GHz.
3. All modes of operation were investigated and the worst-case emissions are reported.

4.1.4 DEVIATION FROM TEST STANDARD

No deviation

4.1.5 TEST SETUP

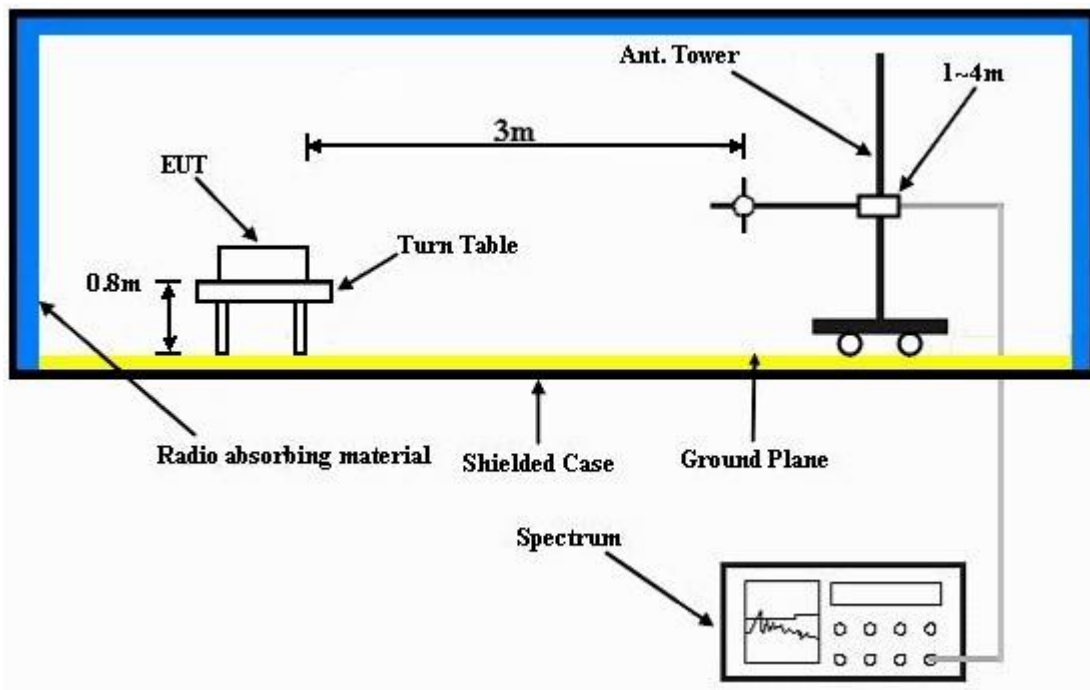

For the actual test configuration, please refer to the attached file (Test Setup Photo).

4.1.6 EUT OPERATING CONDITIONS

- a. Placed the EUT on a testing table.
- b. Use the software to control the EUT under transmission condition continuously at specific channel frequency.



A D T

4.1.7 TEST RESULTS

GFSK

EUT TEST CONDITION		MEASUREMENT DETAIL	
CHANNEL	Channel 0	FREQUENCY RANGE	30MHz ~ 25GHz
INPUT POWER (SYSTEM)	120Vac, 60 Hz	DETECTOR FUNCTION	Peak (PK) Average (AV)
ENVIRONMENTAL CONDITIONS	25deg. C, 65%RH	TESTED BY	Kay Wu

ANTENNA POLARITY & TEST DISTANCE: HORIZONTAL AT 3 M										
FREQ. (MHz)	EMISSION LEVEL (dBuV/m)	READ LEVEL (dBuV)	LIMIT (dBuV/m)	MARGIN (dB)	ANTENNA FACTOR (dB/m)	CABLE LOSS (dB)	PREAMP FACTOR (dB)	ANTENNA HEIGHT (cm)	TABLE ANGLE (Degree)	REMARK
2398	41.84	46.25	54	-12.16	27.26	4.25	35.92	110	196	Average
2398	50.77	55.18	74	-23.23	27.26	4.25	35.92	110	196	Peak
2400	7.96	12.37	54	-46.04	27.26	4.25	35.92	110	196	Average
2400	38.06	42.47	74	-35.94	27.26	4.25	35.92	110	196	Peak
2402	69.41	73.82			27.26	4.25	35.92	110	196	Average
2402	99.51	103.92			27.26	4.25	35.92	110	196	Peak
4804	15.71	31.33	54	-38.29	31.38	6.1	53.1	100	124	Average
4804	45.81	61.43	74	-28.19	31.38	6.1	53.1	100	124	Peak

REMARKS: 2402MHz: Fundamental frequency.



A D T

EUT TEST CONDITION		MEASUREMENT DETAIL	
CHANNEL	Channel 0	FREQUENCY RANGE	30MHz ~ 25GHz
INPUT POWER (SYSTEM)	120Vac, 60 Hz	DETECTOR FUNCTION	Peak (PK) Average (AV)
ENVIRONMENTAL CONDITIONS	25deg. C, 65%RH	TESTED BY	Kay Wu

ANTENNA POLARITY & TEST DISTANCE: VERTICAL AT 3 M										
FREQ. (MHz)	EMISSION LEVEL (dBuV/m)	READ LEVEL (dBuV)	LIMIT (dBuV/m)	MARGIN (dB)	ANTENNA FACTOR (dB/m)	CABLE LOSS (dB)	PREAMP FACTOR (dB)	ANTENNA HEIGHT (cm)	TABLE ANGLE (Degree)	REMARK
2398	33.98	38.39	54	-20.02	27.26	4.25	35.92	100	267	Average
2398	42.28	46.69	74	-31.72	27.26	4.25	35.92	100	267	Peak
2400	2.48	6.89	54	-51.52	27.26	4.25	35.92	100	267	Average
2400	32.58	36.99	74	-41.42	27.26	4.25	35.92	100	267	Peak
2402	59.02	63.43			27.26	4.25	35.92	100	267	Average
2402	89.12	93.53			27.26	4.25	35.92	100	267	Peak
4804	16.37	31.99	54	-37.63	31.38	6.1	53.1	100	50	Average
4804	46.47	62.09	74	-27.53	31.38	6.1	53.1	100	50	Peak

REMARKS: 2402MHz: Fundamental frequency.



A D T

EUT TEST CONDITION		MEASUREMENT DETAIL	
CHANNEL	Channel 39	FREQUENCY RANGE	30MHz ~ 25GHz
INPUT POWER (SYSTEM)	120Vac, 60 Hz	DETECTOR FUNCTION	Peak (PK) Average (AV)
ENVIRONMENTAL CONDITIONS	25deg. C, 65%RH	TESTED BY	Kay Wu

ANTENNA POLARITY & TEST DISTANCE: HORIZONTAL AT 3 M										
FREQ. (MHz)	EMISSION LEVEL (dBuV/m)	READ LEVEL (dBuV)	LIMIT (dBuV/m)	MARGIN (dB)	ANTENNA FACTOR (dB/m)	CABLE LOSS (dB)	PREAMP FACTOR (dB)	ANTENNA HEIGHT (cm)	TABLE ANGLE (Degree)	REMARK
2390	29	33.41	54	-25	27.26	4.25	35.92	110	241	Average
2390	40.63	45.04	74	-33.37	27.26	4.25	35.92	110	241	Peak
2441	68.75	72.97			27.4	4.27	35.89	110	241	Average
2441	98.85	103.07			27.4	4.27	35.89	110	241	Peak
2486	29.17	33.26	54	-24.83	27.5	4.28	35.87	110	241	Average
2486	39.89	43.98	74	-34.11	27.5	4.28	35.87	110	241	Peak
4882	46.47	61.87	74	-27.53	31.53	6.12	53.05	200	195	Peak
4882	16.38	31.78	54	-37.62	31.53	6.12	53.05	200	195	Average

REMARKS: 2441MHz: Fundamental frequency.



A D T

EUT TEST CONDITION		MEASUREMENT DETAIL	
CHANNEL	Channel 39	FREQUENCY RANGE	30MHz ~ 25GHz
INPUT POWER (SYSTEM)	120Vac, 60 Hz	DETECTOR FUNCTION	Peak (PK) Average (AV)
ENVIRONMENTAL CONDITIONS	25deg. C, 65%RH	TESTED BY	Kay Wu

ANTENNA POLARITY & TEST DISTANCE: VERTICAL AT 3 M										
FREQ. (MHz)	EMISSION LEVEL (dBuV/m)	READ LEVEL (dBuV)	LIMIT (dBuV/m)	MARGIN (dB)	ANTENNA FACTOR (dB/m)	CABLE LOSS (dB)	PREAMP FACTOR (dB)	ANTENNA HEIGHT (cm)	TABLE ANGLE (Degree)	REMARK
2390	28.73	33.14	54	-25.27	27.26	4.25	35.92	100	174	Average
2390	38.87	43.28	74	-35.13	27.26	4.25	35.92	100	174	Peak
2441	60.11	64.33			27.4	4.27	35.89	100	174	Average
2442	90.21	94.43			27.4	4.27	35.89	100	174	Peak
2485.5	28.56	32.65	54	-25.44	27.5	4.28	35.87	100	174	Average
2485.5	39.17	43.26	74	-34.83	27.5	4.28	35.87	100	174	Peak
4882	18.65	34.05	54	-35.35	31.53	6.12	53.05	100	360	Average
4882	48.74	64.14	74	-25.26	31.53	6.12	53.05	100	360	Peak

REMARKS: 2441MHz: Fundamental frequency.



A D T

EUT TEST CONDITION		MEASUREMENT DETAIL	
CHANNEL	Channel 78	FREQUENCY RANGE	30MHz ~ 25GHz
INPUT POWER (SYSTEM)	120Vac, 60 Hz	DETECTOR FUNCTION	Peak (PK) Average (AV)
ENVIRONMENTAL CONDITIONS	25deg. C, 65%RH	TESTED BY	Kay Wu

ANTENNA POLARITY & TEST DISTANCE: HORIZONTAL AT 3 M										
FREQ. (MHz)	EMISSION LEVEL (dBuV/m)	READ LEVEL (dBuV)	LIMIT (dBuV/m)	MARGIN (dB)	ANTENNA FACTOR (dB/m)	CABLE LOSS (dB)	PREAMP FACTOR (dB)	ANTENNA HEIGHT (cm)	TABLE ANGLE (Degree)	REMARK
82.65	28.85	51.31	40	-11.15	8.16	0.98	31.6			Peak
119.91	35.31	55	43.5	-8.19	11.02	1.19	31.9	100	284	Peak
170.94	33.96	52.58	43.5	-9.54	11.67	1.45	31.74			Peak
311.9	25.86	42.46	46	-20.14	13.24	2.1	31.94			Peak
535.2	22.11	32.79	46	-23.89	18.13	2.9	31.71			Peak
682.9	24.8	32.66	46	-21.2	20.61	3.37	31.84			Peak
2480	66.66	70.75			27.5	4.28	35.87	120	234	Average
2480	96.76	100.85			27.5	4.28	35.87	120	234	Peak
2483.5	5.54	9.63	54	-48.46	27.5	4.28	35.87	120	234	Average
2483.5	35.64	39.73	74	-38.36	27.5	4.28	35.87	120	234	Peak
2485.5	31.87	35.96	54	-22.13	27.5	4.28	35.87	120	234	Average
2485.5	43.83	47.92	74	-30.17	27.5	4.28	35.87	120	234	Peak
4960	18.91	34.11	54	-35.09	31.72	6.12	53.04	200	360	Average
4960	49.01	64.21	74	-24.99	31.72	6.12	53.04	200	360	Peak

REMARKS: 2480MHz: Fundamental frequency.



A D T

EUT TEST CONDITION		MEASUREMENT DETAIL	
CHANNEL	Channel 78	FREQUENCY RANGE	30MHz ~ 25GHz
INPUT POWER (SYSTEM)	120Vac, 60 Hz	DETECTOR FUNCTION	Peak (PK) Average (AV)
ENVIRONMENTAL CONDITIONS	25deg. C, 65%RH	TESTED BY	Kay Wu

ANTENNA POLARITY & TEST DISTANCE: VERTICAL AT 3 M										
FREQ. (MHz)	EMISSION LEVEL (dBuV/m)	READ LEVEL (dBuV)	LIMIT (dBuV/m)	MARGIN (dB)	ANTENNA FACTOR (dB/m)	CABLE LOSS (dB)	PREAMP FACTOR (dB)	ANTENNA HEIGHT (cm)	TABLE ANGLE (Degree)	REMARK
30.27	31.94	50.53	40	-8.06	11.98	0.57	31.14	100	358	QP
35.67	36.97	54.47	40	-3.03	12.94	0.61	31.05	100	358	QP
171.21	34.56	53.29	43.5	-8.94	11.57	1.45	31.75			Peak
305.6	20.33	37.08	46	-25.67	13.08	2.07	31.9			Peak
430.2	19.76	33.28	46	-26.24	15.95	2.54	32.01			Peak
680.8	24	31.89	46	-22	20.59	3.36	31.84			Peak
2480	59.91	64			27.5	4.28	35.87	105	167	Average
2480	90.01	94.1			27.5	4.28	35.87	105	167	Peak
2483.5	4.25	8.34	54	-49.75	27.5	4.28	35.87	105	167	Average
2483.5	34.35	38.44	74	-39.65	27.5	4.28	35.87	105	167	Peak
2485.5	29.57	33.66	54	-24.43	27.5	4.28	35.87	105	167	Average
2485.5	40.58	44.67	74	-33.42	27.5	4.28	35.87	105	167	Peak
4960	25.38	40.58	54	-28.62	31.72	6.12	53.04	100	360	Average
4960	55.48	70.68	74	-18.52	31.72	6.12	53.04	100	360	Peak

REMARKS: 2480MHz: Fundamental frequency.

4.2 CONDUCTED EMISSION MEASUREMENT

4.2.1 LIMITS OF CONDUCTED EMISSION MEASUREMENT

FREQUENCY OF EMISSION (MHz)	CONDUCTED LIMIT (dB μ V)	
	Quasi-peak	Average
0.15 ~ 0.5	66 to 56	56 to 46
0.5 ~ 5	56	46
5 ~ 30	60	50

- NOTE:**
1. The lower limit shall apply at the transition frequencies.
 2. The limit decreases in line with the logarithm of the frequency in the range of 0.15 to 0.50 MHz.
 3. All emanations from a class A/B digital device or system, including any network of conductors and apparatus connected thereto, shall not exceed the level of field strengths specified above.

4.2.2 TEST INSTRUMENTS

DESCRIPTION & MANUFACTURER	MODEL NO.	SERIAL NO.	DATE OF CALIBRATION	DUE DATE OF CALIBRATION
Test Receiver ROHDE & SCHWARZ	ESCS30	100289	Nov. 19, 2011	Nov. 18, 2012
RF signal cable Woken	5D-FB	Cable-HYCO2-0 1	Dec. 22, 2011	Dec. 21, 2012
LISN ROHDE & SCHWARZ	ESH2-Z5	100100	Dec. 30, 2011	Dec. 29, 2012
LISN ROHDE & SCHWARZ	ESH3-Z5	100312	Jul. 07, 2011	Jul. 06, 2012
V-LISN SCHWARZBECK	NNBL 8226-2	8226-142	Jun. 30, 2011	Jun. 29, 2012
LISN ROHDE & SCHWARZ	ENV216	100072	Jun. 10, 2011	Jun. 09, 2012
Software ADT	ADT_Cond_ V7.3.7	NA	NA	NA

- NOTE:**
1. The calibration interval of the above test instruments is 12 months and the calibrations are traceable to NML/ROC and NIST/USA.
 2. The test was performed in HwaYa Shielded Room 2.
 3. The VCCI Site Registration No. is C-2047.

4.2.3 TEST PROCEDURES

- a. The EUT was placed 0.4 meters from the conducting wall of the shielded room with EUT being connected to the power mains through a line impedance stabilization network (LISN). Other support units were connected to the power mains through another LISN. The two LISNs provide 50 ohm/ 50uH of coupling impedance for the measuring instrument.
- b. Both lines of the power mains connected to the EUT were checked for maximum conducted interference.
- c. The frequency range from 150kHz to 30MHz was searched. Emission levels under (Limit - 20dB) was not recorded.

NOTE: All modes of operation were investigated and the worst-case emissions are reported.

4.2.4 DEVIATION FROM TEST STANDARD

No deviation

4.2.5 TEST SETUP

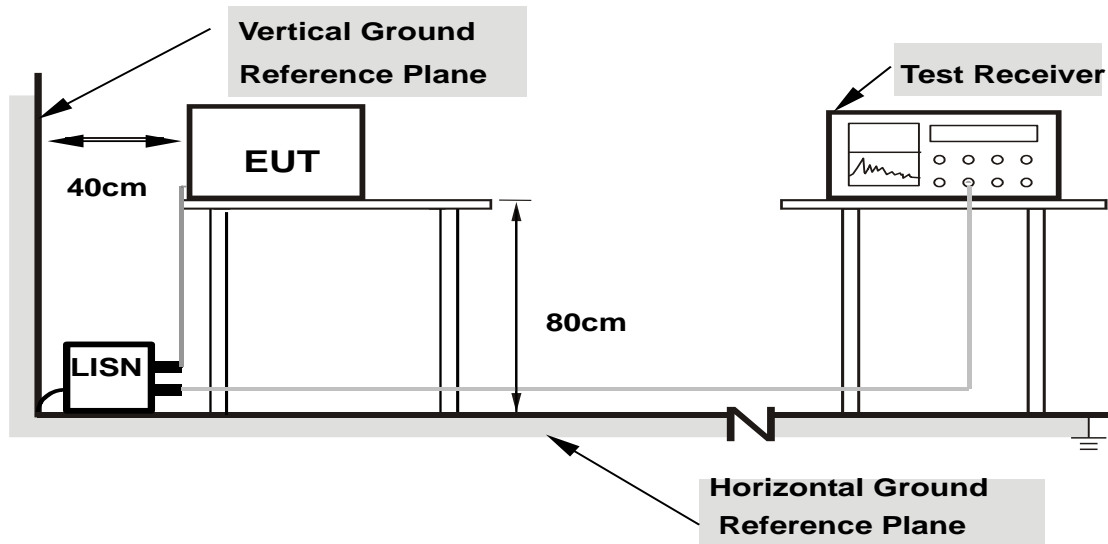

- Note: 1.Support units were connected to second LISN.
 2.Both of LISNs (AMN) are 80 cm from EUT and at least 80 from other units and other metal planes**

For the actual test configuration, please refer to the attached file (Test Setup Photo).

4.2.6 EUT OPERATING CONDITIONS

Same as 4.1.6

4.2.7 TEST RESULTS

CONDUCTED WORST CASE DATA: GFSK

PHASE	Line 1	6dB BANDWIDTH	9kHz
-------	--------	---------------	------

No	Freq. [MHz]	Corr. Factor (dB)	Reading Value		Emission Level		Limit		Margin	
			[dB (uV)]		[dB (uV)]		[dB (uV)]		(dB)	
			Q.P.	AV.	Q.P.	AV.	Q.P.	AV.	Q.P.	AV.
1	0.18125	0.15	60.66	43.33	60.81	43.48	64.43	54.43	-3.62	-10.95
2	0.27109	0.16	49.42	28.61	49.58	28.77	61.08	51.08	-11.51	-22.32
3	0.37656	0.17	39.33	17.16	39.50	17.33	58.35	48.35	-18.86	-31.03
4	0.79063	0.18	42.72	27.99	42.90	28.17	56.00	46.00	-13.10	-17.83
5	0.97813	0.19	40.41	24.82	40.60	25.01	56.00	46.00	-15.40	-20.99
6	4.59375	0.35	42.04	28.96	42.39	29.31	56.00	46.00	-13.61	-16.69

- REMARKS:**
1. Q.P. and AV. are abbreviations of quasi-peak and average individually.
 2. "-": The Quasi-peak reading value also meets average limit and measurement with the average detector is unnecessary.
 3. The emission levels of other frequencies were very low against the limit.
 4. Margin value = Emission level - Limit value
 5. Correction factor = Insertion loss + Cable loss
 6. Emission Level = Correction Factor + Reading Value.

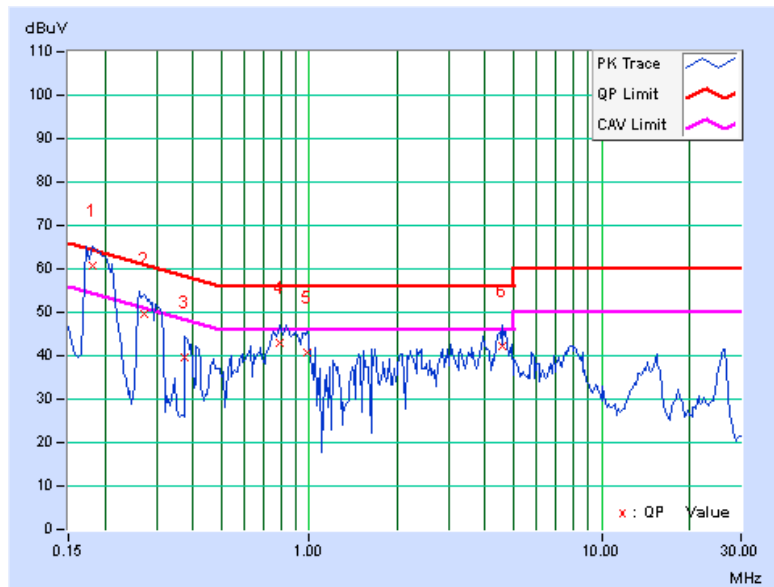

PHASE	Line 2	6dB BANDWIDTH	9kHz
-------	--------	---------------	------

No	Freq. [MHz]	Corr. Factor (dB)	Reading Value		Emission Level		Limit		Margin	
			[dB (uV)]		[dB (uV)]		[dB (uV)]		(dB)	
			Q.P.	AV.	Q.P.	AV.	Q.P.	AV.	Q.P.	AV.
1	0.18516	0.14	57.97	42.32	58.11	42.46	64.25	54.25	-6.14	-11.79
2	0.27109	0.15	47.06	28.69	47.21	28.84	61.08	51.08	-13.88	-22.25
3	0.82578	0.18	45.49	32.60	45.67	32.78	56.00	46.00	-10.33	-13.22
4	0.97813	0.19	42.31	26.11	42.50	26.30	56.00	46.00	-13.50	-19.70
5	2.07422	0.26	40.60	26.24	40.86	26.50	56.00	46.00	-15.14	-19.50
6	2.98828	0.30	38.44	26.48	38.74	26.78	56.00	46.00	-17.26	-19.22
7	3.33203	0.32	39.61	27.69	39.93	28.01	56.00	46.00	-16.07	-17.99
8	4.17969	0.35	41.03	28.42	41.38	28.77	56.00	46.00	-14.62	-17.23
9	7.63672	0.43	40.96	35.02	41.39	35.45	60.00	50.00	-18.61	-14.55

- REMARKS:**
1. Q.P. and AV. are abbreviations of quasi-peak and average individually.
 2. "-": The Quasi-peak reading value also meets average limit and measurement with the average detector is unnecessary.
 3. The emission levels of other frequencies were very low against the limit.
 4. Margin value = Emission level - Limit value
 5. Correction factor = Insertion loss + Cable loss
 6. Emission Level = Correction Factor + Reading Value.

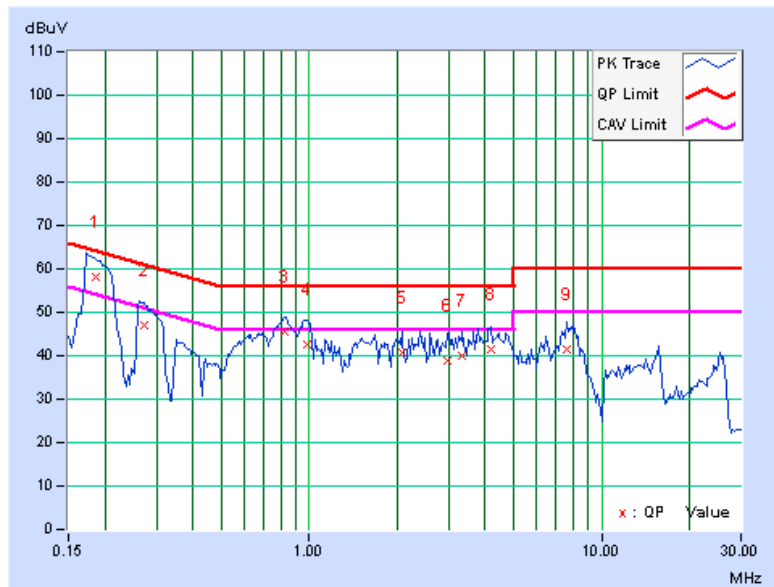

4.3 NUMBER OF HOPPING FREQUENCY USED

4.3.1 LIMIT OF HOPPING FREQUENCY USED

At least 15 channels frequencies, and should be equally spaced.

4.3.2 TEST SETUP

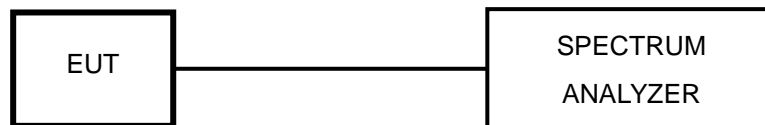

4.3.3 TEST INSTRUMENTS

Refer to section 4.1.2 to get information of above instrument.

4.3.4 TEST PROCEDURES

- a. Check the calibration of the measuring instrument (SA) using either an internal calibrator or a known signal from an external generator.
- b. Turn on the EUT and connect its antenna terminal to measurement via a low loss cable. Then set it to any one measured frequency within its operating range and make sure the instrument is operated in its linear range.
- c. Set the SA on MaxHold Mode, and then keep the EUT in hopping mode. Record all the signals from each channel until each one has been recorded.
- d. Set the SA on View mode and then plot the result on SA screen.
- e. Repeat above procedures until all frequencies measured were complete.

4.3.5 DEVIATION FROM TEST STANDARD

No deviation.

4.3.6 TEST RESULTS

There are 79 hopping frequencies in the hopping mode. Please refer to next two pages for the test result. On the plots, it shows that the hopping frequencies are equally spaced.

GFSK

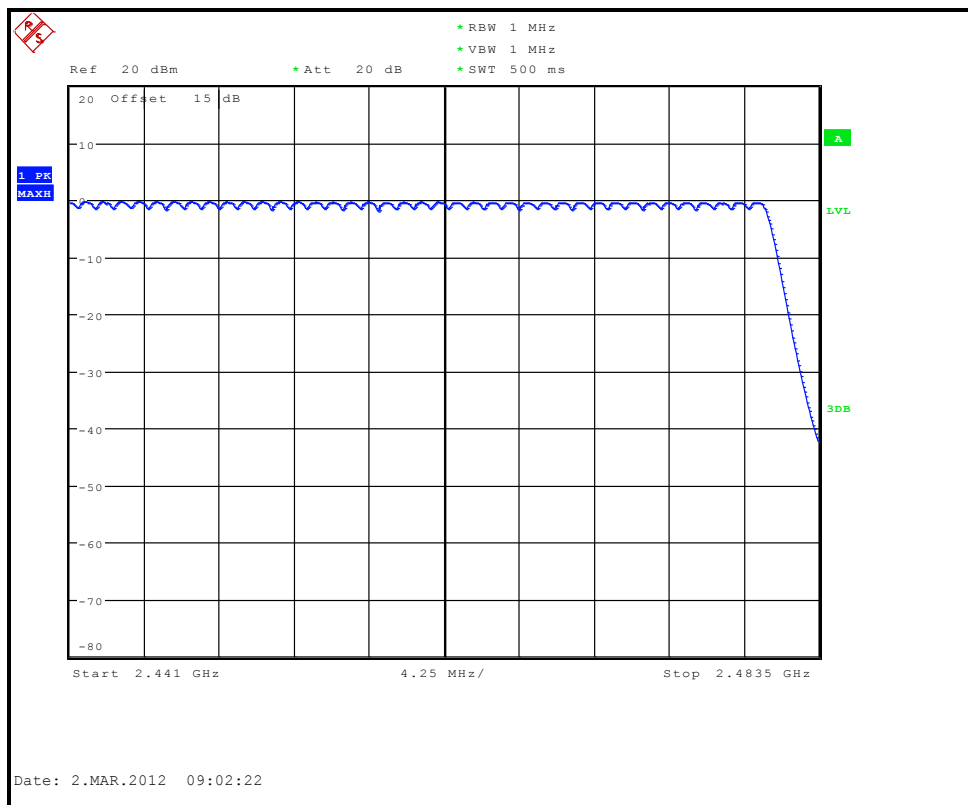

4.4 DWELL TIME ON EACH CHANNEL

4.4.1 LIMIT OF DWELL TIME USED

The average time of occupancy on any channel shall not be greater than 0.4 seconds within a period of 0.4 seconds multiplied by the number of hopping channels employed.

4.4.2 TEST SETUP

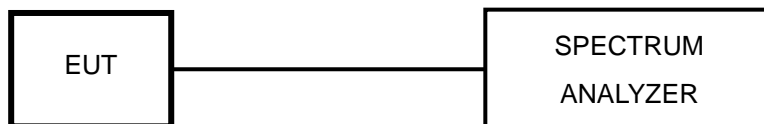

4.4.3 TEST INSTRUMENTS

Refer to section 4.1.2 to get information of above instrument.

4.4.4 TEST PROCEDURES

- a. Check the calibration of the measuring instrument (SA) using either an internal calibrator or a known signal from an external generator.
- b. Turn on the EUT and connect its antenna terminal to measurement via a low loss cable. Then set it to any one measured frequency within its operating range and make sure the instrument is operated in its linear range.
- c. Adjust the center frequency of SA on any frequency be measured and set SA to zero span mode. And then, set RBW and VBW of spectrum analyzer to proper value.
- d. Measure the time duration of one transmission on the measured frequency. And then plot the result with time difference of this time duration.
- e. Repeat above procedures until all different time-slot modes have been completed.

4.4.5 DEVIATION FROM TEST STANDARD

No deviation.

4.4.6 TEST RESULTS

GFSK

Mode	Average Hopping Channel	Package Transfer Time (usec)	Dwell Time (sec)	Limit (msec)
DH1	9.40	407.05	0.12	400
DH3	4.50	1666.67	0.24	400
DH5	3.60	2948.72	0.34	400

NOTE:

1. Dwell Time=79(channels) x 0.4(s) x average hopping channel x package transfer time
2. 79 channels come from the Hopping Channel number
3. Average Hopping Channel = hops/sweep time
4. t: Package Transfer Time(us)
5. Test plots of the transmitting time slot are shown on next 3 pages.



A D T

DH3

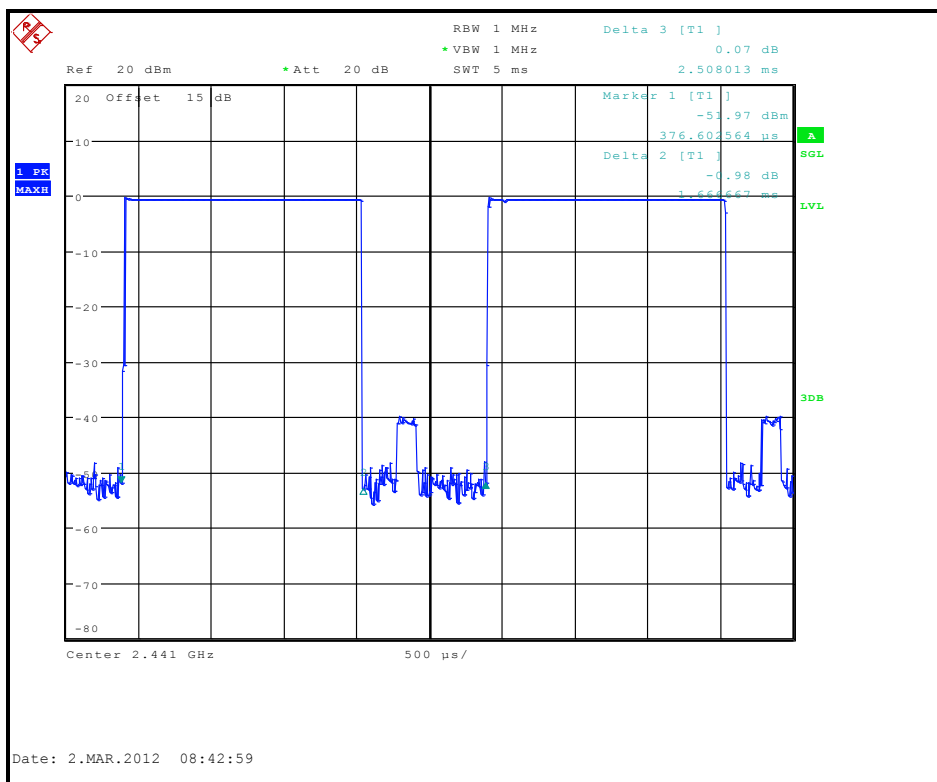
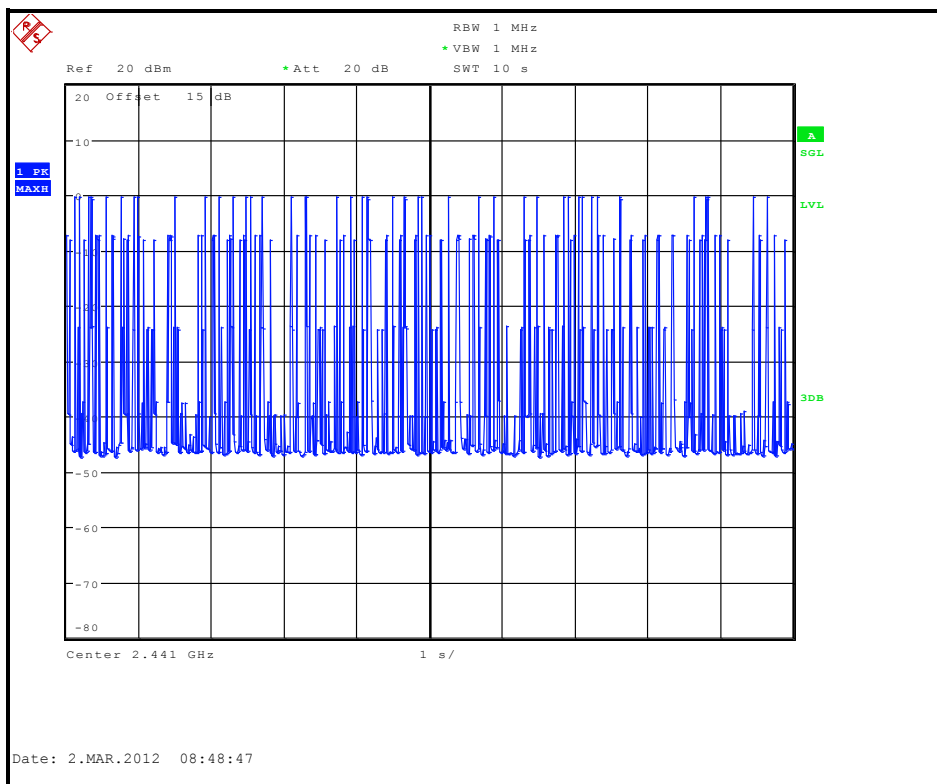

DH5

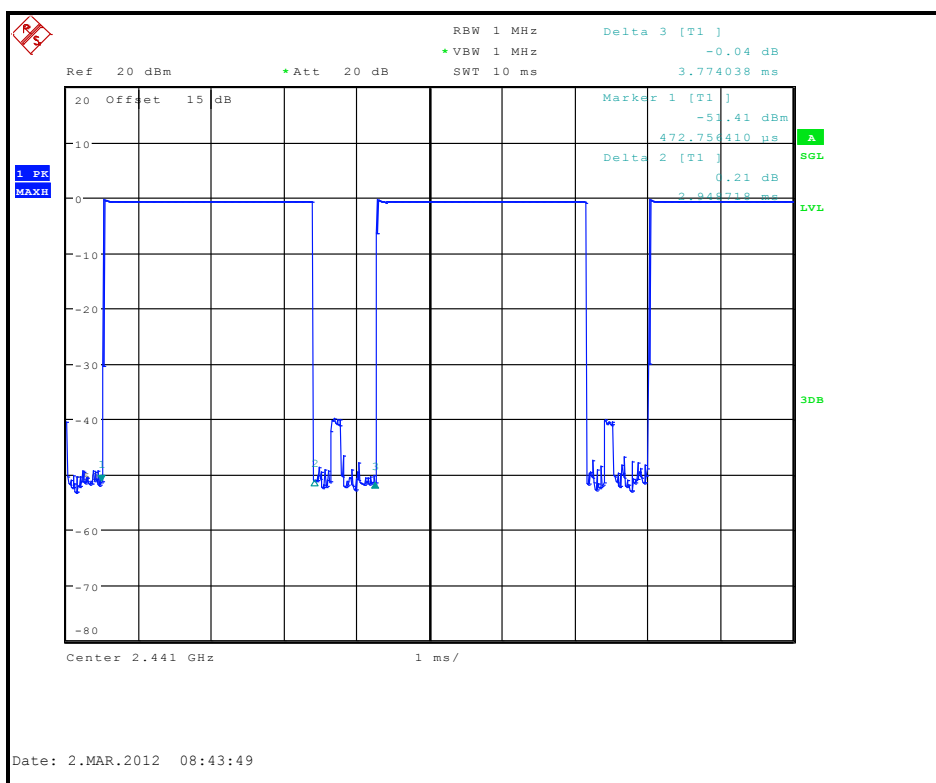
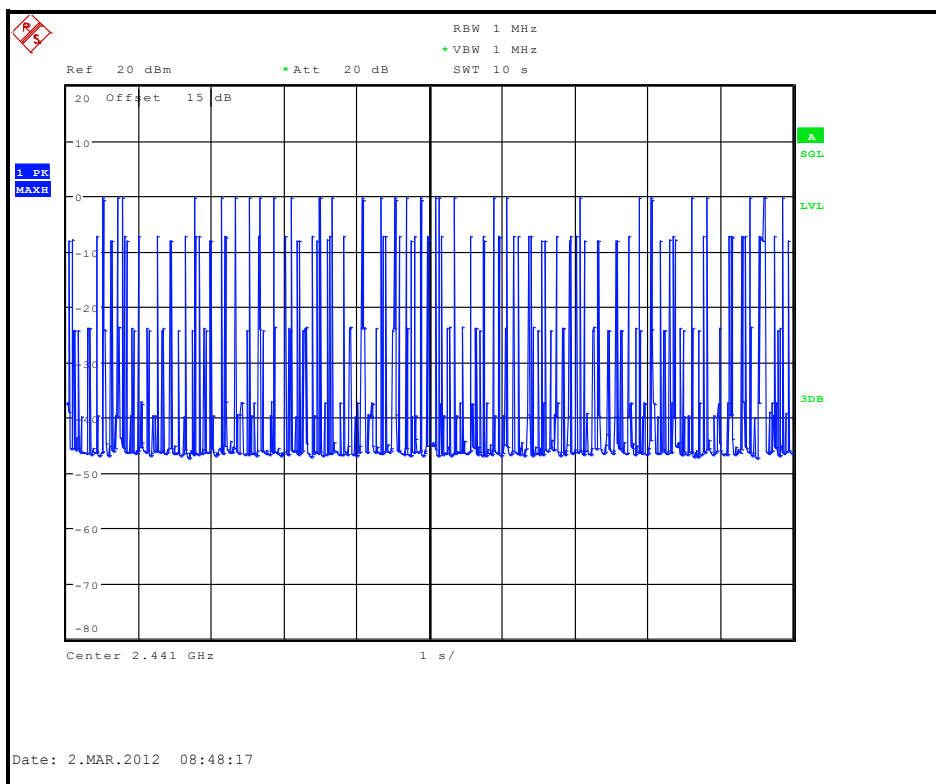



$\pi/4$ -DQPSK

Mode	Average Hopping Channel	Package Transfer Time (usec)	Dwell Time (sec)	Limit (msec)
DH1	9.50	405.77	0.12	400
DH3	5.20	1674.68	0.28	400
DH5	3.80	2932.69	0.35	400

NOTE:

1. Dwell Time=79(channels) x 0.4(s) x average hopping channel x package transfer time
2. 79 channels come from the Hopping Channel number
3. Average Hopping Channel = hops/sweep time
4. t: Package Transfer Time(us)
5. Test plots of the transmitting time slot are shown on next 3 pages.



A D T

DH1

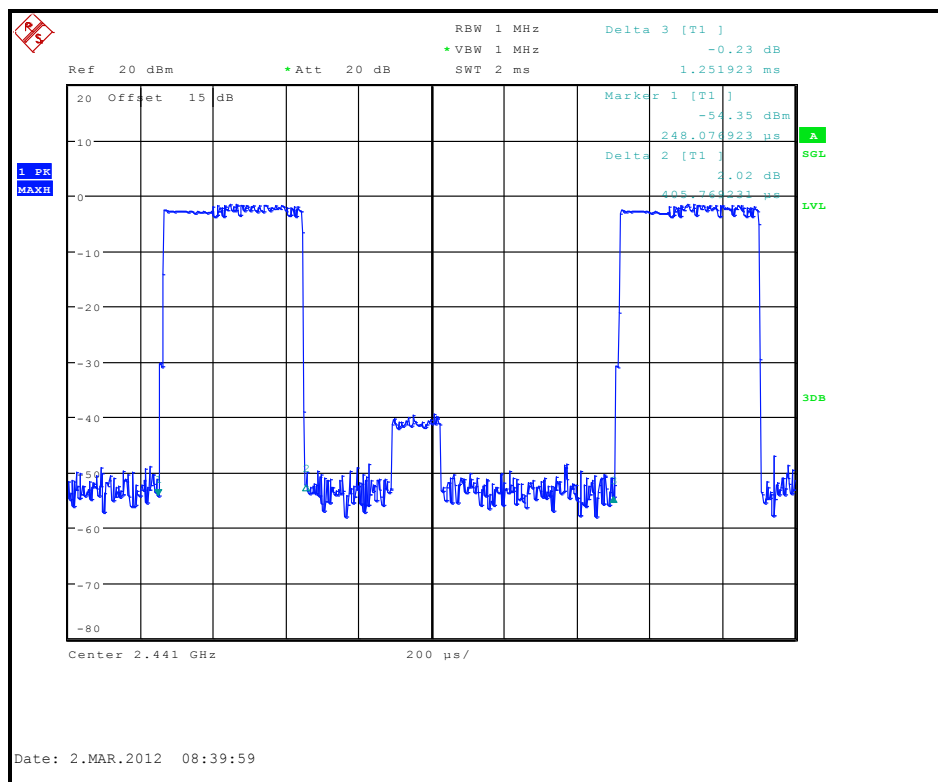
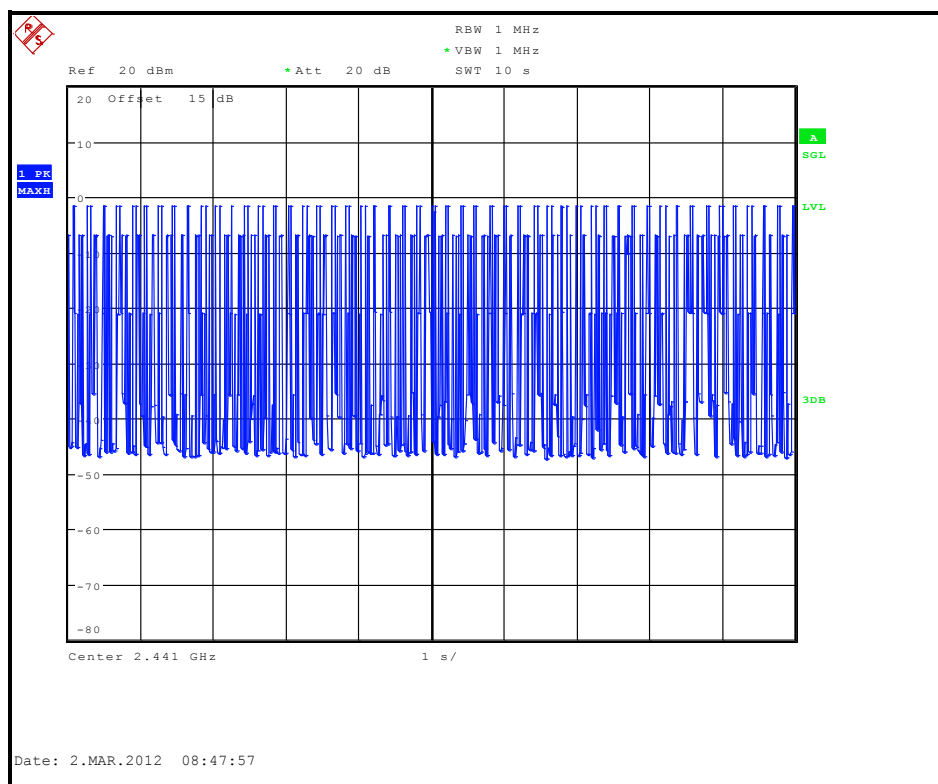

DH3

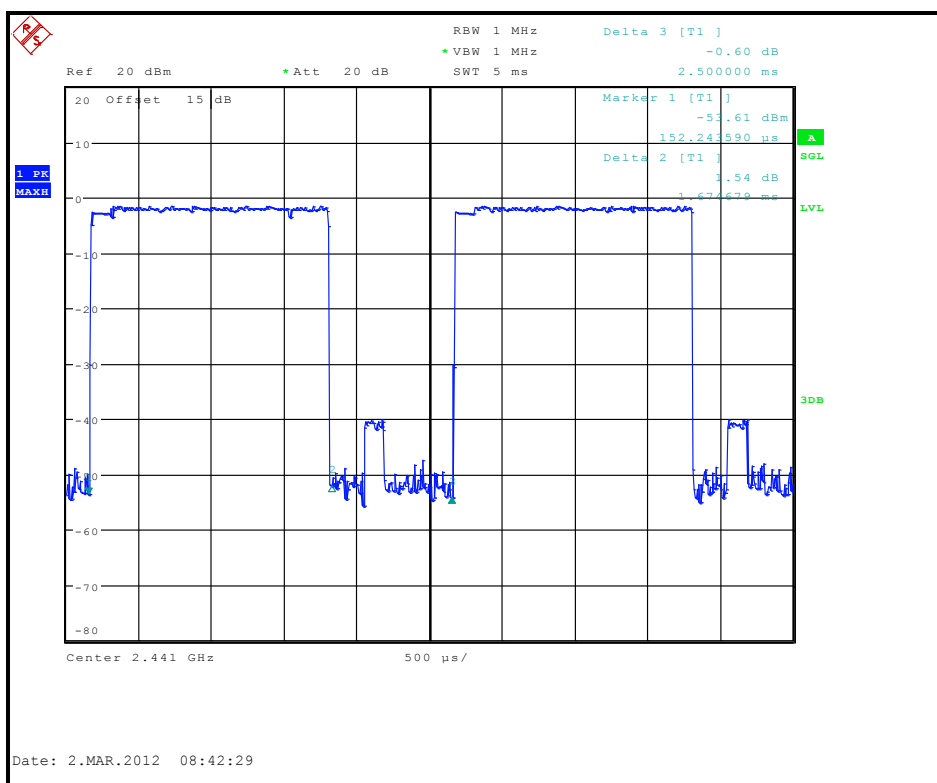
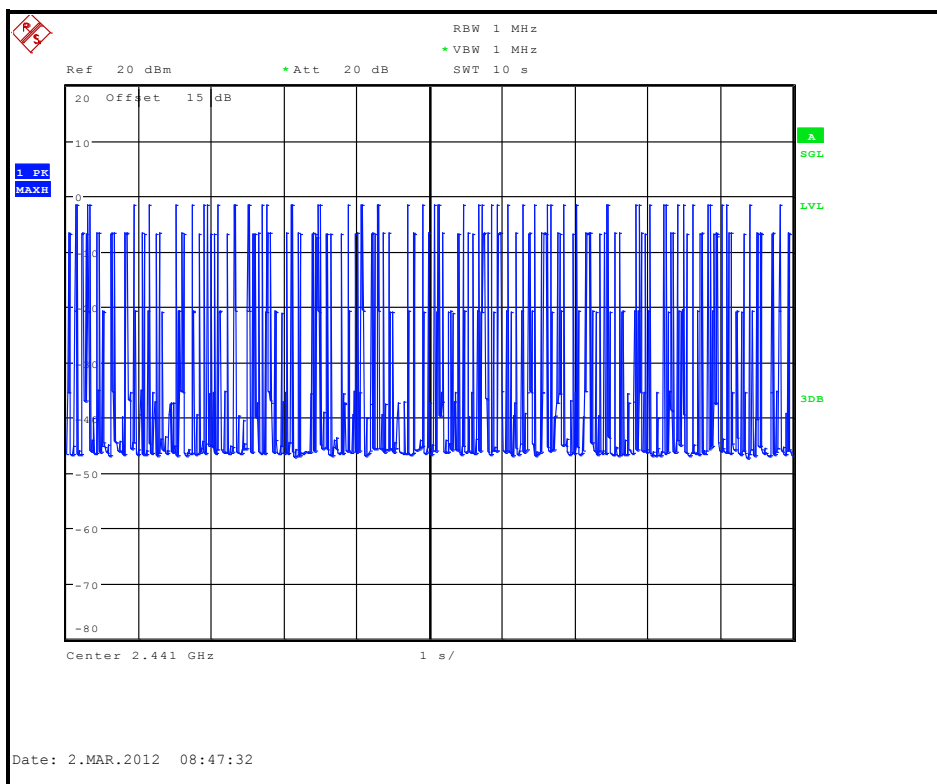



A D T

DH5

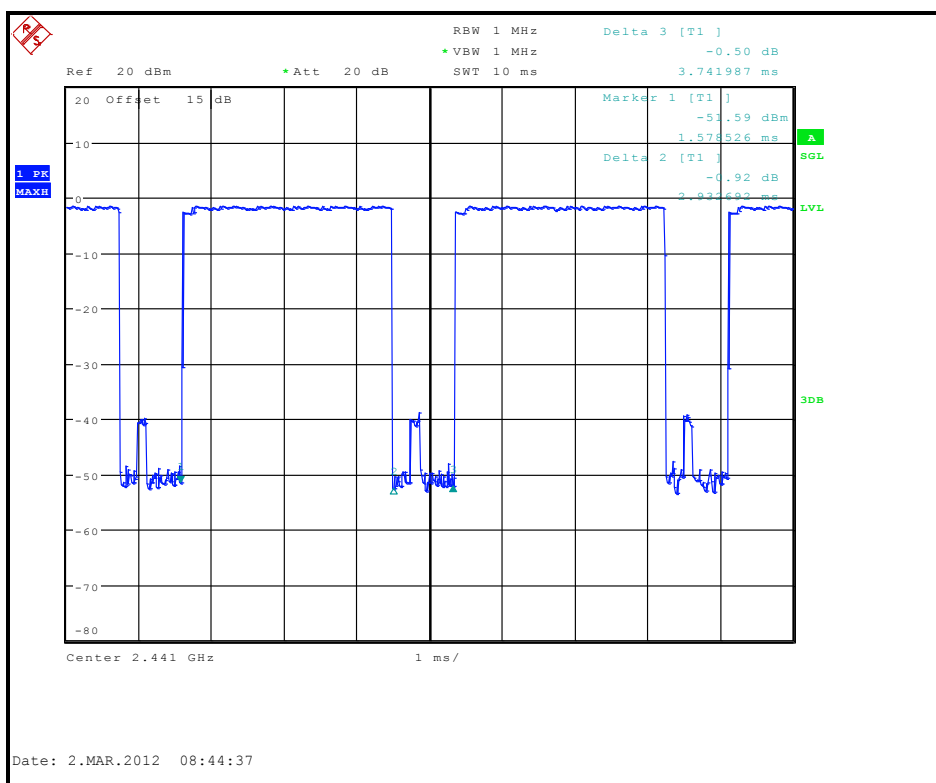
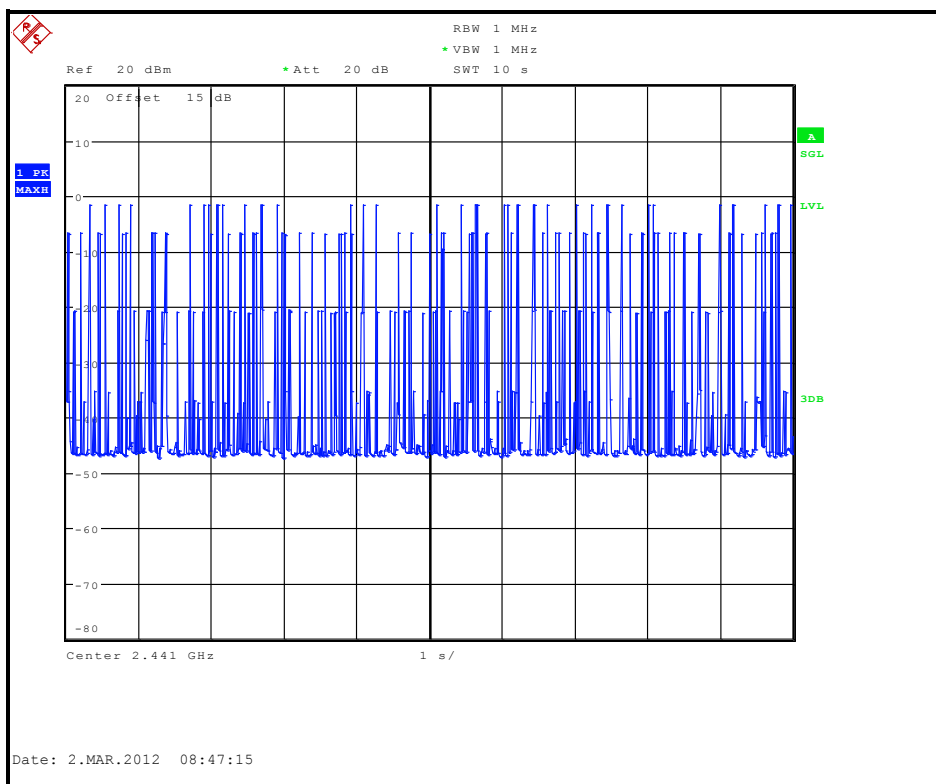



8DPSK

Mode	Average Hopping Channel	Package Transfer Time (usec)	Dwell Time (sec)	Limit (msec)
DH1	9.70	403.85	0.12	400
DH3	4.60	1674.68	0.24	400
DH5	3.60	2932.69	0.33	400

NOTE:

1. Dwell Time= $79(\text{channels}) \times 0.4(\text{s}) \times \text{average hopping channel} \times \text{package transfer time}$
2. 79 channels come from the Hopping Channel number
3. Average Hopping Channel = hops/sweep time
4. t: Package Transfer Time(us)
5. Test plots of the transmitting time slot are shown on next 3 pages.



A D T

DH1

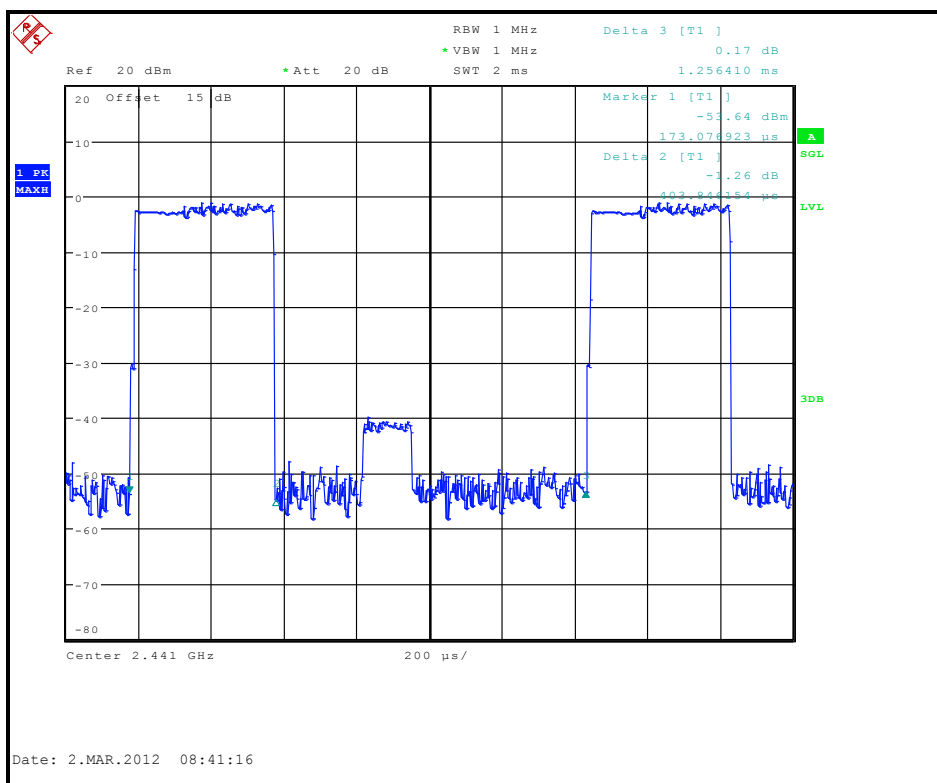
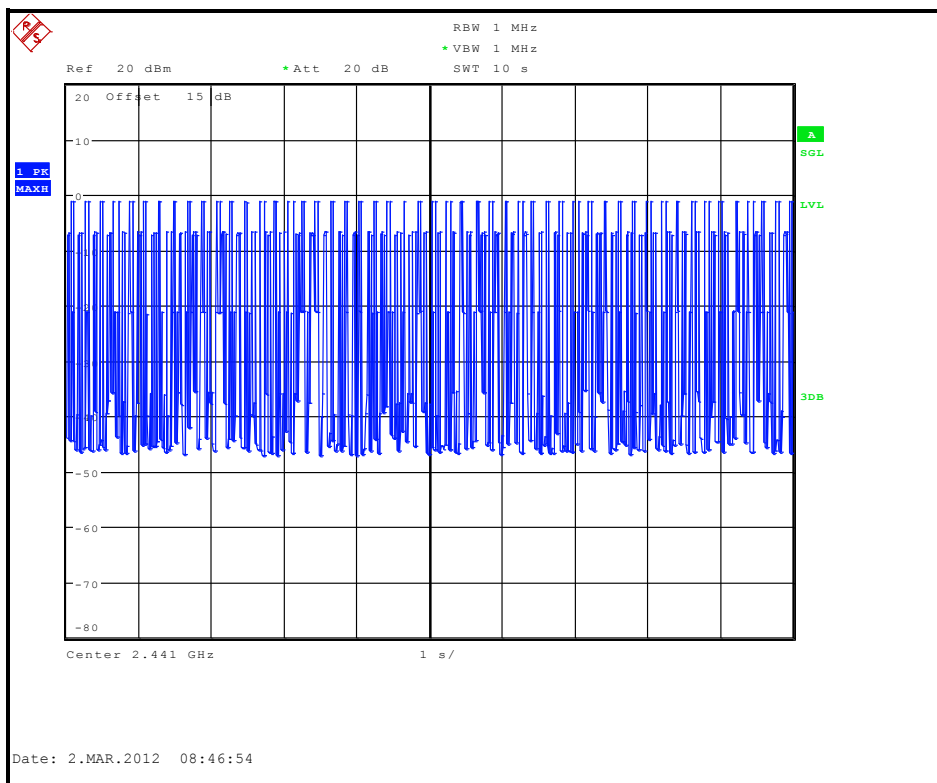

DH3

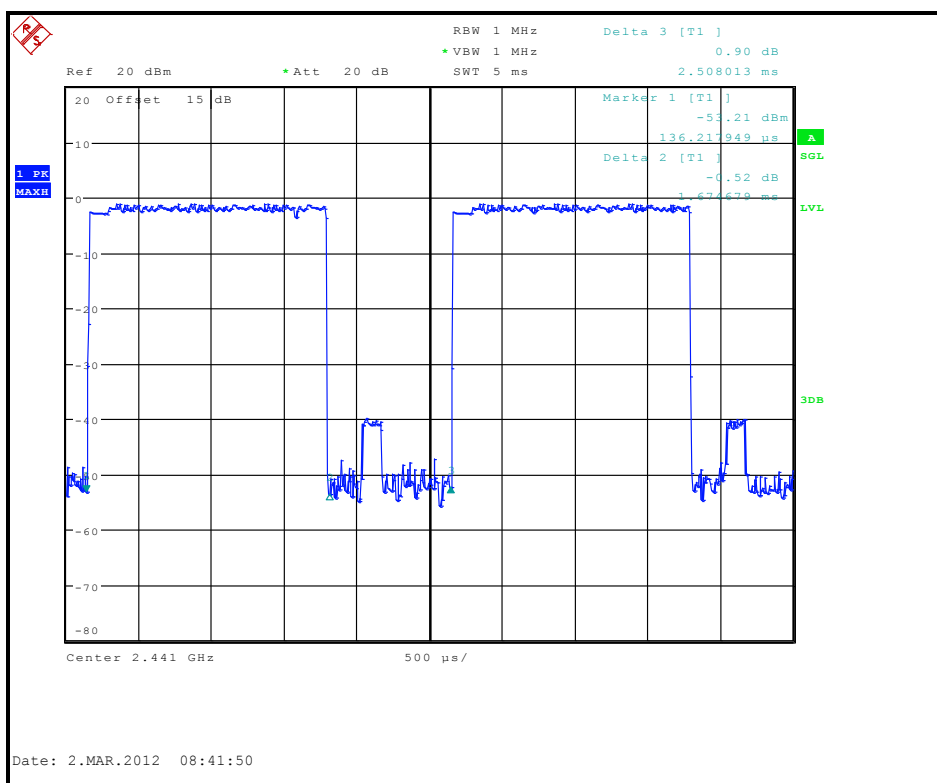
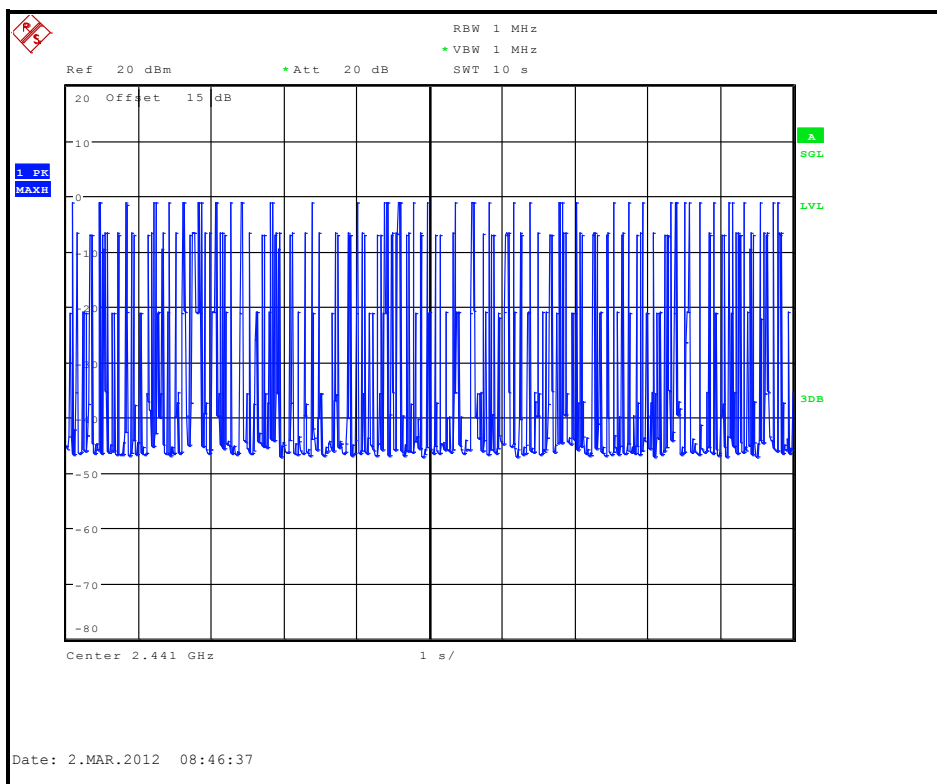



A D T

DH5

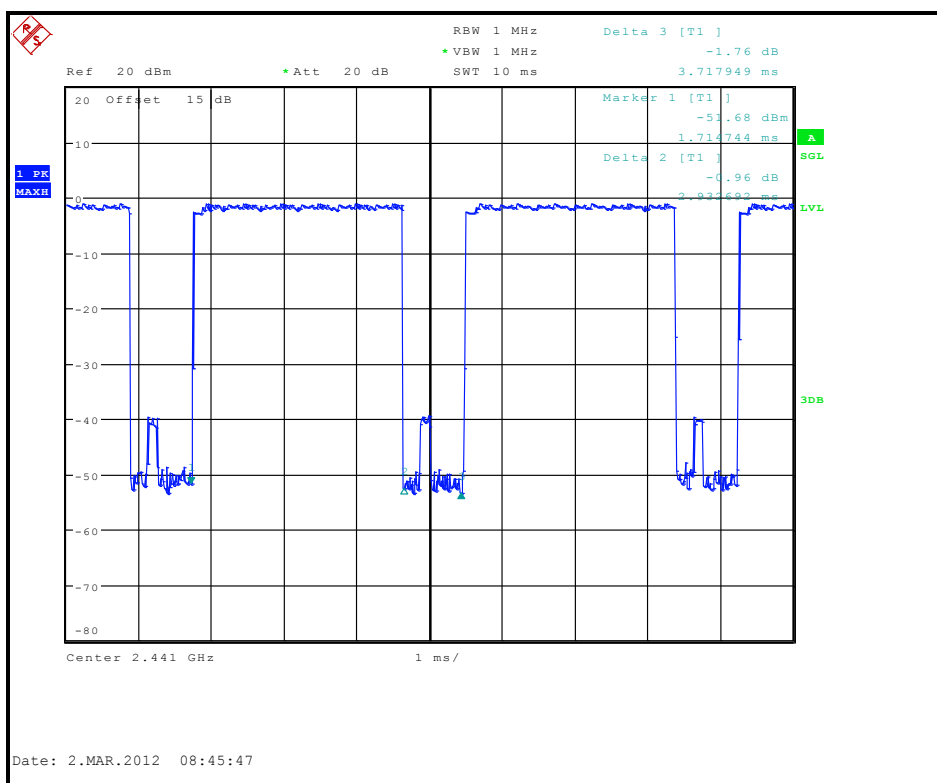
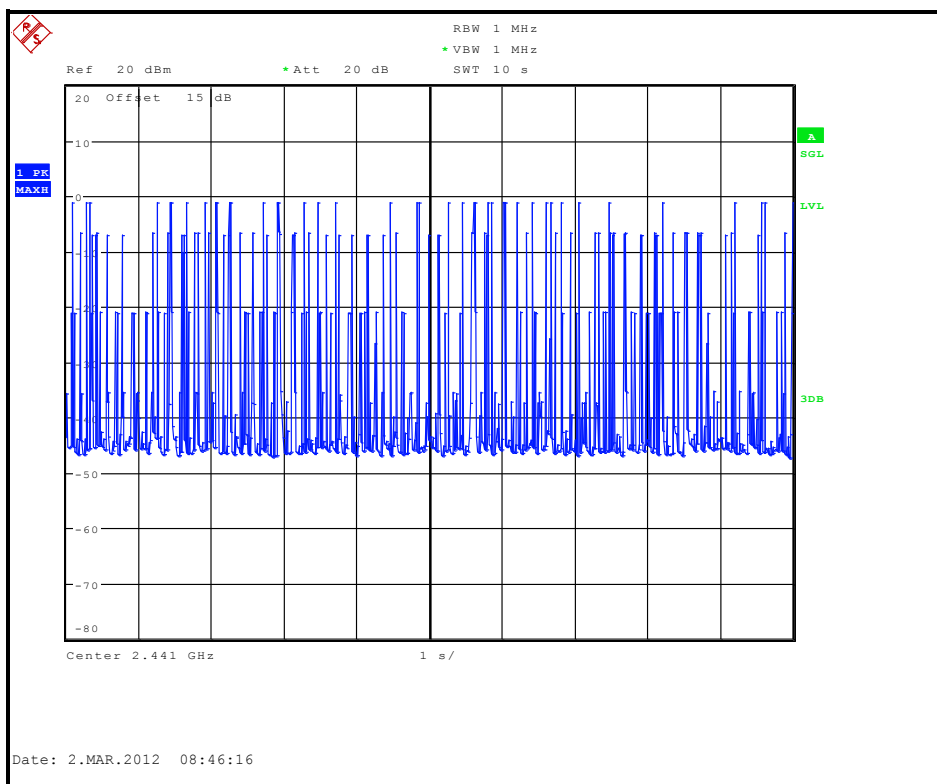

4.5 CHANNEL BANDWIDTH

4.5.1 LIMITS OF CHANNEL BANDWIDTH

For frequency hopping system operating in the 2400-2483.5MHz, If the 20dB bandwidth of hopping channel is greater than 25kHz, two-thirds 20dB bandwidth of hopping channel shall be a minimum limit for the hopping channel separation.

4.5.2 TEST SETUP

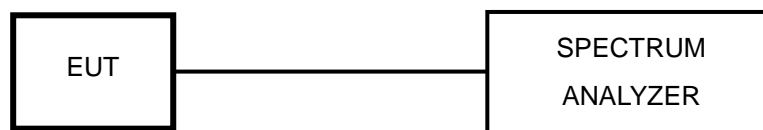

4.5.3 TEST INSTRUMENTS

Refer to section 4.1.2 to get information of above instrument.

4.5.4 TEST PROCEDURE

- a. Check the calibration of the measuring instrument using either an internal calibrator or a known signal from an external generator.
- b. Turn on the EUT and connect it to measurement instrument. Then set it to any one convenient frequency within its operating range. Set a reference level on the measuring instrument equal to the highest peak value.
- c. Measure the frequency difference of two frequencies that were attenuated 20dB from the reference level. Record the frequency difference as the emission bandwidth.
- d. Repeat above procedures until all frequencies measured were complete.

4.5.5 DEVIATION FROM TEST STANDARD

No deviation.

4.5.6 EUT OPERATING CONDITION

The software provided by client enabled the EUT to transmit and receive data at lowest, middle and highest channel frequencies individually.



A D T

4.5.7 TEST RESULTS

GFSK

CHANNEL	CHANNEL FREQUENCY (MHz)	20dB BANDWIDTH (MHz)
0	2402	0.960
39	2441	0.960
78	2480	0.960

CH 0

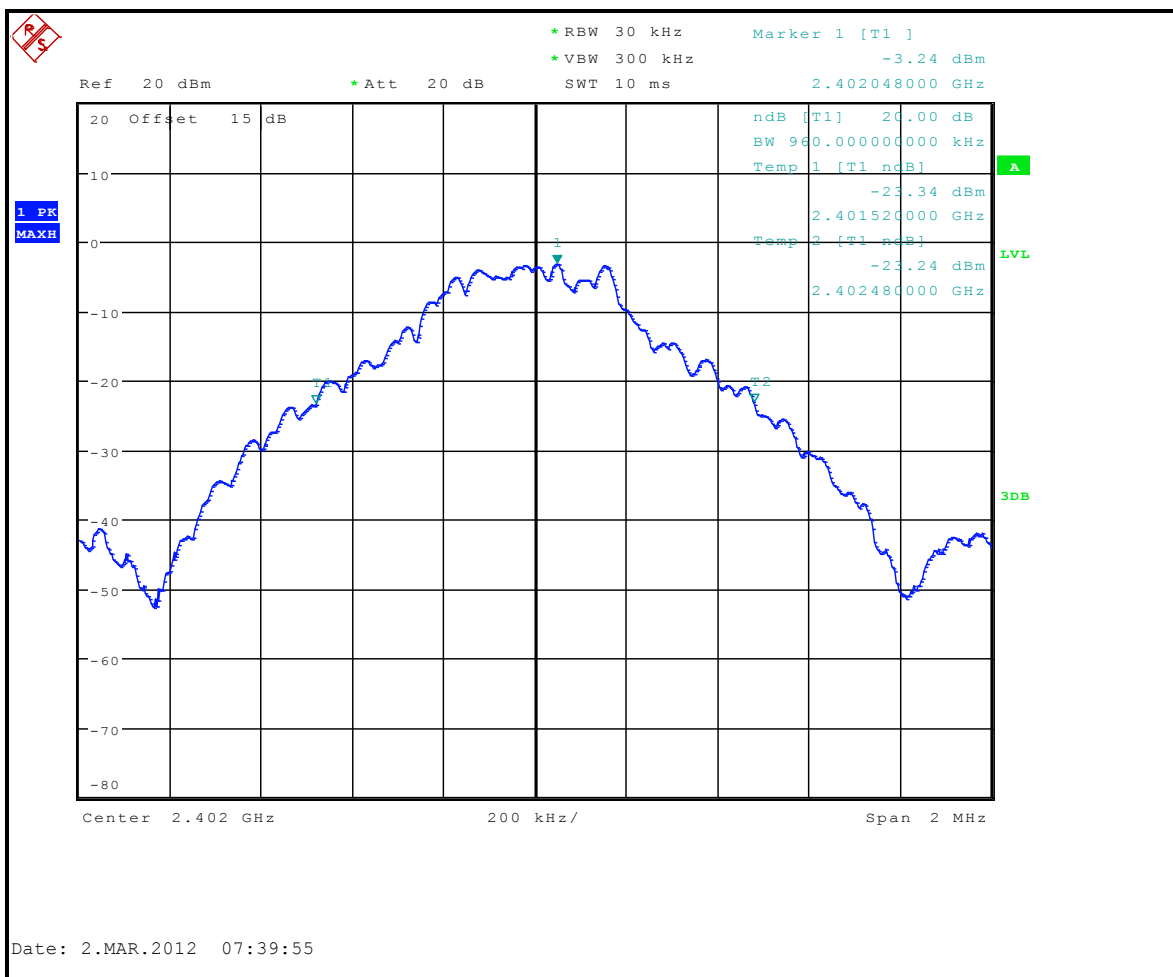



A D T

$\pi/4$ -DQPSK

CHANNEL	CHANNEL FREQUENCY (MHz)	20dB BANDWIDTH (MHz)
0	2402	1.328
39	2441	1.328
78	2480	1.328

CH 0

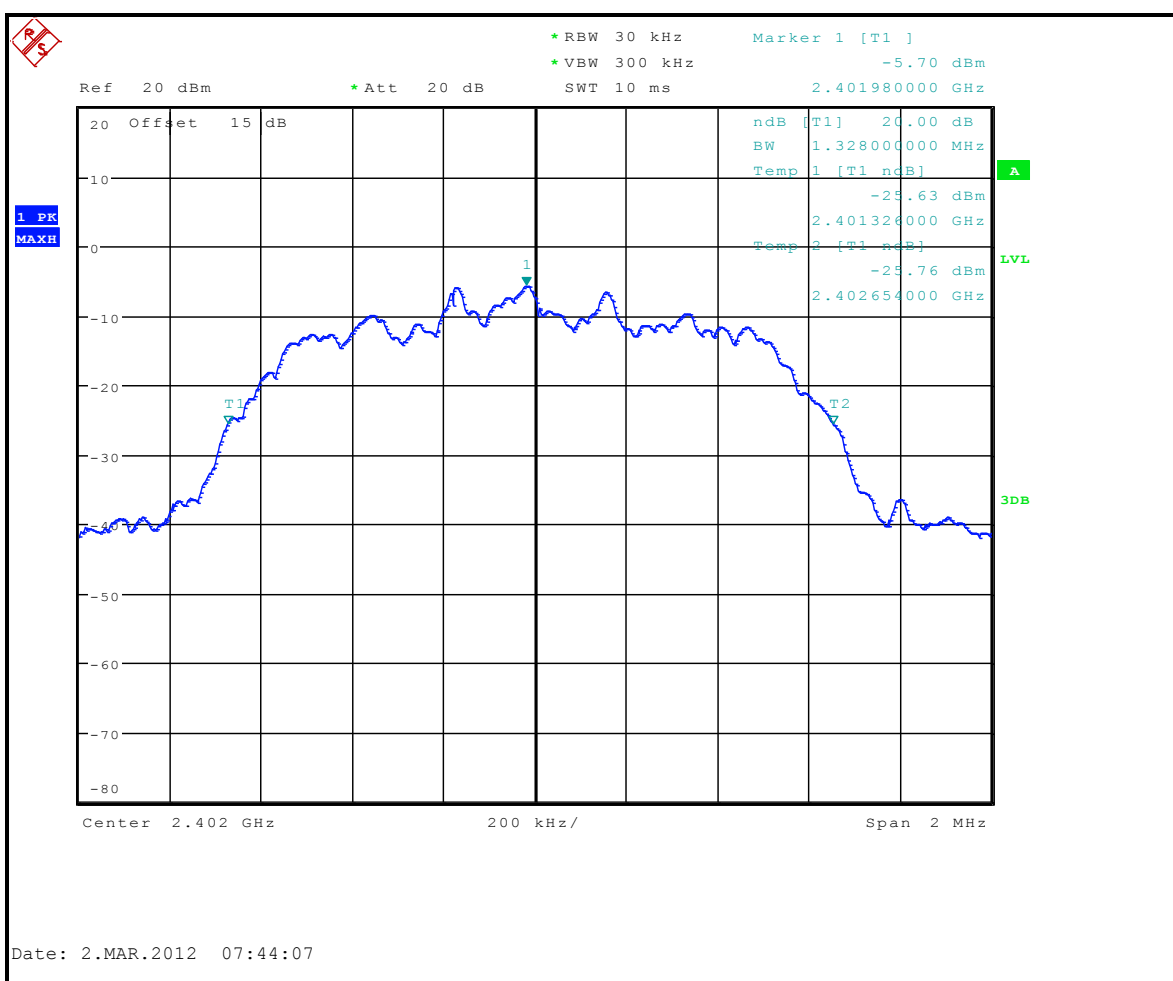



A D T

8DPSK

CHANNEL	CHANNEL FREQUENCY (MHz)	20dB BANDWIDTH (MHz)
0	2402	1.270
39	2441	1.272
78	2480	1.272

CH 78

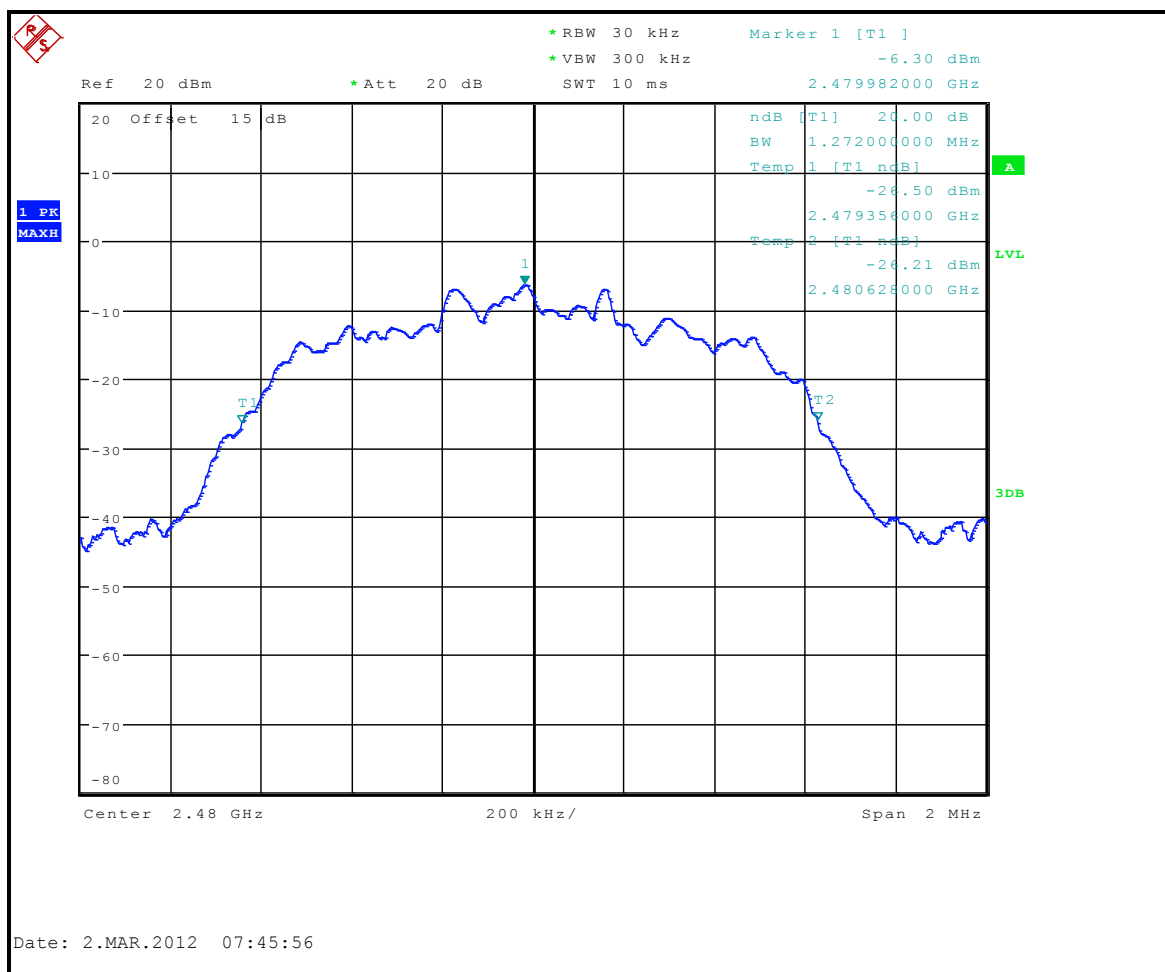

4.6 HOPPING CHANNEL SEPARATION

4.6.1 LIMIT OF HOPPING CHANNEL SEPARATION

At least 25kHz or two-third of 20dB hopping channel bandwidth (whichever is greater).

4.6.2 TEST SETUP

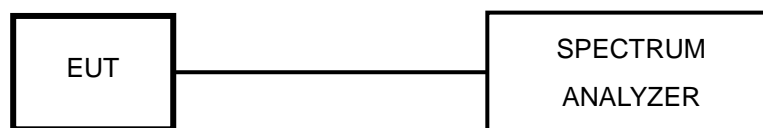

4.6.3 TEST INSTRUMENTS

Refer to section 4.1.2 to get information of above instrument.

4.6.4 TEST PROCEDURES

1. Check the calibration of the measuring instrument using either an internal calibrator or a known signal from an external generator.
2. Turn on the EUT and connect it to measurement instrument. Then set it to any one convenient frequency within its operating range.
3. By using the MaxHold function record the separation of two adjacent channels.
4. Measure the frequency difference of these two adjacent channels by SA MARK function. And then plot the result on SA screen.
5. Repeat above procedures until all frequencies measured were complete.

4.6.5 DEVIATION FROM TEST STANDARD

No deviation.

4.6.6 TEST RESULTS

GFSK

CHANNEL	FREQUENCY (MHz)	ADJACENT CHANNEL SEPARATION (MHz)	20dB BANDWIDTH (MHz)	MINIMUM LIMIT (MHz)	PASS / FAIL
0	2402	1.002	0.960	0.640	PASS
39	2441	1.002	0.960	0.640	PASS
78	2480	1.002	0.960	0.640	PASS

$\pi/4$ -DQPSK

CHANNEL	FREQUENCY (MHz)	ADJACENT CHANNEL SEPARATION (MHz)	20dB BANDWIDTH (MHz)	MINIMUM LIMIT (MHz)	PASS / FAIL
0	2402	1.002	1.328	0.885	PASS
39	2441	1.002	1.328	0.885	PASS
78	2480	1.002	1.328	0.885	PASS

8DPSK

CHANNEL	FREQUENCY (MHz)	ADJACENT CHANNEL SEPARATION (MHz)	20dB BANDWIDTH (MHz)	MINIMUM LIMIT (MHz)	PASS / FAIL
0	2402	1.002	1.270	0.847	PASS
39	2441	1.002	1.272	0.848	PASS
78	2480	1.002	1.272	0.848	PASS

NOTE: The minimum limit is two-third 20dB bandwidth.



A D T

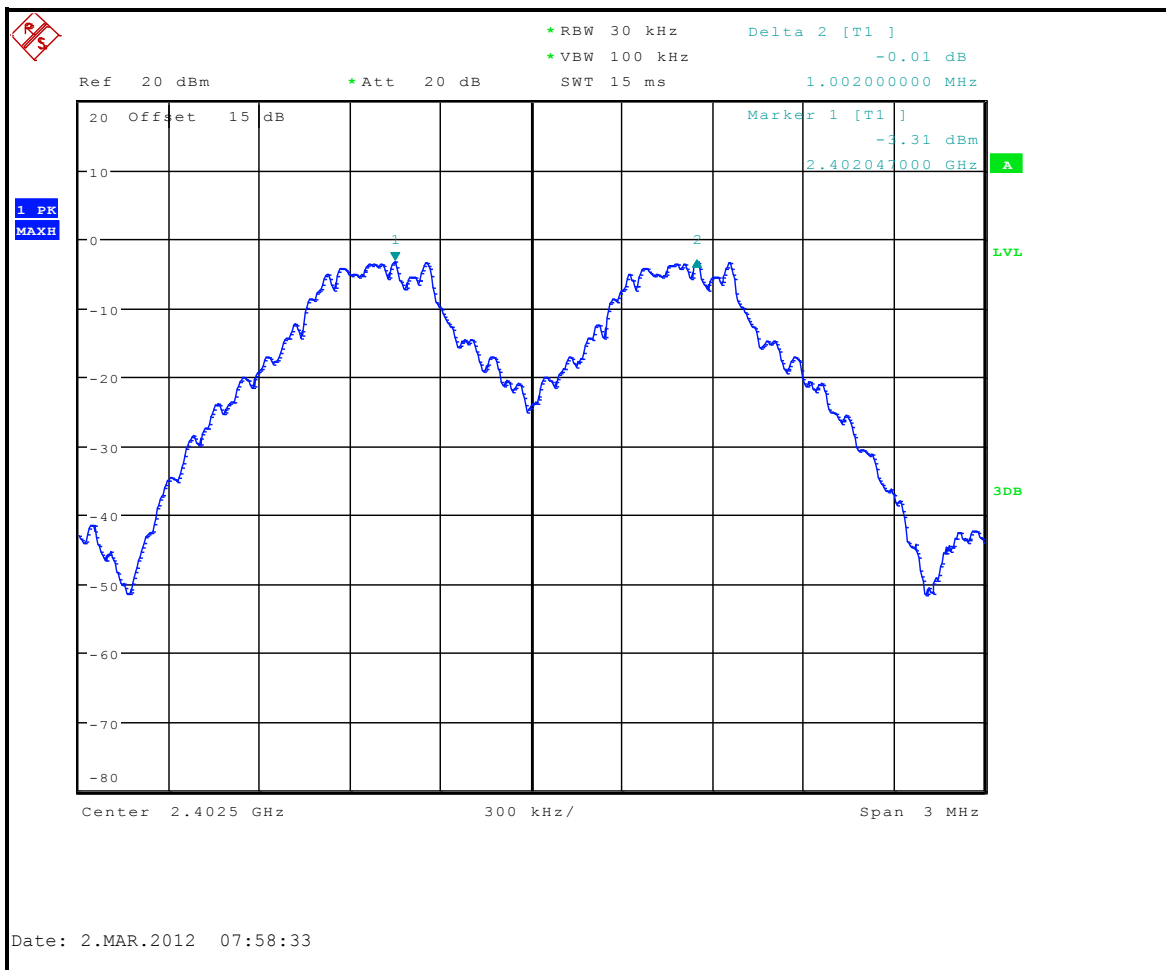

4.7 MAXIMUM OUTPUT POWER

4.7.1 LIMITS OF MAXIMUM OUTPUT POWER MEASUREMENT

The Maximum Output Power Measurement is 125mW.

4.7.2 TEST SETUP

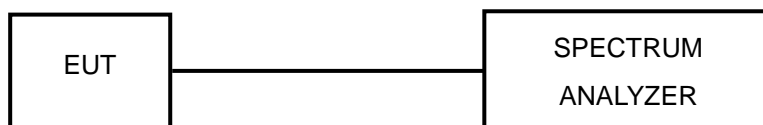

4.7.3 TEST INSTRUMENTS

Refer to section 4.1.2 to get information of above instrument.

4.7.4 TEST PROCEDURES

- a. Check the calibration of the measuring instrument using either an internal calibrator or a known signal from an external generator.
- b. Turn on the EUT and connect it to measurement instrument. Then set it to any one convenient frequency within its operating range. Set a reference level on the measuring instrument equal to the highest peak value.
- c. The center frequency of the spectrum analyzer is set to the fundamental frequency and using 3MHz RBW and 10 MHz VBW.
- d. Measure the captured power within the band and recording the plot.
- e. Repeat above procedures until all frequencies required were complete.

4.7.5 DEVIATION FROM TEST STANDARD

No deviation.

4.7.6 EUT OPERATING CONDITION

The software provided by client enabled the EUT to transmit and receive data at lowest, middle and highest channel frequencies individually.

4.7.7 TEST RESULTS

GFSK

CHANNEL	CHANNEL FREQUENCY (MHz)	POWER OUTPUT (mW)	POWER OUTPUT (dBm)	POWER LIMIT (mW)	PASS/FAIL
0	2402	1.014	0.06	125	PASS
39	2441	0.971	-0.13	125	PASS
78	2480	0.951	-0.22	125	PASS

$\pi/4$ -DQPSK

CHANNEL	CHANNEL FREQUENCY (MHz)	POWER OUTPUT (mW)	POWER OUTPUT (dBm)	POWER LIMIT (mW)	PASS/FAIL
0	2402	0.887	-0.52	125	PASS
39	2441	0.834	-0.79	125	PASS
78	2480	0.800	-0.97	125	PASS

8DPSK

CHANNEL	CHANNEL FREQUENCY (MHz)	POWER OUTPUT (mW)	POWER OUTPUT (dBm)	POWER LIMIT (mW)	PASS/FAIL
0	2402	0.971	-0.13	125	PASS
39	2441	0.920	-0.36	125	PASS
78	2480	0.877	-0.57	125	PASS



A D T

GFSK CH 0

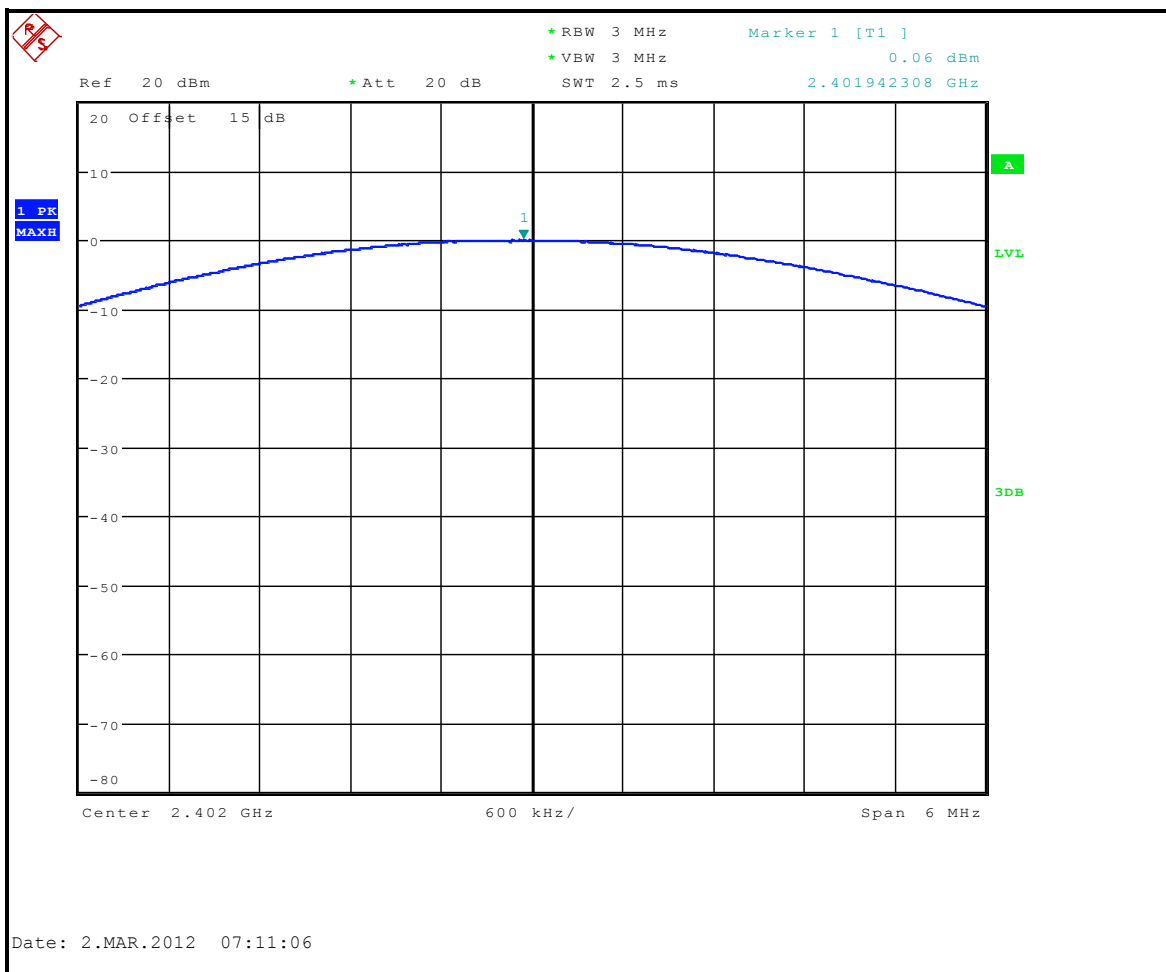

4.8 BAND EDGES MEASUREMENT

4.8.1 LIMITS OF BAND EDGES MEASUREMENT

Below -20dB of the highest emission level of operating band (in 100kHz RBW).

4.8.2 TEST INSTRUMENTS

Refer to section 4.1.2 to get information of above instrument.

4.8.3 TEST PROCEDURE

1. Set RBW = 100 kHz .
2. Set VBW = 300 kHz .
3. Set span to encompass the spectrum to be examined
4. Detector = peak.
5. Trace Mode = max hold.
6. Sweep = auto couple.

4.8.4 DEVIATION FROM TEST STANDARD

No deviation.

4.8.5 EUT OPERATING CONDITION

The software provided by client enabled the EUT to transmit continuously.

4.8.6 TEST RESULTS

The spectrum plots are attached on the following 8 images. D1 line indicates the highest level, D2 line indicates the 20dB offset below D1. It shows compliance with the requirement in part 15.247(d).



A D T

GFSK

Hopping disabled_ Low Channel

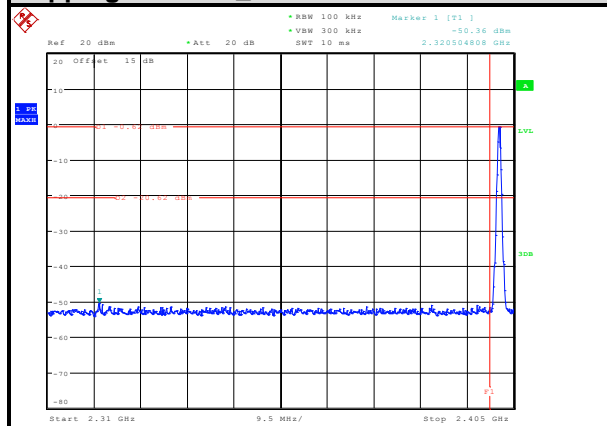

Date: 24.MAY.2012 04:13:03

Hopping disabled_ High Channel

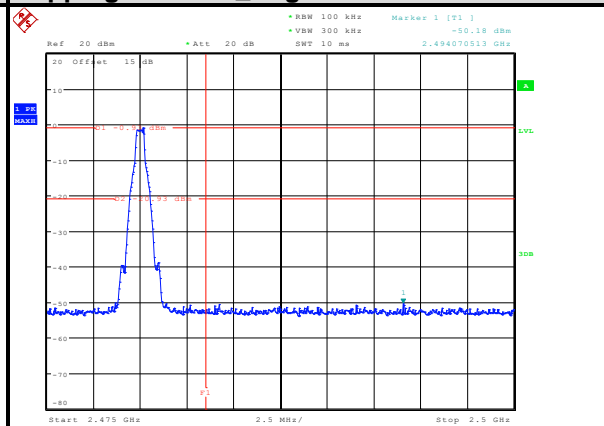

Date: 24.MAY.2012 04:13:21

Hopping enabled_ Low Channel

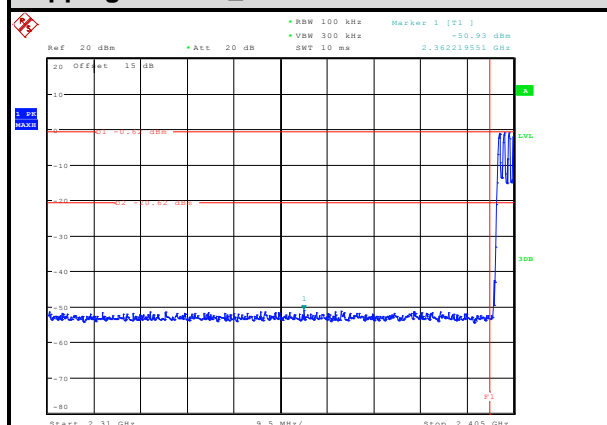

Date: 24.MAY.2012 04:17:03

Hopping enabled_ High Channel

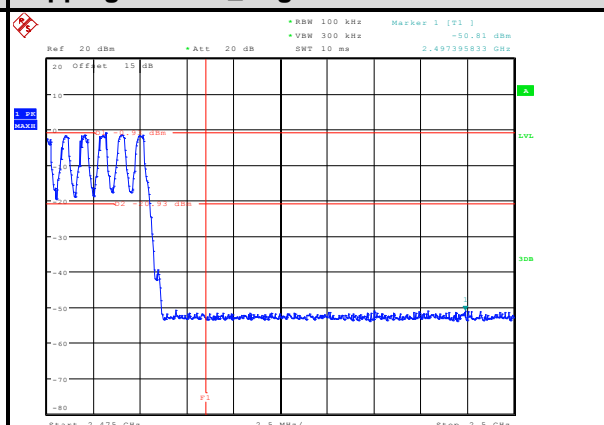

Date: 24.MAY.2012 04:15:36



A D T

$\pi/4$ -DQPSK

Hopping disabled_Low Channel

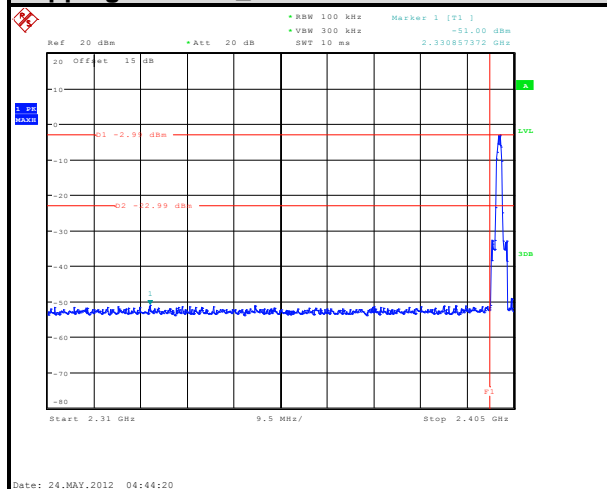

Hopping disabled_High Channel

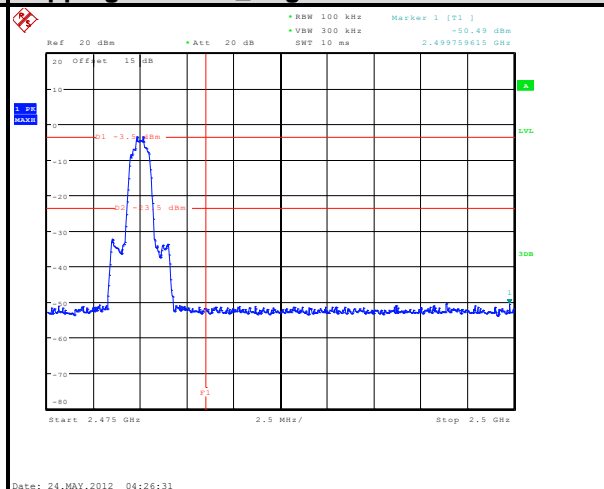

Hopping enabled_Low Channel

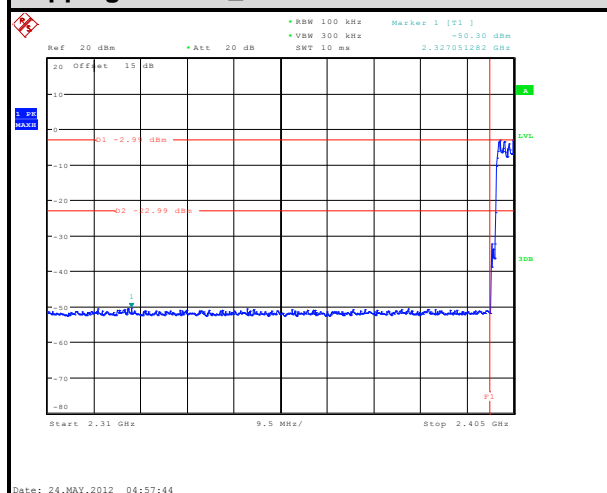

Hopping enabled_High Channel

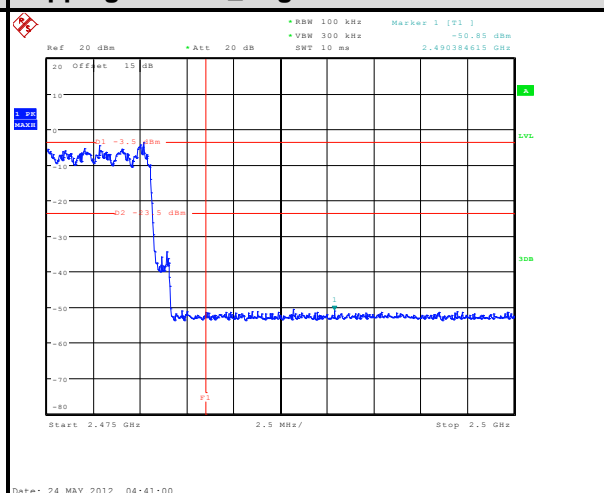



A D T

8DPSK

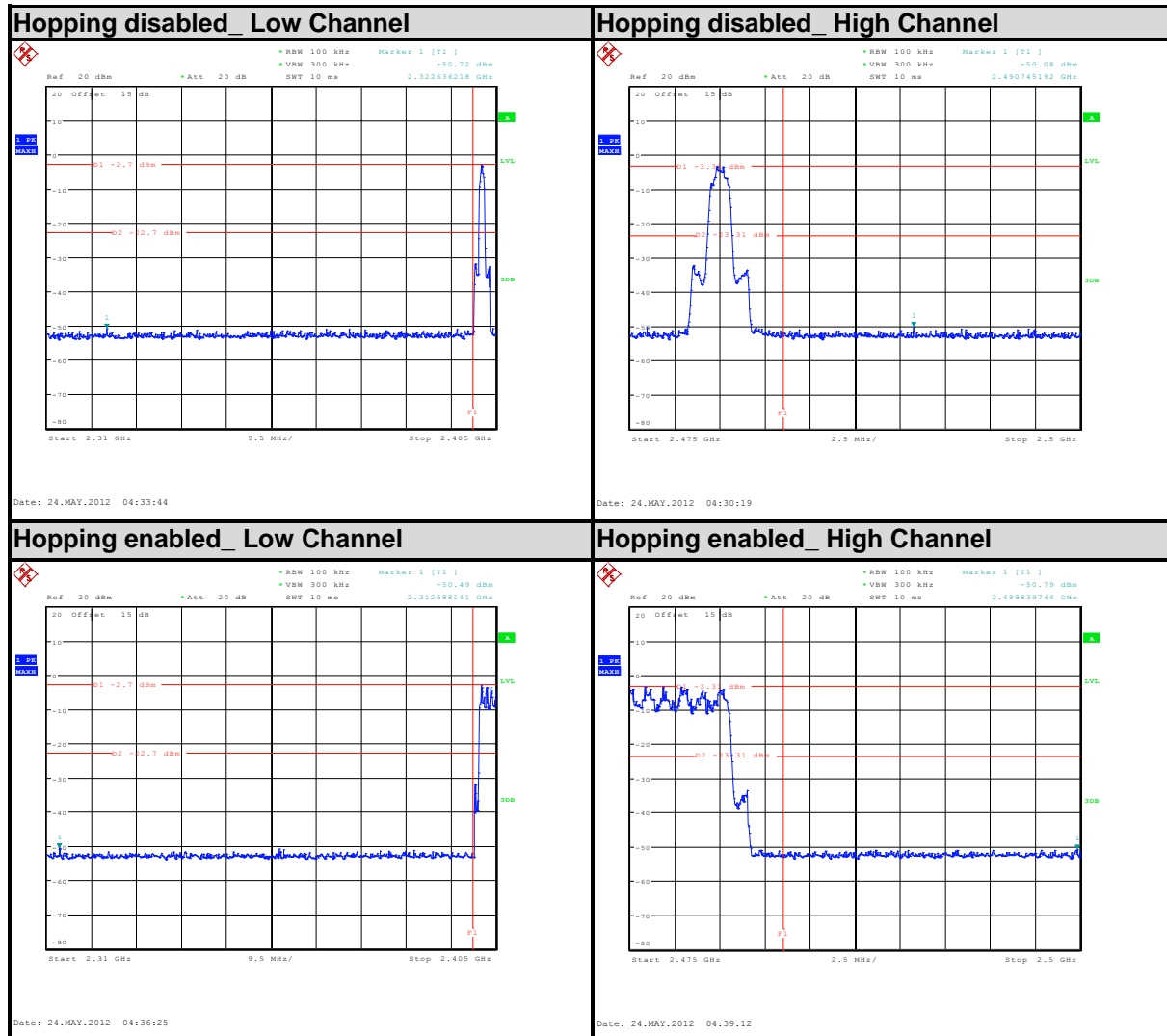

5. PHOTOGRAPHS OF THE TEST CONFIGURATION

Please refer to the attached file (Test Setup Photo).



6. INFORMATION ON THE TESTING LABORATORIES

We, Bureau Veritas Consumer Products Services (H.K.) Ltd., Taoyuan Branch, were founded in 1988 to provide our best service in EMC, Radio, Telecom and Safety consultation. Our laboratories are accredited and approved according to ISO/IEC 17025.

If you have any comments, please feel free to contact us at the following:

Linko EMC/RF Lab:

Tel: 886-2-26052180

Fax: 886-2-26051924

Hsin Chu EMC/RF Lab:

Tel: 886-3-5935343

Fax: 886-3-5935342

Hwa Ya EMC/RF/Safety Telecom Lab:

Tel: 886-3-3183232

Fax: 886-3-3270892

Email: service.adt@tw.bureauveritas.com

Web Site: www.adt.com.tw

The address and road map of all our labs can be found in our web site also.

7. APPENDIX A - MODIFICATIONS RECORDERS FOR ENGINEERING CHANGES TO THE EUT BY THE LAB

No modifications were made to the EUT by the lab during the test.

--- END ---