



# FCC TEST REPORT (15.247)

**REPORT NO.:** RF120309C35-4

**MODEL NO.:** FZ-A1BDAAAAM

**FCC ID:** ACJ9TGFZ-A13

**RECEIVED:** Dec. 21, 2011

**TESTED:** Feb. 21 ~ Mar. 12, 2012 and  
May 24, 2012

**ISSUED:** May 31, 2012

**APPLICANT:** Panasonic Corporation of North America

**ADDRESS:** One Panasonic Way, 4B-8 Secaucus, NJ 07094

**ISSUED BY:** Bureau Veritas Consumer Products Services (H.K.)  
Ltd., Taoyuan Branch

**LAB ADDRESS:** No. 47, 14th Ling, Chia Pau Vil., Lin Kou Dist., New  
Taipei City, Taiwan ( R.O.C )

**TEST LOCATION:** No. 19, Hwa Ya 2nd Rd, Wen Hwa Tsuen, Kwei  
Shan Hsiang, Taoyuan Hsien 333, Taiwan, R.O.C.

This report should not be used by the client to claim product certification, approval, or endorsement by TAF or any government agencies.



This report is for your exclusive use. Any copying or replication of this report to or for any other person or entity, or use of our name or trademark, is permitted only with our prior written permission. This report sets forth our findings solely with respect to the test samples identified herein. The results set forth in this report are not indicative or representative of the quality or characteristics of the lot from which a test sample was taken or any similar or identical product unless specifically and expressly noted. Our report includes all of the tests requested by you and the results thereof based upon the information that you provided to us. You have 60 days from date of issuance of this report to notify us of any material error or omission caused by our negligence, provided, however, that such notice shall be in writing and shall specifically address the issue you wish to raise. A failure to raise such issue within the prescribed time shall constitute your unqualified acceptance of the completeness of this report, the tests conducted and the correctness of the report contents. Unless specific mention, the uncertainty of measurement has been explicitly taken into account to declare the compliance or non-compliance to the specification



A D T

## TABLE OF CONTENTS

RELEASE CONTROL RECORD.....	6
1. CERTIFICATION.....	7
2. SUMMARY OF TEST RESULTS .....	8
2.1 MEASUREMENT UNCERTAINTY.....	8
3. GENERAL INFORMATION .....	9
3.1 GENERAL DESCRIPTION OF EUT .....	9
3.2 DESCRIPTION OF TEST MODES.....	11
3.2.1 TEST MODE APPLICABILITY AND TESTED CHANNEL DETAIL.....	12
3.3 DESCRIPTION OF SUPPORT UNITS .....	16
3.3.1 CONFIGURATION OF SYSTEM UNDER TEST .....	16
3.4 GENERAL DESCRIPTION OF APPLIED STANDARDS .....	16
4. TEST TYPES AND RESULTS (FOR 2.4GHZ BAND) .....	18
4.1 RADIATED EMISSION AND BANDEDGE MEASUREMENT .....	18
4.1.1 LIMITS OF RADIATED EMISSION AND BANDEDGE MEASUREMENT.....	18
4.1.2 TEST INSTRUMENTS.....	19
4.1.3 TEST PROCEDURES .....	20
4.1.4 DEVIATION FROM TEST STANDARD .....	20
4.1.5 TEST SETUP.....	21
4.1.6 EUT OPERATING CONDITIONS .....	21
4.1.7 TEST RESULTS.....	22
4.2 CONDUCTED EMISSION MEASUREMENT .....	34
4.2.1 LIMITS OF CONDUCTED EMISSION MEASUREMENT .....	34
4.2.2 TEST INSTRUMENTS.....	34
4.2.3 TEST PROCEDURES .....	35
4.2.4 DEVIATION FROM TEST STANDARD .....	35
4.2.5 TEST SETUP.....	36
4.2.6 EUT OPERATING CONDITIONS .....	36
4.2.7 TEST RESULTS.....	37
4.3 6DB BANDWIDTH MEASUREMENT .....	39
4.3.1 LIMITS OF 6DB BANDWIDTH MEASUREMENT .....	39
4.3.2 TEST SETUP.....	39
4.3.3 TEST INSTRUMENTS.....	39
4.3.4 TEST PROCEDURE .....	39



A D T

4.3.5	DEVIATION FROM TEST STANDARD .....	39
4.3.6	EUT OPERATING CONDITIONS .....	39
4.3.7	TEST RESULTS.....	40
4.4	CONDUCTED OUTPUT POWER.....	44
4.4.1	LIMITS OF CONDUCTED OUTPUT POWER MEASUREMENT.....	44
4.4.2	TEST SETUP.....	44
4.4.3	TEST INSTRUMENTS.....	44
4.4.4	TEST PROCEDURES .....	44
4.4.5	DEVIATION FROM TEST STANDARD .....	44
4.4.6	EUT OPERATING CONDITIONS .....	44
4.4.7	TEST RESULTS.....	45
4.5	POWER SPECTRAL DENSITY MEASUREMENT.....	46
4.5.1	LIMITS OF POWER SPECTRAL DENSITY MEASUREMENT .....	46
4.5.2	TEST SETUP.....	46
4.5.3	TEST INSTRUMENTS.....	46
4.5.4	TEST PROCEDURE .....	46
4.5.5	DEVIATION FROM TEST STANDARD .....	46
4.5.6	EUT OPERATING CONDITION.....	46
4.5.7	TEST RESULTS.....	47
4.6	BAND EDGES MEASUREMENT .....	51
4.6.1	LIMITS OF OUT OF BAND EMISSION MEASUREMENT .....	51
4.6.2	TEST SETUP.....	51
4.6.3	TEST INSTRUMENTS.....	51
4.6.4	TEST PROCEDURE.....	52
4.6.5	DEVIATION FROM TEST STANDARD .....	52
4.6.6	EUT OPERATING CONDITION.....	52
4.6.7	TEST RESULTS.....	52
5.	TEST TYPES AND RESULTS (FOR 5.0GHZ BAND) .....	57
5.1	RADIATED EMISSION AND BANDEDGE MEASUREMENT .....	57
5.1.1	LIMITS OF RADIATED EMISSION AND BANDEDGE MEASUREMENT.....	57
5.1.2	TEST INSTRUMENTS.....	58
5.1.3	TEST PROCEDURES .....	58
5.1.4	DEVIATION FROM TEST STANDARD .....	58
5.1.5	TEST SETUP.....	58
5.1.6	EUT OPERATING CONDITIONS .....	58



A D T

5.1.7	TEST RESULTS.....	59
5.2	CONDUCTED EMISSION MEASUREMENT .....	67
5.2.1	LIMITS OF CONDUCTED EMISSION MEASUREMENT .....	67
5.2.2	TEST INSTRUMENTS.....	67
5.2.3	TEST PROCEDURES .....	67
5.2.4	DEVIATION FROM TEST STANDARD .....	67
5.2.5	TEST SETUP.....	67
5.2.6	EUT OPERATING CONDITIONS .....	67
5.2.7	TEST RESULTS.....	68
5.3	6DB BANDWIDTH MEASUREMENT .....	70
5.3.1	LIMITS OF 6DB BANDWIDTH MEASUREMENT .....	70
5.3.2	TEST SETUP.....	70
5.3.3	TEST INSTRUMENTS.....	70
5.3.4	TEST PROCEDURE .....	70
5.3.5	DEVIATION FROM TEST STANDARD .....	70
5.3.6	EUT OPERATING CONDITIONS .....	70
5.3.7	TEST RESULTS.....	71
5.4	MAXIMUM OUTPUT POWER .....	74
5.4.1	LIMITS OF MAXIMUM OUTPUT POWER MEASUREMENT .....	74
5.4.2	TEST SETUP.....	74
5.4.3	INSTRUMENTS .....	74
5.4.4	TEST PROCEDURES .....	74
5.4.5	DEVIATION FROM TEST STANDARD .....	74
5.4.6	EUT OPERATING CONDITIONS .....	74
5.4.7	TEST RESULTS.....	75
5.5	POWER SPECTRAL DENSITY MEASUREMENT.....	76
5.5.1	LIMITS OF POWER SPECTRAL DENSITY MEASUREMENT .....	76
5.5.2	TEST SETUP.....	76
5.5.3	TEST INSTRUMENTS.....	76
5.5.4	TEST PROCEDURE.....	76
5.5.5	DEVIATION FROM TEST STANDARD .....	76
5.5.6	EUT OPERATING CONDITION.....	76
5.5.7	TEST RESULTS.....	77
5.6	BAND EDGES MEASUREMENT .....	80
5.6.1	LIMITS OF OUT OF BAND EMISSION MEASUREMENT .....	80



A D T

5.6.2	TEST SETUP .....	80
5.6.3	TEST INSTRUMENTS .....	80
5.6.4	TEST PROCEDURE .....	80
5.6.5	DEVIATION FROM TEST STANDARD .....	80
5.6.6	EUT OPERATING CONDITION.....	80
5.6.7	TEST RESULTS.....	80
6.	PHOTOGRAPHS OF THE TEST CONFIGURATION.....	84
7.	INFORMATION ON THE TESTING LABORATORIES .....	85
8.	APPENDIX A - MODIFICATIONS RECORDERS FOR ENGINEERING CHANGES TO THE EUT BY THE LAB .....	86



A D T

## RELEASE CONTROL RECORD

ISSUE NO.	REASON FOR CHANGE	DATE ISSUED
RF120309C35-4	Original release	May 31, 2012



A D T

## 1. CERTIFICATION

**PRODUCT:** Tablet PC

**MODEL:** FZ-A1BDAAAAM

**BRAND:** Panasonic

**APPLICANT:** Panasonic Corporation of North America

**TESTED:** Feb. 21 ~ Mar. 12, 2012 and May 24, 2012

**TEST SAMPLE:** Engineering Sample

**STANDARDS:** **FCC Part 15, Subpart C (Section 15.247)**

ANSI C63.10-2009

The above equipment (Model: FZ-A1BDAAAAM) has been tested by **Bureau Veritas Consumer Products Services (H.K.) Ltd., Taoyuan Branch**, and found compliance with the requirement of the above standards. The test record, data evaluation & Equipment Under Test (EUT) configurations represented herein are true and accurate accounts of the measurements of the sample's EMC characteristics under the conditions specified in this report.

**PREPARED BY** : Ivonne Wu , **DATE:** May 31, 2012  
Ivonne Wu / Senior Specialist

**APPROVED BY** : Gary Chang , **DATE:** May 31, 2012  
Gary Chang / Technical Manager

## 2. SUMMARY OF TEST RESULTS

The EUT has been tested according to the following specifications:

APPLIED STANDARD: FCC PART 15, SUBPART C (SECTION 15.247)			
STANDARD SECTION	TEST TYPE AND LIMIT	RESULT	REMARK
15.207	AC Power Conducted Emission	PASS	Meet the requirement of limit. Minimum passing margin is -3.62dB at 0.18125MHz.
15.247(d) 15.209	Radiated Emissions	PASS	Meet the requirement of limit. Minimum passing margin is -3.55dB at 2483.5MHz.
15.247(d)	Band Edge Measurement	PASS	Meet the requirement of limit.
15.247(a)(2)	6dB bandwidth	PASS	Meet the requirement of limit.
15.247(b)	Conducted power	PASS	Meet the requirement of limit.
15.247(e)	Power Spectral Density	PASS	Meet the requirement of limit.
15.203	Antenna Requirement	PASS	No antenna connector is used.

### 2.1 MEASUREMENT UNCERTAINTY

Where relevant, the following measurement uncertainty levels have been estimated for tests performed on the EUT as specified in CISPR 16-4-2:

MEASUREMENT	FREQUENCY	UNCERTAINTY
Conducted emissions	150kHz~30MHz	2.44 dB
Radiated emissions	30MHz ~ 200MHz	2.93 dB
	200MHz ~1000MHz	2.95 dB
	1GHz ~ 18GHz	2.26 dB
	18GHz ~ 40GHz	1.94 dB

This uncertainty represents an expanded uncertainty expressed at approximately the 95% confidence level using a coverage factor of  $k = 2$ .



A D T

### 3. GENERAL INFORMATION

#### 3.1 GENERAL DESCRIPTION OF EUT

<b>EUT</b>	Tablet PC
<b>MODEL NO.</b>	FZ-A1BDAAAAM
<b>POWER SUPPLY</b>	12Vdc (adapter) 7.4Vdc (battery)
<b>MODULATION TYPE</b>	CCK, DQPSK, DBPSK for DSSS 64QAM, 16QAM, QPSK, BPSK for OFDM
<b>TRANSFER RATE</b>	802.11b: 11.0/ 5.5/ 2.0/ 1.0Mbps 802.11g: 54.0/ 48.0/ 36.0/ 24.0/ 18.0/ 12.0/ 9.0/ 6.0Mbps 802.11a: 54.0/ 48.0/ 36.0/ 24.0/ 18.0/ 12.0/ 9.0/ 6.0Mbps 802.11n: up to 150.0Mbps
<b>MODULATION TECHNOLOGY</b>	DSSS, OFDM
<b>OPERATING FREQUENCY</b>	2.4GHz: 2412 ~ 2462MHz 5.0GHz: 5745 ~ 5825MHz
<b>NUMBER OF CHANNEL</b>	<b>2.4GHz:</b> 11 for 802.11b, 802.11g, 802.11n (20MHz) 7 for 802.11n (40MHz) <b>5.0GHz:</b> 5 for 802.11a, 802.11n (20MHz) 2 for 802.11n (40MHz)
<b>OUTPUT POWER</b>	200.447mW for 2412 ~ 2462MHz 137.721mW for 5745 ~ 5825MHz
<b>ANTENNA TYPE</b>	<b>2.4GHz:</b> PIFA antenna with 2.44dBi gain <b>5.0GHz:</b> PIFA antenna with 1.99dBi gain
<b>ANTENNA CONNECTOR</b>	NA
<b>DATA CABLE</b>	NA
<b>I/O PORTS</b>	Refer to user's manual
<b>ACCESSORY DEVICES</b>	Refer to Note as below



A D T

**NOTE:**

1. The EUT contains following accessory devices.

ITEM	BRAND	MODEL	SPECIFICATION
Adapter	JRC	NJD-9370	Input: 100-240Vac, 50/60Hz , 0.5A~0.3A Output: 12Vdc, 2A Power line: 0.7m non-shielded cable without core
Battery	SANYO	2UF484462-3-T0775	Rating: 7.4Vdc Type: Li-ion
LCD Panel	Hannstar	HSD100PXN1	--
Main Camera	D-Max Technology	HAC-001502-W1A	--
2 <sup>nd</sup> Camera	D-Max Technology	HAC-002103-W1A	--

2. The above EUT information is declared by the manufacturer and for more detailed features description, please refer to the manufacturer's specifications or User's Manual.



### 3.2 DESCRIPTION OF TEST MODES

#### FOR 2.4GHz:

11 channels are provided for 802.11b, 802.11g and 802.11n (20MHz):

CHANNEL	FREQUENCY	CHANNEL	FREQUENCY
1	2412MHz	7	2442MHz
2	2417MHz	8	2447MHz
3	2422MHz	9	2452MHz
4	2427MHz	10	2457MHz
5	2432MHz	11	2462MHz
6	2437MHz		

7 channels are provided for 802.11n (40MHz):

CHANNEL	FREQUENCY	CHANNEL	FREQUENCY
1	2422MHz	5	2442MHz
2	2427MHz	6	2447MHz
3	2432MHz	7	2452MHz
4	2437MHz		

#### FOR 5.0GHz (5745 ~ 5825MHz):

5 channels are provided for 802.11a, 802.11n (20MHz):

CHANNEL	FREQUENCY	CHANNEL	FREQUENCY
149	5745MHz	161	5805MHz
153	5765MHz	165	5825MHz
157	5785MHz		

2 channels are provided for 802.11n (40MHz):

CHANNEL	FREQUENCY	CHANNEL	FREQUENCY
151	5755MHz	159	5795MHz



### 3.2.1 TEST MODE APPLICABILITY AND TESTED CHANNEL DETAIL

#### FOR 2.4GHz:

EUT CONFIGURE MODE	APPLICABLE TO			DESCRIPTION
	RE	PLC	APCM	
-	√	√	√	-

Where **RE:** Radiated Emission **PLC:** Power Line Conducted Emission  
**APCM:** Antenna Port Conducted Measurement

**NOTE:**

The EUT had been pre-tested on the positioned of each 3 axis. The worst case was found when positioned on **X-plane**.

#### RADIATED EMISSION TEST:

- Pre-Scan has been conducted to determine the worst-case mode from all possible combinations between available modulations, data rates and antenna ports (if EUT with antenna diversity architecture).
- Following channel(s) was (were) selected for the final test as listed below.

EUT CONFIGURE MODE	MODE	AVAILABLE CHANNEL	TESTED CHANNEL	MODULATION TECHNOLOGY	MODULATION TYPE	DATA RATE (Mbps)
-	802.11b	1 to 11	1, 6, 11	DSSS	DBPSK	1.0
-	802.11g	1 to 11	1, 6, 11	OFDM	BPSK	6.0
-	802.11n (20MHz)	1 to 11	1, 6, 11	OFDM	BPSK	65.0
-	802.11n (40MHz)	1 to 7	1, 4, 7	OFDM	BPSK	120.0

#### POWER LINE CONDUCTED EMISSION TEST:

- Pre-Scan has been conducted to determine the worst-case mode from all possible combinations between available modulations, data rates and antenna ports (if EUT with antenna diversity architecture).
- Following channel(s) was (were) selected for the final test as listed below.

EUT CONFIGURE MODE	MODE	AVAILABLE CHANNEL	TESTED CHANNEL	MODULATION TECHNOLOGY	MODULATION TYPE	DATA RATE (Mbps)
-	802.11n (20MHz)	1 to 11	1	OFDM	BPSK	65.0



A D T

### **BANDEDGE MEASUREMENT:**

- Pre-Scan has been conducted to determine the worst-case mode from all possible combinations between available modulations, data rates and antenna ports (if EUT with antenna diversity architecture).
- Following channel(s) was (were) selected for the final test as listed below.

EUT CONFIGURE MODE	MODE	AVAILABLE CHANNEL	TESTED CHANNEL	MODULATION TECHNOLOGY	MODULATION TYPE	DATA RATE (Mbps)
-	802.11b	1 to 11	1, 11	DSSS	DBPSK	1.0
-	802.11g	1 to 11	1, 11	OFDM	BPSK	6.0
-	802.11n (20MHz)	1 to 11	1, 11	OFDM	BPSK	65.0
-	802.11n (40MHz)	1 to 7	1, 7	OFDM	BPSK	120.0

### **ANTENNA PORT CONDUCTED MEASUREMENT:**

- Pre-Scan has been conducted to determine the worst-case mode from all possible combinations between available modulations, data rates and antenna ports (if EUT with antenna diversity architecture).
- Following channel(s) was (were) selected for the final test as listed below.

EUT CONFIGURE MODE	MODE	AVAILABLE CHANNEL	TESTED CHANNEL	MODULATION TECHNOLOGY	MODULATION TYPE	DATA RATE (Mbps)
-	802.11b	1 to 11	1, 6, 11	DSSS	DBPSK	1.0
-	802.11g	1 to 11	1, 6, 11	OFDM	BPSK	6.0
-	802.11n (20MHz)	1 to 11	1, 6, 11	OFDM	BPSK	65.0
-	802.11n (40MHz)	1 to 7	1, 4, 7	OFDM	BPSK	120.0

### **TEST CONDITION:**

APPLICABLE TO	ENVIRONMENTAL CONDITIONS	INPUT POWER	TESTED BY
RE	25deg. C, 65%RH	120Vac, 60Hz	Kay Wu
PLC	25deg. C, 67%RH	120Vac, 60Hz	Scott Yang
APCM	25deg. C, 53%RH	120Vac, 60Hz	Phoenix Chen



**FOR 5.745 ~ 5.825GHz:**

EUT CONFIGURE MODE	APPLICABLE TO			DESCRIPTION
	RE	PLC	APCM	
-	√	√	√	-

Where **PLC:** Power Line Conducted Emission      **RE:** Radiated Emission  
**APCM:** Antenna Port Conducted Measurement

**RADIATED EMISSION TEST:**

- Pre-Scan has been conducted to determine the worst-case mode from all possible combinations between available modulations, data rates and antenna ports (if EUT with antenna diversity architecture).
- Following channel(s) was (were) selected for the final test as listed below.

EUT CONFIGURE MODE	MODE	AVAILABLE CHANNEL	TESTED CHANNEL	MODULATION TECHNOLOGY	MODULATION TYPE	DATA RATE (Mbps)
-	802.11a	149 to 165	149, 157, 165	OFDM	BPSK	6.0
-	802.11n (20MHz)	149 to 165	149, 157, 165	OFDM	BPSK	7.2
-	802.11n (40MHz)	151 to 159	151, 159	OFDM	BPSK	120.0

**POWER LINE CONDUCTED EMISSION TEST:**

- Pre-Scan has been conducted to determine the worst-case mode from all possible combinations between available modulations, data rates and antenna ports (if EUT with antenna diversity architecture).
- Following channel(s) was (were) selected for the final test as listed below.

EUT CONFIGURE MODE	MODE	AVAILABLE CHANNEL	TESTED CHANNEL	MODULATION TECHNOLOGY	MODULATION TYPE	DATA RATE (Mbps)
-	802.11n (40MHz)	151 to 159	151	OFDM	BPSK	120.0



A D T

### **BANDEDGE MEASUREMENT:**

- Pre-Scan has been conducted to determine the worst-case mode from all possible combinations between available modulations, data rates and antenna ports (if EUT with antenna diversity architecture).
- Following channel(s) was (were) selected for the final test as listed below.

EUT CONFIGURE MODE	MODE	AVAILABLE CHANNEL	TESTED CHANNEL	MODULATION TECHNOLOGY	MODULATION TYPE	DATA RATE (Mbps)
-	802.11a	149 to 165	149, 165	OFDM	BPSK	6.0
-	802.11n (20MHz)	149 to 165	149, 165	OFDM	BPSK	7.2
-	802.11n (40MHz)	151 to 159	151, 159	OFDM	BPSK	120.0

### **ANTENNA PORT CONDUCTED MEASUREMENT:**

- Pre-Scan has been conducted to determine the worst-case mode from all possible combinations between available modulations, data rates and antenna ports (if EUT with antenna diversity architecture).
- Following channel(s) was (were) selected for the final test as listed below.

EUT CONFIGURE MODE	MODE	AVAILABLE CHANNEL	TESTED CHANNEL	MODULATION TECHNOLOGY	MODULATION TYPE	DATA RATE (Mbps)
-	802.11a	149 to 165	149, 157, 165	OFDM	BPSK	6.0
-	802.11n (20MHz)	149 to 165	149, 157, 165	OFDM	BPSK	7.2
-	802.11n (40MHz)	151 to 159	151, 159	OFDM	BPSK	120.0

### **TEST CONDITION:**

APPLICABLE TO	ENVIRONMENTAL CONDITIONS	INPUT POWER	TESTED BY
RE	25deg. C, 65%RH	120Vac, 60Hz	Kay Wu
PLC	25deg. C, 67%RH	120Vac, 60Hz	Scott Yang
APCM	25deg. C, 53%RH	120Vac, 60Hz	Phoenix Chen

### 3.3 DESCRIPTION OF SUPPORT UNITS

The EUT has been tested as an independent unit together with other necessary accessories or support units.

#### 3.3.1 CONFIGURATION OF SYSTEM UNDER TEST

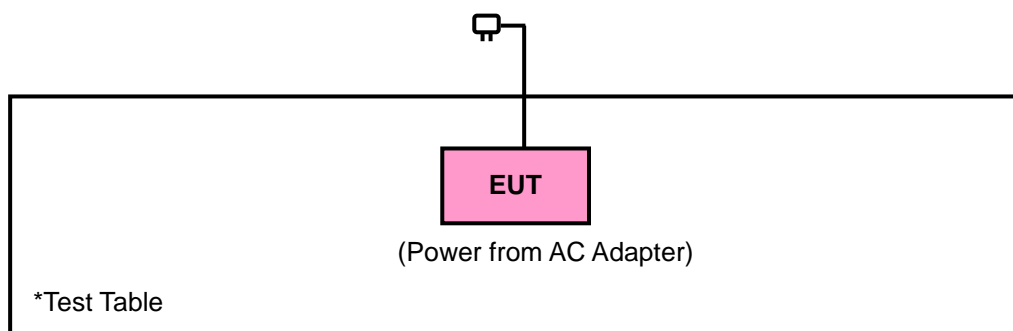

### 3.4 GENERAL DESCRIPTION OF APPLIED STANDARDS

The EUT is a RF Product. According to the specifications of the manufacturer, it must comply with the requirements of the following standards:

**FCC Part 15, Subpart C (15.247)**

**ANSI C63.10-2009**

**KDB 558074 D01 DTS Meas Guidance v01**

All test items have been performed and recorded as per the above standards.

**NOTE:** The EUT is also considered as a kind of computer peripheral, because the connection to computer is necessary for typical use. It has been verified to comply with the requirements of FCC Part 15, Subpart B, Class B (DoC). The test report has been issued separately.



A D T



## 4. TEST TYPES AND RESULTS (FOR 2.4GHz BAND)

### 4.1 RADIATED EMISSION AND BANDEDGE MEASUREMENT

#### 4.1.1 LIMITS OF RADIATED EMISSION AND BANDEDGE MEASUREMENT

Radiated emissions which fall in the restricted bands must comply with the radiated emission limits specified as below table. Other emissions shall be at least 20dB below the highest level of the desired power:

FREQUENCIES (MHz)	FIELD STRENGTH (microvolts/meter)	MEASUREMENT DISTANCE (meters)
0.009 ~ 0.490	2400/F(kHz)	300
0.490 ~ 1.705	24000/F(kHz)	30
1.705 ~ 30.0	30	30
30 ~ 88	100	3
88 ~ 216	150	3
216 ~ 960	200	3
Above 960	500	3

**NOTE:**

1. The lower limit shall apply at the transition frequencies.
2. Emission level (dBuV/m) = 20 log Emission level (uV/m).
3. For frequencies above 1000MHz, the field strength limits are based on average detector, however, the peak field strength of any emission shall not exceed the maximum permitted average limits, specified above by more than 20dB under any condition of modulation.



A D T

#### 4.1.2 TEST INSTRUMENTS

DESCRIPTION & MANUFACTURER	MODEL NO.	SERIAL NO.	DATE OF CALIBRATION	DUE DATE OF CALIBRATION
Test Receiver Agilent	N9038A	MY51210203	Dec. 22, 2011	Dec. 21, 2012
Spectrum Analyzer ROHDE & SCHWARZ	FSU43	101261	Dec. 21, 2011	Dec. 20, 2012
BILOG Antenna SCHWARZBECK	VULB9168	9168-472	Dec. 20, 2011	Dec. 19, 2012
HORN Antenna SCHWARZBECK	BBHA 9120 D	9120D-969	Dec. 20, 2011	Dec. 19, 2012
HORN Antenna SCHWARZBECK	BBHA 9170	9170-480	Dec. 20, 2011	Dec. 19, 2012
Preamplifier EMCI	EMC 012645	980115	Dec. 30, 2011	Dec. 29, 2012
Preamplifier EMCI	EMC 330H	980112	Dec. 30, 2011	Dec. 29, 2012
RF signal cable HUBER+SUHNNER	SUCOFLEX 104	309219/4	Oct. 21, 2011	Oct. 20, 2012
RF signal cable HUBER+SUHNNER	SUCOFLEX 104	250130/4	Jan. 02, 2012	Jan. 01, 2013
RF signal cable Worken	RG-213	NA	Jan. 02, 2012	Jan. 01, 2013
Software	E3 6.120103	NA	NA	NA
Antenna Tower MF	MFA-440H	NA	NA	NA
Turn Table MF	MFT-201SS	NA	NA	NA
Antenna Tower & Turn Table Controller MF	MF-7802	NA	NA	NA

- NOTE:**
1. The calibration interval of the above test instruments is 12 months and the calibrations are traceable to NML/ROC and NIST/USA.
  2. The test was performed in HwaYa Chamber 9.
  3. The horn antenna and HP preamplifier (model: 8449B) are used only for the measurement of emission frequency above 1GHz if tested.
  4. The FCC Site Registration No. is 460141.
  5. The IC Site Registration No. is IC 7450F-4.



#### 4.1.3 TEST PROCEDURES

- a. The EUT was placed on the top of a rotating table 0.8 meters above the ground at a 3 meters semi-anechoic chamber. The table was rotated 360 degrees to determine the position of the highest radiation.
- b. The EUT was set 3 meters away from the interference-receiving antenna, which was mounted on the top of a variable-height antenna tower.
- c. The antenna is a broadband antenna, and its height is varied from one meter to four meters above the ground to determine the maximum value of the field strength. Both horizontal and vertical polarizations of the antenna are set to make the measurement.
- d. For each suspected emission, the EUT was arranged to its worst case and then the antenna was tuned to heights from 1 meter to 4 meters and the rotatable table was turned from 0 degrees to 360 degrees to find the maximum reading.
- e. The test-receiver system was set to Peak Detect Function and Specified Bandwidth with Maximum Hold Mode.
- f. If the emission level of the EUT in peak mode was lower than the limit specified, then testing could be stopped and the peak values of the EUT would be reported. Otherwise the emissions would be re-tested one by one using peak, quasi-peak or average method as specified and then reported in a data sheet.

**NOTE:**

1. The resolution bandwidth and video bandwidth of test receiver/spectrum analyzer is 120kHz for Quasi-peak detection at frequency below 1GHz.
2. RBW=1 MHz; VBW=3 MHz (Peak)/ 10Hz (AV) is used for radiated spurious emission in restricted band above 1GHz
3. RBW=1MHz; VBW=3 MHz(PK)/10Hz(AV) is used for measurement radiated emission and band edge
4. All modes of operation were investigated and the worst-case emissions are reported.

#### 4.1.4 DEVIATION FROM TEST STANDARD

No deviation.

#### 4.1.5 TEST SETUP

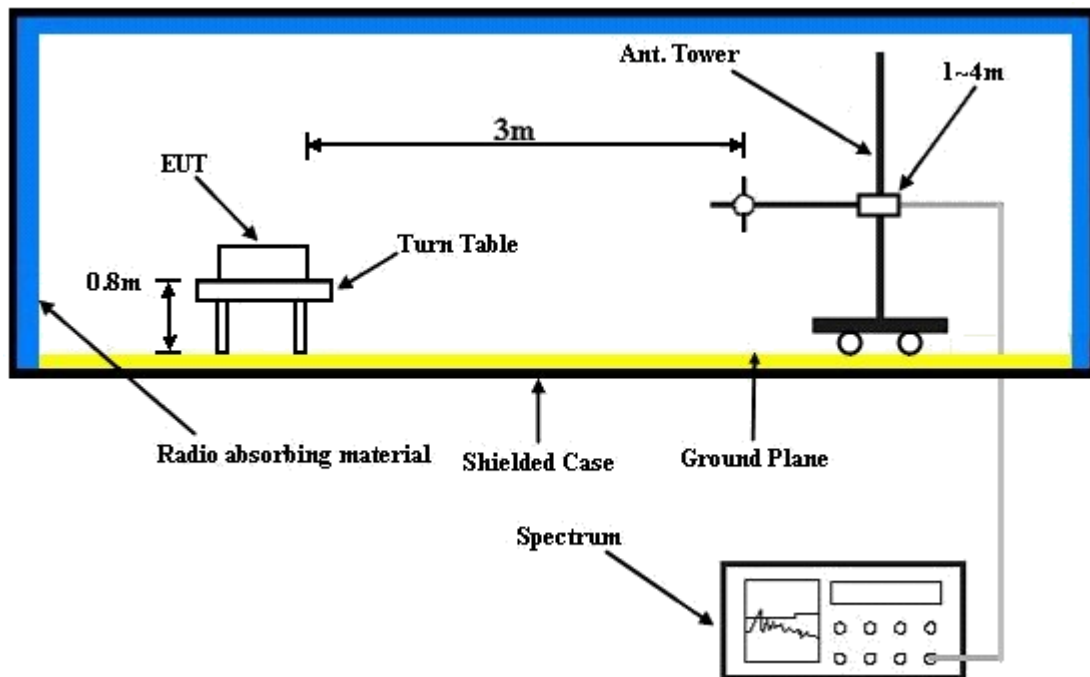

For the actual test configuration, please refer to the attached file (Test Setup Photo).

#### 4.1.6 EUT OPERATING CONDITIONS

- Placed the EUT on a testing table.
- Use the software to control the EUT under transmission condition continuously at specific channel frequency.



A D T

#### 4.1.7 TEST RESULTS

##### 802.11b

EUT TEST CONDITION		MEASUREMENT DETAIL	
CHANNEL	Channel 1	FREQUENCY RANGE	30MHz ~ 25GHz
INPUT POWER (SYSTEM)	120Vac, 60 Hz	DETECTOR FUNCTION	Peak (PK) Average (AV)
ENVIRONMENTAL CONDITIONS	25deg. C, 65%RH	TESTED BY	Kay Wu

ANTENNA POLARITY & TEST DISTANCE: HORIZONTAL AT 3 M										
FREQ. (MHz)	EMISSION LEVEL (dBuV/m)	READ LEVEL (dBuV)	LIMIT (dBuV/m)	MARGIN (dB)	ANTENNA FACTOR (dB/m)	CABLE LOSS (dB)	PREAMP FACTOR (dB)	ANTENNA HEIGHT (cm)	TABLE ANGLE (Degree)	REMARK
2390	46.74	68.88	54	-7.26	27.26	4.25	53.65	100	112	Average
2390	56.31	78.45	74	-17.69	27.26	4.25	53.65	100	112	Peak
2412	103.56	125.65			27.31	4.25	53.65	100	112	Average
2412	107.98	130.07			27.31	4.25	53.65	100	112	Peak
2483.5	45.49	67.32	54	-8.51	27.5	4.28	53.61	100	112	Average
2483.5	56.77	78.6	74	-17.23	27.5	4.28	53.61	100	112	Peak
4824	47.78	63.33	54	-6.22	31.42	6.11	53.08	100	333	Average
4824	50.77	66.32	74	-23.23	31.42	6.11	53.08	100	333	Peak
ANTENNA POLARITY & TEST DISTANCE: VERTICAL AT 3 M										
FREQ. (MHz)	EMISSION LEVEL (dBuV/m)	READ LEVEL (dBuV)	LIMIT (dBuV/m)	MARGIN (dB)	ANTENNA FACTOR (dB/m)	CABLE LOSS (dB)	PREAMP FACTOR (dB)	ANTENNA HEIGHT (cm)	TABLE ANGLE (Degree)	REMARK
2390	46.79	68.93	54	-7.21	27.26	4.25	53.65	100	258	Average
2390	56.34	78.48	74	-17.66	27.26	4.25	53.65	100	258	Peak
2412	94.41	116.5			27.31	4.25	53.65	100	258	Average
2412	98.9	120.99			27.31	4.25	53.65	100	258	Peak
2483.5	45.33	67.16	54	-8.67	27.5	4.28	53.61	100	258	Average
2483.5	56.92	78.75	74	-17.08	27.5	4.28	53.61	100	258	Peak
4824	50.14	65.69	54	-3.86	31.42	6.11	53.08	100	88	Average
4824	52.18	67.73	74	-21.82	31.42	6.11	53.08	100	88	Peak

REMARKS: 2412MHz: Fundamental frequency.



A D T

EUT TEST CONDITION		MEASUREMENT DETAIL	
CHANNEL	Channel 6	FREQUENCY RANGE	30MHz ~ 25GHz
INPUT POWER (SYSTEM)	120Vac, 60 Hz	DETECTOR FUNCTION	Peak (PK) Average (AV)
ENVIRONMENTAL CONDITIONS	25deg. C, 65%RH	TESTED BY	Kay Wu

ANTENNA POLARITY & TEST DISTANCE: HORIZONTAL AT 3 M										
FREQ. (MHz)	EMISSION LEVEL (dBuV/m)	READ LEVEL (dBuV)	LIMIT (dBuV/m)	MARGIN (dB)	ANTENNA FACTOR (dB/m)	CABLE LOSS (dB)	PREAMP FACTOR (dB)	ANTENNA HEIGHT (cm)	TABLE ANGLE (Degree)	REMARK
2390	45.53	67.67	54	-8.47	27.26	4.25	53.65	100	121	Average
2390	56.87	79.01	74	-17.13	27.26	4.25	53.65	100	121	Peak
2437	100.48	122.51			27.35	4.26	53.64	100	121	Average
2437	104.83	126.86			27.35	4.26	53.64	100	121	Peak
2483.5	46.3	68.13	54	-7.7	27.5	4.28	53.61	100	121	Average
2483.5	55.9	77.73	74	-18.1	27.5	4.28	53.61	100	121	Peak
4874	49.1	64.5	54	-4.9	31.53	6.12	53.05	100	214	Average
4874	51.32	66.72	74	-22.68	31.53	6.12	53.05	100	214	Peak
ANTENNA POLARITY & TEST DISTANCE: VERTICAL AT 3 M										
FREQ. (MHz)	EMISSION LEVEL (dBuV/m)	READ LEVEL (dBuV)	LIMIT (dBuV/m)	MARGIN (dB)	ANTENNA FACTOR (dB/m)	CABLE LOSS (dB)	PREAMP FACTOR (dB)	ANTENNA HEIGHT (cm)	TABLE ANGLE (Degree)	REMARK
2390	45.25	67.39	54	-8.75	27.26	4.25	53.65	100	85	Average
2390	54.92	77.06	74	-19.08	27.26	4.25	53.65	100	85	Peak
2437	94.47	116.45			27.4	4.26	53.64	100	85	Average
2437	98.77	120.75			27.4	4.26	53.64	100	85	Peak
2483.5	45.46	67.29	54	-8.54	27.5	4.28	53.61	100	85	Average
2483.5	57.38	79.21	74	-16.62	27.5	4.28	53.61	100	85	Peak
4874	49.56	64.96	54	-4.44	31.53	6.12	53.05	100	141	Average
4874	51.33	66.73	74	-22.67	31.53	6.12	53.05	100	141	Peak

REMARKS: 2437MHz: Fundamental frequency.



A D T

EUT TEST CONDITION		MEASUREMENT DETAIL	
CHANNEL	Channel 11	FREQUENCY RANGE	30MHz ~ 25GHz
INPUT POWER (SYSTEM)	120Vac, 60 Hz	DETECTOR FUNCTION	Peak (PK) Average (AV)
ENVIRONMENTAL CONDITIONS	25deg. C, 65%RH	TESTED BY	Kay Wu

ANTENNA POLARITY & TEST DISTANCE: HORIZONTAL AT 3 M										
FREQ. (MHz)	EMISSION LEVEL (dBuV/m)	READ LEVEL (dBuV)	LIMIT (dBuV/m)	MARGIN (dB)	ANTENNA FACTOR (dB/m)	CABLE LOSS (dB)	PREAMP FACTOR (dB)	ANTENNA HEIGHT (cm)	TABLE ANGLE (Degree)	REMARK
2390	46.37	68.51	54	-7.63	27.26	4.25	53.65	100	255	Average
2390	56.35	78.49	74	-17.65	27.26	4.25	53.65	100	255	Peak
2462	101.5	123.4			27.45	4.27	53.62	100	255	Average
2462	105.96	127.86			27.45	4.27	53.62	100	255	Peak
2483.5	45.8	67.63	54	-8.2	27.5	4.28	53.61	100	255	Average
2483.5	57.95	79.78	74	-16.05	27.5	4.28	53.61	100	255	Peak
4924	47.89	63.16	54	-6.11	31.64	6.12	53.03	100	121	Average
4924	51.29	66.56	74	-22.71	31.64	6.12	53.03	100	121	Peak
ANTENNA POLARITY & TEST DISTANCE: VERTICAL AT 3 M										
FREQ. (MHz)	EMISSION LEVEL (dBuV/m)	READ LEVEL (dBuV)	LIMIT (dBuV/m)	MARGIN (dB)	ANTENNA FACTOR (dB/m)	CABLE LOSS (dB)	PREAMP FACTOR (dB)	ANTENNA HEIGHT (cm)	TABLE ANGLE (Degree)	REMARK
2390	45.99	68.13	54	-8.01	27.26	4.25	53.65	100	174	Average
2390	56.04	78.18	74	-17.96	27.26	4.25	53.65	100	174	Peak
2462	93.47	115.37			27.45	4.27	53.62	100	174	Average
2462	97.89	119.79			27.45	4.27	53.62	100	174	Peak
2483.5	45.51	67.34	54	-8.49	27.5	4.28	53.61	100	174	Average
2483.5	57.93	79.76	74	-16.07	27.5	4.28	53.61	100	174	Peak
4924	49.54	64.81	54	-4.46	31.64	6.12	53.03	100	21	Average
4924	51.3	66.57	74	-22.7	31.64	6.12	53.03	100	21	Peak

REMARKS: 2462MHz: Fundamental frequency.



A D T

802.11g

EUT TEST CONDITION		MEASUREMENT DETAIL	
CHANNEL	Channel 1	FREQUENCY RANGE	30MHz ~ 25GHz
INPUT POWER (SYSTEM)	120Vac, 60 Hz	DETECTOR FUNCTION	Peak (PK) Average (AV)
ENVIRONMENTAL CONDITIONS	25deg. C, 65%RH	TESTED BY	Kay Wu

ANTENNA POLARITY & TEST DISTANCE: HORIZONTAL AT 3 M										
FREQ. (MHz)	EMISSION LEVEL (dBuV/m)	READ LEVEL (dBuV)	LIMIT (dBuV/m)	MARGIN (dB)	ANTENNA FACTOR (dB/m)	CABLE LOSS (dB)	PREAMP FACTOR (dB)	ANTENNA HEIGHT (cm)	TABLE ANGLE (Degree)	REMARK
2390	50.06	72.2	54	-3.94	27.26	4.25	53.65	100	47	Average
2390	61.51	83.65	74	-12.49	27.26	4.25	53.65	100	47	Peak
2412	98.23	120.32			27.31	4.25	53.65	100	47	Average
2412	107.35	129.44			27.31	4.25	53.65	100	47	Peak
2483.5	46.88	68.71	54	-7.12	27.5	4.28	53.61	100	47	Average
2483.5	57.24	79.07	74	-16.76	27.5	4.28	53.61	100	47	Peak
4824	48.72	64.27	74	-25.28	31.42	6.11	53.08	100	1	Peak
ANTENNA POLARITY & TEST DISTANCE: VERTICAL AT 3 M										
FREQ. (MHz)	EMISSION LEVEL (dBuV/m)	READ LEVEL (dBuV)	LIMIT (dBuV/m)	MARGIN (dB)	ANTENNA FACTOR (dB/m)	CABLE LOSS (dB)	PREAMP FACTOR (dB)	ANTENNA HEIGHT (cm)	TABLE ANGLE (Degree)	REMARK
2390	46.72	68.86	54	-7.28	27.26	4.25	53.65	100	101	Average
2390	56.88	79.02	74	-17.12	27.26	4.25	53.65	100	101	Peak
2412	88.68	110.77			27.31	4.25	53.65	100	101	Average
2412	97.89	119.98			27.31	4.25	53.65	100	101	Peak
2484	46.97	68.8	54	-7.03	27.5	4.28	53.61	100	101	Average
2484	56.94	78.77	74	-17.06	27.5	4.28	53.61	100	101	Peak
4824	47.81	63.36	74	-26.19	31.42	6.11	53.08	100	10	Peak

REMARKS: 2412MHz: Fundamental frequency.



A D T

EUT TEST CONDITION		MEASUREMENT DETAIL	
CHANNEL	Channel 6	FREQUENCY RANGE	30MHz ~ 25GHz
INPUT POWER (SYSTEM)	120Vac, 60 Hz	DETECTOR FUNCTION	Peak (PK) Average (AV)
ENVIRONMENTAL CONDITIONS	25deg. C, 65%RH	TESTED BY	Kay Wu

ANTENNA POLARITY & TEST DISTANCE: HORIZONTAL AT 3 M										
FREQ. (MHz)	EMISSION LEVEL (dBuV/m)	READ LEVEL (dBuV)	LIMIT (dBuV/m)	MARGIN (dB)	ANTENNA FACTOR (dB/m)	CABLE LOSS (dB)	PREAMP FACTOR (dB)	ANTENNA HEIGHT (cm)	TABLE ANGLE (Degree)	REMARK
2390	45.39	67.53	54	-8.61	27.26	4.25	53.65	100	125	Average
2390	56.44	78.58	74	-17.56	27.26	4.25	53.65	100	125	Peak
2437	99.41	121.39			27.4	4.26	53.64	100	125	Average
2437	108.53	130.56			27.35	4.26	53.64	100	125	Peak
2483.5	46.4	68.23	54	-7.6	27.5	4.28	53.61	100	125	Average
2483.5	58.04	79.87	74	-15.96	27.5	4.28	53.61	100	125	Peak
4874	48.25	63.65	74	-25.75	31.53	6.12	53.05	100	21	Peak
ANTENNA POLARITY & TEST DISTANCE: VERTICAL AT 3 M										
FREQ. (MHz)	EMISSION LEVEL (dBuV/m)	READ LEVEL (dBuV)	LIMIT (dBuV/m)	MARGIN (dB)	ANTENNA FACTOR (dB/m)	CABLE LOSS (dB)	PREAMP FACTOR (dB)	ANTENNA HEIGHT (cm)	TABLE ANGLE (Degree)	REMARK
2390	46.1	68.24	54	-7.9	27.26	4.25	53.65	100	111	Average
2390	56.71	78.85	74	-17.29	27.26	4.25	53.65	100	111	Peak
2437	90.26	112.24			27.4	4.26	53.64	100	111	Average
2437	99.26	121.24			27.4	4.26	53.64	100	111	Peak
2484	45.74	67.57	54	-8.26	27.5	4.28	53.61	100	111	Average
2484	57.43	79.26	74	-16.57	27.5	4.28	53.61	100	111	Peak
4874	46.46	61.86	74	-27.54	31.53	6.12	53.05	100	312	Peak

REMARKS: 2437MHz: Fundamental frequency.



A D T

EUT TEST CONDITION		MEASUREMENT DETAIL	
CHANNEL	Channel 11	FREQUENCY RANGE	30MHz ~ 25GHz
INPUT POWER (SYSTEM)	120Vac, 60 Hz	DETECTOR FUNCTION	Peak (PK) Average (AV)
ENVIRONMENTAL CONDITIONS	25deg. C, 65%RH	TESTED BY	Kay Wu

ANTENNA POLARITY & TEST DISTANCE: HORIZONTAL AT 3 M										
FREQ. (MHz)	EMISSION LEVEL (dBuV/m)	READ LEVEL (dBuV)	LIMIT (dBuV/m)	MARGIN (dB)	ANTENNA FACTOR (dB/m)	CABLE LOSS (dB)	PREAMP FACTOR (dB)	ANTENNA HEIGHT (cm)	TABLE ANGLE (Degree)	REMARK
2390	46.62	68.76	54	-7.38	27.26	4.25	53.65	100	141	Average
2390	55.66	77.8	74	-18.34	27.26	4.25	53.65	100	141	Peak
2462	97.16	119.06			27.45	4.27	53.62	100	141	Average
2462	106.36	128.26			27.45	4.27	53.62	100	141	Peak
2483.5	49.25	71.08	54	-4.75	27.5	4.28	53.61	100	141	Average
2483.5	66.19	88.02	74	-7.81	27.5	4.28	53.61	100	141	Peak
4924	47.76	63.03	74	-26.24	31.64	6.12	53.03	100	107	Peak
ANTENNA POLARITY & TEST DISTANCE: VERTICAL AT 3 M										
FREQ. (MHz)	EMISSION LEVEL (dBuV/m)	READ LEVEL (dBuV)	LIMIT (dBuV/m)	MARGIN (dB)	ANTENNA FACTOR (dB/m)	CABLE LOSS (dB)	PREAMP FACTOR (dB)	ANTENNA HEIGHT (cm)	TABLE ANGLE (Degree)	REMARK
2390	45.38	67.52	54	-8.62	27.26	4.25	53.65	100	41	Average
2390	55.46	77.6	74	-18.54	27.26	4.25	53.65	100	41	Peak
2462	89.07	110.97			27.45	4.27	53.62	100	41	Average
2462	98.22	120.12			27.45	4.27	53.62	100	41	Peak
2483.5	47.66	69.49	54	-6.34	27.5	4.28	53.61	100	41	Average
2483.5	58.31	80.14	74	-15.69	27.5	4.28	53.61	100	41	Peak
4924	49.13	64.4	74	-24.87	31.64	6.12	53.03	100	33	Peak

REMARKS: 2462MHz: Fundamental frequency.



A D T

802.11n (20MHz)

EUT TEST CONDITION		MEASUREMENT DETAIL	
CHANNEL	Channel 1	FREQUENCY RANGE	30MHz ~ 25GHz
INPUT POWER (SYSTEM)	120Vac, 60 Hz	DETECTOR FUNCTION	Peak (PK) Average (AV)
ENVIRONMENTAL CONDITIONS	25deg. C, 65%RH	TESTED BY	Kay Wu

ANTENNA POLARITY & TEST DISTANCE: HORIZONTAL AT 3 M										
FREQ. (MHz)	EMISSION LEVEL (dBuV/m)	READ LEVEL (dBuV)	LIMIT (dBuV/m)	MARGIN (dB)	ANTENNA FACTOR (dB/m)	CABLE LOSS (dB)	PREAMP FACTOR (dB)	ANTENNA HEIGHT (cm)	TABLE ANGLE (Degree)	REMARK
2390	49.15	71.29	54	-4.85	27.26	4.25	53.65	100	123	Average
2390	67.73	89.87	74	-6.27	27.26	4.25	53.65	100	123	Peak
2412	97.81	119.9			27.31	4.25	53.65	100	123	Average
2412	107.07	129.16			27.31	4.25	53.65	100	123	Peak
2483.5	46.51	68.34	54	-7.49	27.5	4.28	53.61	100	123	Average
2483.5	56.71	78.54	74	-17.29	27.5	4.28	53.61	100	123	Peak
4824	48.35	63.9	74	-25.65	31.42	6.11	53.08	100	221	Peak
ANTENNA POLARITY & TEST DISTANCE: VERTICAL AT 3 M										
FREQ. (MHz)	EMISSION LEVEL (dBuV/m)	READ LEVEL (dBuV)	LIMIT (dBuV/m)	MARGIN (dB)	ANTENNA FACTOR (dB/m)	CABLE LOSS (dB)	PREAMP FACTOR (dB)	ANTENNA HEIGHT (cm)	TABLE ANGLE (Degree)	REMARK
2390	46.74	68.88	54	-7.26	27.26	4.25	53.65	100	28	Average
2390	57.34	79.48	74	-16.66	27.26	4.25	53.65	100	28	Peak
2412	88.45	110.54			27.31	4.25	53.65	100	28	Average
2412	97.94	120.03			27.31	4.25	53.65	100	28	Peak
2483.5	46.3	68.13	54	-7.7	27.5	4.28	53.61	100	28	Average
2483.5	56.71	78.54	74	-17.29	27.5	4.28	53.61	100	28	Peak
4824	48.46	64.01	74	-25.54	31.42	6.11	53.08	100	275	Peak

REMARKS: 2412MHz: Fundamental frequency.



A D T

EUT TEST CONDITION		MEASUREMENT DETAIL	
CHANNEL	Channel 6	FREQUENCY RANGE	30MHz ~ 25GHz
INPUT POWER (SYSTEM)	120Vac, 60 Hz	DETECTOR FUNCTION	Peak (PK) Average (AV)
ENVIRONMENTAL CONDITIONS	25deg. C, 65%RH	TESTED BY	Kay Wu

ANTENNA POLARITY & TEST DISTANCE: HORIZONTAL AT 3 M										
FREQ. (MHz)	EMISSION LEVEL (dBuV/m)	READ LEVEL (dBuV)	LIMIT (dBuV/m)	MARGIN (dB)	ANTENNA FACTOR (dB/m)	CABLE LOSS (dB)	PREAMP FACTOR (dB)	ANTENNA HEIGHT (cm)	TABLE ANGLE (Degree)	REMARK
2390	46.21	68.35	54	-7.79	27.26	4.25	53.65	100	133	Average
2390	56.23	78.37	74	-17.77	27.26	4.25	53.65	100	133	Peak
2437	99.03	121.01			27.4	4.26	53.64	100	133	Average
2437	108.32	130.3			27.4	4.26	53.64	100	133	Peak
2483.5	46.41	68.24	54	-7.59	27.5	4.28	53.61	100	133	Average
2483.5	59.27	81.1	74	-14.73	27.5	4.28	53.61	100	133	Peak
4874	49.02	64.42	74	-24.98	31.53	6.12	53.05	100	27	Peak
ANTENNA POLARITY & TEST DISTANCE: VERTICAL AT 3 M										
FREQ. (MHz)	EMISSION LEVEL (dBuV/m)	READ LEVEL (dBuV)	LIMIT (dBuV/m)	MARGIN (dB)	ANTENNA FACTOR (dB/m)	CABLE LOSS (dB)	PREAMP FACTOR (dB)	ANTENNA HEIGHT (cm)	TABLE ANGLE (Degree)	REMARK
2390	46.07	68.21	54	-7.93	27.26	4.25	53.65	100	331	Average
2390	56.37	78.51	74	-17.63	27.26	4.25	53.65	100	331	Peak
2437	89.89	111.87			27.4	4.26	53.64	100	331	Average
2437	99.14	121.12			27.4	4.26	53.64	100	331	Peak
2483.5	46.1	67.93	54	-7.9	27.5	4.28	53.61	100	331	Average
2483.5	57.35	79.18	74	-16.65	27.5	4.28	53.61	100	331	Peak
4874	48.06	63.46	74	-25.94	31.53	6.12	53.05	100	201	Peak

REMARKS: 2437MHz: Fundamental frequency.



A D T

EUT TEST CONDITION		MEASUREMENT DETAIL	
CHANNEL	Channel 11	FREQUENCY RANGE	30MHz ~ 25GHz
INPUT POWER (SYSTEM)	120Vac, 60 Hz	DETECTOR FUNCTION	Peak (PK) Average (AV)
ENVIRONMENTAL CONDITIONS	25deg. C, 65%RH	TESTED BY	Kay Wu

ANTENNA POLARITY & TEST DISTANCE: HORIZONTAL AT 3 M										
FREQ. (MHz)	EMISSION LEVEL (dBuV/m)	READ LEVEL (dBuV)	LIMIT (dBuV/m)	MARGIN (dB)	ANTENNA FACTOR (dB/m)	CABLE LOSS (dB)	PREAMP FACTOR (dB)	ANTENNA HEIGHT (cm)	TABLE ANGLE (Degree)	REMARK
2390	46.62	68.76	54	-7.38	27.26	4.25	53.65	100	285	Average
2390	56.6	78.74	74	-17.4	27.26	4.25	53.65	100	285	Peak
2462	97.4	119.3			27.45	4.27	53.62	100	285	Average
2462	106.49	128.39			27.45	4.27	53.62	100	285	Peak
2483.5	50.03	71.86	54	-3.97	27.5	4.28	53.61	100	285	Average
2483.5	66.32	88.15	74	-7.68	27.5	4.28	53.61	100	285	Peak
4924	47.79	63.06	74	-26.21	31.64	6.12	53.03	100	107	Peak
ANTENNA POLARITY & TEST DISTANCE: VERTICAL AT 3 M										
FREQ. (MHz)	EMISSION LEVEL (dBuV/m)	READ LEVEL (dBuV)	LIMIT (dBuV/m)	MARGIN (dB)	ANTENNA FACTOR (dB/m)	CABLE LOSS (dB)	PREAMP FACTOR (dB)	ANTENNA HEIGHT (cm)	TABLE ANGLE (Degree)	REMARK
2390	46.4	68.54	54	-7.6	27.26	4.25	53.65	100	241	Average
2390	55.86	78	74	-18.14	27.26	4.25	53.65	100	241	Peak
2462	89.7	111.6			27.45	4.27	53.62	100	241	Average
2462	98.97	120.87			27.45	4.27	53.62	100	241	Peak
2483.5	47.98	69.81	54	-6.02	27.5	4.28	53.61	100	241	Average
2483.5	60.13	81.96	74	-13.87	27.5	4.28	53.61	100	241	Peak
4924	48.62	63.89	74	-25.38	31.64	6.12	53.03	100	105	Peak

REMARKS: 2462MHz: Fundamental frequency.



A D T

802.11n (40MHz)

EUT TEST CONDITION		MEASUREMENT DETAIL	
CHANNEL	Channel 1	FREQUENCY RANGE	30MHz ~ 25GHz
INPUT POWER (SYSTEM)	120Vac, 60 Hz	DETECTOR FUNCTION	Peak (PK) Average (AV)
ENVIRONMENTAL CONDITIONS	25deg. C, 65%RH	TESTED BY	Kay Wu

ANTENNA POLARITY & TEST DISTANCE: HORIZONTAL AT 3 M										
FREQ. (MHz)	EMISSION LEVEL (dBuV/m)	READ LEVEL (dBuV)	LIMIT (dBuV/m)	MARGIN (dB)	ANTENNA FACTOR (dB/m)	CABLE LOSS (dB)	PREAMP FACTOR (dB)	ANTENNA HEIGHT (cm)	TABLE ANGLE (Degree)	REMARK
2390	45.16	49.57	54	-8.84	27.26	4.25	35.92	100	211	Average
2390	56.26	60.67	74	-17.74	27.26	4.25	35.92	100	211	Peak
2422	95.25	99.54			27.35	4.26	35.9	100	211	Average
2422	106.51	110.8			27.35	4.26	35.9	100	211	Peak
2483.5	43.35	47.44	54	-10.65	27.5	4.28	35.87	100	211	Average
2483.5	55.39	59.48	74	-18.61	27.5	4.28	35.87	100	211	Peak
4844	49.55	65.04	74	-24.45	31.46	6.11	53.06	100	36	Peak
ANTENNA POLARITY & TEST DISTANCE: VERTICAL AT 3 M										
FREQ. (MHz)	EMISSION LEVEL (dBuV/m)	READ LEVEL (dBuV)	LIMIT (dBuV/m)	MARGIN (dB)	ANTENNA FACTOR (dB/m)	CABLE LOSS (dB)	PREAMP FACTOR (dB)	ANTENNA HEIGHT (cm)	TABLE ANGLE (Degree)	REMARK
2390	40.09	44.5	54	-13.91	27.26	4.25	35.92	100	127	Average
2390	51.53	55.94	74	-22.47	27.26	4.25	35.92	100	127	Peak
2422	85.25	89.54			27.35	4.26	35.9	100	127	Average
2422	96.72	101.01			27.35	4.26	35.9	100	127	Peak
2483.5	40.01	44.1	54	-13.99	27.5	4.28	35.87	100	127	Average
2483.5	52.49	56.58	74	-21.51	27.5	4.28	35.87	100	127	Peak
4844	48.61	64.1	74	-25.39	31.46	6.11	53.06	100	14	Peak

REMARKS: 2422MHz: Fundamental frequency.



A D T

EUT TEST CONDITION		MEASUREMENT DETAIL	
CHANNEL	Channel 4	FREQUENCY RANGE	30MHz ~ 25GHz
INPUT POWER (SYSTEM)	120Vac, 60 Hz	DETECTOR FUNCTION	Peak (PK) Average (AV)
ENVIRONMENTAL CONDITIONS	25deg. C, 65%RH	TESTED BY	Kay Wu

ANTENNA POLARITY & TEST DISTANCE: HORIZONTAL AT 3 M										
FREQ. (MHz)	EMISSION LEVEL (dBuV/m)	READ LEVEL (dBuV)	LIMIT (dBuV/m)	MARGIN (dB)	ANTENNA FACTOR (dB/m)	CABLE LOSS (dB)	PREAMP FACTOR (dB)	ANTENNA HEIGHT (cm)	TABLE ANGLE (Degree)	REMARK
2388	43.04	47.49	54	-10.96	27.26	4.23	35.94	130	65	Average
2388	57.71	62.16	74	-16.29	27.26	4.23	35.94	130	65	Peak
2437	95.61	99.85			27.4	4.26	35.9	130	65	Average
2437	106.46	110.75			27.35	4.26	35.9	130	65	Peak
2484	46.85	50.94	54	-7.15	27.5	4.28	35.87	130	65	Average
2484	64.64	68.73	74	-9.36	27.5	4.28	35.87	130	65	Peak
ANTENNA POLARITY & TEST DISTANCE: VERTICAL AT 3 M										
FREQ. (MHz)	EMISSION LEVEL (dBuV/m)	READ LEVEL (dBuV)	LIMIT (dBuV/m)	MARGIN (dB)	ANTENNA FACTOR (dB/m)	CABLE LOSS (dB)	PREAMP FACTOR (dB)	ANTENNA HEIGHT (cm)	TABLE ANGLE (Degree)	REMARK
2384	33.1	37.6	54	-20.9	27.21	4.23	35.94	102	15	Average
2384	43.71	48.21	74	-30.29	27.21	4.23	35.94	102	15	Peak
2437	83.87	88.11			27.4	4.26	35.9	102	15	Average
2437	94.21	98.45			27.4	4.26	35.9	102	15	Peak
2488	33.57	37.61	54	-20.43	27.55	4.28	35.87	102	15	Average
2488	47.8	51.84	74	-26.2	27.55	4.28	35.87	102	15	Peak

REMARKS: 2437MHz: Fundamental frequency.



**A D T**

EUT TEST CONDITION		MEASUREMENT DETAIL	
CHANNEL	Channel 7	FREQUENCY RANGE	30MHz ~ 25GHz
INPUT POWER (SYSTEM)	120Vac, 60 Hz	DETECTOR FUNCTION	Peak (PK) Average (AV)
ENVIRONMENTAL CONDITIONS	25deg. C, 65%RH	TESTED BY	Kay Wu

ANTENNA POLARITY & TEST DISTANCE: HORIZONTAL AT 3 M										
FREQ. (MHz)	EMISSION LEVEL (dBuV/m)	READ LEVEL (dBuV)	LIMIT (dBuV/m)	MARGIN (dB)	ANTENNA FACTOR (dB/m)	CABLE LOSS (dB)	PREAMP FACTOR (dB)	ANTENNA HEIGHT (cm)	TABLE ANGLE (Degree)	REMARK
35.67	25.34	42.84	40	-14.66	12.94	0.61	31.05			Peak
59.97	24.95	43.54	40	-15.05	11.94	0.83	31.36			Peak
172.02	32.72	51.45	43.5	-10.78	11.57	1.45	31.75	100	283	Peak
313.3	25.28	41.85	46	-20.72	13.26	2.1	31.93			Peak
398.7	21.34	35.73	46	-24.66	15.31	2.42	32.12			Peak
578.6	23.16	33.13	46	-22.84	19.12	3.03	32.12			Peak
2390	40.85	45.26	54	-13.15	27.26	4.25	35.92	100	117	Average
2390	51.76	56.17	74	-22.24	27.26	4.25	35.92	100	117	Peak
2452	94.44	98.66			27.4	4.27	35.89	100	117	Average
2452	105.64	109.86			27.4	4.27	35.89	100	117	Peak
<b>2483.5</b>	<b>50.45</b>	<b>54.54</b>	<b>54</b>	<b>-3.55</b>	<b>27.5</b>	<b>4.28</b>	<b>35.87</b>	<b>100</b>	<b>117</b>	<b>Average</b>
2483.5	65.24	69.33	74	-8.76	27.5	4.28	35.87	100	117	Peak

ANTENNA POLARITY & TEST DISTANCE: VERTICAL AT 3 M										
FREQ. (MHz)	EMISSION LEVEL (dBuV/m)	READ LEVEL (dBuV)	LIMIT (dBuV/m)	MARGIN (dB)	ANTENNA FACTOR (dB/m)	CABLE LOSS (dB)	PREAMP FACTOR (dB)	ANTENNA HEIGHT (cm)	TABLE ANGLE (Degree)	REMARK
30.54	34.83	53.24	40	-5.17	12.14	0.57	31.12	100	0	QP
35.67	34.66	52.16	40	-5.34	12.94	0.61	31.05	100	0	QP
172.56	33.62	52.45	43.5	-9.88	11.47	1.46	31.76			Peak
494.6	19.72	31.45	46	-26.28	17.21	2.76	31.7			Peak
596.8	23.38	32.99	46	-22.62	19.52	3.08	32.21			Peak
831.3	26.4	31.73	46	-19.6	22.63	3.77	31.73			Peak
2390	39.85	44.26	54	-14.15	27.26	4.25	35.92	100	57	Average
2390	52.77	57.18	74	-21.23	27.26	4.25	35.92	100	57	Peak
2452	83.72	87.94			27.4	4.27	35.89	100	57	Average
2452	95.03	99.25			27.4	4.27	35.89	100	57	Peak
2483.5	44.29	48.38	54	-9.71	27.5	4.28	35.87	100	57	Average
2483.5	57.05	61.14	74	-16.95	27.5	4.28	35.87	100	57	Peak

REMARKS: 2452MHz: Fundamental frequency.



A D T

## 4.2 CONDUCTED EMISSION MEASUREMENT

### 4.2.1 LIMITS OF CONDUCTED EMISSION MEASUREMENT

FREQUENCY OF EMISSION (MHz)	CONDUCTED LIMIT (dB $\mu$ V)	
	Quasi-peak	Average
0.15 ~ 0.5	66 to 56	56 to 46
0.5 ~ 5	56	46
5 ~ 30	60	50

- NOTE:** 1. The lower limit shall apply at the transition frequencies.  
2. The limit decreases in line with the logarithm of the frequency in the range of 0.15 to 0.50MHz.  
3. All emanations from a class A/B digital device or system, including any network of conductors and apparatus connected thereto, shall not exceed the level of field strengths specified above.

### 4.2.2 TEST INSTRUMENTS

DESCRIPTION & MANUFACTURER	MODEL NO.	SERIAL NO.	DATE OF CALIBRATION	DUE DATE OF CALIBRATION
Test Receiver ROHDE & SCHWARZ	ESCS30	100289	Nov. 19, 2011	Nov. 18, 2012
RF signal cable Woken	5D-FB	Cable-HYCO2-0 1	Dec. 22, 2011	Dec. 21, 2012
LISN ROHDE & SCHWARZ	ESH2-Z5	100100	Dec. 30, 2011	Dec. 29, 2012
LISN ROHDE & SCHWARZ	ESH3-Z5	100312	Jul. 07, 2011	Jul. 06, 2012
V-LISN SCHWARZBECK	NNBL 8226-2	8226-142	Jun. 30, 2011	Jun. 29, 2012
LISN ROHDE & SCHWARZ	ENV216	100072	Jun. 10, 2011	Jun. 09, 2012
Software ADT	ADT_Cond_ V7.3.7	NA	NA	NA

- NOTE:** 1. The calibration interval of the above test instruments is 12 months and the calibrations are traceable to NML/ROC and NIST/USA.  
2. The test was performed in HwaYa Shielded Room 2.  
3. The VCCI Site Registration No. is C-2047.



#### 4.2.3 TEST PROCEDURES

- a. The EUT was placed 0.4 meters from the conducting wall of the shielded room with EUT being connected to the power mains through a line impedance stabilization network (LISN). Other support units were connected to the power mains through another LISN. The two LISNs provide 50 ohm/ 50uH of coupling impedance for the measuring instrument.
- b. Both lines of the power mains connected to the EUT were checked for maximum conducted interference.
- c. The frequency range from 150kHz to 30MHz was searched. Emission levels under (Limit - 20dB) was not recorded.

**NOTE:** All modes of operation were investigated and the worst-case emissions are reported.

#### 4.2.4 DEVIATION FROM TEST STANDARD

No deviation.

#### 4.2.5 TEST SETUP

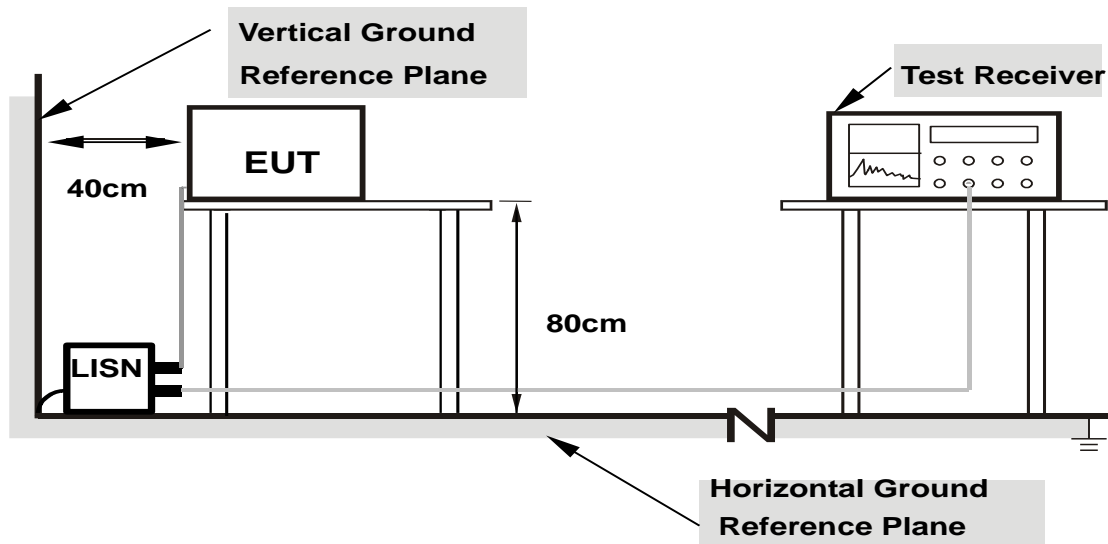

- Note:**
1. Support units were connected to second LISN.
  2. Both of LISNs (AMN) are 80 cm from EUT and at least 80 from other units and other metal planes

For the actual test configuration, please refer to the attached file (Test Setup Photo).

#### 4.2.6 EUT OPERATING CONDITIONS

Same as 4.1.6.

### 4.2.7 TEST RESULTS

**CONDUCTED WORST-CASE DATA : 802.11n (20MHz)**

<b>PHASE</b>	Line 1	<b>6dB BANDWIDTH</b>	9kHz
--------------	--------	----------------------	------

No	Freq. [MHz]	Corr. Factor (dB)	Reading Value		Emission Level		Limit		Margin	
			[dB (uV)]		[dB (uV)]		[dB (uV)]		(dB)	
			Q.P.	AV.	Q.P.	AV.	Q.P.	AV.	Q.P.	AV.
1	0.18125	0.15	60.66	43.33	60.81	43.48	64.43	54.43	-3.62	-10.95
2	0.27109	0.16	49.42	28.61	49.58	28.77	61.08	51.08	-11.51	-22.32
3	0.37656	0.17	39.33	17.16	39.50	17.33	58.35	48.35	-18.86	-31.03
4	0.79063	0.18	42.72	27.99	42.90	28.17	56.00	46.00	-13.10	-17.83
5	0.97813	0.19	40.41	24.82	40.60	25.01	56.00	46.00	-15.40	-20.99
6	4.59375	0.35	42.04	28.96	42.39	29.31	56.00	46.00	-13.61	-16.69

- REMARKS:**
1. Q.P. and AV. are abbreviations of quasi-peak and average individually.
  2. The emission levels of other frequencies were very low against the limit.
  3. Margin value = Emission level - Limit value
  4. Correction factor = Insertion loss + Cable loss
  5. Emission Level = Correction Factor + Reading Value.

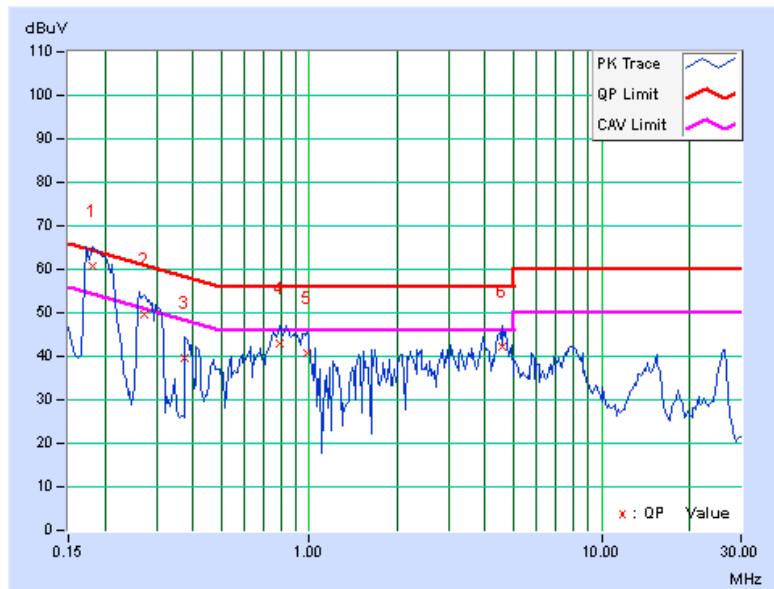



A D T

PHASE	Line 2	6dB BANDWIDTH	9kHz
-------	--------	---------------	------

No	Freq. [MHz]	Corr. Factor (dB)	Reading Value [dB (uV)]		Emission Level [dB (uV)]		Limit [dB (uV)]		Margin (dB)	
			Q.P.	AV.	Q.P.	AV.	Q.P.	AV.	Q.P.	AV.
			1	0.18516	0.14	57.97	42.32	58.11	42.46	64.25
2	0.27109	0.15	47.06	28.69	47.21	28.84	61.08	51.08	-13.88	-22.25
3	0.82578	0.18	45.49	32.60	45.67	32.78	56.00	46.00	-10.33	-13.22
4	0.97813	0.19	42.31	26.11	42.50	26.30	56.00	46.00	-13.50	-19.70
5	2.07422	0.26	40.60	26.24	40.86	26.50	56.00	46.00	-15.14	-19.50
6	2.98828	0.30	38.44	26.48	38.74	26.78	56.00	46.00	-17.26	-19.22
7	3.33203	0.32	39.61	27.69	39.93	28.01	56.00	46.00	-16.07	-17.99
8	4.17969	0.35	41.03	28.42	41.38	28.77	56.00	46.00	-14.62	-17.23
9	7.63672	0.43	40.96	35.02	41.39	35.45	60.00	50.00	-18.61	-14.55

- REMARKS:**
1. Q.P. and AV. are abbreviations of quasi-peak and average individually.
  2. The emission levels of other frequencies were very low against the limit.
  3. Margin value = Emission level - Limit value
  4. Correction factor = Insertion loss + Cable loss
  5. Emission Level = Correction Factor + Reading Value.

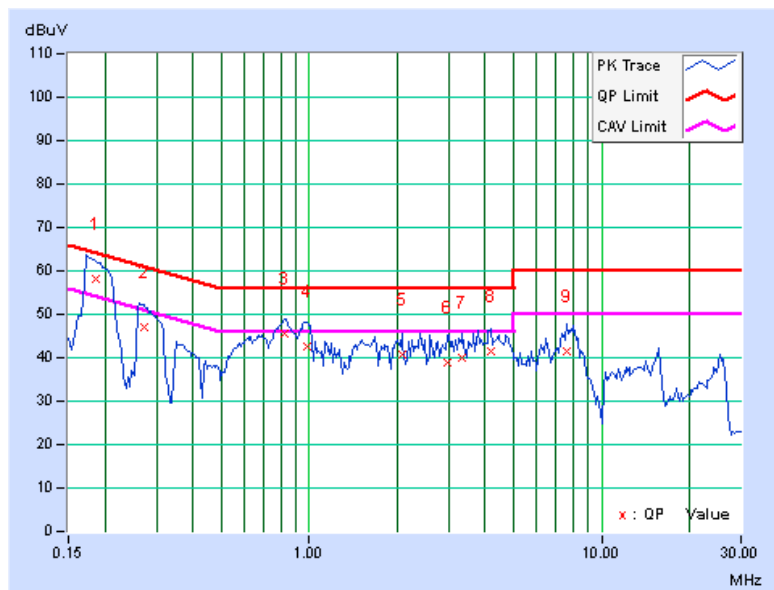

### 4.3 6dB BANDWIDTH MEASUREMENT

#### 4.3.1 LIMITS OF 6dB BANDWIDTH MEASUREMENT

The minimum of 6dB Bandwidth Measurement is 0.5 MHz.

#### 4.3.2 TEST SETUP

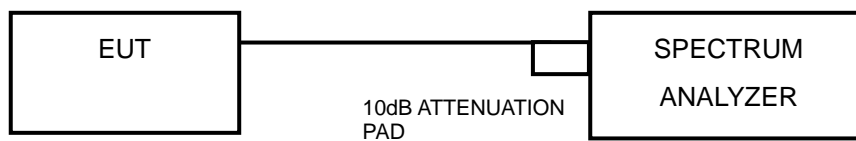

#### 4.3.3 TEST INSTRUMENTS

Refer to section 4.1.2 to get information of above instrument.

#### 4.3.4 TEST PROCEDURE

- a. Set resolution bandwidth (RBW) = approximately 1% of the emission bandwidth
- b. Set the video bandwidth (VBW)  $\geq 3 \times$  RBW, Detector = Peak.
- c. Trace mode = max hold.
- d. Sweep = auto couple.
- e. Measure the maximum width of the emission that is constrained by the frequencies associated with the two amplitude points (upper and lower) that are attenuated by 6 dB relative to the maximum level measured in the fundamental emission

#### 4.3.5 DEVIATION FROM TEST STANDARD

No deviation.

#### 4.3.6 EUT OPERATING CONDITIONS

The software provided by client to enable the EUT under transmission condition continuously at lowest, middle and highest channel frequencies individually.



A D T

### 4.3.7 TEST RESULTS

#### 802.11b

CHANNEL	FREQUENCY (MHz)	6dB BANDWIDTH (MHz)	MINIMUM LIMIT (MHz)	PASS / FAIL
1	2412	10.20	0.5	PASS
6	2437	10.18	0.5	PASS
11	2462	10.20	0.5	PASS

#### CH 1

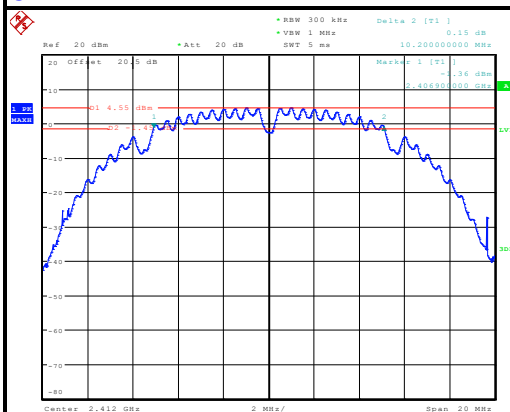

Date: 24.MAY.2012 05:20:45

#### CH 6

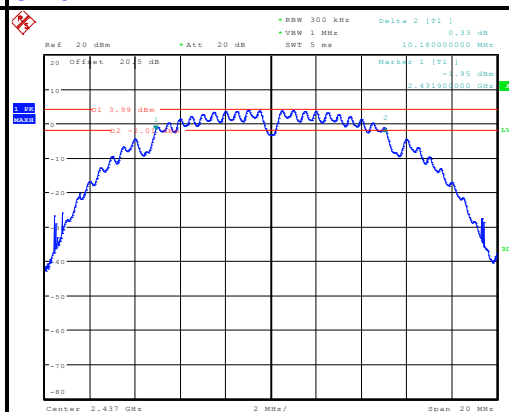

Date: 24.MAY.2012 05:29:19

#### CH 11

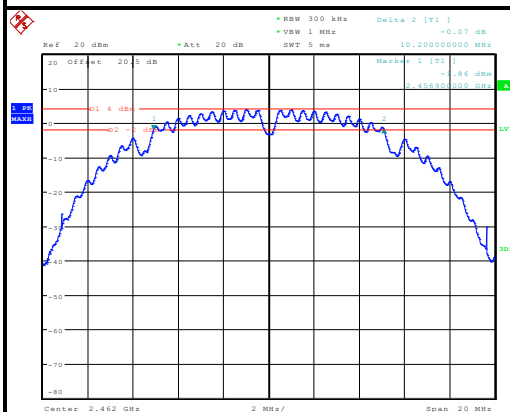

Date: 24.MAY.2012 05:30:22



A D T

802.11g

CHANNEL	FREQUENCY (MHz)	6dB BANDWIDTH (MHz)	MINIMUM LIMIT (MHz)	PASS / FAIL
1	2412	16.52	0.5	PASS
6	2437	16.52	0.5	PASS
11	2462	16.52	0.5	PASS

CH 1

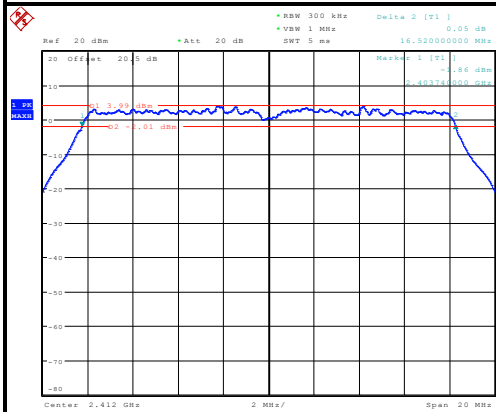

Date: 24.MAY.2012 05:38:10

CH 6

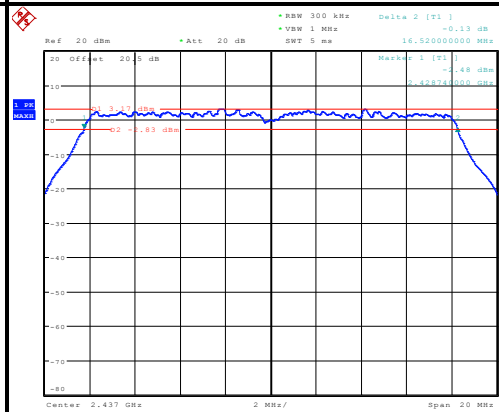

Date: 24.MAY.2012 05:45:40

CH 11

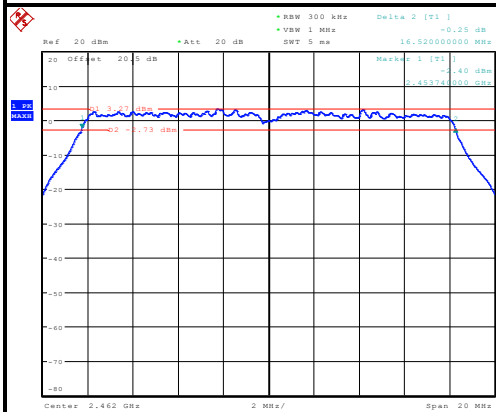

Date: 24.MAY.2012 05:47:35



A D T

802.11n (20MHz)

CHANNEL	FREQUENCY (MHz)	6dB BANDWIDTH (MHz)	MINIMUM LIMIT (MHz)	PASS / FAIL
1	2412	17.80	0.5	PASS
6	2437	17.80	0.5	PASS
11	2462	17.80	0.5	PASS

CH 1

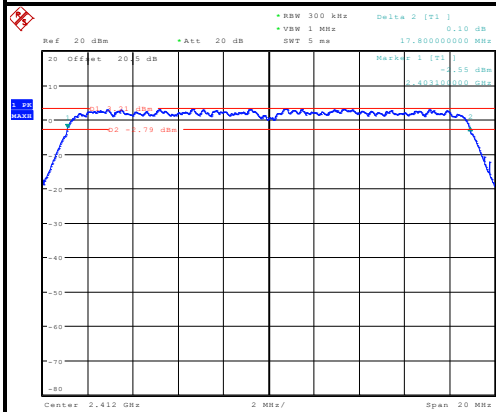

Date: 24.MAY.2012 05:56:29

CH 6

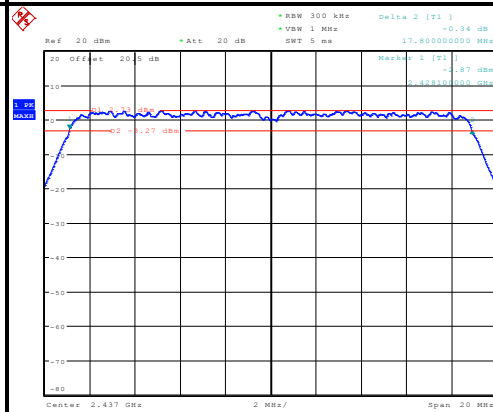

Date: 24.MAY.2012 06:02:24

CH 11

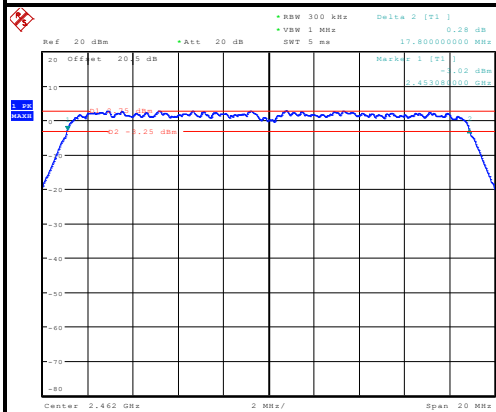

Date: 24.MAY.2012 06:03:20



A D T

802.11n (40MHz)

CHANNEL	FREQUENCY (MHz)	6dB BANDWIDTH (MHz)	MINIMUM LIMIT (MHz)	PASS / FAIL
1	2422	36.72	0.5	PASS
4	2437	36.72	0.5	PASS
7	2452	36.64	0.5	PASS

CH 1

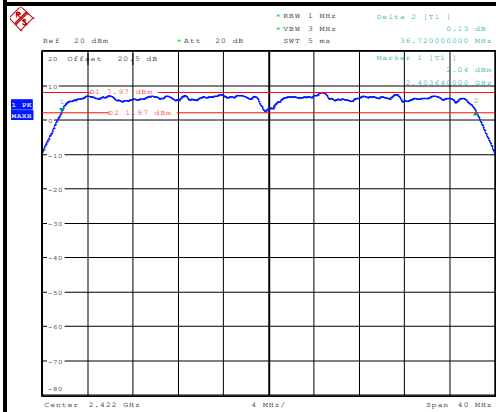

Date: 24\_MAY.2012 07:20:29

CH 6

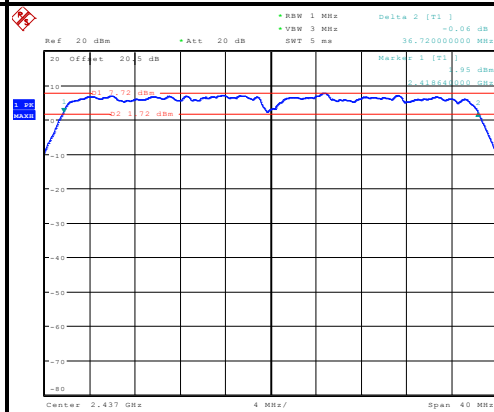

Date: 24\_MAY.2012 07:31:45

CH 11

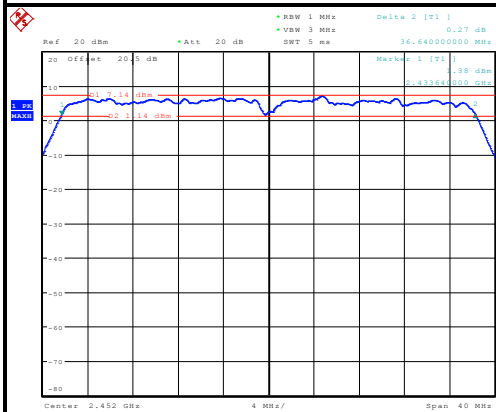

Date: 24\_MAY.2012 07:33:22

## 4.4 CONDUCTED OUTPUT POWER

### 4.4.1 LIMITS OF CONDUCTED OUTPUT POWER MEASUREMENT

For systems using digital modulation in the 2400–2483.5 MHz: 1 Watt (30dBm)

### 4.4.2 TEST SETUP

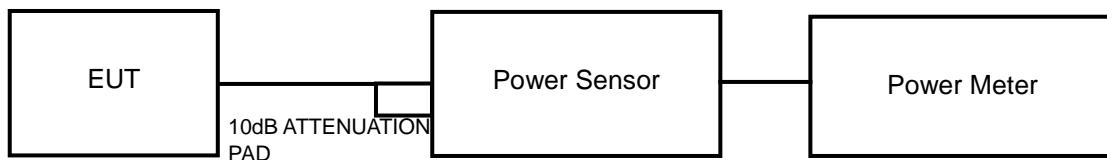

### 4.4.3 TEST INSTRUMENTS

Refer to section 4.1.2 to get information of above instrument.

### 4.4.4 TEST PROCEDURES

A peak power sensor was used on the output port of the EUT. A power meter was used to read the response of the peak power sensor. Record the peak power level.

### 4.4.5 DEVIATION FROM TEST STANDARD

No deviation.

### 4.4.6 EUT OPERATING CONDITIONS

Same as Item 4.3.6.



#### 4.4.7 TEST RESULTS

##### 802.11b

CHANNEL	FREQUENCY (MHz)	PEAK POWER (mW)	PEAK POWER (dBm)	LIMIT (dBm)	PASS/FAIL
1	2412	40.272	16.05	30	PASS
6	2437	35.727	15.53	30	PASS
11	2462	37.757	15.77	30	PASS

##### 802.11g

CHANNEL	FREQUENCY (MHz)	PEAK POWER (mW)	PEAK POWER (dBm)	LIMIT (dBm)	PASS/FAIL
1	2412	186.209	22.7	30	PASS
6	2437	160.694	22.06	30	PASS
11	2462	162.555	22.11	30	PASS

##### 802.11n (20MHz)

CHANNEL	FREQUENCY (MHz)	PEAK POWER (mW)	PEAK POWER (dBm)	LIMIT (dBm)	PASS/FAIL
1	2412	200.447	23.02	30	PASS
6	2437	157.398	21.97	30	PASS
11	2462	177.828	22.5	30	PASS

##### 802.11n (40MHz)

CHANNEL	FREQUENCY (MHz)	PEAK POWER (mW)	PEAK POWER (dBm)	LIMIT (dBm)	PASS/FAIL
1	2422	177.419	22.49	30	PASS
4	2437	155.955	21.93	30	PASS
7	2452	121.339	20.84	30	PASS

## 4.5 POWER SPECTRAL DENSITY MEASUREMENT

### 4.5.1 LIMITS OF POWER SPECTRAL DENSITY MEASUREMENT

The Maximum of Power Spectral Density Measurement is 8dBm.

### 4.5.2 TEST SETUP

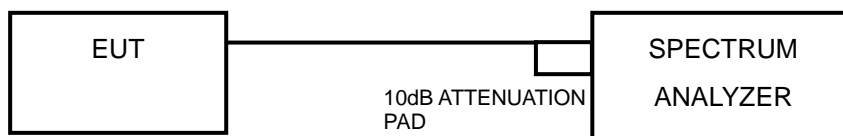

### 4.5.3 TEST INSTRUMENTS

Refer to section 4.1.2 to get information of above instrument.

### 4.5.4 TEST PROCEDURE

- a. Set the RBW = 100 kHz, VBW = 300 kHz, Detector = peak.
- b. Sweep time = auto couple, Trace mode = max hold, allow trace to fully stabilize.
- c. Use the peak marker function to determine the maximum power level in any 100 kHz band segment within the fundamental EBW.
- d. Scale the observed power level to an equivalent value in 3 kHz by adjusting (reducing) the measured power by a bandwidth correction factor (BWCF) where  $BWCF = 10\log(3 \text{ kHz}/100\text{kHz})$

### 4.5.5 DEVIATION FROM TEST STANDARD

No deviation.

### 4.5.6 EUT OPERATING CONDITION

Same as Item 4.3.6



A D T

### 4.5.7 TEST RESULTS

#### 802.11b

Channel	FREQ. (MHz)	PSD (dBm/100kHz)	PSD (dBm/3kHz)	Limit (dBm/3kHz)	PASS /FAIL
1	2412	2.25	-12.95	8	PASS
6	2437	1.68	-13.52	8	PASS
11	2462	1.62	-13.58	8	PASS

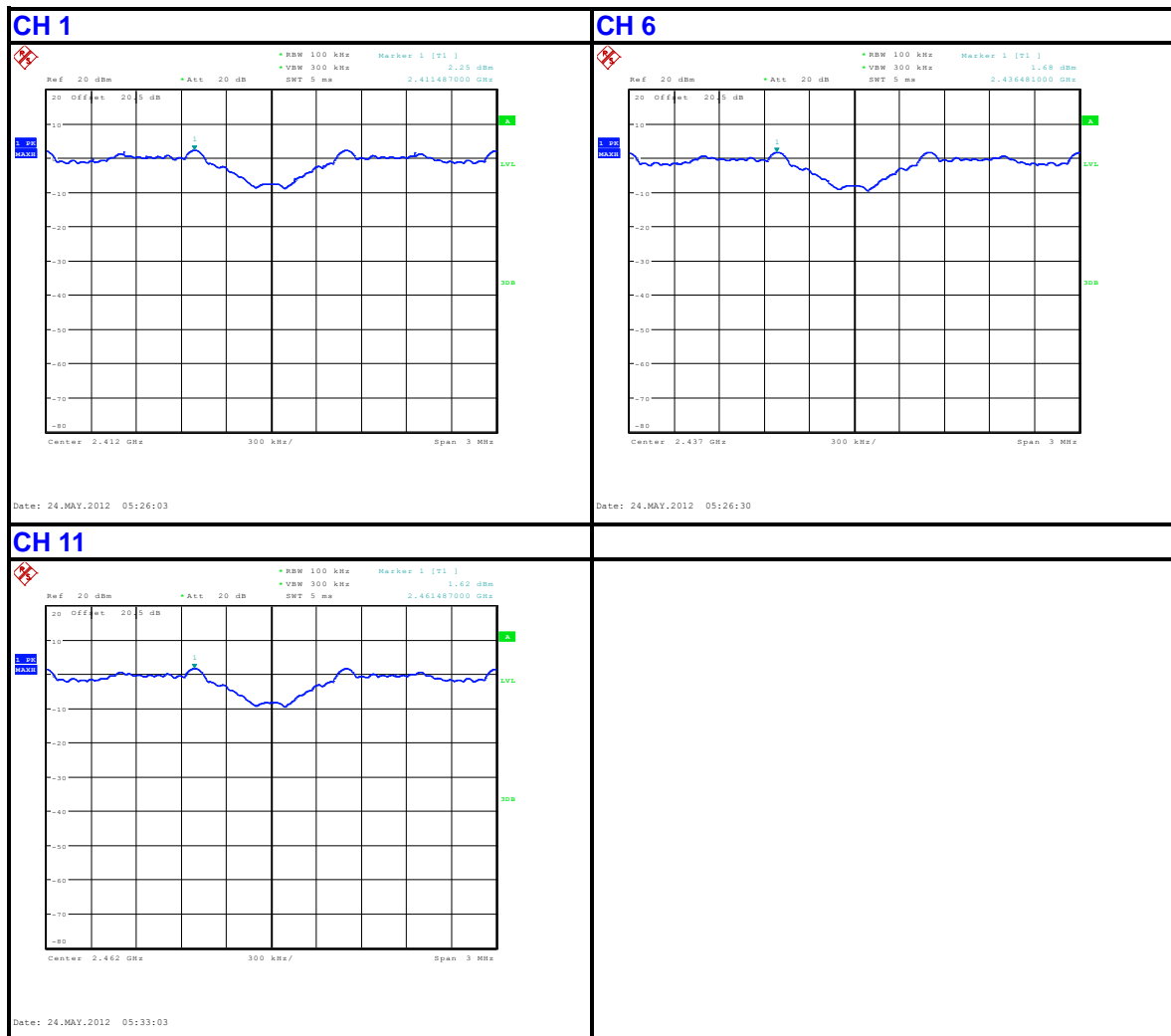



A D T

802.11g

Channel	FREQ. (MHz)	PSD (dBm/100kHz)	PSD (dBm/3kHz)	Limit (dBm/3kHz)	PASS /FAIL
1	2412	-2.65	-17.85	8	PASS
6	2437	-3.20	-18.40	8	PASS
11	2462	-3.28	-18.48	8	PASS

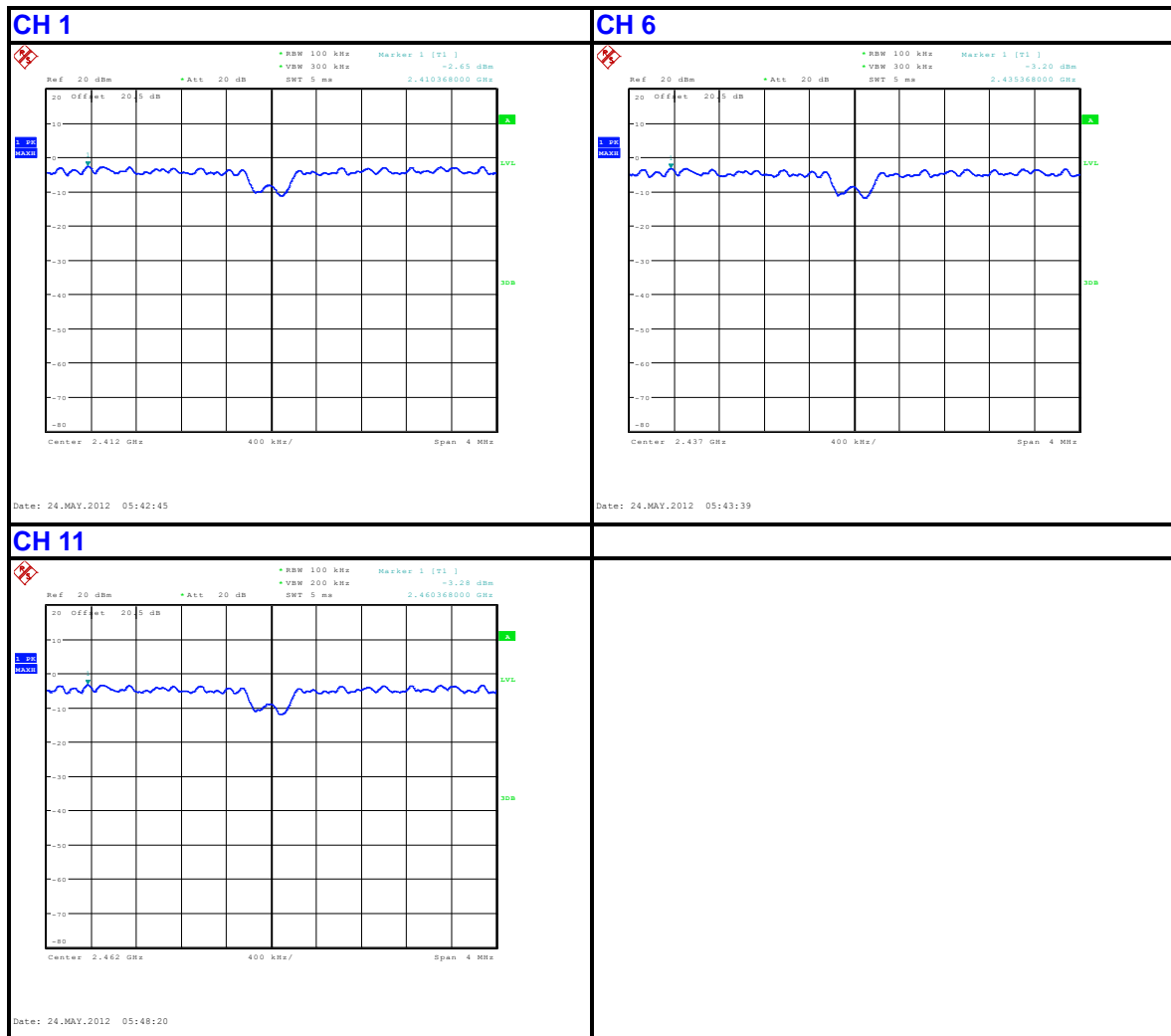



A D T

802.11n (20MHz)

Channel	FREQ. (MHz)	PSD (dBm/100kHz)	PSD (dBm/3kHz)	Limit (dBm/3kHz)	PASS /FAIL
1	2412	-2.45	-17.65	8	PASS
6	2437	-2.91	-18.11	8	PASS
11	2462	-2.92	-18.12	8	PASS

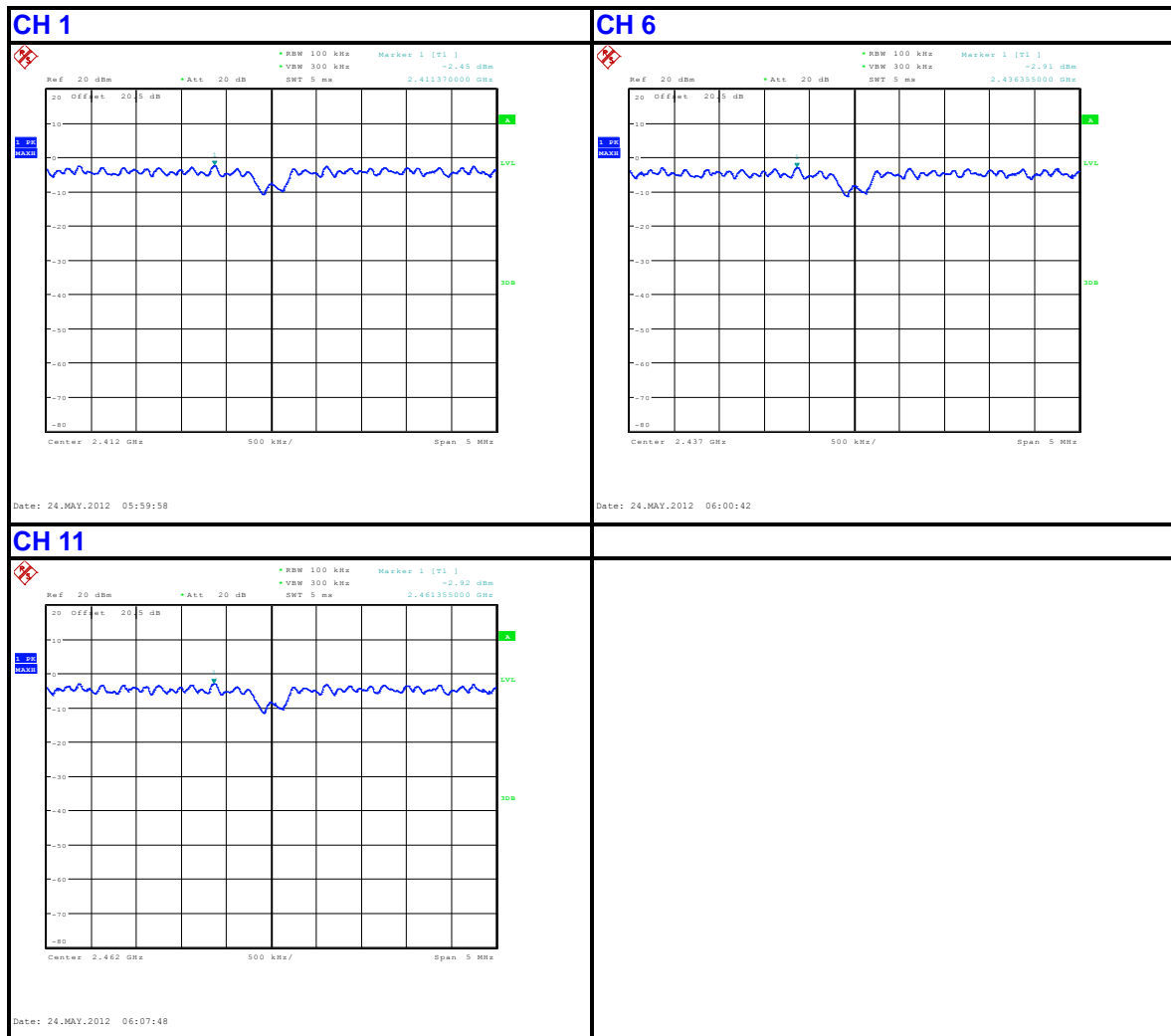



A D T

### 802.11n (40MHz)

Channel	FREQ. (MHz)	PSD (dBm/100kHz)	PSD (dBm/3kHz)	Limit (dBm/3kHz)	PASS /FAIL
1	2422	-2.87	-18.07	8	PASS
4	2437	-2.95	-18.15	8	PASS
7	2452	-3.66	-18.86	8	PASS

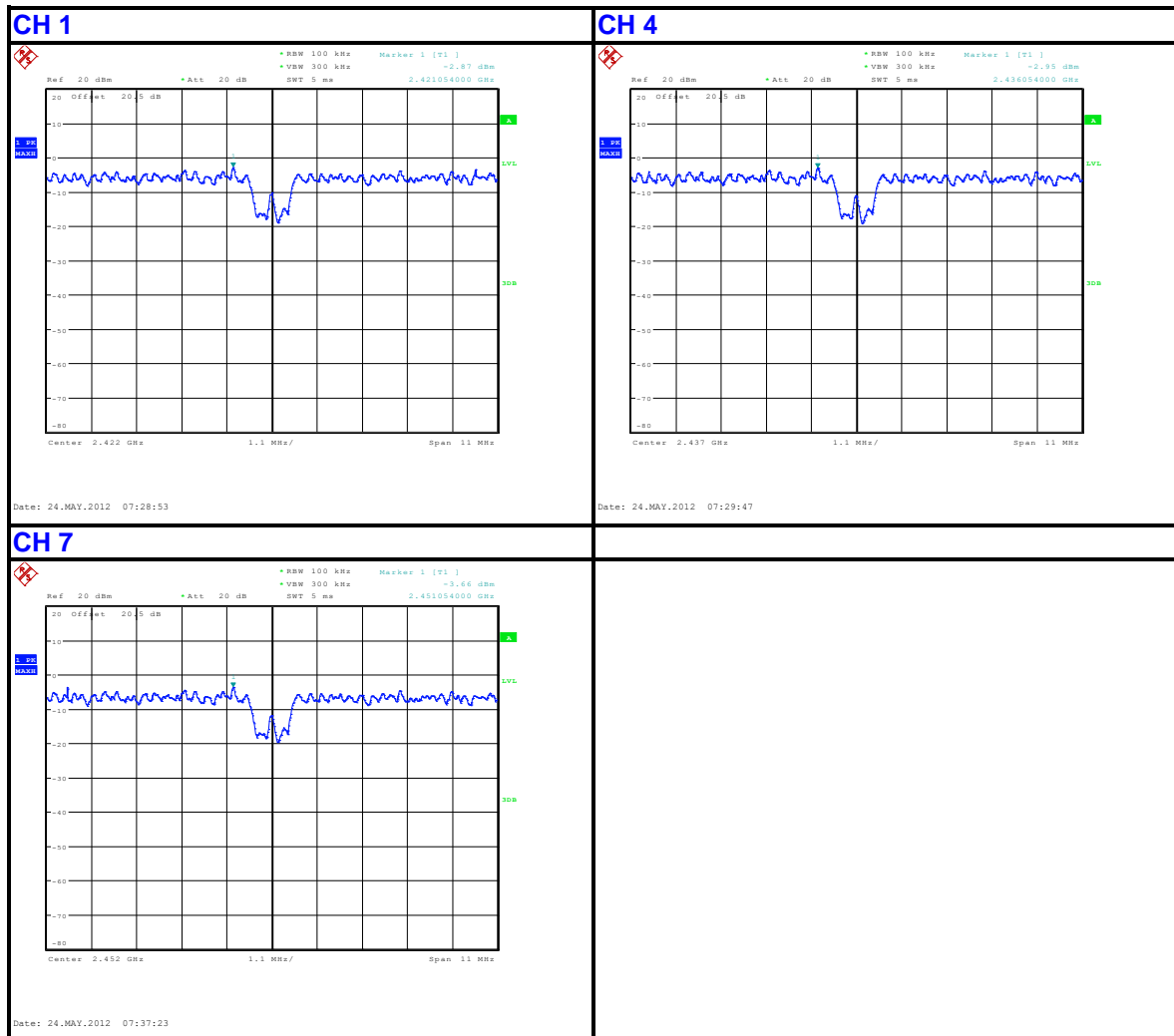

## 4.6 BAND EDGES MEASUREMENT

### 4.6.1 LIMITS OF OUT OF BAND EMISSION MEASUREMENT

Below  $-20\text{dB}$  of the highest emission level of operating band (in 100kHz Resolution Bandwidth).

### 4.6.2 TEST SETUP

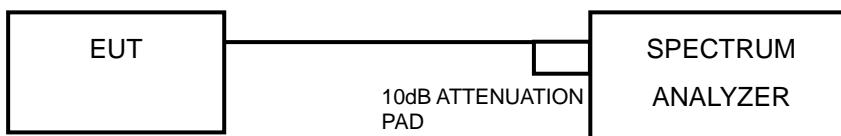

### 4.6.3 TEST INSTRUMENTS

Refer to section 4.1.2 to get information of above instrument.



A D T

#### 4.6.4 TEST PROCEDURE

RBW= 100 kHz; VBW= 300 kHz is used for RF conducted measurement. The band edges was measured and recorded.

#### 4.6.5 DEVIATION FROM TEST STANDARD

No deviation.

#### 4.6.6 EUT OPERATING CONDITION

Same as Item 4.3.6

#### 4.6.7 TEST RESULTS

The spectrum plots are attached on the following pages. D1 line indicates the highest level, and D2 line indicates the 20dB offset below D1. It shows compliance with the requirement.



A D T

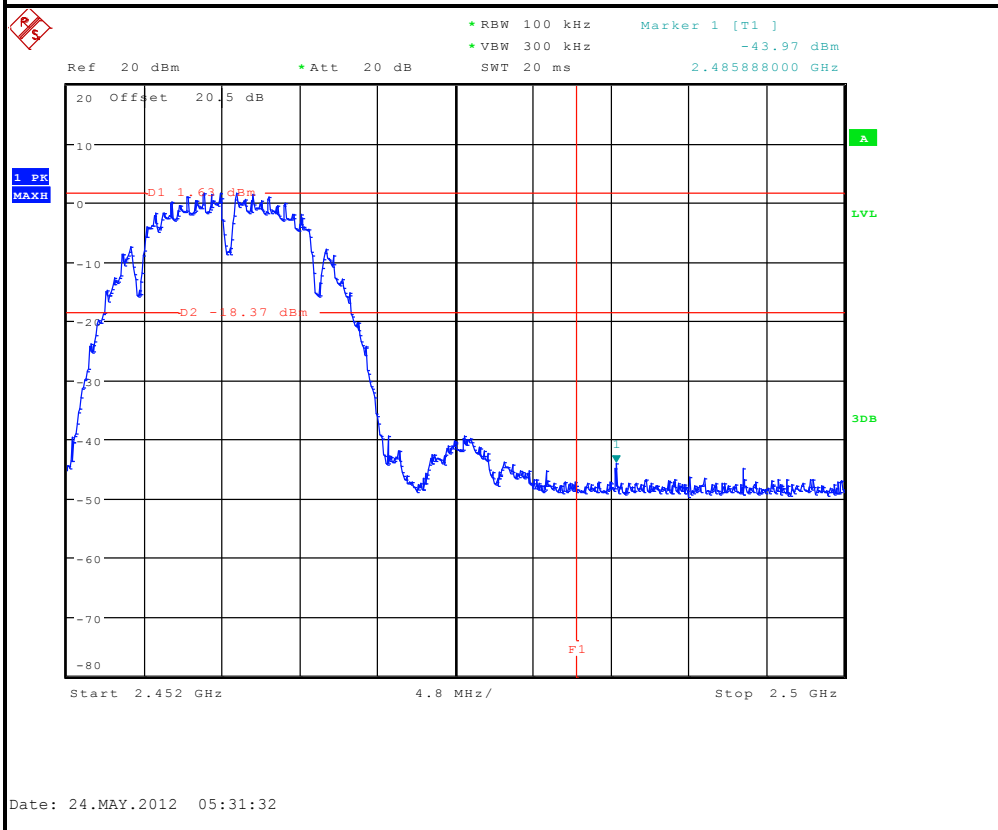
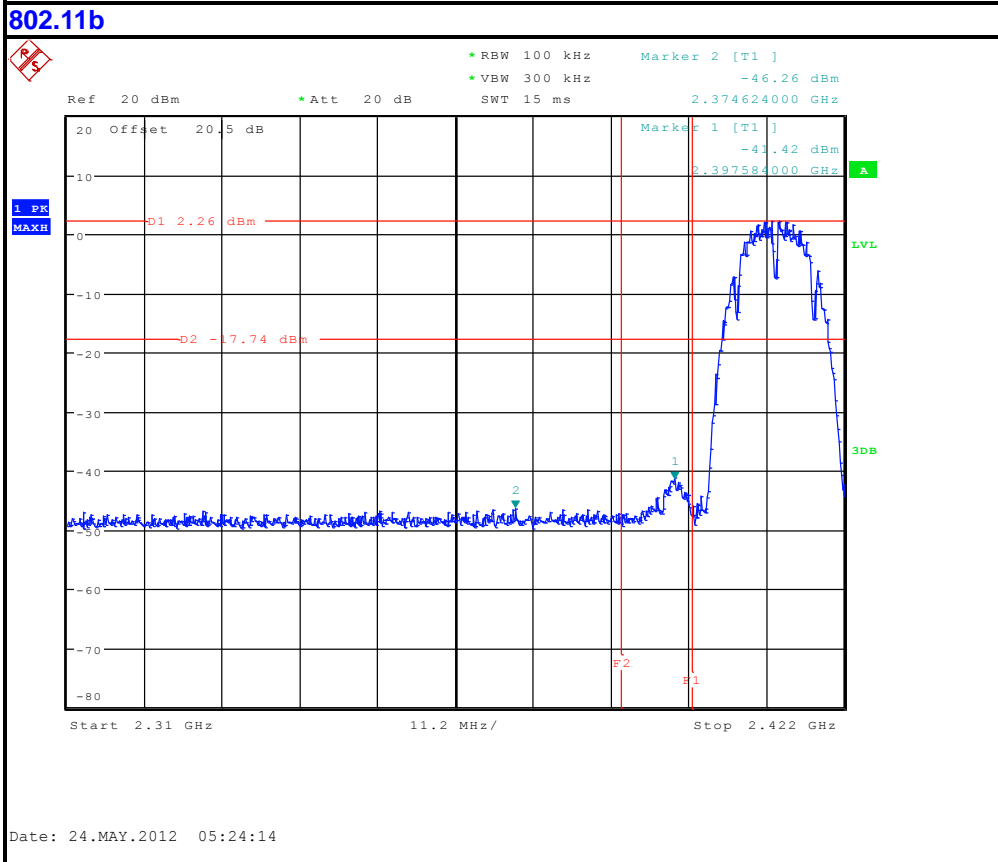



A D T

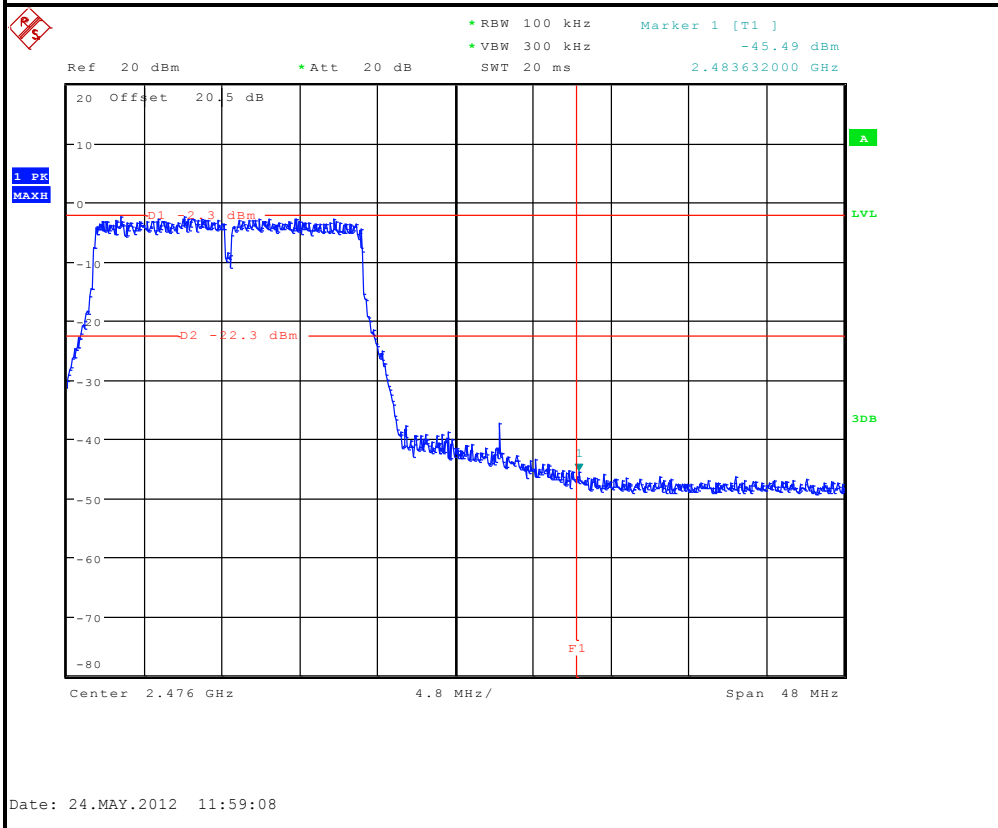
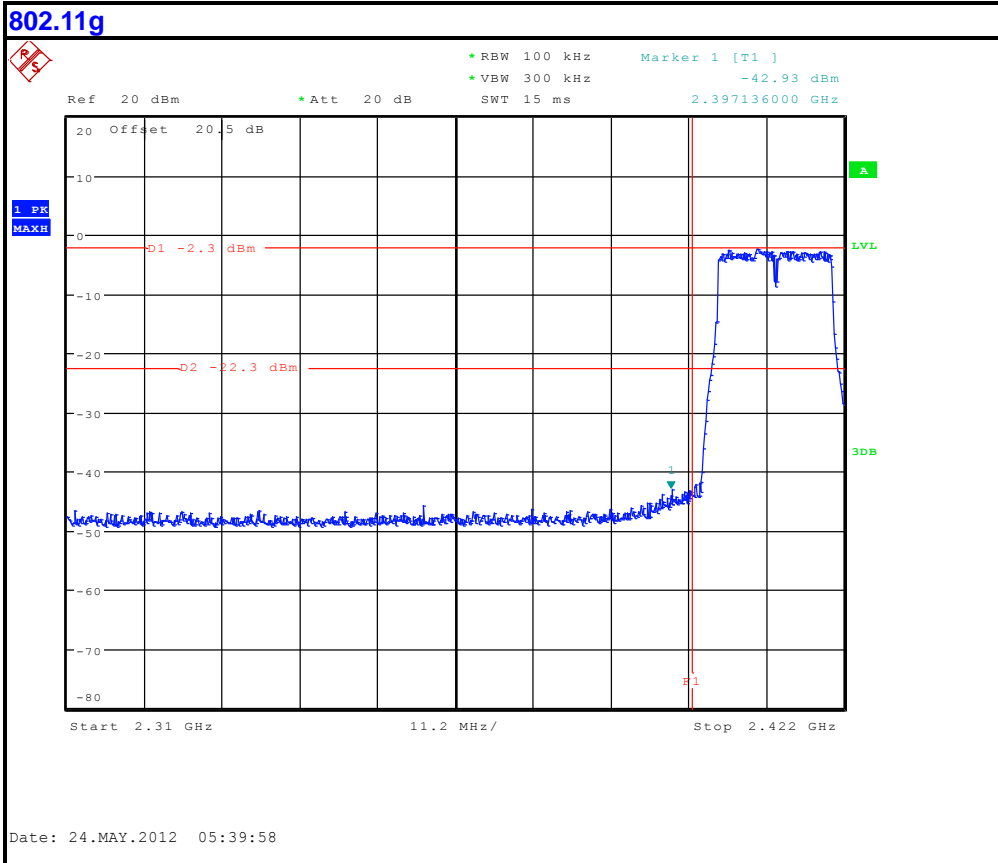



A D T

### 802.11n (20MHz)

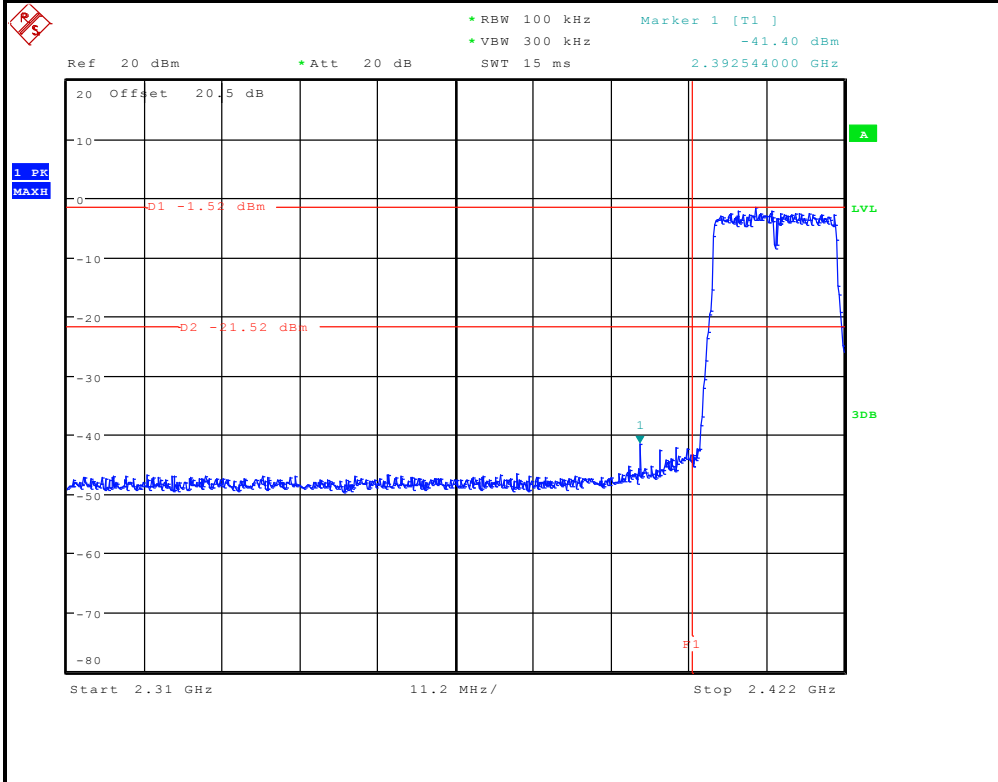

Date: 24.MAY.2012 05:58:03

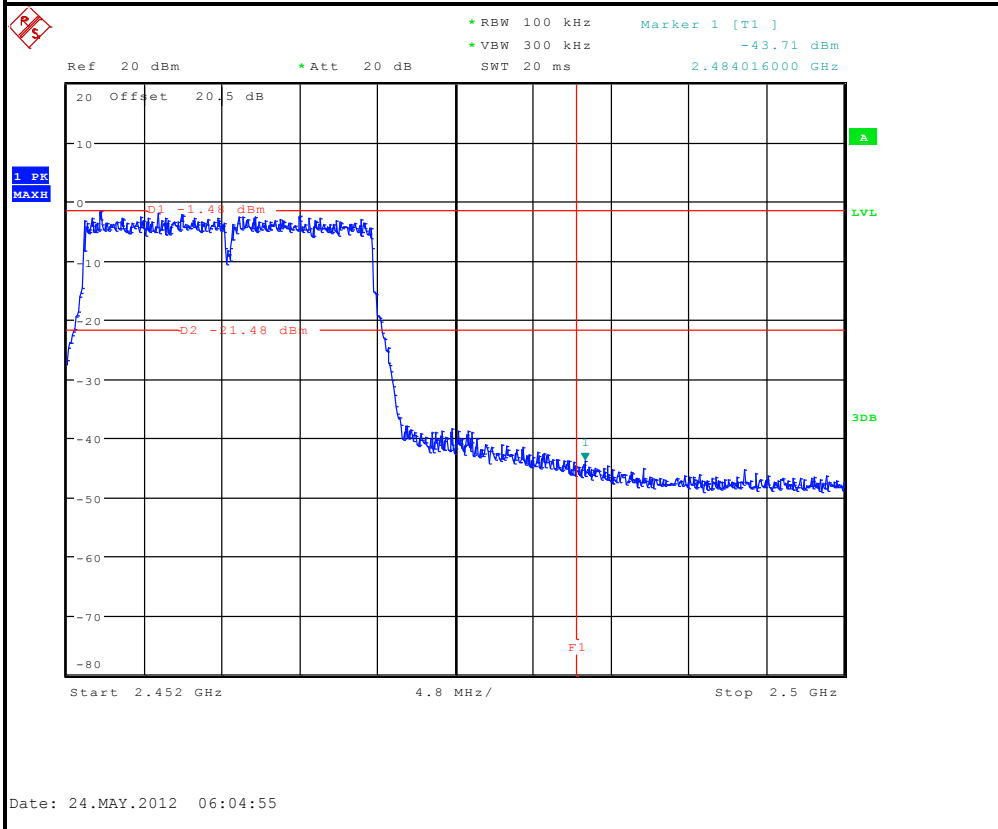

Date: 24.MAY.2012 06:04:55



A D T

### 802.11n (40MHz)

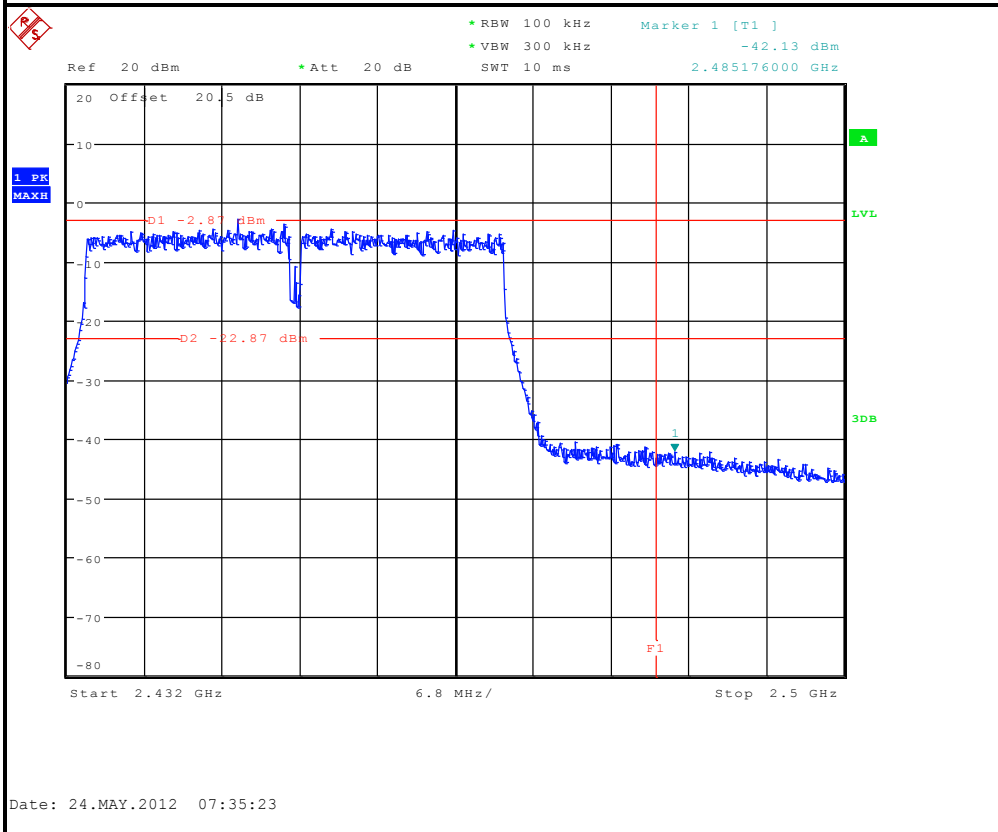
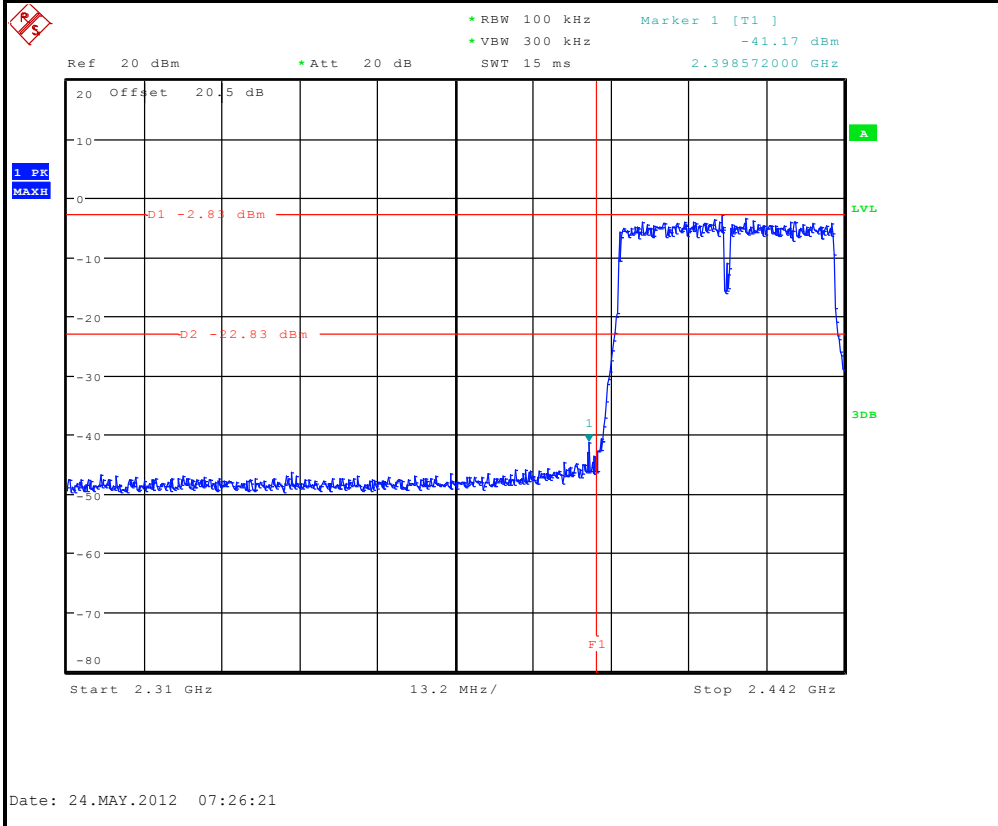

## 5. TEST TYPES AND RESULTS (FOR 5.0GHz BAND)

### 5.1 RADIATED EMISSION AND BANDEGE MEASUREMENT

#### 5.1.1 LIMITS OF RADIATED EMISSION AND BANDEGE MEASUREMENT

Radiated emissions which fall in the restricted bands must comply with the radiated emission limits specified as below table. Other emissions shall be at least 20dB below the highest level of the desired power:

FREQUENCIES (MHz)	FIELD STRENGTH (microvolts/meter)	MEASUREMENT DISTANCE (meters)
0.009 ~ 0.490	2400/F(kHz)	300
0.490 ~ 1.705	24000/F(kHz)	30
1.705 ~ 30.0	30	30
30 ~ 88	100	3
88 ~ 216	150	3
216 ~ 960	200	3
Above 960	500	3

**NOTE:**

1. The lower limit shall apply at the transition frequencies.
2. Emission level (dBuV/m) = 20 log Emission level (uV/m).
3. For frequencies above 1000MHz, the field strength limits are based on average detector, however, the peak field strength of any emission shall not exceed the maximum permitted average limits, specified above by more than 20dB under any condition of modulation.



A D T

#### 5.1.2 TEST INSTRUMENTS

Same as item 4.1.2.

#### 5.1.3 TEST PROCEDURES

Same as item 4.1.3.

#### 5.1.4 DEVIATION FROM TEST STANDARD

No deviation.

#### 5.1.5 TEST SETUP

Same as item 4.1.5.

#### 5.1.6 EUT OPERATING CONDITIONS

Same as item 4.1.6.



A D T

## 5.1.7 TEST RESULTS

### 802.11a

EUT TEST CONDITION		MEASUREMENT DETAIL	
CHANNEL	Channel 149	FREQUENCY RANGE	30MHz ~ 40GHz
INPUT POWER (SYSTEM)	120Vac, 60 Hz	DETECTOR FUNCTION	Peak (PK) Average (AV)
ENVIRONMENTAL CONDITIONS	25deg. C, 65%RH	TESTED BY	Kay Wu

ANTENNA POLARITY & TEST DISTANCE: HORIZONTAL AT 3 M										
FREQ. (MHz)	EMISSION LEVEL (dBuV/m)	READ LEVEL (dBuV)	LIMIT (dBuV/m)	MARGIN (dB)	ANTENNA FACTOR (dB/m)	CABLE LOSS (dB)	PREAMP FACTOR (dB)	ANTENNA HEIGHT (cm)	TABLE ANGLE (Degree)	REMARK
5725	43.37	39.53	68.39	-25.02	32.36	6.62	35.14	111	214	Average
5725	60.01	56.17	78.72	-18.71	32.36	6.62	35.14	110	214	Peak
5745	88.39	84.52			32.38	6.64	35.15	110	214	Average
5745	98.72	94.85			32.38	6.64	35.15	110	214	Peak
5850	38.06	33.96	68.39	-30.33	32.53	6.7	35.13	110	214	Average
5850	48.04	43.94	78.72	-30.68	32.53	6.7	35.13	110	214	Peak
ANTENNA POLARITY & TEST DISTANCE: VERTICAL AT 3 M										
FREQ. (MHz)	EMISSION LEVEL (dBuV/m)	READ LEVEL (dBuV)	LIMIT (dBuV/m)	MARGIN (dB)	ANTENNA FACTOR (dB/m)	CABLE LOSS (dB)	PREAMP FACTOR (dB)	ANTENNA HEIGHT (cm)	TABLE ANGLE (Degree)	REMARK
5725	46.06	42.22	70.18	-24.12	32.36	6.62	35.14	134	179	Average
5725	62.08	58.24	80.67	-18.59	32.36	6.62	35.14	134	179	Peak
5745	90.18	86.31			32.38	6.64	35.15	134	179	Average
5745	100.67	96.8			32.38	6.64	35.15	134	179	Peak
5850	37.35	33.25	70.18	-32.83	32.53	6.7	35.13	134	179	Average
5850	47.62	43.52	80.67	-33.05	32.53	6.7	35.13	134	179	Peak

#### REMARKS:

- 5745MHz: Fundamental frequency.
- 5725MHz & 5850MHz: Out of restricted band



**A D T**

EUT TEST CONDITION		MEASUREMENT DETAIL	
CHANNEL	Channel 157	FREQUENCY RANGE	30MHz ~ 40GHz
INPUT POWER (SYSTEM)	120Vac, 60 Hz	DETECTOR FUNCTION	Peak (PK) Average (AV)
ENVIRONMENTAL CONDITIONS	25deg. C, 65%RH	TESTED BY	Kay Wu

ANTENNA POLARITY & TEST DISTANCE: HORIZONTAL AT 3 M										
FREQ. (MHz)	EMISSION LEVEL (dBuV/m)	READ LEVEL (dBuV)	LIMIT (dBuV/m)	MARGIN (dB)	ANTENNA FACTOR (dB/m)	CABLE LOSS (dB)	PREAMP FACTOR (dB)	ANTENNA HEIGHT (cm)	TABLE ANGLE (Degree)	REMARK
5725	36.99	33.15	67.7	-30.71	32.36	6.62	35.14	100	154	Average
5725	47.08	43.24	78.21	-31.13	32.36	6.62	35.14	100	154	Peak
5785	87.7	83.75			32.43	6.7	35.18	100	154	Average
5785	98.21	94.26			32.43	6.7	35.18	100	154	Peak
5850	37.65	33.55	67.7	-30.05	32.53	6.7	35.13	100	154	Average
5850	47.72	43.62	78.21	-30.49	32.53	6.7	35.13	100	154	Peak
ANTENNA POLARITY & TEST DISTANCE: VERTICAL AT 3 M										
FREQ. (MHz)	EMISSION LEVEL (dBuV/m)	READ LEVEL (dBuV)	LIMIT (dBuV/m)	MARGIN (dB)	ANTENNA FACTOR (dB/m)	CABLE LOSS (dB)	PREAMP FACTOR (dB)	ANTENNA HEIGHT (cm)	TABLE ANGLE (Degree)	REMARK
5725	36	32.16	69.24	-33.24	32.36	6.62	35.14	115	237	Average
5725	48.18	44.34	79.73	-31.55	32.36	6.62	35.14	115	237	Peak
5785	89.24	85.29			32.43	6.7	35.18	115	237	Average
5785	99.73	95.78			32.43	6.7	35.18	115	237	Peak
5850	36.34	32.24	69.24	-32.9	32.53	6.7	35.13	115	237	Average
5850	49.24	45.14	79.73	-30.49	32.53	6.7	35.13	115	237	Peak

**REMARKS:**

- 5785MHz: Fundamental frequency.
- 5725MHz & 5850MHz: Out of restricted band



**A D T**

EUT TEST CONDITION		MEASUREMENT DETAIL	
CHANNEL	Channel 165	FREQUENCY RANGE	30MHz ~ 40GHz
INPUT POWER (SYSTEM)	120Vac, 60 Hz	DETECTOR FUNCTION	Peak (PK) Average (AV)
ENVIRONMENTAL CONDITIONS	25deg. C, 65%RH	TESTED BY	Kay Wu

ANTENNA POLARITY & TEST DISTANCE: HORIZONTAL AT 3 M										
FREQ. (MHz)	EMISSION LEVEL (dBuV/m)	READ LEVEL (dBuV)	LIMIT (dBuV/m)	MARGIN (dB)	ANTENNA FACTOR (dB/m)	CABLE LOSS (dB)	PREAMP FACTOR (dB)	ANTENNA HEIGHT (cm)	TABLE ANGLE (Degree)	REMARK
5725	37.03	33.19	67.56	-30.53	32.36	6.62	35.14	100	241	Average
5725	46.93	43.09	77.96	-31.03	32.36	6.62	35.14	100	241	Peak
5825	87.56	83.5			32.51	6.7	35.15	100	241	Average
5825	97.96	93.9			32.51	6.7	35.15	100	241	Peak
5850	41.73	37.63	67.56	-25.83	32.53	6.7	35.13	100	241	Average
5850	53.75	49.65	77.96	-24.21	32.53	6.7	35.13	100	241	Peak
ANTENNA POLARITY & TEST DISTANCE: VERTICAL AT 3 M										
FREQ. (MHz)	EMISSION LEVEL (dBuV/m)	READ LEVEL (dBuV)	LIMIT (dBuV/m)	MARGIN (dB)	ANTENNA FACTOR (dB/m)	CABLE LOSS (dB)	PREAMP FACTOR (dB)	ANTENNA HEIGHT (cm)	TABLE ANGLE (Degree)	REMARK
5725	36.12	32.28	70.01	-33.89	32.36	6.62	35.14	110	169	Average
5725	47.26	43.42	80.31	-33.05	32.36	6.62	35.14	110	169	Peak
5825	90.01	85.95			32.51	6.7	35.15	110	169	Average
5825	100.31	96.25			32.51	6.7	35.15	110	169	Peak
5850	42.35	38.25	70.01	-27.66	32.53	6.7	35.13	110	169	Average
5850	56.09	51.99	80.31	-24.22	32.53	6.7	35.13	110	169	Peak

**REMARKS:**

- 5825MHz: Fundamental frequency.
- 5725MHz & 5850MHz: Out of restricted band



A D T

802.11n (20MHz)

EUT TEST CONDITION		MEASUREMENT DETAIL	
CHANNEL	Channel 149	FREQUENCY RANGE	30MHz ~ 40GHz
INPUT POWER (SYSTEM)	120Vac, 60 Hz	DETECTOR FUNCTION	Peak (PK) Average (AV)
ENVIRONMENTAL CONDITIONS	25deg. C, 65%RH	TESTED BY	Kay Wu

ANTENNA POLARITY & TEST DISTANCE: HORIZONTAL AT 3 M										
FREQ. (MHz)	EMISSION LEVEL (dBuV/m)	READ LEVEL (dBuV)	LIMIT (dBuV/m)	MARGIN (dB)	ANTENNA FACTOR (dB/m)	CABLE LOSS (dB)	PREAMP FACTOR (dB)	ANTENNA HEIGHT (cm)	TABLE ANGLE (Degree)	REMARK
5725	45.15	41.31	69.52	-24.37	32.36	6.62	35.14	100	267	Average
5725	65.99	62.15	80.51	-14.52	32.36	6.62	35.14	100	267	Peak
5745	89.52	85.65			32.38	6.64	35.15	100	267	Average
5745	100.51	96.64			32.38	6.64	35.15	100	267	Peak
5850	36.79	32.69	69.52	-32.73	32.53	6.7	35.13	100	267	Average
5850	46.89	42.79	80.51	-33.62	32.53	6.7	35.13	100	267	Peak
ANTENNA POLARITY & TEST DISTANCE: HORIZONTAL AT 3 M										
FREQ. (MHz)	EMISSION LEVEL (dBuV/m)	READ LEVEL (dBuV)	LIMIT (dBuV/m)	MARGIN (dB)	ANTENNA FACTOR (dB/m)	CABLE LOSS (dB)	PREAMP FACTOR (dB)	ANTENNA HEIGHT (cm)	TABLE ANGLE (Degree)	REMARK
5725	45.96	42.12	71.24	-25.28	32.36	6.62	35.14	120	171	Average
5725	66.63	62.79	82.16	-15.53	32.36	6.62	35.14	120	171	Peak
5745	91.24	87.37			32.38	6.64	35.15	120	171	Average
5745	102.16	98.29			32.38	6.64	35.15	120	171	Peak
5850	36.2	32.1	71.24	-35.04	32.53	6.7	35.13	120	171	Average
5850	46.99	42.89	82.16	-35.17	32.53	6.7	35.13	120	171	Peak

REMARKS:

- 5745MHz: Fundamental frequency.
- 5725MHz & 5850MHz: Out of restricted band



A D T

EUT TEST CONDITION		MEASUREMENT DETAIL	
CHANNEL	Channel 157	FREQUENCY RANGE	30MHz ~ 40GHz
INPUT POWER (SYSTEM)	120Vac, 60 Hz	DETECTOR FUNCTION	Peak (PK) Average (AV)
ENVIRONMENTAL CONDITIONS	25deg. C, 65%RH	TESTED BY	Kay Wu

ANTENNA POLARITY & TEST DISTANCE: HORIZONTAL AT 3 M										
FREQ. (MHz)	EMISSION LEVEL (dBuV/m)	READ LEVEL (dBuV)	LIMIT (dBuV/m)	MARGIN (dB)	ANTENNA FACTOR (dB/m)	CABLE LOSS (dB)	PREAMP FACTOR (dB)	ANTENNA HEIGHT (cm)	TABLE ANGLE (Degree)	REMARK
5725	37.03	33.19	68.09	-31.06	32.36	6.62	35.14	130	264	Average
5725	47.86	44.02	78.54	-30.68	32.36	6.62	35.14	130	264	Peak
5785	88.09	84.14			32.43	6.7	35.18	130	264	Average
5785	98.54	94.59			32.43	6.7	35.18	130	264	Peak
5850	36.35	32.25	68.09	-31.74	32.53	6.7	35.13	130	264	Average
5850	47.91	43.81	78.54	-30.63	32.53	6.7	35.13	130	264	Peak
ANTENNA POLARITY & TEST DISTANCE: VERTICAL AT 3 M										
FREQ. (MHz)	EMISSION LEVEL (dBuV/m)	READ LEVEL (dBuV)	LIMIT (dBuV/m)	MARGIN (dB)	ANTENNA FACTOR (dB/m)	CABLE LOSS (dB)	PREAMP FACTOR (dB)	ANTENNA HEIGHT (cm)	TABLE ANGLE (Degree)	REMARK
5725	36.98	33.14	70.9	-33.92	32.36	6.62	35.14	110	184	Average
5725	48.25	44.41	81.51	-33.26	32.36	6.62	35.14	110	184	Peak
5785	90.9	86.95			32.43	6.7	35.18	110	184	Average
5785	101.51	97.56			32.43	6.7	35.18	110	184	Peak
5850	36.65	32.55	70.9	-34.25	32.53	6.7	35.13	110	184	Average
5850	48.55	44.45	81.51	-32.96	32.53	6.7	35.13	110	184	Peak

REMARKS:

- 5785MHz: Fundamental frequency.
- 5725MHz & 5850MHz: Out of restricted band



A D T

EUT TEST CONDITION		MEASUREMENT DETAIL	
CHANNEL	Channel 165	FREQUENCY RANGE	30MHz ~ 40GHz
INPUT POWER (SYSTEM)	120Vac, 60 Hz	DETECTOR FUNCTION	Peak (PK) Average (AV)
ENVIRONMENTAL CONDITIONS	25deg. C, 65%RH	TESTED BY	Kay Wu

ANTENNA POLARITY & TEST DISTANCE: HORIZONTAL AT 3 M										
FREQ. (MHz)	EMISSION LEVEL (dBuV/m)	READ LEVEL (dBuV)	LIMIT (dBuV/m)	MARGIN (dB)	ANTENNA FACTOR (dB/m)	CABLE LOSS (dB)	PREAMP FACTOR (dB)	ANTENNA HEIGHT (cm)	TABLE ANGLE (Degree)	REMARK
5725	36.9	33.06	70.07	-33.17	32.36	6.62	35.14	115	236	Average
5725	48.37	44.53	80.73	-32.36	32.36	6.62	35.14	115	236	Peak
5825	90.07	86.01			32.51	6.7	35.15	115	236	Average
5825	100.73	96.67			32.51	6.7	35.15	115	236	Peak
5850	44.7	40.6	70.07	-25.37	32.53	6.7	35.13	115	236	Average
5850	64.38	60.28	80.73	-16.35	32.53	6.7	35.13	115	236	Peak
ANTENNA POLARITY & TEST DISTANCE: VERTICAL AT 3 M										
FREQ. (MHz)	EMISSION LEVEL (dBuV/m)	READ LEVEL (dBuV)	LIMIT (dBuV/m)	MARGIN (dB)	ANTENNA FACTOR (dB/m)	CABLE LOSS (dB)	PREAMP FACTOR (dB)	ANTENNA HEIGHT (cm)	TABLE ANGLE (Degree)	REMARK
5725	36.7	32.86	72.24	-35.54	32.36	6.62	35.14	100	139	Average
5725	48.22	44.38	83.24	-35.02	32.36	6.62	35.14	100	139	Peak
5825	92.24	88.18			32.51	6.7	35.15	100	139	Average
5825	103.24	99.18			32.51	6.7	35.15	100	139	Peak
5850	43.76	39.66	72.24	-28.48	32.53	6.7	35.13	100	139	Average
5850	63.96	59.86	83.24	-19.28	32.53	6.7	35.13	100	139	Peak

REMARKS:

- 5825MHz: Fundamental frequency.
- 5725MHz & 5850MHz: Out of restricted band



A D T

802.11n (40MHz)

EUT TEST CONDITION		MEASUREMENT DETAIL	
CHANNEL	Channel 151	FREQUENCY RANGE	30MHz ~ 40GHz
INPUT POWER (SYSTEM)	120Vac, 60 Hz	DETECTOR FUNCTION	Peak (PK) Average (AV)
ENVIRONMENTAL CONDITIONS	25deg. C, 65%RH	TESTED BY	Kay Wu

ANTENNA POLARITY & TEST DISTANCE: HORIZONTAL AT 3 M										
FREQ. (MHz)	EMISSION LEVEL (dBuV/m)	READ LEVEL (dBuV)	LIMIT (dBuV/m)	MARGIN (dB)	ANTENNA FACTOR (dB/m)	CABLE LOSS (dB)	PREAMP FACTOR (dB)	ANTENNA HEIGHT (cm)	TABLE ANGLE (Degree)	REMARK
81.3	25.27	47.7	40	-14.73	8.15	0.98	31.56			Peak
119.37	31.41	51.19	43.5	-12.09	10.93	1.18	31.89			Peak
170.67	32.96	51.58	43.5	-10.54	11.67	1.45	31.74	100	107	Peak
306.3	25.48	42.22	46	-20.52	13.1	2.07	31.91			Peak
507.9	21.61	32.89	46	-24.39	17.51	2.81	31.6			Peak
654.2	24.95	33.41	46	-21.05	20.27	3.26	31.99			Peak
5725	51.5	47.66	66.81	-15.31	32.36	6.62	35.14	100	158	Average
5725	64.7	60.86	78	-13.3	32.36	6.62	35.14	100	158	Peak
5755	86.81	82.91			32.41	6.64	35.15	100	167	Average
5755	98	94.1			32.41	6.64	35.15	100	167	Peak
5850	36.62	32.52	66.81	-30.19	32.53	6.7	35.13	100	167	Average
5850	48.04	43.94	78	-29.96	32.53	6.7	35.13	100	167	Peak
ANTENNA POLARITY & TEST DISTANCE: VERTICAL AT 3 M										
FREQ. (MHz)	EMISSION LEVEL (dBuV/m)	READ LEVEL (dBuV)	LIMIT (dBuV/m)	MARGIN (dB)	ANTENNA FACTOR (dB/m)	CABLE LOSS (dB)	PREAMP FACTOR (dB)	ANTENNA HEIGHT (cm)	TABLE ANGLE (Degree)	REMARK
30.54	34.11	52.52	40	-5.89	12.14	0.57	31.12	100	0	QP
35.67	33.82	51.32	40	-6.18	12.94	0.61	31.05	100	0	QP
171.48	34.45	53.18	43.5	-9.05	11.57	1.45	31.75			Peak
398.7	19.3	33.69	46	-26.7	15.31	2.42	32.12			Peak
581.4	24.19	34.11	46	-21.81	19.17	3.03	32.12			Peak
741	26.7	33.22	46	-19.3	21.39	3.55	31.46			Peak
5725	49.83	45.99	67.8	-17.97	32.36	6.62	35.14	110	221	Average
5725	65.51	61.67	79.16	-13.65	32.36	6.62	35.14	110	221	Peak
5755	87.8	83.9			32.41	6.64	35.15	110	242	Average
5755	99.16	95.26			32.41	6.64	35.15	110	242	Peak
5850	36.65	32.55	67.8	-31.15	32.53	6.7	35.13	110	242	Average
5850	48.78	44.68	79.16	-30.38	32.53	6.7	35.13	110	242	Peak

REMARKS:

- 5755MHz: Fundamental frequency.
- 5725MHz & 5850MHz: Out of restricted band



**A D T**

EUT TEST CONDITION		MEASUREMENT DETAIL	
CHANNEL	Channel 159	FREQUENCY RANGE	30MHz ~ 40GHz
INPUT POWER (SYSTEM)	120Vac, 60 Hz	DETECTOR FUNCTION	Peak (PK) Average (AV)
ENVIRONMENTAL CONDITIONS	25deg. C, 65%RH	TESTED BY	Kay Wu

ANTENNA POLARITY & TEST DISTANCE: HORIZONTAL AT 3 M										
FREQ. (MHz)	EMISSION LEVEL (dBuV/m)	READ LEVEL (dBuV)	LIMIT (dBuV/m)	MARGIN (dB)	ANTENNA FACTOR (dB/m)	CABLE LOSS (dB)	PREAMP FACTOR (dB)	ANTENNA HEIGHT (cm)	TABLE ANGLE (Degree)	REMARK
5725	36.08	32.24	66.21	-30.13	32.36	6.62	35.14	100	129	Average
5725	52.75	48.91	76.71	-23.96	32.36	6.62	35.14	100	129	Peak
5795	86.21	82.23			32.46	6.7	35.18	100	129	Average
5795	96.71	92.73			32.46	6.7	35.18	100	129	Peak
5850	42.56	38.46	66.21	-23.65	32.53	6.7	35.13	100	129	Average
5850	54.07	49.97	76.71	-22.64	32.53	6.7	35.13	100	129	Peak
ANTENNA POLARITY & TEST DISTANCE: VERTICAL AT 3 M										
FREQ. (MHz)	EMISSION LEVEL (dBuV/m)	READ LEVEL (dBuV)	LIMIT (dBuV/m)	MARGIN (dB)	ANTENNA FACTOR (dB/m)	CABLE LOSS (dB)	PREAMP FACTOR (dB)	ANTENNA HEIGHT (cm)	TABLE ANGLE (Degree)	REMARK
5725	38.08	34.24	68.61	-30.53	32.36	6.62	35.14	110	259	Average
5725	50.66	46.82	79.18	-28.52	32.36	6.62	35.14	110	259	Peak
5795	88.61	84.63			32.46	6.7	35.18	110	259	Average
5795	99.18	95.2			32.46	6.7	35.18	110	259	Peak
5850	45.47	41.37	68.61	-23.14	32.53	6.7	35.13	110	259	Average
5850	55.21	51.11	79.18	-23.97	32.53	6.7	35.13	110	259	Peak

**REMARKS:**

- 5795MHz: Fundamental frequency.
- 5725MHz & 5850MHz: Out of restricted band

## 5.2 CONDUCTED EMISSION MEASUREMENT

### 5.2.1 LIMITS OF CONDUCTED EMISSION MEASUREMENT

FREQUENCY OF EMISSION (MHz)	CONDUCTED LIMIT (dB $\mu$ V)	
	Quasi-peak	Average
0.15 ~ 0.5	66 to 56	56 to 46
0.5 ~ 5	56	46
5 ~ 30	60	50

- NOTE:** 1. The lower limit shall apply at the transition frequencies.  
2. The limit decreases in line with the logarithm of the frequency in the range of 0.15 to 0.50MHz.  
3. All emanations from a class A/B digital device or system, including any network of conductors and apparatus connected thereto, shall not exceed the level of field strengths specified above.

### 5.2.2 TEST INSTRUMENTS

Same as 4.2.2.

### 5.2.3 TEST PROCEDURES

Same as 4.2.3.

### 5.2.4 DEVIATION FROM TEST STANDARD

No deviation.

### 5.2.5 TEST SETUP

Same as 4.2.5.

### 5.2.6 EUT OPERATING CONDITIONS

Same as 4.1.6

### 5.2.7 TEST RESULTS

**CONDUCTED WORST-CASE DATA : 802.11n (40MHz)**

<b>PHASE</b>	Line 1	<b>6dB BANDWIDTH</b>	9kHz
--------------	--------	----------------------	------

No	Freq. [MHz]	Corr. Factor (dB)	Reading Value		Emission Level		Limit		Margin	
			[dB (uV)]		[dB (uV)]		[dB (uV)]		(dB)	
			Q.P.	AV.	Q.P.	AV.	Q.P.	AV.	Q.P.	AV.
1	0.18125	0.15	57.23	40.83	57.38	40.98	64.43	54.43	-7.05	-13.45
2	0.27109	0.16	45.93	25.69	46.09	25.85	61.08	51.08	-15.00	-25.24
3	0.71250	0.18	42.02	26.69	42.20	26.87	56.00	46.00	-13.80	-19.13
4	0.84922	0.18	43.62	25.65	43.80	25.83	56.00	46.00	-12.20	-20.17
5	4.16406	0.34	39.40	27.23	39.74	27.57	56.00	46.00	-16.26	-18.43
6	4.73047	0.35	40.52	26.36	40.87	26.71	56.00	46.00	-15.13	-19.29
7	7.68750	0.40	40.49	33.84	40.89	34.24	60.00	50.00	-19.11	-15.76

- REMARKS:**
1. Q.P. and AV. are abbreviations of quasi-peak and average individually.
  2. The emission levels of other frequencies were very low against the limit.
  3. Margin value = Emission level - Limit value
  4. Correction factor = Insertion loss + Cable loss
  5. Emission Level = Correction Factor + Reading Value.

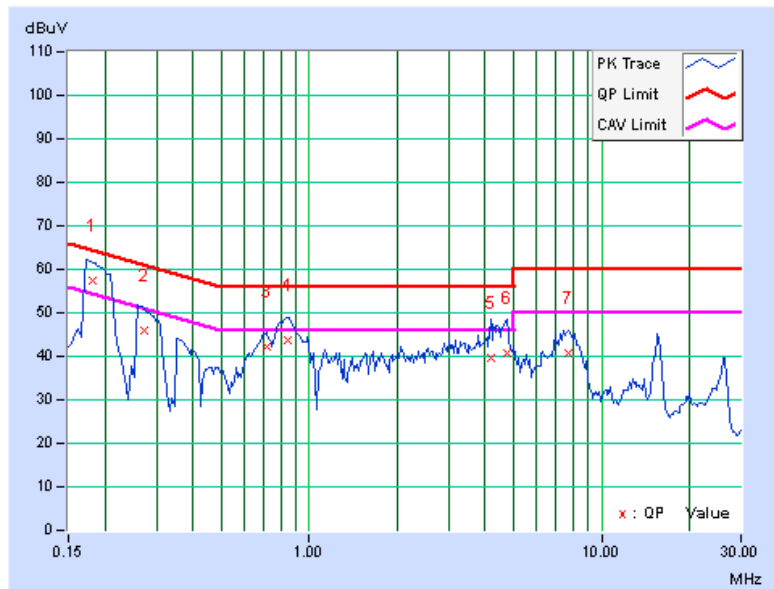

PHASE	Line 2	6dB BANDWIDTH	9kHz
-------	--------	---------------	------

No	Freq. [MHz]	Corr. Factor (dB)	Reading Value		Emission Level		Limit		Margin	
			[dB (uV)]		[dB (uV)]		[dB (uV)]		(dB)	
			Q.P.	AV.	Q.P.	AV.	Q.P.	AV.	Q.P.	AV.
1	0.18516	0.14	56.57	41.53	56.71	41.67	64.25	54.25	-7.54	-12.58
2	0.27500	0.15	45.59	28.01	45.74	28.16	60.97	50.97	-15.23	-22.81
3	0.72031	0.18	42.78	28.02	42.96	28.20	56.00	46.00	-13.04	-17.80
4	0.83750	0.18	44.73	29.96	44.91	30.14	56.00	46.00	-11.09	-15.86
5	0.98203	0.19	41.02	24.67	41.21	24.86	56.00	46.00	-14.79	-21.14
6	1.52734	0.23	39.98	24.87	40.21	25.10	56.00	46.00	-15.79	-20.90
7	2.08984	0.26	38.80	25.43	39.06	25.69	56.00	46.00	-16.94	-20.31
8	4.26563	0.36	40.50	28.19	40.86	28.55	56.00	46.00	-15.14	-17.45
9	4.69531	0.37	41.68	27.25	42.05	27.62	56.00	46.00	-13.95	-18.38
10	7.69922	0.43	41.50	34.88	41.93	35.31	60.00	50.00	-18.07	-14.69

- REMARKS:**
1. Q.P. and AV. are abbreviations of quasi-peak and average individually.
  2. The emission levels of other frequencies were very low against the limit.
  3. Margin value = Emission level - Limit value
  4. Correction factor = Insertion loss + Cable loss
  5. Emission Level = Correction Factor + Reading Value.

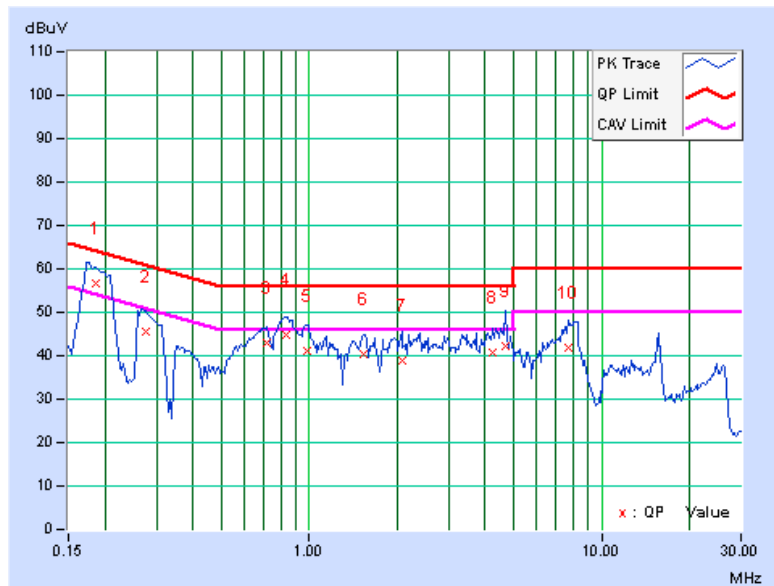



A D T

### **5.3 6dB BANDWIDTH MEASUREMENT**

#### **5.3.1 LIMITS OF 6dB BANDWIDTH MEASUREMENT**

The minimum of 6dB Bandwidth Measurement is 0.5MHz.

#### **5.3.2 TEST SETUP**

Same as item 4.3.2.

#### **5.3.3 TEST INSTRUMENTS**

Refer to section 4.1.2 to get information of above instrument.

#### **5.3.4 TEST PROCEDURE**

Same as item 4.3.4.

#### **5.3.5 DEVIATION FROM TEST STANDARD**

No deviation.

#### **5.3.6 EUT OPERATING CONDITIONS**

Same as item 4.3.6.



A D T

### 5.3.7 TEST RESULTS

#### 802.11a

CHANNEL	CHANNEL FREQUENCY (MHz)	6dB BANDWIDTH (MHz)	MINIMUM LIMIT (MHz)	PASS / FAIL
149	5745	16.52	0.5	PASS
157	5785	16.52	0.5	PASS
165	5825	16.50	0.5	PASS

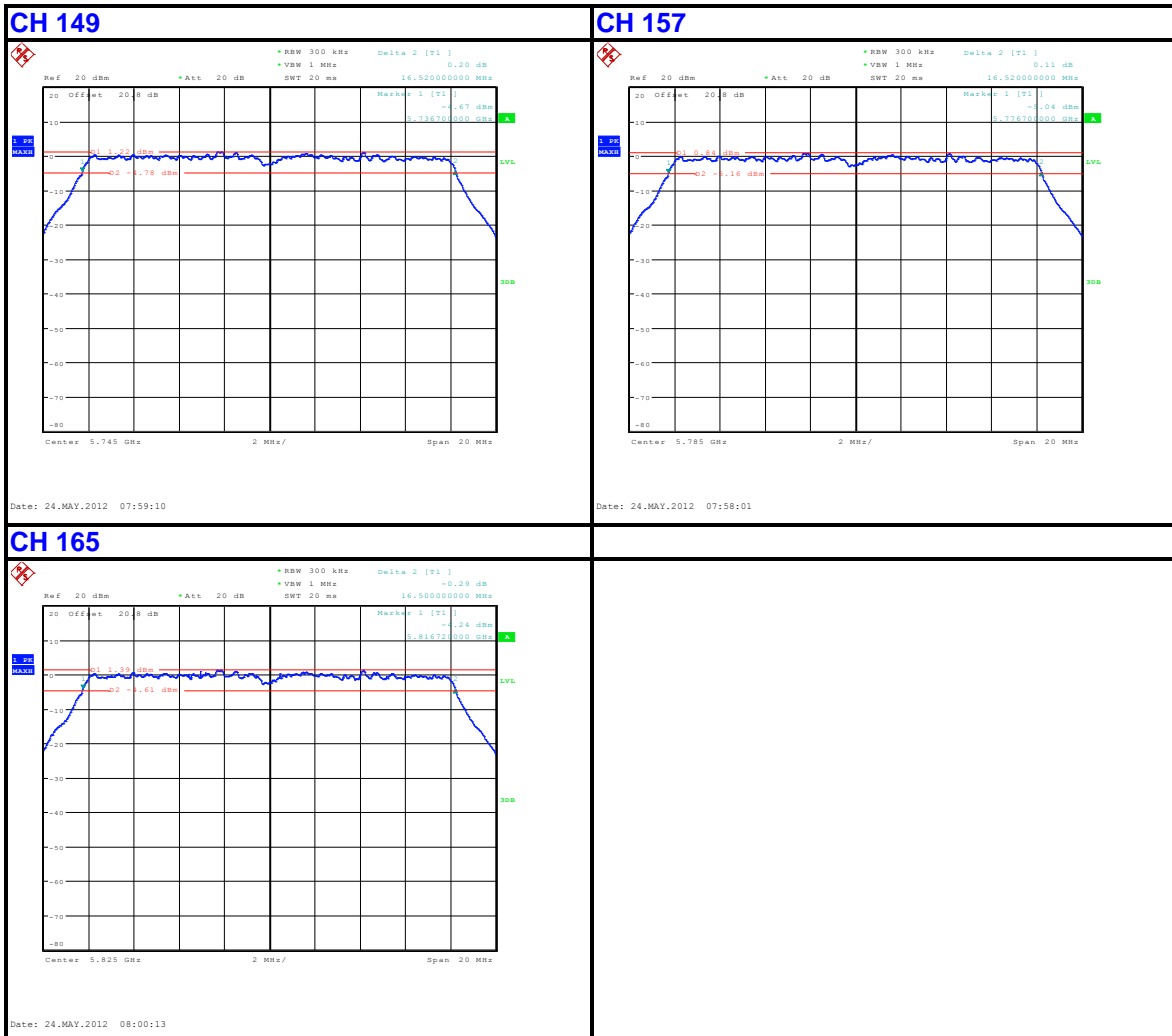



A D T

802.11n (20MHz)

CHANNEL	CHANNEL FREQUENCY (MHz)	6dB BANDWIDTH (MHz)	MINIMUM LIMIT (MHz)	PASS / FAIL
149	5745	17.80	0.5	PASS
157	5785	17.78	0.5	PASS
165	5825	17.80	0.5	PASS

CH 149

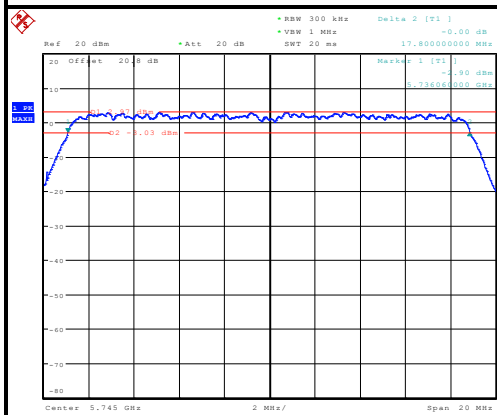

Date: 24.MAY.2012 08:10:26

CH 157

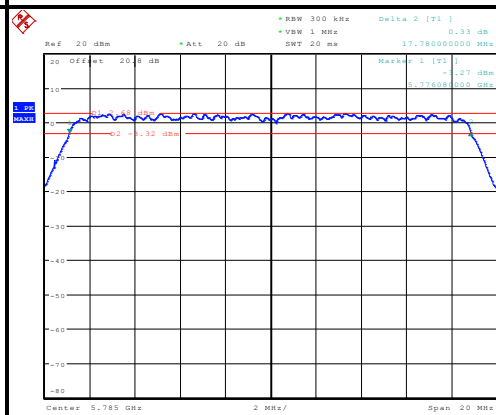

Date: 24.MAY.2012 08:16:33

CH 165

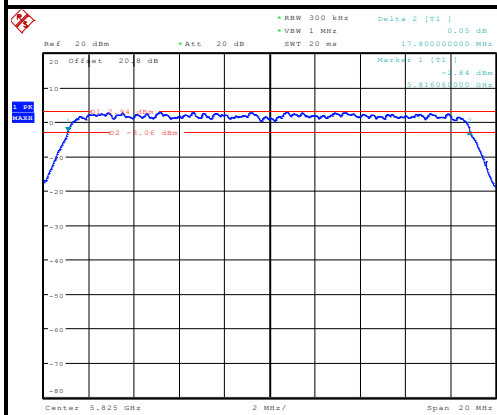

Date: 24.MAY.2012 08:25:27



A D T

802.11n (40MHz)

CHANNEL	CHANNEL FREQUENCY (MHz)	6dB BANDWIDTH (MHz)	MINIMUM LIMIT (MHz)	PASS / FAIL
151	5755	36.52	0.5	PASS
159	5795	36.52	0.5	PASS

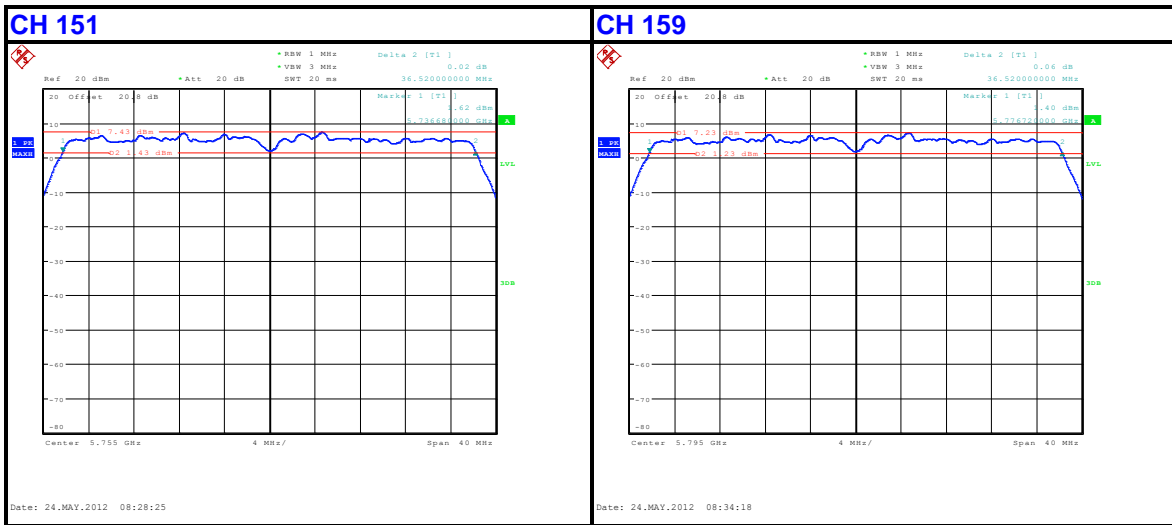



## **5.4 MAXIMUM OUTPUT POWER**

### **5.4.1 LIMITS OF MAXIMUM OUTPUT POWER MEASUREMENT**

For systems using digital modulation in the 5725 –5850 MHz bands: 1 Watt (30dBm)

### **5.4.2 TEST SETUP**

Same as Item 4.4.2.

### **5.4.3 INSTRUMENTS**

Refer to section 4.1.2 to get information of above instrument.

### **5.4.4 TEST PROCEDURES**

Same as Item 4.4.4.

### **5.4.5 DEVIATION FROM TEST STANDARD**

No deviation.

### **5.4.6 EUT OPERATING CONDITIONS**

Same as Item 4.3.6.



## 5.4.7 TEST RESULTS

### 802.11a

CHANNEL	FREQUENCY (MHz)	PEAK POWER (mW)	PEAK POWER (dBm)	LIMIT (dBm)	PASS/FAIL
149	5745	81.283	19.10	30	PASS
157	5785	75.683	18.79	30	PASS
165	5825	79.616	19.01	30	PASS

### 802.11n (20MHz)

CHANNEL	FREQUENCY (MHz)	PEAK POWER (mW)	PEAK POWER (dBm)	LIMIT (dBm)	PASS/FAIL
149	5745	119.674	20.78	30	PASS
157	5785	108.643	20.36	30	PASS
165	5825	111.686	20.48	30	PASS

### 802.11n (40MHz)

CHANNEL	FREQUENCY (MHz)	PEAK POWER (mW)	PEAK POWER (dBm)	LIMIT (dBm)	PASS/FAIL
151	5755	137.721	21.39	30	PASS
159	5795	129.122	21.11	30	PASS



A D T

## **5.5 POWER SPECTRAL DENSITY MEASUREMENT**

### **5.5.1 LIMITS OF POWER SPECTRAL DENSITY MEASUREMENT**

The Maximum of Power Spectral Density Measurement is 8dBm.

### **5.5.2 TEST SETUP**

Same as item 4.5.2.

### **5.5.3 TEST INSTRUMENTS**

Refer to section 4.1.2 to get information of above instrument.

### **5.5.4 TEST PROCEDURE.**

Same as item 4.5.4.

### **5.5.5 DEVIATION FROM TEST STANDARD**

No deviation.

### **5.5.6 EUT OPERATING CONDITION**

Same as Item 5.3.6.



A D T

### 5.5.7 TEST RESULTS

#### 802.11a

Channel	FREQ. (MHz)	PSD (dBm/100kHz)	PSD (dBm/3kHz)	Limit (dBm/3kHz)	PASS /FAIL
149	5745	-3.16	-18.36	8	PASS
157	5785	-3.93	-19.13	8	PASS
165	5825	-3.09	-18.29	8	PASS

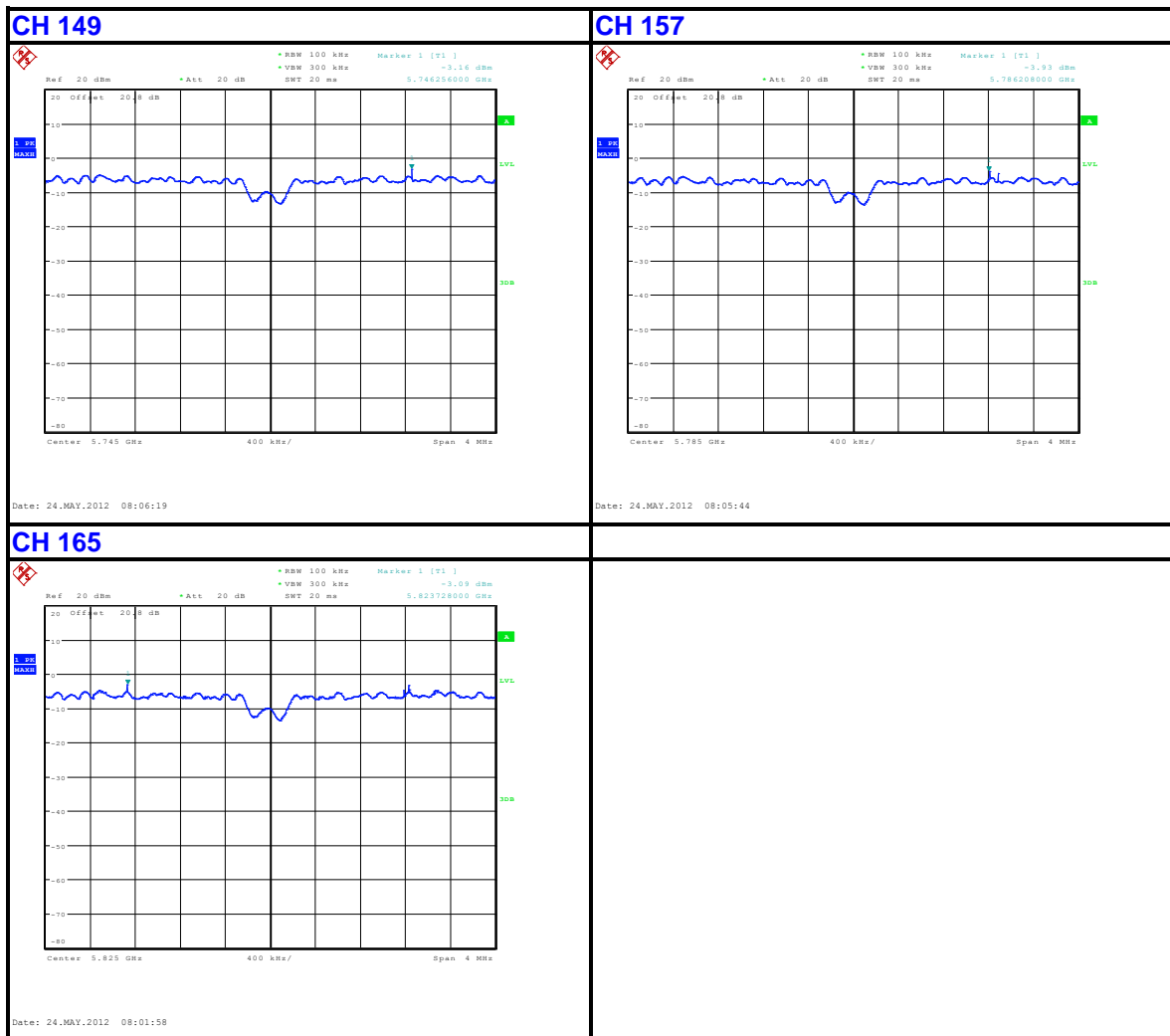



A D T

802.11n (20MHz)

Channel	FREQ. (MHz)	PSD (dBm/100kHz)	PSD (dBm/3kHz)	Limit (dBm/3kHz)	PASS /FAIL
149	5745	-0.65	-15.85	8	PASS
157	5785	-2.95	-18.15	8	PASS
165	5825	-0.47	-15.67	8	PASS

CH 149

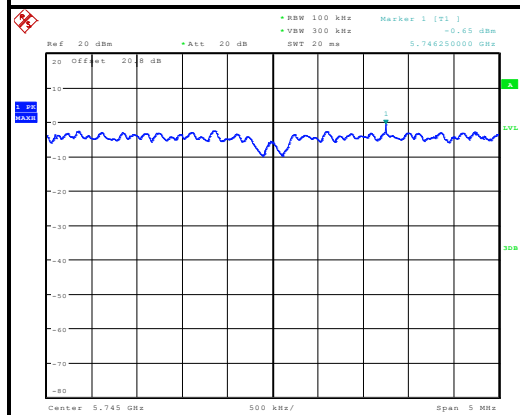

Date: 24\_MAY\_2012 08:13:52

CH 157

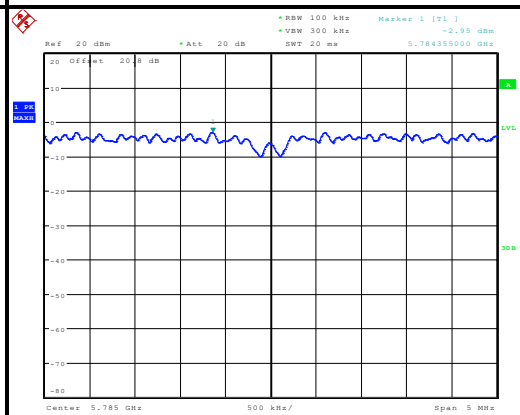

Date: 24\_MAY\_2012 08:14:58

CH 165

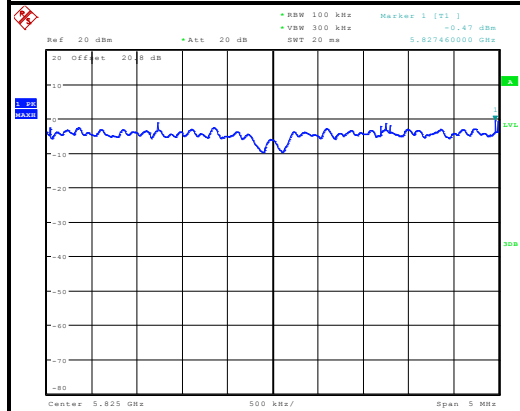

Date: 24\_MAY\_2012 08:22:15



A D T

### 802.11n (40MHz)

Channel	FREQ. (MHz)	PSD (dBm/100kHz)	PSD (dBm/3kHz)	Limit (dBm/3kHz)	PASS /FAIL
151	5755	-2.87	-18.07	8	PASS
159	5795	-3.97	-19.17	8	PASS

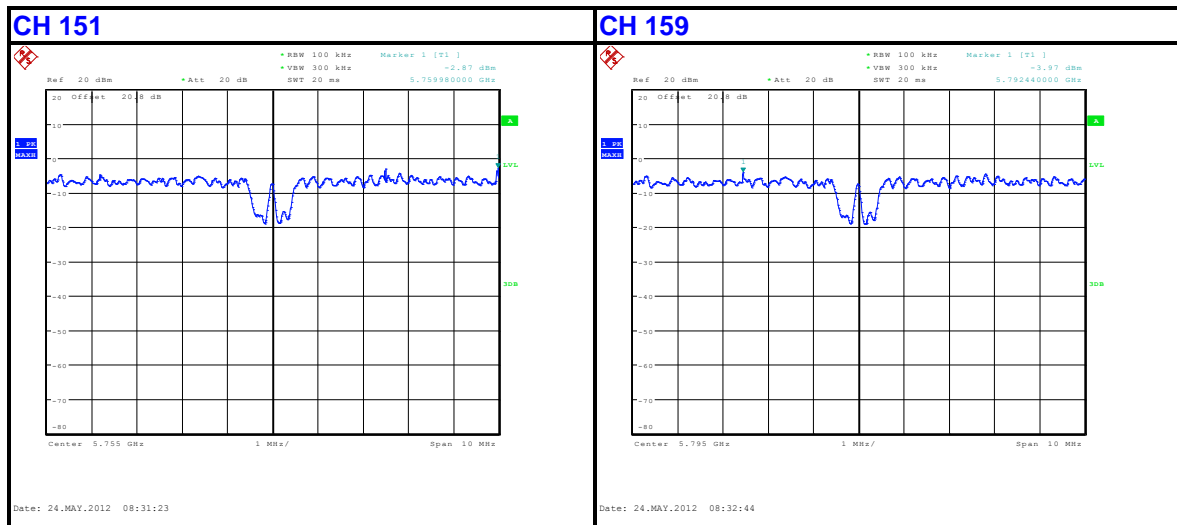



## **5.6 BAND EDGES MEASUREMENT**

### **5.6.1 LIMITS OF OUT OF BAND EMISSION MEASUREMENT**

Below  $-20\text{dB}$  of the highest emission level of operating band (in 100kHz Resolution Bandwidth).

### **5.6.2 TEST SETUP**

Same as Item 4.6.2

### **5.6.3 TEST INSTRUMENTS**

Refer to section 4.1.2 to get information of above instrument.

### **5.6.4 TEST PROCEDURE**

Same as Item 4.6.4

### **5.6.5 DEVIATION FROM TEST STANDARD**

No deviation.

### **5.6.6 EUT OPERATING CONDITION**

Same as Item 5.3.6

### **5.6.7 TEST RESULTS**

The spectrum plots are attached on the following pages. D1 line indicates the highest level, and D2 line indicates the 20dB offset below D1. It shows compliance with the requirement in part 15.247(d).



A D T

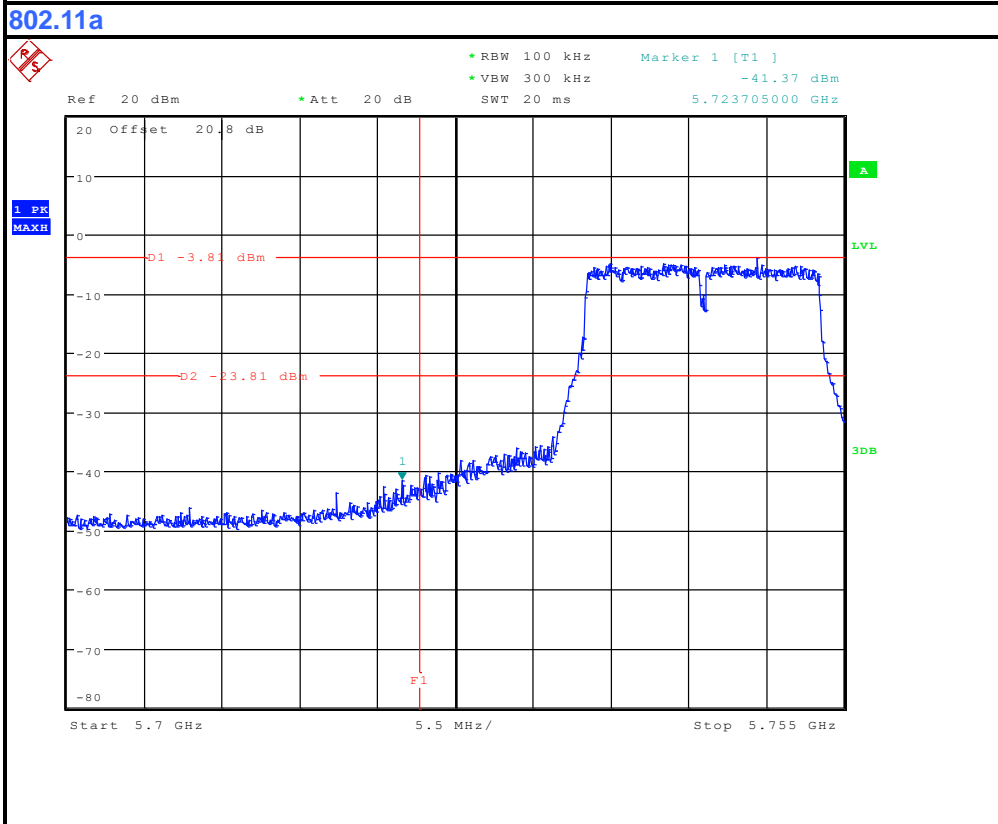

Date: 24.MAY.2012 07:52:01

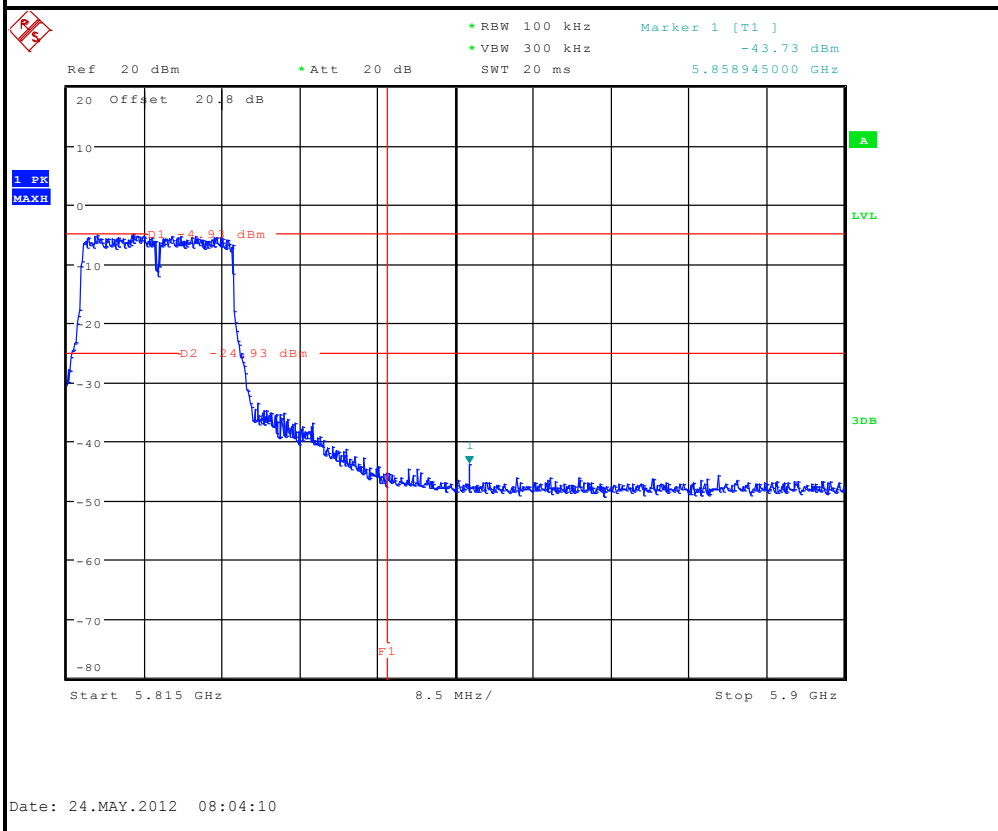

Date: 24.MAY.2012 08:04:10



A D T

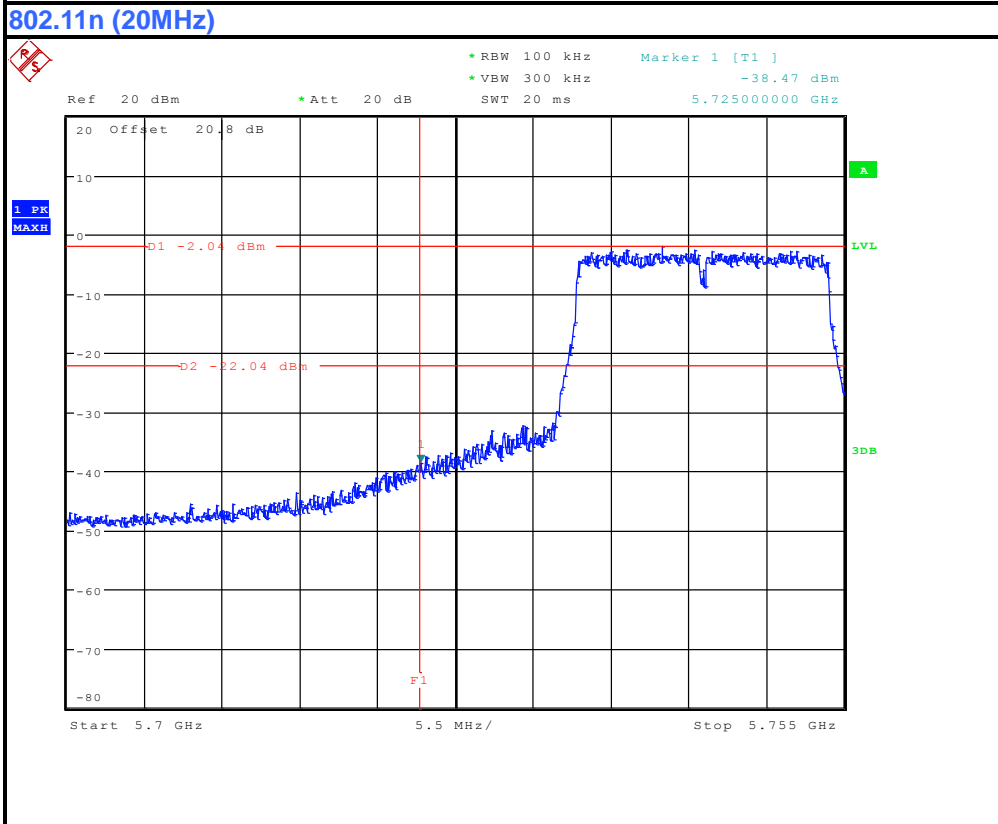

Date: 24.MAY.2012 08:11:52

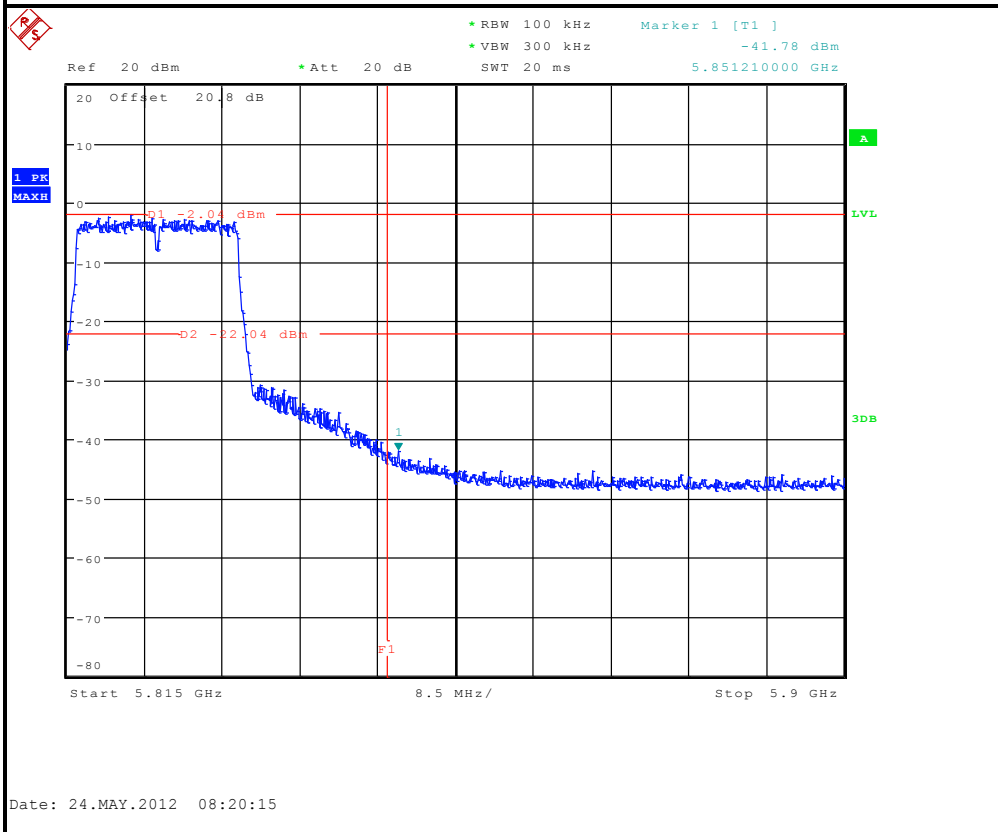

Date: 24.MAY.2012 08:20:15



A D T

### 802.11n (40MHz)

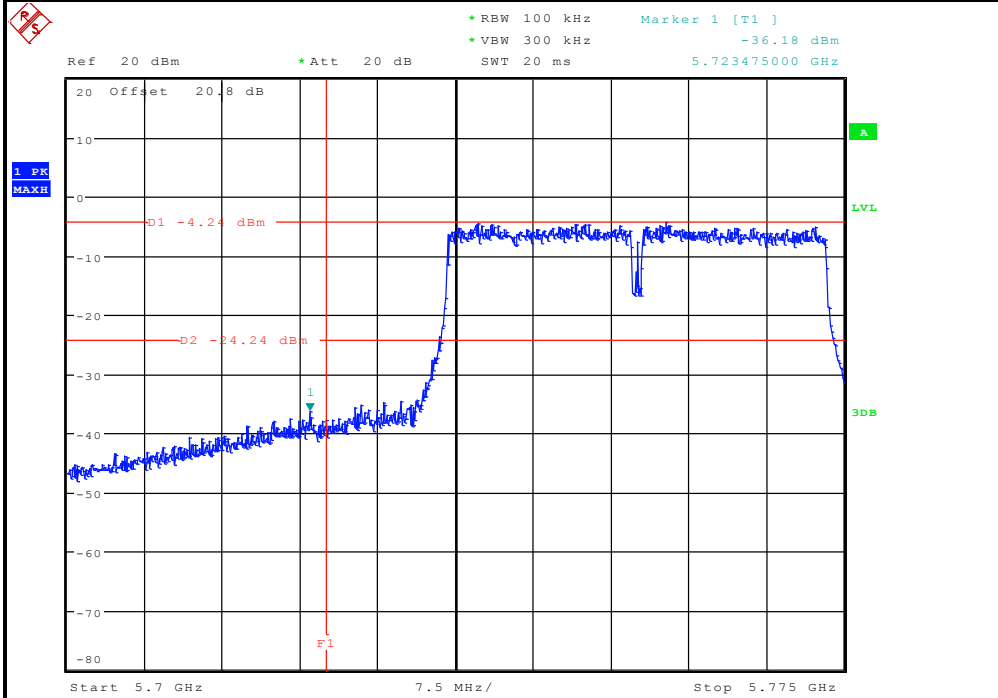

Date: 24.MAY.2012 08:29:42

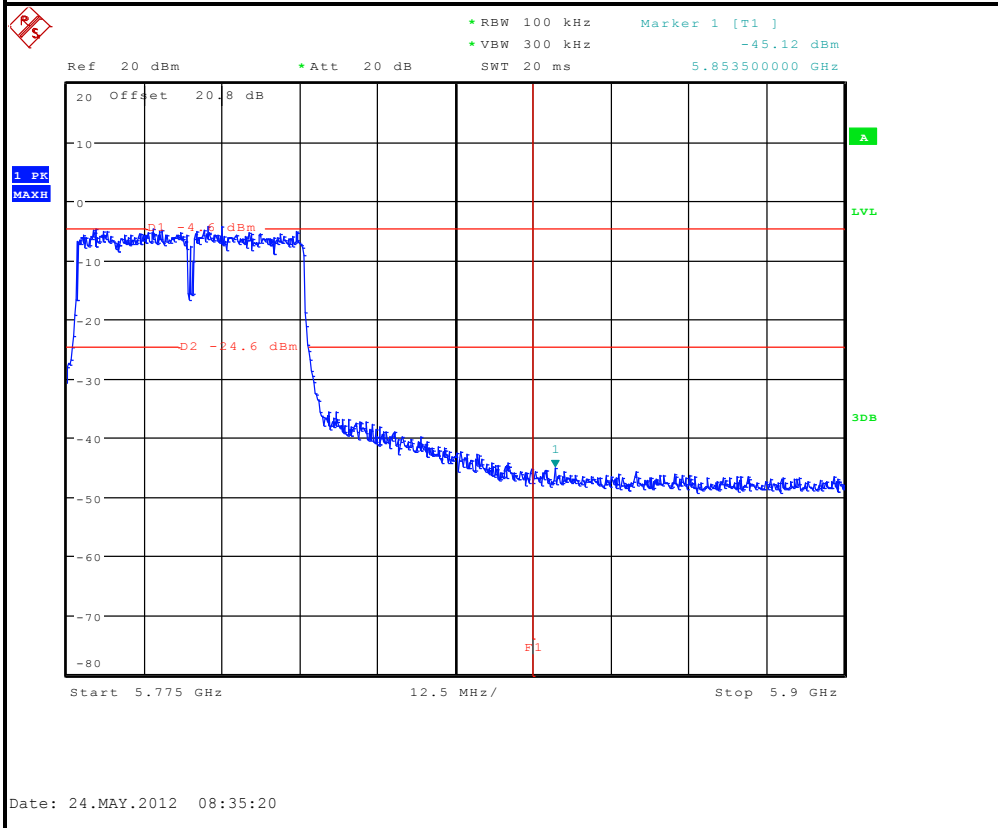

Date: 24.MAY.2012 08:35:20



A D T

## 6. PHOTOGRAPHS OF THE TEST CONFIGURATION

Please refer to the attached file (Test Setup Photo).



A D T

## 7. INFORMATION ON THE TESTING LABORATORIES

We, Bureau Veritas Consumer Products Services (H.K.) Ltd., Taoyuan Branch, were founded in 1988 to provide our best service in EMC, Radio, Telecom and Safety consultation. Our laboratories are accredited and approved according to ISO/IEC 17025.

If you have any comments, please feel free to contact us at the following:

**Linko EMC/RF Lab**

Tel: 886-2-26052180

Fax: 886-2-26051924

**Hsin Chu EMC/RF Lab**

Tel: 886-3-5935343

Fax: 886-3-5935342

**Hwa Ya EMC/RF/Safety/Telecom Lab**

Tel: 886-3-3183232

Fax: 886-3-3270892

**Email:** [service.adt@tw.bureauveritas.com](mailto:service.adt@tw.bureauveritas.com)

**Web Site:** [www.adt.com.tw](http://www.adt.com.tw)

The address and road map of all our labs can be found in our web site also.



A D T

## 8. APPENDIX A - MODIFICATIONS RECORDERS FOR ENGINEERING CHANGES TO THE EUT BY THE LAB

No modifications were made to the EUT by the lab during the test.

---END---