



FCC TEST REPORT (15.407)

REPORT NO.: RF120309C18-5

MODEL NO.: FZ-A1BDAAVAM

FCC ID: ACJ9TGFZ-A12

RECEIVED: Dec. 21, 2011

TESTED: Feb. 22 ~ Mar. 15, 2012 and
May 24, 2012

ISSUED: May 25, 2012

APPLICANT: Panasonic Corporation of North America

ADDRESS: One Panasonic Way, 4B-8 Secaucus, NJ 07094

ISSUED BY: Bureau Veritas Consumer Products Services
(H.K.) Ltd., Taoyuan Branch

LAB ADDRESS: No. 47, 14th Ling, Chia Pau Vil., Lin Kou Dist.,
New Taipei City, Taiwan (R.O.C)

TEST LOCATION: No. 19, Hwa Ya 2nd Rd, Wen Hwa Tsuen, Kwei
Shan Hsiang, Taoyuan Hsien 333, Taiwan,
R.O.C.

This report should not be used by the client to claim product certification, approval, or endorsement by TAF or any government agencies.



This report is for your exclusive use. Any copying or replication of this report to or for any other person or entity, or use of our name or trademark, is permitted only with our prior written permission. This report sets forth our findings solely with respect to the test samples identified herein. The results set forth in this report are not indicative or representative of the quality or characteristics of the lot from which a test sample was taken or any similar or identical product unless specifically and expressly noted. Our report includes all of the tests requested by you and the results thereof based upon the information that you provided to us. You have 60 days from date of issuance of this report to notify us of any material error or omission caused by our negligence, provided, however, that such notice shall be in writing and shall specifically address the issue you wish to raise. A failure to raise such issue within the prescribed time shall constitute your unqualified acceptance of the completeness of this report, the tests conducted and the correctness of the report contents. Unless specific mention, the uncertainty of measurement has been explicitly taken into account to declare the compliance or non-compliance to the specification

TABLE OF CONTENTS

RELEASE CONTROL RECORD	4
1. CERTIFICATION.....	5
2. SUMMARY OF TEST RESULTS.....	6
2.1 MEASUREMENT UNCERTAINTY	6
3. GENERAL INFORMATION	7
3.1 GENERAL DESCRIPTION OF EUT.....	7
3.2 DESCRIPTION OF TEST MODES.....	8
3.2.1 CONFIGURATION OF SYSTEM UNDER TEST	8
3.2.2 TEST MODE APPLICABILITY AND TESTED CHANNEL DETAIL.....	9
3.3 GENERAL DESCRIPTION OF APPLIED STANDARDS	12
3.4 DESCRIPTION OF SUPPORT UNITS.....	12
4. TEST TYPES AND RESULTS.....	13
4.1 RADIATED EMISSION AND BANDEDGE MEASUREMENT	13
4.1.1 LIMITS OF RADIATED EMISSION AND BANDEDGE MEASUREMENT	13
4.1.2 LIMITS OF UNWANTED EMISSION OUT OF THE RESTRICTED BANDS.....	13
4.1.3 TEST INSTRUMENTS.....	14
4.1.4 TEST PROCEDURES	15
4.1.5 DEVIATION FROM TEST STANDARD	15
4.1.6 TEST SETUP.....	16
4.1.7 EUT OPERATING CONDITION.....	16
4.1.8 TEST RESULTS	17
4.2 CONDUCTED EMISSION MEASUREMENT	42
4.2.1 LIMITS OF CONDUCTED EMISSION MEASUREMENT	42
4.2.2 TEST INSTRUMENTS.....	42
4.2.3 TEST PROCEDURES	43
4.2.4 DEVIATION FROM TEST STANDARD	43
4.2.5 TEST SETUP.....	44
4.2.6 EUT OPERATING CONDITIONS.....	44
4.2.7 TEST RESULTS	45
4.3 MAXIMUM CONDUCTED OUTPUT POWER MEASUREMENT.....	47
4.3.1 LIMITS OF MAXIMUM CONDUCTED OUTPUT POWER MEASUREMENT	47
4.3.2 TEST SETUP.....	47
4.3.3 TEST INSTRUMENTS.....	47



4.3.4	TEST PROCEDURE	48
4.3.5	DEVIATION FROM TEST STANDARD	48
4.3.6	EUT OPERATING CONDITIONS.....	48
4.3.7	TEST RESULTS	49
4.4	PEAK POWER EXCURSION MEASUREMENT	53
4.4.1	LIMITS OF PEAK POWER EXCURSION MEASUREMENT	53
4.4.2	TEST SETUP.....	53
4.4.3	TEST INSTRUMENTS.....	53
4.4.4	TEST PROCEDURE.....	53
4.4.5	DEVIATION FROM TEST STANDARD	53
4.4.6	EUT OPERATING CONDITIONS.....	53
4.4.7	TEST RESULTS	54
4.5	PEAK POWER SPECTRAL DENSITY MEASUREMENT	60
4.5.1	LIMITS OF PEAK POWER SPECTRAL DENSITY MEASUREMENT	60
4.5.2	TEST SETUP.....	60
4.5.3	TEST INSTRUMENTS.....	60
4.5.4	TEST PROCEDURES	60
4.5.5	DEVIATION FROM TEST STANDARD	60
4.5.6	EUT OPERATING CONDITIONS.....	61
4.5.7	TEST RESULTS	62
4.6	FREQUENCY STABILITY.....	64
4.6.1	LIMITS OF FREQUENCY STABILITY MEASUREMENT	64
4.6.2	TEST SETUP.....	64
4.6.3	TEST INSTRUMENTS.....	64
4.6.4	TEST PROCEDURE.....	65
4.6.5	DEVIATION FROM TEST STANDARD	65
4.6.6	EUT OPERATING CONDITION.....	65
4.6.7	TEST RESULTS	66
5.	PHOTOGRAPHS OF THE TEST CONFIGURATION	68
6.	INFORMATION ON THE TESTING LABORATORIES	69
7.	APPENDIX A - MODIFICATIONS RECORDERS FOR ENGINEERING CHANGES TO THE EUT BY THE LAB	70



A D T

RELEASE CONTROL RECORD

ISSUE NO.	REASON FOR CHANGE	DATE ISSUED
RF120309C18-5	Original release	May 25, 2012



1. CERTIFICATION

PRODUCT: Tablet PC

MODEL: FZ-A1BDAAVAM

BRAND: Panasonic

APPLICANT: Panasonic Corporation of North America

TESTED: Feb. 22 ~ Mar. 15, 2012 and May 24, 2012

TEST SAMPLE: Engineering Sample

STANDARDS: FCC Part 15, Subpart E (Section 15.407)

ANSI C63.10-2009

The above equipment (Model: FZ-A1BDAAVAM) has been tested by **Bureau Veritas Consumer Products Services (H.K.) Ltd., Taoyuan Branch**, and found compliance with the requirement of the above standards. The test record, data evaluation & Equipment Under Test (EUT) configurations represented herein are true and accurate accounts of the measurements of the sample's EMC characteristics under the conditions specified in this report.

PREPARED BY : Ivonne Wu , **DATE:** May 25, 2012
Ivonne Wu / Senior Specialist

APPROVED BY : Gary Chang , **DATE:** May 25, 2012
Gary Chang / Technical Manager

2. SUMMARY OF TEST RESULTS

The EUT has been tested according to the following specifications:

APPLIED STANDARD: FCC PART 15, SUBPART E (SECTION 15.407)			
STANDARD SECTION	TEST TYPE AND LIMIT	RESULT	REMARK
15.407(b)(5)	AC Power Conducted Emission	PASS	Meet the requirement of limit. Minimum passing margin is -7.51dB at 0.18516MHz.
15.407(b)(1/2/3)(b)(5)	Electric Field Strength Spurious Emissions, 30MHz ~ 40000MHz	PASS	Meet the requirement of limit. Minimum passing margin is -4.81dB at 35.67MHz.
15.407(a)(1/2/3)	Peak Transmit Power	PASS	Meet the requirement of limit.
15.407(a)(6)	Peak Power Excursion	PASS	Meet the requirement of limit.
15.407(a)(1/2/3)	Peak Power Spectral Density	PASS	Meet the requirement of limit.
15.407(g)	Frequency Stability	PASS	Meet the requirement of limit.
15.203	Antenna Requirement	PASS	No antenna connector is used.

2.1 MEASUREMENT UNCERTAINTY

Where relevant, the following measurement uncertainty levels have been estimated for tests performed on the EUT as specified in CISPR 16-4-2:

MEASUREMENT	FREQUENCY	UNCERTAINTY
Conducted emissions	150kHz~30MHz	2.44 dB
Radiated emissions	30MHz ~ 200MHz	2.93 dB
	200MHz ~1000MHz	2.95 dB
	1GHz ~ 18GHz	2.26 dB
	18GHz ~ 40GHz	1.94 dB

This uncertainty represents an expanded uncertainty expressed at approximately the 95% confidence level using a coverage factor of $k = 2$.



3. GENERAL INFORMATION

3.1 GENERAL DESCRIPTION OF EUT

EUT	Tablet PC
MODEL NO.	FZ-A1BDAAVAM
POWER SUPPLY	12Vdc (adapter) 7.4Vdc (battery)
MODULATION TYPE	64QAM, 16QAM, QPSK, BPSK
MODULATION TECHNOLOGY	OFDM
TRANSFER RATE	802.11a: 54.0/ 48.0/ 36.0/ 24.0/ 18.0/ 12.0/ 9.0/ 6.0Mbps 802.11n: up to 150.0Mbps
OPERATING FREQUENCY	5180 ~ 5320MHz & 5500 ~ 5700MHz
NUMBER OF CHANNEL	5180 ~ 5320MHz: 8 for 802.11a, 802.11n (20MHz) 4 for 802.11n (40MHz) 5500 ~ 5700MHz: 11 for 802.11a, 802.11n (20MHz) 5 for 802.11n (40MHz)
OUTPUT POWER	18.967mW for 5180 ~ 5240MHz 15.417mW for 5260 ~ 5320MHz 21.777mW for 5500 ~ 5700MHz
ANTENNA TYPE	PIFA antenna with 1.99dBi gain
ANTENNA CONNECTOR	NA
DATA CABLE	NA
I/O PORTS	Refer to user's manual
ACCESSORY DEVICES	Refer to Note as below

NOTE:

1. The EUT contains following accessory devices.

ITEM	BRAND	MODEL	SPECIFICATION
Adapter	JRC	NJD-9370	Input: 100-240Vac, 50/60Hz , 0.5A~0.3A Output: 12Vdc, 2A Power line: 0.7m non-shielded cable without core
Battery	SANYO	2UF484462-3-T0775	Rating: 7.4Vdc Type: Li-ion
LCD Panel	Hannstar	HSD100PXN1	--
Main Camera	D-Max Technology	HAC-001502-W1A	--
2 nd Camera	D-Max Technology	HAC-002103-W1A	--

2. The above EUT information is declared by the manufacturer and for more detailed features description, please refer to the manufacturer's specifications or User's Manual.



3.2 DESCRIPTION OF TEST MODES

FOR 5180 ~ 5320MHz

8 channels are provided for 802.11a, 802.11n (20MHz):

CHANNEL	FREQUENCY	CHANNEL	FREQUENCY
36	5180 MHz	52	5260 MHz
40	5200 MHz	56	5280 MHz
44	5220 MHz	60	5300 MHz
48	5240 MHz	64	5320 MHz

4 channels are provided for 802.11n (40MHz):

CHANNEL	FREQUENCY	CHANNEL	FREQUENCY
38	5190 MHz	54	5270 MHz
46	5230 MHz	62	5310 MHz

FOR 5500 ~ 5700MHz

11 channels are provided for 802.11a, 802.11n (20MHz):

CHANNEL	FREQUENCY	CHANNEL	FREQUENCY
100	5500 MHz	124	5620 MHz
104	5520 MHz	128	5640 MHz
108	5540 MHz	132	5660 MHz
112	5560 MHz	136	5680 MHz
116	5580 MHz	140	5700 MHz
120	5600 MHz		

5 channels are provided for 802.11n (40MHz):

CHANNEL	FREQUENCY	CHANNEL	FREQUENCY
102	5510 MHz	126	5630 MHz
110	5550 MHz	134	5670 MHz
118	5590 MHz		

3.2.1 TEST MODE APPLICABILITY AND TESTED CHANNEL DETAIL

EUT CONFIGURE MODE	APPLICABLE TO			DESCRIPTION
	RE	PLC	APCM	
-	√	√	√	-

Where **RE**: Radiated Emission **PLC**: Power Line Conducted Emission
APCM: Antenna Port Conducted Measurement

NOTE:

The EUT had been pre-tested on the positioned of each 3 axis. The worst case was found when positioned on **X-plane**.

RADIATED EMISSION TEST:

- Pre-Scan has been conducted to determine the worst-case mode from all possible combinations between available modulations, data rates and antenna ports (if EUT with antenna diversity architecture).
- Following channel(s) was (were) selected for the final test as listed below.

MODE	FREQ. BAND (MHz)	AVAILABLE CHANNEL	TESTED CHANNEL	MODULATION TECHNOLOGY	MODULATION TYPE	DATA RATE (Mbps)
802.11a	5180-5320	36 to 64	36, 44, 48, 52, 60, 64	OFDM	BPSK	6.0
802.11n (20MHz)		36 to 64	36, 44, 48, 52, 60, 64	OFDM	BPSK	7.2
802.11n (40MHz)		38 to 62	38, 46, 54, 62	OFDM	BPSK	15.0
802.11a	5500-5700	100 to 140	100, 116, 140	OFDM	BPSK	6.0
802.11n (20MHz)		100 to 140	100, 116, 140	OFDM	BPSK	7.2
802.11n (40MHz)		102 to 134	102, 110, 134	OFDM	BPSK	15.0

POWER LINE CONDUCTED EMISSION TEST:

- Pre-Scan has been conducted to determine the worst-case mode from all possible combinations between available modulations, data rates and antenna ports (if EUT with antenna diversity architecture).
- Following channel(s) was (were) selected for the final test as listed below.

MODE	FREQ. BAND (MHz)	AVAILABLE CHANNEL	TESTED CHANNEL	MODULATION TECHNOLOGY	MODULATION TYPE	DATA RATE (Mbps)
802.11n (20MHz)	5500-5700	100 to 140	100	OFDM	BPSK	7.2

ANTENNA PORT CONDUCTED MEASUREMENT:

- This item includes all test value of each mode, but only includes spectrum plot of worst value of each mode.
- Pre-Scan has been conducted to determine the worst-case mode from all possible combinations between available modulations, data rates and antenna ports (if EUT with antenna diversity architecture).
- Following channel(s) was (were) selected for the final test as listed below.

MODE	FREQ. BAND (MHz)	AVAILABLE CHANNEL	TESTED CHANNEL	MODULATION TECHNOLOGY	MODULATION TYPE	DATA RATE (Mbps)
802.11a	5180-5320	36 to 64	36, 40, 48, 52, 60, 64	OFDM	BPSK	6.0
802.11n (20MHz)		36 to 64	36, 40, 48, 52, 60, 64	OFDM	BPSK	7.2
802.11n (40MHz)		38 to 62	38, 46, 54, 62	OFDM	BPSK	15.0
802.11a	5500-5700	100 to 140	100, 116, 140	OFDM	BPSK	6.0
802.11n (20MHz)		100 to 140	100, 116, 140	OFDM	BPSK	7.2
802.11n (40MHz)		102 to 134	102, 110, 134	OFDM	BPSK	15.0

TEST CONDITION:

APPLICABLE TO	ENVIRONMENTAL CONDITIONS	INPUT POWER (SYSTEM)	TESTED BY
RE	25deg. C, 65%RH	120Vac, 60Hz	Kay Wu
PLC	25deg. C, 67%RH	120Vac, 60Hz	Scott Yang
APCM	25deg. C, 47%RH	120Vac, 60Hz	Phoenix Chen



3.3 Duty cycle of test signal

Duty cycle of test signal is > 98 %.

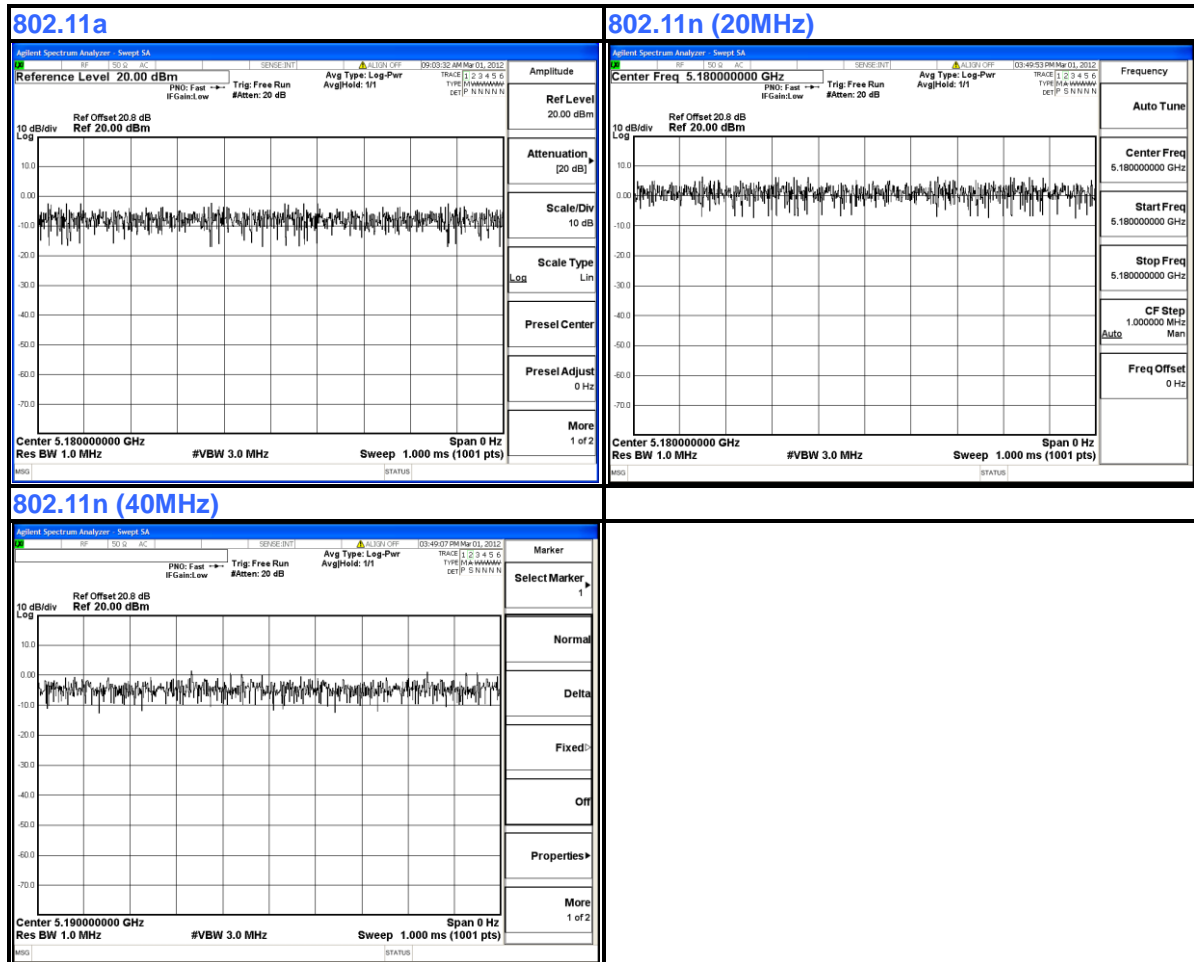

3.4 DESCRIPTION OF SUPPORT UNITS

The EUT has been tested as an independent unit together with other necessary accessories or support units.

3.4.1 CONFIGURATION OF SYSTEM UNDER TEST

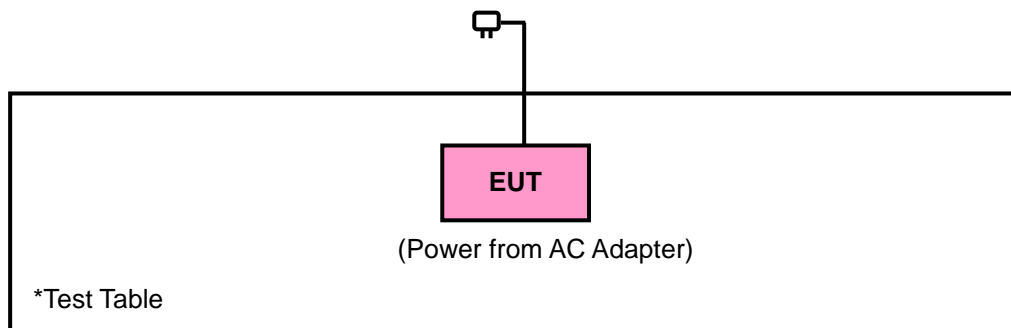

3.5 GENERAL DESCRIPTION OF APPLIED STANDARDS

The EUT is a RF Product. According to the specifications of the manufacturer, it must comply with the requirements of the following standards:

FCC Part 15, Subpart E (15.407)

ANSI C63.10-2009

KDB 789033 D01 General UNII Test Procedures v01r01

All test items have been performed and recorded as per the above standards.

NOTE: The EUT is also considered as a kind of computer peripheral, because the connection to computer is necessary for typical use. It has been verified to comply with the requirements of FCC Part 15, Subpart B, Class B (DoC). The test report has been issued separately.

4. TEST TYPES AND RESULTS

4.1 RADIATED EMISSION AND BANDEDGE MEASUREMENT

4.1.1 LIMITS OF RADIATED EMISSION AND BANDEDGE MEASUREMENT

Emissions radiated outside of the specified bands, shall be according to the general radiated limits in 15.209 as following:

FREQUENCIES (MHz)	FIELD STRENGTH (microvolts/meter)	MEASUREMENT DISTANCE (meters)
0.009 ~ 0.490	2400/F(kHz)	300
0.490 ~ 1.705	24000/F(kHz)	30
1.705 ~ 30.0	30	30
30 ~ 88	100	3
88 ~ 216	150	3
216 ~ 960	200	3
Above 960	500	3

NOTE:

1. The lower limit shall apply at the transition frequencies.
2. Emission level (dBuV/m) = 20 log Emission level (uV/m).
3. As shown in 15.35(b), for frequencies above 1000MHz, the field strength limits are based on average detector, however, the peak field strength of any emission shall not exceed the maximum permitted average limits, specified above by more than 20dB under any condition of modulation.

4.1.2 LIMITS OF UNWANTED EMISSION OUT OF THE RESTRICTED BANDS

FREQUENCIES (MHz)	EIRP LIMIT (dBm)	EQUIVALENT FIELD STRENGTH AT 3m (dBµV/m) *NOTE 3
	PK	PK
5150 ~ 5350	-27	68.3
5470 ~ 5725	-27	68.3

NOTE: The following formula is used to convert the equipment isotropic radiated power (eirp) to field strength:

$$E = \frac{1000000\sqrt{30P}}{3} \mu\text{V/m, where P is the eirp (Watts).}$$

4.1.3 TEST INSTRUMENTS

DESCRIPTION & MANUFACTURER	MODEL NO.	SERIAL NO.	DATE OF CALIBRATION	DUE DATE OF CALIBRATION
Test Receiver Agilent	N9038A	MY51210203	Dec. 22, 2011	Dec. 21, 2012
Spectrum Analyzer ROHDE & SCHWARZ	FSU43	101261	Dec. 21, 2011	Dec. 20, 2012
BILOG Antenna SCHWARZBECK	VULB9168	9168-472	Dec. 20, 2011	Dec. 19, 2012
HORN Antenna SCHWARZBECK	BBHA 9120 D	9120D-969	Dec. 20, 2011	Dec. 19, 2012
HORN Antenna SCHWARZBECK	BBHA 9170	9170-480	Dec. 20, 2011	Dec. 19, 2012
Preamplifier EMCI	EMC 012645	980115	Dec. 30, 2011	Dec. 29, 2012
Preamplifier EMCI	EMC 330H	980112	Dec. 30, 2011	Dec. 29, 2012
RF signal cable HUBER+SUHNNER	SUCOFLEX 104	309219/4	Oct. 21, 2011	Oct. 20, 2012
RF signal cable HUBER+SUHNNER	SUCOFLEX 104	250130/4	Jan. 02, 2012	Jan. 01, 2013
RF signal cable Worken	RG-213	NA	Jan. 02, 2012	Jan. 01, 2013
Software	E3 6.120103	NA	NA	NA
Antenna Tower MF	MFA-440H	NA	NA	NA
Turn Table MF	MFT-201SS	NA	NA	NA
Antenna Tower & Turn Table Controller MF	MF-7802	NA	NA	NA

- NOTE:**
1. The calibration interval of the above test instruments is 12 months and the calibrations are traceable to NML/ROC and NIST/USA.
 2. The test was performed in HwaYa Chamber 9.
 3. The horn antenna and HP preamplifier (model: 8449B) are used only for the measurement of emission frequency above 1GHz if tested.
 4. The FCC Site Registration No. is 460141.
 5. The IC Site Registration No. is IC 7450F-4.

4.1.4 TEST PROCEDURES

- a. The EUT was placed on the top of a rotating table 0.8 meters above the ground at a 3 meter semi-anechoic chamber. The table was rotated 360 degrees to determine the position of the highest radiation.
- b. The EUT was set 3 meters away from the interference-receiving antenna, which was mounted on the top of a variable-height antenna tower.
- c. The antenna is a broadband antenna, and its height is varied from one meter to four meters above the ground to determine the maximum value of the field strength. Both horizontal and vertical polarizations of the antenna are set to make the measurement.
- d. For each suspected emission, the EUT was arranged to its worst case and then the antenna was tuned to heights from 1 meter to 4 meters and the rotatable table was turned from 0 degrees to 360 degrees to find the maximum reading.
- e. The test-receiver system was set to Peak Detect Function and Specified Bandwidth with Maximum Hold Mode.
- f. If the emission level of the EUT in peak mode was 10dB lower than the limit specified, then testing could be stopped and the peak values of the EUT would be reported. Otherwise the emissions that did not have 10dB margin would be re-tested one by one using peak, quasi-peak or average method as specified and then reported in a data sheet.

NOTE:

1. The resolution bandwidth and video bandwidth of test receiver/spectrum analyzer is 120kHz for Peak detection (PK) and Quasi-peak detection (QP) at frequency below 1GHz.
2. RBW=1 MHz; VBW=3 MHz (Peak)/ 10Hz (AV) is used for radiated spurious emission in restricted band above 1GHz
3. RBW=1MHz; VBW=3 MHz(PK)/10Hz(AV) is used for measurement radiated emission and band edge
4. All modes of operation were investigated and the worst-case emissions are reported.

4.1.5 DEVIATION FROM TEST STANDARD

No deviation.

4.1.6 TEST SETUP

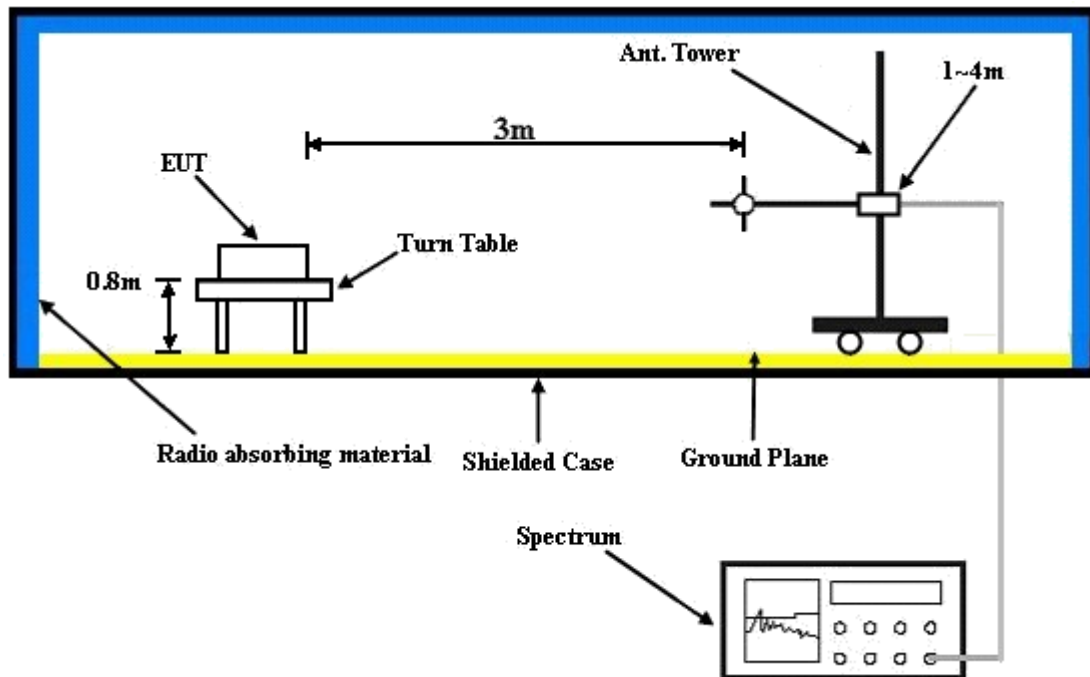

For the actual test configuration, please refer to the attached file (Test Setup Photo).

4.1.7 EUT OPERATING CONDITION

- a. Placed the EUT on a testing table.
- b. Use the software to control the EUT under transmission condition continuously at specific channel frequency.

4.1.8 TEST RESULTS

802.11a

EUT TEST CONDITION		MEASUREMENT DETAIL	
CHANNEL	Channel 36	FREQUENCY RANGE	30MHz ~ 40GHz
INPUT POWER (SYSTEM)	120Vac, 60 Hz	DETECTOR FUNCTION	Peak (PK) Average (AV)
ENVIRONMENTAL CONDITIONS	25deg. C, 65%RH	TESTED BY	Kay Wu

ANTENNA POLARITY & TEST DISTANCE: HORIZONTAL AT 3 M										
FREQ. (MHz)	EMISSION LEVEL (dBuV/m)	READ LEVEL (dBuV)	LIMIT (dBuV/m)	MARGIN (dB)	ANTENNA FACTOR (dB/m)	CABLE LOSS (dB)	PREAMP FACTOR (dB)	ANTENNA HEIGHT (cm)	TABLE ANGLE (Degree)	REMARK
5150	37.71	34.87	54	-16.29	31.87	6.31	35.34	101	178	Average
5150	51.9	49.06	74	-22.1	31.87	6.31	35.34	101	178	Peak
5180	91.29	88.43			31.88	6.28	35.3	101	178	Average
5180	101.86	99			31.88	6.28	35.3	101	178	Peak
5386	35.75	32.56	54	-18.25	31.98	6.35	35.14	101	178	Average
5386	48.23	45.04	74	-25.77	31.98	6.35	35.14	101	178	Peak
ANTENNA POLARITY & TEST DISTANCE: VERTICAL AT 3 M										
FREQ. (MHz)	EMISSION LEVEL (dBuV/m)	READ LEVEL (dBuV)	LIMIT (dBuV/m)	MARGIN (dB)	ANTENNA FACTOR (dB/m)	CABLE LOSS (dB)	PREAMP FACTOR (dB)	ANTENNA HEIGHT (cm)	TABLE ANGLE (Degree)	REMARK
5148	37.47	34.63	54	-16.53	31.87	6.31	35.34	166	207	Average
5148	51.95	49.11	74	-22.05	31.87	6.31	35.34	166	207	Peak
5180	89.79	86.93			31.88	6.28	35.3	166	207	Average
5180	100.2	97.34			31.88	6.28	35.3	166	207	Peak
5458	34.11	30.77	54	-19.89	32.01	6.46	35.13	166	207	Average
5458	47.88	44.54	74	-26.12	32.01	6.46	35.13	166	207	Peak

REMARKS: 5180MHz: Fundamental frequency.



A D T

EUT TEST CONDITION		MEASUREMENT DETAIL	
CHANNEL	Channel 44	FREQUENCY RANGE	30MHz ~ 40GHz
INPUT POWER (SYSTEM)	120Vac, 60 Hz	DETECTOR FUNCTION	Peak (PK) Average (AV)
ENVIRONMENTAL CONDITIONS	25deg. C, 65%RH	TESTED BY	Kay Wu

ANTENNA POLARITY & TEST DISTANCE: HORIZONTAL AT 3 M										
FREQ. (MHz)	EMISSION LEVEL (dBuV/m)	READ LEVEL (dBuV)	LIMIT (dBuV/m)	MARGIN (dB)	ANTENNA FACTOR (dB/m)	CABLE LOSS (dB)	PREAMP FACTOR (dB)	ANTENNA HEIGHT (cm)	TABLE ANGLE (Degree)	REMARK
5146	35.3	32.46	54	-18.7	31.87	6.31	35.34	102	136	Average
5146	49.17	46.33	74	-24.83	31.87	6.31	35.34	102	136	Peak
5220	91.93	89.03			31.9	6.26	35.26	102	136	Average
5220	102.66	99.76			31.9	6.26	35.26	102	136	Peak
5408	35.36	32.14	54	-18.64	31.99	6.36	35.13	102	136	Average
5408	48.45	45.23	74	-25.55	31.99	6.36	35.13	102	136	Peak
ANTENNA POLARITY & TEST DISTANCE: VERTICAL AT 3 M										
FREQ. (MHz)	EMISSION LEVEL (dBuV/m)	READ LEVEL (dBuV)	LIMIT (dBuV/m)	MARGIN (dB)	ANTENNA FACTOR (dB/m)	CABLE LOSS (dB)	PREAMP FACTOR (dB)	ANTENNA HEIGHT (cm)	TABLE ANGLE (Degree)	REMARK
5112	35.12	32.35	54	-18.88	31.85	6.35	35.43	137	212	Average
5112	48.36	45.59	74	-25.64	31.85	6.35	35.43	137	212	Peak
5220	89.27	86.37			31.9	6.26	35.26	137	212	Average
5220	100.02	97.12			31.9	6.26	35.26	137	212	Peak
5458	34.16	30.82	54	-19.84	32.01	6.46	35.13	137	212	Average
5458	47.28	43.94	74	-26.72	32.01	6.46	35.13	137	212	Peak

REMARKS: 5220MHz: Fundamental frequency.



A D T

EUT TEST CONDITION		MEASUREMENT DETAIL	
CHANNEL	Channel 48	FREQUENCY RANGE	30MHz ~ 40GHz
INPUT POWER (SYSTEM)	120Vac, 60 Hz	DETECTOR FUNCTION	Peak (PK) Average (AV)
ENVIRONMENTAL CONDITIONS	25deg. C, 65%RH	TESTED BY	Kay Wu

ANTENNA POLARITY & TEST DISTANCE: HORIZONTAL AT 3 M										
FREQ. (MHz)	EMISSION LEVEL (dBuV/m)	READ LEVEL (dBuV)	LIMIT (dBuV/m)	MARGIN (dB)	ANTENNA FACTOR (dB/m)	CABLE LOSS (dB)	PREAMP FACTOR (dB)	ANTENNA HEIGHT (cm)	TABLE ANGLE (Degree)	REMARK
5098	35.27	32.51	54	-18.73	31.84	6.35	35.43	128	137	Average
5098	47.45	44.69	74	-26.55	31.84	6.35	35.43	128	137	Peak
5240	90.62	87.67			31.91	6.28	35.24	128	137	Average
5240	101.41	98.45			31.92	6.28	35.24	128	137	Peak
5436	34.11	30.82	54	-19.89	32.01	6.41	35.13	128	137	Average
5436	47.01	43.72	74	-26.99	32.01	6.41	35.13	128	137	Peak
ANTENNA POLARITY & TEST DISTANCE: VERTICAL AT 3 M										
FREQ. (MHz)	EMISSION LEVEL (dBuV/m)	READ LEVEL (dBuV)	LIMIT (dBuV/m)	MARGIN (dB)	ANTENNA FACTOR (dB/m)	CABLE LOSS (dB)	PREAMP FACTOR (dB)	ANTENNA HEIGHT (cm)	TABLE ANGLE (Degree)	REMARK
5120	34.36	31.57	54	-19.64	31.85	6.33	35.39	167	241	Average
5120	47.86	45.07	74	-26.14	31.85	6.33	35.39	167	241	Peak
5240	88.73	85.78			31.91	6.28	35.24	167	241	Average
5240	99.87	96.92			31.91	6.28	35.24	167	241	Peak
5390	33.92	30.73	54	-20.08	31.98	6.35	35.14	167	241	Average
5390	46.69	43.5	74	-27.31	31.98	6.35	35.14	167	241	Peak

REMARKS: 5240MHz: Fundamental frequency.



A D T

EUT TEST CONDITION		MEASUREMENT DETAIL	
CHANNEL	Channel 52	FREQUENCY RANGE	30MHz ~ 40GHz
INPUT POWER (SYSTEM)	120Vac, 60 Hz	DETECTOR FUNCTION	Peak (PK) Average (AV)
ENVIRONMENTAL CONDITIONS	25deg. C, 65%RH	TESTED BY	Kay Wu

ANTENNA POLARITY & TEST DISTANCE: HORIZONTAL AT 3 M										
FREQ. (MHz)	EMISSION LEVEL (dBuV/m)	READ LEVEL (dBuV)	LIMIT (dBuV/m)	MARGIN (dB)	ANTENNA FACTOR (dB/m)	CABLE LOSS (dB)	PREAMP FACTOR (dB)	ANTENNA HEIGHT (cm)	TABLE ANGLE (Degree)	REMARK
5130	35.44	32.64	54	-18.56	31.86	6.33	35.39	100	174	Average
5130	48.6	45.8	74	-25.4	31.86	6.33	35.39	100	174	Peak
5260	89.64	86.63			31.92	6.3	35.21	100	174	Average
5260	100.37	97.36			31.92	6.3	35.21	100	174	Peak
5458	34.18	30.84	54	-19.82	32.01	6.46	35.13	100	174	Average
5458	47.55	44.21	74	-26.45	32.01	6.46	35.13	100	174	Peak
ANTENNA POLARITY & TEST DISTANCE: VERTICAL AT 3 M										
FREQ. (MHz)	EMISSION LEVEL (dBuV/m)	READ LEVEL (dBuV)	LIMIT (dBuV/m)	MARGIN (dB)	ANTENNA FACTOR (dB/m)	CABLE LOSS (dB)	PREAMP FACTOR (dB)	ANTENNA HEIGHT (cm)	TABLE ANGLE (Degree)	REMARK
5102	35.17	32.41	54	-18.83	31.84	6.35	35.43	138	240	Average
5102	47.36	44.6	74	-26.64	31.84	6.35	35.43	138	240	Peak
5260	88.4	85.39			31.92	6.3	35.21	138	240	Average
5260	98.84	95.83			31.92	6.3	35.21	138	240	Peak
5384	34.97	31.78	54	-19.03	31.98	6.35	35.14	138	240	Average
5384	47.16	43.97	74	-26.84	31.98	6.35	35.14	138	240	Peak

REMARKS: 5260MHz: Fundamental frequency.



A D T

EUT TEST CONDITION		MEASUREMENT DETAIL	
CHANNEL	Channel 60	FREQUENCY RANGE	30MHz ~ 40GHz
INPUT POWER (SYSTEM)	120Vac, 60 Hz	DETECTOR FUNCTION	Peak (PK) Average (AV)
ENVIRONMENTAL CONDITIONS	25deg. C, 65%RH	TESTED BY	Kay Wu

ANTENNA POLARITY & TEST DISTANCE: HORIZONTAL AT 3 M										
FREQ. (MHz)	EMISSION LEVEL (dBuV/m)	READ LEVEL (dBuV)	LIMIT (dBuV/m)	MARGIN (dB)	ANTENNA FACTOR (dB/m)	CABLE LOSS (dB)	PREAMP FACTOR (dB)	ANTENNA HEIGHT (cm)	TABLE ANGLE (Degree)	REMARK
5132	34.47	31.67	54	-19.53	31.86	6.33	35.39	100	183	Average
5132	47.91	45.11	74	-26.09	31.86	6.33	35.39	100	183	Peak
5300	89.33	86.22			31.94	6.33	35.16	100	183	Average
5300	99.83	96.77			31.94	6.31	35.19	100	183	Peak
5372	34.24	31.07	54	-19.76	31.97	6.35	35.15	100	183	Average
5372	48.13	44.96	74	-25.87	31.97	6.35	35.15	100	183	Peak
ANTENNA POLARITY & TEST DISTANCE: VERTICAL AT 3 M										
FREQ. (MHz)	EMISSION LEVEL (dBuV/m)	READ LEVEL (dBuV)	LIMIT (dBuV/m)	MARGIN (dB)	ANTENNA FACTOR (dB/m)	CABLE LOSS (dB)	PREAMP FACTOR (dB)	ANTENNA HEIGHT (cm)	TABLE ANGLE (Degree)	REMARK
5084	33.79	31.08	54	-20.21	31.83	6.29	35.41	124	245	Average
5084	48.41	45.7	74	-25.59	31.83	6.29	35.41	124	245	Peak
5300	87.16	84.05			31.94	6.33	35.16	124	245	Average
5300	97.47	94.36			31.94	6.33	35.16	124	245	Peak
5460	34.41	31.07	54	-19.59	32.01	6.46	35.13	124	245	Average
5460	47.23	43.89	74	-26.77	32.01	6.46	35.13	124	245	Peak

REMARKS: 5300MHz: Fundamental frequency.



A D T

EUT TEST CONDITION		MEASUREMENT DETAIL	
CHANNEL	Channel 64	FREQUENCY RANGE	30MHz ~ 40GHz
INPUT POWER (SYSTEM)	120Vac, 60 Hz	DETECTOR FUNCTION	Peak (PK) Average (AV)
ENVIRONMENTAL CONDITIONS	25deg. C, 65%RH	TESTED BY	Kay Wu

ANTENNA POLARITY & TEST DISTANCE: HORIZONTAL AT 3 M										
FREQ. (MHz)	EMISSION LEVEL (dBuV/m)	READ LEVEL (dBuV)	LIMIT (dBuV/m)	MARGIN (dB)	ANTENNA FACTOR (dB/m)	CABLE LOSS (dB)	PREAMP FACTOR (dB)	ANTENNA HEIGHT (cm)	TABLE ANGLE (Degree)	REMARK
5028	35.31	32.71	54	-18.69	31.81	6.17	35.38	139	104	Average
5028	47.98	45.38	74	-26.02	31.81	6.17	35.38	139	104	Peak
5320	89.62	86.5			31.95	6.33	35.16	139	104	Average
5320	99.88	96.76			31.95	6.33	35.16	139	104	Peak
5352	34.85	31.68	54	-19.15	31.97	6.35	35.15	139	104	Average
5352	47.64	44.47	74	-26.36	31.97	6.35	35.15	139	104	Peak
ANTENNA POLARITY & TEST DISTANCE: VERTICAL AT 3 M										
FREQ. (MHz)	EMISSION LEVEL (dBuV/m)	READ LEVEL (dBuV)	LIMIT (dBuV/m)	MARGIN (dB)	ANTENNA FACTOR (dB/m)	CABLE LOSS (dB)	PREAMP FACTOR (dB)	ANTENNA HEIGHT (cm)	TABLE ANGLE (Degree)	REMARK
5044	34.99	32.33	54	-19.01	31.82	6.23	35.39	123	245	Average
5044	47.02	44.36	74	-26.98	31.82	6.23	35.39	123	245	Peak
5320	87.46	84.34			31.95	6.33	35.16	123	245	Average
5320	97.91	94.78			31.95	6.34	35.16	123	245	Peak
5408	35.36	32.14	54	-18.64	31.99	6.36	35.13	123	245	Average
5408	47.31	44.09	74	-26.69	31.99	6.36	35.13	123	245	Peak

REMARKS: 5320MHz: Fundamental frequency.



A D T

EUT TEST CONDITION		MEASUREMENT DETAIL	
CHANNEL	Channel 100	FREQUENCY RANGE	30MHz ~ 40GHz
INPUT POWER (SYSTEM)	120Vac, 60 Hz	DETECTOR FUNCTION	Peak (PK) Average (AV)
ENVIRONMENTAL CONDITIONS	25deg. C, 65%RH	TESTED BY	Kay Wu

ANTENNA POLARITY & TEST DISTANCE: HORIZONTAL AT 3 M										
FREQ. (MHz)	EMISSION LEVEL (dBuV/m)	READ LEVEL (dBuV)	LIMIT (dBuV/m)	MARGIN (dB)	ANTENNA FACTOR (dB/m)	CABLE LOSS (dB)	PREAMP FACTOR (dB)	ANTENNA HEIGHT (cm)	TABLE ANGLE (Degree)	REMARK
5458	36.58	33.24	54	-17.42	32.01	6.46	35.13	136	108	Average
5458	49.01	45.67	74	-24.99	32.01	6.46	35.13	136	108	Peak
5470	49.69	46.34	68.3	-18.61	32.02	6.46	35.13	136	108	Peak
5500	87.76	84.33			32.04	6.51	35.12	136	108	Average
5500	102.25	98.82			32.04	6.51	35.12	136	108	Peak
5725	47.8	43.96	68.3	-20.5	32.36	6.62	35.14	136	108	Peak
ANTENNA POLARITY & TEST DISTANCE: VERTICAL AT 3 M										
FREQ. (MHz)	EMISSION LEVEL (dBuV/m)	READ LEVEL (dBuV)	LIMIT (dBuV/m)	MARGIN (dB)	ANTENNA FACTOR (dB/m)	CABLE LOSS (dB)	PREAMP FACTOR (dB)	ANTENNA HEIGHT (cm)	TABLE ANGLE (Degree)	REMARK
5446	35.52	32.23	54	-18.48	32.01	6.41	35.13	102	90	Average
5446	47.87	44.58	74	-26.13	32.01	6.41	35.13	102	90	Peak
5470	52.62	49.27	68.3	-15.68	32.02	6.46	35.13	102	90	Peak
5500	92.28	88.85			32.04	6.51	35.12	102	90	Average
5500	102.53	99.1			32.04	6.51	35.12	102	90	Peak
5725	46.05	42.21	68.3	-22.25	32.36	6.62	35.14	102	90	Peak

REMARKS:

1. 5550MHz: Fundamental frequency.
2. 5470MHz & 5725MHz: Out of restricted band



A D T

EUT TEST CONDITION		MEASUREMENT DETAIL	
CHANNEL	Channel 116	FREQUENCY RANGE	30MHz ~ 40GHz
INPUT POWER (SYSTEM)	120Vac, 60 Hz	DETECTOR FUNCTION	Peak (PK) Average (AV)
ENVIRONMENTAL CONDITIONS	25deg. C, 65%RH	TESTED BY	Kay Wu

ANTENNA POLARITY & TEST DISTANCE: HORIZONTAL AT 3 M										
FREQ. (MHz)	EMISSION LEVEL (dBuV/m)	READ LEVEL (dBuV)	LIMIT (dBuV/m)	MARGIN (dB)	ANTENNA FACTOR (dB/m)	CABLE LOSS (dB)	PREAMP FACTOR (dB)	ANTENNA HEIGHT (cm)	TABLE ANGLE (Degree)	REMARK
5370	35.5	32.33	54	-18.5	31.97	6.35	35.15	100	36	Average
5370	47.7	44.53	74	-26.3	31.97	6.35	35.15	100	36	Peak
5470	45.53	42.18	68.3	-22.77	32.02	6.46	35.13	100	36	Peak
5580	89.99	86.46			32.14	6.46	35.07	100	36	Average
5580	100.84	97.31			32.14	6.47	35.08	100	36	Peak
5725	48.28	44.44	68.3	-20.02	32.36	6.62	35.14	100	36	Peak
ANTENNA POLARITY & TEST DISTANCE: VERTICAL AT 3 M										
FREQ. (MHz)	EMISSION LEVEL (dBuV/m)	READ LEVEL (dBuV)	LIMIT (dBuV/m)	MARGIN (dB)	ANTENNA FACTOR (dB/m)	CABLE LOSS (dB)	PREAMP FACTOR (dB)	ANTENNA HEIGHT (cm)	TABLE ANGLE (Degree)	REMARK
5434	35.44	32.15	54	-18.56	32.01	6.41	35.13	100	84	Average
5434	48.32	45.03	74	-25.68	32.01	6.41	35.13	100	84	Peak
5470	45.97	42.62	68.3	-22.33	32.02	6.46	35.13	100	84	Peak
5580	91.41	87.88			32.14	6.46	35.07	100	84	Average
5580	102.09	98.56			32.14	6.46	35.07	100	84	Peak
5725	46.01	42.17	68.3	-22.29	32.36	6.62	35.14	100	84	Peak

REMARKS:

- 5580MHz: Fundamental frequency.
- 5470MHz & 5725MHz: Out of restricted band



A D T

EUT TEST CONDITION		MEASUREMENT DETAIL	
CHANNEL	Channel 140	FREQUENCY RANGE	30MHz ~ 40GHz
INPUT POWER (SYSTEM)	120Vac, 60 Hz	DETECTOR FUNCTION	Peak (PK) Average (AV)
ENVIRONMENTAL CONDITIONS	25deg. C, 65%RH	TESTED BY	Kay Wu

ANTENNA POLARITY & TEST DISTANCE: HORIZONTAL AT 3 M										
FREQ. (MHz)	EMISSION LEVEL (dBuV/m)	READ LEVEL (dBuV)	LIMIT (dBuV/m)	MARGIN (dB)	ANTENNA FACTOR (dB/m)	CABLE LOSS (dB)	PREAMP FACTOR (dB)	ANTENNA HEIGHT (cm)	TABLE ANGLE (Degree)	REMARK
5394	35.3	32.11	54	-18.7	31.98	6.35	35.14	153	113	Average
5394	47.3	44.11	74	-26.7	31.98	6.35	35.14	153	113	Peak
5470	45.06	41.71	68.3	-23.24	32.02	6.46	35.13	153	113	Peak
5700	88.17	84.4			32.31	6.59	35.13	153	113	Average
5700	98.5	94.73			32.31	6.59	35.13	153	113	Peak
5725	54.22	50.38	68.3	-14.08	32.36	6.62	35.14	153	113	Peak
ANTENNA POLARITY & TEST DISTANCE: VERTICAL AT 3 M										
FREQ. (MHz)	EMISSION LEVEL (dBuV/m)	READ LEVEL (dBuV)	LIMIT (dBuV/m)	MARGIN (dB)	ANTENNA FACTOR (dB/m)	CABLE LOSS (dB)	PREAMP FACTOR (dB)	ANTENNA HEIGHT (cm)	TABLE ANGLE (Degree)	REMARK
5374	35.45	32.27	54	-18.55	31.97	6.35	35.14	109	102	Average
5374	47.26	44.08	74	-26.74	31.97	6.35	35.14	109	102	Peak
5470	45.08	41.73	68.3	-23.22	32.02	6.46	35.13	109	102	Peak
5700	88.81	85.04			32.31	6.59	35.13	109	102	Average
5700	99.21	95.42			32.33	6.59	35.13	109	102	Peak
5725	53.1	49.26	68.3	-15.2	32.36	6.62	35.14	109	102	Peak

REMARKS:

- 5700MHz: Fundamental frequency.
- 5470MHz & 5725MHz: Out of restricted band

802.11n (20MHz)

EUT TEST CONDITION		MEASUREMENT DETAIL	
CHANNEL	Channel 36	FREQUENCY RANGE	30MHz ~ 40GHz
INPUT POWER (SYSTEM)	120Vac, 60 Hz	DETECTOR FUNCTION	Peak (PK) Average (AV)
ENVIRONMENTAL CONDITIONS	25deg. C, 65%RH	TESTED BY	Kay Wu

ANTENNA POLARITY & TEST DISTANCE: HORIZONTAL AT 3 M										
FREQ. (MHz)	EMISSION LEVEL (dBuV/m)	READ LEVEL (dBuV)	LIMIT (dBuV/m)	MARGIN (dB)	ANTENNA FACTOR (dB/m)	CABLE LOSS (dB)	PREAMP FACTOR (dB)	ANTENNA HEIGHT (cm)	TABLE ANGLE (Degree)	REMARK
5150	40.38	37.54	54	-13.62	31.87	6.31	35.34	102	173	Average
5150	57.99	55.15	74	-16.01	31.87	6.31	35.34	102	173	Peak
5180	92.62	89.76			31.88	6.28	35.3	102	173	Average
5180	103.19	100.33			31.88	6.28	35.3	102	173	Peak
5350	36.61	33.44	54	-17.39	31.97	6.35	35.15	102	173	Average
5350	46.8	43.63	74	-27.2	31.97	6.35	35.15	102	173	Peak
ANTENNA POLARITY & TEST DISTANCE: VERTICAL AT 3 M										
FREQ. (MHz)	EMISSION LEVEL (dBuV/m)	READ LEVEL (dBuV)	LIMIT (dBuV/m)	MARGIN (dB)	ANTENNA FACTOR (dB/m)	CABLE LOSS (dB)	PREAMP FACTOR (dB)	ANTENNA HEIGHT (cm)	TABLE ANGLE (Degree)	REMARK
5150	41.08	38.24	54	-12.92	31.87	6.31	35.34	164	198	Average
5150	59.25	56.41	74	-14.75	31.87	6.31	35.34	164	198	Peak
5180	92.94	90.08			31.88	6.28	35.3	164	198	Average
5180	103.46	100.6			31.88	6.28	35.3	164	198	Peak
5350	35.85	32.68	54	-18.15	31.97	6.35	35.15	164	198	Average
5350	46.63	43.46	74	-27.37	31.97	6.35	35.15	164	198	Peak

REMARKS: 5180MHz: Fundamental frequency.



A D T

EUT TEST CONDITION		MEASUREMENT DETAIL	
CHANNEL	Channel 44	FREQUENCY RANGE	30MHz ~ 40GHz
INPUT POWER (SYSTEM)	120Vac, 60 Hz	DETECTOR FUNCTION	Peak (PK) Average (AV)
ENVIRONMENTAL CONDITIONS	25deg. C, 65%RH	TESTED BY	Kay Wu

ANTENNA POLARITY & TEST DISTANCE: HORIZONTAL AT 3 M										
FREQ. (MHz)	EMISSION LEVEL (dBuV/m)	READ LEVEL (dBuV)	LIMIT (dBuV/m)	MARGIN (dB)	ANTENNA FACTOR (dB/m)	CABLE LOSS (dB)	PREAMP FACTOR (dB)	ANTENNA HEIGHT (cm)	TABLE ANGLE (Degree)	REMARK
5150	36.45	33.61	54	-17.55	31.87	6.31	35.34	100	181	Average
5150	46.66	43.82	74	-27.34	31.87	6.31	35.34	100	181	Peak
5220	91.08	88.18			31.9	6.26	35.26	100	181	Average
5220	101.83	98.93			31.9	6.26	35.26	100	181	Peak
5350	35.7	32.53	54	-18.3	31.97	6.35	35.15	100	181	Average
5350	46.05	42.88	74	-27.95	31.97	6.35	35.15	100	181	Peak
ANTENNA POLARITY & TEST DISTANCE: VERTICAL AT 3 M										
FREQ. (MHz)	EMISSION LEVEL (dBuV/m)	READ LEVEL (dBuV)	LIMIT (dBuV/m)	MARGIN (dB)	ANTENNA FACTOR (dB/m)	CABLE LOSS (dB)	PREAMP FACTOR (dB)	ANTENNA HEIGHT (cm)	TABLE ANGLE (Degree)	REMARK
5150	35.93	33.09	54	-18.07	31.87	6.31	35.34	150	198	Average
5150	47.04	44.2	74	-26.96	31.87	6.31	35.34	150	198	Peak
5220	91.83	88.93			31.9	6.26	35.26	150	198	Average
5220	102.61	99.71			31.9	6.26	35.26	150	198	Peak
5350	35.78	32.61	54	-18.22	31.97	6.35	35.15	150	198	Average
5350	46.28	43.11	74	-27.72	31.97	6.35	35.15	150	198	Peak

REMARKS: 5220MHz: Fundamental frequency.



A D T

EUT TEST CONDITION		MEASUREMENT DETAIL	
CHANNEL	Channel 48	FREQUENCY RANGE	30MHz ~ 40GHz
INPUT POWER (SYSTEM)	120Vac, 60 Hz	DETECTOR FUNCTION	Peak (PK) Average (AV)
ENVIRONMENTAL CONDITIONS	25deg. C, 65%RH	TESTED BY	Kay Wu

ANTENNA POLARITY & TEST DISTANCE: HORIZONTAL AT 3 M										
FREQ. (MHz)	EMISSION LEVEL (dBuV/m)	READ LEVEL (dBuV)	LIMIT (dBuV/m)	MARGIN (dB)	ANTENNA FACTOR (dB/m)	CABLE LOSS (dB)	PREAMP FACTOR (dB)	ANTENNA HEIGHT (cm)	TABLE ANGLE (Degree)	REMARK
5150	35.88	33.04	54	-18.12	31.87	6.31	35.34	100	174	Average
5150	46.42	43.58	74	-27.58	31.87	6.31	35.34	100	174	Peak
5240	90.99	88.04			31.91	6.28	35.24	100	174	Average
5240	102.03	99.08			31.91	6.28	35.24	100	174	Peak
5350	35.85	32.68	54	-18.15	31.97	6.35	35.15	100	174	Average
5350	46.59	43.42	74	-27.41	31.97	6.35	35.15	100	174	Peak
ANTENNA POLARITY & TEST DISTANCE: VERTICAL AT 3 M										
FREQ. (MHz)	EMISSION LEVEL (dBuV/m)	READ LEVEL (dBuV)	LIMIT (dBuV/m)	MARGIN (dB)	ANTENNA FACTOR (dB/m)	CABLE LOSS (dB)	PREAMP FACTOR (dB)	ANTENNA HEIGHT (cm)	TABLE ANGLE (Degree)	REMARK
5150	35.97	33.13	54	-18.03	31.87	6.31	35.34	148	199	Average
5150	46.86	44.02	74	-27.14	31.87	6.31	35.34	148	199	Peak
5240	92.02	89.07			31.91	6.28	35.24	148	199	Average
5240	102.41	99.46			31.91	6.28	35.24	148	199	Peak
5350	35.7	32.53	54	-18.3	31.97	6.35	35.15	148	199	Average
5350	46.7	43.53	74	-27.3	31.97	6.35	35.15	148	199	Peak

REMARKS: 5240MHz: Fundamental frequency.



A D T

EUT TEST CONDITION		MEASUREMENT DETAIL	
CHANNEL	Channel 52	FREQUENCY RANGE	30MHz ~ 40GHz
INPUT POWER (SYSTEM)	120Vac, 60 Hz	DETECTOR FUNCTION	Peak (PK) Average (AV)
ENVIRONMENTAL CONDITIONS	25deg. C, 65%RH	TESTED BY	Kay Wu

ANTENNA POLARITY & TEST DISTANCE: HORIZONTAL AT 3 M										
FREQ. (MHz)	EMISSION LEVEL (dBuV/m)	READ LEVEL (dBuV)	LIMIT (dBuV/m)	MARGIN (dB)	ANTENNA FACTOR (dB/m)	CABLE LOSS (dB)	PREAMP FACTOR (dB)	ANTENNA HEIGHT (cm)	TABLE ANGLE (Degree)	REMARK
5150	35	32.16	54	-19	31.87	6.31	35.34	100	173	Average
5150	47.06	44.22	74	-26.94	31.87	6.31	35.34	100	173	Peak
5260	91.21	88.2			31.92	6.3	35.21	100	173	Average
5260	101.75	98.74			31.92	6.3	35.21	100	173	Peak
5350	35.77	32.6	54	-18.23	31.97	6.35	35.15	100	173	Average
5350	46.59	43.42	74	-27.41	31.97	6.35	35.15	100	173	Peak
ANTENNA POLARITY & TEST DISTANCE: VERTICAL AT 3 M										
FREQ. (MHz)	EMISSION LEVEL (dBuV/m)	READ LEVEL (dBuV)	LIMIT (dBuV/m)	MARGIN (dB)	ANTENNA FACTOR (dB/m)	CABLE LOSS (dB)	PREAMP FACTOR (dB)	ANTENNA HEIGHT (cm)	TABLE ANGLE (Degree)	REMARK
5150	36.04	33.2	54	-17.96	31.87	6.31	35.34	146	198	Average
5150	47.45	44.61	74	-26.55	31.87	6.31	35.34	146	198	Peak
5260	91.81	88.8			31.92	6.3	35.21	146	198	Average
5260	102.35	99.34			31.92	6.3	35.21	146	198	Peak
5350	36.11	32.94	54	-17.89	31.97	6.35	35.15	146	198	Average
5350	46.09	42.92	74	-27.91	31.97	6.35	35.15	146	198	Peak

REMARKS: 5260MHz: Fundamental frequency.



A D T

EUT TEST CONDITION		MEASUREMENT DETAIL	
CHANNEL	Channel 60	FREQUENCY RANGE	30MHz ~ 40GHz
INPUT POWER (SYSTEM)	120Vac, 60 Hz	DETECTOR FUNCTION	Peak (PK) Average (AV)
ENVIRONMENTAL CONDITIONS	25deg. C, 65%RH	TESTED BY	Kay Wu

ANTENNA POLARITY & TEST DISTANCE: HORIZONTAL AT 3 M										
FREQ. (MHz)	EMISSION LEVEL (dBuV/m)	READ LEVEL (dBuV)	LIMIT (dBuV/m)	MARGIN (dB)	ANTENNA FACTOR (dB/m)	CABLE LOSS (dB)	PREAMP FACTOR (dB)	ANTENNA HEIGHT (cm)	TABLE ANGLE (Degree)	REMARK
5150	36.04	33.2	54	-17.96	31.87	6.31	35.34	100	178	Average
5150	46.5	43.66	74	-27.5	31.87	6.31	35.34	100	178	Peak
5300	90.69	87.58			31.94	6.33	35.16	100	178	Average
5300	101.63	98.52			31.94	6.33	35.16	100	178	Peak
5350	36.3	33.13	54	-17.7	31.97	6.35	35.15	100	178	Average
5350	45.75	42.58	74	-28.25	31.97	6.35	35.15	100	178	Peak
ANTENNA POLARITY & TEST DISTANCE: VERTICAL AT 3 M										
FREQ. (MHz)	EMISSION LEVEL (dBuV/m)	READ LEVEL (dBuV)	LIMIT (dBuV/m)	MARGIN (dB)	ANTENNA FACTOR (dB/m)	CABLE LOSS (dB)	PREAMP FACTOR (dB)	ANTENNA HEIGHT (cm)	TABLE ANGLE (Degree)	REMARK
5150	35.97	33.13	54	-18.03	31.87	6.31	35.34	146	197	Average
5150	46.08	43.24	74	-27.92	31.87	6.31	35.34	146	197	Peak
5300	92.46	89.35			31.94	6.33	35.16	146	197	Average
5300	102.94	99.83			31.94	6.33	35.16	146	197	Peak
5350	35.85	32.68	54	-18.15	31.97	6.35	35.15	146	197	Average
5350	46.36	43.19	74	-27.64	31.97	6.35	35.15	146	197	Peak

REMARKS: 5300MHz: Fundamental frequency.



A D T

EUT TEST CONDITION		MEASUREMENT DETAIL	
CHANNEL	Channel 64	FREQUENCY RANGE	30MHz ~ 40GHz
INPUT POWER (SYSTEM)	120Vac, 60 Hz	DETECTOR FUNCTION	Peak (PK) Average (AV)
ENVIRONMENTAL CONDITIONS	25deg. C, 65%RH	TESTED BY	Kay Wu

ANTENNA POLARITY & TEST DISTANCE: HORIZONTAL AT 3 M										
FREQ. (MHz)	EMISSION LEVEL (dBuV/m)	READ LEVEL (dBuV)	LIMIT (dBuV/m)	MARGIN (dB)	ANTENNA FACTOR (dB/m)	CABLE LOSS (dB)	PREAMP FACTOR (dB)	ANTENNA HEIGHT (cm)	TABLE ANGLE (Degree)	REMARK
5150	35.99	33.15	54	-18.01	31.87	6.31	35.34	100	171	Average
5150	46.52	43.68	74	-27.48	31.87	6.31	35.34	100	171	Peak
5320	90.33	87.21			31.95	6.33	35.16	100	171	Average
5320	100.64	97.52			31.95	6.33	35.16	100	171	Peak
5350	37.25	34.08	54	-16.75	31.97	6.35	35.15	100	171	Average
5350	50.87	47.7	74	-23.13	31.97	6.35	35.15	100	171	Peak
ANTENNA POLARITY & TEST DISTANCE: VERTICAL AT 3 M										
FREQ. (MHz)	EMISSION LEVEL (dBuV/m)	READ LEVEL (dBuV)	LIMIT (dBuV/m)	MARGIN (dB)	ANTENNA FACTOR (dB/m)	CABLE LOSS (dB)	PREAMP FACTOR (dB)	ANTENNA HEIGHT (cm)	TABLE ANGLE (Degree)	REMARK
5150	35.51	32.67	54	-18.49	31.87	6.31	35.34	119	198	Average
5150	45.79	42.95	74	-28.21	31.87	6.31	35.34	119	198	Peak
5320	91.94	88.82			31.95	6.33	35.16	119	198	Average
5320	102.31	99.19			31.95	6.33	35.16	119	198	Peak
5354	37.75	34.58	54	-16.25	31.97	6.35	35.15	119	198	Average
5354	53.18	50.01	74	-20.82	31.97	6.35	35.15	119	198	Peak

REMARKS: 5320MHz: Fundamental frequency.



A D T

EUT TEST CONDITION		MEASUREMENT DETAIL	
CHANNEL	Channel 100	FREQUENCY RANGE	30MHz ~ 40GHz
INPUT POWER (SYSTEM)	120Vac, 60 Hz	DETECTOR FUNCTION	Peak (PK) Average (AV)
ENVIRONMENTAL CONDITIONS	25deg. C, 65%RH	TESTED BY	Kay Wu

ANTENNA POLARITY & TEST DISTANCE: HORIZONTAL AT 3 M										
FREQ. (MHz)	EMISSION LEVEL (dBuV/m)	READ LEVEL (dBuV)	LIMIT (dBuV/m)	MARGIN (dB)	ANTENNA FACTOR (dB/m)	CABLE LOSS (dB)	PREAMP FACTOR (dB)	ANTENNA HEIGHT (cm)	TABLE ANGLE (Degree)	REMARK
5460	36.51	33.17	54	-17.49	32.01	6.46	35.13	100	186	Average
5460	51.17	47.83	74	-22.83	32.01	6.46	35.13	100	186	Peak
5470	54.28	50.93	68.3	-14.02	32.02	6.46	35.13	100	186	Peak
5500	90.87	87.44			32.04	6.51	35.12	100	186	Average
5500	101.91	98.48			32.04	6.51	35.12	100	186	Peak
5725	46.7	42.86	68.3	-21.6	32.36	6.62	35.14	100	186	Peak
ANTENNA POLARITY & TEST DISTANCE: VERTICAL AT 3 M										
FREQ. (MHz)	EMISSION LEVEL (dBuV/m)	READ LEVEL (dBuV)	LIMIT (dBuV/m)	MARGIN (dB)	ANTENNA FACTOR (dB/m)	CABLE LOSS (dB)	PREAMP FACTOR (dB)	ANTENNA HEIGHT (cm)	TABLE ANGLE (Degree)	REMARK
5460	37.11	33.77	54	-16.89	32.01	6.46	35.13	114	202	Average
5460	50.47	47.13	74	-23.53	32.01	6.46	35.13	114	202	Peak
5470	56.61	53.26	68.3	-11.69	32.02	6.46	35.13	114	202	Peak
5500	92.44	89.01			32.04	6.51	35.12	114	202	Average
5500	103.53	100.1			32.04	6.51	35.12	114	202	Peak
5725	46.26	42.42	68.3	-22.04	32.36	6.62	35.14	114	202	Peak

REMARKS:

1. 5500MHz: Fundamental frequency.
2. 5470MHz & 5725MHz: Out of restricted band



A D T

EUT TEST CONDITION		MEASUREMENT DETAIL	
CHANNEL	Channel 116	FREQUENCY RANGE	30MHz ~ 40GHz
INPUT POWER (SYSTEM)	120Vac, 60 Hz	DETECTOR FUNCTION	Peak (PK) Average (AV)
ENVIRONMENTAL CONDITIONS	25deg. C, 65%RH	TESTED BY	Kay Wu

ANTENNA POLARITY & TEST DISTANCE: HORIZONTAL AT 3 M										
FREQ. (MHz)	EMISSION LEVEL (dBuV/m)	READ LEVEL (dBuV)	LIMIT (dBuV/m)	MARGIN (dB)	ANTENNA FACTOR (dB/m)	CABLE LOSS (dB)	PREAMP FACTOR (dB)	ANTENNA HEIGHT (cm)	TABLE ANGLE (Degree)	REMARK
5460	36	32.66	54	-18	32.01	6.46	35.13	125	171	Average
5460	46.13	42.79	74	-27.87	32.01	6.46	35.13	125	171	Peak
5470	45.48	42.13	68.3	-22.82	32.02	6.46	35.13	125	171	Peak
5580	90.17	86.64			32.14	6.46	35.07	125	171	Average
5580	101.08	97.55			32.14	6.46	35.07	125	171	Peak
5725	45.54	41.7	68.3	-22.76	32.36	6.62	35.14	125	171	Peak
ANTENNA POLARITY & TEST DISTANCE: VERTICAL AT 3 M										
FREQ. (MHz)	EMISSION LEVEL (dBuV/m)	READ LEVEL (dBuV)	LIMIT (dBuV/m)	MARGIN (dB)	ANTENNA FACTOR (dB/m)	CABLE LOSS (dB)	PREAMP FACTOR (dB)	ANTENNA HEIGHT (cm)	TABLE ANGLE (Degree)	REMARK
5460	35.89	32.55	54	-18.11	32.01	6.46	35.13	114	207	Average
5460	46.43	43.09	74	-27.57	32.01	6.46	35.13	114	207	Peak
5470	46.66	43.31	68.3	-21.64	32.02	6.46	35.13	114	207	Peak
5580	92.18	88.65			32.14	6.46	35.07	114	207	Average
5580	102.71	99.18			32.14	6.46	35.07	114	207	Peak
5725	47.29	43.45	68.3	-21.01	32.36	6.62	35.14	114	207	Peak

REMARKS:

- 5580MHz: Fundamental frequency.
- 5470MHz & 5725MHz: Out of restricted band



A D T

EUT TEST CONDITION		MEASUREMENT DETAIL	
CHANNEL	Channel 140	FREQUENCY RANGE	30MHz ~ 40GHz
INPUT POWER (SYSTEM)	120Vac, 60 Hz	DETECTOR FUNCTION	Peak (PK) Average (AV)
ENVIRONMENTAL CONDITIONS	25deg. C, 65%RH	TESTED BY	Kay Wu

ANTENNA POLARITY & TEST DISTANCE: HORIZONTAL AT 3 M										
FREQ. (MHz)	EMISSION LEVEL (dBuV/m)	READ LEVEL (dBuV)	LIMIT (dBuV/m)	MARGIN (dB)	ANTENNA FACTOR (dB/m)	CABLE LOSS (dB)	PREAMP FACTOR (dB)	ANTENNA HEIGHT (cm)	TABLE ANGLE (Degree)	REMARK
5460	35.35	32.01	54	-18.65	32.01	6.46	35.13	103	173	Average
5460	46.08	42.74	74	-27.92	32.01	6.46	35.13	103	173	Peak
5470	46.13	42.78	68.3	-22.17	32.02	6.46	35.13	103	173	Peak
5700	88.97	85.2			32.31	6.59	35.13	103	173	Average
5700	99.1	95.33			32.31	6.59	35.13	103	173	Peak
5725	54.45	50.61	68.3	-13.85	32.36	6.62	35.14	103	173	Peak
ANTENNA POLARITY & TEST DISTANCE: VERTICAL AT 3 M										
FREQ. (MHz)	EMISSION LEVEL (dBuV/m)	READ LEVEL (dBuV)	LIMIT (dBuV/m)	MARGIN (dB)	ANTENNA FACTOR (dB/m)	CABLE LOSS (dB)	PREAMP FACTOR (dB)	ANTENNA HEIGHT (cm)	TABLE ANGLE (Degree)	REMARK
5460	36.85	33.51	54	-17.15	32.01	6.46	35.13	110	207	Average
5460	45.61	42.27	74	-28.39	32.01	6.46	35.13	110	207	Peak
5470	46.49	43.14	68.3	-21.81	32.02	6.46	35.13	110	207	Peak
5700	90.34	86.57			32.31	6.59	35.13	110	207	Average
5700	100.19	96.42			32.31	6.59	35.13	110	207	Peak
5725	56.89	53.05	68.3	-11.41	32.36	6.62	35.14	110	207	Peak

REMARKS:

1. 5700MHz: Fundamental frequency.
2. 5470MHz & 5725MHz: Out of restricted band



A D T

802.11a (40MHz)

EUT TEST CONDITION		MEASUREMENT DETAIL	
CHANNEL	Channel 38	FREQUENCY RANGE	30MHz ~ 40GHz
INPUT POWER (SYSTEM)	120Vac, 60 Hz	DETECTOR FUNCTION	Peak (PK) Average (AV)
ENVIRONMENTAL CONDITIONS	25deg. C, 65%RH	TESTED BY	Kay Wu

ANTENNA POLARITY & TEST DISTANCE: HORIZONTAL AT 3 M										
FREQ. (MHz)	EMISSION LEVEL (dBuV/m)	READ LEVEL (dBuV)	LIMIT (dBuV/m)	MARGIN (dB)	ANTENNA FACTOR (dB/m)	CABLE LOSS (dB)	PREAMP FACTOR (dB)	ANTENNA HEIGHT (cm)	TABLE ANGLE (Degree)	REMARK
35.67	26.19	43.69	40	-13.81	12.94	0.61	31.05			Peak
120.18	30.88	50.57	43.5	-12.62	11.02	1.19	31.9			Peak
172.02	32.66	51.39	43.5	-10.84	11.57	1.45	31.75	100	266	Peak
311.2	25.52	42.15	46	-20.48	13.22	2.09	31.94			Peak
398.7	21.14	35.53	46	-24.86	15.31	2.42	32.12			Peak
653.5	24.35	32.82	46	-21.65	20.26	3.26	31.99			Peak
5150	45.77	42.93	54	-8.23	31.87	6.31	35.34	100	177	Average
5150	59.28	56.44	74	-14.72	31.87	6.31	35.34	100	177	Peak
5190	88.88	86.02			31.88	6.28	35.3	100	177	Average
5190	99.31	96.45			31.88	6.28	35.3	100	177	Peak
5350	36.12	32.95	54	-17.88	31.97	6.35	35.15	100	177	Average
5350	46.91	43.74	74	-27.09	31.97	6.35	35.15	100	177	Peak
ANTENNA POLARITY & TEST DISTANCE: VERTICAL AT 3 M										
FREQ. (MHz)	EMISSION LEVEL (dBuV/m)	READ LEVEL (dBuV)	LIMIT (dBuV/m)	MARGIN (dB)	ANTENNA FACTOR (dB/m)	CABLE LOSS (dB)	PREAMP FACTOR (dB)	ANTENNA HEIGHT (cm)	TABLE ANGLE (Degree)	REMARK
30.81	34.74	53.15	40	-5.26	12.14	0.57	31.12	100	110	QP
35.67	35.19	52.69	40	-4.81	12.94	0.61	31.05	100	110	QP
171.48	34.87	53.6	43.5	-8.63	11.57	1.45	31.75			Peak
330.1	18.12	34.11	46	-27.88	13.66	2.16	31.81			Peak
628.3	23.58	32.61	46	-22.42	19.95	3.17	32.15			Peak
673.8	24.07	32.06	46	-21.93	20.5	3.33	31.82			Peak
5150	45.05	42.21	54	-8.95	31.87	6.31	35.34	121	85	Average
5150	56.59	53.75	74	-17.41	31.87	6.31	35.34	121	85	Peak
5190	88.24	85.38			31.88	6.28	35.3	121	85	Average
5190	98.77	95.91			31.88	6.28	35.3	121	85	Peak
5350	35.57	32.4	54	-18.43	31.97	6.35	35.15	121	85	Average
5350	46.32	43.15	74	-27.68	31.97	6.35	35.15	121	85	Peak

REMARKS: 5190MHz: Fundamental frequency.



A D T

EUT TEST CONDITION		MEASUREMENT DETAIL	
CHANNEL	Channel 46	FREQUENCY RANGE	30MHz ~ 40GHz
INPUT POWER (SYSTEM)	120Vac, 60 Hz	DETECTOR FUNCTION	Peak (PK) Average (AV)
ENVIRONMENTAL CONDITIONS	25deg. C, 65%RH	TESTED BY	Kay Wu

ANTENNA POLARITY & TEST DISTANCE: HORIZONTAL AT 3 M										
FREQ. (MHz)	EMISSION LEVEL (dBuV/m)	READ LEVEL (dBuV)	LIMIT (dBuV/m)	MARGIN (dB)	ANTENNA FACTOR (dB/m)	CABLE LOSS (dB)	PREAMP FACTOR (dB)	ANTENNA HEIGHT (cm)	TABLE ANGLE (Degree)	REMARK
5150	36	33.16	54	-18	31.87	6.31	35.34	100	175	Average
5150	47.94	45.1	74	-26.06	31.87	6.31	35.34	100	175	Peak
5230	88.68	85.73			31.91	6.28	35.24	100	175	Average
5230	98.98	96.03			31.91	6.28	35.24	100	175	Peak
5350	35.81	32.64	54	-18.19	31.97	6.35	35.15	100	175	Average
5350	45.9	42.73	74	-28.1	31.97	6.35	35.15	100	175	Peak
ANTENNA POLARITY & TEST DISTANCE: VERTICAL AT 3 M										
FREQ. (MHz)	EMISSION LEVEL (dBuV/m)	READ LEVEL (dBuV)	LIMIT (dBuV/m)	MARGIN (dB)	ANTENNA FACTOR (dB/m)	CABLE LOSS (dB)	PREAMP FACTOR (dB)	ANTENNA HEIGHT (cm)	TABLE ANGLE (Degree)	REMARK
5150	35.57	32.73	54	-18.43	31.87	6.31	35.34	151	258	Average
5150	47.81	44.97	74	-26.19	31.87	6.31	35.34	151	258	Peak
5230	88.01	85.06			31.91	6.28	35.24	151	258	Average
5230	98.69	95.74			31.91	6.28	35.24	151	258	Peak
5350	36.3	33.13	54	-17.7	31.97	6.35	35.15	151	258	Average
5350	48	44.83	74	-26	31.97	6.35	35.15	151	258	Peak

REMARKS: 5230MHz: Fundamental frequency.



A D T

EUT TEST CONDITION		MEASUREMENT DETAIL	
CHANNEL	Channel 54	FREQUENCY RANGE	30MHz ~ 40GHz
INPUT POWER (SYSTEM)	120Vac, 60 Hz	DETECTOR FUNCTION	Peak (PK) Average (AV)
ENVIRONMENTAL CONDITIONS	25deg. C, 65%RH	TESTED BY	Kay Wu

ANTENNA POLARITY & TEST DISTANCE: HORIZONTAL AT 3 M										
FREQ. (MHz)	EMISSION LEVEL (dBuV/m)	READ LEVEL (dBuV)	LIMIT (dBuV/m)	MARGIN (dB)	ANTENNA FACTOR (dB/m)	CABLE LOSS (dB)	PREAMP FACTOR (dB)	ANTENNA HEIGHT (cm)	TABLE ANGLE (Degree)	REMARK
5150	35.93	33.09	54	-18.07	31.87	6.31	35.34	100	176	Average
5150	46.86	44.02	74	-27.14	31.87	6.31	35.34	100	176	Peak
5270	88.44	85.43			31.92	6.3	35.21	100	176	Average
5270	99.4	96.39			31.92	6.3	35.21	100	176	Peak
5350	36.26	33.09	54	-17.74	31.97	6.35	35.15	100	176	Average
5350	48.36	45.19	74	-25.64	31.97	6.35	35.15	100	176	Peak
ANTENNA POLARITY & TEST DISTANCE: VERTICAL AT 3 M										
FREQ. (MHz)	EMISSION LEVEL (dBuV/m)	READ LEVEL (dBuV)	LIMIT (dBuV/m)	MARGIN (dB)	ANTENNA FACTOR (dB/m)	CABLE LOSS (dB)	PREAMP FACTOR (dB)	ANTENNA HEIGHT (cm)	TABLE ANGLE (Degree)	REMARK
5150	36.23	33.39	54	-17.77	31.87	6.31	35.34	124	256	Average
5150	47.29	44.45	74	-26.71	31.87	6.31	35.34	124	256	Peak
5270	87.3	84.29			31.92	6.3	35.21	124	256	Average
5270	98.1	95.09			31.92	6.3	35.21	124	256	Peak
5350	35.7	32.53	54	-18.3	31.97	6.35	35.15	124	256	Average
5350	47.55	44.38	74	-26.45	31.97	6.35	35.15	124	256	Peak

REMARKS: 5270MHz: Fundamental frequency.



EUT TEST CONDITION		MEASUREMENT DETAIL	
CHANNEL	Channel 62	FREQUENCY RANGE	30MHz ~ 40GHz
INPUT POWER (SYSTEM)	120Vac, 60 Hz	DETECTOR FUNCTION	Peak (PK) Average (AV)
ENVIRONMENTAL CONDITIONS	25deg. C, 65%RH	TESTED BY	Kay Wu

ANTENNA POLARITY & TEST DISTANCE: HORIZONTAL AT 3 M										
FREQ. (MHz)	EMISSION LEVEL (dBuV/m)	READ LEVEL (dBuV)	LIMIT (dBuV/m)	MARGIN (dB)	ANTENNA FACTOR (dB/m)	CABLE LOSS (dB)	PREAMP FACTOR (dB)	ANTENNA HEIGHT (cm)	TABLE ANGLE (Degree)	REMARK
81.3	25.04	47.47	40	-14.96	8.15	0.98	31.56			Peak
120.18	30.88	50.57	43.5	-12.62	11.02	1.19	31.9	100	266	Peak
269.76	23.95	42.02	46	-22.05	12.05	1.91	32.03			Peak
311.2	25.52	42.15	46	-20.48	13.22	2.09	31.94			Peak
357.4	22.08	37.43	46	-23.92	14.33	2.26	31.94			Peak
806.1	27.55	32.98	46	-18.45	22.3	3.71	31.44			Peak
5150	34.94	32.1	54	-19.06	31.87	6.31	35.34	100	179	Average
5150	47.16	44.32	74	-26.84	31.87	6.31	35.34	100	179	Peak
5310	88.11	84.99			31.95	6.33	35.16	100	179	Average
5310	98.42	95.3			31.95	6.33	35.16	100	179	Peak
5350	41.96	38.79	54	-12.04	31.97	6.35	35.15	100	179	Average
5350	53.9	50.73	74	-20.1	31.97	6.35	35.15	100	179	Peak
ANTENNA POLARITY & TEST DISTANCE: VERTICAL AT 3 M										
FREQ. (MHz)	EMISSION LEVEL (dBuV/m)	READ LEVEL (dBuV)	LIMIT (dBuV/m)	MARGIN (dB)	ANTENNA FACTOR (dB/m)	CABLE LOSS (dB)	PREAMP FACTOR (dB)	ANTENNA HEIGHT (cm)	TABLE ANGLE (Degree)	REMARK
30.81	34.74	53.15	40	-5.26	12.14	0.57	31.12	100	110	QP
35.67	35.19	52.69	40	-4.81	12.94	0.61	31.05	100	110	QP
54.3	36.61	54.59	40	-3.39	12.56	0.79	31.33			Peak
330.1	18.12	34.11	46	-27.88	13.66	2.16	31.81			Peak
628.3	23.58	32.61	46	-22.42	19.95	3.17	32.15			Peak
761.3	25.04	31.2	46	-20.96	21.68	3.6	31.44			Peak
5150	35.97	33.13	54	-18.03	31.87	6.31	35.34	123	257	Average
5150	47.28	44.44	74	-26.72	31.87	6.31	35.34	123	257	Peak
5310	87.76	84.64			31.95	6.33	35.16	123	257	Average
5310	98.68	95.56			31.95	6.33	35.16	123	257	Peak
5350	42.01	38.84	54	-11.99	31.97	6.35	35.15	123	257	Average
5350	52.82	49.65	74	-21.18	31.97	6.35	35.15	123	257	Peak

REMARKS: 5310MHz: Fundamental frequency.



A D T

EUT TEST CONDITION		MEASUREMENT DETAIL	
CHANNEL	Channel 102	FREQUENCY RANGE	30MHz ~ 40GHz
INPUT POWER (SYSTEM)	120Vac, 60 Hz	DETECTOR FUNCTION	Peak (PK) Average (AV)
ENVIRONMENTAL CONDITIONS	25deg. C, 65%RH	TESTED BY	Kay Wu

ANTENNA POLARITY & TEST DISTANCE: HORIZONTAL AT 3 M										
FREQ. (MHz)	EMISSION LEVEL (dBuV/m)	READ LEVEL (dBuV)	LIMIT (dBuV/m)	MARGIN (dB)	ANTENNA FACTOR (dB/m)	CABLE LOSS (dB)	PREAMP FACTOR (dB)	ANTENNA HEIGHT (cm)	TABLE ANGLE (Degree)	REMARK
59.97	24.49	43.08	40	-15.51	11.94	0.83	31.36			Peak
81.3	25.27	47.7	40	-14.73	8.15	0.98	31.56	100	120	Peak
160.41	28.62	46.38	43.5	-14.88	12.73	1.39	31.88			Peak
555.5	21.63	32.1	46	-24.37	18.59	2.96	32.02			Peak
727.7	25.99	32.89	46	-20.01	21.2	3.51	31.61			Peak
909.7	28.41	32.91	46	-17.59	23.56	3.99	32.05			Peak
5460	43.03	39.69	54	-10.97	32.01	6.46	35.13	100	184	Average
5460	57.47	54.13	74	-16.53	32.01	6.46	35.13	100	184	Peak
5470	59.62	56.27	68.3	-8.68	32.02	6.46	35.13	100	184	Peak
5510	88.92	85.49			32.04	6.5	35.11	100	184	Average
5510	99.38	95.95			32.04	6.5	35.11	100	184	Peak
5725	45.95	42.11	68.3	-22.35	32.36	6.62	35.14	100	184	Peak

ANTENNA POLARITY & TEST DISTANCE: VERTICAL AT 3 M										
FREQ. (MHz)	EMISSION LEVEL (dBuV/m)	READ LEVEL (dBuV)	LIMIT (dBuV/m)	MARGIN (dB)	ANTENNA FACTOR (dB/m)	CABLE LOSS (dB)	PREAMP FACTOR (dB)	ANTENNA HEIGHT (cm)	TABLE ANGLE (Degree)	REMARK
30.54	34.11	52.52	40	-5.89	12.14	0.57	31.12	100	5	QP
35.67	33.82	51.32	40	-6.18	12.94	0.61	31.05	100	5	QP
82.92	34.71	57.19	40	-5.29	8.18	0.99	31.65			Peak
526.8	21.08	31.93	46	-24.92	17.93	2.87	31.65			Peak
691.3	24.65	32.37	46	-21.35	20.71	3.4	31.83			Peak
890.1	27.23	31.89	46	-18.77	23.39	3.94	31.99			Peak
5460	43.6	40.26	54	-10.4	32.01	6.46	35.13	119	255	Average
5460	60.12	56.78	74	-13.88	32.01	6.46	35.13	119	255	Peak
5470	61.12	57.77	68.3	-7.18	32.02	6.46	35.13	119	255	Peak
5510	90.69	87.26			32.04	6.5	35.11	119	255	Average
5510	101.4	97.97			32.04	6.5	35.11	119	255	Peak
5725	47.06	43.22	68.3	-21.24	32.36	6.62	35.14	119	255	Peak

REMARKS:

- 5510MHz: Fundamental frequency.
- 5470MHz & 5725MHz: Out of restricted band



A D T

EUT TEST CONDITION		MEASUREMENT DETAIL	
CHANNEL	Channel 110	FREQUENCY RANGE	30MHz ~ 40GHz
INPUT POWER (SYSTEM)	120Vac, 60 Hz	DETECTOR FUNCTION	Peak (PK) Average (AV)
ENVIRONMENTAL CONDITIONS	25deg. C, 65%RH	TESTED BY	Kay Wu

ANTENNA POLARITY & TEST DISTANCE: HORIZONTAL AT 3 M										
FREQ. (MHz)	EMISSION LEVEL (dBuV/m)	READ LEVEL (dBuV)	LIMIT (dBuV/m)	MARGIN (dB)	ANTENNA FACTOR (dB/m)	CABLE LOSS (dB)	PREAMP FACTOR (dB)	ANTENNA HEIGHT (cm)	TABLE ANGLE (Degree)	REMARK
5460	36.51	33.17	54	-17.49	32.01	6.46	35.13	129	186	Average
5460	46.92	43.58	74	-27.08	32.01	6.46	35.13	129	186	Peak
5470	47.43	44.08	68.3	-20.87	32.02	6.46	35.13	129	186	Peak
5550	87.44	83.93			32.11	6.49	35.09	129	186	Average
5550	98.11	94.6			32.11	6.49	35.09	129	186	Peak
5725	46.43	42.59	68.3	-21.87	32.36	6.62	35.14	129	186	Peak
ANTENNA POLARITY & TEST DISTANCE: VERTICAL AT 3 M										
FREQ. (MHz)	EMISSION LEVEL (dBuV/m)	READ LEVEL (dBuV)	LIMIT (dBuV/m)	MARGIN (dB)	ANTENNA FACTOR (dB/m)	CABLE LOSS (dB)	PREAMP FACTOR (dB)	ANTENNA HEIGHT (cm)	TABLE ANGLE (Degree)	REMARK
5460	36.56	33.22	54	-17.44	32.01	6.46	35.13	139	206	Average
5460	48.87	45.53	74	-25.13	32.01	6.46	35.13	139	206	Peak
5470	49.84	46.49	68.3	-18.46	32.02	6.46	35.13	139	206	Peak
5550	89.55	86.04			32.11	6.49	35.09	139	206	Average
5550	100.38	96.87			32.11	6.49	35.09	139	206	Peak
5725	47.44	43.6	68.3	-20.86	32.36	6.62	35.14	139	206	Peak

REMARKS:

- 5550MHz: Fundamental frequency.
- 5470MHz & 5725MHz: Out of restricted band



A D T

EUT TEST CONDITION		MEASUREMENT DETAIL	
CHANNEL	Channel 134	FREQUENCY RANGE	30MHz ~ 40GHz
INPUT POWER (SYSTEM)	120Vac, 60 Hz	DETECTOR FUNCTION	Peak (PK) Average (AV)
ENVIRONMENTAL CONDITIONS	25deg. C, 65%RH	TESTED BY	Kay Wu

ANTENNA POLARITY & TEST DISTANCE: HORIZONTAL AT 3 M										
FREQ. (MHz)	EMISSION LEVEL (dBuV/m)	READ LEVEL (dBuV)	LIMIT (dBuV/m)	MARGIN (dB)	ANTENNA FACTOR (dB/m)	CABLE LOSS (dB)	PREAMP FACTOR (dB)	ANTENNA HEIGHT (cm)	TABLE ANGLE (Degree)	REMARK
5460	36.8	33.46	54	-17.2	32.01	6.46	35.13	118	32	Average
5460	46.89	43.55	74	-27.11	32.01	6.46	35.13	118	32	Peak
5470	46.71	43.36	68.3	-21.59	32.02	6.46	35.13	118	32	Peak
5670	87.03	83.31			32.28	6.56	35.12	118	32	Average
5670	97.75	94.03			32.28	6.56	35.12	118	32	Peak
5725	50.88	47.04	68.3	-17.42	32.36	6.62	35.14	118	32	Peak
ANTENNA POLARITY & TEST DISTANCE: VERTICAL AT 3 M										
FREQ. (MHz)	EMISSION LEVEL (dBuV/m)	READ LEVEL (dBuV)	LIMIT (dBuV/m)	MARGIN (dB)	ANTENNA FACTOR (dB/m)	CABLE LOSS (dB)	PREAMP FACTOR (dB)	ANTENNA HEIGHT (cm)	TABLE ANGLE (Degree)	REMARK
5460	35.49	32.15	54	-18.51	32.01	6.46	35.13	137	71	Average
5460	46.6	43.26	74	-27.4	32.01	6.46	35.13	137	71	Peak
5470	47.5	44.15	68.3	-20.8	32.02	6.46	35.13	137	71	Peak
5670	90.28	86.56			32.28	6.56	35.12	137	71	Average
5670	100.91	97.19			32.28	6.56	35.12	137	71	Peak
5725	53.12	49.28	68.3	-15.18	32.36	6.62	35.14	137	71	Peak

REMARKS:

- 5670MHz: Fundamental frequency.
- 5470MHz & 5725MHz: Out of restricted band

4.2 CONDUCTED EMISSION MEASUREMENT

4.2.1 LIMITS OF CONDUCTED EMISSION MEASUREMENT

FREQUENCY OF EMISSION (MHz)	CONDUCTED LIMIT (dB μ V)	
	Quasi-peak	Average
0.15 ~ 0.5	66 to 56	56 to 46
0.5 ~ 5	56	46
5 ~ 30	60	50

- NOTE:** 1. The lower limit shall apply at the transition frequencies.
2. The limit decreases in line with the logarithm of the frequency in the range of 0.15 to 0.50MHz.
3. All emanations from a class A/B digital device or system, including any network of conductors and apparatus connected thereto, shall not exceed the level of field strengths specified above.

4.2.2 TEST INSTRUMENTS

DESCRIPTION & MANUFACTURER	MODEL NO.	SERIAL NO.	DATE OF CALIBRATION	DUE DATE OF CALIBRATION
Test Receiver ROHDE & SCHWARZ	ESCS30	100289	Nov. 19, 2011	Nov. 18, 2012
RF signal cable Woken	5D-FB	Cable-HYCO2-0 1	Dec. 22, 2011	Dec. 21, 2012
LISN ROHDE & SCHWARZ	ESH2-Z5	100100	Dec. 30, 2011	Dec. 29, 2012
LISN ROHDE & SCHWARZ	ESH3-Z5	100312	Jul. 07, 2011	Jul. 06, 2012
V-LISN SCHWARZBECK	NNBL 8226-2	8226-142	Jun. 30, 2011	Jun. 29, 2012
LISN ROHDE & SCHWARZ	ENV216	100072	Jun. 10, 2011	Jun. 09, 2012
Software ADT	ADT_Cond_ V7.3.7	NA	NA	NA

- NOTE:** 1. The calibration interval of the above test instruments is 12 months and the calibrations are traceable to NML/ROC and NIST/USA.
2. The test was performed in HwaYa Shielded Room 2.
3. The VCCI Site Registration No. is C-2047.

4.2.3 TEST PROCEDURES

- a. The EUT was placed 0.4 meters from the conducting wall of the shielded room with EUT being connected to the power mains through a line impedance stabilization network (LISN). Other support units were connected to the power mains through another LISN. The two LISNs provide 50 ohm/ 50uH of coupling impedance for the measuring instrument.
- b. Both lines of the power mains connected to the EUT were checked for maximum conducted interference.
- c. The frequency range from 150kHz to 30MHz was searched. Emission levels under (Limit - 20dB) was not recorded.

4.2.4 DEVIATION FROM TEST STANDARD

No deviation.

4.2.5 TEST SETUP

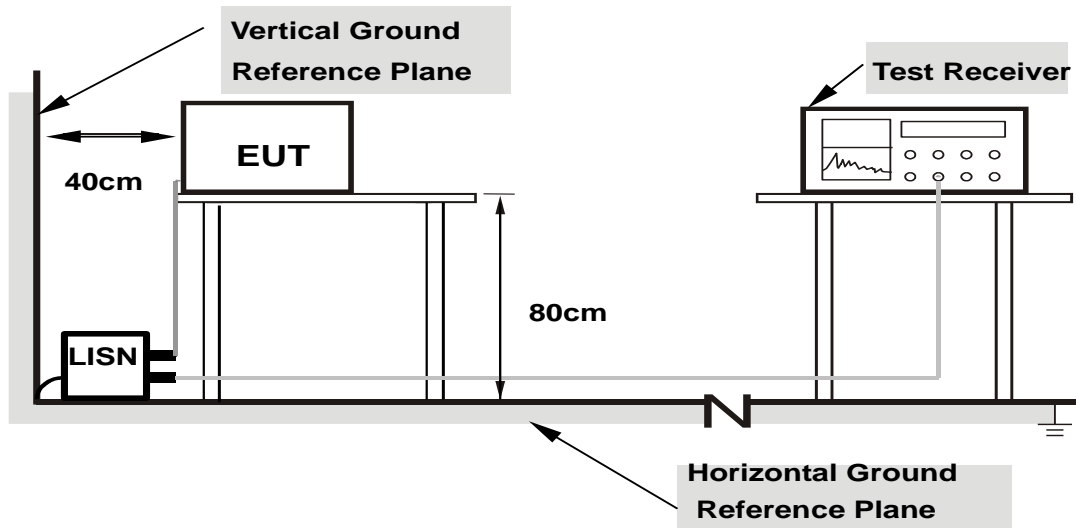

- Note:**
- 1.Support units were connected to second LISN.
 - 2.Both of LISNs (AMN) are 80 cm from EUT and at least 80 from other units and other metal planes

For the actual test configuration, please refer to the attached file (Test Setup Photo).

4.2.6 EUT OPERATING CONDITIONS

Same as 4.1.6.

4.2.7 TEST RESULTS

CONDUCTED WORST-CASE DATA : 802.11n (40MHz)

PHASE	Line 1	6dB BANDWIDTH	9kHz
-------	--------	---------------	------

No	Freq. [MHz]	Corr. Factor (dB)	Reading Value		Emission Level		Limit		Margin	
			[dB (uV)]		[dB (uV)]		[dB (uV)]		(dB)	
			Q.P.	AV.	Q.P.	AV.	Q.P.	AV.	Q.P.	AV.
1	0.18516	0.15	56.59	40.71	56.74	40.86	64.25	54.25	-7.51	-13.39
2	0.27109	0.16	45.51	25.19	45.67	25.35	61.08	51.08	-15.42	-25.74
3	0.72422	0.18	43.59	30.85	43.77	31.03	56.00	46.00	-12.23	-14.97
4	0.85703	0.19	44.53	26.72	44.72	26.91	56.00	46.00	-11.28	-19.09
5	4.25000	0.34	39.33	27.10	39.67	27.44	56.00	46.00	-16.33	-18.56
6	4.64453	0.35	41.10	27.08	41.45	27.43	56.00	46.00	-14.55	-18.57
7	7.59375	0.39	40.40	33.36	40.79	33.75	60.00	50.00	-19.21	-16.25

- REMARKS:**
1. Q.P. and AV. are abbreviations of quasi-peak and average individually.
 2. The emission levels of other frequencies were very low against the limit.
 3. Margin value = Emission level - Limit value
 4. Correction factor = Insertion loss + Cable loss
 5. Emission Level = Correction Factor + Reading Value.

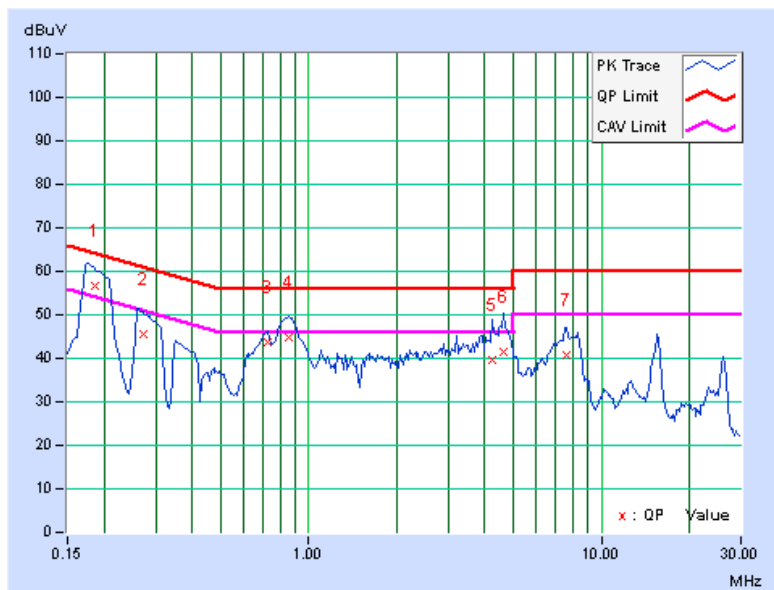



A D T

PHASE	Line 2	6dB BANDWIDTH	9kHz
-------	--------	---------------	------

No	Freq. [MHz]	Corr. Factor (dB)	Reading Value		Emission Level		Limit		Margin	
			[dB (uV)]		[dB (uV)]		[dB (uV)]		(dB)	
			Q.P.	AV.	Q.P.	AV.	Q.P.	AV.	Q.P.	AV.
1	0.18906	0.14	54.24	40.43	54.38	40.57	64.08	54.08	-9.70	-13.51
2	0.27109	0.15	43.46	26.40	43.61	26.55	61.08	51.08	-17.48	-24.54
3	0.72813	0.18	45.36	31.03	45.54	31.21	56.00	46.00	-10.46	-14.79
4	0.87266	0.18	46.05	30.26	46.23	30.44	56.00	46.00	-9.77	-15.56
5	2.91406	0.30	37.99	25.02	38.29	25.32	56.00	46.00	-17.71	-20.68
6	3.80469	0.34	37.86	25.67	38.20	26.01	56.00	46.00	-17.80	-19.99
7	4.58984	0.36	39.13	25.35	39.49	25.71	56.00	46.00	-16.51	-20.29
8	7.48047	0.43	40.58	33.42	41.01	33.85	60.00	50.00	-18.99	-16.15

- REMARKS:**
1. Q.P. and AV. are abbreviations of quasi-peak and average individually.
 2. The emission levels of other frequencies were very low against the limit.
 3. Margin value = Emission level - Limit value
 4. Correction factor = Insertion loss + Cable loss
 5. Emission Level = Correction Factor + Reading Value.

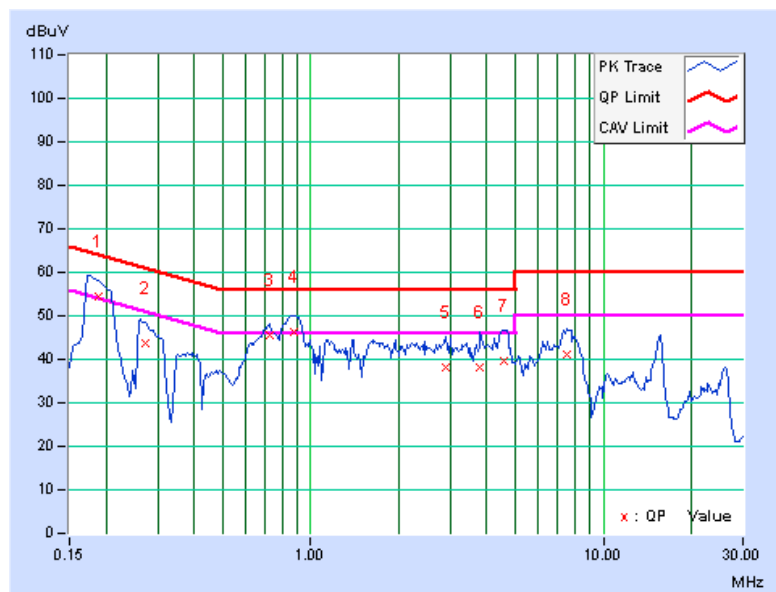

4.3 MAXIMUM CONDUCTED OUTPUT POWER MEASUREMENT

4.3.1 LIMITS OF MAXIMUM CONDUCTED OUTPUT POWER MEASUREMENT

FREQUENCY BAND	LIMIT
5.150 ~ 5.250GHz	The lesser of 50mW (17dBm) or 4dBm + 10logB
5.250 ~ 5.350GHz	The lesser of 250mW (24dBm) or 11dBm + 10logB
5.470 ~ 5.725GHz	The lesser of 250mW (24dBm) or 11dBm + 10logB

NOTE: Where B is the 26dB emission bandwidth in MHz.

4.3.2 TEST SETUP

FOR POWER OUTPUT MEASUREMENT

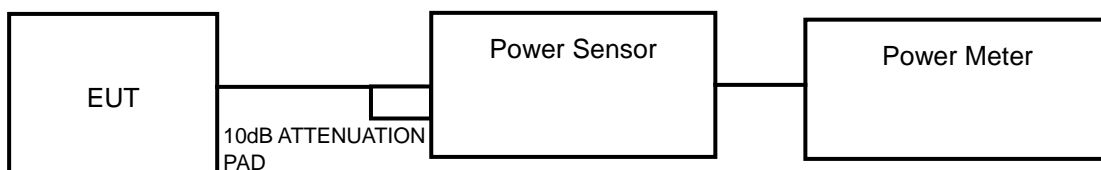

FOR 26dB BANDWIDTH

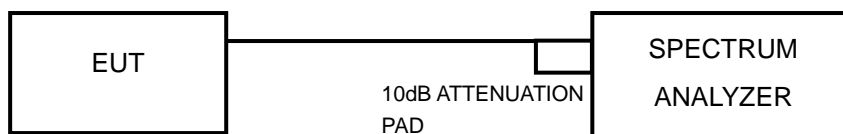

4.3.3 TEST INSTRUMENTS

Refer to section 4.1.3 to get information of above instrument.

4.3.4 TEST PROCEDURE

FOR AVERAGE POWER MEASUREMENT (Method-PM)

An average power sensor was used on the output port of the EUT. A power meter was used to read the response of the power sensor. Record the power level. Duty cycle of test signal is 100%, duty factor is not required to add to measured value.

FOR 26dB BANDWIDTH

- 1) Set RBW = approximately 1% of the emission bandwidth.
- 2) Set the VBW > RBW.
- 3) Detector = Peak.
- 4) Trace mode = max hold.
- 5) Measure the maximum width of the emission that is 26 dB down from the peak of the emission. Compare this with the RBW setting of the analyzer. Readjust RBW and repeat measurement as needed until the RBW/EBW ratio is approximately 1%.

4.3.5 DEVIATION FROM TEST STANDARD

No deviation.

4.3.6 EUT OPERATING CONDITIONS

The software provided by client to enable the EUT under transmission condition continuously at specific channel frequencies individually.

4.3.7 TEST RESULTS

POWER OUTPUT: 802.11a

CHANNEL	CHANNEL FREQUENCY (MHz)	AVERAGE POWER (mW)	AVERAGE POWER (dBm)	POWER LIMIT (dBm)	PASS / FAIL
36	5180	12.677	11.03	17	PASS
44	5220	11.298	10.53	17	PASS
48	5240	9.795	9.91	17	PASS
52	5260	9.683	9.86	24	PASS
60	5300	8.433	9.26	24	PASS
64	5320	8.222	9.15	24	PASS
100	5500	14.028	11.47	24	PASS
116	5580	12.618	11.01	24	PASS
140	5700	9.863	9.94	24	PASS

802.11n (20MHz)

CHANNEL	CHANNEL FREQUENCY (MHz)	AVERAGE POWER (mW)	AVERAGE POWER (dBm)	POWER LIMIT (dBm)	PASS / FAIL
36	5180	18.967	12.78	17	PASS
44	5220	16.943	12.29	17	PASS
48	5240	14.588	11.64	17	PASS
52	5260	14.521	11.62	24	PASS
60	5300	12.794	11.07	24	PASS
64	5320	14.158	11.51	24	PASS
100	5500	21.777	13.38	24	PASS
116	5580	20.045	13.02	24	PASS
140	5700	15.849	12.00	24	PASS



A D T

802.11n (40MHz)

CHANNEL	CHANNEL FREQUENCY (MHz)	AVERAGE POWER (mW)	AVERAGE POWER (dBm)	POWER LIMIT (dBm)	PASS / FAIL
38	5190	18.197	12.600	17	PASS
46	5230	15.996	12.040	17	PASS
54	5270	13.900	11.430	24	PASS
62	5310	15.417	11.880	24	PASS
102	5510	20.989	13.220	24	PASS
110	5550	20.606	13.140	24	PASS
134	5670	16.749	12.240	24	PASS



A D T

26dB BANDWIDTH: 802.11a

CHANNEL	CHANNEL FREQUENCY (MHz)	26dBc BANDWIDTH (MHz)	PASS / FAIL
36	5180	20.090	PASS
44	5220	20.090	PASS
48	5240	20.000	PASS
52	5260	19.900	PASS
60	5300	19.900	PASS
64	5320	19.860	PASS
100	5500	20.130	PASS
116	5580	20.110	PASS
140	5700	20.030	PASS

802.11n (20MHz)

CHANNEL	CHANNEL FREQUENCY (MHz)	26dBc BANDWIDTH (MHz)	PASS / FAIL
36	5180	20.360	PASS
44	5220	20.320	PASS
48	5240	20.300	PASS
52	5260	20.320	PASS
60	5300	20.320	PASS
64	5320	20.320	PASS
100	5500	20.320	PASS
116	5580	20.320	PASS
140	5700	20.320	PASS



A D T

802.11n (40MHz)

CHANNEL	CHANNEL FREQUENCY (MHz)	26dBc BANDWIDTH (MHz)	PASS / FAIL
38	5190	40.480	PASS
46	5230	40.480	PASS
54	5270	40.480	PASS
62	5310	40.480	PASS
102	5510	40.480	PASS
110	5550	40.480	PASS
134	5670	40.480	PASS

4.4 PEAK POWER EXCURSION MEASUREMENT

4.4.1 LIMITS OF PEAK POWER EXCURSION MEASUREMENT

Shall not exceed 13 dB

4.4.2 TEST SETUP

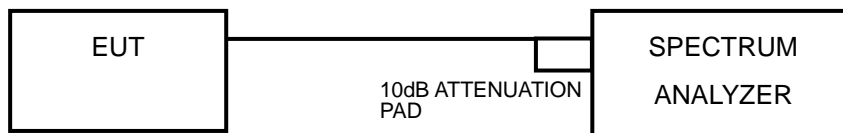

4.4.3 TEST INSTRUMENTS

Refer to section 4.1.3 to get information of above instrument.

4.4.4 TEST PROCEDURE

- 1) Set RBW = 1 MHz, VBW \geq 3 MHz, Detector = peak.
- 2) Trace mode = max-hold. Allow the sweeps to continue until the trace stabilizes.
- 3) Use the peak search function to find the peak of the spectrum.
- 4) Use method SA-1 to measure the PPSD.
- 5) Compute the ratio of the maximum of the peak-max-hold spectrum to the PPSD.

4.4.5 DEVIATION FROM TEST STANDARD

No deviation.

4.4.6 EUT OPERATING CONDITIONS

Same as 4.2.6



A D T

4.4.7 TEST RESULTS

802.11a

CHANNEL	CHANNEL FREQUENCY (MHz)	PEAK VALUE (dBm)	PPSD (dBm)	PEAK EXCURSION (dB)	LIMIT (dB)	PASS/FAIL
36	5180	7.235	-1.92	9.155	13	PASS
44	5220	6.276	-2.214	8.49	13	PASS
48	5240	5.627	-3.15	8.777	13	PASS
52	5260	5.515	-2.902	8.417	13	PASS
60	5300	4.99	-3.667	8.657	13	PASS
64	5320	4.843	-3.728	8.571	13	PASS
100	5500	8.003	-1.459	9.462	13	PASS
116	5580	7.314	-1.723	9.037	13	PASS
140	5700	5.995	-2.977	8.972	13	PASS



A D T

Channel 100

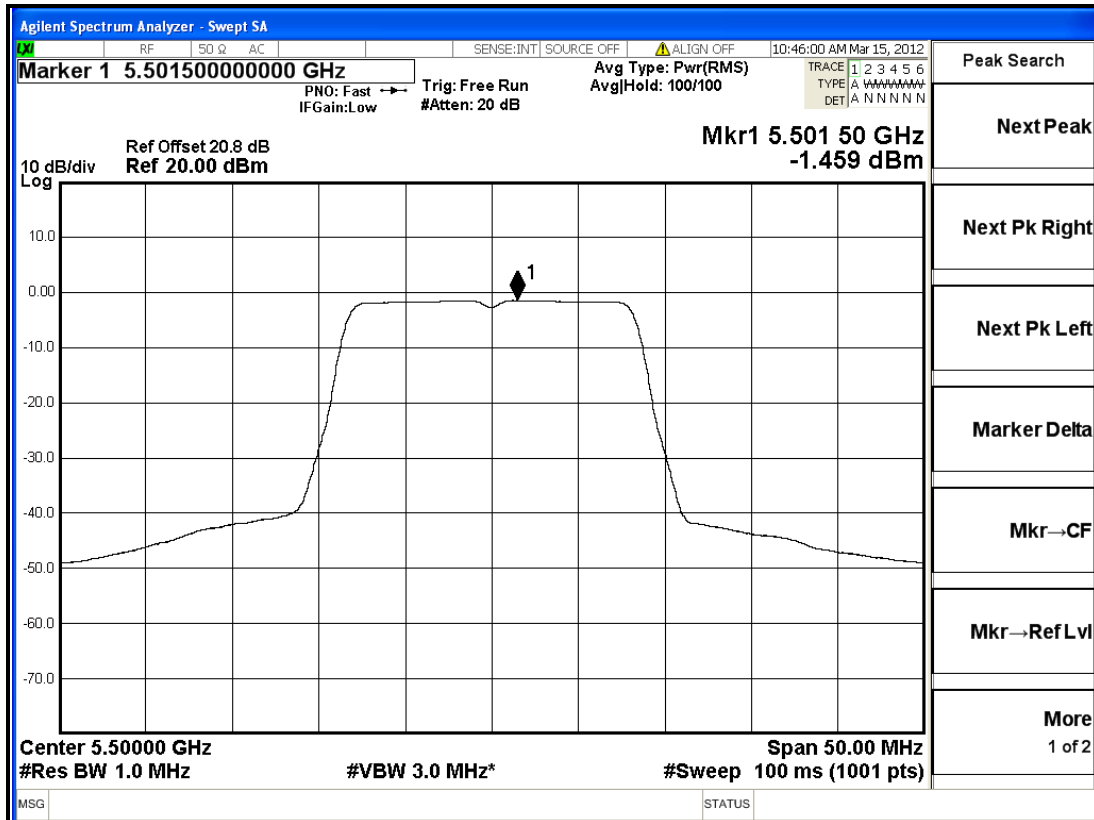
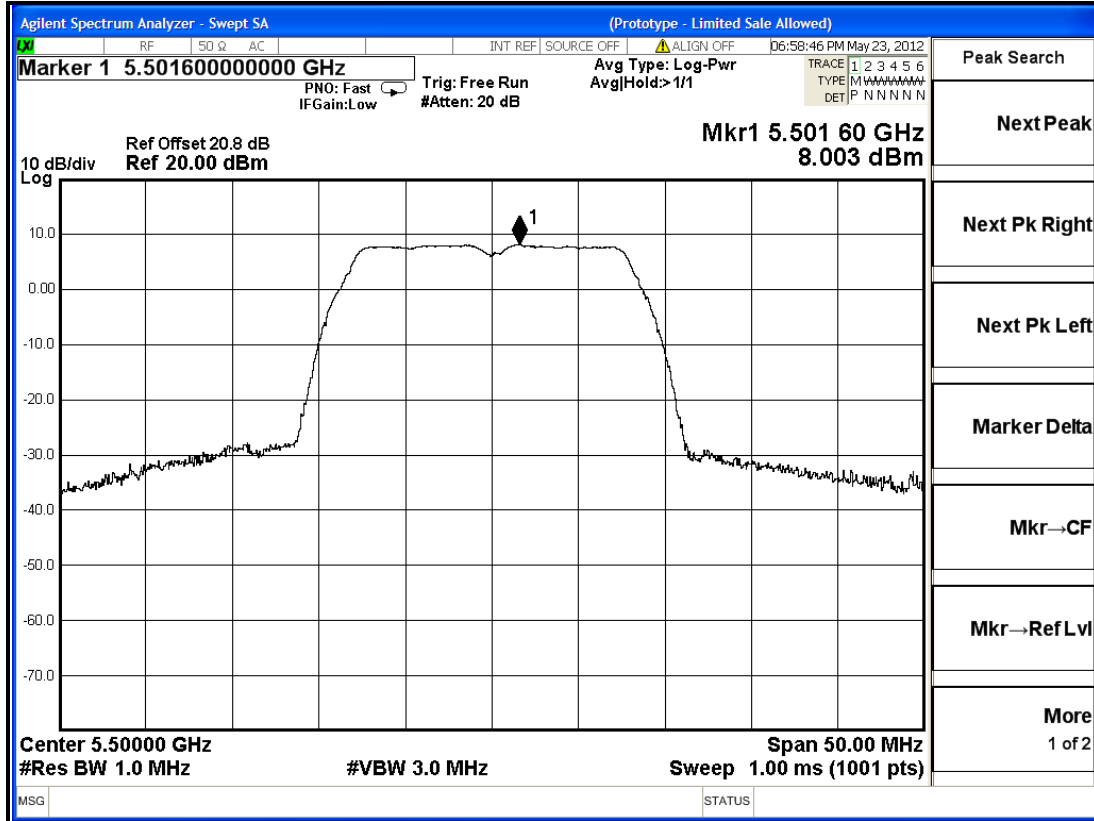



A D T

802.11n (20MHz)

CHANNEL	CHANNEL FREQUENCY (MHz)	PEAK VALUE (dBm)	PPSD (dBm)	PEAK EXCURSION (dB)	LIMIT (dB)	PASS/FAIL
36	5180	8.944	-0.118	9.062	13	PASS
44	5220	8.382	-0.634	9.016	13	PASS
48	5240	7.741	-1.256	8.997	13	PASS
52	5260	7.613	-1.309	8.922	13	PASS
60	5300	7.19	-2.028	9.218	13	PASS
64	5320	7.01	-2.073	9.083	13	PASS
100	5500	9.85	0.636	9.214	13	PASS
116	5580	9.624	0.367	9.257	13	PASS
140	5700	7.788	-0.96	8.748	13	PASS



A D T

Channel 116

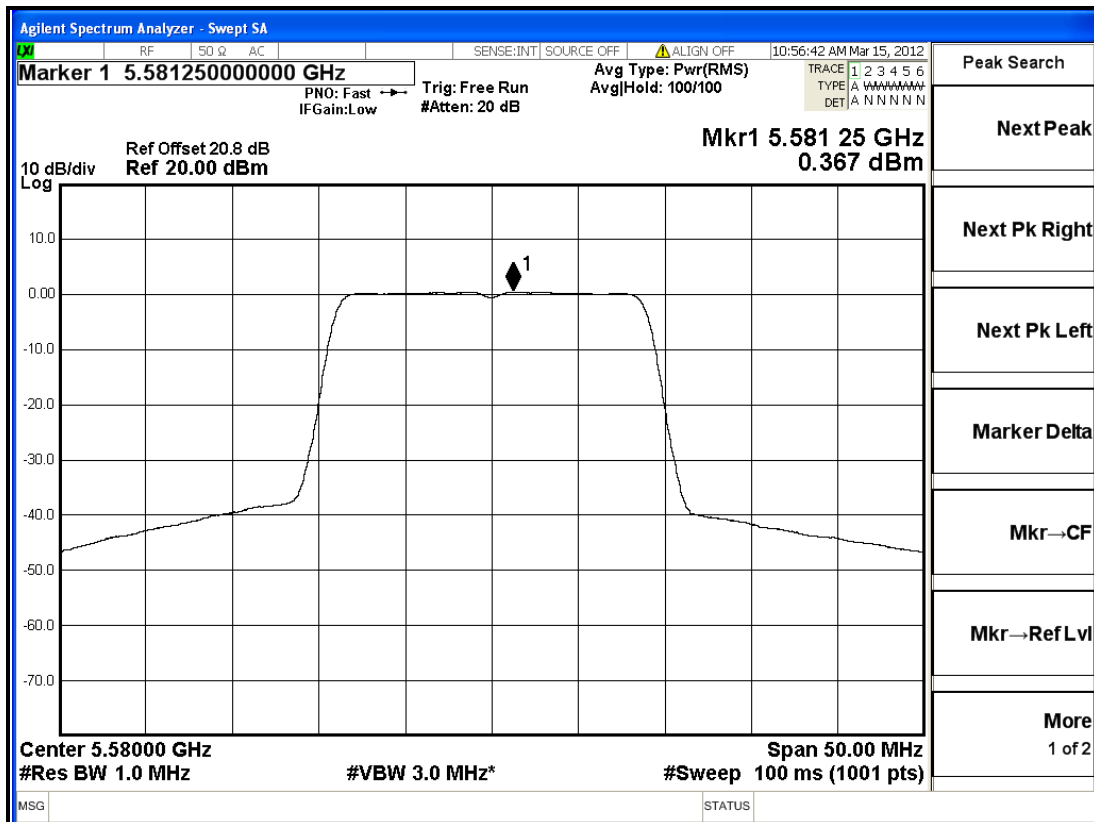
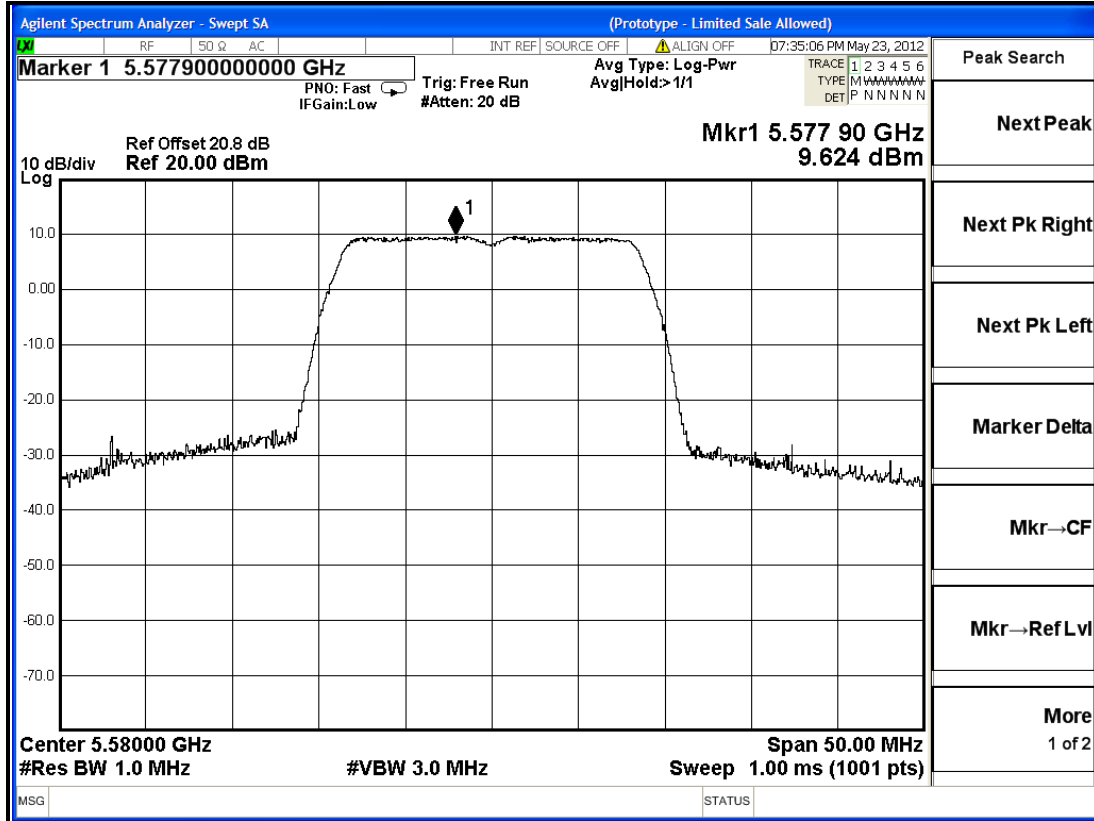



802.11n (40MHz)

CHANNEL	CHANNEL FREQUENCY (MHz)	PEAK VALUE (dBm)	PPSD (dBm)	PEAK EXCURSION (dB)	LIMIT (dB)	PASS/FAIL
38	5190	5.682	-3.218	8.9	13	PASS
46	5230	5.194	-3.809	9.003	13	PASS
54	5270	4.548	-4.419	8.967	13	PASS
62	5310	3.965	-5.115	9.08	13	PASS
102	5510	7.096	-2.227	9.323	13	PASS
118	5590	7.188	-2.02	9.208	13	PASS
134	5670	5.85	-3.013	8.863	13	PASS



A D T

Channel 102

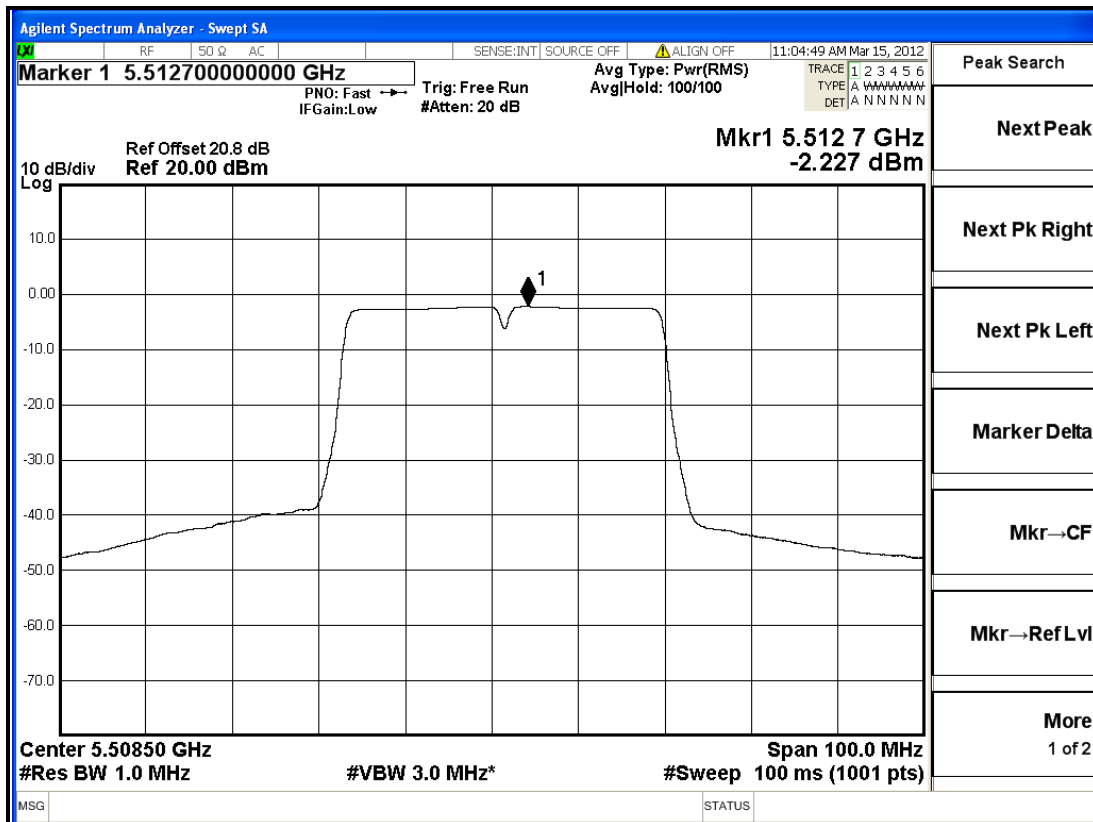
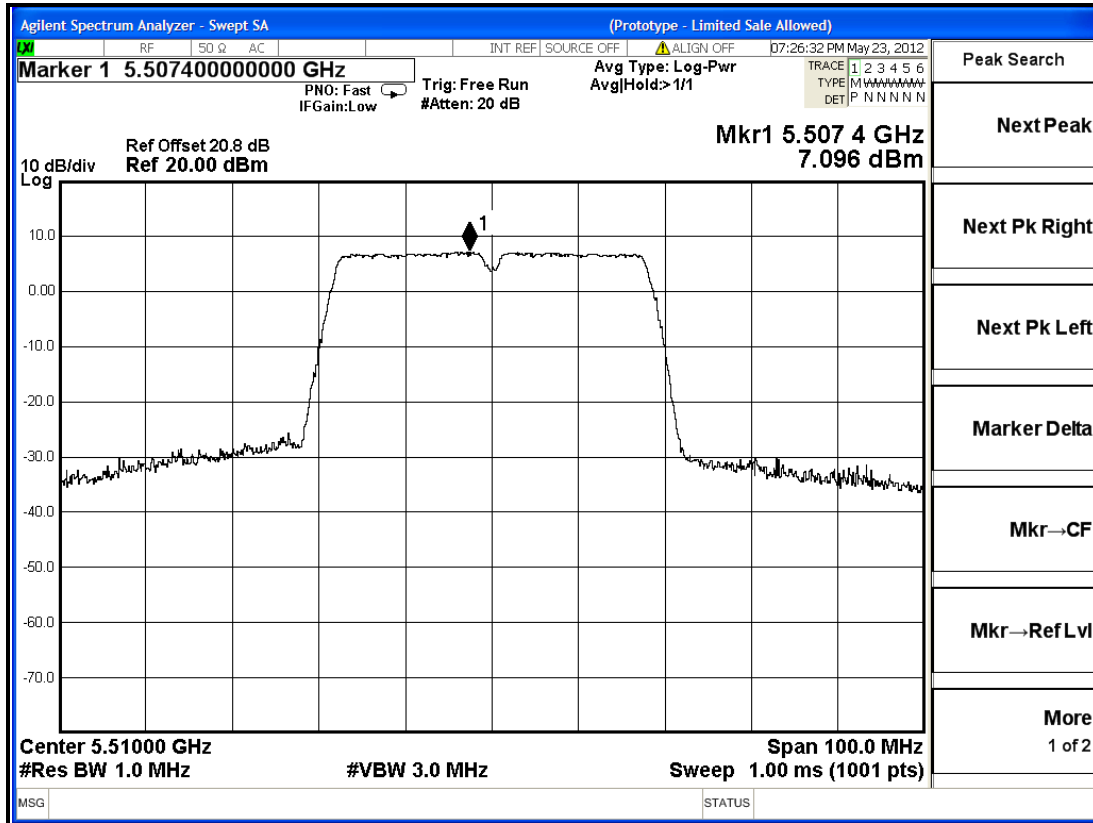

4.5 PEAK POWER SPECTRAL DENSITY MEASUREMENT

4.5.1 LIMITS OF PEAK POWER SPECTRAL DENSITY MEASUREMENT

FREQUENCY BAND	LIMIT(dBm)
5.15 ~ 5.25GHz	4
5.25 ~ 5.35GHz and 5.470 ~ 5.725GHz	11
5.725~5825GHz	17

4.5.2 TEST SETUP

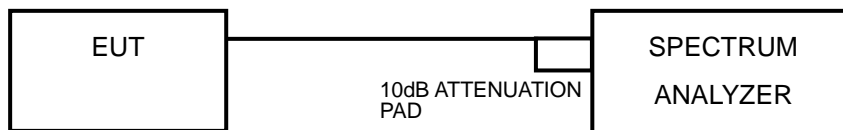

4.5.3 TEST INSTRUMENTS

Refer to section 4.1.3 to get information of above instrument.

4.5.4 TEST PROCEDURES

- 1) Method SA-1 is used. Set span to encompass the entire emission bandwidth (EBW) of the signal.
- 2) Set RBW = 1 MHz, Set VBW \geq 3 MHz, Detector = RMS
- 3) Sweep time = auto, trigger set to "free run".
- 4) Trace average at least 100 traces in power averaging mode.
- 5) Record the max value

4.5.5 DEVIATION FROM TEST STANDARD

No deviation.



A D T

4.5.6 EUT OPERATING CONDITIONS

Same as 4.3.6.



4.5.7 TEST RESULTS

802.11a

CHANNEL	FREQUENCY (MHz)	PSD (dBm)	MAXIMUM LIMIT (dBm)	PASS/FAIL
36	5180	-1.92	4	PASS
40	5200	-2.214	4	PASS
48	5240	-3.15	4	PASS
52	5260	-2.902	11	PASS
60	5300	-3.667	11	PASS
64	5320	-3.728	11	PASS
100	5500	-1.459	11	PASS
116	5580	-1.723	11	PASS
140	5700	-2.977	11	PASS

802.11n (20MHz)

CHANNEL	FREQUENCY (MHz)	PSD (dBm)	MAXIMUM LIMIT (dBm)	PASS/FAIL
36	5180	-0.118	4	PASS
40	5200	-0.634	4	PASS
48	5240	-1.256	4	PASS
52	5260	-1.309	11	PASS
60	5300	-2.028	11	PASS
64	5320	-2.073	11	PASS
100	5500	0.636	11	PASS
116	5580	0.367	11	PASS
140	5700	-0.96	11	PASS



802.11n (40MHz)

CHANNEL	FREQUENCY (MHz)	PSD (dBm)	MAXIMUM LIMIT (dBm)	PASS/FAIL
38	5190	-3.218	4	PASS
46	5230	-3.809	4	PASS
54	5270	-4.419	11	PASS
62	5310	-5.115	11	PASS
102	5510	-2.227	11	PASS
110	5550	-2.02	11	PASS
134	5670	-3.013	11	PASS

4.6 FREQUENCY STABILITY

4.6.1 LIMITS OF FREQUENCY STABILITY MEASUREMENT

The frequency of the carrier signal shall be maintained within band of operation

4.6.2 TEST SETUP

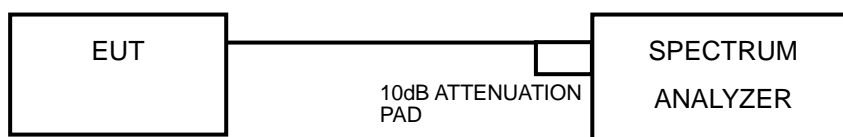

4.6.3 TEST INSTRUMENTS

Refer to section 4.1.3 to get information of above instrument.

4.6.4 TEST PROCEDURE

- a. To ensure emission at the band edge is maintained within the authorized band, those values shall be measured by radiation emissions at upper and lower frequency points, and finally compensated by frequency deviation as procedures below.
- b. The EUT was operated at the maximum output power, and connected to the spectrum analyzer, which is set to maximum hold function and peak detector. The peak value of the power envelope was measured and noted. The upper and lower frequency points were respectively measured relatively 10dB lower than the measured peak value.
- c. The frequency deviation was calculated by adding the upper frequency point and the lower frequency point divided by two. Those detailed values of frequency deviation are provided in table below.

4.6.5 DEVIATION FROM TEST STANDARD

No deviation.

4.6.6 EUT OPERATING CONDITION

Set the EUT transmit at un-modulation mode to test frequency stability.



4.6.7 TEST RESULTS

FREQUENCY STABILITY VERSUS TEMP.				
802.11a				
Channel	Frequency (MHz)	Low Frequency (Fl)	High Frequency (Fh)	Frequency Stability (ppm)
36	5180	5171.65	5188.325	-2.41
40	5200	5211.65	5228.325	-2.39
48	5240	5231.65	5248.325	-2.39
52	5260	5251.675	5268.325	0.00
60	5300	5291.675	5308.325	0.00
64	5320	5311.675	5328.325	0.00
100	5500	5491.675	5508.325	0.00
116	5580	5571.675	5588.325	0.00
140	5700	5691.675	5708.300	-2.19

FREQUENCY STABILITY VERSUS TEMP.				
802.11n (20MHz)				
Channel	Frequency (MHz)	Low Frequency (Fl)	High Frequency (Fh)	Frequency Stability (ppm)
36	5180	5171.050	5188.950	0.00
40	5200	5211.050	5228.950	0.00
48	5240	5231.050	5248.950	0.00
52	5260	5251.050	5268.950	0.00
60	5300	5291.050	5308.950	0.00
64	5320	5311.050	5328.950	0.00
100	5500	5491.050	5508.950	0.00
116	5580	5571.050	5588.950	0.00
140	5700	5691.050	5708.950	0.00



A D T

FREQUENCY STABILITY VERSUS TEMP.				
802.11n (40MHz)				
Channel	Frequency (MHz)	Low Frequency (Fl)	High Frequency (Fh)	Frequency Stability (ppm)
38	5190	5171.700	5208.350	4.82
46	5230	5211.700	5248.300	0.00
54	5270	5251.700	5288.300	0.00
62	5310	5291.650	5328.350	0.00
102	5510	5491.650	5528.350	0.00
118	5590	5531.700	5568.300	0.00
134	5670	5651.700	5688.300	0.00

5. PHOTOGRAPHS OF THE TEST CONFIGURATION

Please refer to the attached file (Test Setup Photo).



6. INFORMATION ON THE TESTING LABORATORIES

We, Bureau Veritas Consumer Products Services (H.K.) Ltd., Taoyuan Branch, were founded in 1988 to provide our best service in EMC, Radio, Telecom and Safety consultation. Our laboratories are accredited and approved according to ISO/IEC 17025.

If you have any comments, please feel free to contact us at the following:

Linko EMC/RF Lab:

Tel: 886-2-26052180

Fax: 886-2-26051924

Hsin Chu EMC/RF Lab:

Tel: 886-3-5935343

Fax: 886-3-5935342

Hwa Ya EMC/RF/Safety Telecom Lab:

Tel: 886-3-3183232

Fax: 886-3-3185050

Email: service.adt@tw.bureauveritas.com

Web Site: www.adt.com.tw

The address and road map of all our labs can be found in our web site also.

7. APPENDIX A - MODIFICATIONS RECORDERS FOR ENGINEERING CHANGES TO THE EUT BY THE LAB

No modifications were made to the EUT by the lab during the test.

---END---