

APPENDIX A: SAR TEST DATA

PCTEST ENGINEERING LABORATORY, INC.

DUT: CF-W2; Type: Panasonic Notebook PC with WLAN; Serial: 4CKSA00035

Communication System: 2.4GHz WLAN; Frequency: 2437 MHz; Duty Cycle: 1:1

Medium: 2450 Muscle ($\sigma = 1.93$ mho/m, $\epsilon_r = 54.62$, $\rho = 1000$ kg/m³)

Phantom section: Flat Section; Space: 0.0 cm

Test Date: 07-29-2004; Ambient Temp: 23.5°C; Tissue Temp: 21.6°C

Probe: ES3DV2 - SN3022; ConvF(4.2, 4.2, 4.2); Calibrated: 9/23/2003

Sensor-Surface: 3mm (Mechanical Surface Detection)

Electronics: DAE3 Sn330; Calibrated: 6/23/2004

Phantom: SAM 12b; Type: SAM 4.0; Serial: TP:1197

Measurement SW: DASY4, V4.2 Build 44; Postprocessing SW: SEMCAD, V1.8 Build 112

Mode: IEEE 802.11b, Laptop Position, ch.06, 11Mbps, Main antenna

Area Scan (41x81x1): Measurement grid: dx=15mm, dy=15mm

Zoom Scan (5x5x7)/Cube 0: Measurement grid: dx=8mm, dy=8mm, dz=5mm

Reference Value = 7.35 V/m

Peak SAR (extrapolated) = 1.18 W/kg

SAR(1 g) = 0.590 mW/g; SAR(10 g) = 0.292 mW/g

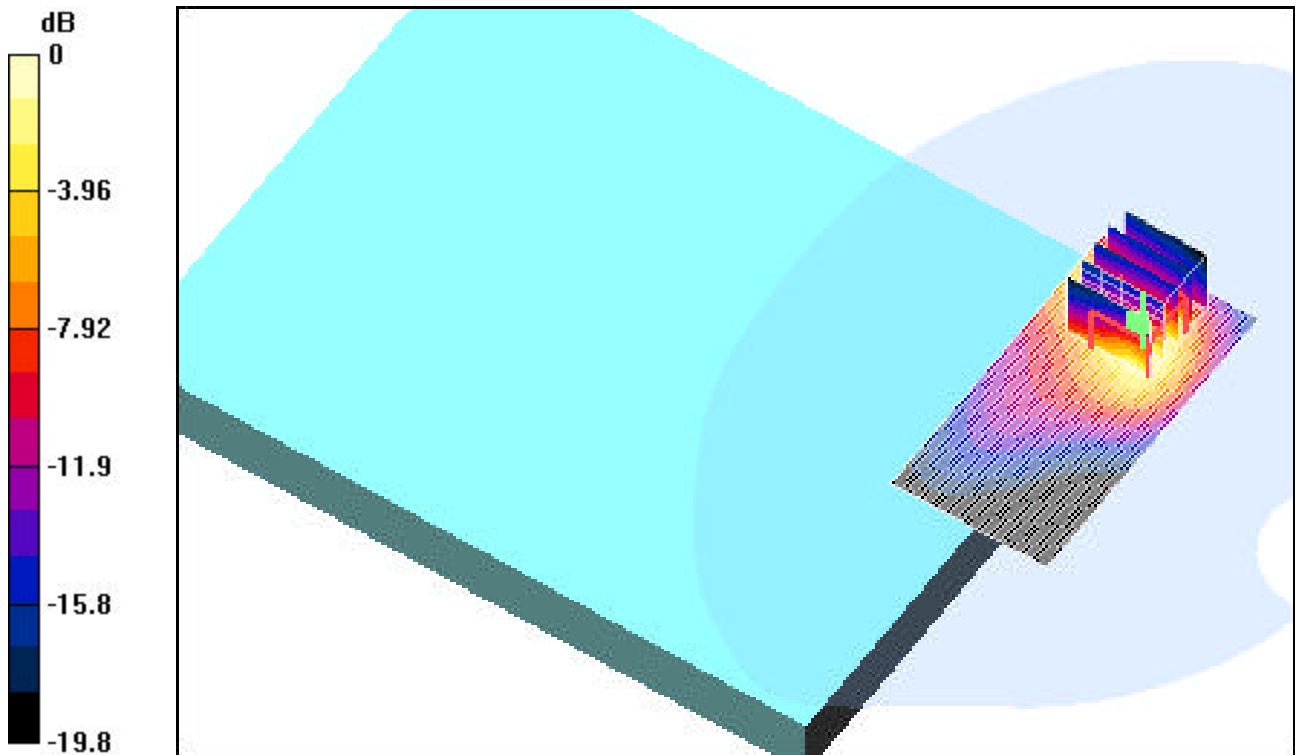

0 dB = 0.780mW/g

PCTEST ENGINEERING LABORATORY, INC.

DUT: CF-W2; Type: Panasonic Notebook PC with WLAN; Serial: 4CKSA00035

Communication System: 2.4GHz WLAN; Frequency: 2437 MHz; Duty Cycle: 1:1

Medium: 2450 Muscle ($\sigma = 1.96$ mho/m, $\epsilon_r = 55.14$, $\rho = 1000$ kg/m³)

Phantom section: Flat Section; Space: 1.5 cm

Test Date: 07-22-2004; Ambient Temp: 23.7°C; Tissue Temp: 21.6°C

Probe: ES3DV2 - SN3022; ConvF(4.2, 4.2, 4.2); Calibrated: 9/23/2003

Sensor-Surface: 3mm (Mechanical Surface Detection)

Electronics: DAE3 Sn455; Calibrated: 1/6/2004

Phantom: SAM 12b; Type: SAM 4.0; Serial: TP:1197

Measurement SW: DASY4, V4.2 Build 44; Postprocessing SW: SEMCAD, V1.8 Build 112

Mode: IEEE 802.11b, Bystander position, ch.06, 11Mbps, Main antenna

Area Scan (41x161x1): Measurement grid: dx=15mm, dy=15mm

Zoom Scan (5x5x7)/Cube 0: Measurement grid: dx=8mm, dy=8mm, dz=5mm

Reference Value = 5.62 V/m

Peak SAR (extrapolated) = 0.852 W/kg

SAR(1 g) = 0.457 mW/g; SAR(10 g) = 0.230 mW/g

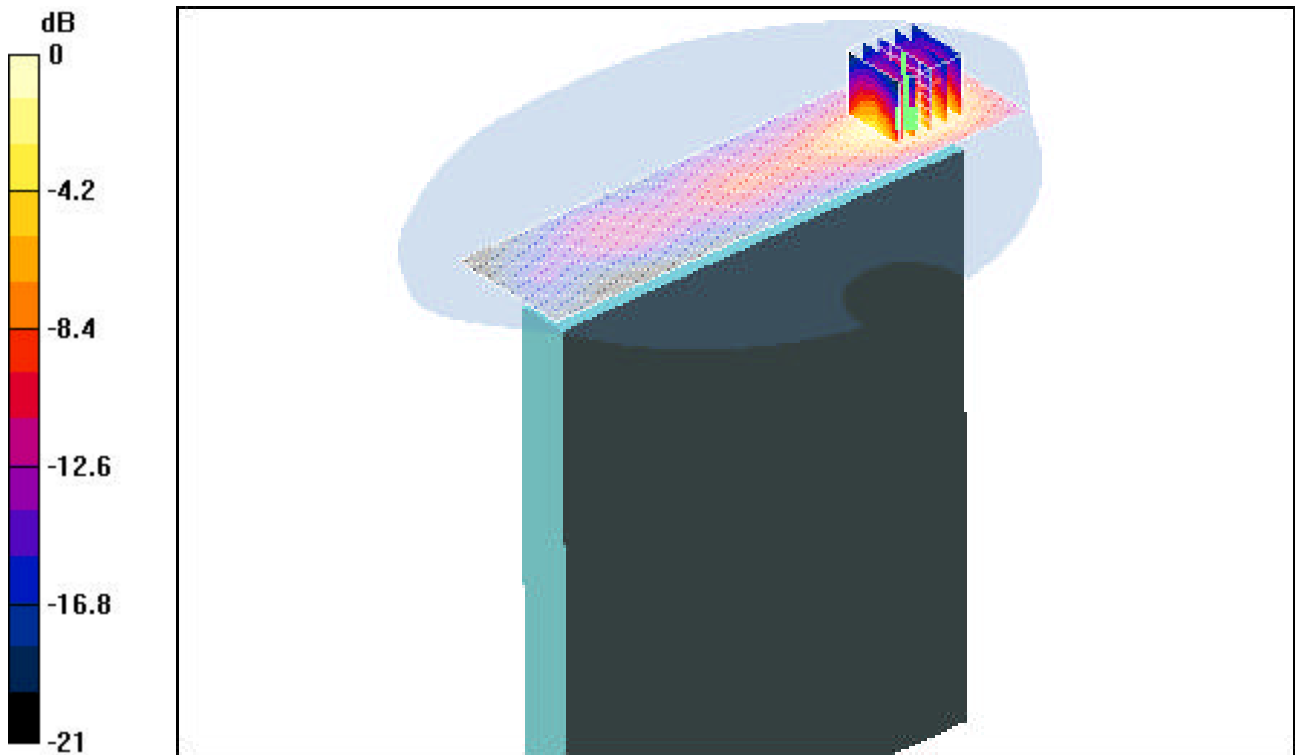

0 dB = 0.585mW/g

PCTEST ENGINEERING LABORATORY, INC.

DUT: CF-W2; Type: Panasonic Notebook PC with WLAN; Serial: 4CKSA00035

Communication System: 2.4GHz WLAN; Frequency: 2412 MHz; Duty Cycle: 1:1

Medium: 2450 Muscle ($\sigma = 1.93$ mho/m, $\epsilon_r = 54.62$, $\rho = 1000$ kg/m³)

Phantom section: Flat Section; Space: 0.0 cm

Test Date: 07-29-2004; Ambient Temp: 23.5°C; Tissue Temp: 21.6°C

Probe: ES3DV2 - SN3022; ConvF(4.2, 4.2, 4.2); Calibrated: 9/23/2003

Sensor-Surface: 3mm (Mechanical Surface Detection)

Electronics: DAE3 Sn330; Calibrated: 6/23/2004

Phantom: SAM 12b; Type: SAM 4.0; Serial: TP:1197

Measurement SW: DASY4, V4.2 Build 44; Postprocessing SW: SEMCAD, V1.8 Build 112

Mode: IEEE 802.11g, Laptop Position, ch.01, 9Mbps, Main antenna

Area Scan (41x81x1): Measurement grid: dx=15mm, dy=15mm

Zoom Scan (5x5x7)/Cube 0: Measurement grid: dx=8mm, dy=8mm, dz=5mm

Reference Value = 6.52 V/m

Peak SAR (extrapolated) = 0.910 W/kg

SAR(1 g) = 0.459 mW/g; SAR(10 g) = 0.229 mW/g

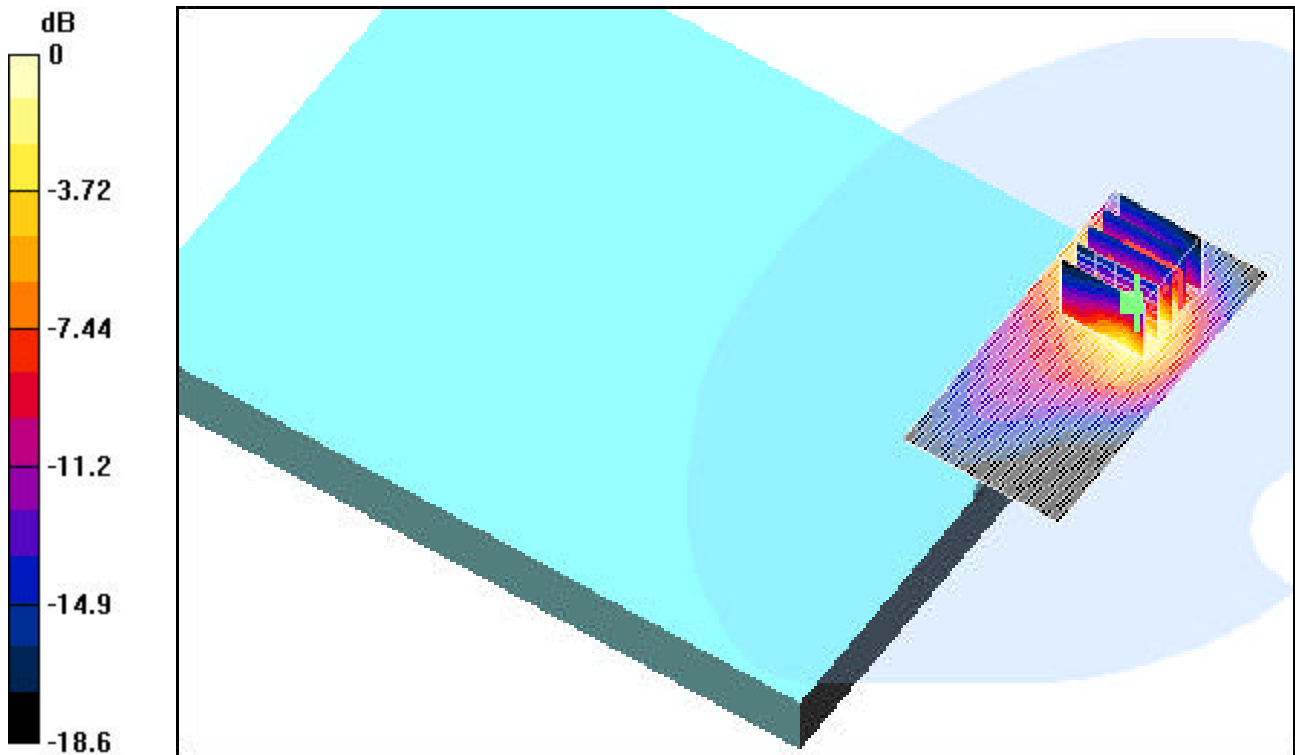

0 dB = 0.575mW/g

PCTEST ENGINEERING LABORATORY, INC.

DUT: CF-W2; Type: Panasonic Notebook PC with WLAN; Serial: 4CKSA00035

Communication System: 2.4GHz WLAN; Frequency: 2437 MHz; Duty Cycle: 1:1

Medium: 2450 Muscle ($\sigma = 1.96$ mho/m, $\epsilon_r = 55.14$, $\rho = 1000$ kg/m³)

Phantom section: Flat Section; Space: 1.5 cm

Test Date: 07-22-2004; Ambient Temp: 23.7°C; Tissue Temp: 21.6°C

Probe: ES3DV2 - SN3022; ConvF(4.2, 4.2, 4.2); Calibrated: 9/23/2003

Sensor-Surface: 3mm (Mechanical Surface Detection)

Electronics: DAE3 Sn455; Calibrated: 1/6/2004

Phantom: SAM 12b; Type: SAM 4.0; Serial: TP:1197

Measurement SW: DASY4, V4.2 Build 44; Postprocessing SW: SEMCAD, V1.8 Build 112

Mode: IEEE 802.11g, Bystander position, ch.06, 9Mbps, Main antenna

Area Scan (41x161x1): Measurement grid: dx=15mm, dy=15mm

Zoom Scan (5x5x7)/Cube 0: Measurement grid: dx=8mm, dy=8mm, dz=5mm

Reference Value = 3.9 V/m

Peak SAR (extrapolated) = 0.360 W/kg

SAR(1 g) = 0.191 mW/g; SAR(10 g) = 0.099 mW/g

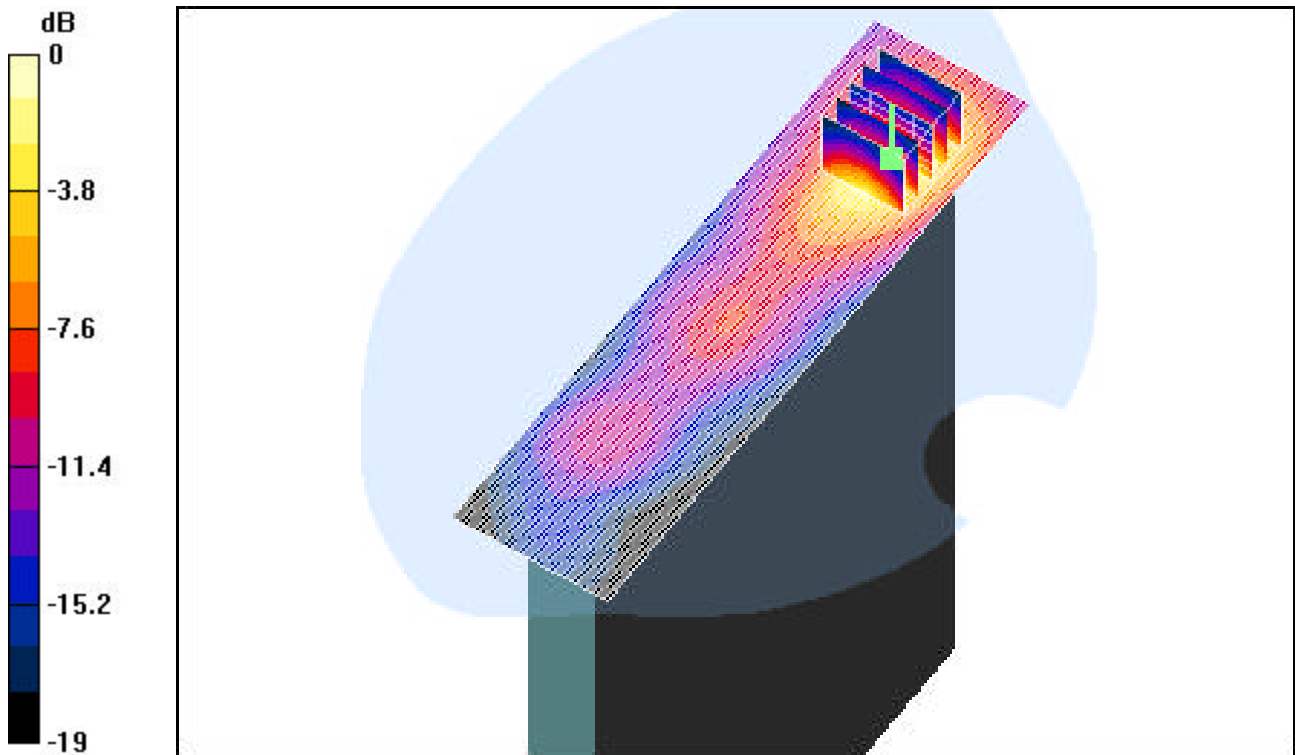

0 dB = 0.241mW/g

PCTEST ENGINEERING LABORATORY, INC.

DUT: CF-W2; Type: Panasonic Notebook PC with WLAN; Serial: 4CKSA00035

Communication System: IEEE 802.11a WLAN; Frequency: 5320 MHz; Duty Cycle: 1:1

Medium: 5300 Muscle ($\sigma = 5.2$ mho/m, $\epsilon_r = 47.16$, $\rho = 1000$ kg/m³)

Phantom section: Flat Section; Space: 0.0 cm

Test Date: 07-22-2004; Ambient Temp: 23.4°C; Tissue Temp: 22.4°C

Probe: ES3DV2 - SN3022; ConvF(1.8, 1.8, 1.8); Calibrated: 9/23/2003

Sensor-Surface: 3mm (Mechanical Surface Detection)

Electronics: DAE3 Sn455; Calibrated: 1/6/2004

Phantom: SAM 12b; Type: SAM 4.0; Serial: TP:1197

Measurement SW: DASY4, V4.2 Build 44; Postprocessing SW: SEMCAD, V1.8 Build 112

Mode: IEEE 802.11a, Laptop position, ch.64, 12Mbps, Main antenna

Area Scan (61x101x1): Measurement grid: dx=10mm, dy=10mm

Zoom Scan (8x8x8)/Cube 0: Measurement grid: dx=4.3mm, dy=4.3mm, dz=3mm

Reference Value = 5.29 V/m

Peak SAR (extrapolated) = 4.01 W/kg

SAR(1 g) = 1.07 mW/g; SAR(10 g) = 0.356 mW/g

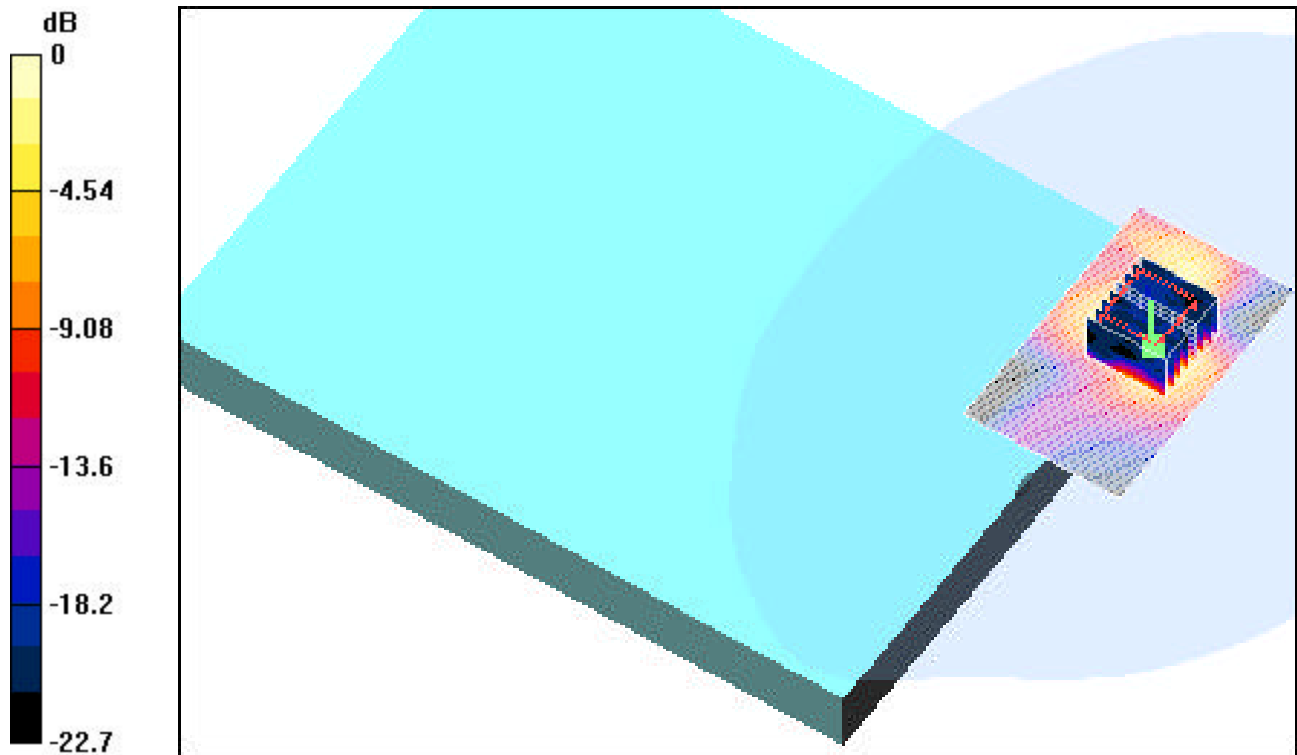

0 dB = 1.5mW/g

PCTEST ENGINEERING LABORATORY, INC.

DUT: CF-W2; Type: Panasonic Notebook PC with WLAN; Serial: 4CKSA00035

Communication System: IEEE 802.11a WLAN; Frequency: 5320 MHz; Duty Cycle: 1:1

Medium: 5300 Muscle ($\sigma = 5.2$ mho/m, $\epsilon_r = 47.16$, $\rho = 1000$ kg/m³)

Phantom section: Flat Section; Space: 1.5 cm

Test Date: 07-22-2004; Ambient Temp: 23.4°C; Tissue Temp: 22.4°C

Probe: ES3DV2 - SN3022; ConvF(1.8, 1.8, 1.8); Calibrated: 9/23/2003

Sensor-Surface: 3mm (Mechanical Surface Detection)

Electronics: DAE3 Sn455; Calibrated: 1/6/2004

Phantom: SAM 12b; Type: SAM 4.0; Serial: TP:1197

Measurement SW: DASY4, V4.2 Build 44; Postprocessing SW: SEMCAD, V1.8 Build 112

Mode: IEEE 802.11a, Bystander position, ch.64, 12Mbps, Main antenna

Area Scan (51x121x1): Measurement grid: dx=10mm, dy=10mm

Zoom Scan (8x8x8)/Cube 0: Measurement grid: dx=4.3mm, dy=4.3mm, dz=3mm

Reference Value = 5.06 V/m

Peak SAR (extrapolated) = 4.13 W/kg

SAR(1 g) = 1.2 mW/g; SAR(10 g) = 0.410 mW/g

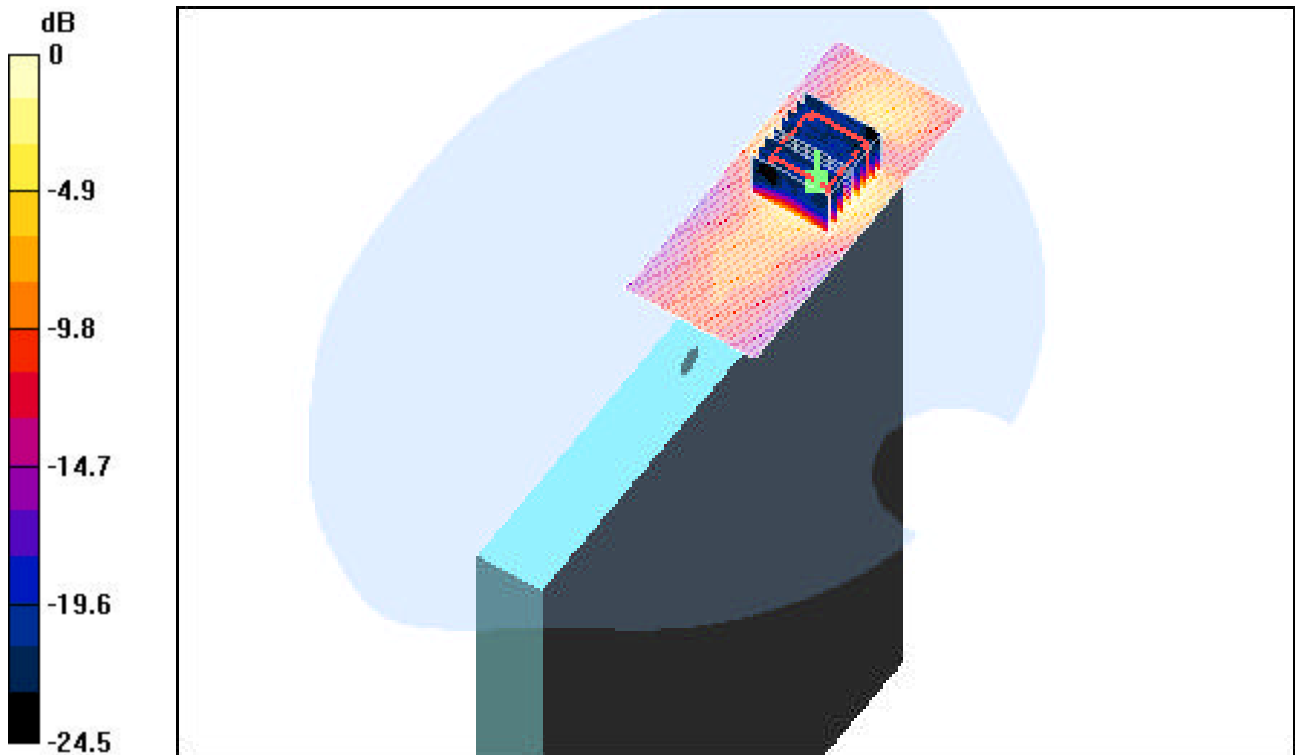

0 dB = 1.67mW/g

PCTEST ENGINEERING LABORATORY, INC.

DUT: CF-W2; Type: Panasonic Notebook PC with WLAN; Serial: 4CKSA00035

Communication System: IEEE 802.11a WLAN; Frequency: 5785 MHz; Duty Cycle: 1:1

Medium: 5800 Muscle ($\sigma = 5.72$ mho/m, $\epsilon_r = 46.82$, $\rho = 1000$ kg/m³)

Phantom section: Flat Section; Space: 0.0 cm

Test Date: 07-22-2004; Ambient Temp: 23.4°C; Tissue Temp: 22.4°C

Probe: ES3DV2 - SN3022; ConvF(1.57, 1.57, 1.57); Calibrated: 9/23/2003

Sensor-Surface: 3mm (Mechanical Surface Detection)

Electronics: DAE3 Sn455; Calibrated: 1/6/2004

Phantom: SAM 12b; Type: SAM 4.0; Serial: TP:1197

Measurement SW: DASY4, V4.2 Build 44; Postprocessing SW: SEMCAD, V1.8 Build 112

Mode: IEEE 802.11a, Laptop position, ch.157, 12Mbps, Main antenna

Area Scan (61x101x1): Measurement grid: dx=10mm, dy=10mm

Zoom Scan (8x8x8)/Cube 0: Measurement grid: dx=4.3mm, dy=4.3mm, dz=3mm

Reference Value = 2.98 V/m

Peak SAR (extrapolated) = 1.42 W/kg

SAR(1 g) = 0.298 mW/g; SAR(10 g) = 0.121 mW/g



0 dB = 0.402mW/g

PCTEST ENGINEERING LABORATORY, INC.

DUT: CF-W2; Type: Panasonic Notebook PC with WLAN; Serial: 4CKSA00035

Communication System: IEEE 802.11a WLAN; Frequency: 5785 MHz; Duty Cycle: 1:1

Medium: 5800 Muscle ($\sigma = 5.72$ mho/m, $\epsilon_r = 46.82$, $\rho = 1000$ kg/m³)

Phantom section: Flat Section; Space: 1.5 cm

Test Date: 07-22-2004; Ambient Temp: 23.0°C; Tissue Temp: 21.9°C

Probe: ES3DV2 - SN3022; ConvF(1.57, 1.57, 1.57); Calibrated: 9/23/2003

Sensor-Surface: 3mm (Mechanical Surface Detection)

Electronics: DAE3 Sn455; Calibrated: 1/6/2004

Phantom: SAM 12b; Type: SAM 4.0; Serial: TP:1197

Measurement SW: DASY4, V4.2 Build 44; Postprocessing SW: SEMCAD, V1.8 Build 112

Mode: IEEE 802.11a, Bystander position, ch.157, 12Mbps, Main antenna

Area Scan (51x101x1): Measurement grid: dx=10mm, dy=10mm

Zoom Scan (8x8x8)/Cube 0: Measurement grid: dx=4.3mm, dy=4.3mm, dz=3mm

Reference Value = 3.39 V/m

Peak SAR (extrapolated) = 0.764 W/kg

SAR(1 g) = 0.201 mW/g; SAR(10 g) = 0.079 mW/g

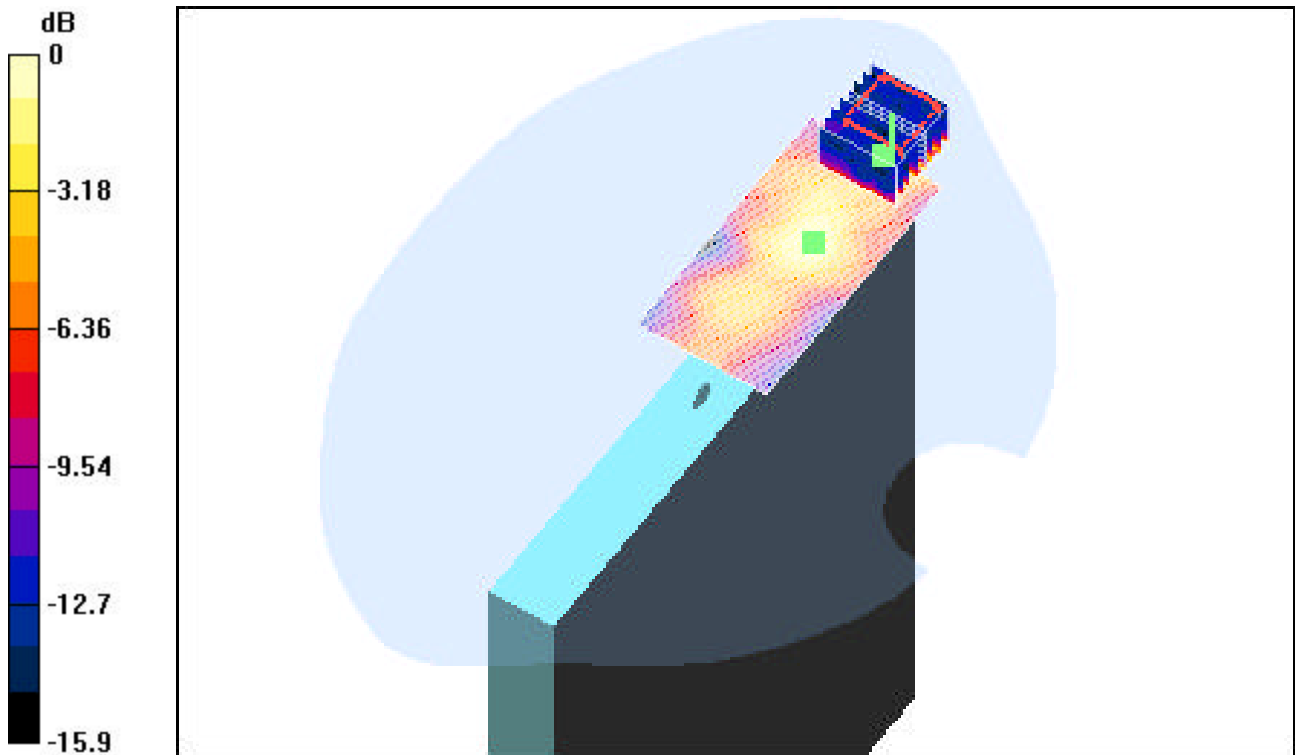

PCTEST ENGINEERING LABORATORY, INC.

DUT: CF-W2; Type: Panasonic Notebook PC with WLAN; Serial: 4CKSA00035

Communication System: 2.4GHz WLAN; Frequency: 2437 MHz; Duty Cycle: 1:1

Medium: 2450 Muscle ($\sigma = 1.93$ mho/m, $\epsilon_r = 54.62$, $\rho = 1000$ kg/m³)

Phantom section: Flat Section; Space: 0.0 cm

Test Date: 07-29-2004; Ambient Temp: 23.5°C; Tissue Temp: 21.6°C

Probe: ES3DV2 - SN3022; ConvF(4.2, 4.2, 4.2); Calibrated: 9/23/2003

Sensor-Surface: 3mm (Mechanical Surface Detection)

Electronics: DAE3 Sn330; Calibrated: 6/23/2004

Phantom: SAM 12b; Type: SAM 4.0; Serial: TP:1197

Measurement SW: DASY4, V4.2 Build 44; Postprocessing SW: SEMCAD, V1.8 Build 112

Mode: IEEE 802.11b, Laptop Position, ch.06, 11Mbps, Main antenna

Area Scan (41x81x1): Measurement grid: dx=15mm, dy=15mm

Zoom Scan (5x5x7)/Cube 0: Measurement grid: dx=8mm, dy=8mm, dz=5mm

Reference Value = 7.35 V/m

Peak SAR (extrapolated) = 1.18 W/kg

SAR(1 g) = 0.590 mW/g; SAR(10 g) = 0.292 mW/g

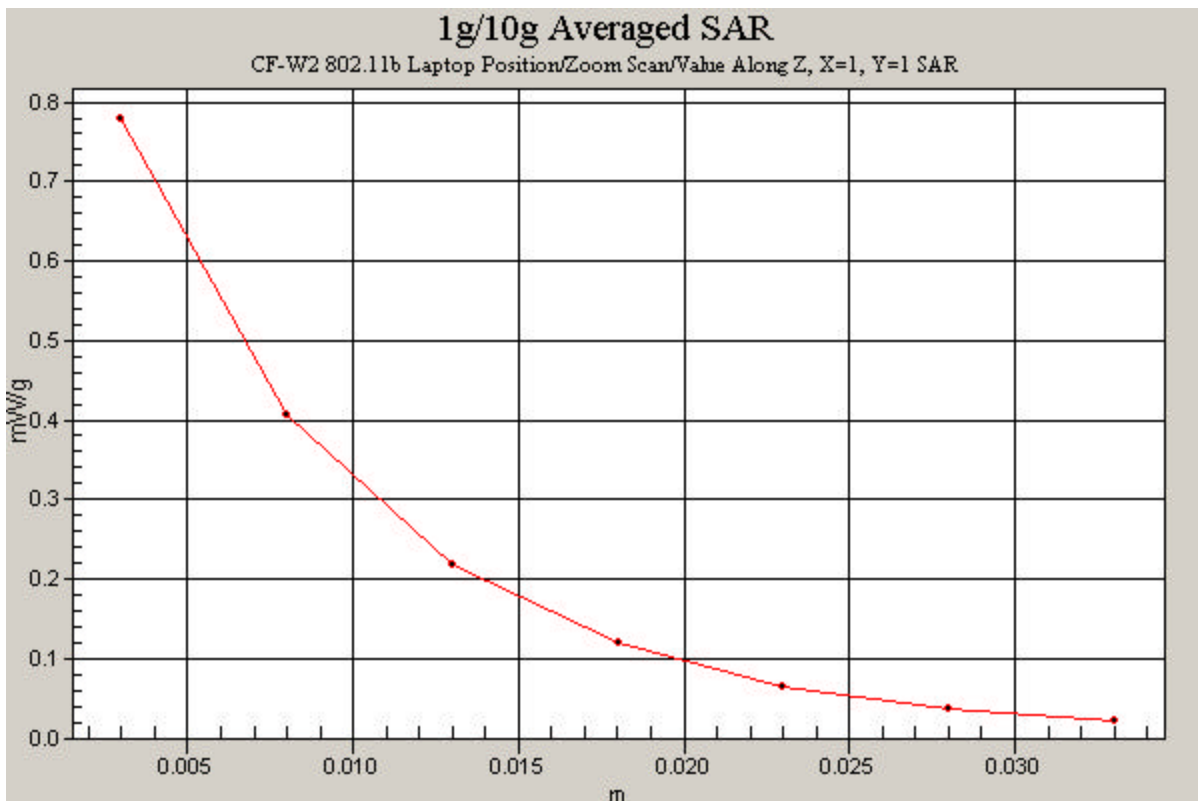

PCTEST ENGINEERING LABORATORY, INC.

DUT: CF-W2; Type: Panasonic Notebook PC with WLAN; Serial: 4CKSA00035

Communication System: IEEE 802.11a WLAN; Frequency: 5320 MHz; Duty Cycle: 1:1

Medium: 5300 Muscle ($\sigma = 5.2$ mho/m, $\epsilon_r = 47.16$, $\rho = 1000$ kg/m³)

Phantom section: Flat Section; Space: 1.5 cm

Test Date: 07-22-2004; Ambient Temp: 23.4°C; Tissue Temp: 22.4°C

Probe: ES3DV2 - SN3022; ConvF(1.8, 1.8, 1.8); Calibrated: 9/23/2003

Sensor-Surface: 3mm (Mechanical Surface Detection)

Electronics: DAE3 Sn455; Calibrated: 1/6/2004

Phantom: SAM 12b; Type: SAM 4.0; Serial: TP:1197

Measurement SW: DASY4, V4.2 Build 44; Postprocessing SW: SEMCAD, V1.8 Build 112

Mode: IEEE 802.11a, Bystander position, ch.64, 12Mbps, Main antenna

Area Scan (51x121x1): Measurement grid: dx=10mm, dy=10mm

Zoom Scan (8x8x8)/Cube 0: Measurement grid: dx=4.3mm, dy=4.3mm, dz=3mm

Reference Value = 5.06 V/m

Peak SAR (extrapolated) = 4.13 W/kg

SAR(1 g) = 1.2 mW/g; SAR(10 g) = 0.410 mW/g

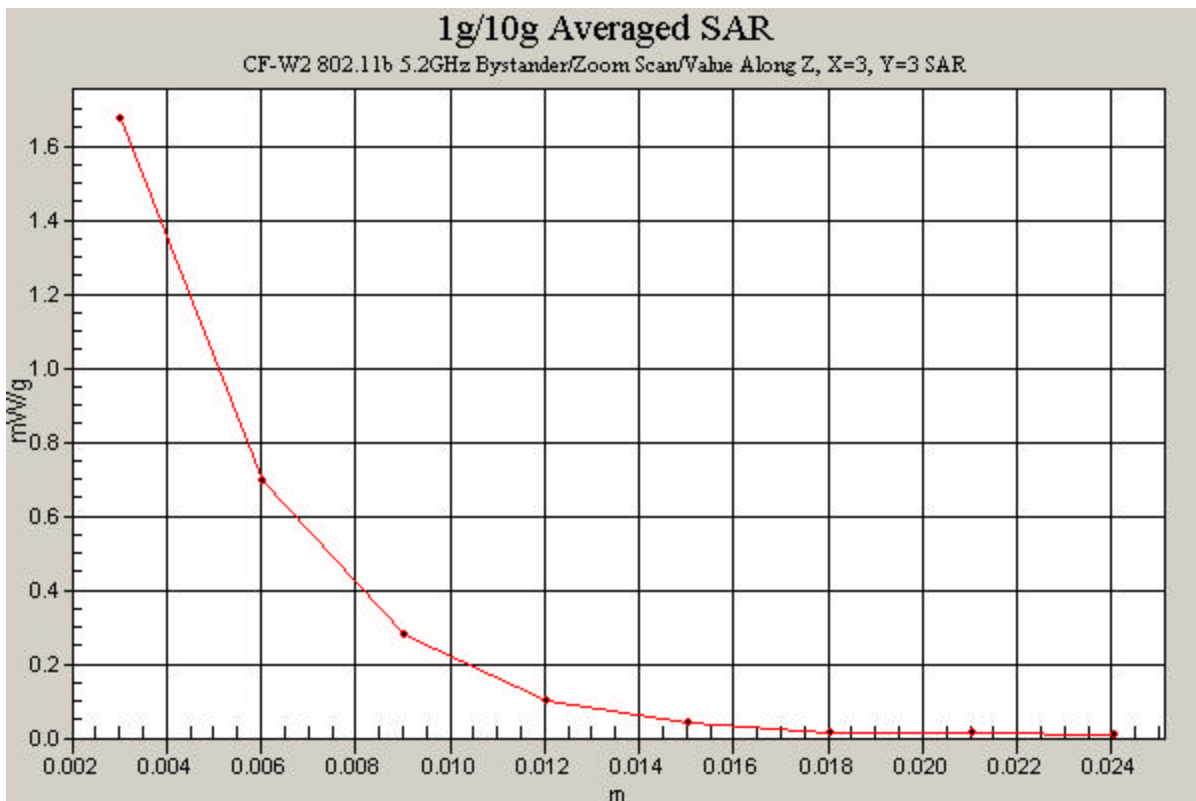

PCTEST ENGINEERING LABORATORY, INC.

DUT: CF-W2; Type: Panasonic Notebook PC with WLAN; Serial: 4CKSA00035

Communication System: IEEE 802.11a WLAN; Frequency: 5785 MHz; Duty Cycle: 1:1

Medium: 5800 Muscle ($\sigma = 5.72$ mho/m, $\epsilon_r = 46.82$, $\rho = 1000$ kg/m³)

Phantom section: Flat Section; Space: 0.0 cm

Test Date: 07-22-2004; Ambient Temp: 23.0°C; Tissue Temp: 21.9°C

Probe: ES3DV2 - SN3022; ConvF(1.57, 1.57, 1.57); Calibrated: 9/23/2003

Sensor-Surface: 3mm (Mechanical Surface Detection)

Electronics: DAE3 Sn455; Calibrated: 1/6/2004

Phantom: SAM 12b; Type: SAM 4.0; Serial: TP:1197

Measurement SW: DASY4, V4.2 Build 44; Postprocessing SW: SEMCAD, V1.8 Build 112

Mode: IEEE 802.11a, Laptop position, ch.157, 12Mbps, Main antenna

Area Scan (61x101x1): Measurement grid: dx=10mm, dy=10mm

Zoom Scan (8x8x8)/Cube 0: Measurement grid: dx=4.3mm, dy=4.3mm, dz=3mm

Reference Value = 2.98 V/m

Peak SAR (extrapolated) = 1.42 W/kg

SAR(1 g) = 0.298 mW/g; SAR(10 g) = 0.121 mW/g

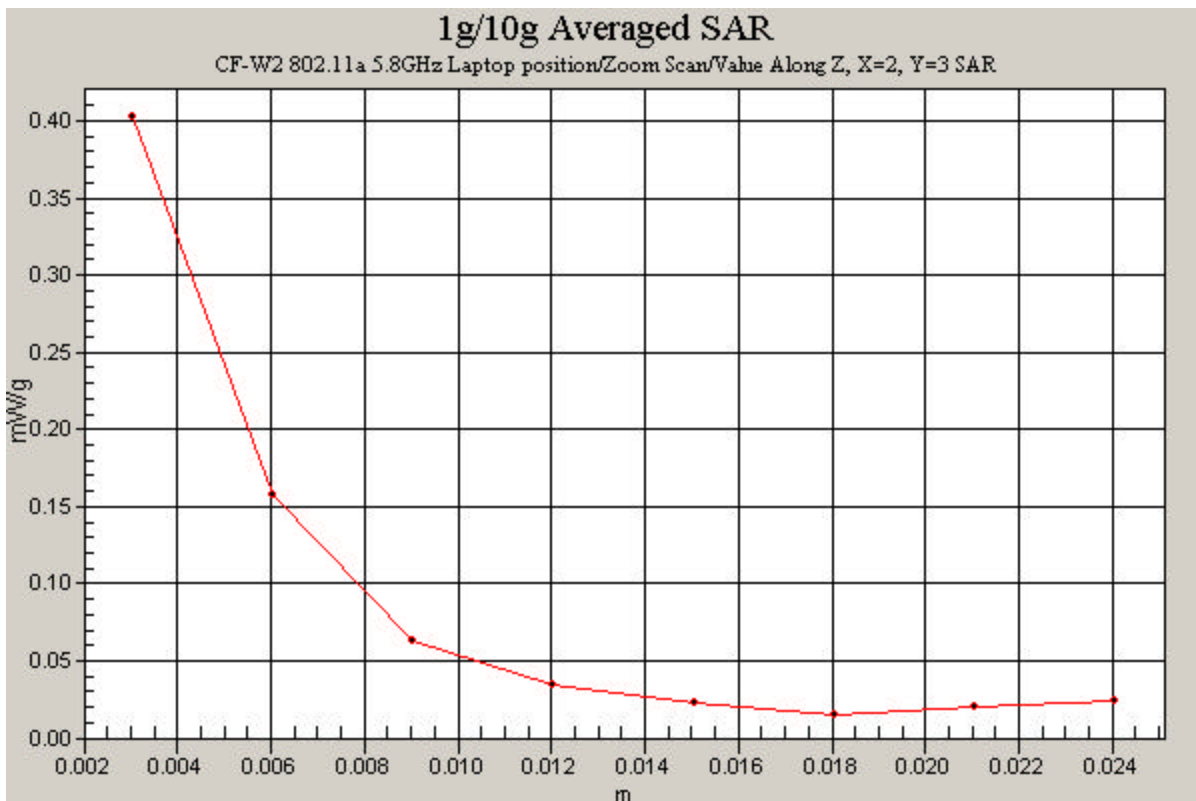

APPENDIX B: DIPOLE VALIDATION

PCTEST ENGINEERING LABORATORY, INC.

DUT: Dipole 2450 MHz; Type: D2450V2; Serial: D2450V2 - SN:719

Communication System: CW; Frequency: 2450 MHz; Duty Cycle: 1:1

Medium: 2450 Brain ($\sigma = 1.85$ mho/m, $\epsilon_r = 40.3$, $\rho = 1000$ kg/m³)

Phantom section: Flat Section; Space: 1.0 cm

Test Date: 07-20-2004; Ambient Temp: 23.1°C; Tissue Temp: 21.2°C

Probe: ES3DV2 - SN3022; ConvF(4.5, 4.5, 4.5); Calibrated: 9/23/2003

Sensor-Surface: 3mm (Mechanical Surface Detection)

Electronics: DAE3 Sn455; Calibrated: 1/6/2004

Phantom: SAM 12b; Type: SAM 4.0; Serial: TP:1197

Measurement SW: DASY4, V4.2 Build 44; Postprocessing SW: SEMCAD, V1.8 Build 112

2450 MHz Dipole Validation

Area Scan (41x51x1): Measurement grid: dx=15mm, dy=15mm

Zoom Scan (7x7x7)/Cube 0: Measurement grid: dx=5mm, dy=5mm, dz=5mm

Input Power = 24.0 dBm (250 mW)

SAR(1 g) = 12.9 mW/g; SAR(10 g) = 5.98 mW/g

Target SAR(1g) = 13.1 mW/g; Deviation = -1.52 %

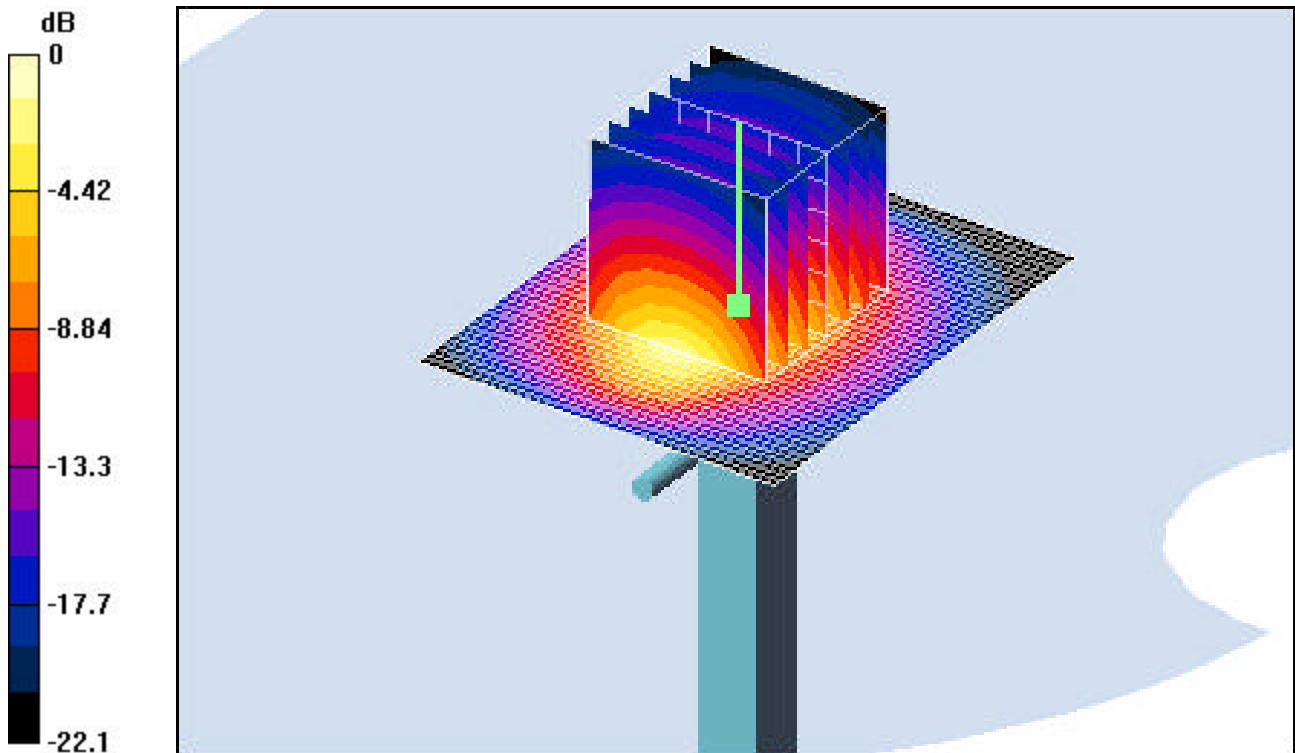

0 dB = 17mW/g

PCTEST ENGINEERING LABORATORY, INC.

DUT: Dipole 2450 MHz; Type: D2450V2; Serial: D2450V2 - SN:719

Communication System: CW; Frequency: 2450 MHz; Duty Cycle: 1:1

Medium: 2450 Brain ($\sigma = 1.85$ mho/m, $\epsilon_r = 40.3$, $\rho = 1000$ kg/m³)

Phantom section: Flat Section; Space: 1.0 cm

Test Date: 07-21-2004; Ambient Temp: 23.4°C; Tissue Temp: 21.2°C

Probe: ES3DV2 - SN3022; ConvF(4.5, 4.5, 4.5); Calibrated: 9/23/2003

Sensor-Surface: 3mm (Mechanical Surface Detection)

Electronics: DAE3 Sn455; Calibrated: 1/6/2004

Phantom: SAM 12b; Type: SAM 4.0; Serial: TP:1197

Measurement SW: DASY4, V4.2 Build 44; Postprocessing SW: SEMCAD, V1.8 Build 112

2450 MHz Dipole Validation

Area Scan (51x61x1): Measurement grid: dx=15mm, dy=15mm

Zoom Scan (7x7x7)/Cube 0: Measurement grid: dx=5mm, dy=5mm, dz=5mm

Input Power = 24.0 dBm (250 mW)

SAR(1 g) = 12.6 mW/g; SAR(10 g) = 5.8 mW/g

Target SAR(1g) = 13.1 mW/g; Deviation = -3.81 %

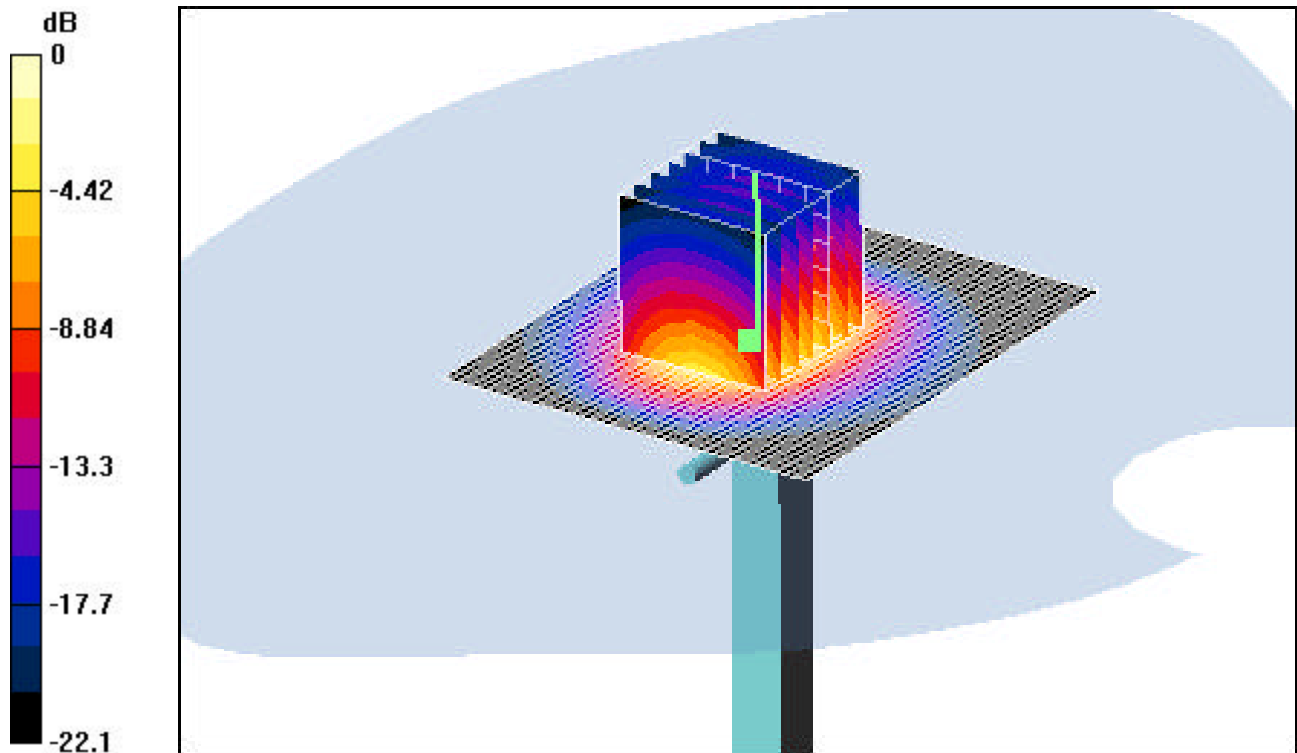

0 dB = 16.5mW/g

PCTEST ENGINEERING LABORATORY, INC.

DUT: Dipole 2450 MHz; Type: D2450V2; Serial: D2450V2 - SN:719

Communication System: CW; Frequency: 2450 MHz; Duty Cycle: 1:1

Medium: 2450 Brain ($\sigma = 1.85$ mho/m, $\epsilon_r = 40.3$, $\rho = 1000$ kg/m³)

Phantom section: Flat Section; Space: 1.0 cm

Test Date: 07-22-2004; Ambient Temp: 23.5°C; Tissue Temp: 21.8°C

Probe: ES3DV2 - SN3022; ConvF(4.5, 4.5, 4.5); Calibrated: 9/23/2003

Sensor-Surface: 3mm (Mechanical Surface Detection)

Electronics: DAE3 Sn455; Calibrated: 1/6/2004

Phantom: SAM 12b; Type: SAM 4.0; Serial: TP:1197

Measurement SW: DASY4, V4.2 Build 44; Postprocessing SW: SEMCAD, V1.8 Build 112

2450 MHz Dipole Validation

Area Scan (51x51x1): Measurement grid: dx=15mm, dy=15mm

Zoom Scan (7x7x7)/Cube 0: Measurement grid: dx=5mm, dy=5mm, dz=5mm

Input Power = 24.0 dBm (250 mW)

SAR(1 g) = 12.8 mW/g; SAR(10 g) = 5.9 mW/g

Target SAR(1g) = 13.1 mW/g; Deviation = -2.29 %

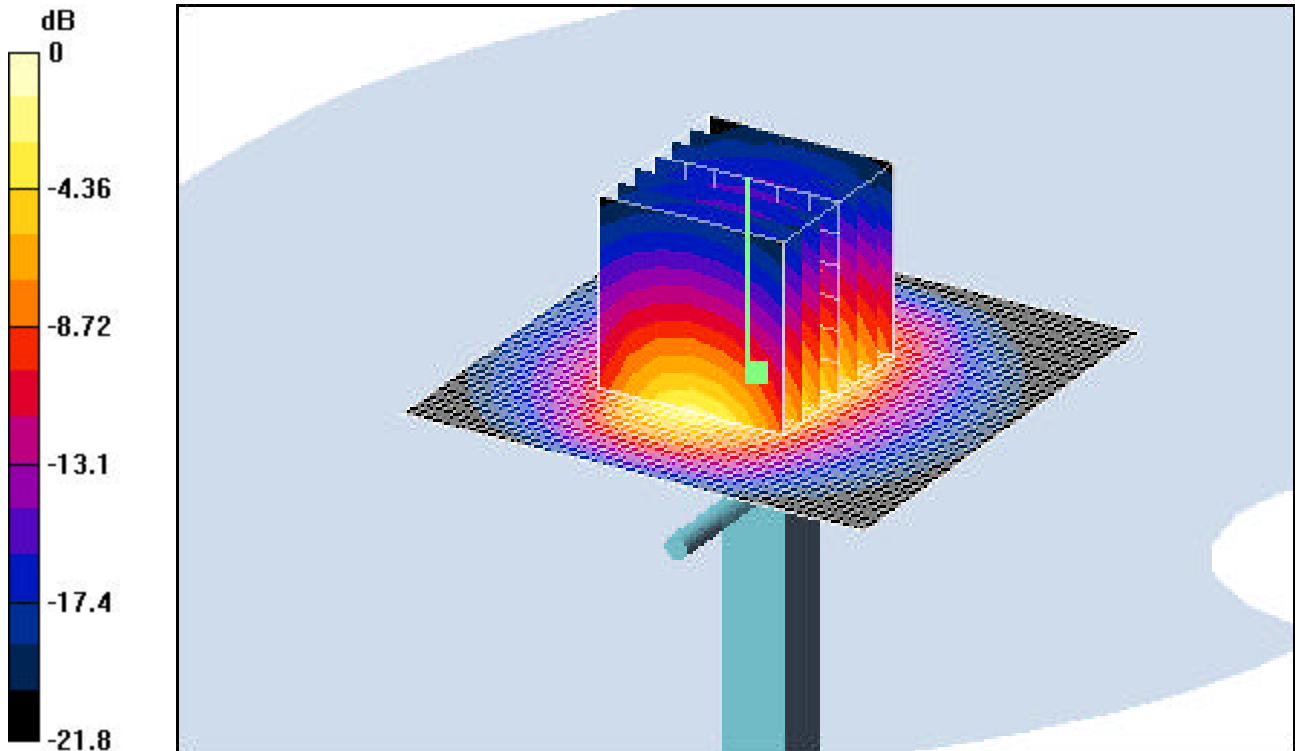

0 dB = 16.8mW/g

PCTEST ENGINEERING LABORATORY, INC.

DUT: Dipole 2450 MHz; Type: D2450V2; Serial: D2450V2 - SN:719

Communication System: CW; Frequency: 2450 MHz; Duty Cycle: 1:1

Medium: 2450 Brain ($\sigma = 1.81$ mho/m, $\epsilon_r = 39.74$, $\rho = 1000$ kg/m³)

Phantom section: Flat Section; Space: 1.0 cm

Test Date: 07-29-2004; Ambient Temp: 23.6°C; Tissue Temp: 21.5°C

Probe: ES3DV2 - SN3022; ConvF(4.5, 4.5, 4.5); Calibrated: 9/23/2003

Sensor-Surface: 3mm (Mechanical Surface Detection)

Electronics: DAE3 Sn330; Calibrated: 6/23/2004

Phantom: SAM 12b; Type: SAM 4.0; Serial: TP:1197

Measurement SW: DASY4, V4.2 Build 44; Postprocessing SW: SEMCAD, V1.8 Build 112

2450 MHz Dipole Validation

Area Scan (51x61x1): Measurement grid: dx=15mm, dy=15mm

Zoom Scan (7x7x7)/Cube 0: Measurement grid: dx=5mm, dy=5mm, dz=5mm

Input Power = 24.0 dBm (250 mW)

SAR(1 g) = 12.9 mW/g; SAR(10 g) = 5.92 mW/g

Target SAR(1g) = 13.1 mW/g; Deviation = -1.52 %

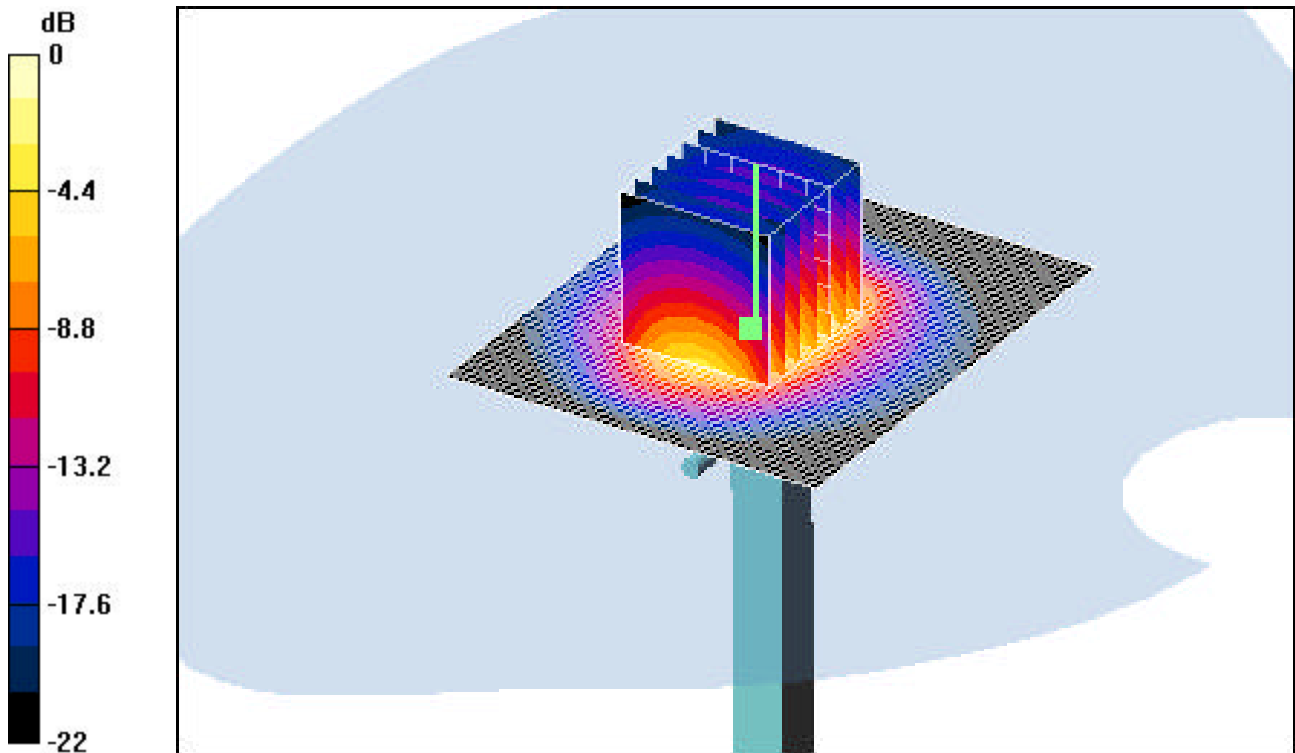

0 dB = 16.8mW/g

PCTEST ENGINEERING LABORATORY, INC.

DUT: Dipole 5800 MHz; Type: D5GHzV2; Serial: 1007

Communication System: CW; Frequency: 5800 MHz; Duty Cycle: 1:1

Medium: 5800 Brain ($\sigma = 5.28$ mho/m, $\epsilon_r = 35.84$, $\rho = 1000$ kg/m³)

Phantom section: Flat Section; Space: 1.0 cm

Test Date: 07-21-2004; Ambient Temp: 23.7°C; Tissue Temp: 21.8°C

Probe: ES3DV2 - SN3022; ConvF(2.15, 2.15, 2.15); Calibrated: 9/23/2003

Sensor-Surface: 3mm (Mechanical Surface Detection)

Electronics: DAE3 Sn455; Calibrated: 1/6/2004

Phantom: SAM 12b; Type: SAM 4.0; Serial: TP:1197

Measurement SW: DASY4, V4.2 Build 44; Postprocessing SW: SEMCAD, V1.8 Build 112

5800 MHz Dipole Validation

Area Scan (51x61x1): Measurement grid: dx=10mm, dy=10mm

Zoom Scan (7x7x8)/Cube 0: Measurement grid: dx=4.3mm, dy=4.3mm, dz=3mm

Input Power = 20.0 dBm (100 mW)

SAR(1 g) = 8.47 mW/g; SAR(10 g) = 2.3 mW/g

Target SAR(1g) = 9.00 mW/g; Deviation = -5.88 %

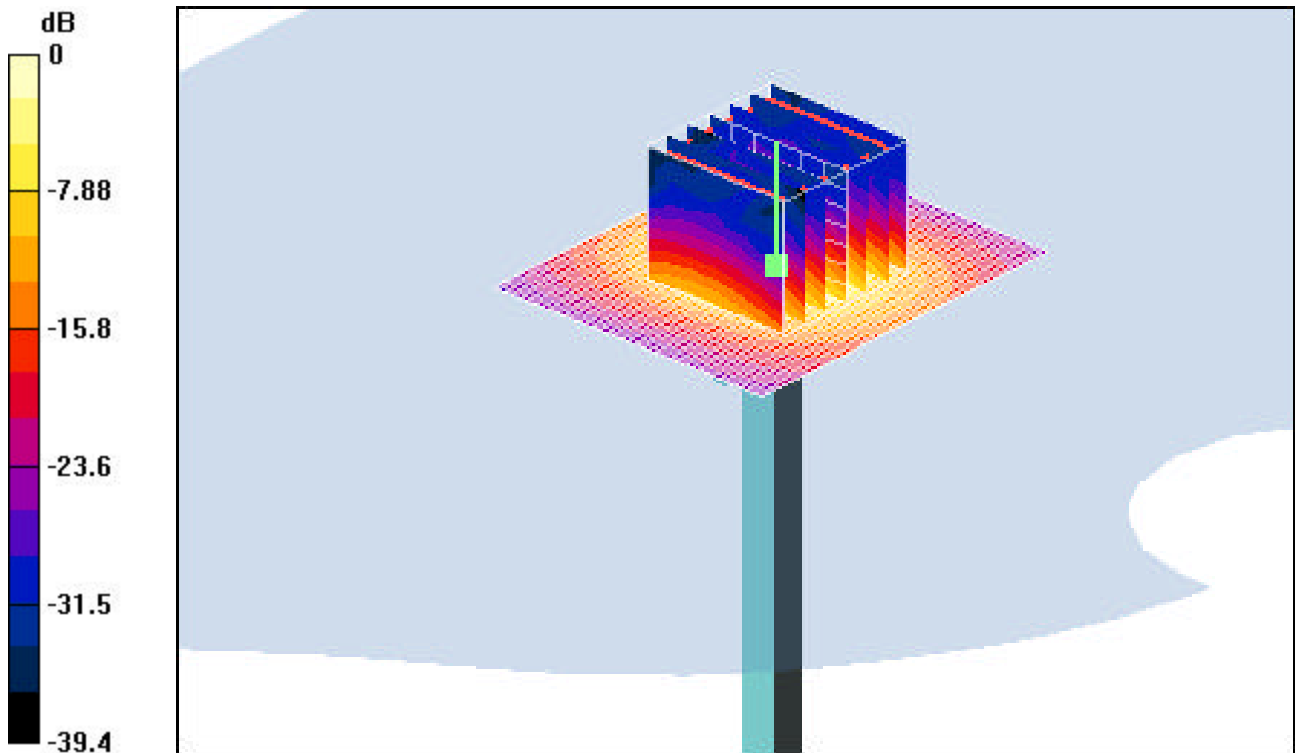

PCTEST ENGINEERING LABORATORY, INC.

DUT: Dipole 5800 MHz; Type: D5GHzV2; Serial: 1007

Communication System: CW; Frequency: 5800 MHz; Duty Cycle: 1:1

Medium: 5800 Brain ($\sigma = 5.28$ mho/m, $\epsilon_r = 35.84$, $\rho = 1000$ kg/m³)

Phantom section: Flat Section; Space: 1.0 cm

Test Date: 07-22-2004; Ambient Temp: 23.4°C; Tissue Temp: 21.2°C

Probe: ES3DV2 - SN3022; ConvF(2.15, 2.15, 2.15); Calibrated: 9/23/2003

Sensor-Surface: 3mm (Mechanical Surface Detection)

Electronics: DAE3 Sn455; Calibrated: 1/6/2004

Phantom: SAM 12b; Type: SAM 4.0; Serial: TP:1197

Measurement SW: DASY4, V4.2 Build 44; Postprocessing SW: SEMCAD, V1.8 Build 112

5800 MHz Dipole Validation

Area Scan (61x61x1): Measurement grid: dx=10mm, dy=10mm

Zoom Scan (7x7x8)/Cube 0: Measurement grid: dx=4.3mm, dy=4.3mm, dz=3mm

Input Power = 20.0 dBm (100 mW)

SAR(1 g) = 8.57 mW/g; SAR(10 g) = 2.33 mW/g

Target SAR(1g) = 9.00 mW/g; Deviation = -4.77 %

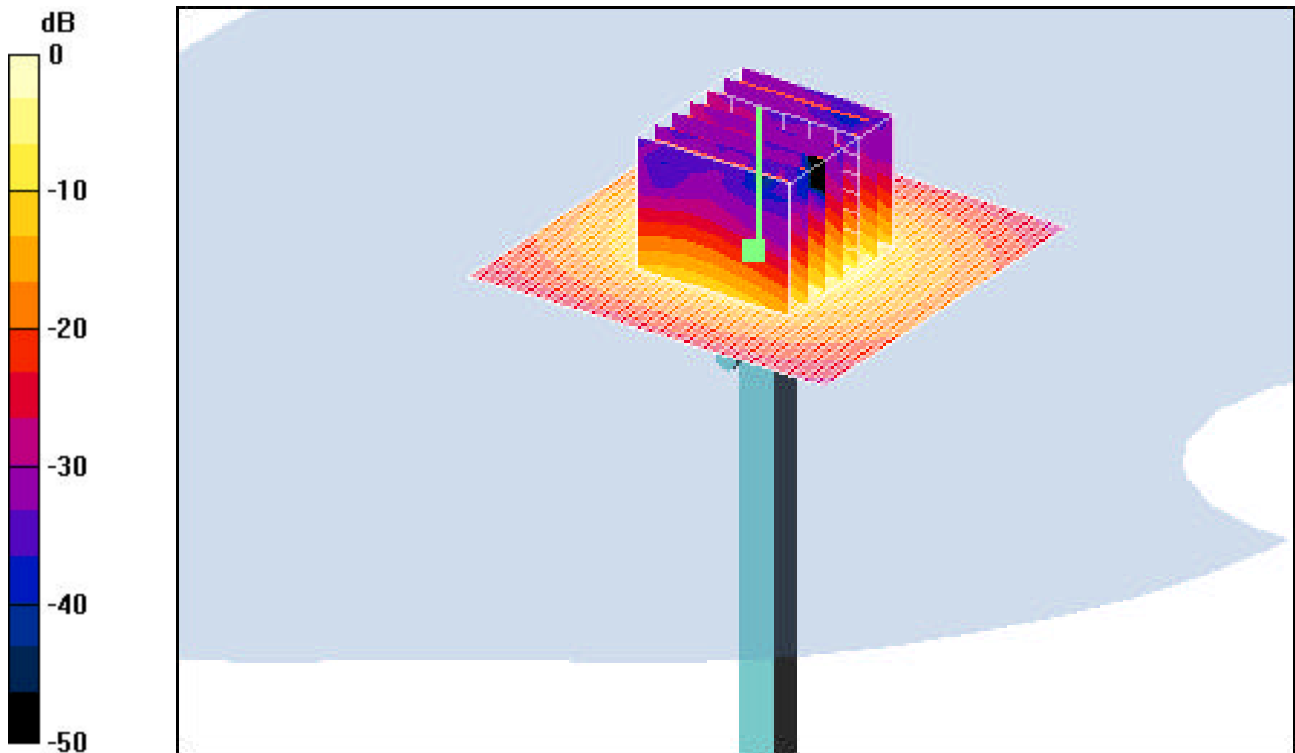

0 dB = 11.4mW/g

APPENDIX C: PROBE CALIBRATION

Client **PC Test**

CALIBRATION CERTIFICATE



Object(s) **ES3DV2 - SN:3022**
 Calibration procedure(s) **QA CAL-01 v2
Calibration procedure for dosimetric E-field probes**
 Calibration date: **September 23, 2003**
 Condition of the calibrated item **In Tolerance (according to the specific calibration document)**

This calibration statement documents traceability of M&TE used in the calibration procedures and conformity of the procedures with the ISO/IEC 17025 international standard.

All calibrations have been conducted in the closed laboratory facility: environment temperature 22 +/- 2 degrees Celsius and humidity < 75%.

Calibration Equipment used (M&TE critical for calibration)

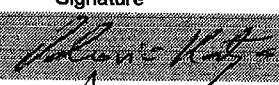
Model Type	ID #	Cal Date (Calibrated by, Certificate No.)	Scheduled Calibration
Power meter EPM E4419B	GB41293874	2-Apr-03 (METAS, No 252-0250)	Apr-04
Power sensor E4412A	MY41495277	2-Apr-03 (METAS, No 252-0250)	Apr-04
Reference 20 dB Attenuator	SN: 5086 (20b)	3-Apr-03 (METAS No. 251-0340)	Apr-04
Fluke Process Calibrator Type 702	SN: 6295803	8-Sep-03 (Sintrel SCS No. E-030020)	Sep-04
Power sensor HP 8481A	MY41092180	18-Sep-02 (Agilent, No. 20020918)	In house check: Oct 03
RF generator HP 8684C	US3642U01700	4-Aug-99 (SPEAG, in house check Aug-02)	In house check: Aug-05
Network Analyzer HP 8753E	US37390585	18-Oct-01 (Agilent, No. 24BR1033101)	In house check: Oct 03

	Name	Function	Signature
Calibrated by:	Katja Pokovic	Laboratory Director	
Approved by:	Niels Kuster	Quality Manager	

Date issued: October 5, 2003

This calibration certificate is issued as an intermediate solution until the accreditation process (based on ISO/IEC 17025 International Standard) for Calibration Laboratory of Schmid & Partner Engineering AG is completed.

Probe ES3DV2

SN:3022

Manufactured: April 15, 2003
Last calibration: September 23, 2003

Calibrated for DASY Systems

(Note: non-compatible with DASY2 system!)

DASY - Parameters of Probe: ES3DV2 SN:3022

Sensitivity in Free Space

NormX	1.00 $\mu\text{V}/(\text{V}/\text{m})^2$
NormY	1.04 $\mu\text{V}/(\text{V}/\text{m})^2$
NormZ	0.98 $\mu\text{V}/(\text{V}/\text{m})^2$

Diode Compression

DCP X	95	mV
DCP Y	95	mV
DCP Z	95	mV

Sensitivity in Tissue Simulating Liquid

Head **900 MHz** $\epsilon_r = 41.5 \pm 5\%$ $\sigma = 0.97 \pm 5\%$ mho/m
 Valid for f=800-1000 MHz with Head Tissue Simulating Liquid according to EN 50361, P1528-200X

ConvF X	6.1 $\pm 9.5\%$ (k=2)	Boundary effect:
ConvF Y	6.1 $\pm 9.5\%$ (k=2)	Alpha 0.32
ConvF Z	6.1 $\pm 9.5\%$ (k=2)	Depth 1.65

Head **1800 MHz** $\epsilon_r = 40.0 \pm 5\%$ $\sigma = 1.40 \pm 5\%$ mho/m
 Valid for f=1710-1910 MHz with Head Tissue Simulating Liquid according to EN 50361, P1528-200X

ConvF X	5.0 $\pm 9.5\%$ (k=2)	Boundary effect:
ConvF Y	5.0 $\pm 9.5\%$ (k=2)	Alpha 0.25
ConvF Z	5.0 $\pm 9.5\%$ (k=2)	Depth 2.30

Boundary Effect

Head **900 MHz** Typical SAR gradient: 5 % per mm

Probe Tip to Boundary		1 mm	2 mm
SAR _{be} [%] Without Correction Algorithm		5.5	2.5
SAR _{be} [%] With Correction Algorithm		0.1	0.4

Head **1800 MHz** Typical SAR gradient: 10 % per mm

Probe Tip to Boundary		1 mm	2 mm
SAR _{be} [%] Without Correction Algorithm		7.1	4.4
SAR _{be} [%] With Correction Algorithm		0.0	0.1

Sensor Offset

Probe Tip to Sensor Center	2.0	mm
----------------------------	------------	----

Receiving Pattern (ϕ , $\theta = 0^\circ$)

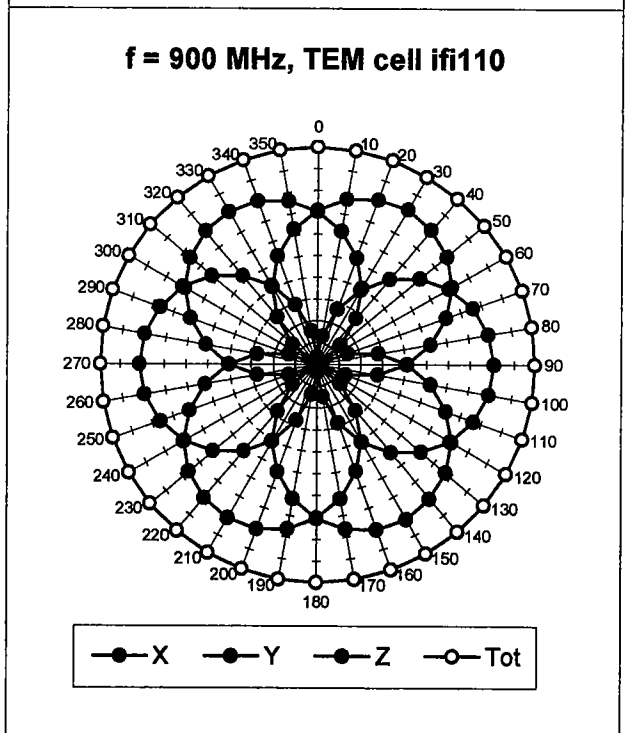
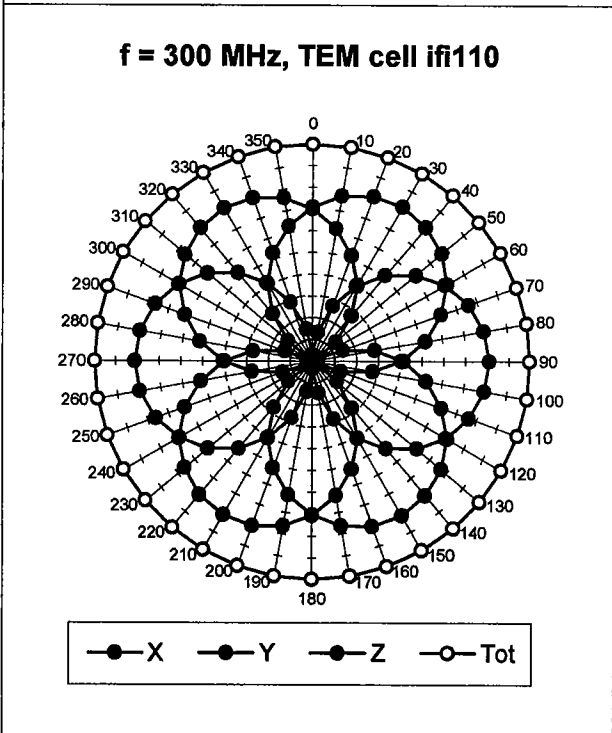
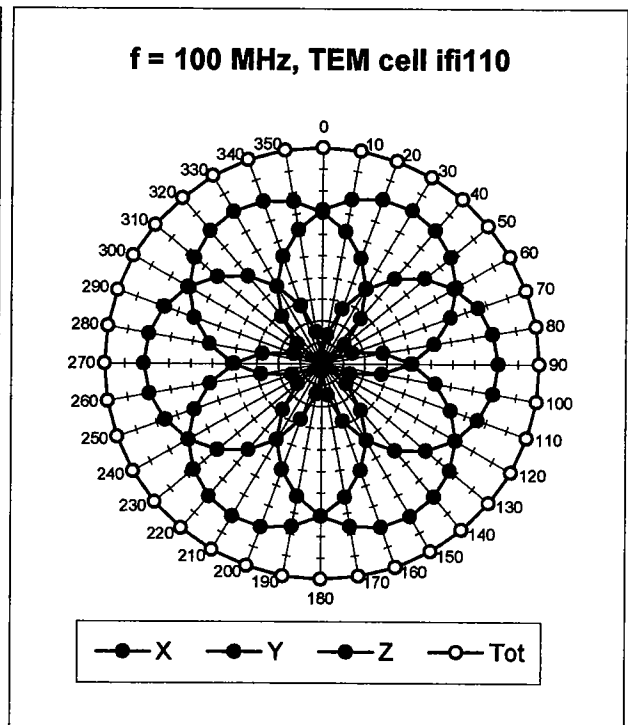
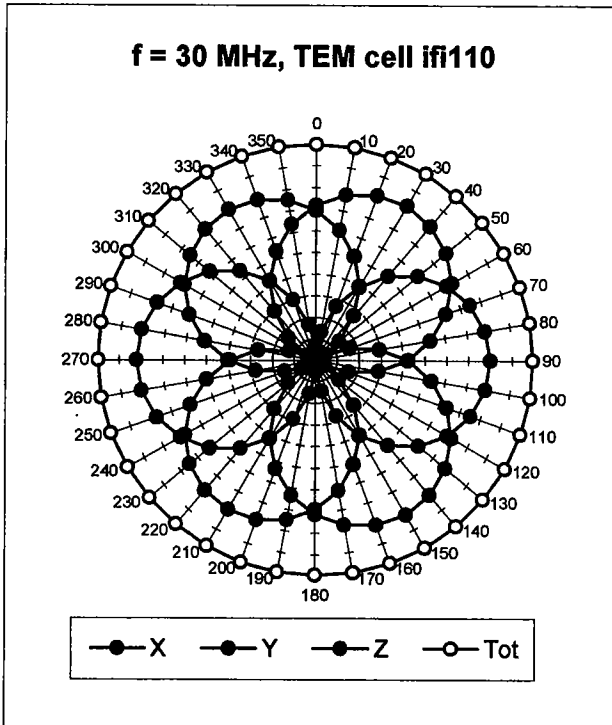

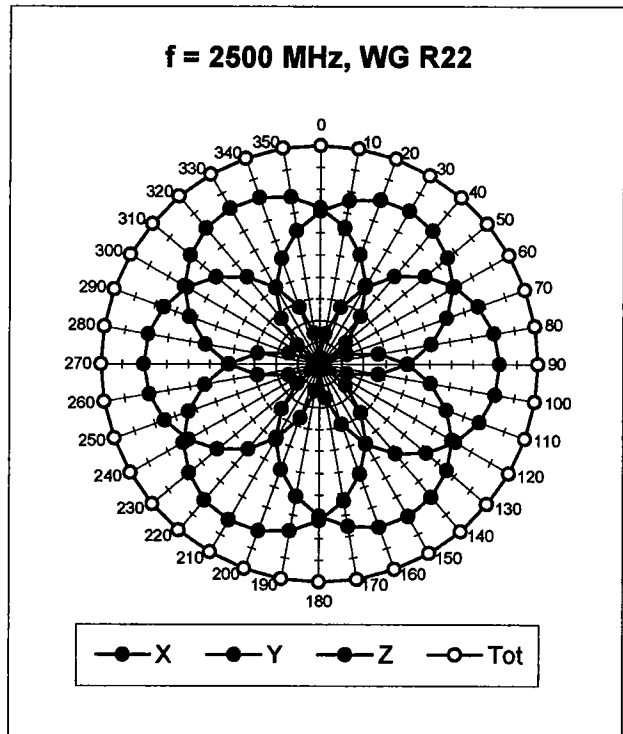
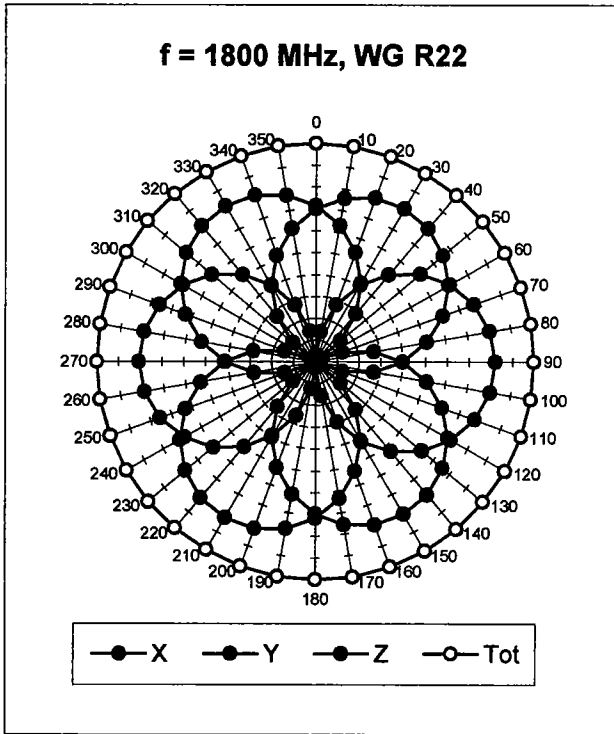

Isotropy Error (ϕ), $\theta = 0^\circ$

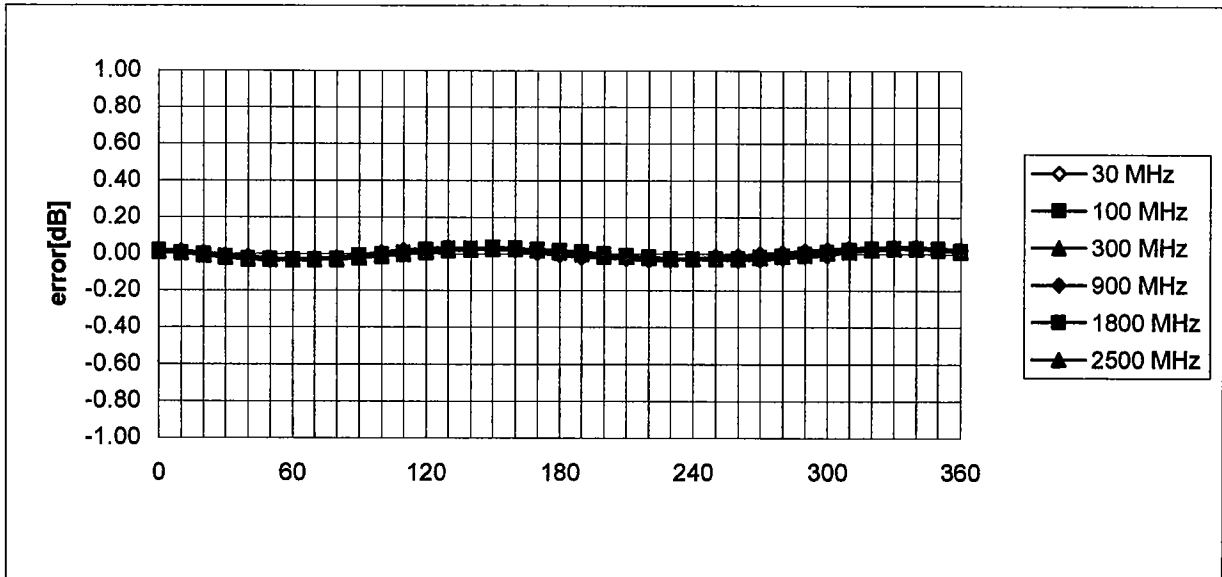

Frequency Response of E-Field

(TEM-Cell:ifi110, Waveguide R22)

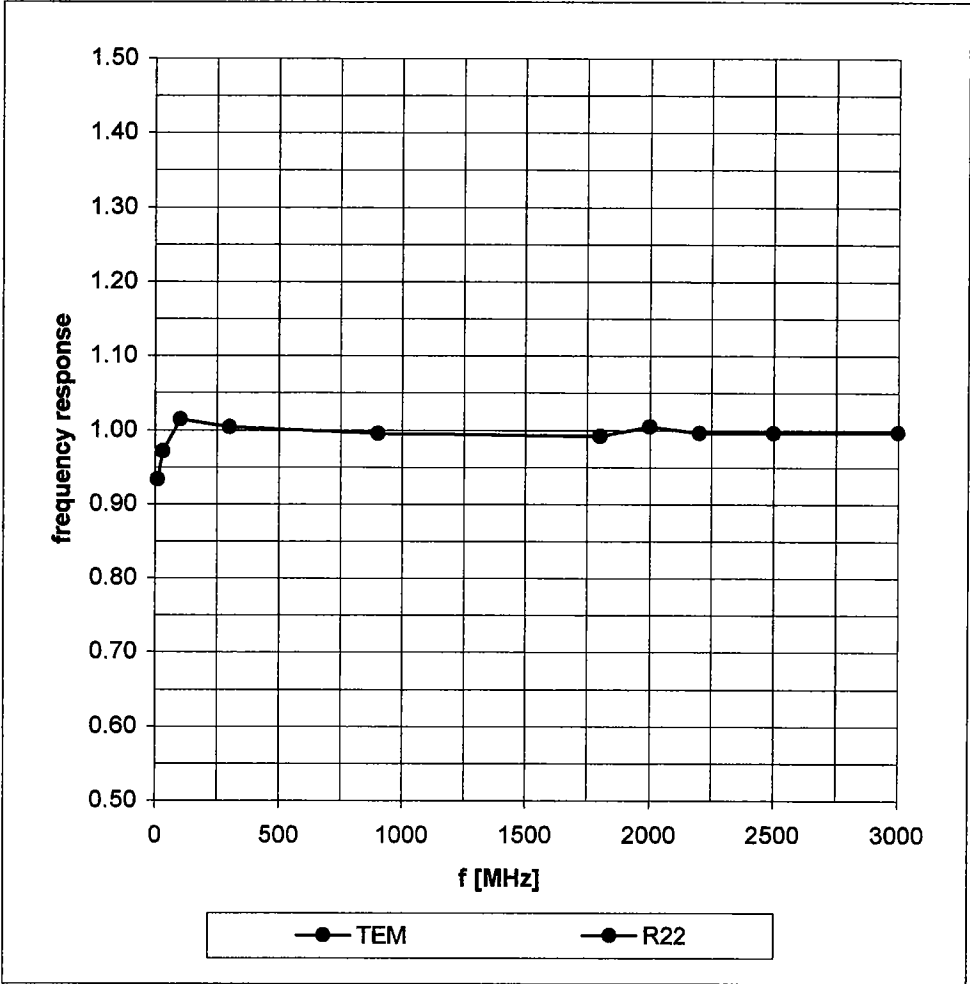

Dynamic Range $f(\text{SAR}_{\text{brain}})$ (Waveguide R22)

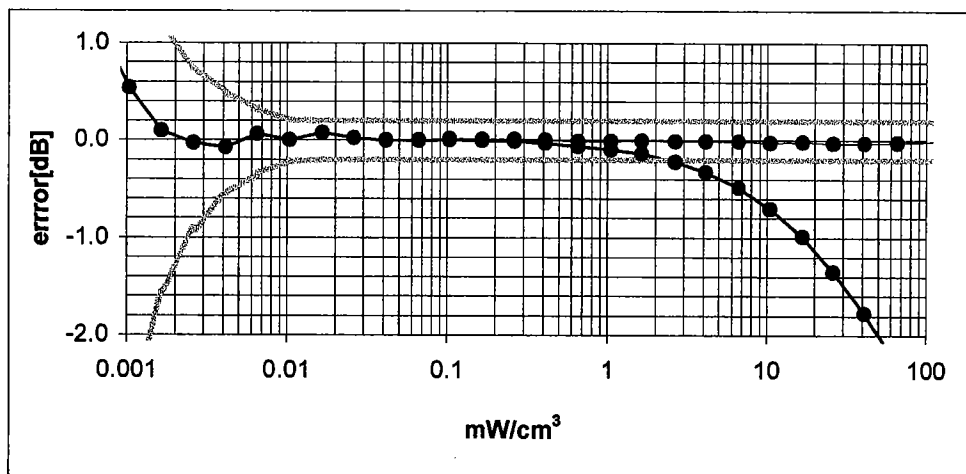
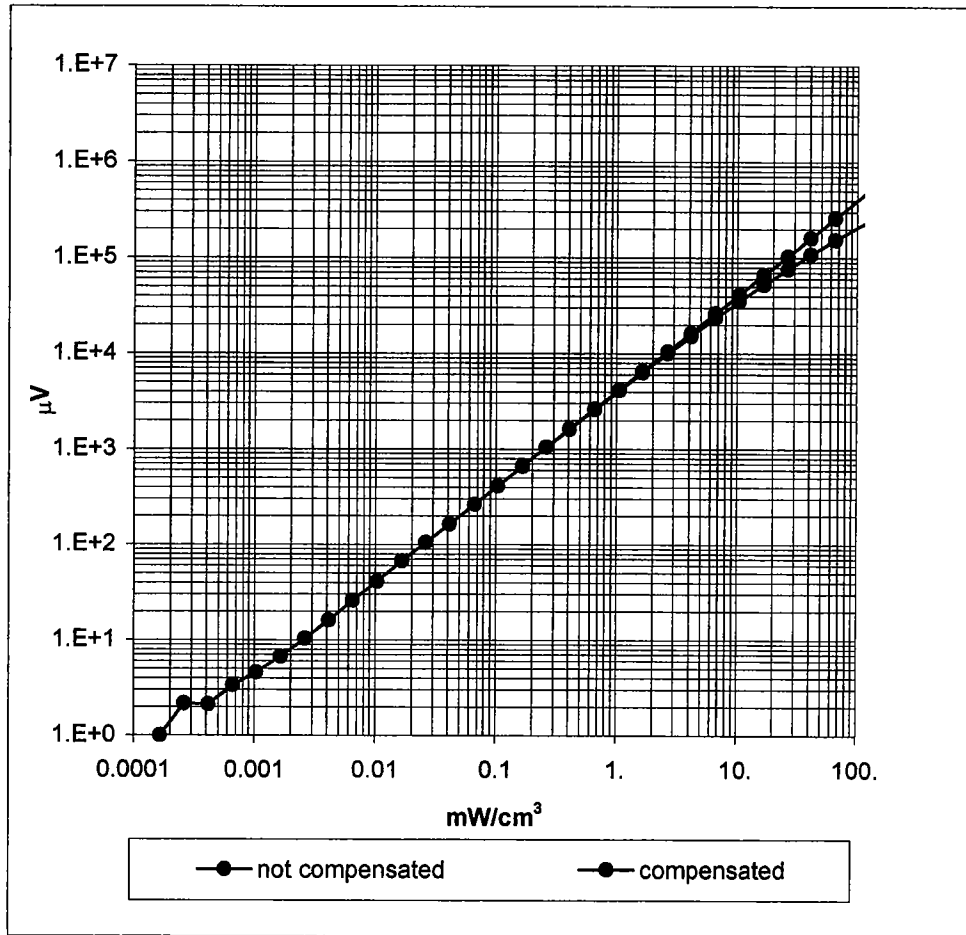

Conversion Factor Assessment

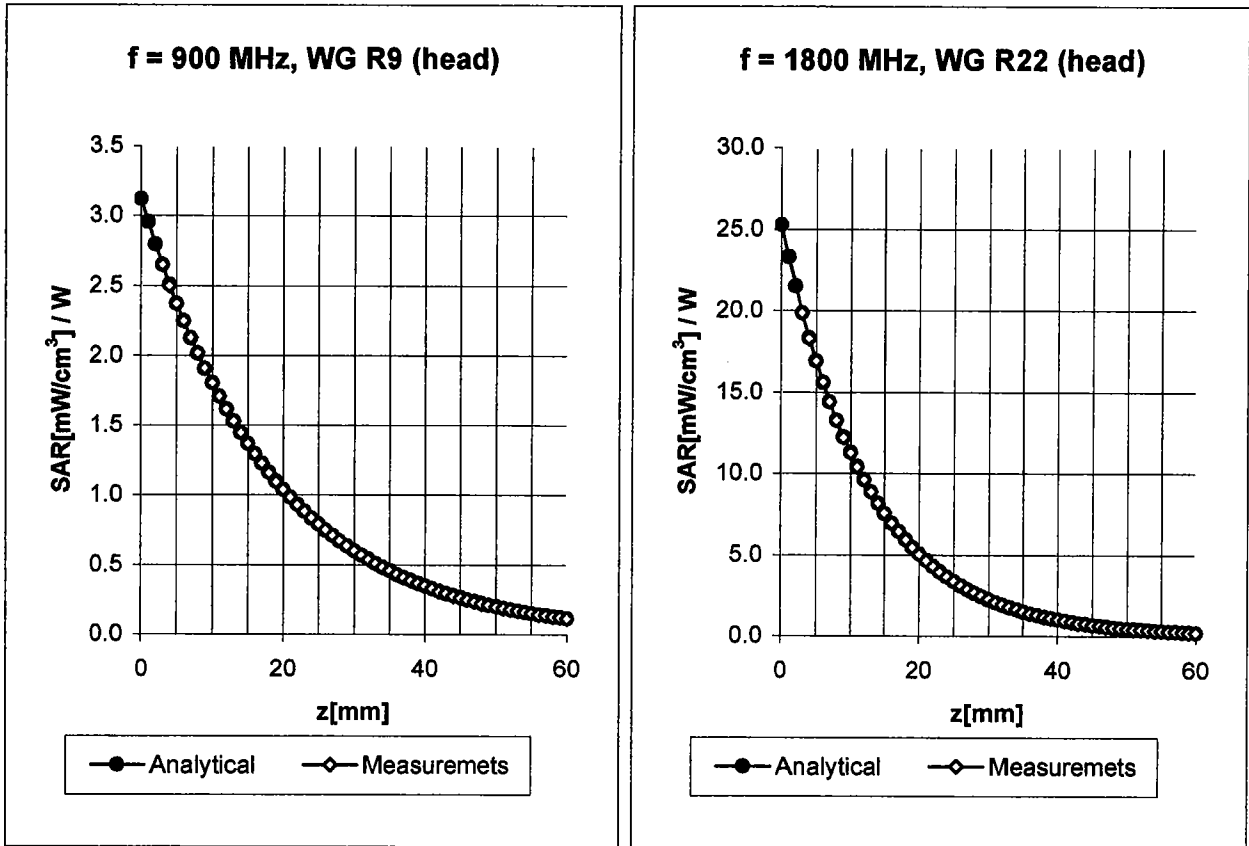

Head 900 MHz $\epsilon_r = 41.5 \pm 5\%$ $\sigma = 0.97 \pm 5\%$ mho/m

Valid for f=800-1000 MHz with Head Tissue Simulating Liquid according to EN 50361, P1528-200X

ConvF X	6.1 $\pm 9.5\%$ (k=2)	Boundary effect:
ConvF Y	6.1 $\pm 9.5\%$ (k=2)	Alpha 0.32
ConvF Z	6.1 $\pm 9.5\%$ (k=2)	Depth 1.65

Head 1800 MHz $\epsilon_r = 40.0 \pm 5\%$ $\sigma = 1.40 \pm 5\%$ mho/m

Valid for f=1710-1910 MHz with Head Tissue Simulating Liquid according to EN 50361, P1528-200X

ConvF X	5.0 $\pm 9.5\%$ (k=2)	Boundary effect:
ConvF Y	5.0 $\pm 9.5\%$ (k=2)	Alpha 0.25
ConvF Z	5.0 $\pm 9.5\%$ (k=2)	Depth 2.30

Conversion Factor Assessment

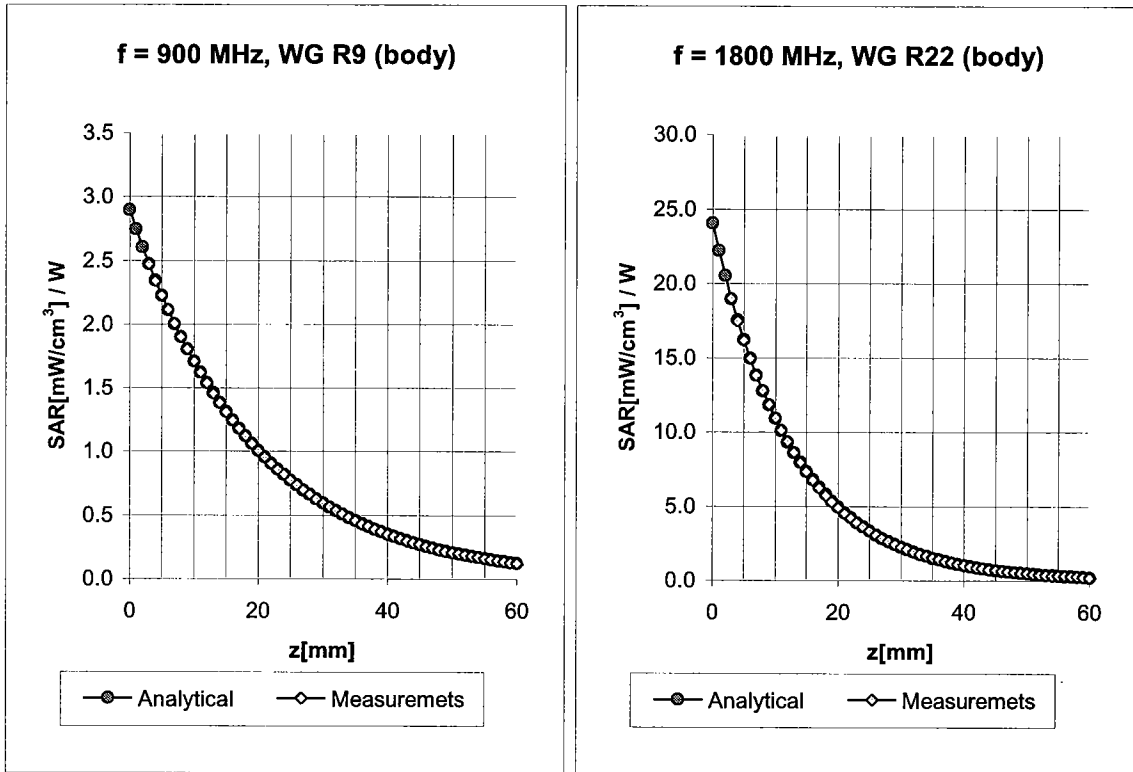

Body **900 MHz** $\epsilon_r = 55.0 \pm 5\%$ $\sigma = 1.05 \pm 5\%$ mho/m

Valid for f=800-1000 MHz with Body Tissue Simulating Liquid according to OET 65 Suppl. C

ConvF X	6.0 ± 9.5% (k=2)	Boundary effect:
ConvF Y	6.0 ± 9.5% (k=2)	Alpha 0.38
ConvF Z	6.0 ± 9.5% (k=2)	Depth 1.47

Body **1800 MHz** $\epsilon_r = 53.3 \pm 5\%$ $\sigma = 1.52 \pm 5\%$ mho/m

Valid for f=1710-1910 MHz with Body Tissue Simulating Liquid according to OET 65 Suppl. C

ConvF X	4.5 ± 9.5% (k=2)	Boundary effect:
ConvF Y	4.5 ± 9.5% (k=2)	Alpha 0.22
ConvF Z	4.5 ± 9.5% (k=2)	Depth 3.42

Conversion Factor Assessment

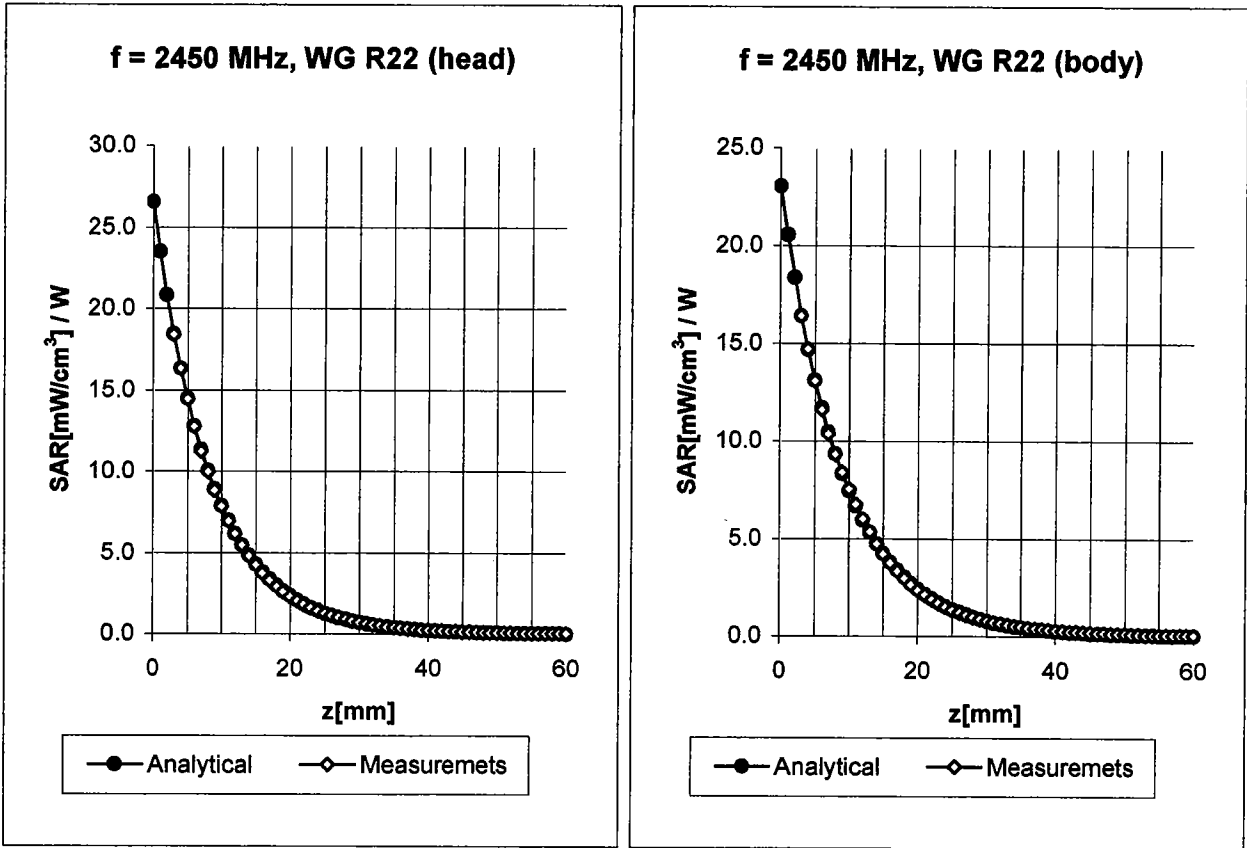

Head 2450 MHz $\epsilon_r = 39.2 \pm 5\%$ $\sigma = 1.80 \pm 5\%$ mho/m

Valid for f=2400-2500 MHz with Head Tissue Simulating Liquid according to EN 50361, P1528-200X

ConvF X	4.5 $\pm 9.5\%$ (k=2)	Boundary effect:
ConvF Y	4.5 $\pm 9.5\%$ (k=2)	Alpha 0.42
ConvF Z	4.5 $\pm 9.5\%$ (k=2)	Depth 1.56

Body 2450 MHz $\epsilon_r = 52.7 \pm 5\%$ $\sigma = 1.95 \pm 5\%$ mho/m

Valid for f=2400-2500 MHz with Body Tissue Simulating Liquid according to OET 65 Suppl. C

ConvF X	4.2 $\pm 9.5\%$ (k=2)	Boundary effect:
ConvF Y	4.2 $\pm 9.5\%$ (k=2)	Alpha 0.42
ConvF Z	4.2 $\pm 9.5\%$ (k=2)	Depth 1.65

Conversion Factor Assessment

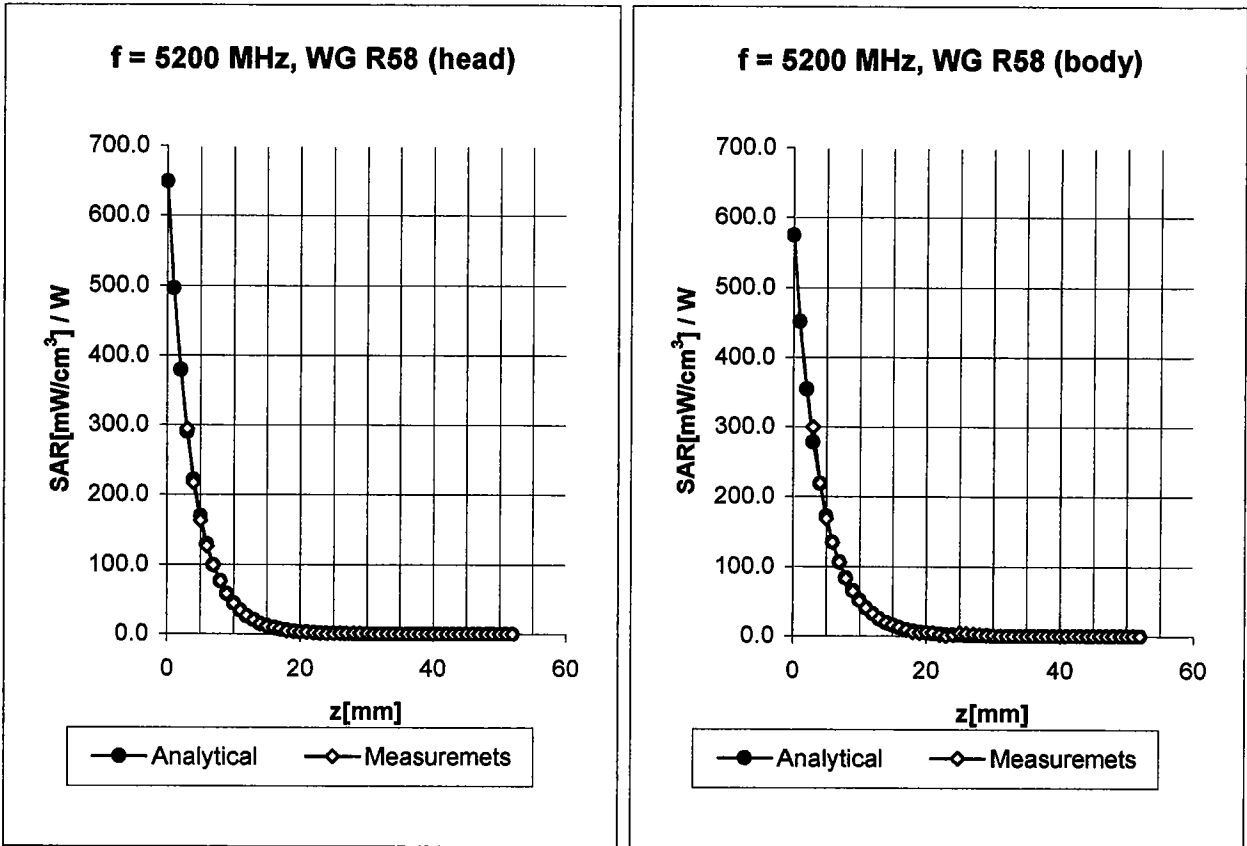

Head 5200 MHz $\epsilon_r = 36.0 \pm 5\%$ $\sigma = 4.66 \pm 5\%$ mho/m

Valid for f=4940-5460 MHz with Head Tissue Simulating Liquid according to OET65-SuppC

ConvF X	2.60 $\pm 16.6\%$ (k=2)	Boundary effect:
ConvF Y	2.60 $\pm 16.6\%$ (k=2)	Alpha 0.93
ConvF Z	2.60 $\pm 16.6\%$ (k=2)	Depth 1.50

Body 5200 MHz $\epsilon_r = 49.0 \pm 5\%$ $\sigma = 5.30 \pm 5\%$ mho/m

Valid for f=4940-5460 MHz with Body Tissue Simulating Liquid according to OET65-SuppC

ConvF X	1.80 $\pm 16.6\%$ (k=2)	Boundary effect:
ConvF Y	1.80 $\pm 16.6\%$ (k=2)	Alpha 1.05
ConvF Z	1.80 $\pm 16.6\%$ (k=2)	Depth 1.60

Conversion Factor Assessment

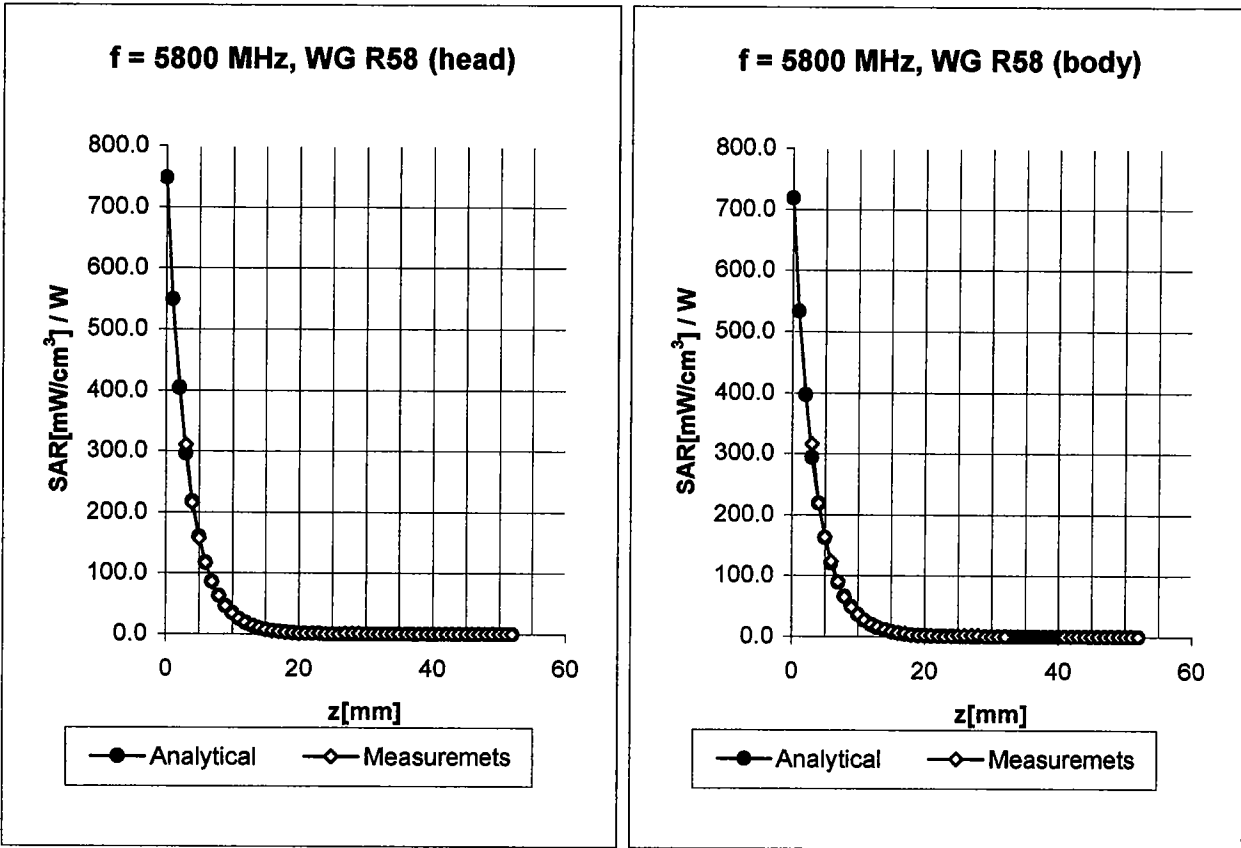

Head 5800 MHz $\epsilon_r = 35.3 \pm 5\%$ $\sigma = 5.27 \pm 5\%$ mho/m

Valid for f=5510-6090 MHz with Head Tissue Simulating Liquid according to OET65-SuppC

ConvF X	2.15 $\pm 16.6\%$ (k=2)	Boundary effect:	
ConvF Y	2.15 $\pm 16.6\%$ (k=2)	Alpha	1.04
ConvF Z	2.15 $\pm 16.6\%$ (k=2)	Depth	1.50

Body 5800 MHz $\epsilon_r = 48.2 \pm 5\%$ $\sigma = 6.0 \pm 5\%$ mho/m

Valid for f=5510-6090 MHz with Body Tissue Simulating Liquid according to OET65-SuppC

ConvF X	1.57 $\pm 16.6\%$ (k=2)	Boundary effect:	
ConvF Y	1.57 $\pm 16.6\%$ (k=2)	Alpha	1.15
ConvF Z	1.57 $\pm 16.6\%$ (k=2)	Depth	1.70

Deviation from Isotropy in HSL

Error ($\theta\phi$), $f = 900$ MHz

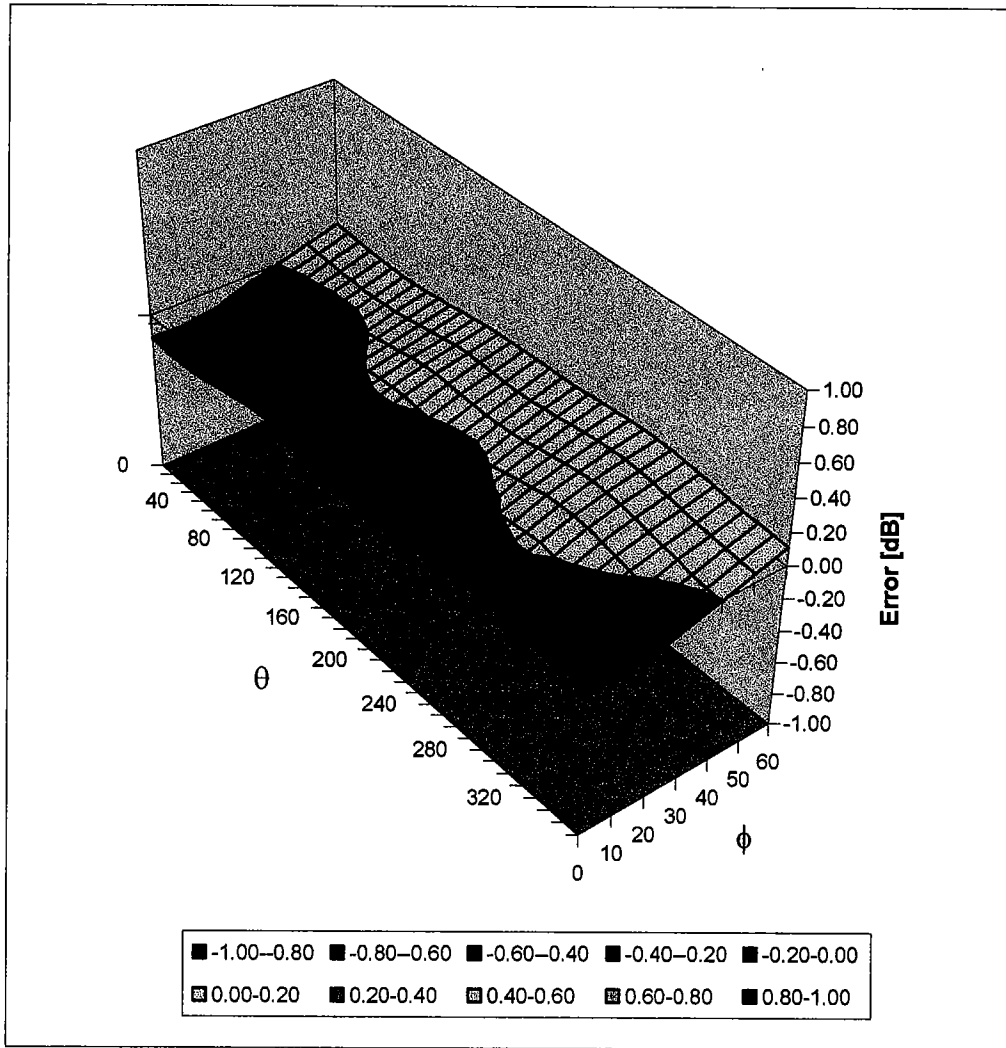

Additional Conversion Factors

for Dosimetric E-Field Probe

Type:

ES3DV2

Serial Number:

3022

Place of Assessment:

Zurich

Date of Assessment:

December 3, 2003

Probe Calibration Date:

September 23, 2003

Schmid & Partner Engineering AG hereby certifies that conversion factor(s) of this probe have been evaluated on the date indicated above. The assessment was performed using the FDTD numerical code SEMCAD of Schmid & Partner Engineering AG. Since the evaluation is coupled with measured conversion factors, it has to be recalculated yearly, i.e., following the re-calibration schedule of the probe. The uncertainty of the numerical assessment is based on the extrapolation from measured value at 900 MHz or at 1800 MHz.

Assessed by:

Dosimetric E-Field Probe ES3DV2 SN:3022

Conversion factor (\pm standard deviation)

1950 MHz	ConvF	4.7 \pm 9.5%	$\epsilon = 40.0 \pm 5\%$ $\sigma = 1.40 \pm 5\%$ mho/m (head tissue)
1950 MHz	ConvF	4.3 \pm 9.5%	$\epsilon = 53.3 \pm 5\%$ $\sigma = 1.52 \pm 5\%$ mho/m (body tissue)

Additional Conversion Factors

for Dosimetric E-Field Probe

Type:	ES3DV2
Serial Number:	3022
Place of Assessment:	Zurich
Date of Assessment:	October 3, 2003
Probe Calibration Date:	September 23, 2003

Schmid & Partner Engineering AG hereby certifies that conversion factor(s) of this probe have been evaluated on the date indicated above. The assessment was performed using the FDTD numerical code SEMCAD of Schmid & Partner Engineering AG. Since the evaluation is coupled with measured conversion factors, it has to be recalculated yearly, i.e., following the re-calibration schedule of the probe. The uncertainty of the numerical assessment is based on the extrapolation from measured value at 900 MHz or at 1800 MHz.

Assessed by:

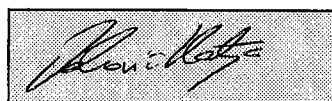

Dosimetric E-Field Probe ES3DV2 SN:3022

Conversion factor (\pm standard deviation)

150 MHz	ConvF	8.5 \pm 8%	$\epsilon_r = 52.3 \pm 5\%$ $\sigma = 0.76 \pm 5\%$ mho/m (head tissue)
150 MHz	ConvF	8.0 \pm 8%	$\epsilon_r = 61.9 \pm 5\%$ $\sigma = 0.80 \pm 5\%$ mho/m (body tissue)
450 MHz	ConvF	7.1 \pm 8%	$\epsilon_r = 43.5 \pm 5\%$ $\sigma = 0.87 \pm 5\%$ mho/m (head tissue)
450 MHz	ConvF	7.2 \pm 8%	$\epsilon_r = 56.7 \pm 5\%$ $\sigma = 0.94 \pm 5\%$ mho/m (body tissue)

Additional Conversion Factors

for Dosimetric E-Field Probe

Type:

ES3DV2

Serial Number:

3022

Place of Assessment:

Zurich

Date of Assessment:

November 28, 2003

Probe Calibration Date:

September 23, 2003

Schmid & Partner Engineering AG hereby certifies that conversion factor(s) of this probe have been evaluated on the date indicated above. The assessment was performed using the FDTD numerical code SEMCAD of Schmid & Partner Engineering AG. Since the evaluation is coupled with measured conversion factors, it has to be recalculated yearly, i.e., following the re-calibration schedule of the probe. The uncertainty of the numerical assessment is based on the extrapolation from measured value at 900 MHz or at 1800 MHz.

Assessed by:

Dosimetric E-Field Probe ES3DV2 SN:3022

Conversion factor (\pm standard deviation)

1600 MHz	ConvF	5.2 \pm 8%	$\square = 40.3 \pm 5\%$ $\square = 1.29 \pm 5\%$ mho/m (head tissue)
1600 MHz	ConvF	4.9 \pm 8%	$\square = 53.8 \pm 5\%$ $\square = 1.40 \pm 5\%$ mho/m (body tissue)

Additional Conversion Factors

for Dosimetric E-Field Probe

Type:

ES3DV2

Serial Number:

3022

Place of Assessment:

Zurich

Date of Assessment:

December 9, 2003

Probe Calibration Date:

September 23, 2003

Schmid & Partner Engineering AG hereby certifies that conversion factor(s) of this probe have been evaluated on the date indicated above. The assessment was performed using the FDTD numerical code SEMCAD of Schmid & Partner Engineering AG. Since the evaluation is coupled with measured conversion factors, it has to be recalculated yearly, i.e., following the re-calibration schedule of the probe. The uncertainty of the numerical assessment is based on the extrapolation from measured value at 900 MHz or at 1800 MHz.

Assessed by:

Dosimetric E-Field Probe ES3DV2 SN:3022

Conversion factor (\pm standard deviation)

2140 MHz ConvF **4.5 \pm 8%**

$\square = 39.8 \pm 5\%$ $\square = 1.49 \pm 5\%$ mho/m (brain tissue)
--