

APPENDIX A: SAR TEST DATA

PCTEST ENGINEERING LABORATORY, INC.

DUT: CF-U1; Type: Tablet PC with 802.11abgn, Bluetooth, GSM and WCDMA; SN: SAR 1

Communication System: GSM850 GPRS; 3 Tx slots; Frequency: 836.6 MHz; Duty Cycle: 1:2.76

Medium: 835 Muscle ($\sigma = 0.93$ mho/m, $\epsilon_r = 53.18$, $\rho = 1000$ kg/m³)

Phantom section: Flat Section; Space: 0.0 cm

Test Date: 08-07-2008; Ambient Temp: 23.7°C; Tissue Temp: 22.6°C

Probe: EX3DV4 - SN3561; ConvF(8.27, 8.27, 8.27); Calibrated: 8/30/2007

Sensor-Surface: 3mm (Mechanical Surface Detection)

Electronics: DAE4 Sn649; Calibrated: 1/30/2008

Phantom: SAM Main; Type: SAM 4.0; Serial: TP-1114

Measurement SW: DASY4, V4.7 Build 71; Postprocessing SW: SEMCAD, V1.8 Build 172

Mode: GSM850 GPRS, Body SAR, Laptop Position, Mid Ch, 3x Slot

Area Scan (13x15x1): Measurement grid: dx=15mm, dy=15mm

Zoom Scan (5x5x7)/Cube 0: Measurement grid: dx=8mm, dy=8mm, dz=5mm

Reference Value = 18.9 V/m

Peak SAR (extrapolated) = 0.392 W/kg

SAR(1 g) = 0.307 mW/g; SAR(10 g) = 0.223 mW/g

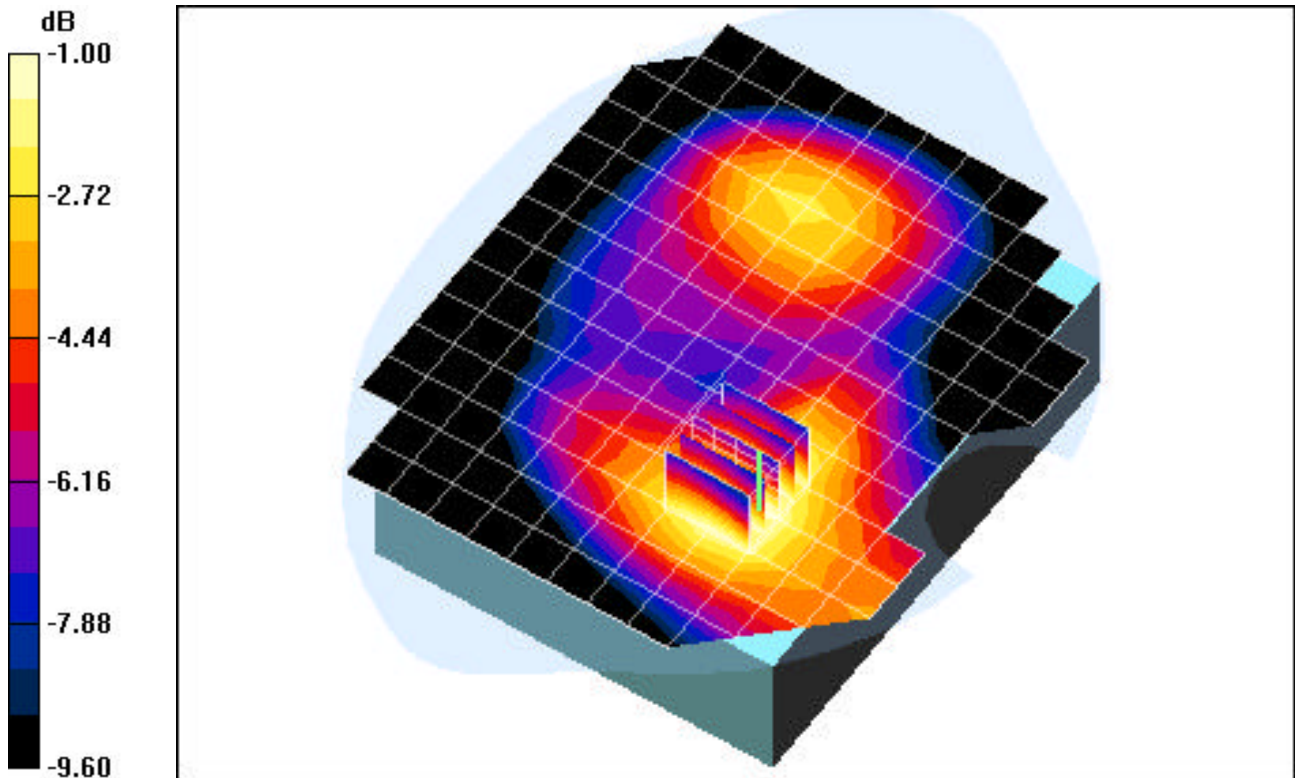

0 dB = 0.335mW/g

PCTEST ENGINEERING LABORATORY, INC.

DUT: CF-U1; Type: Tablet PC with 802.11abgn, Bluetooth, GSM and WCDMA; SN: SAR 1

Communication System: GSM850 EGPRS; 3 Tx slots; Frequency: 836.6 MHz; Duty Cycle: 1:2.76

Medium: 835 Muscle ($\sigma = 0.93$ mho/m, $\epsilon_r = 53.18$, $\rho = 1000$ kg/m³)

Phantom section: Flat Section; Space: 0.0 cm

Test Date: 08-07-2008; Ambient Temp: 23.6°C; Tissue Temp: 22.8°C

Probe: EX3DV4 - SN3561; ConvF(8.27, 8.27, 8.27); Calibrated: 8/30/2007

Sensor-Surface: 3mm (Mechanical Surface Detection)

Electronics: DAE4 Sn649; Calibrated: 1/30/2008

Phantom: SAM Main; Type: SAM 4.0; Serial: TP-1114

Measurement SW: DASY4, V4.7 Build 71; Postprocessing SW: SEMCAD, V1.8 Build 172

Mode: GSM850 GPRS, Body SAR, Tablet Position, Mid Ch, 3x Slot

Area Scan (7x15x1): Measurement grid: dx=15mm, dy=15mm

Zoom Scan (5x5x7)/Cube 0: Measurement grid: dx=8mm, dy=8mm, dz=5mm

Reference Value = 11.4 V/m

Peak SAR (extrapolated) = 0.336 W/kg

SAR(1 g) = 0.132 mW/g; SAR(10 g) = 0.058 mW/g

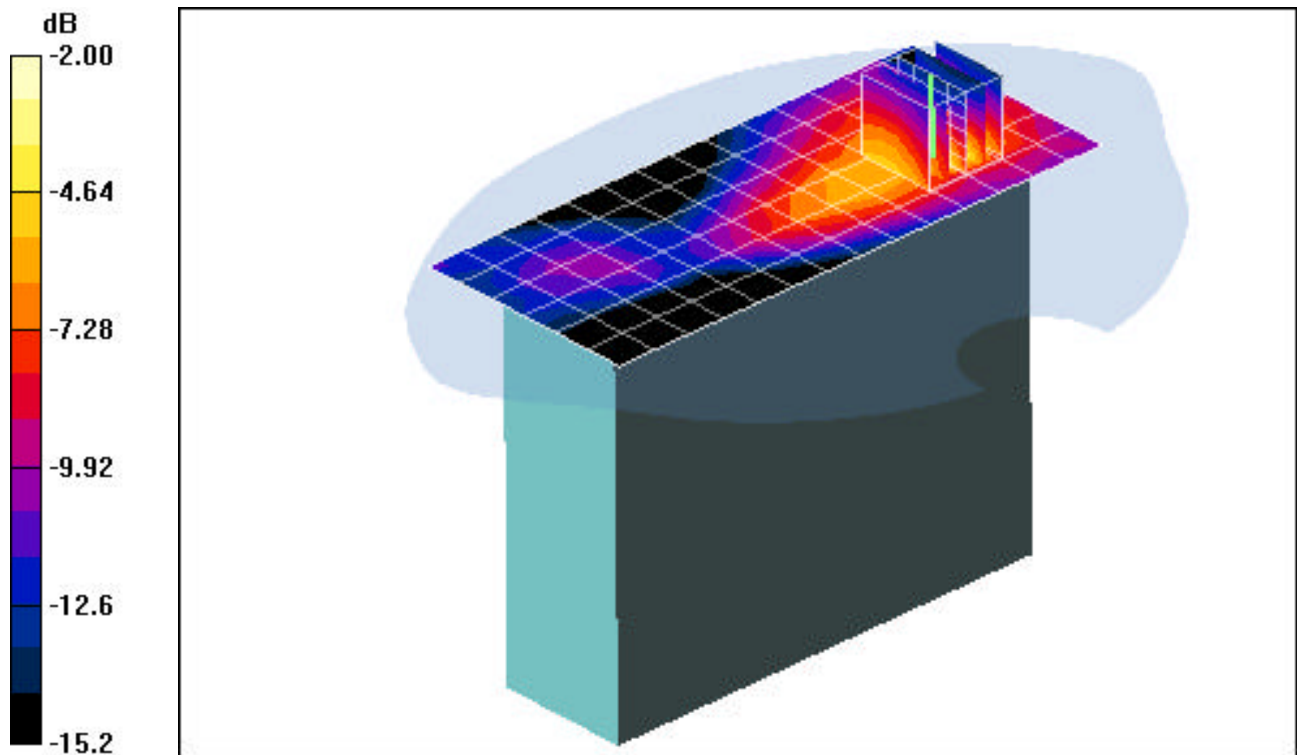

0 dB = 0.184mW/g

PCTEST ENGINEERING LABORATORY, INC.

DUT: CF-U1; Type: Tablet PC with 802.11abgn, Bluetooth, GSM and WCDMA; SN: SAR 1

Communication System: GSM1900 GPRS; 4 Tx slots; Frequency: 1880 MHz; Duty Cycle: 1:2

Medium: 1900 Muscle ($\sigma = 1.47$ mho/m, $\epsilon_r = 54.83$, $\rho = 1000$ kg/m³)

Phantom section: Flat Section; Space: 0.0 cm

Test Date: 08-08-2008; Ambient Temp: 23.5°C; Tissue Temp: 22.7°C

Probe: EX3DV4 - SN3561; ConvF(6.6, 6.6, 6.6); Calibrated: 8/30/2007

Sensor-Surface: 3mm (Mechanical Surface Detection)

Electronics: DAE4 Sn649; Calibrated: 1/30/2008

Phantom: SAM Sub; Type: SAM 4.0; Serial: TP-1357

Measurement SW: DASY4, V4.7 Build 71; Postprocessing SW: SEMCAD, V1.8 Build 172

Mode: GSM1900 GPRS, Body SAR, Laptop Position, Mid Ch, 4x Slot

Area Scan (13x15x1): Measurement grid: dx=15mm, dy=15mm

Zoom Scan (5x5x7)/Cube 0: Measurement grid: dx=8mm, dy=8mm, dz=5mm

Reference Value = 12.6 V/m

Peak SAR (extrapolated) = 0.346 W/kg

SAR(1 g) = 0.216 mW/g; SAR(10 g) = 0.125 mW/g

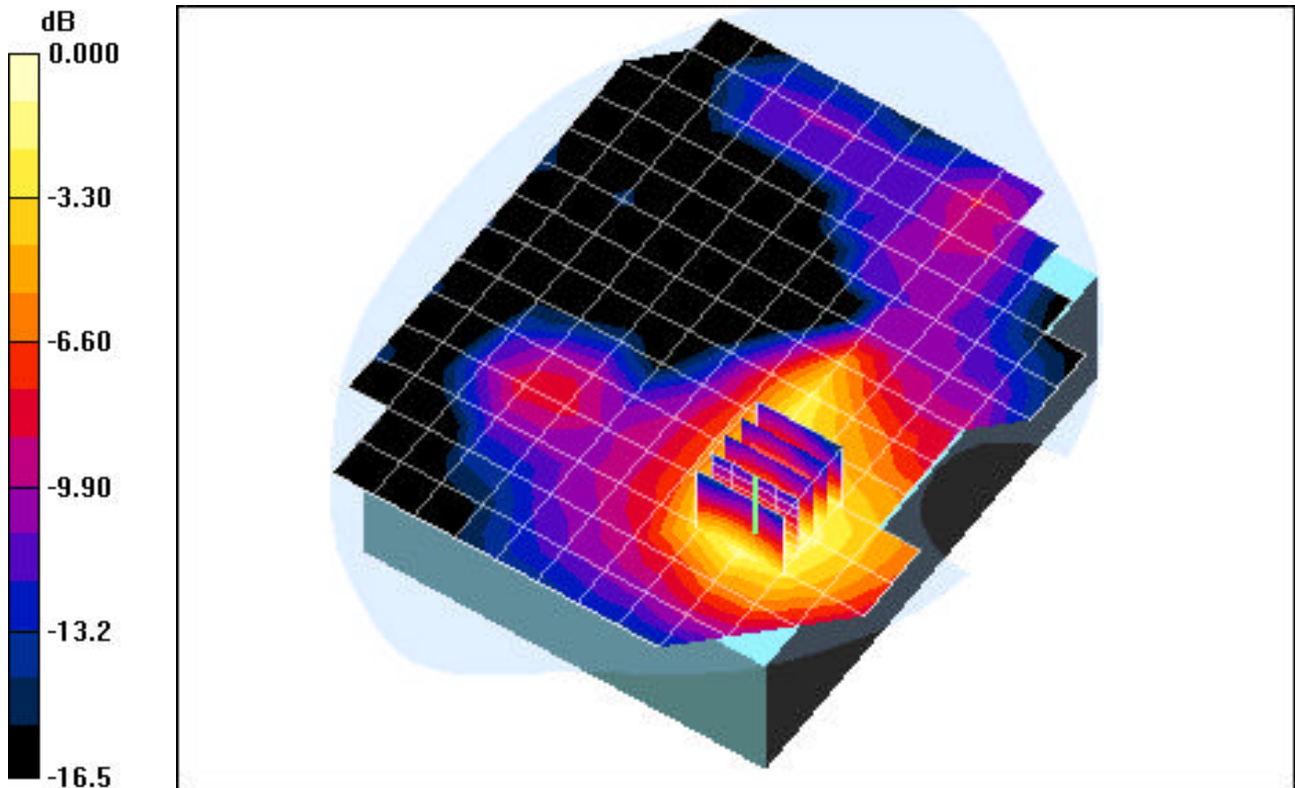

0 dB = 0.251mW/g

PCTEST ENGINEERING LABORATORY, INC.

DUT: CF-U1; Type: Tablet PC with 802.11abgn, Bluetooth, GSM and WCDMA; SN: SAR 1

Communication System: GSM1900 GPRS; 4 Tx slots; Frequency: 1880 MHz; Duty Cycle: 1:2

Medium: 1900 Muscle ($\sigma = 1.47$ mho/m, $\epsilon_r = 54.83$, $\rho = 1000$ kg/m³)

Phantom section: Flat Section; Space: 0.0 cm

Test Date: 08-08-2008; Ambient Temp: 23.5°C; Tissue Temp: 22.7°C

Probe: EX3DV4 - SN3561; ConvF(6.6, 6.6, 6.6); Calibrated: 8/30/2007

Sensor-Surface: 3mm (Mechanical Surface Detection)

Electronics: DAE4 Sn649; Calibrated: 1/30/2008

Phantom: SAM Sub; Type: SAM 4.0; Serial: TP-1357

Measurement SW: DASY4, V4.7 Build 71; Postprocessing SW: SEMCAD, V1.8 Build 172

Mode: GSM1900 GPRS, Body SAR, Tablet Position, Mid Ch, 4x Slot

Area Scan (7x15x1): Measurement grid: dx=15mm, dy=15mm

Zoom Scan (5x5x7)/Cube 0: Measurement grid: dx=8mm, dy=8mm, dz=5mm

Reference Value = 3.81 V/m

Peak SAR (extrapolated) = 0.030 W/kg

SAR(1 g) = 0.019 mW/g; SAR(10 g) = 0.012 mW/g

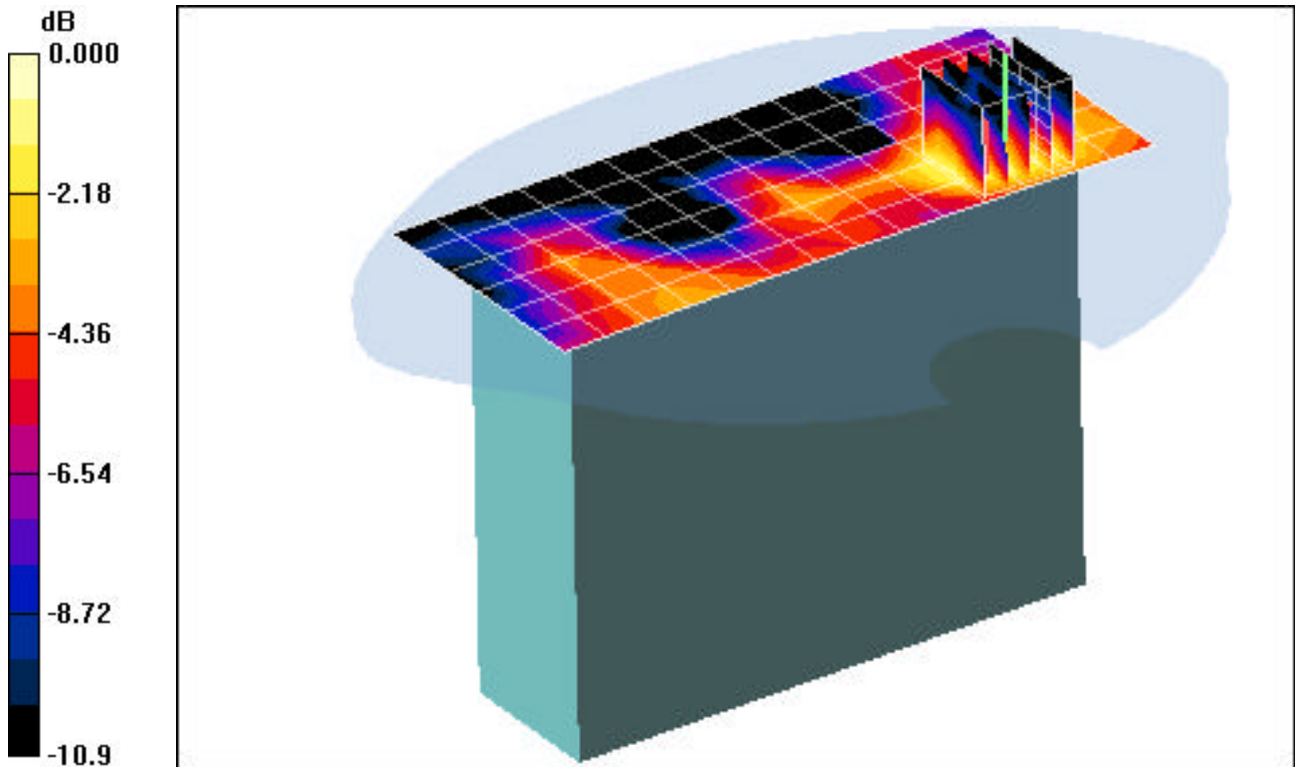

0 dB = 0.023mW/g

PCTEST ENGINEERING LABORATORY, INC.

DUT: CF-U1; Type: Tablet PC with 802.11abgn, Bluetooth, GSM and WCDMA; SN: SAR 1

Communication System: WCDMA850; Frequency: 836.6 MHz; Duty Cycle: 1:1

Medium: 835 Muscle ($\sigma = 0.93$ mho/m, $\epsilon_r = 53.18$, $\rho = 1000$ kg/m³)

Phantom section: Flat Section; Space: 0.0 cm

Test Date: 08-07-2008; Ambient Temp: 23.7°C; Tissue Temp: 22.6°C

Probe: EX3DV4 - SN3561; ConvF(8.27, 8.27, 8.27); Calibrated: 8/30/2007

Sensor-Surface: 3mm (Mechanical Surface Detection)

Electronics: DAE4 Sn649; Calibrated: 1/30/2008

Phantom: SAM Main; Type: SAM 4.0; Serial: TP-1114

Measurement SW: DASY4, V4.7 Build 71; Postprocessing SW: SEMCAD, V1.8 Build 172

Mode: WCDMA850, Body SAR, Laptop Position, Mid Ch, HSDPA Inactive

Area Scan (13x15x1): Measurement grid: dx=15mm, dy=15mm

Zoom Scan (5x5x7)/Cube 0: Measurement grid: dx=8mm, dy=8mm, dz=5mm

Reference Value = 13.9 V/m

Peak SAR (extrapolated) = 0.217 W/kg

SAR(1 g) = 0.160 mW/g; SAR(10 g) = 0.116 mW/g

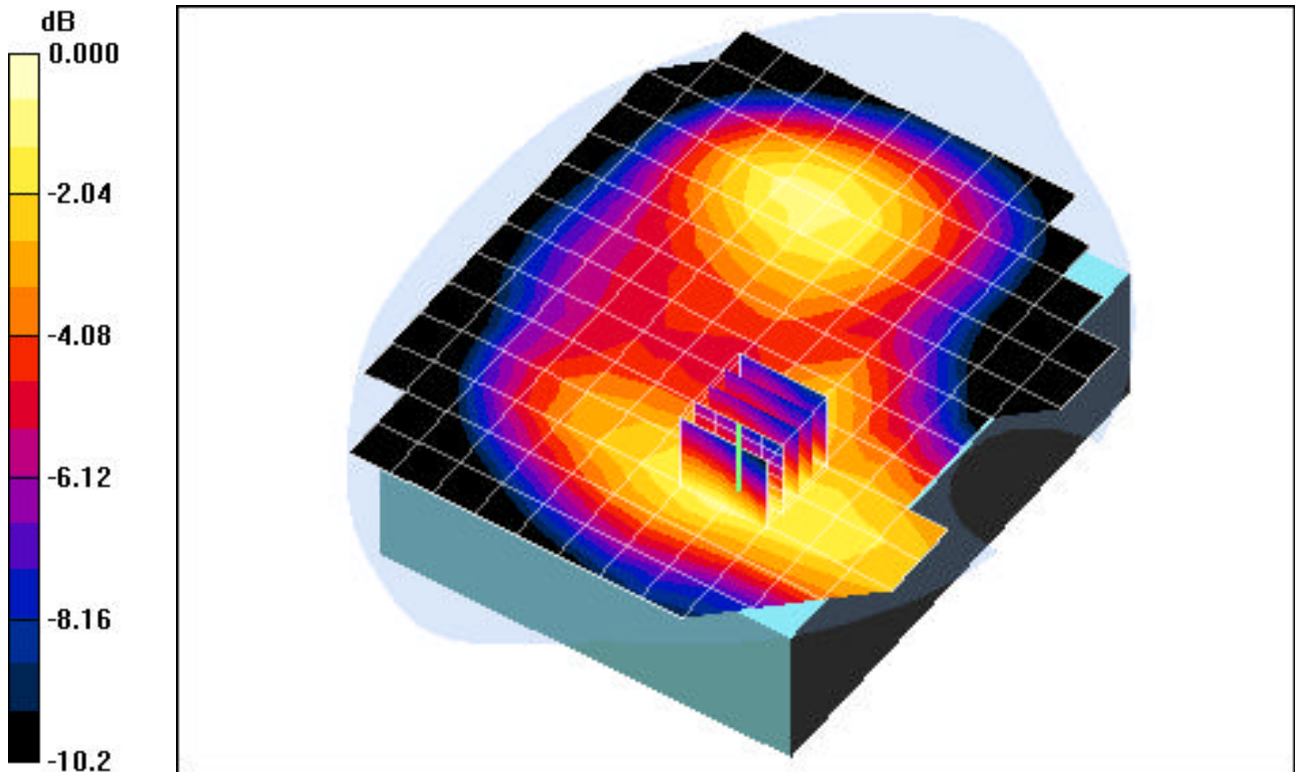

0 dB = 0.179mW/g

PCTEST ENGINEERING LABORATORY, INC.

DUT: CF-U1; Type: Tablet PC with 802.11abgn, Bluetooth, GSM and WCDMA; SN: SAR 1

Communication System: WCDMA850; Frequency: 836.6 MHz; Duty Cycle: 1:1

Medium: 835 Muscle ($\sigma = 0.93$ mho/m, $\epsilon_r = 53.18$, $\rho = 1000$ kg/m³)

Phantom section: Flat Section; Space: 0.0 cm

Test Date: 08-07-2008; Ambient Temp: 23.7°C; Tissue Temp: 22.6°C

Probe: EX3DV4 - SN3561; ConvF(8.27, 8.27, 8.27); Calibrated: 8/30/2007

Sensor-Surface: 3mm (Mechanical Surface Detection)

Electronics: DAE4 Sn649; Calibrated: 1/30/2008

Phantom: SAM Main; Type: SAM 4.0; Serial: TP-1114

Measurement SW: DASY4, V4.7 Build 71; Postprocessing SW: SEMCAD, V1.8 Build 172

Mode: WCDMA850, Body SAR, Tablet Position, Mid Ch, HSDPA Inactive

Area Scan (7x15x1): Measurement grid: dx=15mm, dy=15mm

Zoom Scan (5x5x7)/Cube 0: Measurement grid: dx=8mm, dy=8mm, dz=5mm

Reference Value = 14.9 V/m

Peak SAR (extrapolated) = 0.406 W/kg

SAR(1 g) = 0.120 mW/g; SAR(10 g) = 0.046 mW/g

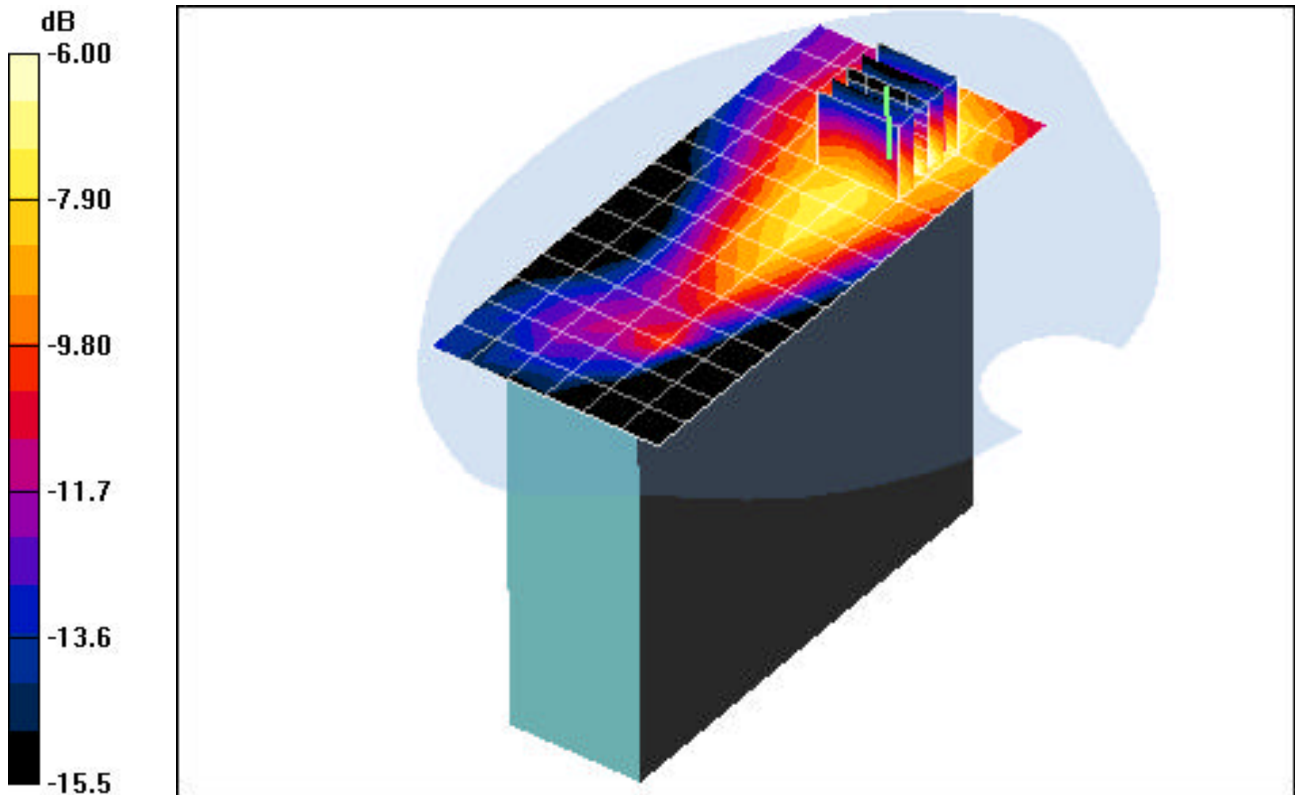

0 dB = 0.209mW/g

PCTEST ENGINEERING LABORATORY, INC.

DUT: CF-U1; Type: Tablet PC with 802.11abgn, Bluetooth, GSM and WCDMA; SN: SAR 1

Communication System: WCDMA1900; Frequency: 1880 MHz; Duty Cycle: 1:1

Medium: 1900 Muscle ($\sigma = 1.47$ mho/m, $\epsilon_r = 54.83$, $\rho = 1000$ kg/m³)

Phantom section: Flat Section; Space: 0.0 cm

Test Date: 08-08-2008; Ambient Temp: 23.5°C; Tissue Temp: 22.7°C

Probe: EX3DV4 - SN3561; ConvF(6.6, 6.6, 6.6); Calibrated: 8/30/2007

Sensor-Surface: 3mm (Mechanical Surface Detection)

Electronics: DAE4 Sn649; Calibrated: 1/30/2008

Phantom: SAM Main; Type: SAM 4.0; Serial: TP-1114

Measurement SW: DASY4, V4.7 Build 71; Postprocessing SW: SEMCAD, V1.8 Build 172

Mode: WCDMA1900, Body SAR, Laptop Position, Mid Ch, HSDPA Inactive

Area Scan (13x15x1): Measurement grid: dx=15mm, dy=15mm

Zoom Scan (5x5x7)/Cube 0: Measurement grid: dx=8mm, dy=8mm, dz=5mm

Reference Value = 10.5 V/m

Peak SAR (extrapolated) = 0.393 W/kg

SAR(1 g) = 0.228 mW/g; SAR(10 g) = 0.133 mW/g

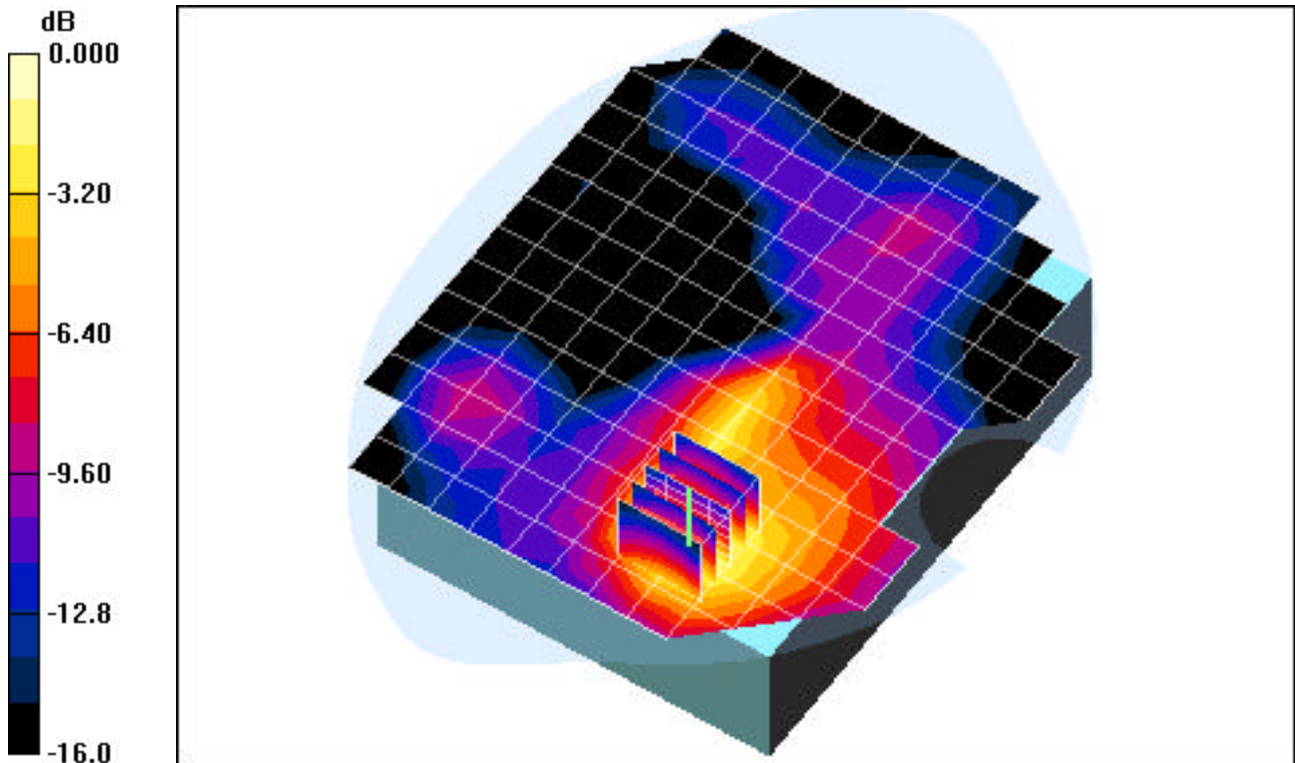

0 dB = 0.275mW/g

PCTEST ENGINEERING LABORATORY, INC.

DUT: CF-U1; Type: Tablet PC with 802.11abgn, Bluetooth, GSM and WCDMA; SN: SAR 1

Communication System: WCDMA1900; Frequency: 1880 MHz; Duty Cycle: 1:1

Medium: 1900 Muscle ($\sigma = 1.47$ mho/m, $\epsilon_r = 54.83$, $\rho = 1000$ kg/m³)

Phantom section: Flat Section; Space: 0.0 cm

Test Date: 08-08-2008; Ambient Temp: 23.5°C; Tissue Temp: 22.7°C

Probe: EX3DV4 - SN3561; ConvF(6.6, 6.6, 6.6); Calibrated: 8/30/2007

Sensor-Surface: 3mm (Mechanical Surface Detection)

Electronics: DAE4 Sn649; Calibrated: 1/30/2008

Phantom: SAM Main; Type: SAM 4.0; Serial: TP-1114

Measurement SW: DASY4, V4.7 Build 71; Postprocessing SW: SEMCAD, V1.8 Build 172

Mode: WCDMA1900, Body SAR, Tablet Position, Mid Ch, HSDPA Active

Area Scan (7x15x1): Measurement grid: dx=15mm, dy=15mm

Zoom Scan (5x5x7)/Cube 0: Measurement grid: dx=8mm, dy=8mm, dz=5mm

Reference Value = 7.44 V/m

Peak SAR (extrapolated) = 0.144 W/kg

SAR(1 g) = 0.086 mW/g; SAR(10 g) = 0.050 mW/g

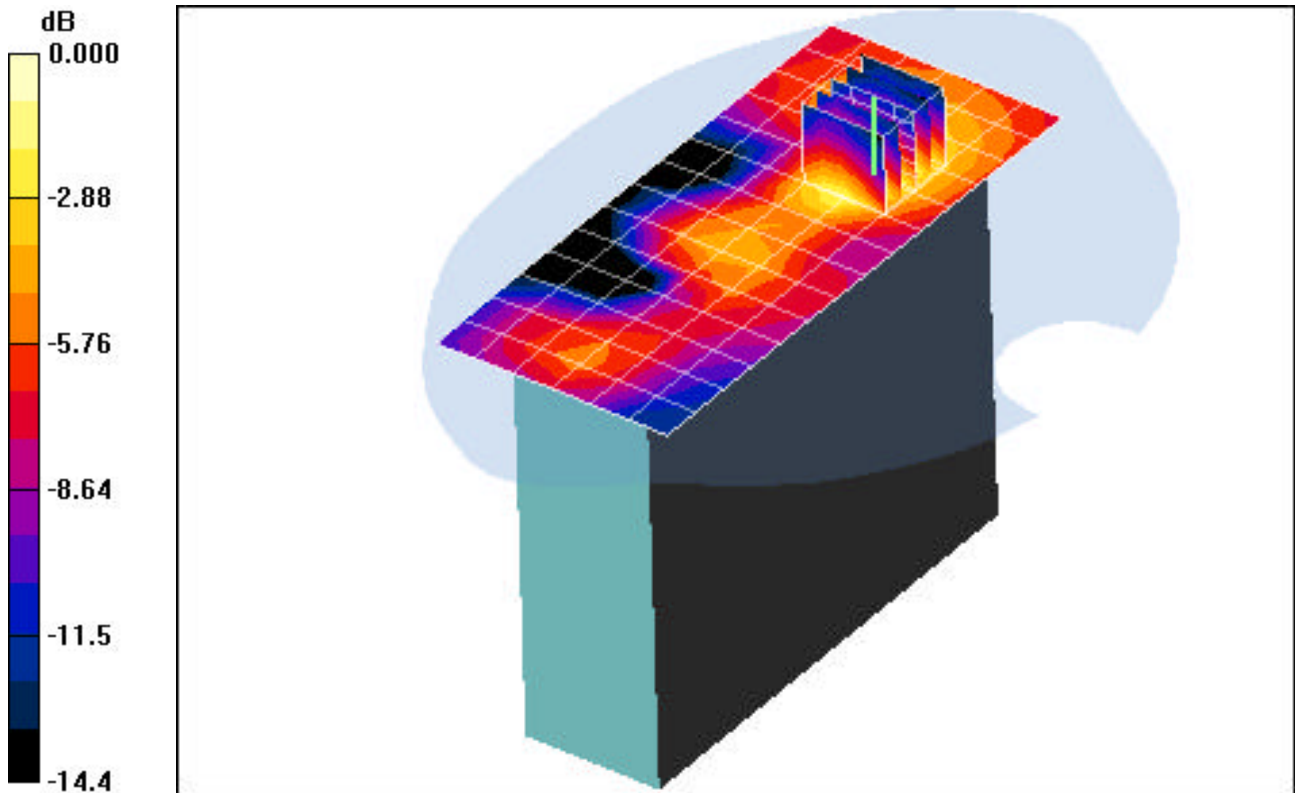

0 dB = 0.104mW/g

PCTEST ENGINEERING LABORATORY, INC.

DUT: CF-U1; Type: Tablet PC with 802.11abgn, Bluetooth, GSM and WCDMA; SN: SAR 1

Communication System: Bluetooth; Frequency: 2441 MHz; Duty Cycle: 1:1

Medium: 2450 Muscle ($\sigma = 1.93$ mho/m, $\epsilon_r = 51.84$, $\rho = 1000$ kg/m³)

Phantom section: Flat Section; Space: 0.0 cm

Test Date: 08-11-2008; Ambient Temp: 23.9°C; Tissue Temp: 22.6°C

Probe: ES3DV2 - SN3022; ConvF(4.01, 4.01, 4.01); Calibrated: 10/23/2007

Sensor-Surface: 3mm (Mechanical Surface Detection)

Electronics: DAE4 Sn649; Calibrated: 1/30/2008

Phantom: SAM Main; Type: SAM 4.0; Serial: TP-1114

Measurement SW: DASY4, V4.7 Build 71; Postprocessing SW: SEMCAD, V1.8 Build 172

Mode: Bluetooth, Body SAR, Laptop Position, Mid Ch

Area Scan (13x15x1): Measurement grid: dx=15mm, dy=15mm

Zoom Scan (5x5x7)/Cube 0: Measurement grid: dx=8mm, dy=8mm, dz=5mm

Reference Value = 1.81 V/m

Peak SAR (extrapolated) = 0.099 W/kg

SAR(1 g) = 0.051 mW/g; SAR(10 g) = 0.028 mW/g

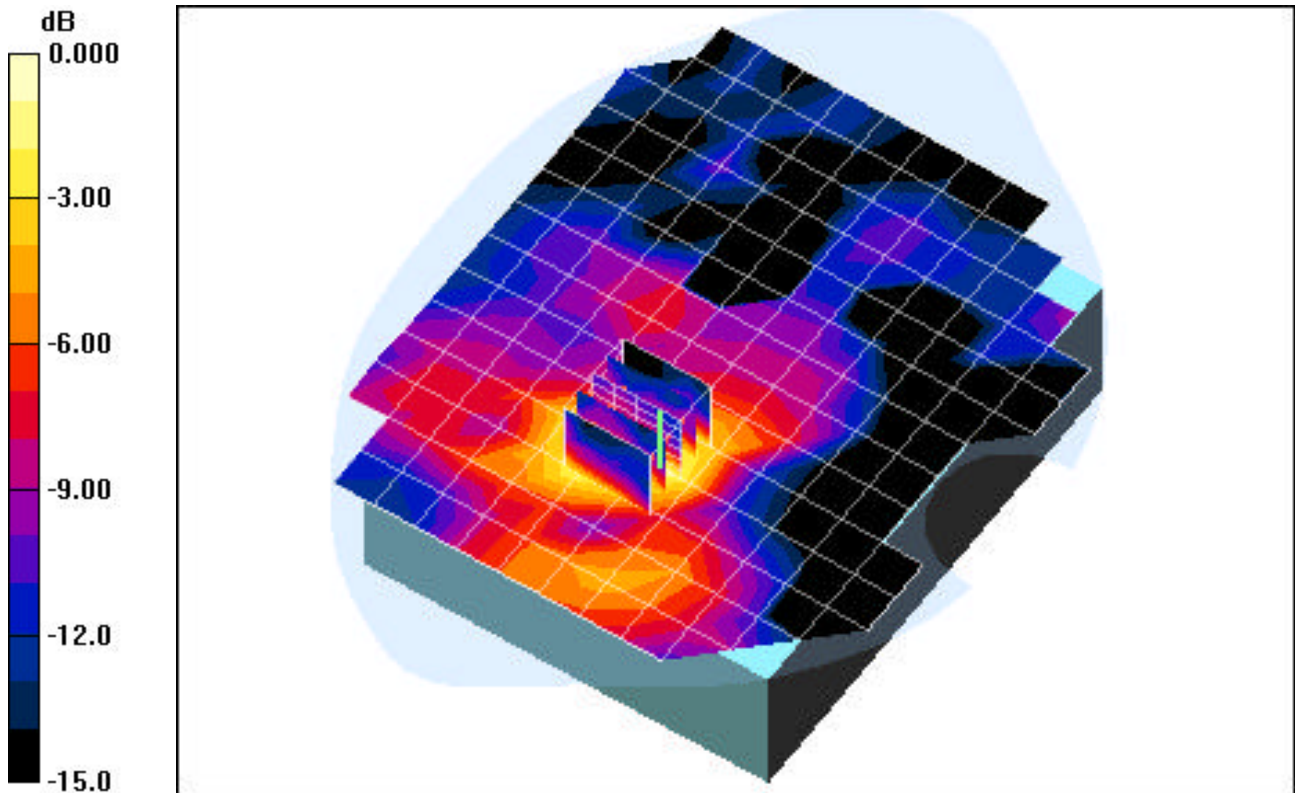

0 dB = 0.063mW/g

PCTEST ENGINEERING LABORATORY, INC.

DUT: CF-U1; Type: Tablet PC with 802.11abgn, Bluetooth, GSM and WCDMA; SN: SAR 1

Communication System: Bluetooth; Frequency: 2441 MHz; Duty Cycle: 1:1

Medium: 2450 Muscle ($\sigma = 1.93$ mho/m, $\epsilon_r = 51.84$, $\rho = 1000$ kg/m³)

Phantom section: Flat Section; Space: 0.0 cm

Test Date: 08-11-2008; Ambient Temp: 23.9°C; Tissue Temp: 22.6°C

Probe: ES3DV2 - SN3022; ConvF(4.01, 4.01, 4.01); Calibrated: 10/23/2007

Sensor-Surface: 3mm (Mechanical Surface Detection)

Electronics: DAE4 Sn649; Calibrated: 1/30/2008

Phantom: SAM Main; Type: SAM 4.0; Serial: TP-1114

Measurement SW: DASY4, V4.7 Build 71; Postprocessing SW: SEMCAD, V1.8 Build 172

Mode: Bluetooth, Body SAR, Tablet Position, Mid Ch

Area Scan (7x15x1): Measurement grid: dx=15mm, dy=15mm

Zoom Scan (5x5x7)/Cube 0: Measurement grid: dx=8mm, dy=8mm, dz=5mm

Reference Value = 1.44 V/m

Peak SAR (extrapolated) = 0.109 W/kg

SAR(1 g) = 0.052 mW/g; SAR(10 g) = 0.025 mW/g

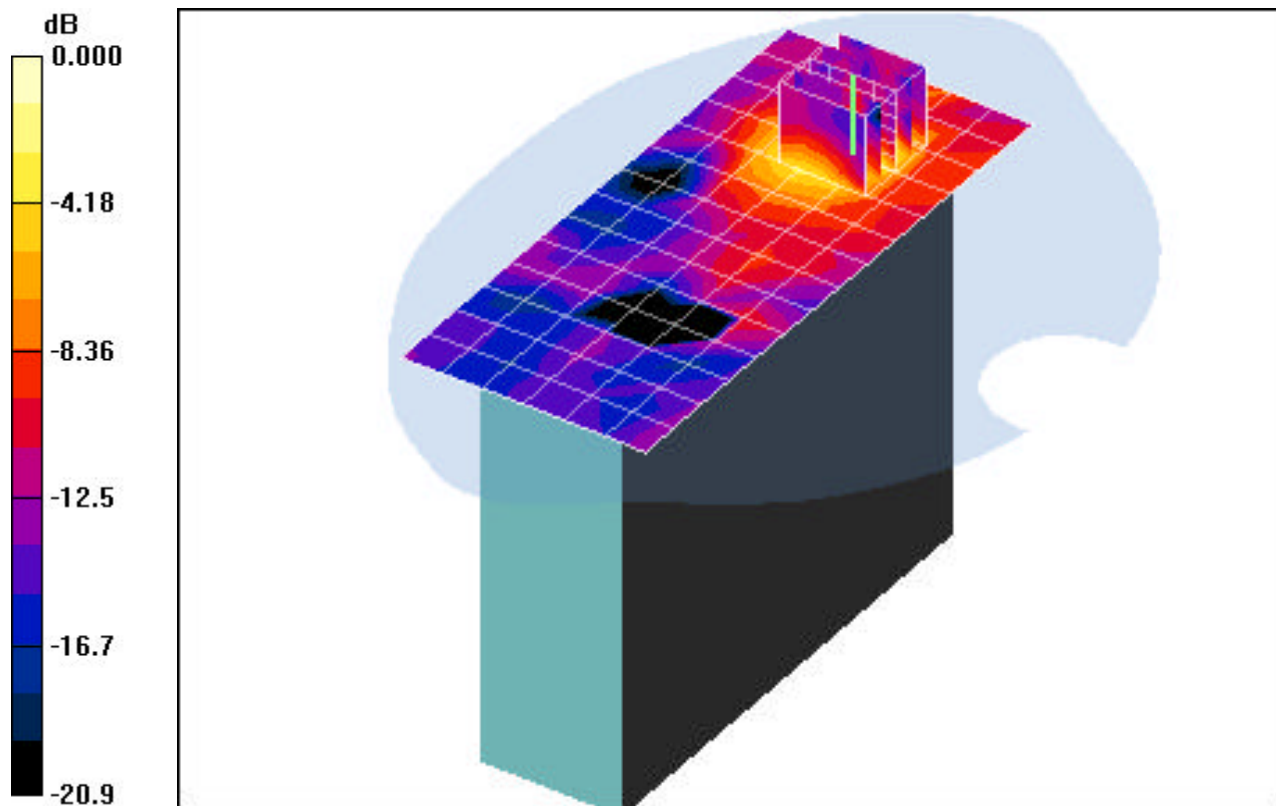

0 dB = 0.066mW/g

PCTEST ENGINEERING LABORATORY, INC.

DUT: CF-U1; Type: Tablet PC with 802.11abgn, Bluetooth, GSM and WCDMA; SN: SAR 1

Communication System: IEEE 802.11b; Frequency: 2437 MHz; Duty Cycle: 1:1

Medium: 2450 Muscle ($\sigma = 1.93$ mho/m, $\epsilon_r = 51.84$, $\rho = 1000$ kg/m³)

Phantom section: Flat Section; Space: 0.0 cm

Test Date: 08-11-2008; Ambient Temp: 23.9°C; Tissue Temp: 22.6°C

Probe: EX3DV4 - SN3561; ConvF(6.15, 6.15, 6.15); Calibrated: 8/30/2007

Sensor-Surface: 3mm (Mechanical Surface Detection)

Electronics: DAE4 Sn649; Calibrated: 1/30/2008

Phantom: SAM Main; Type: SAM 4.0; Serial: TP-1114

Measurement SW: DASY4, V4.7 Build 71; Postprocessing SW: SEMCAD, V1.8 Build 172

Mode: IEEE 802.11b, Body SAR, Laptop Position, Mid Ch, 1Mbps

Area Scan (13x15x1): Measurement grid: dx=15mm, dy=15mm

Zoom Scan (5x5x7)/Cube 0: Measurement grid: dx=8mm, dy=8mm, dz=5mm

Reference Value = 6.08 V/m

Peak SAR (extrapolated) = 0.120 W/kg

SAR(1 g) = 0.061 mW/g; SAR(10 g) = 0.034 mW/g

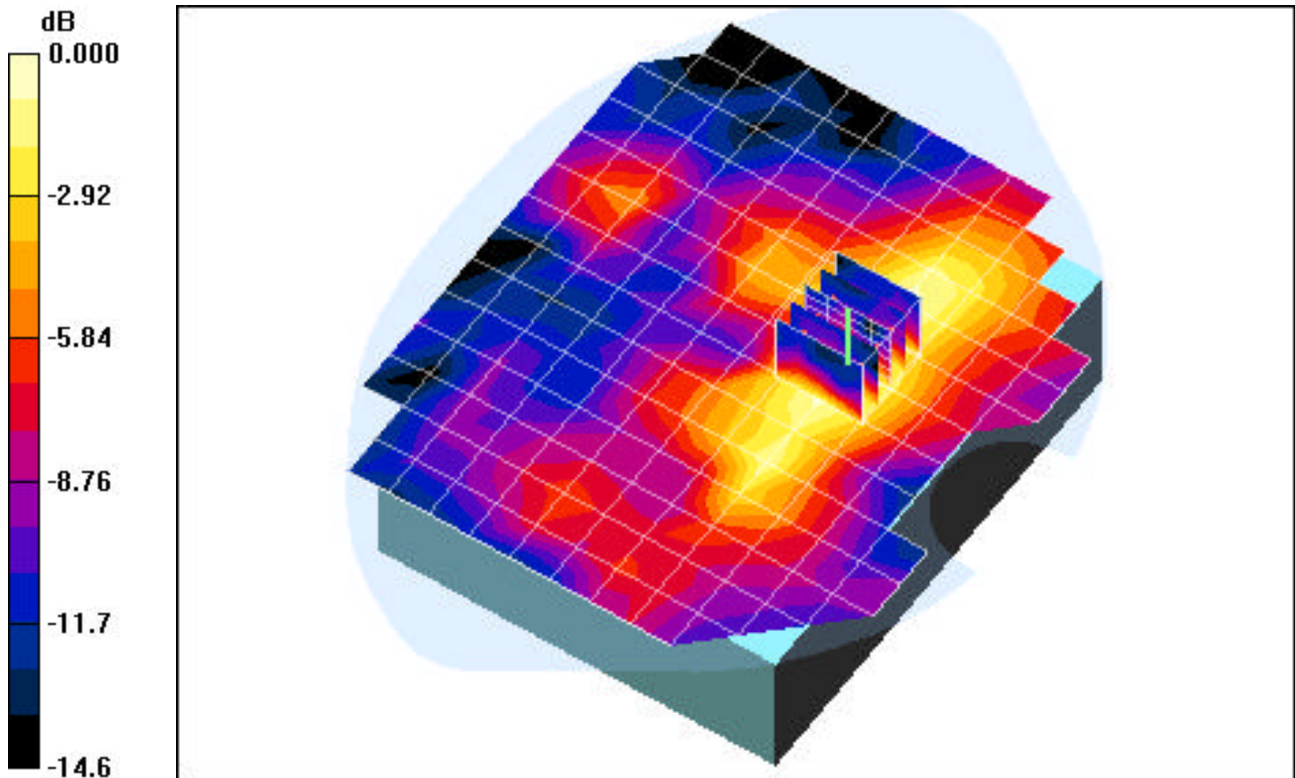

0 dB = 0.074mW/g

PCTEST ENGINEERING LABORATORY, INC.

DUT: CF-U1; Type: Tablet PC with 802.11abgn, Bluetooth, GSM and WCDMA; SN: SAR 1

Communication System: IEEE 802.11b; Frequency: 2462 MHz; Duty Cycle: 1:1

Medium: 2450 Muscle ($\sigma = 1.93$ mho/m, $\epsilon_r = 51.84$, $\rho = 1000$ kg/m³)

Phantom section: Flat Section; Space: 0.0 cm

Test Date: 08-11-2008; Ambient Temp: 23.9°C; Tissue Temp: 22.6°C

Probe: EX3DV4 - SN3561; ConvF(6.15, 6.15, 6.15); Calibrated: 8/30/2007

Sensor-Surface: 3mm (Mechanical Surface Detection)

Electronics: DAE4 Sn649; Calibrated: 1/30/2008

Phantom: SAM Main; Type: SAM 4.0; Serial: TP-1114

Measurement SW: DASY4, V4.7 Build 71; Postprocessing SW: SEMCAD, V1.8 Build 172

Mode: IEEE 802.11b, Body SAR, Tablet Position, High Ch, 1Mbps

Area Scan (7x15x1): Measurement grid: dx=15mm, dy=15mm

Zoom Scan (5x5x7)/Cube 0: Measurement grid: dx=8mm, dy=8mm, dz=5mm

Reference Value = 3.25 V/m

Peak SAR (extrapolated) = 0.040 W/kg

SAR(1 g) = 0.021 mW/g; SAR(10 g) = 0.012 mW/g

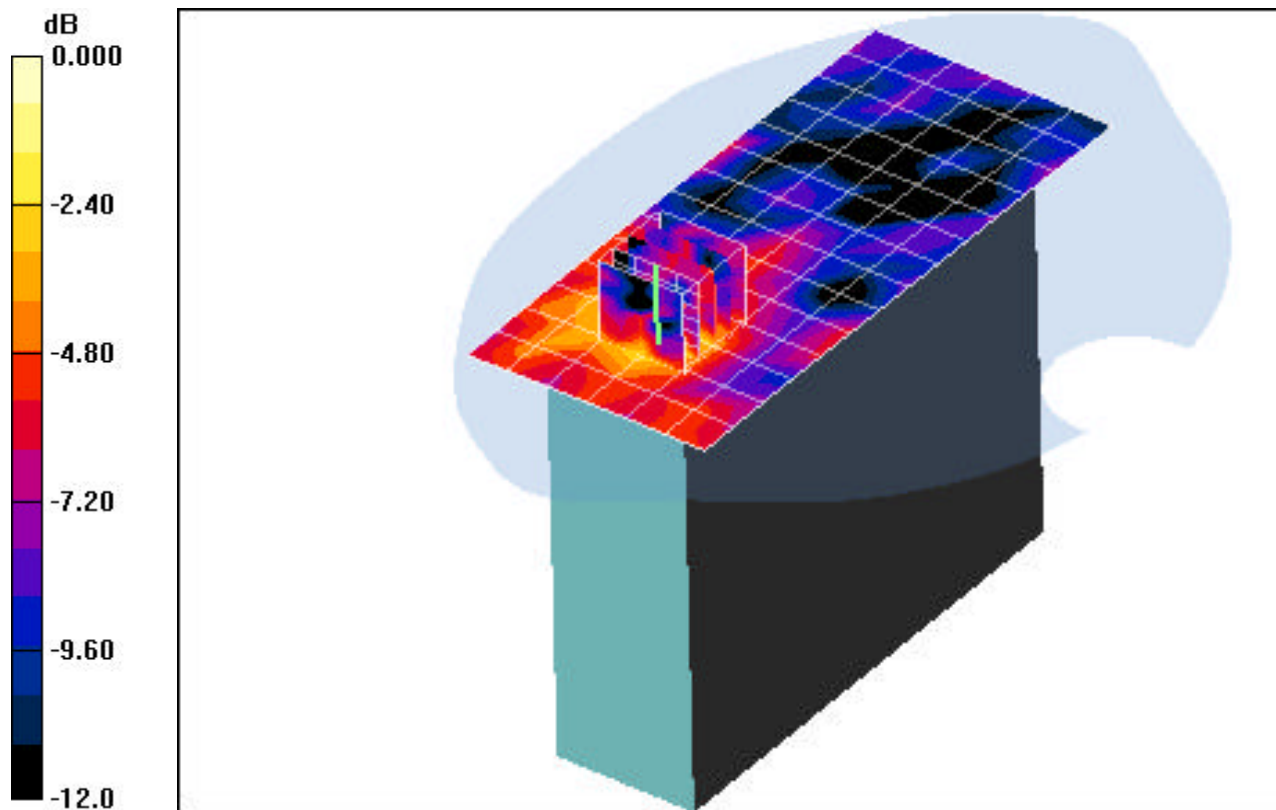

0 dB = 0.028mW/g

PCTEST ENGINEERING LABORATORY, INC.

DUT: CF-U1; Type: Tablet PC with 802.11abgn, Bluetooth, GSM and WCDMA; SN: SAR 1

Communication System: IEEE 802.11g; Frequency: 2412 MHz; Duty Cycle: 1:1

Medium: 2450 Muscle ($\sigma = 1.93$ mho/m, $\epsilon_r = 51.84$, $\rho = 1000$ kg/m³)

Phantom section: Flat Section; Space: 0.0 cm

Test Date: 08-11-2008; Ambient Temp: 23.9°C; Tissue Temp: 22.6°C

Probe: EX3DV4 - SN3561; ConvF(6.15, 6.15, 6.15); Calibrated: 8/30/2007

Sensor-Surface: 3mm (Mechanical Surface Detection)

Electronics: DAE4 Sn649; Calibrated: 1/30/2008

Phantom: SAM Main; Type: SAM 4.0; Serial: TP-1114

Measurement SW: DASY4, V4.7 Build 71; Postprocessing SW: SEMCAD, V1.8 Build 172

Mode: IEEE 802.11g, Body SAR, Laptop Position, Low Ch, 6Mbps

Area Scan (13x15x1): Measurement grid: dx=15mm, dy=15mm

Zoom Scan (5x5x7)/Cube 0: Measurement grid: dx=8mm, dy=8mm, dz=5mm

Reference Value = 5.59 V/m

Peak SAR (extrapolated) = 0.101 W/kg

SAR(1 g) = 0.051 mW/g; SAR(10 g) = 0.028 mW/g

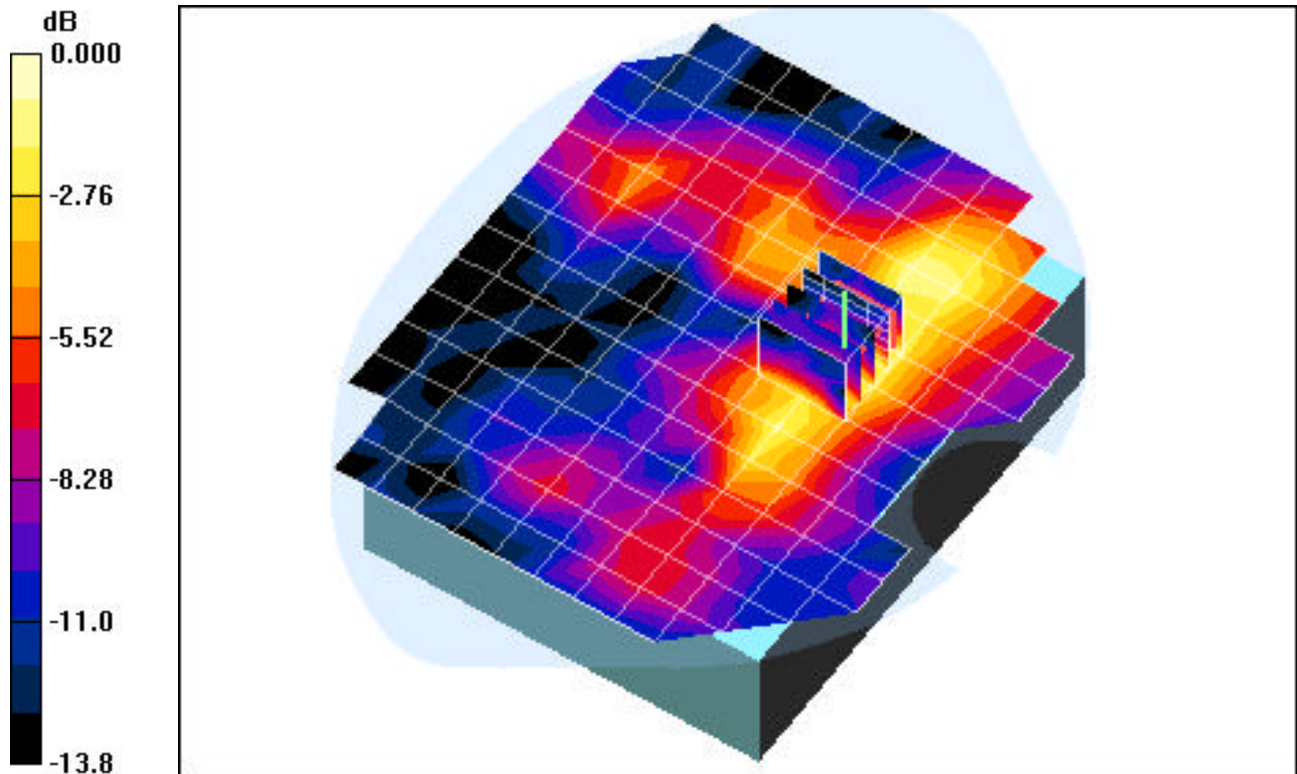

0 dB = 0.063mW/g

PCTEST ENGINEERING LABORATORY, INC.

DUT: CF-U1; Type: Tablet PC with 802.11abgn, Bluetooth, GSM and WCDMA; SN: SAR 1

Communication System: IEEE 802.11g; Frequency: 2437 MHz; Duty Cycle: 1:1

Medium: 2450 Muscle ($\sigma = 1.93$ mho/m, $\epsilon_r = 51.84$, $\rho = 1000$ kg/m³)

Phantom section: Flat Section; Space: 0.0 cm

Test Date: 08-11-2008; Ambient Temp: 23.9°C; Tissue Temp: 22.6°C

Probe: EX3DV4 - SN3561; ConvF(6.15, 6.15, 6.15); Calibrated: 8/30/2007

Sensor-Surface: 3mm (Mechanical Surface Detection)

Electronics: DAE4 Sn649; Calibrated: 1/30/2008

Phantom: SAM Main; Type: SAM 4.0; Serial: TP-1114

Measurement SW: DASY4, V4.7 Build 71; Postprocessing SW: SEMCAD, V1.8 Build 172

Mode: IEEE 802.11g, Body SAR, Tablet Position, Mid Ch, 6Mbps

Area Scan (7x15x1): Measurement grid: dx=15mm, dy=15mm

Zoom Scan (5x5x7)/Cube 0: Measurement grid: dx=8mm, dy=8mm, dz=5mm

Reference Value = 2.45 V/m

Peak SAR (extrapolated) = 0.037 W/kg

SAR(1 g) = 0.018 mW/g; SAR(10 g) = 0.00781 mW/g

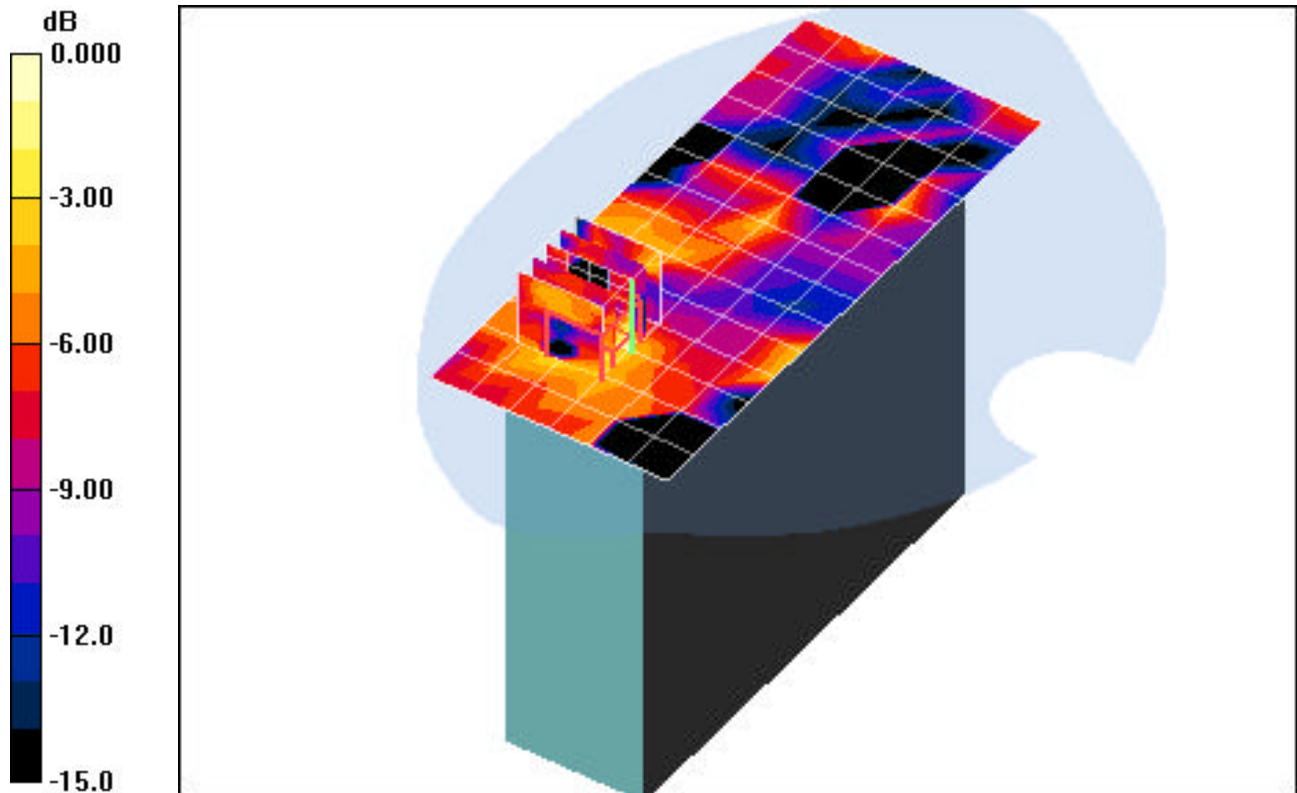

0 dB = 0.028mW/g

PCTEST ENGINEERING LABORATORY, INC.

DUT: CF-U1; Type: Tablet PC with 802.11abgn, Bluetooth, GSM and WCDMA; SN: SAR 1

Communication System: IEEE 802.11n; Frequency: 2422 MHz; Duty Cycle: 1:1

Medium: 2450 Muscle ($\sigma = 1.93$ mho/m, $\epsilon_r = 51.84$, $\rho = 1000$ kg/m³)

Phantom section: Flat Section; Space: 0.0 cm

Test Date: 08-11-2008; Ambient Temp: 23.9°C; Tissue Temp: 22.6°C

Probe: EX3DV4 - SN3561; ConvF(6.15, 6.15, 6.15); Calibrated: 8/30/2007

Sensor-Surface: 3mm (Mechanical Surface Detection)

Electronics: DAE4 Sn649; Calibrated: 1/30/2008

Phantom: SAM Main; Type: SAM 4.0; Serial: TP-1114

Measurement SW: DASY4, V4.7 Build 71; Postprocessing SW: SEMCAD, V1.8 Build 172

Mode: IEEE 802.11n 2.4GHz, Body SAR, Laptop Position, Low Ch, 13.5Mbps

Area Scan (13x15x1): Measurement grid: dx=15mm, dy=15mm

Zoom Scan (5x5x7)/Cube 0: Measurement grid: dx=8mm, dy=8mm, dz=5mm

Reference Value = 5.07 V/m

Peak SAR (extrapolated) = 0.100 W/kg

SAR(1 g) = 0.045 mW/g; SAR(10 g) = 0.024 mW/g

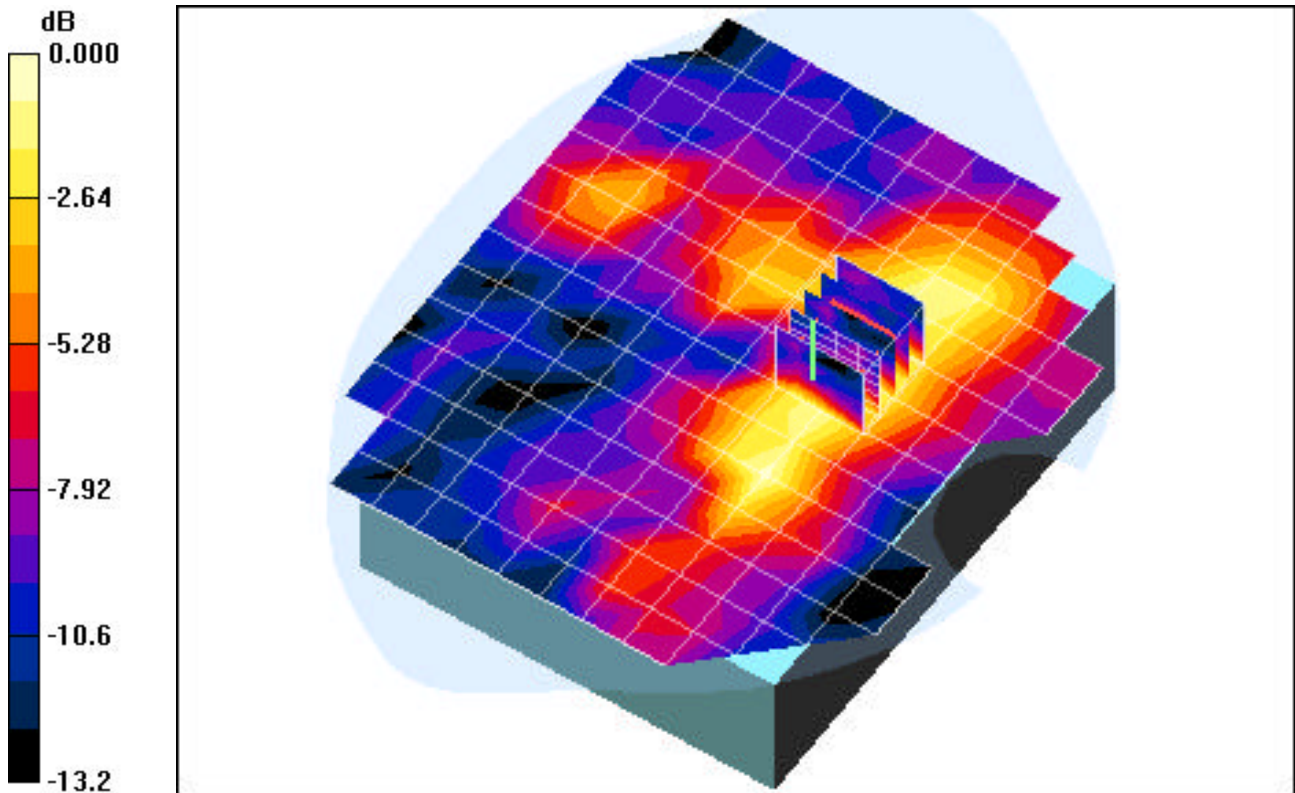

0 dB = 0.054mW/g

PCTEST ENGINEERING LABORATORY, INC.

DUT: CF-U1; Type: Tablet PC with 802.11abgn, Bluetooth, GSM and WCDMA; SN: SAR 1

Communication System: IEEE 802.11n; Frequency: 2452 MHz; Duty Cycle: 1:1

Medium: 2450 Muscle ($\sigma = 1.93$ mho/m, $\epsilon_r = 51.84$, $\rho = 1000$ kg/m³)

Phantom section: Flat Section; Space: 0.0 cm

Test Date: 08-11-2008; Ambient Temp: 23.9°C; Tissue Temp: 22.6°C

Probe: EX3DV4 - SN3561; ConvF(6.15, 6.15, 6.15); Calibrated: 8/30/2007

Sensor-Surface: 3mm (Mechanical Surface Detection)

Electronics: DAE4 Sn649; Calibrated: 1/30/2008

Phantom: SAM Main; Type: SAM 4.0; Serial: TP-1114

Measurement SW: DASY4, V4.7 Build 71; Postprocessing SW: SEMCAD, V1.8 Build 172

Mode: IEEE 802.11n 2.4GHz, Body SAR, Tablet Position, Mid Ch, 13.5Mbps

Area Scan (7x15x1): Measurement grid: dx=15mm, dy=15mm

Zoom Scan (5x5x7)/Cube 0: Measurement grid: dx=8mm, dy=8mm, dz=5mm

Reference Value = 2.77 V/m

Peak SAR (extrapolated) = 0.033 W/kg

SAR(1 g) = 0.017 mW/g; SAR(10 g) = 0.0089 mW/g

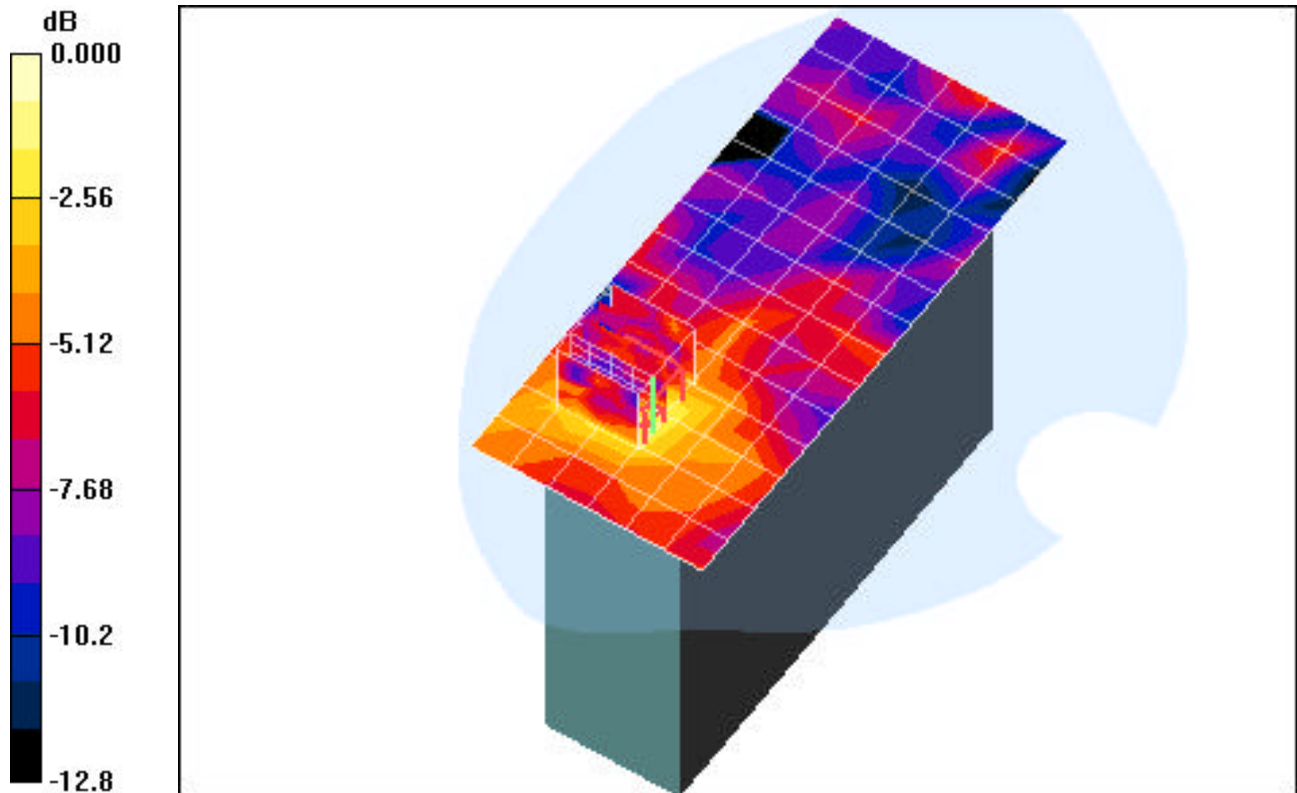

0 dB = 0.022mW/g

PCTEST ENGINEERING LABORATORY, INC.

DUT: CF-U1; Type: Tablet PC with 802.11abgn, Bluetooth, GSM and WCDMA; SN: SAR 1

Communication System: IEEE 802.11a 5.2GHz Band; Frequency: 5200 MHz; Duty Cycle: 1:1

Medium: 5300 Muscle ($\sigma = 5.41$ mho/m, $\epsilon_r = 49.81$, $\rho = 1000$ kg/m³)

Phantom section: Flat Section; Space: 0.0 cm

Test Date: 08-11-2008; Ambient Temp: 23.9°C; Tissue Temp: 22.7°C

Probe: EX3DV4 - SN3561; ConvF(3.83, 3.83, 3.83); Calibrated: 8/30/2007

Sensor-Surface: 3mm (Mechanical Surface Detection)

Electronics: DAE4 Sn649; Calibrated: 1/30/2008

Phantom: SAM Main; Type: SAM 4.0; Serial: TP-1114

Measurement SW: DASY4, V4.7 Build 71; Postprocessing SW: SEMCAD, V1.8 Build 172

Mode: IEEE 802.11a 5.2GHz, Body SAR, Laptop Position, Ch.40, 6Mbps

Area Scan (18x21x1): Measurement grid: dx=10mm, dy=10mm

Zoom Scan (8x8x8)/Cube 0: Measurement grid: dx=4.3mm, dy=4.3mm, dz=3mm

Reference Value = 4.68 V/m

Peak SAR (extrapolated) = 0.400 W/kg

SAR(1 g) = 0.090 mW/g; SAR(10 g) = 0.044 mW/g

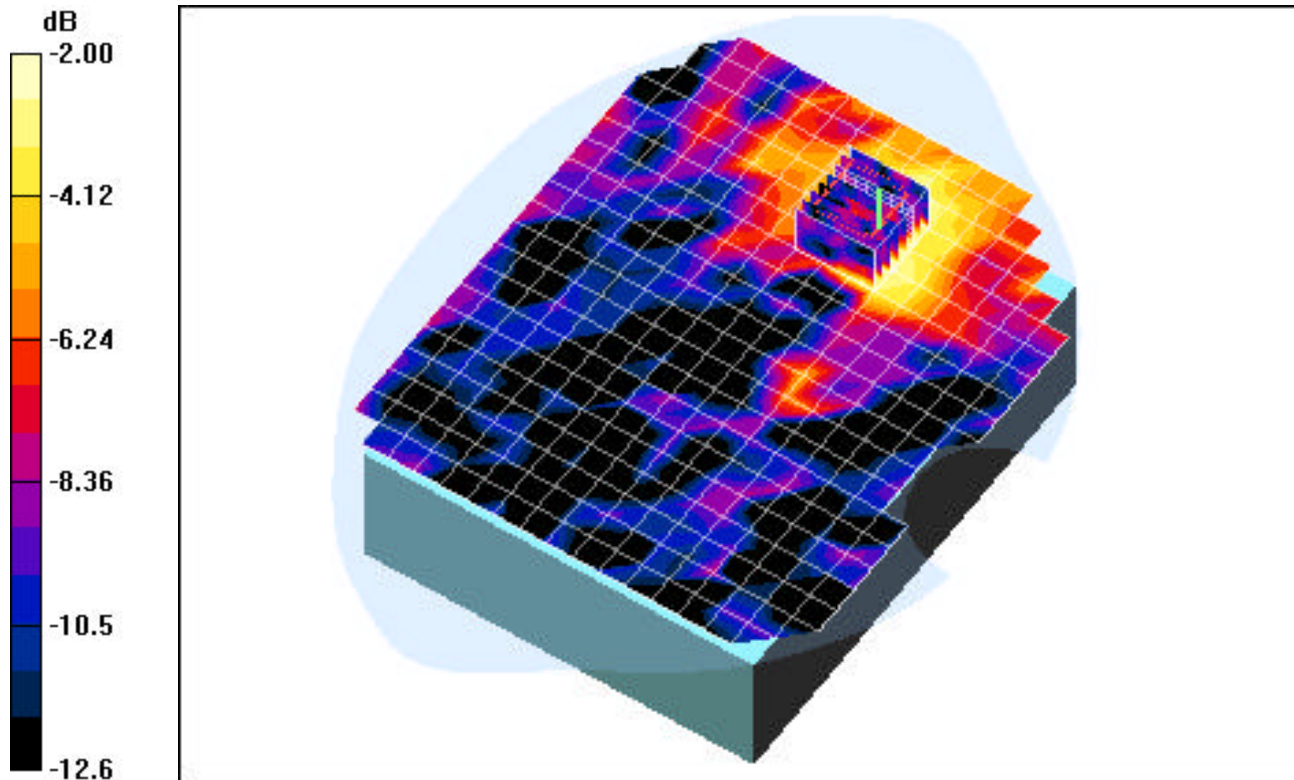

0 dB = 0.129mW/g

PCTEST ENGINEERING LABORATORY, INC.

DUT: CF-U1; Type: Tablet PC with 802.11abgn, Bluetooth, GSM and WCDMA; SN: SAR 1

Communication System: IEEE 802.11a 5.2GHz Band; Frequency: 5200 MHz; Duty Cycle: 1:1

Medium: 5300 Muscle ($\sigma = 5.41$ mho/m, $\epsilon_r = 49.81$, $\rho = 1000$ kg/m³)

Phantom section: Flat Section; Space: 0.0 cm

Test Date: 08-11-2008; Ambient Temp: 23.9°C; Tissue Temp: 22.7°C

Probe: EX3DV4 - SN3561; ConvF(3.83, 3.83, 3.83); Calibrated: 8/30/2007

Sensor-Surface: 3mm (Mechanical Surface Detection)

Electronics: DAE4 Sn649; Calibrated: 1/30/2008

Phantom: SAM Main; Type: SAM 4.0; Serial: TP-1114

Measurement SW: DASY4, V4.7 Build 71; Postprocessing SW: SEMCAD, V1.8 Build 172

Mode: IEEE 802.11a 5.2GHz, Body SAR, Tablet Position, Ch.40, 6Mbps

Area Scan (8x21x1): Measurement grid: dx=10mm, dy=10mm

Zoom Scan (8x8x8)/Cube 0: Measurement grid: dx=4.3mm, dy=4.3mm, dz=3mm

Reference Value = 2.60 V/m

Peak SAR (extrapolated) = 0.095 W/kg

SAR(1 g) = 0.016 mW/g; SAR(10 g) = 0.011 mW/g

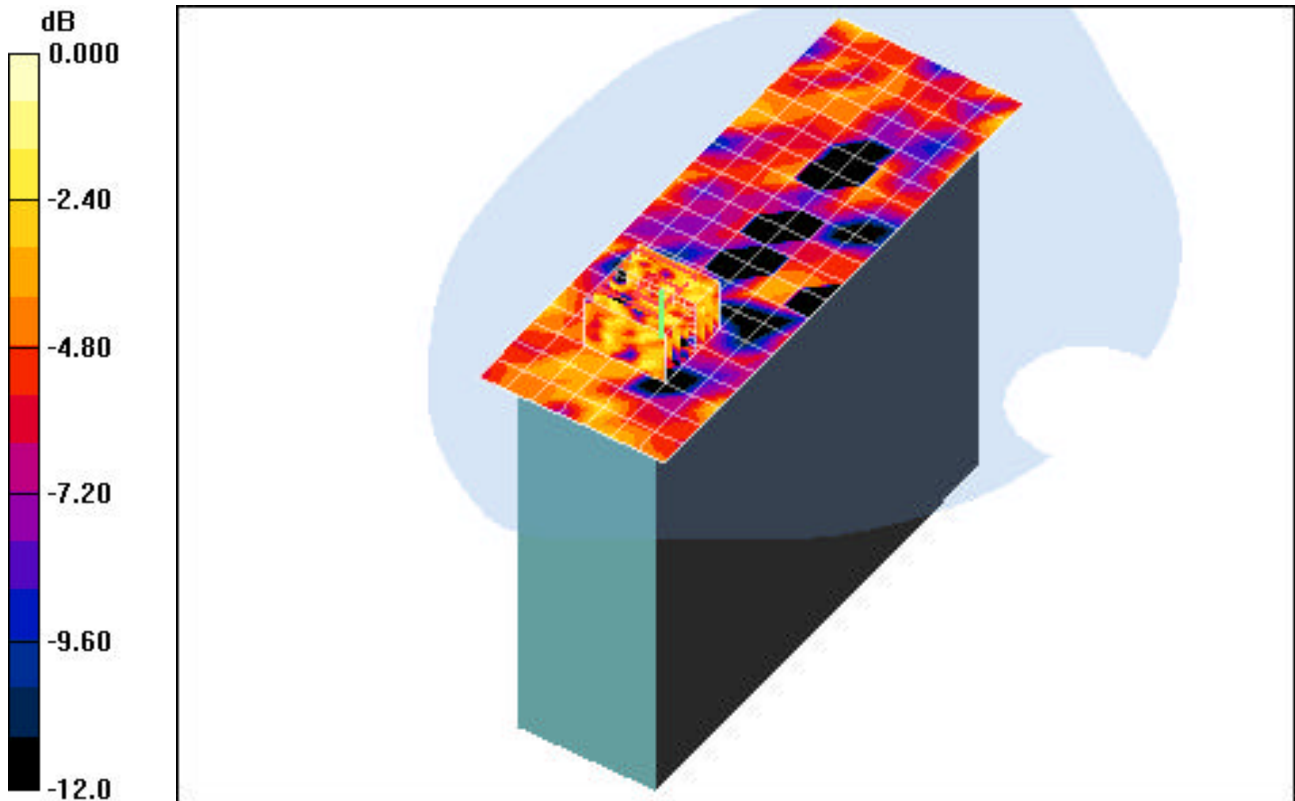

0 dB = 0.034mW/g

PCTEST ENGINEERING LABORATORY, INC.

DUT: CF-U1; Type: Tablet PC with 802.11abgn, Bluetooth, GSM and WCDMA; SN: SAR 1

Communication System: IEEE 802.11n 5.2GHz Band; Frequency: 5190 MHz; Duty Cycle: 1:1

Medium: 5300 Muscle ($\sigma = 5.41$ mho/m, $\epsilon_r = 49.81$, $\rho = 1000$ kg/m³)

Phantom section: Flat Section; Space: 0.0 cm

Test Date: 08-11-2008; Ambient Temp: 23.9°C; Tissue Temp: 22.7°C

Probe: EX3DV4 - SN3561; ConvF(3.83, 3.83, 3.83); Calibrated: 8/30/2007

Sensor-Surface: 3mm (Mechanical Surface Detection)

Electronics: DAE4 Sn649; Calibrated: 1/30/2008

Phantom: SAM Main; Type: SAM 4.0; Serial: TP-1114

Measurement SW: DASY4, V4.7 Build 71; Postprocessing SW: SEMCAD, V1.8 Build 172

Mode: IEEE 802.11n 5.2GHz, Body SAR, Laptop Position, Ch.38, 13.5Mbps

Area Scan (18x21x1): Measurement grid: dx=10mm, dy=10mm

Zoom Scan (8x8x8)/Cube 0: Measurement grid: dx=4.3mm, dy=4.3mm, dz=3mm

Reference Value = 4.15 V/m

Peak SAR (extrapolated) = 0.464 W/kg

SAR(1 g) = 0.093 mW/g; SAR(10 g) = 0.046 mW/g

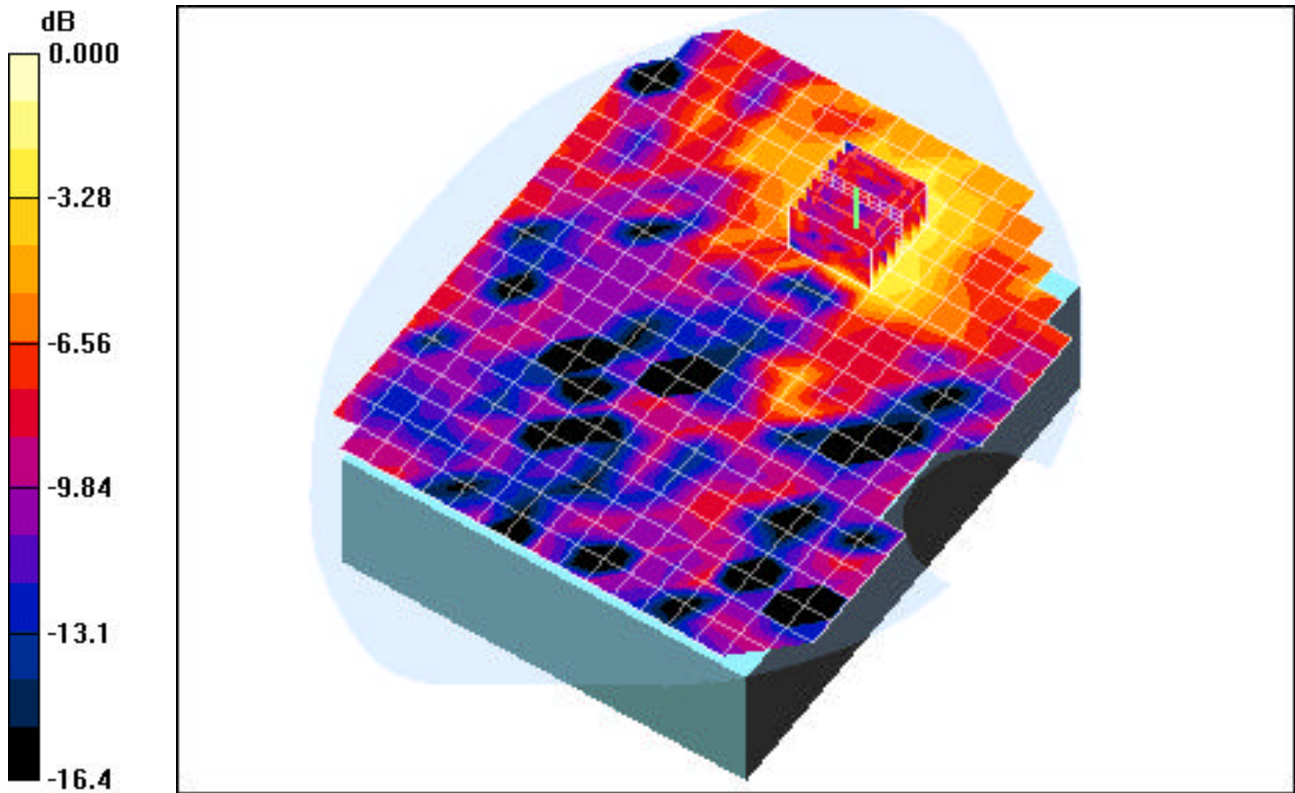

0 dB = 0.116mW/g

PCTEST ENGINEERING LABORATORY, INC.

DUT: CF-U1; Type: Tablet PC with 802.11abgn, Bluetooth, GSM and WCDMA; SN: SAR 1

Communication System: IEEE 802.11n 5.2GHz Band; Frequency: 5230 MHz; Duty Cycle: 1:1

Medium: 5300 Muscle ($\sigma = 5.41$ mho/m, $\epsilon_r = 49.81$, $\rho = 1000$ kg/m³)

Phantom section: Flat Section; Space: 0.0 cm

Test Date: 08-11-2008; Ambient Temp: 23.9°C; Tissue Temp: 22.7°C

Probe: EX3DV4 - SN3561; ConvF(3.83, 3.83, 3.83); Calibrated: 8/30/2007

Sensor-Surface: 3mm (Mechanical Surface Detection)

Electronics: DAE4 Sn649; Calibrated: 1/30/2008

Phantom: SAM Main; Type: SAM 4.0; Serial: TP-1114

Measurement SW: DASY4, V4.7 Build 71; Postprocessing SW: SEMCAD, V1.8 Build 172

Mode: IEEE 802.11n 5.2GHz, Body SAR, Tablet Position, Ch.46, 13.5Mbps

Area Scan (8x21x1): Measurement grid: dx=10mm, dy=10mm

Zoom Scan (8x8x8)/Cube 0: Measurement grid: dx=4.3mm, dy=4.3mm, dz=3mm

Reference Value = 1.72 V/m

Peak SAR (extrapolated) = 0.089 W/kg

SAR(1 g) = 0.016 mW/g; SAR(10 g) = 0.011 mW/g

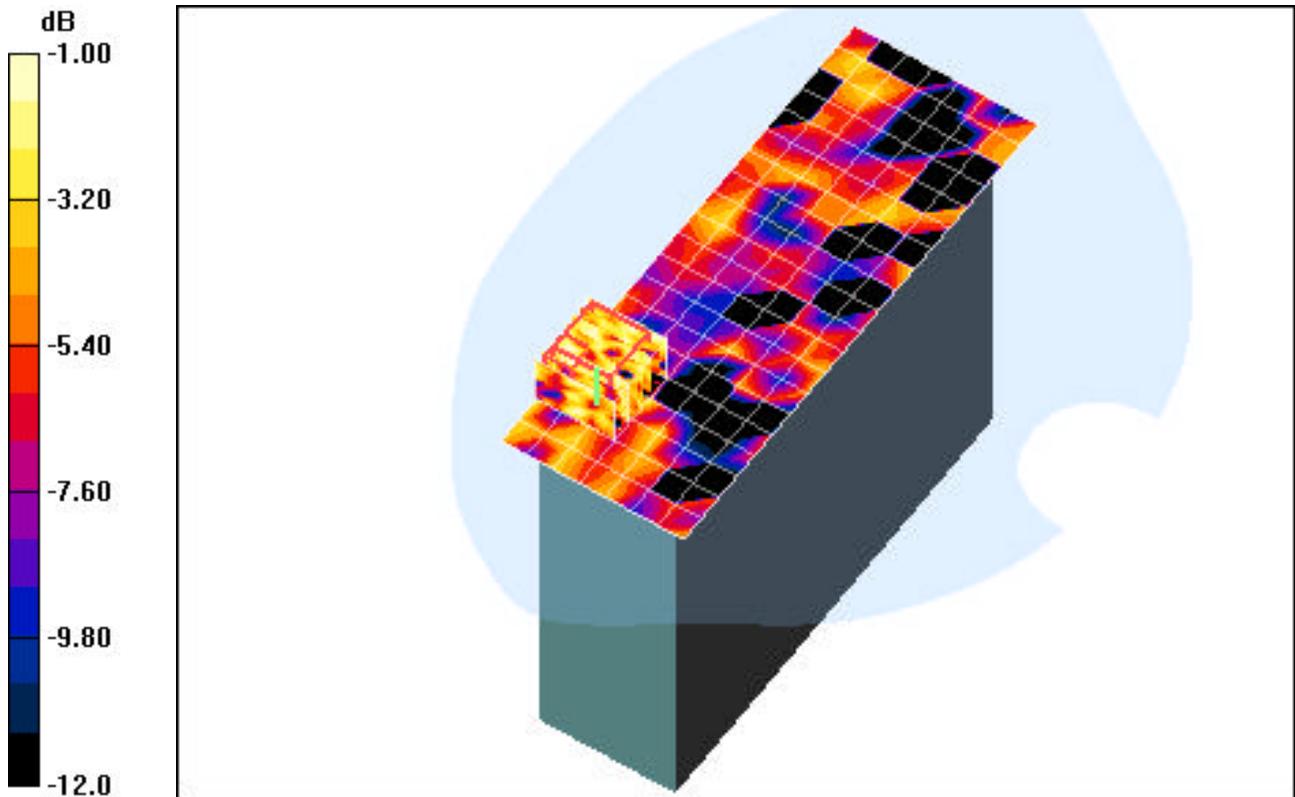

0 dB = 0.032mW/g

PCTEST ENGINEERING LABORATORY, INC.

DUT: CF-U1; Type: Tablet PC with 802.11abgn, Bluetooth, GSM and WCDMA; SN: SAR 1

Communication System: IEEE 802.11a 5.3GHz Band; Frequency: 5300 MHz; Duty Cycle: 1:1

Medium: 5300 Muscle ($\sigma = 5.41$ mho/m, $\epsilon_r = 49.81$, $\rho = 1000$ kg/m³)

Phantom section: Flat Section; Space: 0.0 cm

Test Date: 08-11-2008; Ambient Temp: 23.9°C; Tissue Temp: 22.7°C

Probe: EX3DV4 - SN3561; ConvF(3.67, 3.67, 3.67); Calibrated: 8/30/2007

Sensor-Surface: 3mm (Mechanical Surface Detection)

Electronics: DAE4 Sn649; Calibrated: 1/30/2008

Phantom: SAM Main; Type: SAM 4.0; Serial: TP-1114

Measurement SW: DASY4, V4.7 Build 71; Postprocessing SW: SEMCAD, V1.8 Build 172

Mode: IEEE 802.11a 5.3GHz, Body SAR, Laptop Position, Ch.60, 6Mbps

Area Scan (18x21x1): Measurement grid: dx=10mm, dy=10mm

Zoom Scan (8x8x8)/Cube 0: Measurement grid: dx=4.3mm, dy=4.3mm, dz=3mm

Reference Value = 3.85 V/m

Peak SAR (extrapolated) = 0.479 W/kg

SAR(1 g) = 0.068 mW/g; SAR(10 g) = 0.035 mW/g

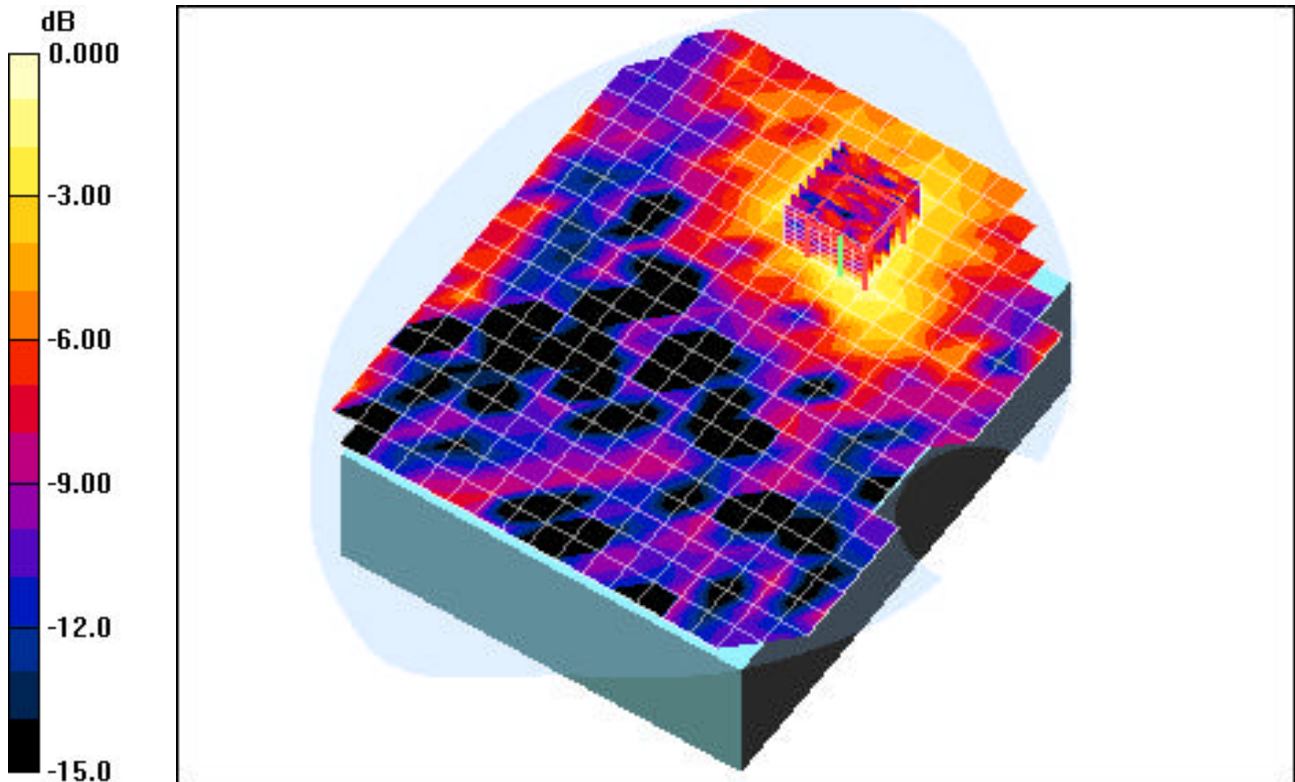

0 dB = 0.098mW/g

PCTEST ENGINEERING LABORATORY, INC.

DUT: CF-U1; Type: Tablet PC with 802.11abgn, Bluetooth, GSM and WCDMA; SN: SAR 1

Communication System: IEEE 802.11a 5.3GHz Band; Frequency: 5300 MHz; Duty Cycle: 1:1

Medium: 5300 Muscle ($\sigma = 5.41$ mho/m, $\epsilon_r = 49.81$, $\rho = 1000$ kg/m³)

Phantom section: Flat Section; Space: 0.0 cm

Test Date: 08-11-2008; Ambient Temp: 23.9°C; Tissue Temp: 22.7°C

Probe: EX3DV4 - SN3561; ConvF(3.67, 3.67, 3.67); Calibrated: 8/30/2007

Sensor-Surface: 3mm (Mechanical Surface Detection)

Electronics: DAE4 Sn649; Calibrated: 1/30/2008

Phantom: SAM Main; Type: SAM 4.0; Serial: TP-1114

Measurement SW: DASY4, V4.7 Build 71; Postprocessing SW: SEMCAD, V1.8 Build 172

Mode: IEEE 802.11a 5.3GHz, Body SAR, Tablet Position, Ch.60, 6Mbps

Area Scan (8x21x1): Measurement grid: dx=10mm, dy=10mm

Zoom Scan (8x8x8)/Cube 0: Measurement grid: dx=4.3mm, dy=4.3mm, dz=3mm

Reference Value = 2.84 V/m

Peak SAR (extrapolated) = 0.084 W/kg

SAR(1 g) = 0.019 mW/g; SAR(10 g) = 0.011 mW/g

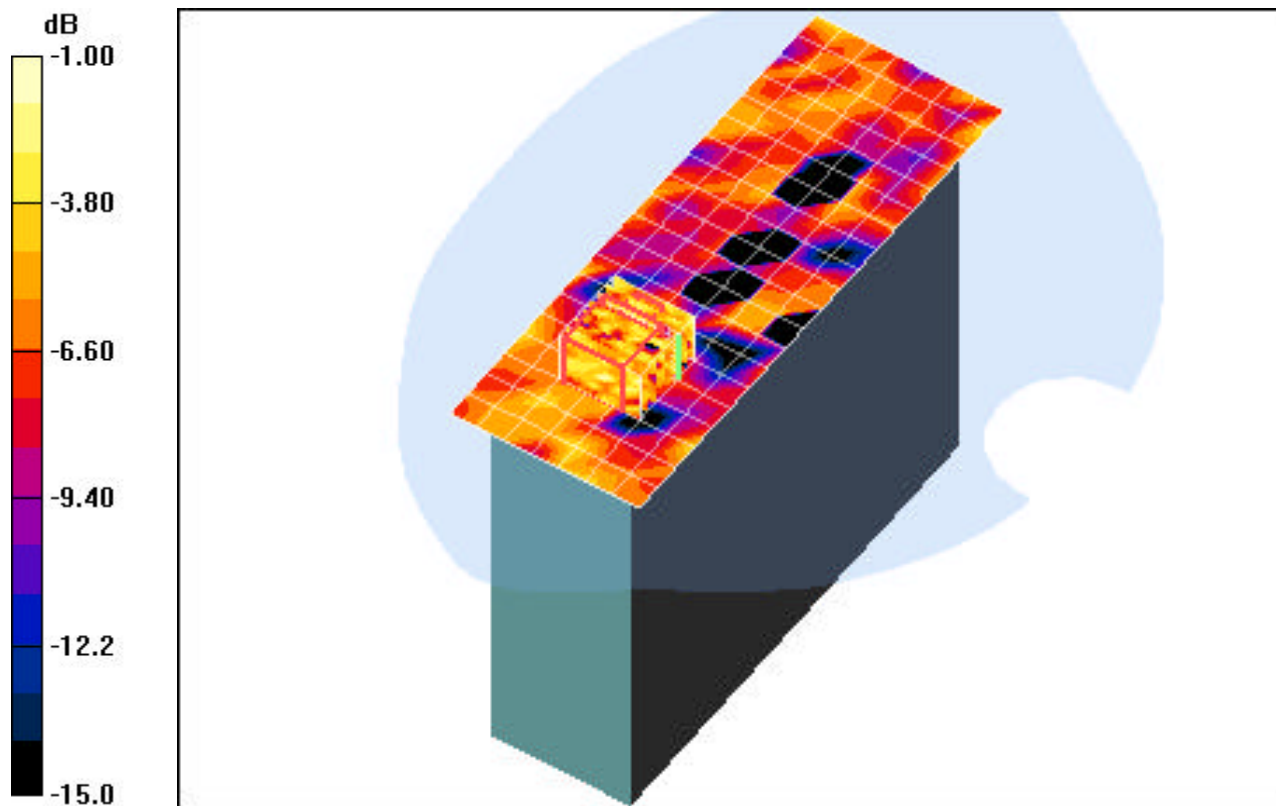

0 dB = 0.048mW/g

PCTEST ENGINEERING LABORATORY, INC.

DUT: CF-U1; Type: Tablet PC with 802.11abgn, Bluetooth, GSM and WCDMA; SN: SAR 1

Communication System: IEEE 802.11n 5.3GHz Band; Frequency: 5270 MHz; Duty Cycle: 1:1

Medium: 5300 Muscle ($\sigma = 5.41$ mho/m, $\epsilon_r = 49.81$, $\rho = 1000$ kg/m³)

Phantom section: Flat Section; Space: 0.0 cm

Test Date: 08-11-2008; Ambient Temp: 23.9°C; Tissue Temp: 22.7°C

Probe: EX3DV4 - SN3561; ConvF(3.67, 3.67, 3.67); Calibrated: 8/30/2007

Sensor-Surface: 3mm (Mechanical Surface Detection)

Electronics: DAE4 Sn649; Calibrated: 1/30/2008

Phantom: SAM Main; Type: SAM 4.0; Serial: TP-1114

Measurement SW: DASY4, V4.7 Build 71; Postprocessing SW: SEMCAD, V1.8 Build 172

Mode: IEEE 802.11n 5.3GHz, Body SAR, Laptop Position, Ch.54, 13.5Mbps

Area Scan (18x21x1): Measurement grid: dx=10mm, dy=10mm

Zoom Scan (8x8x8)/Cube 0: Measurement grid: dx=4.3mm, dy=4.3mm, dz=3mm

Reference Value = 3.83 V/m

Peak SAR (extrapolated) = 0.438 W/kg

SAR(1 g) = 0.077 mW/g; SAR(10 g) = 0.039 mW/g

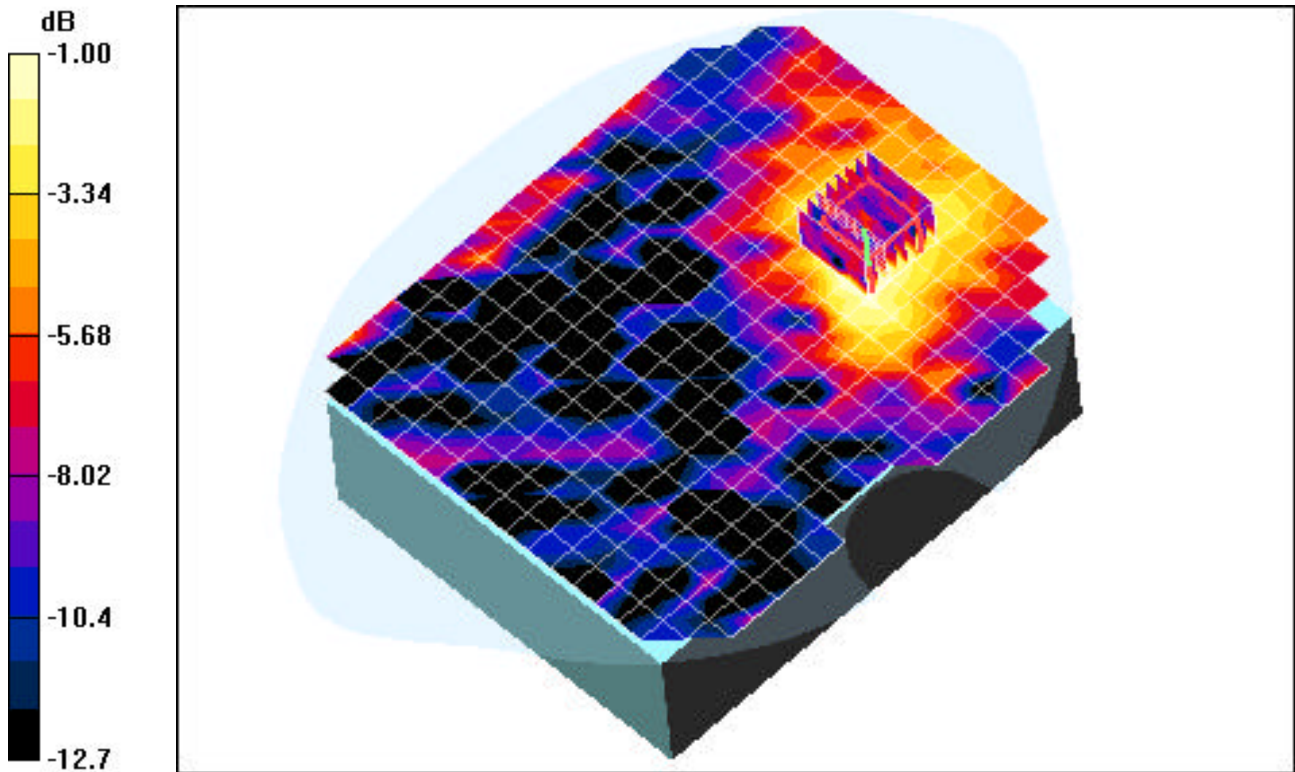

0 dB = 0.098mW/g

PCTEST ENGINEERING LABORATORY, INC.

DUT: CF-U1; Type: Tablet PC with 802.11abgn, Bluetooth, GSM and WCDMA; SN: SAR 1

Communication System: IEEE 802.11n 5.3GHz Band; Frequency: 5270 MHz; Duty Cycle: 1:1

Medium: 5300 Muscle ($\sigma = 5.41$ mho/m, $\epsilon_r = 49.81$, $\rho = 1000$ kg/m³)

Phantom section: Flat Section; Space: 0.0 cm

Test Date: 08-11-2008; Ambient Temp: 23.9°C; Tissue Temp: 22.7°C

Probe: EX3DV4 - SN3561; ConvF(3.67, 3.67, 3.67); Calibrated: 8/30/2007

Sensor-Surface: 3mm (Mechanical Surface Detection)

Electronics: DAE4 Sn649; Calibrated: 1/30/2008

Phantom: SAM Main; Type: SAM 4.0; Serial: TP-1114

Measurement SW: DASY4, V4.7 Build 71; Postprocessing SW: SEMCAD, V1.8 Build 172

Mode: IEEE 802.11n 5.3GHz, Body SAR, Tablet Position, Ch.54, 13.5Mbps

Area Scan (8x21x1): Measurement grid: dx=10mm, dy=10mm

Zoom Scan (8x8x8)/Cube 0: Measurement grid: dx=4.3mm, dy=4.3mm, dz=3mm

Reference Value = 1.26 V/m

Peak SAR (extrapolated) = 0.072 W/kg

SAR(1 g) = 0.015 mW/g; SAR(10 g) = 0.011 mW/g

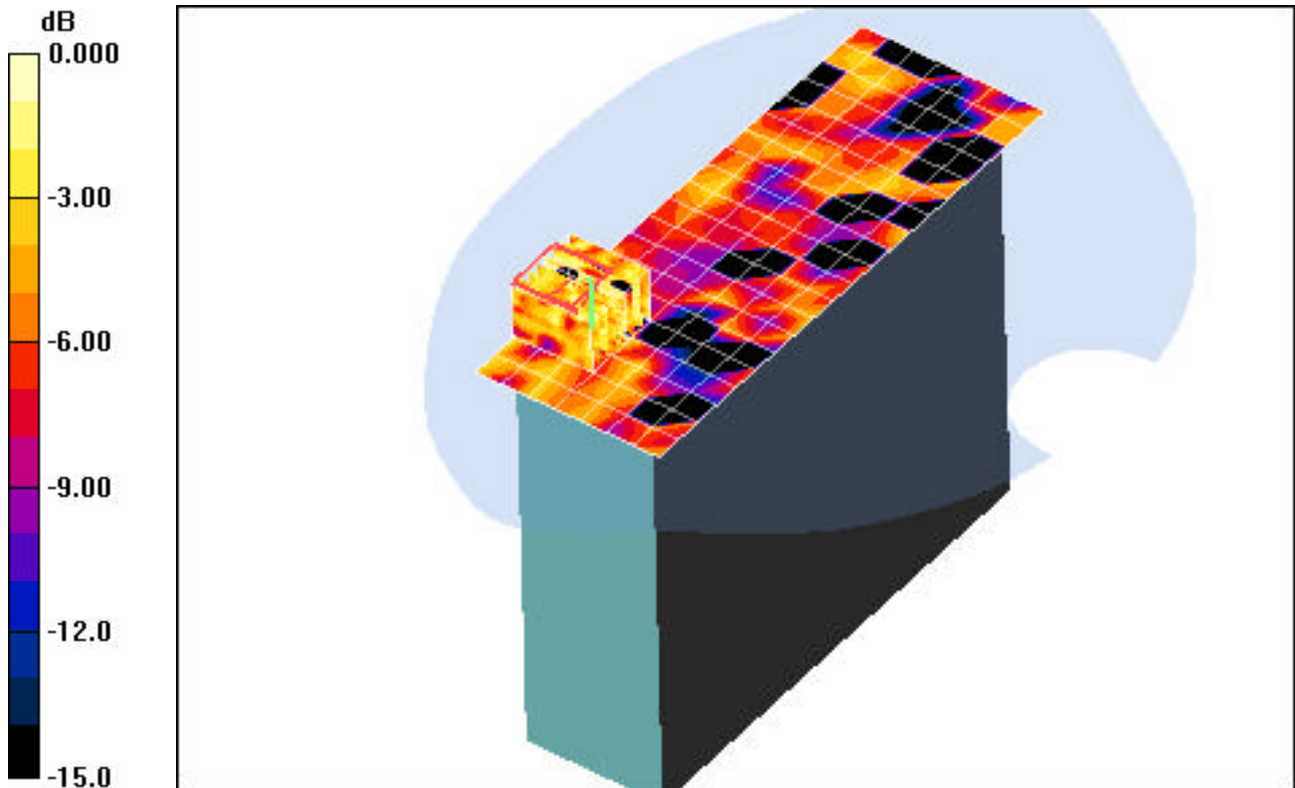

0 dB = 0.033mW/g

PCTEST ENGINEERING LABORATORY, INC.

DUT: CF-U1; Type: Tablet PC with 802.11abgn, Bluetooth, GSM and WCDMA; SN: SAR 1

Communication System: IEEE 802.11a 5.5GHz Band; Frequency: 5600 MHz; Duty Cycle: 1:1

Medium: 5500 Muscle ($\sigma = 5.82$ mho/m, $\epsilon_r = 49.31$, $\rho = 1000$ kg/m³)

Phantom section: Flat Section; Space: 0.0 cm

Test Date: 08-12-2008; Ambient Temp: 23.6°C; Tissue Temp: 22.4°C

Probe: EX3DV4 - SN3561; ConvF(3.81, 3.81, 3.81); Calibrated: 8/30/2007

Sensor-Surface: 3mm (Mechanical Surface Detection)

Electronics: DAE4 Sn649; Calibrated: 1/30/2008

Phantom: SAM Main; Type: SAM 4.0; Serial: TP-1114

Measurement SW: DASY4, V4.7 Build 71; Postprocessing SW: SEMCAD, V1.8 Build 172

Mode: IEEE 802.11a 5.5GHz, Body SAR, Laptop Position, Ch.120, 6Mbps

Area Scan (18x21x1): Measurement grid: dx=10mm, dy=10mm

Zoom Scan (8x8x8)/Cube 0: Measurement grid: dx=4.3mm, dy=4.3mm, dz=3mm

Reference Value = 4.63 V/m

Peak SAR (extrapolated) = 0.813 W/kg

SAR(1 g) = 0.104 mW/g; SAR(10 g) = 0.049 mW/g

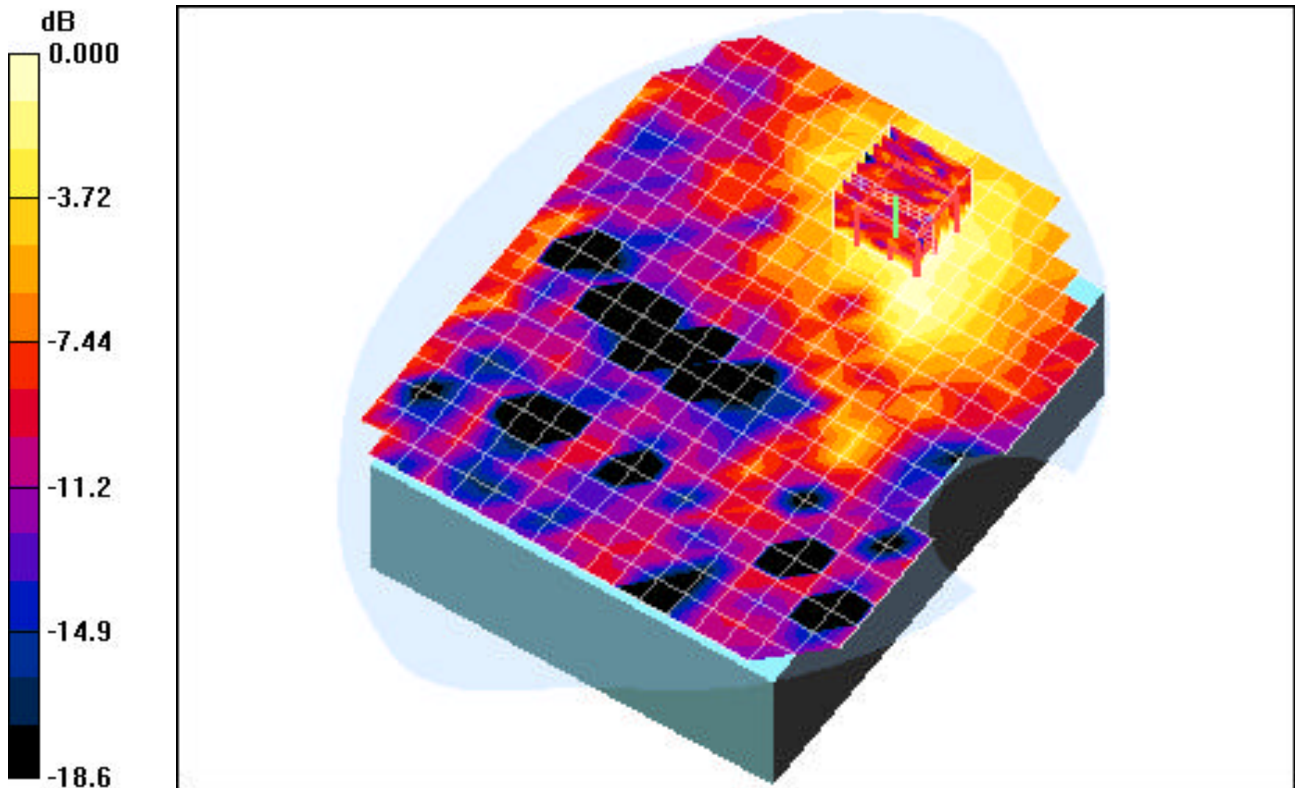

0 dB = 0.129mW/g

PCTEST ENGINEERING LABORATORY, INC.

DUT: CF-U1; Type: Tablet PC with 802.11abgn, Bluetooth, GSM and WCDMA; SN: SAR 1

Communication System: IEEE 802.11a 5.5GHz Band; Frequency: 5540 MHz; Duty Cycle: 1:1

Medium: 5500 Muscle ($\sigma = 5.82$ mho/m, $\epsilon_r = 49.31$, $\rho = 1000$ kg/m³)

Phantom section: Flat Section; Space: 0.0 cm

Test Date: 08-12-2008; Ambient Temp: 23.6°C; Tissue Temp: 22.4°C

Probe: EX3DV4 - SN3561; ConvF(3.67, 3.67, 3.67); Calibrated: 8/30/2007

Sensor-Surface: 3mm (Mechanical Surface Detection)

Electronics: DAE4 Sn649; Calibrated: 1/30/2008

Phantom: SAM Main; Type: SAM 4.0; Serial: TP-1114

Measurement SW: DASY4, V4.7 Build 71; Postprocessing SW: SEMCAD, V1.8 Build 172

Mode: IEEE 802.11a 5.5GHz, Body SAR, Tablet Position, Ch.108, 6Mbps

Area Scan (8x21x1): Measurement grid: dx=10mm, dy=10mm

Zoom Scan (8x8x8)/Cube 0: Measurement grid: dx=4.3mm, dy=4.3mm, dz=3mm

Reference Value = 2.08 V/m

Peak SAR (extrapolated) = 0.116 W/kg

SAR(1 g) = 0.022 mW/g; SAR(10 g) = 0.013 mW/g

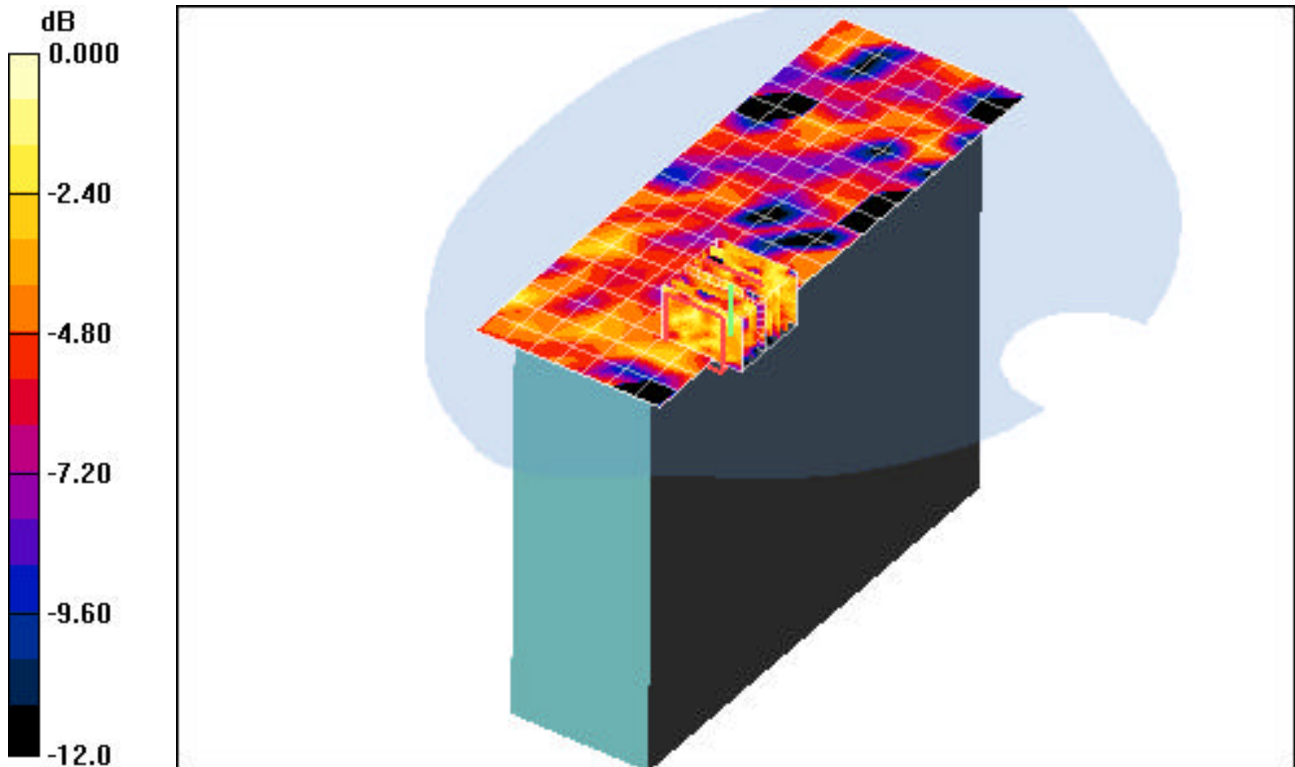

0 dB = 0.076mW/g

PCTEST ENGINEERING LABORATORY, INC.

DUT: CF-U1; Type: Tablet PC with 802.11abgn, Bluetooth, GSM and WCDMA; SN: SAR 1

Communication System: IEEE 802.11n 5.5GHz Band; Frequency: 5590 MHz; Duty Cycle: 1:1

Medium: 5500 Muscle ($\sigma = 5.82$ mho/m, $\epsilon_r = 49.31$, $\rho = 1000$ kg/m³)

Phantom section: Flat Section; Space: 0.0 cm

Test Date: 08-12-2008; Ambient Temp: 23.6°C; Tissue Temp: 22.4°C

Probe: EX3DV4 - SN3561; ConvF(3.81, 3.81, 3.81); Calibrated: 8/30/2007

Sensor-Surface: 3mm (Mechanical Surface Detection)

Electronics: DAE4 Sn649; Calibrated: 1/30/2008

Phantom: SAM Main; Type: SAM 4.0; Serial: TP-1114

Measurement SW: DASY4, V4.7 Build 71; Postprocessing SW: SEMCAD, V1.8 Build 172

Mode: IEEE 802.11n 5.5GHz, Body SAR, Laptop Position, Ch.118, 13.5Mbps

Area Scan (18x21x1): Measurement grid: dx=10mm, dy=10mm

Zoom Scan (8x8x8)/Cube 0: Measurement grid: dx=4.3mm, dy=4.3mm, dz=3mm

Reference Value = 4.62 V/m

Peak SAR (extrapolated) = 0.811 W/kg

SAR(1 g) = 0.103 mW/g; SAR(10 g) = 0.049 mW/g

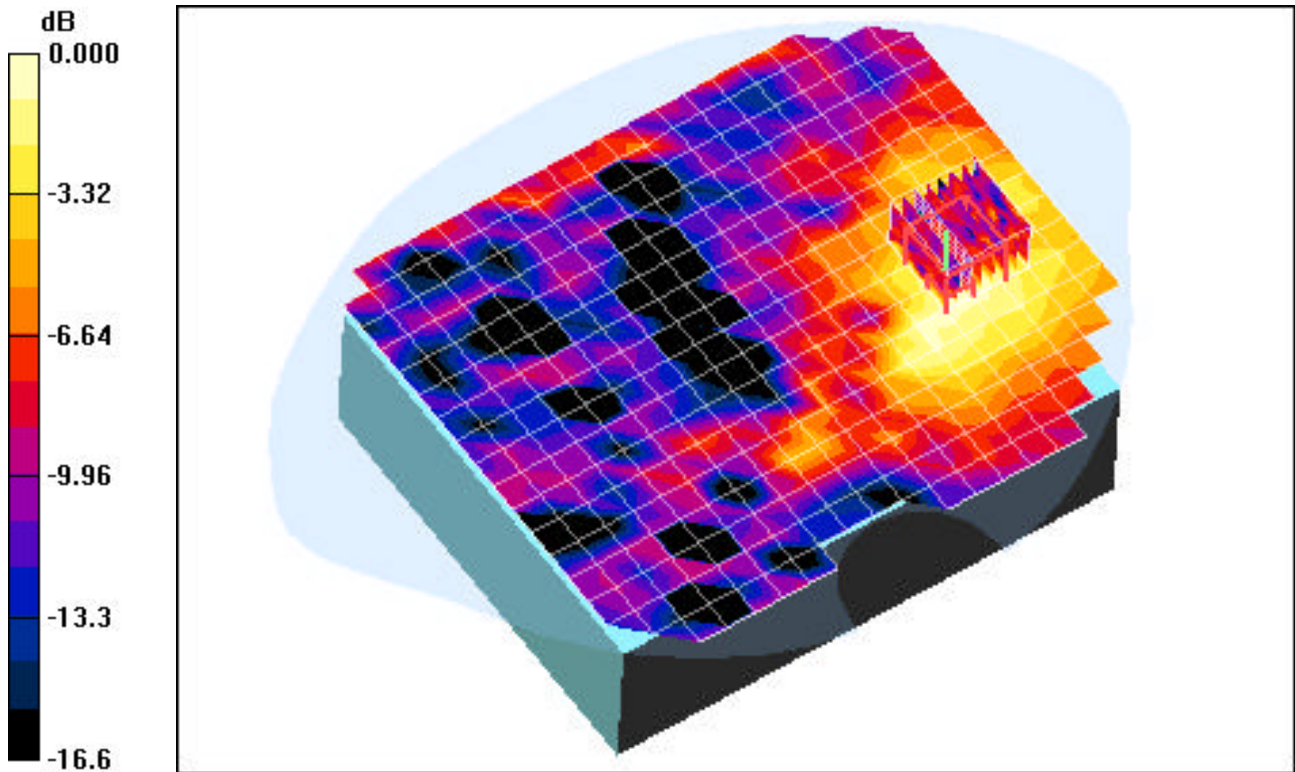

0 dB = 0.129mW/g

PCTEST ENGINEERING LABORATORY, INC.

DUT: CF-U1; Type: Tablet PC with 802.11abgn, Bluetooth, GSM and WCDMA; SN: SAR 1

Communication System: IEEE 802.11n 5.5GHz Band; Frequency: 5510 MHz; Duty Cycle: 1:1

Medium: 5500 Muscle ($\sigma = 5.82$ mho/m, $\epsilon_r = 49.31$, $\rho = 1000$ kg/m³)

Phantom section: Flat Section; Space: 0.0 cm

Test Date: 08-12-2008; Ambient Temp: 23.6°C; Tissue Temp: 22.4°C

Probe: EX3DV4 - SN3561; ConvF(3.67, 3.67, 3.67); Calibrated: 8/30/2007

Sensor-Surface: 3mm (Mechanical Surface Detection)

Electronics: DAE4 Sn649; Calibrated: 1/30/2008

Phantom: SAM Main; Type: SAM 4.0; Serial: TP-1114

Measurement SW: DASYS4, V4.7 Build 71; Postprocessing SW: SEMCAD, V1.8 Build 172

Mode: IEEE 802.11n 5.5GHz, Body SAR, Tablet Position, Ch.102, 13.5Mbps

Area Scan (8x21x1): Measurement grid: dx=10mm, dy=10mm

Zoom Scan (8x8x8)/Cube 0: Measurement grid: dx=4.3mm, dy=4.3mm, dz=3mm

Reference Value = 2.09 V/m

Peak SAR (extrapolated) = 0.116 W/kg

SAR(1 g) = 0.022 mW/g; SAR(10 g) = 0.013 mW/g

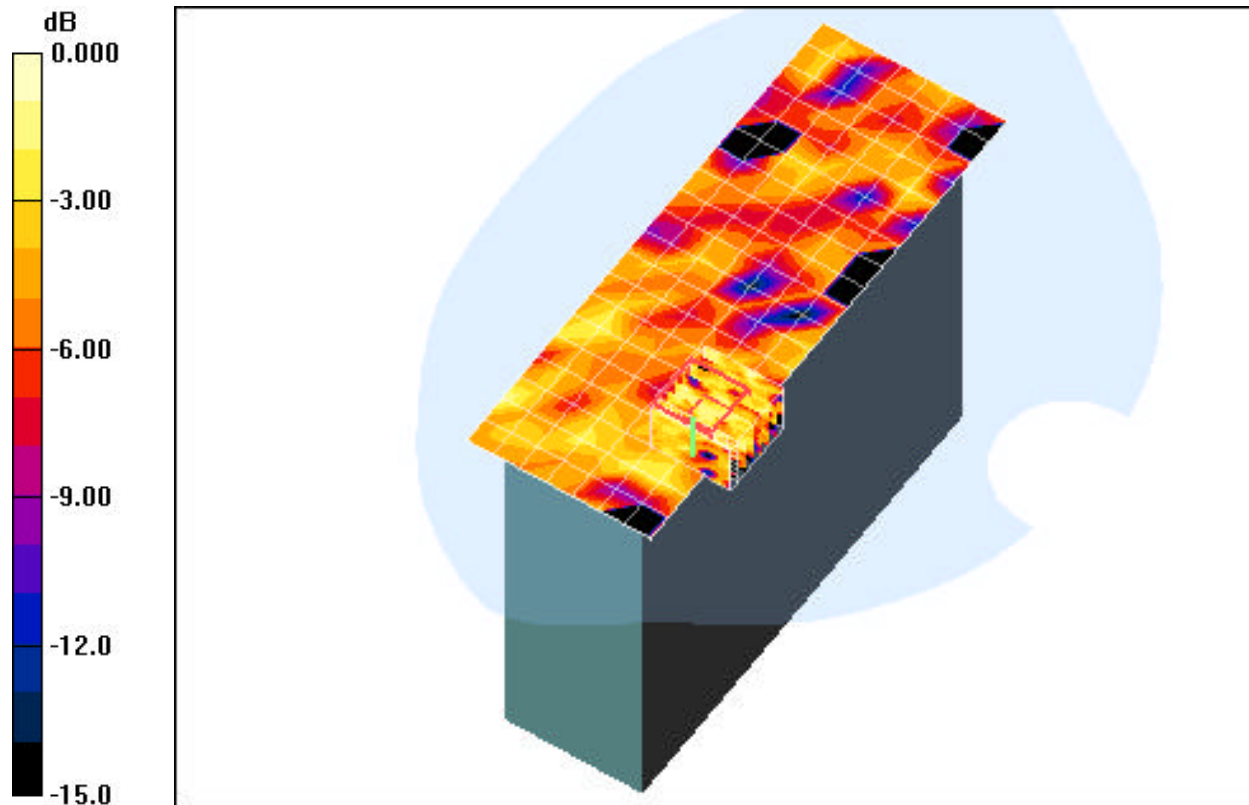

0 dB = 0.076mW/g

PCTEST ENGINEERING LABORATORY, INC.

DUT: CF-U1; Type: Tablet PC with 802.11abgn, Bluetooth, GSM and WCDMA; SN: SAR 1

Communication System: IEEE 802.11a 5.8GHz Band; Frequency: 5745 MHz; Duty Cycle: 1:1

Medium: 5800 Muscle ($\sigma = 6.22$ mho/m, $\epsilon_r = 49.63$, $\rho = 1000$ kg/m³)

Phantom section: Flat Section; Space: 0.0 cm

Test Date: 08-12-2008; Ambient Temp: 23.8°C; Tissue Temp: 22.7°C

Probe: EX3DV4 - SN3561; ConvF(3.75, 3.75, 3.75); Calibrated: 8/30/2007

Sensor-Surface: 3mm (Mechanical Surface Detection)

Electronics: DAE4 Sn649; Calibrated: 1/30/2008

Phantom: SAM Main; Type: SAM 4.0; Serial: TP-1114

Measurement SW: DASY4, V4.7 Build 71; Postprocessing SW: SEMCAD, V1.8 Build 172

Mode: IEEE 802.11a 5.8GHz, Body SAR, Laptop Position, Low Ch, 6Mbps

Area Scan (18x21x1): Measurement grid: dx=10mm, dy=10mm

Zoom Scan (8x8x8)/Cube 0: Measurement grid: dx=4.3mm, dy=4.3mm, dz=3mm

Reference Value = 3.81 V/m

Peak SAR (extrapolated) = 0.323 W/kg

SAR(1 g) = 0.064 mW/g; SAR(10 g) = 0.035 mW/g

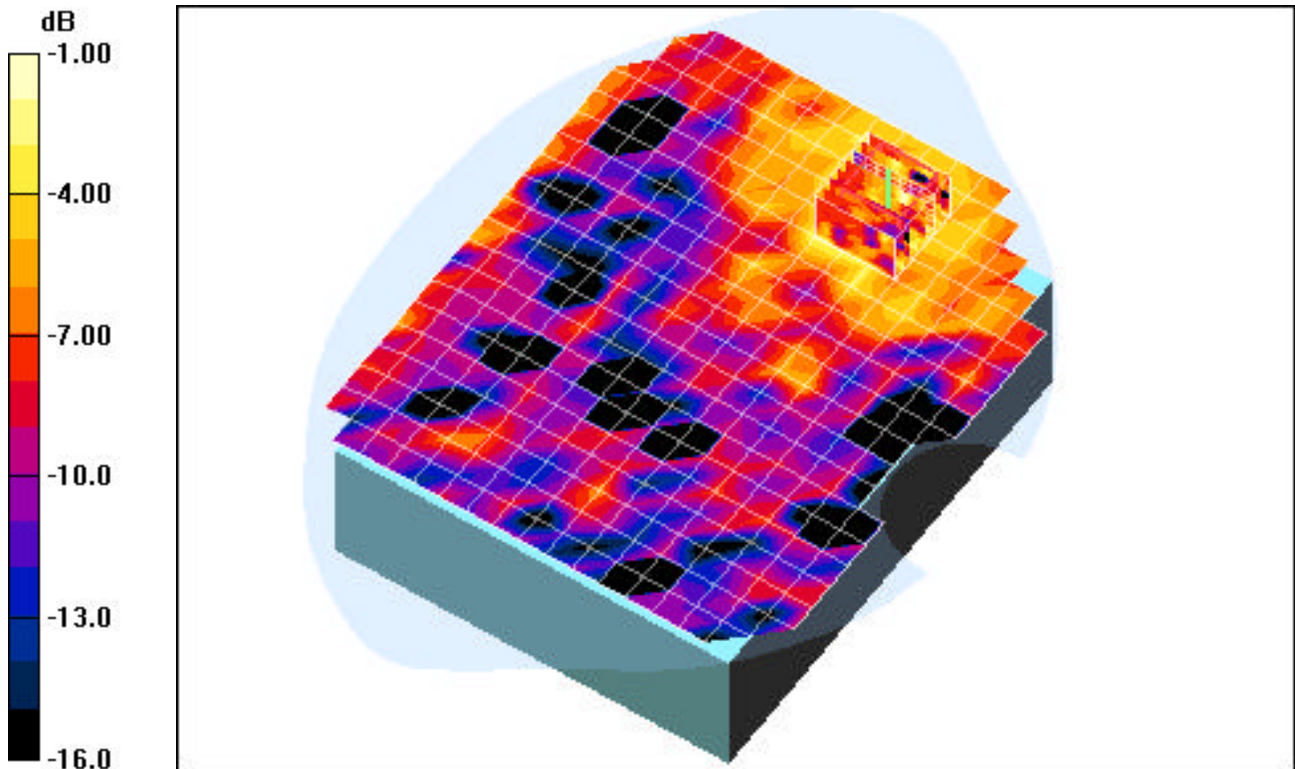

0 dB = 0.104mW/g

PCTEST ENGINEERING LABORATORY, INC.

DUT: CF-U1; Type: Tablet PC with 802.11abgn, Bluetooth, GSM and WCDMA; SN: SAR 1

Communication System: IEEE 802.11a 5.8GHz Band; Frequency: 5745 MHz; Duty Cycle: 1:1

Medium: 5800 Muscle ($\sigma = 6.22$ mho/m, $\epsilon_r = 49.63$, $\rho = 1000$ kg/m³)

Phantom section: Flat Section; Space: 0.0 cm

Test Date: 08-12-2008; Ambient Temp: 23.8°C; Tissue Temp: 22.7°C

Probe: EX3DV4 - SN3561; ConvF(3.75, 3.75, 3.75); Calibrated: 8/30/2007

Sensor-Surface: 3mm (Mechanical Surface Detection)

Electronics: DAE4 Sn649; Calibrated: 1/30/2008

Phantom: SAM Main; Type: SAM 4.0; Serial: TP-1114

Measurement SW: DASY4, V4.7 Build 71; Postprocessing SW: SEMCAD, V1.8 Build 172

Mode: IEEE 802.11a 5.8GHz, Body SAR, Tablet Position, Low Ch, 6Mbps

Area Scan (8x21x1): Measurement grid: dx=10mm, dy=10mm

Zoom Scan (8x8x8)/Cube 0: Measurement grid: dx=4.3mm, dy=4.3mm, dz=3mm

Reference Value = 1.13 V/m

Peak SAR (extrapolated) = 0.110 W/kg

SAR(1 g) = 0.020 mW/g; SAR(10 g) = 0.013 mW/g

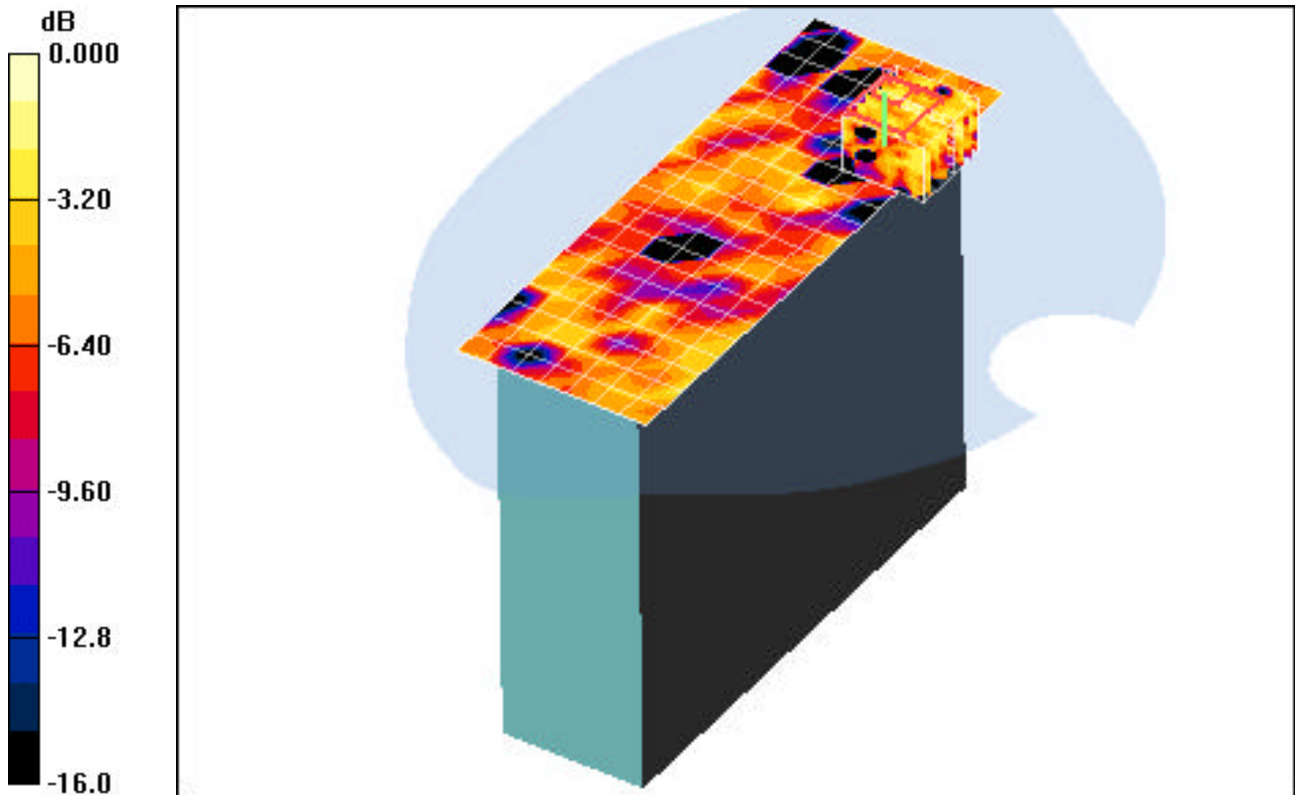

0 dB = 0.042mW/g

PCTEST ENGINEERING LABORATORY, INC.

DUT: CF-U1; Type: Tablet PC with 802.11abgn, Bluetooth, GSM and WCDMA; SN: SAR 1

Communication System: IEEE 802.11n 5.8GHz Band; Frequency: 5795 MHz; Duty Cycle: 1:1

Medium: 5800 Muscle ($\sigma = 6.22$ mho/m, $\epsilon_r = 49.63$, $\rho = 1000$ kg/m³)

Phantom section: Flat Section; Space: 0.0 cm

Test Date: 08-12-2008; Ambient Temp: 23.8°C; Tissue Temp: 22.7°C

Probe: EX3DV4 - SN3561; ConvF(3.75, 3.75, 3.75); Calibrated: 8/30/2007

Sensor-Surface: 3mm (Mechanical Surface Detection)

Electronics: DAE4 Sn649; Calibrated: 1/30/2008

Phantom: SAM Main; Type: SAM 4.0; Serial: TP-1114

Measurement SW: DASY4, V4.7 Build 71; Postprocessing SW: SEMCAD, V1.8 Build 172

Mode: IEEE 802.11n 5.8GHz, Body SAR, Laptop Position, Ch.159, 13.5Mbps

Area Scan (18x21x1): Measurement grid: dx=10mm, dy=10mm

Zoom Scan (8x8x8)/Cube 0: Measurement grid: dx=4.3mm, dy=4.3mm, dz=3mm

Reference Value = 2.88 V/m

Peak SAR (extrapolated) = 0.182 W/kg

SAR(1 g) = 0.044 mW/g; SAR(10 g) = 0.025 mW/g

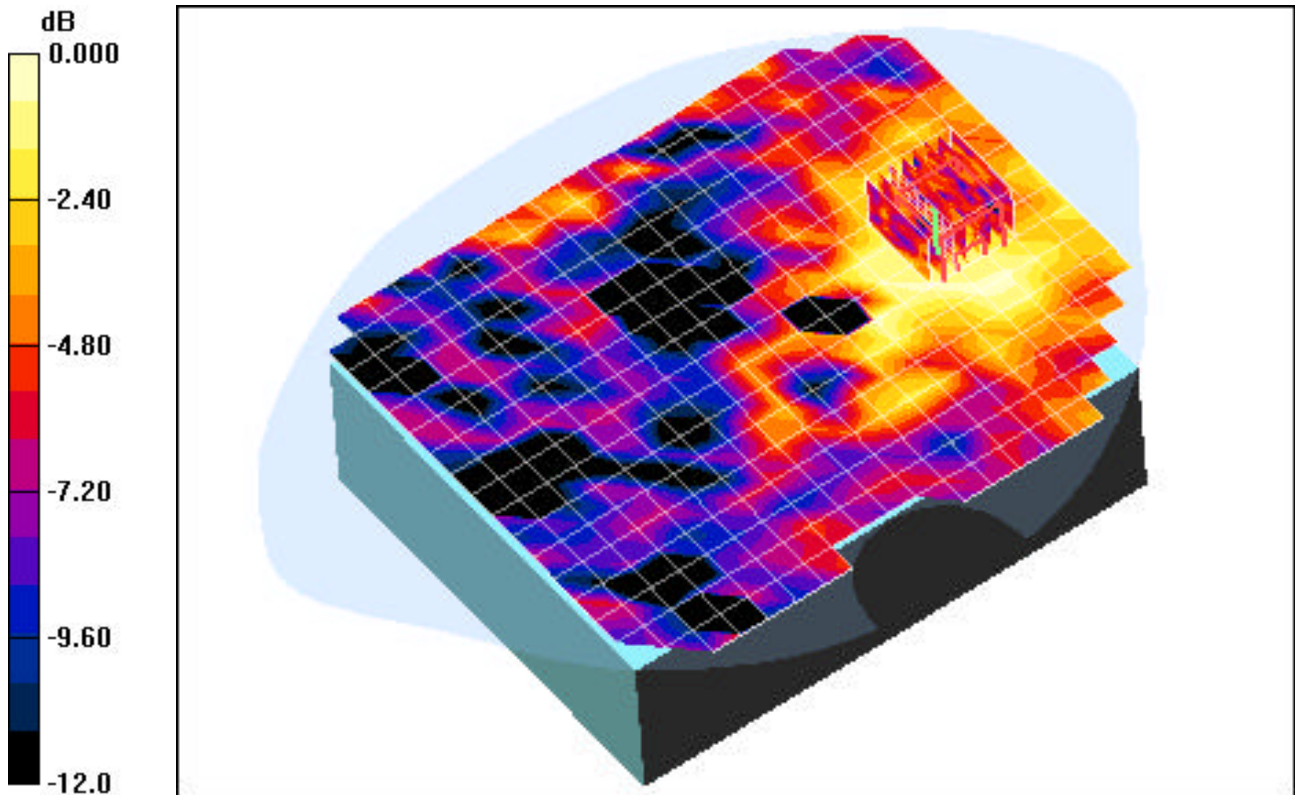

0 dB = 0.068mW/g

PCTEST ENGINEERING LABORATORY, INC.

DUT: CF-U1; Type: Tablet PC with 802.11abgn, Bluetooth, GSM and WCDMA; SN: SAR 1

Communication System: IEEE 802.11n 5.8GHz Band; Frequency: 5755 MHz; Duty Cycle: 1:1

Medium: 5800 Muscle ($\sigma = 6.22$ mho/m, $\epsilon_r = 49.63$, $\rho = 1000$ kg/m³)

Phantom section: Flat Section; Space: 0.0 cm

Test Date: 08-12-2008; Ambient Temp: 23.8°C; Tissue Temp: 22.7°C

Probe: EX3DV4 - SN3561; ConvF(3.81, 3.81, 3.81); Calibrated: 8/30/2007

Sensor-Surface: 3mm (Mechanical Surface Detection)

Electronics: DAE4 Sn649; Calibrated: 1/30/2008

Phantom: SAM Main; Type: SAM 4.0; Serial: TP-1114

Measurement SW: DASY4, V4.7 Build 71; Postprocessing SW: SEMCAD, V1.8 Build 172

Mode: IEEE 802.11n 5.8GHz, Body SAR, Tablet Position, Ch.151, 13.5Mbps

Area Scan (8x21x1): Measurement grid: dx=10mm, dy=10mm

Zoom Scan (8x8x8)/Cube 0: Measurement grid: dx=4.3mm, dy=4.3mm, dz=3mm

Reference Value = 1.55 V/m

Peak SAR (extrapolated) = 0.047 W/kg

SAR(1 g) = 0.021 mW/g; SAR(10 g) = 0.00982 mW/g

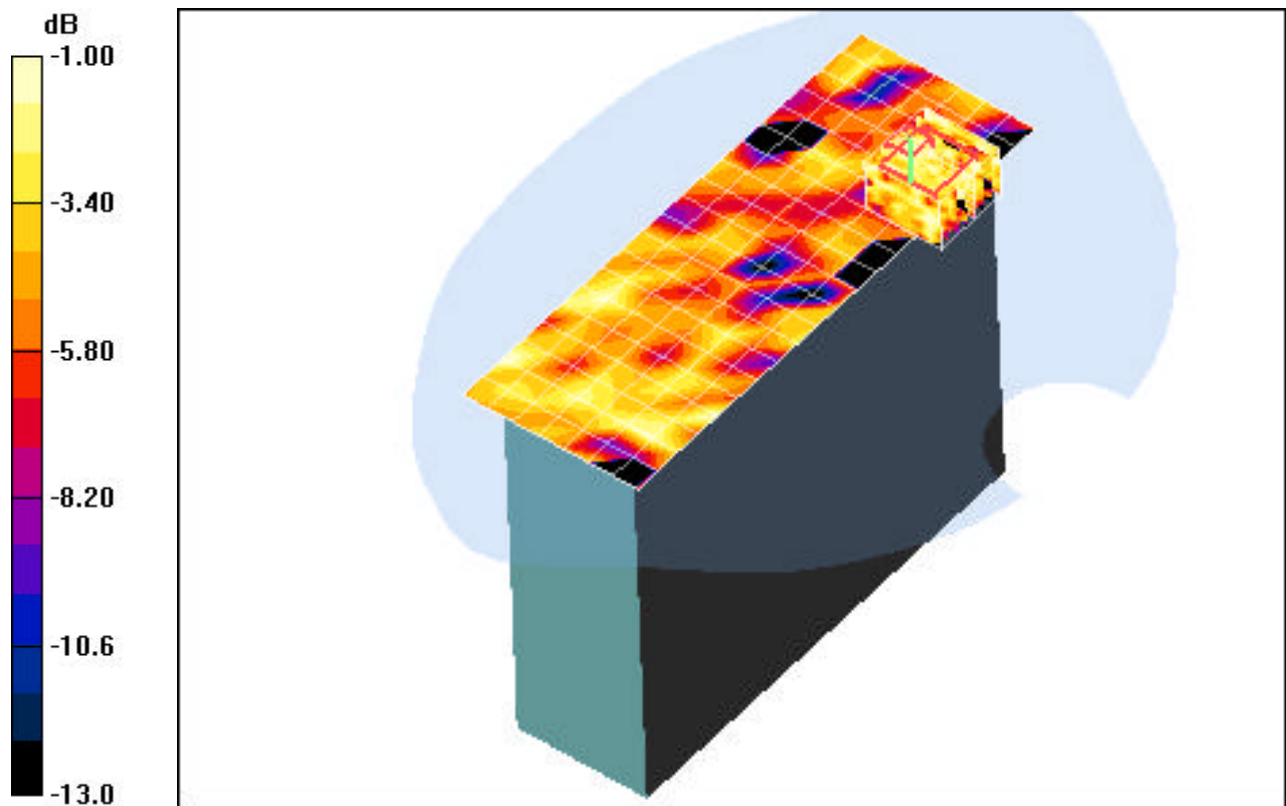

0 dB = 0.032mW/g

PCTEST ENGINEERING LABORATORY, INC.

DUT: CF-U1; Type: Tablet PC with 802.11abgn, Bluetooth, GSM and WCDMA; SN: SAR 1

Communication System: GSM850 GPRS; 3 Tx slots; Frequency: 836.6 MHz; Duty Cycle: 1:2.76

Medium: 835 Muscle ($\sigma = 0.93$ mho/m, $\epsilon_r = 53.18$, $\rho = 1000$ kg/m³)

Phantom section: Flat Section

Test Date: 08-07-2008; Ambient Temp: 23.7°C; Tissue Temp: 22.6°C

Probe: EX3DV4 - SN3561; ConvF(8.27, 8.27, 8.27); Calibrated: 8/30/2007

Sensor-Surface: 3mm (Mechanical Surface Detection)

Electronics: DAE4 Sn649; Calibrated: 1/30/2008

Phantom: SAM Main; Type: SAM 4.0; Serial: TP-1114

Measurement SW: DASY4, V4.7 Build 71; Postprocessing SW: SEMCAD, V1.8 Build 172

Mode: GSM850 GPRS, Body SAR, Laptop Position, Mid Ch, 3x Slot

Area Scan (13x15x1): Measurement grid: dx=15mm, dy=15mm

Zoom Scan (5x5x7)/Cube 0: Measurement grid: dx=8mm, dy=8mm, dz=5mm

Reference Value = 18.9 V/m

Peak SAR (extrapolated) = 0.392 W/kg

SAR(1 g) = 0.307 mW/g; SAR(10 g) = 0.223 mW/g

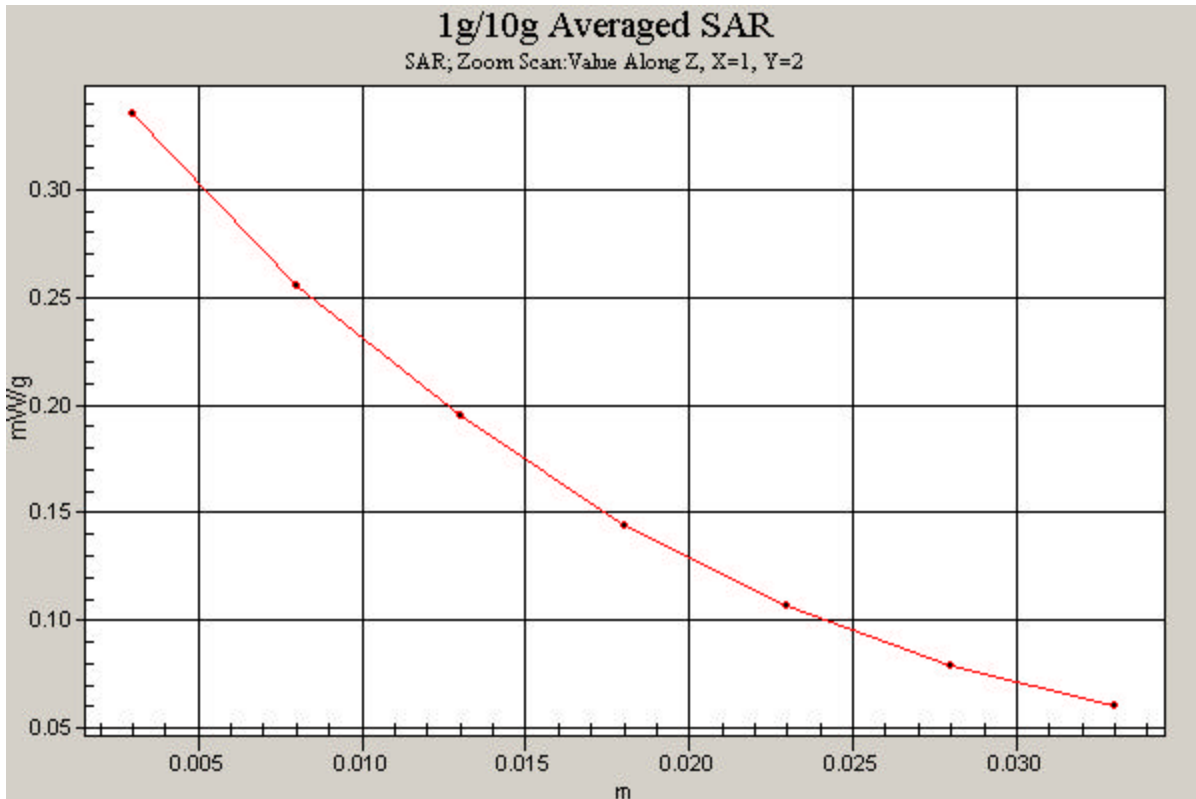

PCTEST ENGINEERING LABORATORY, INC.

DUT: CF-U1; Type: Tablet PC with 802.11abgn, Bluetooth, GSM and WCDMA; SN: SAR 1

Communication System: WCDMA1900; Frequency: 1880 MHz; Duty Cycle: 1:1

Medium: 1900 Muscle ($\sigma = 1.47$ mho/m, $\epsilon_r = 54.83$, $\rho = 1000$ kg/m³)

Phantom section: Flat Section

Test Date: 08-08-2008; Ambient Temp: 23.5°C; Tissue Temp: 22.7°C

Probe: EX3DV4 - SN3561; ConvF(6.6, 6.6, 6.6); Calibrated: 8/30/2007

Sensor-Surface: 3mm (Mechanical Surface Detection)

Electronics: DAE4 Sn649; Calibrated: 1/30/2008

Phantom: SAM Main; Type: SAM 4.0; Serial: TP-1114

Measurement SW: DASY4, V4.7 Build 71; Postprocessing SW: SEMCAD, V1.8 Build 172

Mode: WCDMA1900, Body SAR, Laptop Position, Mid Ch, HSDPA Inactive

Area Scan (13x15x1): Measurement grid: dx=15mm, dy=15mm

Zoom Scan (5x5x7)/Cube 0: Measurement grid: dx=8mm, dy=8mm, dz=5mm

Reference Value = 10.5 V/m

Peak SAR (extrapolated) = 0.393 W/kg

SAR(1 g) = 0.228 mW/g; SAR(10 g) = 0.133 mW/g

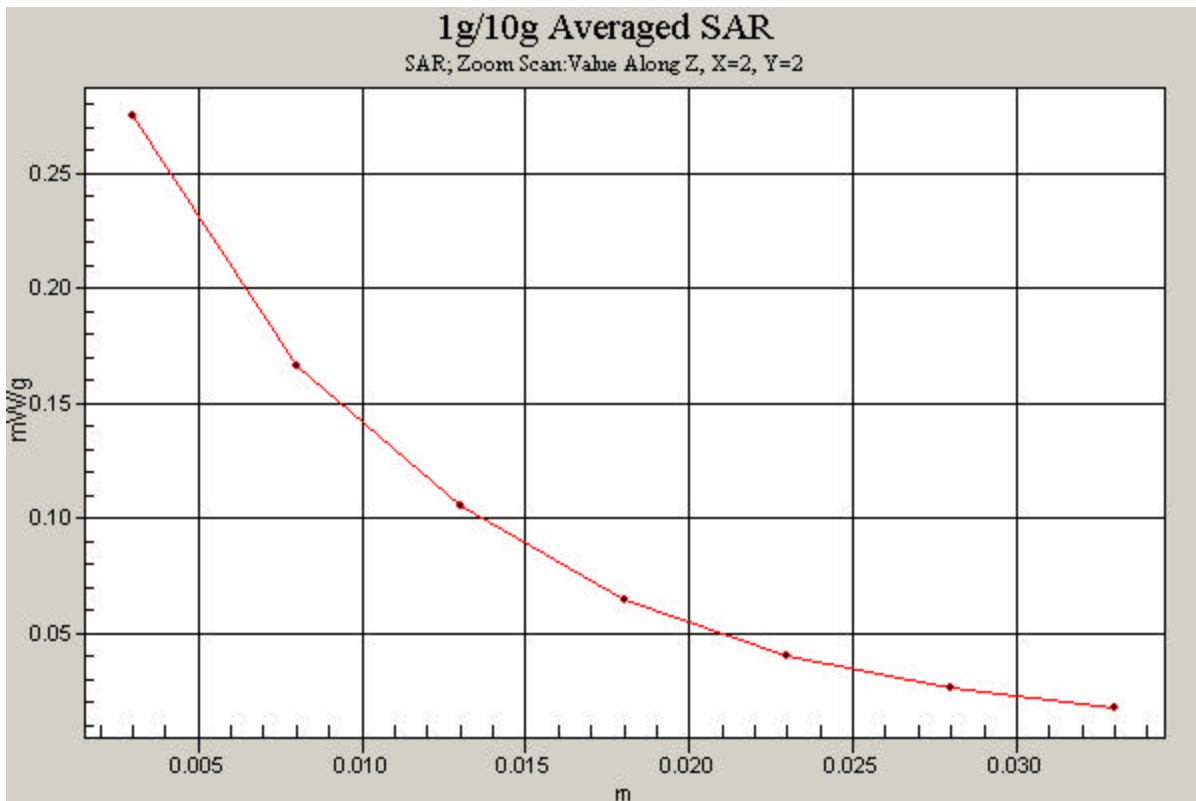

PCTEST ENGINEERING LABORATORY, INC.

DUT: CF-U1; Type: Tablet PC with 802.11abgn, Bluetooth, GSM and WCDMA; SN: SAR 1

Communication System: IEEE 802.11b; Frequency: 2437 MHz; Duty Cycle: 1:1

Medium: 2450 Muscle ($\sigma = 1.93$ mho/m, $\epsilon_r = 51.84$, $\rho = 1000$ kg/m³)

Phantom section: Flat Section; Space: 0.0 cm

Test Date: 08-11-2008; Ambient Temp: 23.9°C; Tissue Temp: 22.6°C

Probe: EX3DV4 - SN3561; ConvF(6.15, 6.15, 6.15); Calibrated: 8/30/2007

Sensor-Surface: 3mm (Mechanical Surface Detection)

Electronics: DAE4 Sn649; Calibrated: 1/30/2008

Phantom: SAM Main; Type: SAM 4.0; Serial: TP-1114

Measurement SW: DASY4, V4.7 Build 71; Postprocessing SW: SEMCAD, V1.8 Build 172

Mode: IEEE 802.11b, Body SAR, Laptop Position, Mid Ch, 1Mbps

Area Scan (13x15x1): Measurement grid: dx=15mm, dy=15mm

Zoom Scan (5x5x7)/Cube 0: Measurement grid: dx=8mm, dy=8mm, dz=5mm

Reference Value = 6.08 V/m

Peak SAR (extrapolated) = 0.120 W/kg

SAR(1 g) = 0.061 mW/g; SAR(10 g) = 0.034 mW/g

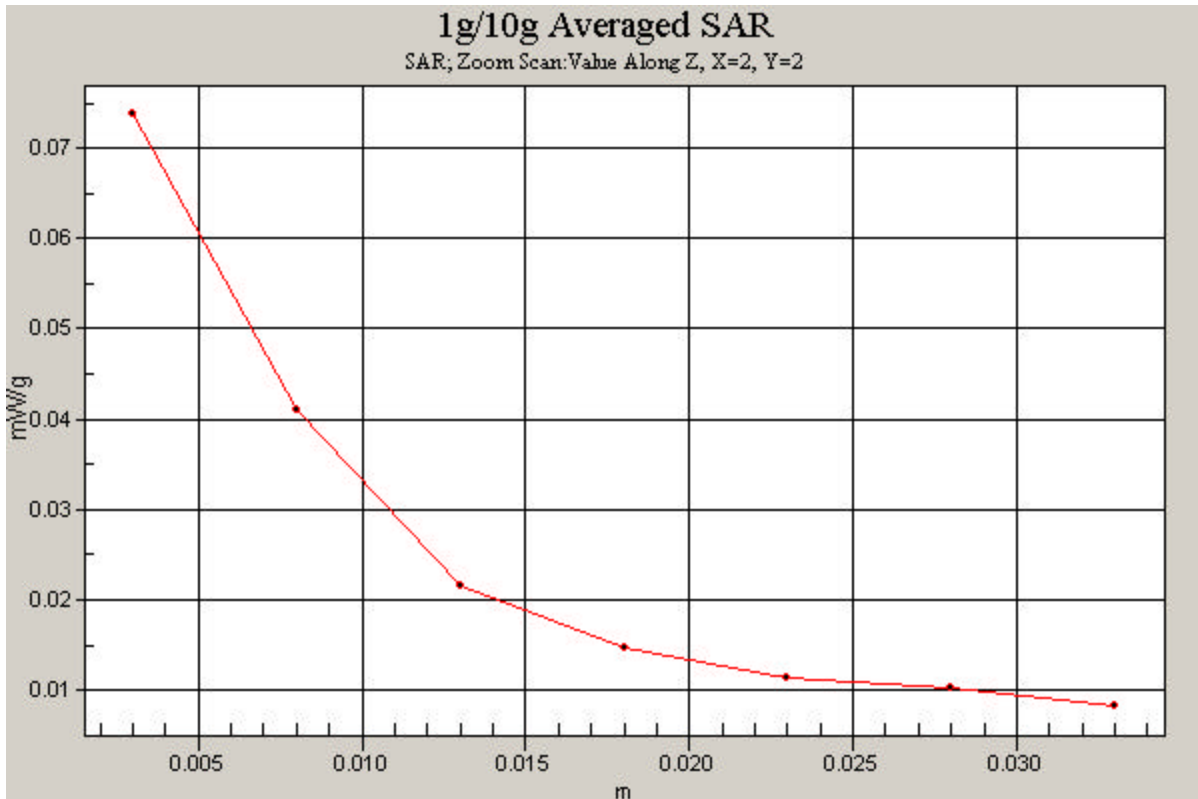

PCTEST ENGINEERING LABORATORY, INC.

DUT: CF-U1; Type: Tablet PC with 802.11abgn, Bluetooth, GSM and WCDMA; SN: SAR 1

Communication System: IEEE 802.11n; Frequency: 5190 MHz; Duty Cycle: 1:1

Medium: 5300 Muscle ($\sigma = 5.41$ mho/m, $\epsilon_r = 49.81$, $\rho = 1000$ kg/m³)

Phantom section: Flat Section; Space: 0.0 cm

Test Date: 08-11-2008; Ambient Temp: 23.9°C; Tissue Temp: 22.7°C

Probe: EX3DV4 - SN3561; ConvF(3.83, 3.83, 3.83); Calibrated: 8/30/2007

Sensor-Surface: 3mm (Mechanical Surface Detection)

Electronics: DAE4 Sn649; Calibrated: 1/30/2008

Phantom: SAM Main; Type: SAM 4.0; Serial: TP-1114

Measurement SW: DASY4, V4.7 Build 53; Postprocessing SW: SEMCAD, V1.8 Build 172

Mode: IEEE 802.11n 5.2GHz, Body SAR, Laptop Position, Ch.38, 13.5Mbps

Area Scan (18x21x1): Measurement grid: dx=10mm, dy=10mm

Zoom Scan (8x8x8)/Cube 0: Measurement grid: dx=4.3mm, dy=4.3mm, dz=3mm

Reference Value = 4.15 V/m

Peak SAR (extrapolated) = 0.464 W/kg

SAR(1 g) = 0.093 mW/g; SAR(10 g) = 0.046 mW/g

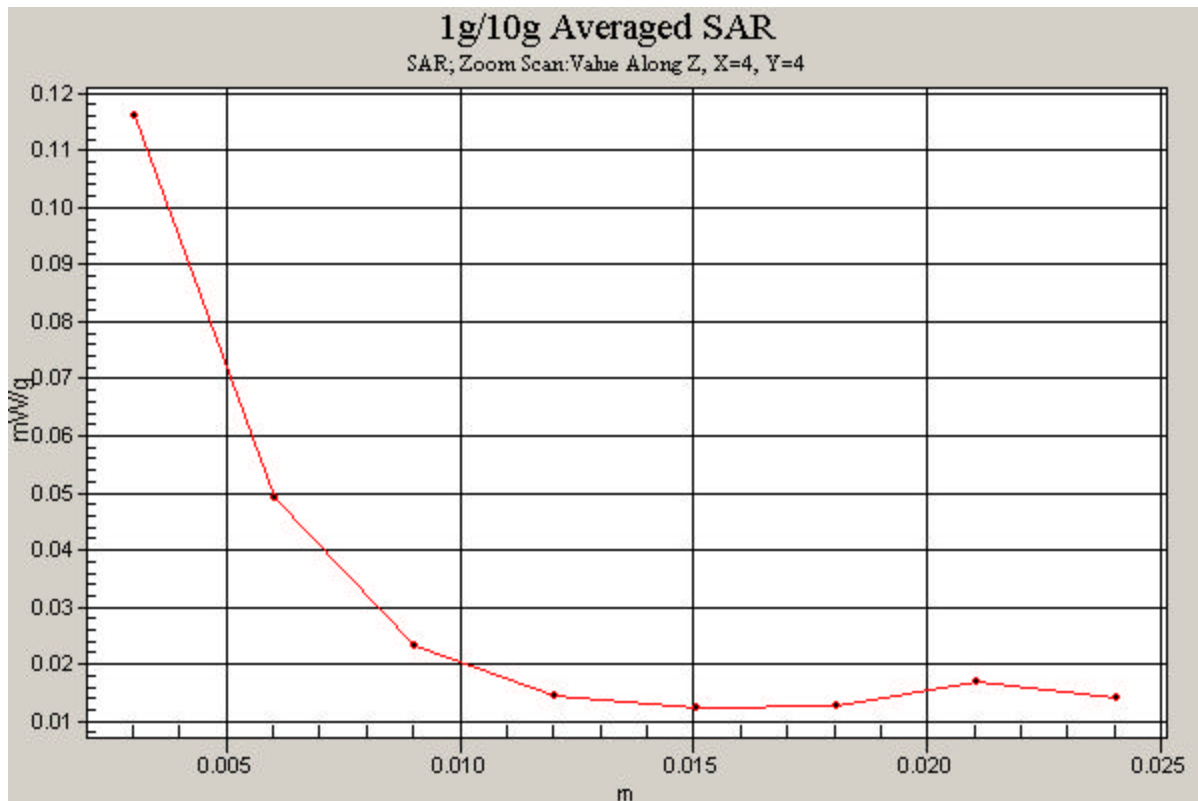

PCTEST ENGINEERING LABORATORY, INC.

DUT: CF-U1; Type: Tablet PC with 802.11abgn, Bluetooth, GSM and WCDMA; SN: SAR 1

Communication System: IEEE 802.11a 5.5GHz Band; Frequency: 5600 MHz; Duty Cycle: 1:1

Medium: 5500 Muscle ($\sigma = 5.82$ mho/m, $\epsilon_r = 49.31$, $\rho = 1000$ kg/m³)

Phantom section: Flat Section; Space: 0.0 cm

Test Date: 08-12-2008; Ambient Temp: 23.6°C; Tissue Temp: 22.4°C

Probe: EX3DV4 - SN3561; ConvF(3.81, 3.81, 3.81); Calibrated: 8/30/2007

Sensor-Surface: 3mm (Mechanical Surface Detection)

Electronics: DAE4 Sn649; Calibrated: 1/30/2008

Phantom: SAM Main; Type: SAM 4.0; Serial: TP-1114

Measurement SW: DASY4, V4.7 Build 71; Postprocessing SW: SEMCAD, V1.8 Build 172

Mode: IEEE 802.11a 5.5GHz, Body SAR, Laptop Position, Ch.120, 6Mbps

Area Scan (18x21x1): Measurement grid: dx=10mm, dy=10mm

Zoom Scan (8x8x8)/Cube 0: Measurement grid: dx=4.3mm, dy=4.3mm, dz=3mm

Reference Value = 4.63 V/m

Peak SAR (extrapolated) = 0.813 W/kg

SAR(1 g) = 0.104 mW/g; SAR(10 g) = 0.049 mW/g

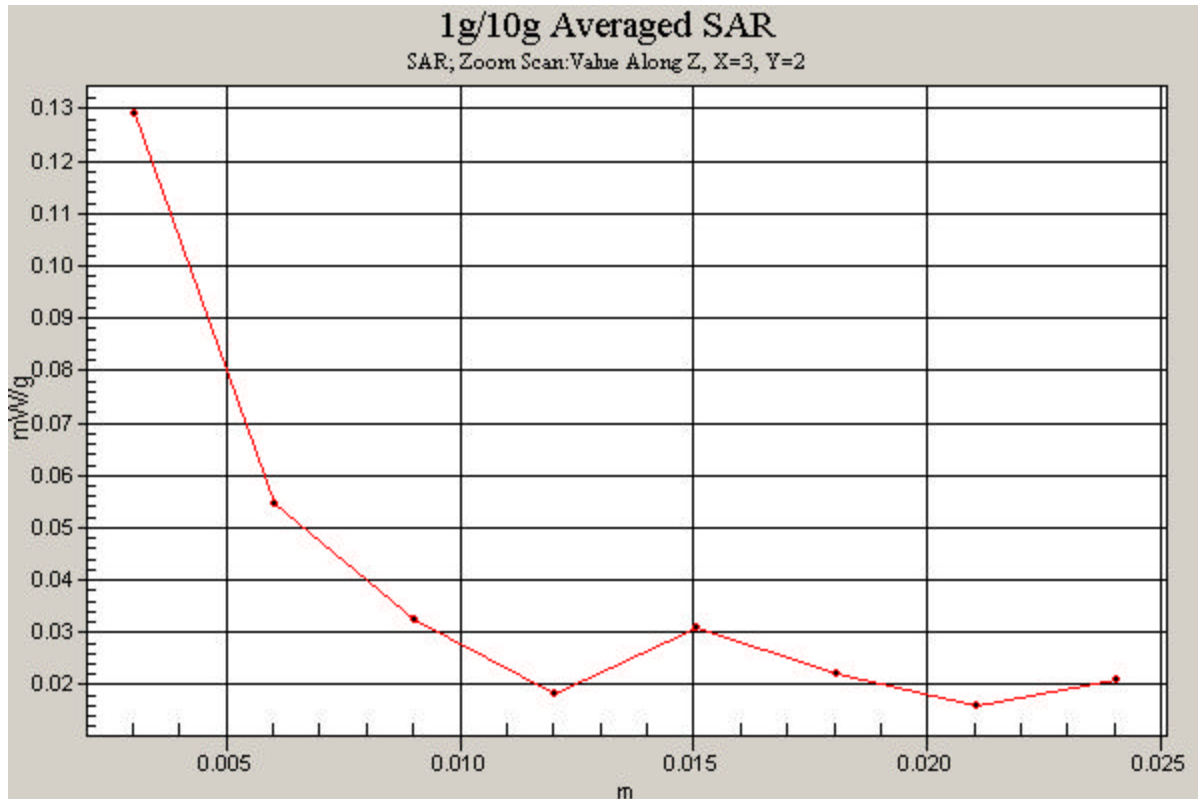

PCTEST ENGINEERING LABORATORY, INC.

DUT: 5GHz SAR Validation Dipole; Type: D5GHzV2; Serial: 1007

Communication System: CW; Frequency: 5800 MHz; Duty Cycle: 1:1

Medium: 5800 Muscle ($\sigma = 6.22$ mho/m, $\epsilon_r = 49.63$, $\rho = 1000$ kg/m³)

Phantom section: Flat Section; Space: 1.0 cm

Test Date: 08-12-2008; Ambient Temp: 23.8°C; Tissue Temp: 22.7°C

Probe: EX3DV4 - SN3561; ConvF(3.75, 3.75, 3.75); Calibrated: 8/30/2007

Sensor-Surface: 3mm (Mechanical Surface Detection)

Electronics: DAE4 Sn649; Calibrated: 1/30/2008

Phantom: SAM Main; Type: SAM 4.0; Serial: TP-1114

Measurement SW: DASY4, V4.7 Build 71; Postprocessing SW: SEMCAD, V1.8 Build 172

5800MHz Dipole Validation

Area Scan (7x9x1): Measurement grid: dx=10mm, dy=10mm

Zoom Scan (8x8x8)/Cube 0: Measurement grid: dx=4.3mm, dy=4.3mm, dz=3mm

Input Power = 20.0 dBm (100 mW)

SAR(1 g) = 7.04 mW/g; SAR(10 g) = 1.93 mW/g

Deviation = 4.61 %

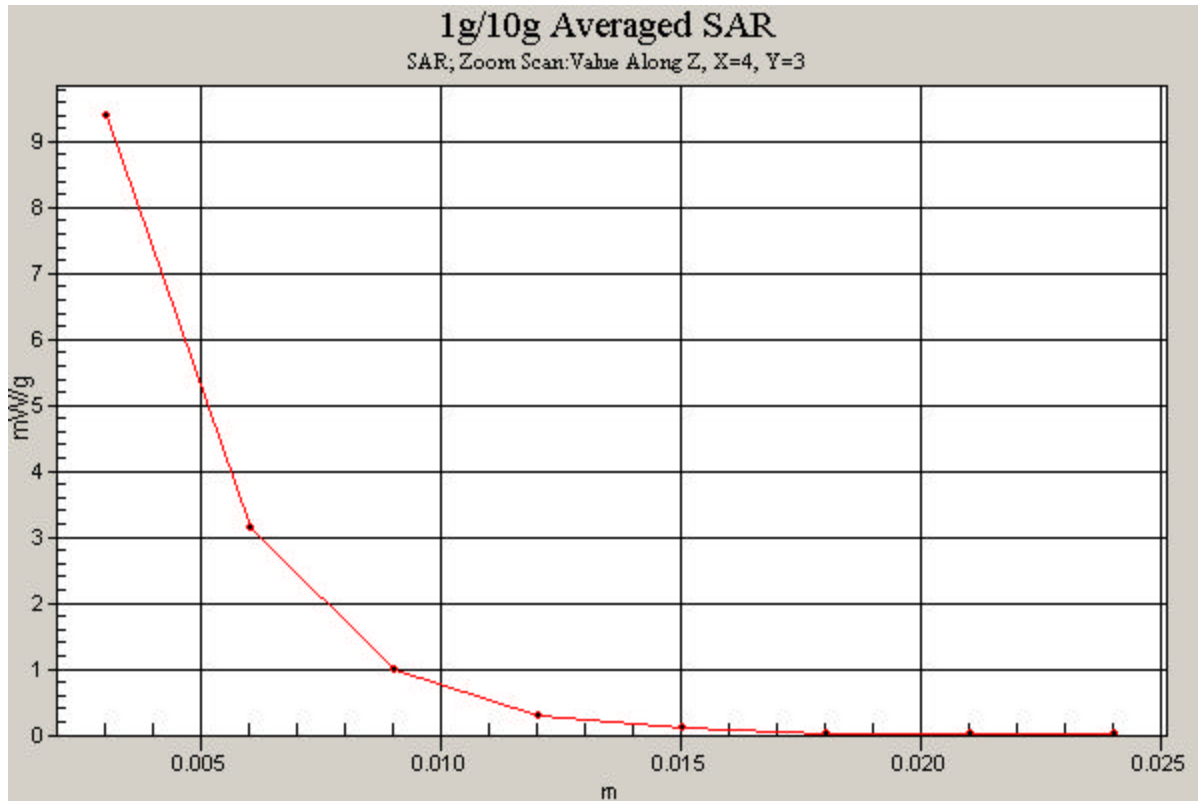

APPENDIX B: DIPOLE VALIDATION

PCTEST ENGINEERING LABORATORY, INC.

DUT: 835MHz SAR Validation Dipole; Type: D835V2; Serial: 4d026

Communication System: CW; Frequency: 835 MHz; Duty Cycle: 1:1

Medium: 835 Brain ($\sigma = 0.88$ mho/m, $\epsilon_r = 40.23$, $\rho = 1000$ kg/m³)

Phantom section: Flat Section; Space: 1.5 cm

Test Date: 08-07-2008; Ambient Temp: 23.6°C; Tissue Temp: 22.8°C

Probe: EX3DV4 - SN3561; ConvF(8.38, 8.38, 8.38); Calibrated: 8/30/2007

Sensor-Surface: 3mm (Mechanical Surface Detection)

Electronics: DAE4 Sn649; Calibrated: 1/30/2008

Phantom: SAM Main; Type: SAM 4.0; Serial: TP-1114

Measurement SW: DASY4, V4.7 Build 71; Postprocessing SW: SEMCAD, V1.8 Build 172

835MHz Dipole Validation

Area Scan (7x13x1): Measurement grid: dx=15mm, dy=15mm

Zoom Scan (5x5x7)/Cube 0: Measurement grid: dx=8mm, dy=8mm, dz=5mm

Input Power = 20.0 dBm (100 mW)

SAR(1 g) = 0.957 mW/g; SAR(10 g) = 0.623 mW/g

Deviation = 6.22 %

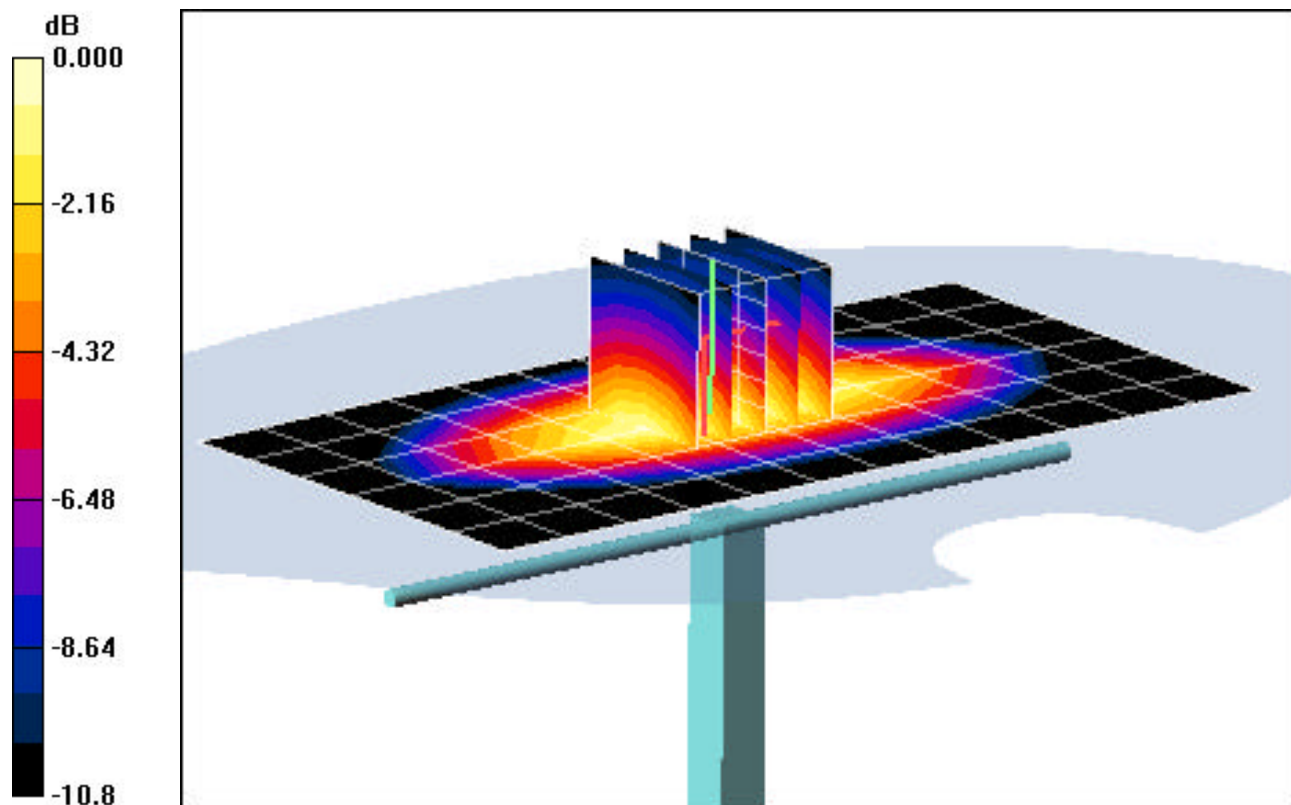

0 dB = 1.12mW/g

PCTEST ENGINEERING LABORATORY, INC.

DUT: 1900MHz SAR Valudation Dipole; Type: D1900V2; Serial: 5d080

Communication System: CW; Frequency: 1900 MHz;Duty Cycle: 1:1

Medium: 1900 Brain ($\sigma = 1.36$ mho/m, $\epsilon_r = 38.16$, $\rho = 1000$ kg/m³)

Phantom section: Flat Section; Space: 1.0 cm

Test Date: 08-08-2008; Ambient Temp: 23.4°C; Tissue Temp: 22.3°C

Probe: EX3DV4 - SN3561; ConvF(6.71, 6.71, 6.71); Calibrated: 8/30/2007

Sensor-Surface: 3mm (Mechanical Surface Detection)

Electronics: DAE4 Sn649; Calibrated: 1/30/2008

Phantom: SAM Main; Type: SAM 4.0; Serial: TP-1114

Measurement SW: DASY4, V4.7 Build 71; Postprocessing SW: SEMCAD, V1.8 Build 172

1900MHz Dipole Validation

Area Scan (5x7x1): Measurement grid: dx=15mm, dy=15mm

Zoom Scan (5x5x7)/Cube 0: Measurement grid: dx=8mm, dy=8mm, dz=5mm

Input Power = 20.0 dBm (100 mW)

SAR(1 g) = 3.89 mW/g; SAR(10 g) = 1.99 mW/g

Deviation = 3.18 %

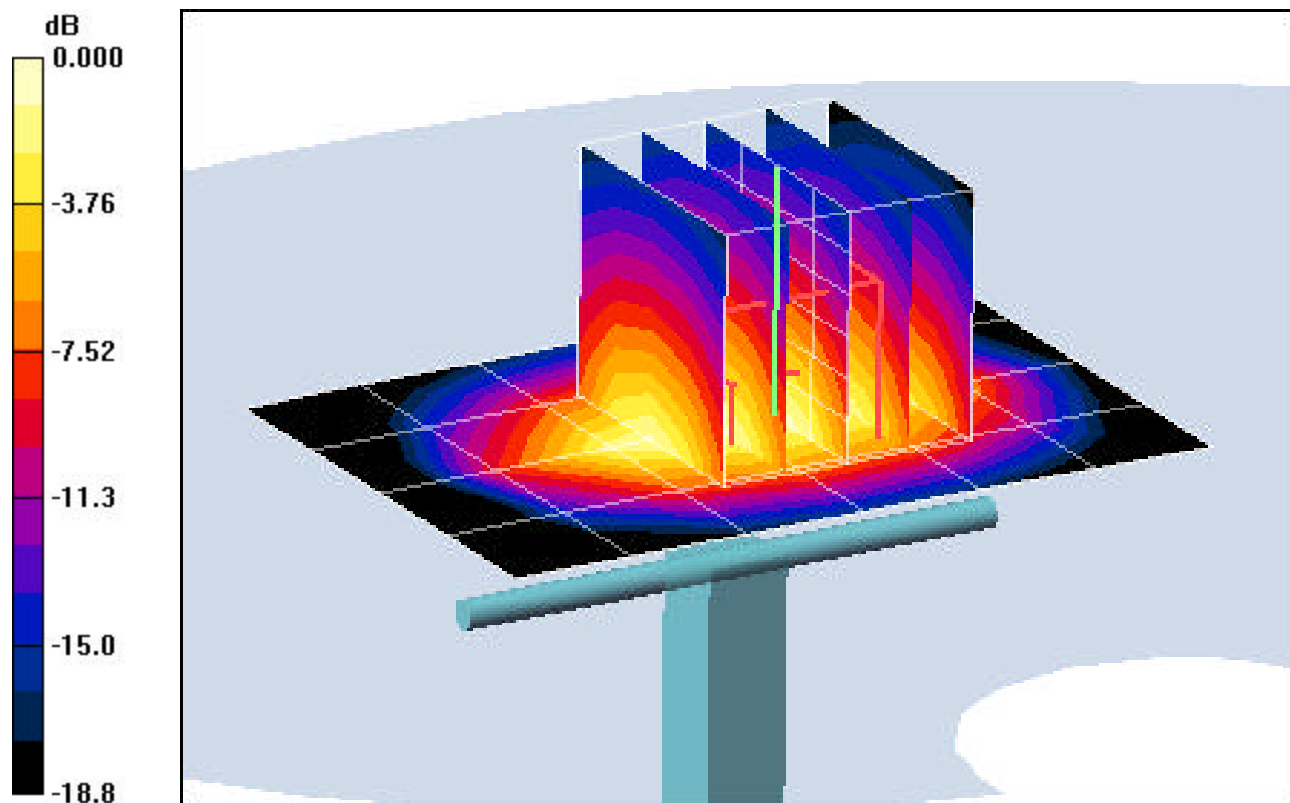

0 dB = 4.86mW/g

PCTEST ENGINEERING LABORATORY, INC.

DUT: 2450MHz SAR Validation Dipole; Type: D2450V2; Serial: 797

Communication System: CW; Frequency: 2450 MHz; Duty Cycle: 1:1

Medium: 2450 Brain ($\sigma = 1.79$ mho/m, $\epsilon_r = 38.08$, $\rho = 1000$ kg/m³)

Phantom section: Flat Section; Space: 1.0 cm

Test Date: 08-11-2008; Ambient Temp: 23.8°C; Tissue Temp: 22.5°C

Probe: EX3DV4 - SN3561; ConvF(6.26, 6.26, 6.26); Calibrated: 8/30/2007

Sensor-Surface: 3mm (Mechanical Surface Detection)

Electronics: DAE4 Sn649; Calibrated: 1/30/2008

Phantom: SAM Main; Type: SAM 4.0; Serial: TP-1114

Measurement SW: DASY4, V4.7 Build 71; Postprocessing SW: SEMCAD, V1.8 Build 172

2450MHz Dipole Validation

Area Scan (5x7x1): Measurement grid: dx=15mm, dy=15mm

Zoom Scan (5x5x7)/Cube 0: Measurement grid: dx=8mm, dy=8mm, dz=5mm

Input Power = 20.0 dBm (100 mW)

SAR(1 g) = 5.56 mW/g; SAR(10 g) = 2.53 mW/g

Deviation = 2.77 %

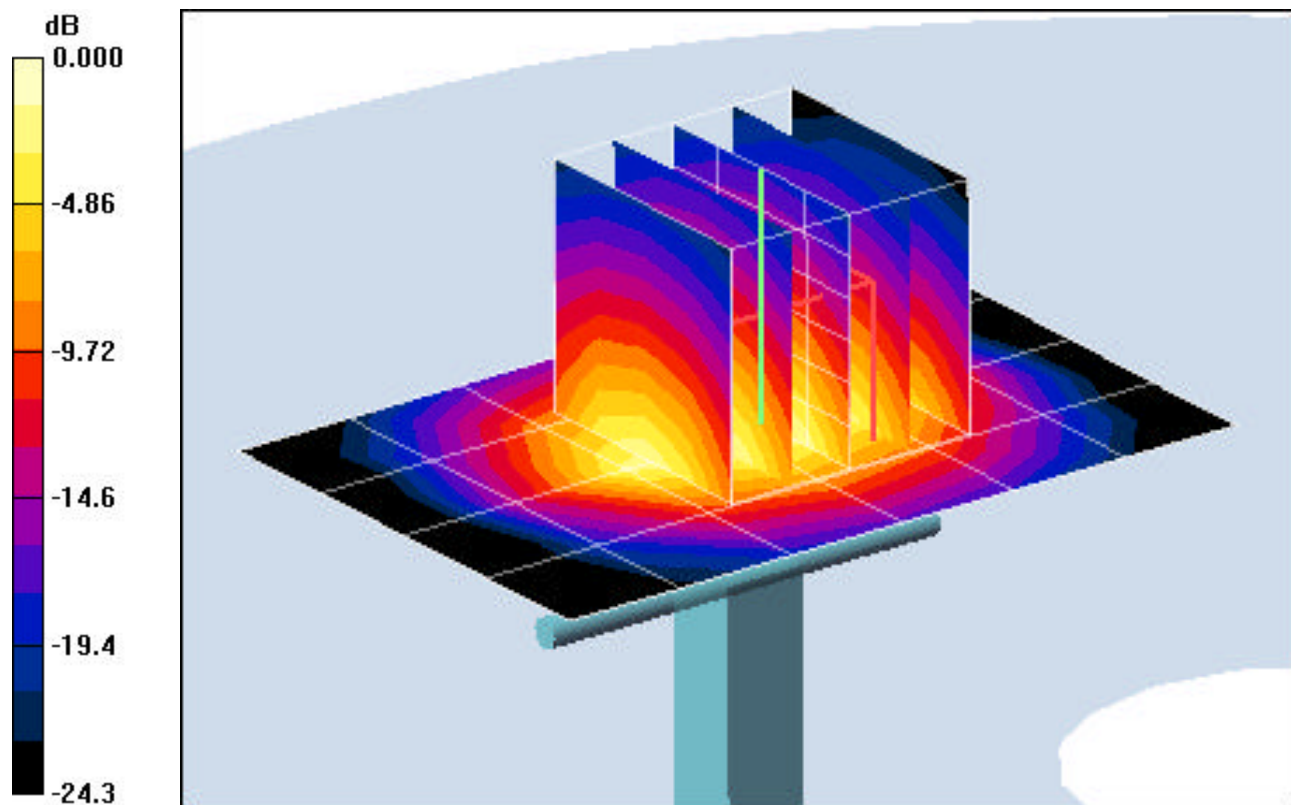

0 dB = 7.22mW/g

PCTEST ENGINEERING LABORATORY, INC.

DUT: 5GHz SAR Validation Dipole; Type: D5GHzV2; Serial: 1007

Communication System: CW; Frequency: 5200 MHz; Duty Cycle: 1:1

Medium: 5300 Muscle ($\sigma = 5.41$ mho/m, $\epsilon_r = 49.81$, $\rho = 1000$ kg/m³)

Phantom section: Flat Section; Space: 1.0 cm

Test Date: 08-11-2008; Ambient Temp: 23.9°C; Tissue Temp: 22.7°C

Probe: EX3DV4 - SN3561; ConvF(3.83, 3.83, 3.83); Calibrated: 8/30/2007

Sensor-Surface: 3mm (Mechanical Surface Detection)

Electronics: DAE4 Sn649; Calibrated: 1/30/2008

Phantom: SAM Main; Type: SAM 4.0; Serial: TP-1114

Measurement SW: DASY4, V4.7 Build 71; Postprocessing SW: SEMCAD, V1.8 Build 172

5200MHz Dipole Validation

Area Scan (7x9x1): Measurement grid: dx=10mm, dy=10mm

Zoom Scan (8x8x8)/Cube 0: Measurement grid: dx=4.3mm, dy=4.3mm, dz=3mm

Input Power = 20.0 dBm (100 mW)

SAR(1 g) = 7.7 mW/g; SAR(10 g) = 2.15 mW/g

Deviation = 6.50 %

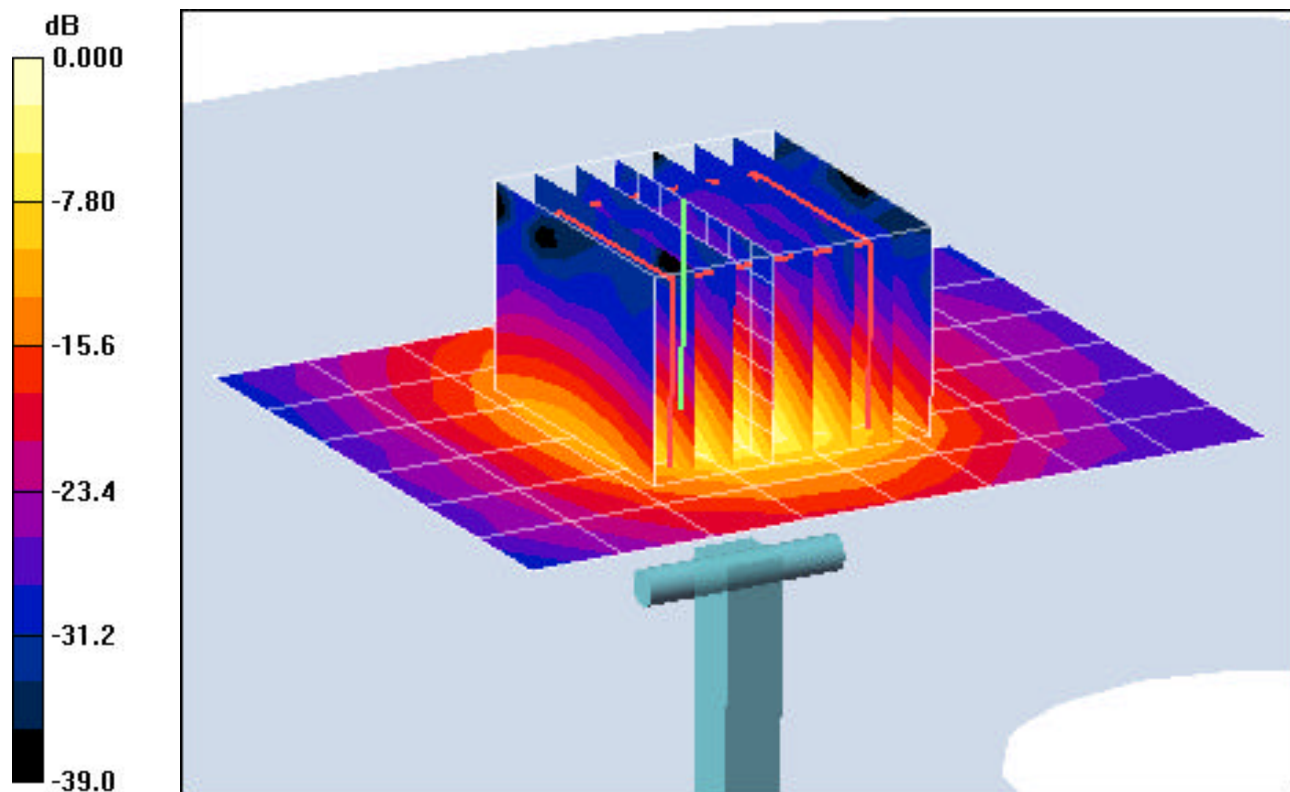

0 dB = 11.0mW/g

PCTEST ENGINEERING LABORATORY, INC.

DUT: 5GHz SAR Validation Dipole; Type: D5GHzV2; Serial: 1007

Communication System: CW; Frequency: 5500 MHz; Duty Cycle: 1:1

Medium: 5500 Muscle ($\sigma = 5.82$ mho/m, $\epsilon_r = 49.31$, $\rho = 1000$ kg/m³)

Phantom section: Flat Section; Space: 1.0 cm

Test Date: 08-12-2008; Ambient Temp: 23.6°C; Tissue Temp: 22.4°C

Probe: EX3DV4 - SN3561; ConvF(3.67, 3.67, 3.67); Calibrated: 8/30/2007

Sensor-Surface: 3mm (Mechanical Surface Detection)

Electronics: DAE4 Sn649; Calibrated: 1/30/2008

Phantom: SAM Main; Type: SAM 4.0; Serial: TP-1114

Measurement SW: DASY4, V4.7 Build 71; Postprocessing SW: SEMCAD, V1.8 Build 172

5500MHz Dipole Validation

Area Scan (7x9x1): Measurement grid: dx=10mm, dy=10mm

Zoom Scan (8x8x8)/Cube 0: Measurement grid: dx=4.3mm, dy=4.3mm, dz=3mm

Input Power = 20.0 dBm (100 mW)

SAR(1 g) = 8.22 mW/g; SAR(10 g) = 2.27 mW/g

Deviation = 7.03 %

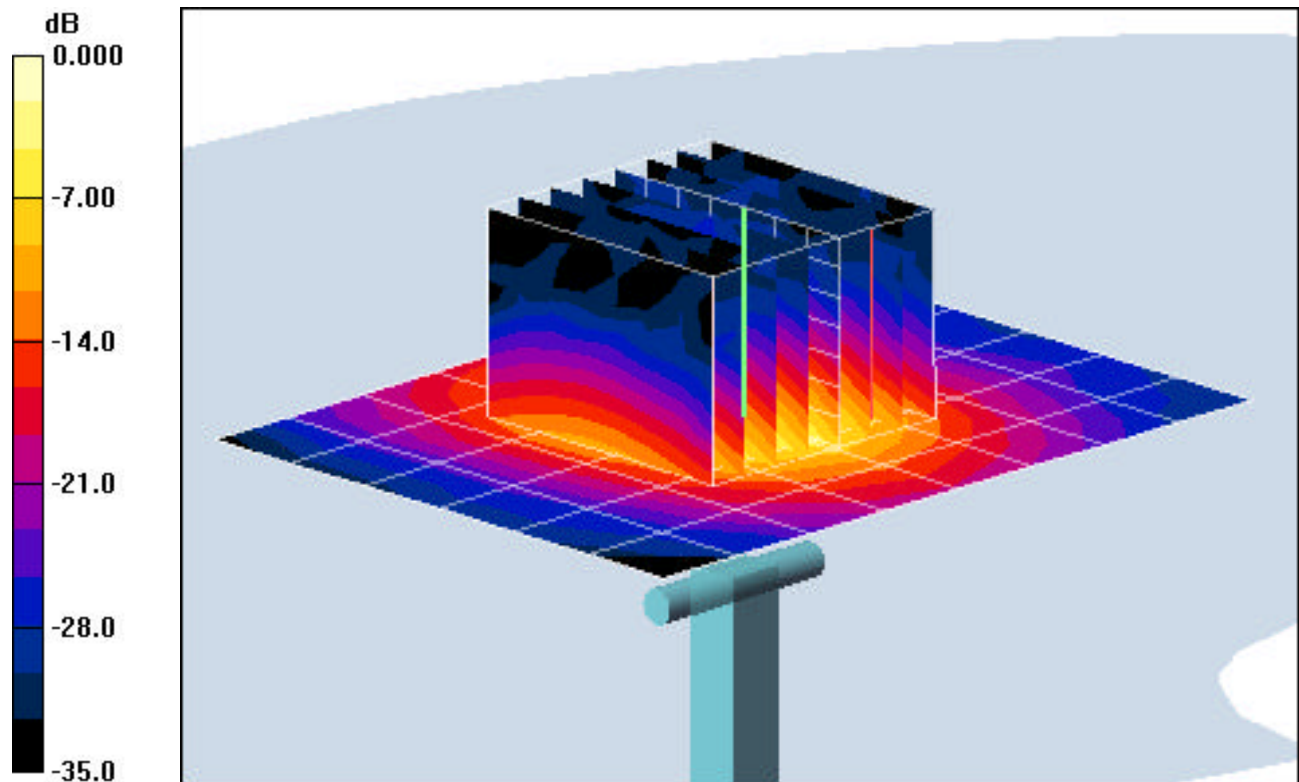

0 dB = 11.4mW/g

PCTEST ENGINEERING LABORATORY, INC.

DUT: 5GHz SAR Validation Dipole; Type: D5GHzV2; Serial: 1007

Communication System: CW; Frequency: 5800 MHz; Duty Cycle: 1:1

Medium: 5800 Muscle ($\sigma = 6.22$ mho/m, $\epsilon_r = 49.63$, $\rho = 1000$ kg/m³)

Phantom section: Flat Section; Space: 1.0 cm

Test Date: 08-12-2008; Ambient Temp: 23.8°C; Tissue Temp: 22.7°C

Probe: EX3DV4 - SN3561; ConvF(3.75, 3.75, 3.75); Calibrated: 8/30/2007

Sensor-Surface: 3mm (Mechanical Surface Detection)

Electronics: DAE4 Sn649; Calibrated: 1/30/2008

Phantom: SAM Main; Type: SAM 4.0; Serial: TP-1114

Measurement SW: DASY4, V4.7 Build 71; Postprocessing SW: SEMCAD, V1.8 Build 172

5800MHz Dipole Validation

Area Scan (7x9x1): Measurement grid: dx=10mm, dy=10mm

Zoom Scan (8x8x8)/Cube 0: Measurement grid: dx=4.3mm, dy=4.3mm, dz=3mm

Input Power = 20.0 dBm (100 mW)

SAR(1 g) = 7.04 mW/g; SAR(10 g) = 1.93 mW/g

Deviation = 4.61 %

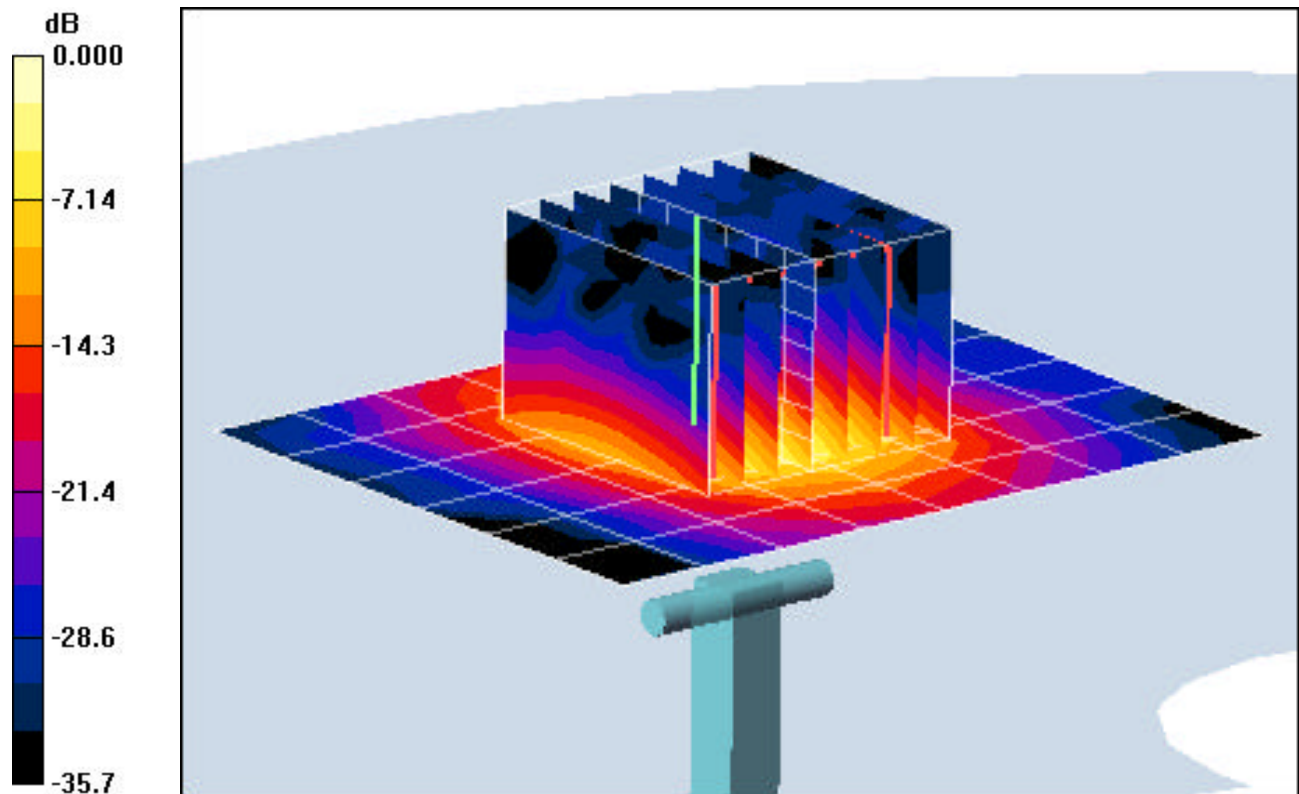

0 dB = 9.39mW/g

APPENDIX C: PROBE CALIBRATION



Accredited by the Swiss Federal Office of Metrology and Accreditation
**The Swiss Accreditation Service is one of the signatories to the EA
Multilateral Agreement for the recognition of calibration certificates**

Accreditation No.: **SCS 108**

Client **PC Test**

Certificate No: **EX3-3561_Aug07**

CALIBRATION CERTIFICATE

Object **EX3DV4 - SN:3561**

Calibration procedure(s) **QA CAL-01.v6 and QA CAL-14.v3
Calibration procedure for dosimetric E-field probes**

Calibration date: **August 30, 2007**

Condition of the calibrated item **In Tolerance**

This calibration certificate documents the traceability to national standards, which realize the physical units of measurements (SI).
The measurements and the uncertainties with confidence probability are given on the following pages and are part of the certificate.

All calibrations have been conducted in the closed laboratory facility: environment temperature (22 ± 3)°C and humidity < 70%.

Calibration Equipment used (M&TE critical for calibration)

Primary Standards	ID #	Cal Date (Calibrated by, Certificate No.)	Scheduled Calibration
Power meter E4419B	GB41293874	29-Mar-07 (METAS, No. 217-00670)	Mar-08
Power sensor E4412A	MY41495277	29-Mar-07 (METAS, No. 217-00670)	Mar-08
Power sensor E4412A	MY41498087	29-Mar-07 (METAS, No. 217-00670)	Mar-08
Reference 3 dB Attenuator	SN: S5054 (3c)	8-Aug-07 (METAS, No. 217-00719)	Aug-08
Reference 20 dB Attenuator	SN: S5086 (20b)	29-Mar-07 (METAS, No. 217-00671)	Mar-08
Reference 30 dB Attenuator	SN: S5129 (30b)	8-Aug-07 (METAS, No. 217-00720)	Aug-08
Reference Probe ES3DV2	SN: 3013	4-Jan-07 (SPEAG, No. ES3-3013_Jan07)	Jan-08
DAE4	SN: 654	20-Apr-07 (SPEAG, No. DAE4-654_Apr07)	Apr-08

Secondary Standards	ID #	Check Date (in house)	Scheduled Check
RF generator HP 8648C	US3642U01700	4-Aug-99 (SPEAG, in house check Nov-05)	In house check: Nov-07
Network Analyzer HP 8753E	US37390585	18-Oct-01 (SPEAG, in house check Oct-06)	In house check: Oct-07

Calibrated by: **Katja Pokovic** **Technical Manager**

Approved by: **Niels Kuster** **Quality Manager**

Issued: August 30, 2007

This calibration certificate shall not be reproduced except in full without written approval of the laboratory.



Accredited by the Swiss Federal Office of Metrology and Accreditation
The Swiss Accreditation Service is one of the signatories to the EA
Multilateral Agreement for the recognition of calibration certificates

Accreditation No.: **SCS 108**

Glossary:

TSL	tissue simulating liquid
NORM _{x,y,z}	sensitivity in free space
ConF	sensitivity in TSL / NORM _{x,y,z}
DCP	diode compression point
Polarization φ	φ rotation around probe axis
Polarization ϑ	ϑ rotation around an axis that is in the plane normal to probe axis (at measurement center), i.e., $\vartheta = 0$ is normal to probe axis

Calibration is Performed According to the Following Standards:

- IEEE Std 1528-2003, "IEEE Recommended Practice for Determining the Peak Spatial-Averaged Specific Absorption Rate (SAR) in the Human Head from Wireless Communications Devices: Measurement Techniques", December 2003
- IEC 62209-1, "Procedure to measure the Specific Absorption Rate (SAR) for hand-held devices used in close proximity to the ear (frequency range of 300 MHz to 3 GHz)", February 2005

Methods Applied and Interpretation of Parameters:

- NORM_{x,y,z}**: Assessed for E-field polarization $\vartheta = 0$ ($f \leq 900$ MHz in TEM-cell; $f > 1800$ MHz: R22 waveguide). NORM_{x,y,z} are only intermediate values, i.e., the uncertainties of NORM_{x,y,z} does not effect the E²-field uncertainty inside TSL (see below *ConvF*).
- NORM(f)_{x,y,z}** = NORM_{x,y,z} * *frequency_response* (see Frequency Response Chart). This linearization is implemented in DASY4 software versions later than 4.2. The uncertainty of the frequency response is included in the stated uncertainty of *ConvF*.
- DCP_{x,y,z}**: DCP are numerical linearization parameters assessed based on the data of power sweep (no uncertainty required). DCP does not depend on frequency nor media.
- ConvF and Boundary Effect Parameters**: Assessed in flat phantom using E-field (or Temperature Transfer Standard for $f \leq 800$ MHz) and inside waveguide using analytical field distributions based on power measurements for $f > 800$ MHz. The same setups are used for assessment of the parameters applied for boundary compensation (alpha, depth) of which typical uncertainty values are given. These parameters are used in DASY4 software to improve probe accuracy close to the boundary. The sensitivity in TSL corresponds to NORM_{x,y,z} * *ConvF* whereby the uncertainty corresponds to that given for *ConvF*. A frequency dependent *ConvF* is used in DASY version 4.4 and higher which allows extending the validity from ± 50 MHz to ± 100 MHz.
- Spherical isotropy (3D deviation from isotropy)**: in a field of low gradients realized using a flat phantom exposed by a patch antenna.
- Sensor Offset**: The sensor offset corresponds to the offset of virtual measurement center from the probe tip (on probe axis). No tolerance required.

Probe EX3DV4

SN:3561

Manufactured:	February 14, 2005
Last calibrated:	November 23, 2006
Recalibrated:	August 30, 2007

Calibrated for DASYS Systems

(Note: non-compatible with DASYS2 system!)

DASY - Parameters of Probe: EX3DV4 SN:3561**Sensitivity in Free Space^A****Diode Compression^B**

NormX	0.440 ± 10.1%	$\mu\text{V}/(\text{V}/\text{m})^2$	DCP X	85 mV
NormY	0.490 ± 10.1%	$\mu\text{V}/(\text{V}/\text{m})^2$	DCP Y	90 mV
NormZ	0.420 ± 10.1%	$\mu\text{V}/(\text{V}/\text{m})^2$	DCP Z	89 mV

Sensitivity in Tissue Simulating Liquid (Conversion Factors)

Please see Page 8.

Boundary Effect**TSL 835 MHz Typical SAR gradient: 5 % per mm**

Sensor Center to Phantom Surface Distance		2.0 mm	3.0 mm
SAR _{b0} [%]	Without Correction Algorithm	1.2	0.1
SAR _{b0} [%]	With Correction Algorithm	0.4	0.0

TSL 1900 MHz Typical SAR gradient: 10 % per mm

Sensor Center to Phantom Surface Distance		2.0 mm	3.0 mm
SAR _{b0} [%]	Without Correction Algorithm	3.0	5.0
SAR _{b0} [%]	With Correction Algorithm	0.2	0.1

Sensor OffsetProbe Tip to Sensor Center **1.0 mm**

The reported uncertainty of measurement is stated as the standard uncertainty of measurement multiplied by the coverage factor k=2, which for a normal distribution corresponds to a coverage probability of approximately 95%.

^A The uncertainties of NormX,Y,Z do not affect the E²-field uncertainty inside TSL (see Page 8).^B Numerical linearization parameter: uncertainty not required.

Frequency Response of E-Field

(TEM-Cell:ifi110 EXX, Waveguide: R22)

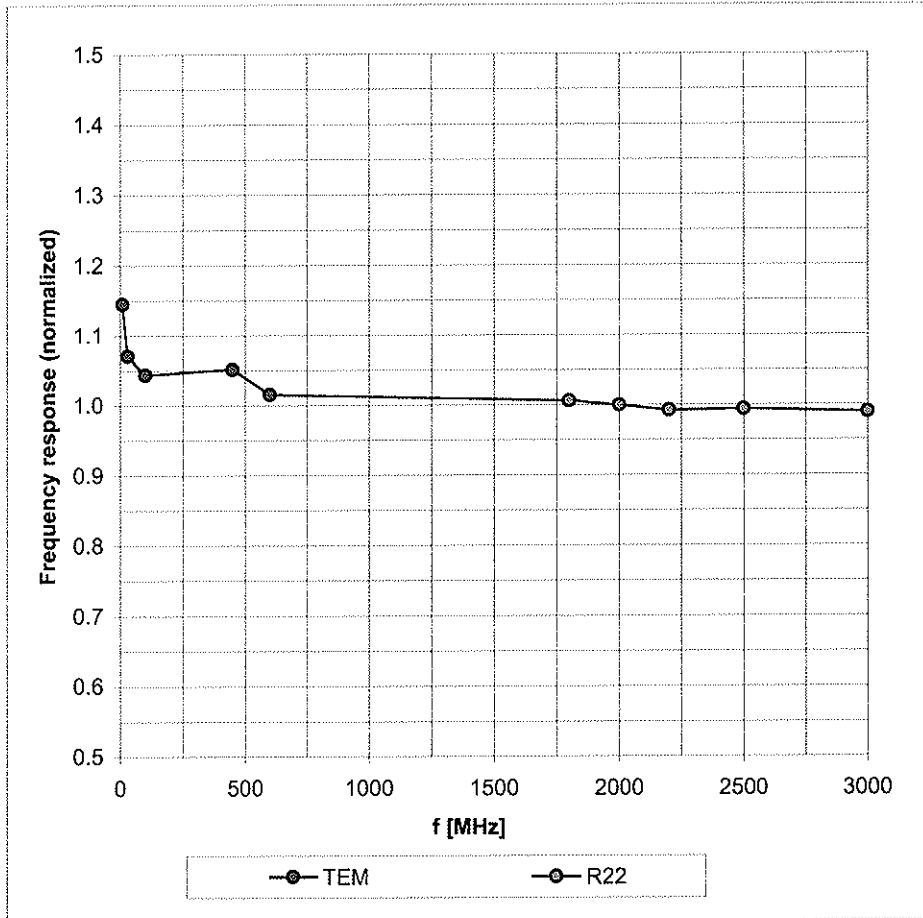

Uncertainty of Frequency Response of E-field: $\pm 6.3\%$ ($k=2$)

Receiving Pattern (ϕ), $\vartheta = 0^\circ$

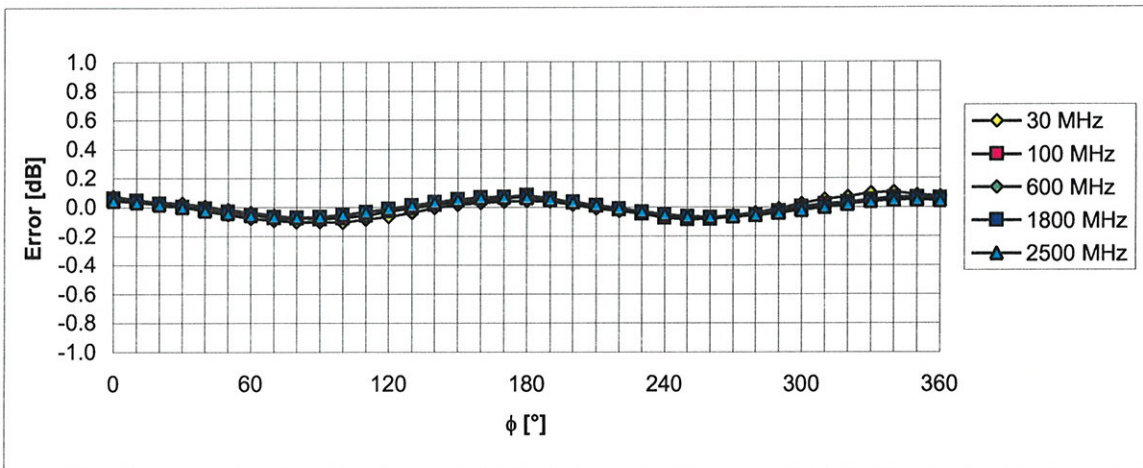
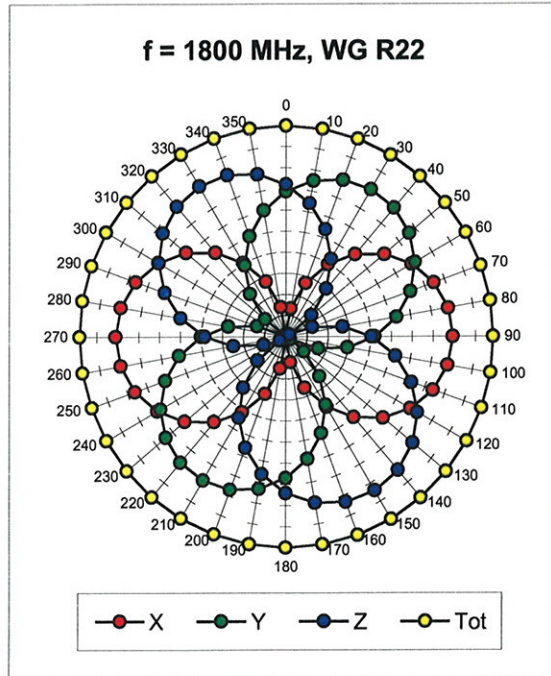
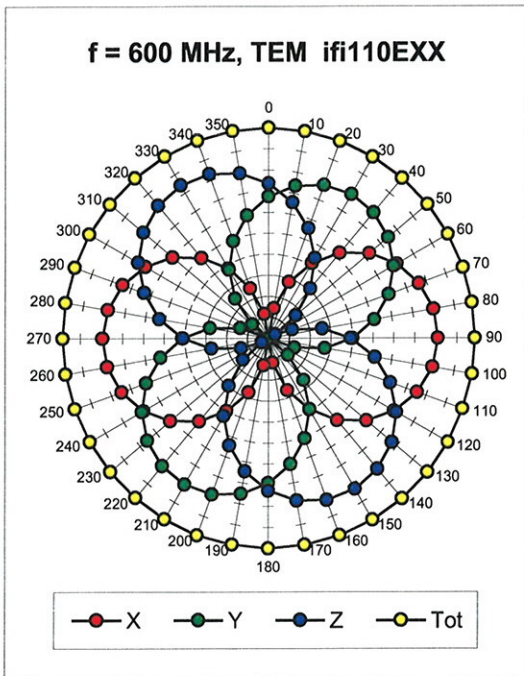

Uncertainty of Axial Isotropy Assessment: $\pm 0.5\%$ ($k=2$)

Dynamic Range $f(\text{SAR}_{\text{head}})$ (Waveguide R22, $f = 1800 \text{ MHz}$)

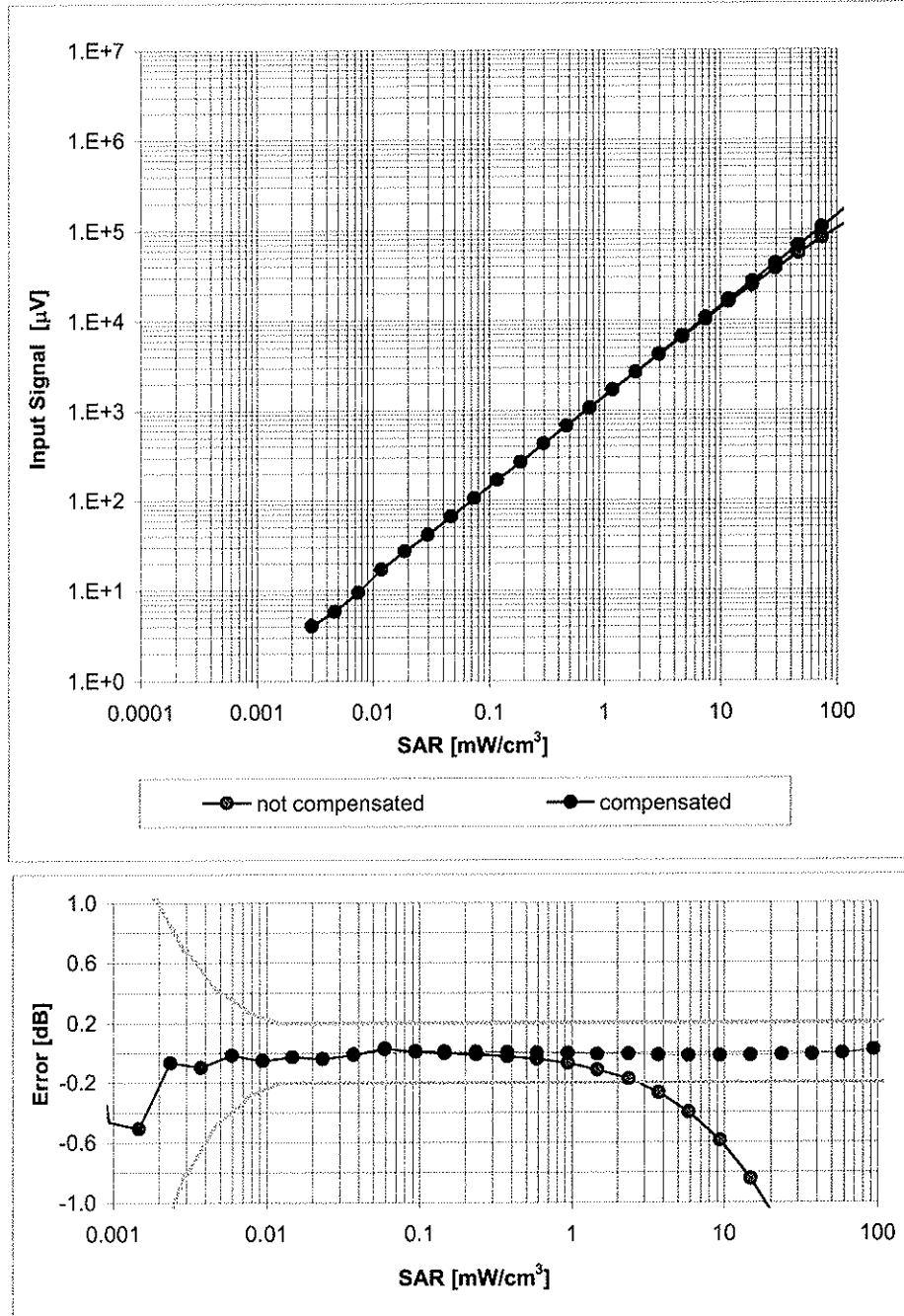

Uncertainty of Linearity Assessment: $\pm 0.6\%$ ($k=2$)

Conversion Factor Assessment

f [MHz]	Validity [MHz] ^c	TSL	Permittivity	Conductivity	Alpha	Depth	ConvF Uncertainty
835	± 50 / ± 100	Head	41.5 ± 5%	0.90 ± 5%	0.65	0.80	8.38 ± 11.0% (k=2)
1750	± 50 / ± 100	Head	40.1 ± 5%	1.37 ± 5%	0.29	1.00	6.85 ± 11.0% (k=2)
1900	± 50 / ± 100	Head	40.0 ± 5%	1.40 ± 5%	0.23	1.10	6.71 ± 11.0% (k=2)
2450	± 50 / ± 100	Head	39.2 ± 5%	1.80 ± 5%	0.41	1.00	6.26 ± 11.8% (k=2)
2600	± 50 / ± 100	Head	39.0 ± 5%	1.96 ± 5%	0.42	1.00	6.09 ± 11.8% (k=2)
4950	± 50 / ± 100	Head	36.3 ± 5%	4.40 ± 5%	0.44	1.45	4.77 ± 13.1% (k=2)
5200	± 50 / ± 100	Head	36.0 ± 5%	4.66 ± 5%	0.42	1.45	4.56 ± 13.1% (k=2)
5300	± 50 / ± 100	Head	35.9 ± 5%	4.76 ± 5%	0.40	1.45	4.26 ± 13.1% (k=2)
5500	± 50 / ± 100	Head	35.6 ± 5%	4.96 ± 5%	0.45	1.45	4.26 ± 13.1% (k=2)
5600	± 50 / ± 100	Head	35.5 ± 5%	5.07 ± 5%	0.42	1.45	4.06 ± 13.1% (k=2)
5800	± 50 / ± 100	Head	35.3 ± 5%	5.27 ± 5%	0.40	1.45	4.05 ± 13.1% (k=2)
835	± 50 / ± 100	Body	55.2 ± 5%	0.97 ± 5%	0.70	0.80	8.27 ± 11.0% (k=2)
1750	± 50 / ± 100	Body	53.4 ± 5%	1.49 ± 5%	0.19	1.26	6.82 ± 11.0% (k=2)
1900	± 50 / ± 100	Body	53.3 ± 5%	1.52 ± 5%	0.19	1.25	6.60 ± 11.0% (k=2)
2450	± 50 / ± 100	Body	52.7 ± 5%	1.95 ± 5%	0.48	1.00	6.15 ± 11.8% (k=2)
2600	± 50 / ± 100	Body	52.5 ± 5%	2.16 ± 5%	0.46	1.00	5.86 ± 11.8% (k=2)
4950	± 50 / ± 100	Body	49.4 ± 5%	5.01 ± 5%	0.43	1.65	4.06 ± 13.1% (k=2)
5200	± 50 / ± 100	Body	49.0 ± 5%	5.30 ± 5%	0.39	1.65	3.83 ± 13.1% (k=2)
5300	± 50 / ± 100	Body	48.9 ± 5%	5.42 ± 5%	0.38	1.65	3.67 ± 13.1% (k=2)
5500	± 50 / ± 100	Body	48.6 ± 5%	5.65 ± 5%	0.36	1.65	3.67 ± 13.1% (k=2)
5600	± 50 / ± 100	Body	48.5 ± 5%	5.77 ± 5%	0.36	1.65	3.81 ± 13.1% (k=2)
5800	± 50 / ± 100	Body	48.2 ± 5%	6.00 ± 5%	0.33	1.65	3.75 ± 13.1% (k=2)

^c The validity of ± 100 MHz only applies for DASY v4.4 and higher (see Page 2). The uncertainty is the RSS of the ConvF uncertainty at calibration frequency and the uncertainty for the indicated frequency band.

Deviation from Isotropy in HSL

Error (ϕ, ϑ), $f = 900$ MHz

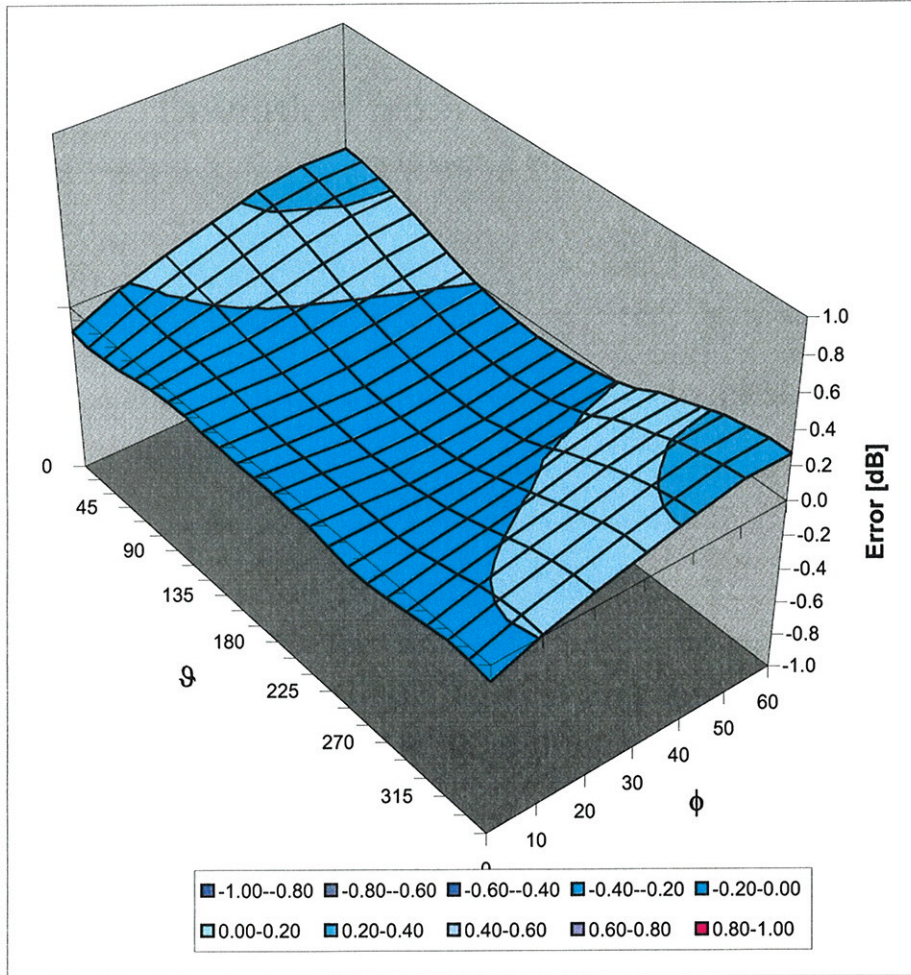

Uncertainty of Spherical Isotropy Assessment: $\pm 2.6\%$ ($k=2$)