

APPENDIX A: SAR TEST DATA

PCTEST ENGINEERING LABORATORY, INC.

DUT: CF-U1; Type: Tablet PC with 802.11abgn, Bluetooth and EVDO; Serial: DVT1-43

Communication System: Cellular CDMA; Frequency: 836.52 MHz; Duty Cycle: 1:1

Medium: 835 Muscle ($\sigma = 0.93$ mho/m, $\epsilon_r = 53.99$, $\rho = 1000$ kg/m³)

Phantom section: Flat Section; Space: 0.0 cm

Test Date: 04-16-2008; Ambient Temp: 23.5°C; Tissue Temp: 21.9°C

Probe: EX3DV4 - SN3561; ConvF(8.27, 8.27, 8.27); Calibrated: 8/30/2007

Sensor-Surface: 3mm (Mechanical Surface Detection)

Electronics: DAE4 Sn649; Calibrated: 1/30/2008

Phantom: SAM Main; Type: SAM 4.0; Serial: TP-1114

Measurement SW: DASY4, V4.7 Build 53; Postprocessing SW: SEMCAD, V1.8 Build 172

Mode: Cellular EVDO Rev.0, Laptop position, Mid.ch

Area Scan (13x15x1): Measurement grid: dx=15mm, dy=15mm

Zoom Scan (5x5x7)/Cube 0: Measurement grid: dx=8mm, dy=8mm, dz=5mm

Reference Value = 13.7 V/m

Peak SAR (extrapolated) = 0.218 W/kg

SAR(1 g) = 0.160 mW/g; SAR(10 g) = 0.114 mW/g

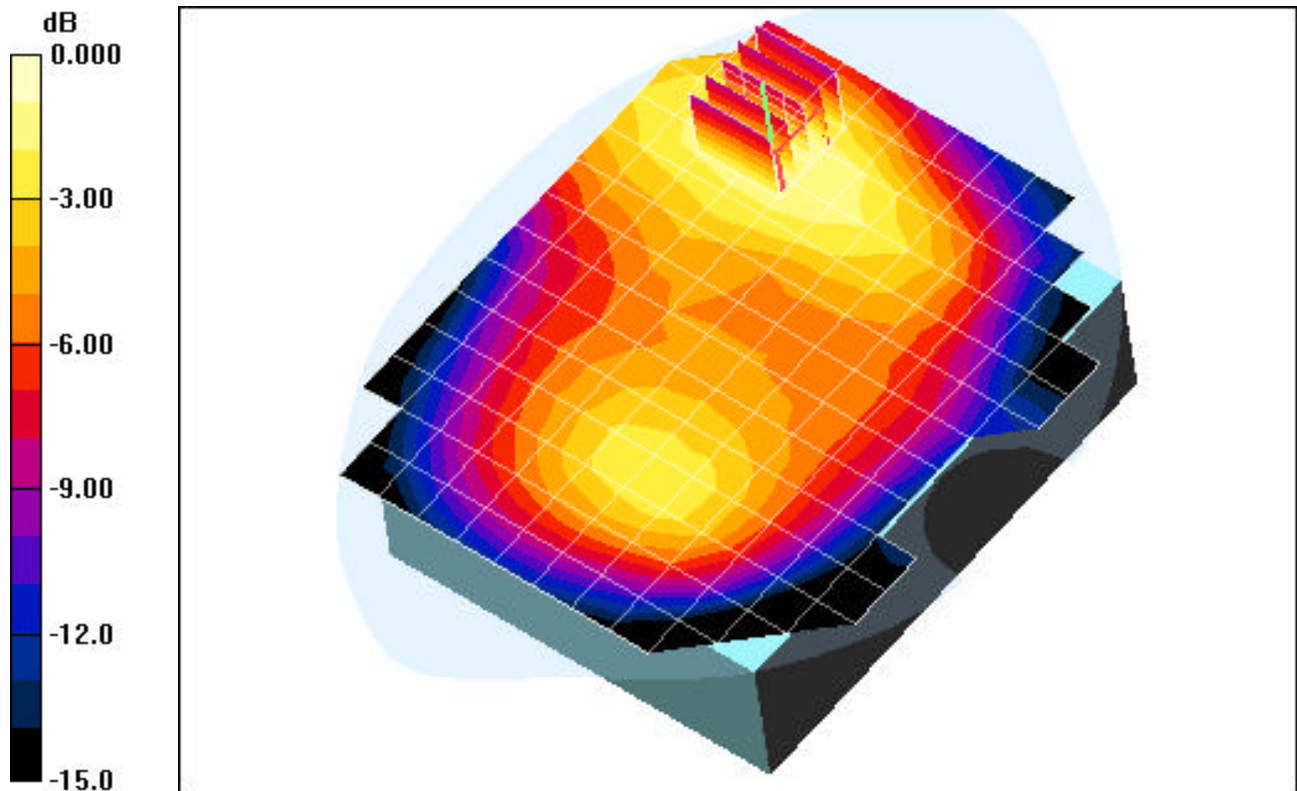

0 dB = 0.200mW/g

PCTEST ENGINEERING LABORATORY, INC.

DUT: CF-U1; Type: Tablet PC with 802.11abgn, Bluetooth and EVDO; Serial: DVT1-43

Communication System: Cellular CDMA; Frequency: 824.7 MHz; Duty Cycle: 1:1
Medium: 835 Muscle ($\sigma = 0.93$ mho/m, $\epsilon_r = 53.99$, $\rho = 1000$ kg/m³)
Phantom section: Flat Section; Space: 0.0 cm

Test Date: 04-16-2008; Ambient Temp: 23.5°C; Tissue Temp: 21.9°C

Probe: EX3DV4 - SN3561; ConvF(8.27, 8.27, 8.27); Calibrated: 8/30/2007
Sensor-Surface: 3mm (Mechanical Surface Detection)
Electronics: DAE4 Sn649; Calibrated: 1/30/2008
Phantom: SAM Main; Type: SAM 4.0; Serial: TP-1114
Measurement SW: DASY4, V4.7 Build 53; Postprocessing SW: SEMCAD, V1.8 Build 172

Mode: Cellular EVDO Rev.0, Tablet position, Bottom side, Low.ch

Area Scan (7x15x1): Measurement grid: dx=15mm, dy=15mm
Zoom Scan (5x5x7)/Cube 0: Measurement grid: dx=8mm, dy=8mm, dz=5mm
Reference Value = 8.05 V/m
Peak SAR (extrapolated) = 0.057 W/kg
SAR(1 g) = 0.044 mW/g; SAR(10 g) = 0.033 mW/g

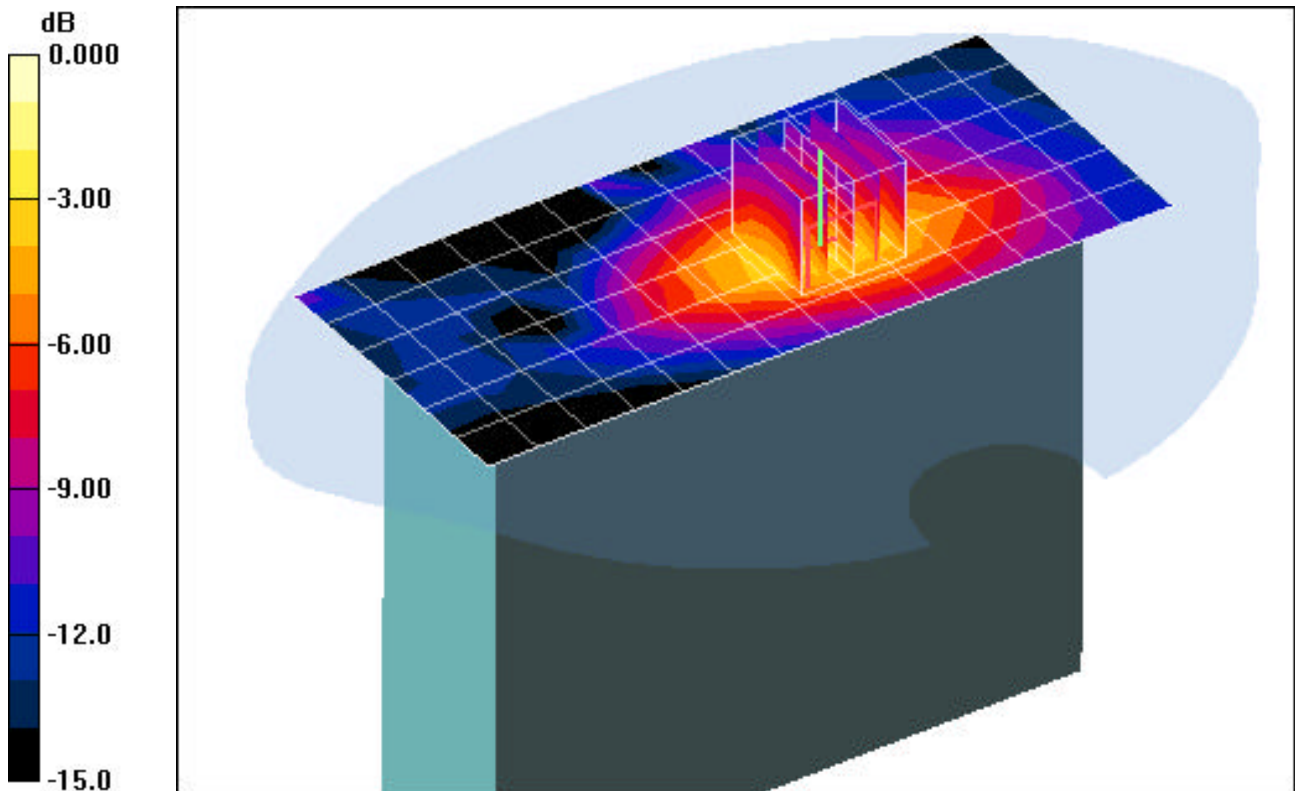

0 dB = 0.100mW/g

PCTEST ENGINEERING LABORATORY, INC.

DUT: CF-U1; Type: Tablet PC with 802.11abgn, Bluetooth and EVDO; Serial: DVT1-43

Communication System: PCS CDMA; Frequency: 1880 MHz; Duty Cycle: 1:1

Medium: 1900 Muscle ($\sigma = 1.59$ mho/m, $\epsilon_r = 54.87$, $\rho = 1000$ kg/m³)

Phantom section: Flat Section; Space: 0.0 cm

Test Date: 04-16-2008; Ambient Temp: 22.8°C; Tissue Temp: 21.4°C

Probe: EX3DV4 - SN3561; ConvF(6.6, 6.6, 6.6); Calibrated: 8/30/2007

Sensor-Surface: 3mm (Mechanical Surface Detection)

Electronics: DAE4 Sn649; Calibrated: 1/30/2008

Phantom: SAM Sub; Type: SAM 4.0; Serial: TP-1357

Measurement SW: DASY4, V4.7 Build 53; Postprocessing SW: SEMCAD, V1.8 Build 172

Mode: PCS EVDO Rev.0, Laptop position, Mid.ch

Area Scan (13x15x1): Measurement grid: dx=15mm, dy=15mm

Zoom Scan (5x5x7)/Cube 0: Measurement grid: dx=8mm, dy=8mm, dz=5mm

Reference Value = 7.51 V/m

Peak SAR (extrapolated) = 0.134 W/kg

SAR(1 g) = 0.076 mW/g; SAR(10 g) = 0.044 mW/g

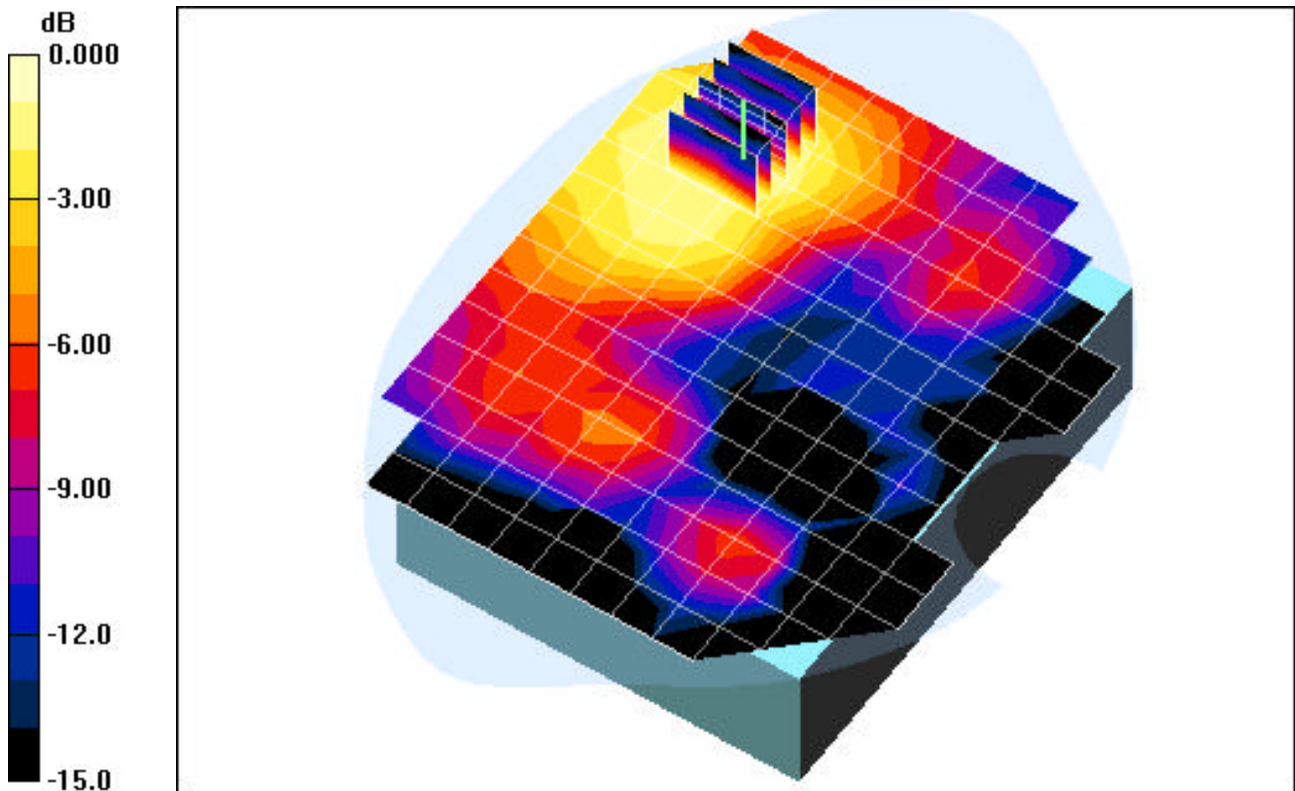

0 dB = 0.100mW/g

PCTEST ENGINEERING LABORATORY, INC.

DUT: CF-U1; Type: Tablet PC with 802.11abgn, Bluetooth and EVDO; Serial: DVT1-43

Communication System: PCS CDMA; Frequency: 1851.25 MHz; Duty Cycle: 1:1

Medium: 1900 Muscle ($\sigma = 1.59$ mho/m, $\epsilon_r = 54.87$, $\rho = 1000$ kg/m³)

Phantom section: Flat Section; Space: 0.0 cm

Test Date: 04-16-2008; Ambient Temp: 22.8°C; Tissue Temp: 21.4°C

Probe: EX3DV4 - SN3561; ConvF(6.6, 6.6, 6.6); Calibrated: 8/30/2007

Sensor-Surface: 3mm (Mechanical Surface Detection)

Electronics: DAE4 Sn649; Calibrated: 1/30/2008

Phantom: SAM Sub; Type: SAM 4.0; Serial: TP-1357

Measurement SW: DASY4, V4.7 Build 53; Postprocessing SW: SEMCAD, V1.8 Build 172

Mode: PCS EVDO Rev.0, Tablet position, Bottom side, Low.ch

Area Scan (7x15x1): Measurement grid: dx=15mm, dy=15mm

Zoom Scan (5x5x7)/Cube 0: Measurement grid: dx=8mm, dy=8mm, dz=5mm

Reference Value = 4.75 V/m

Peak SAR (extrapolated) = 0.065 W/kg

SAR(1 g) = 0.034 mW/g; SAR(10 g) = 0.018 mW/g

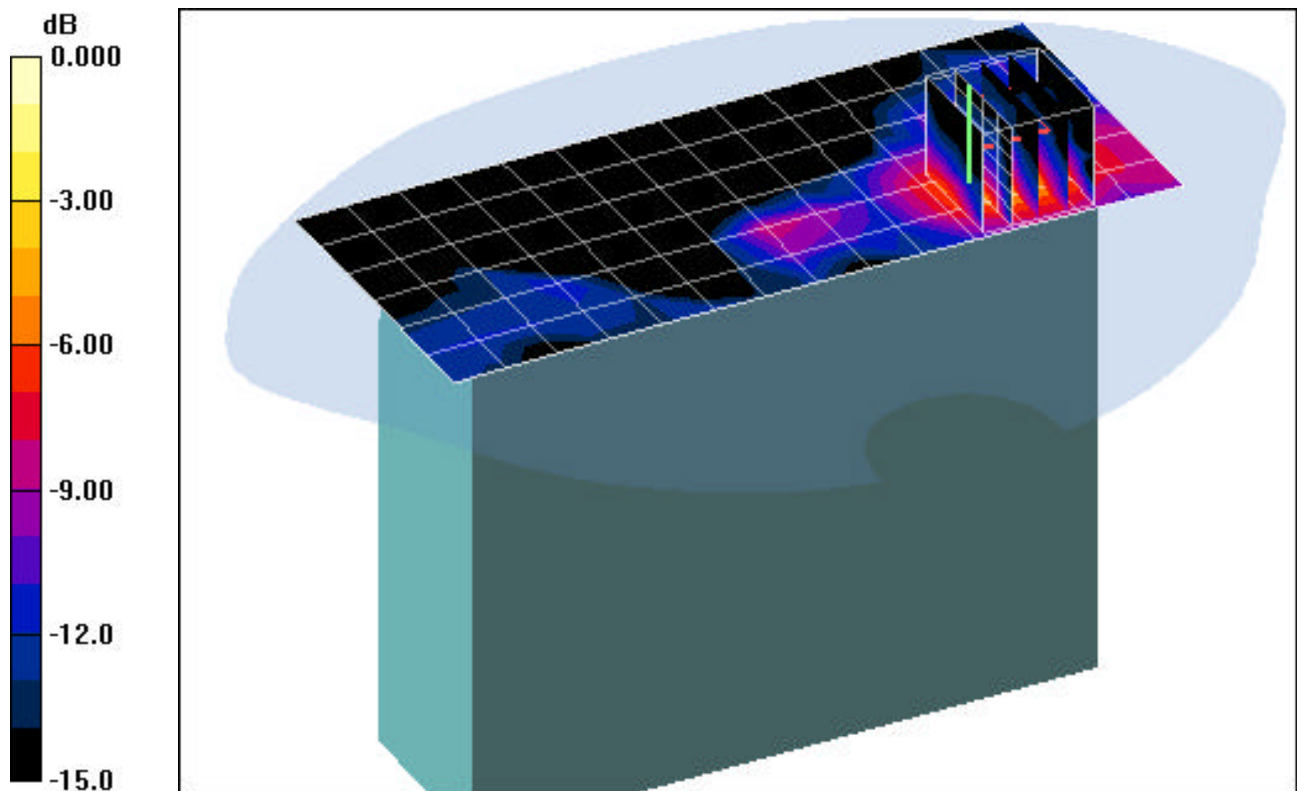

0 dB = 0.100mW/g

PCTEST ENGINEERING LABORATORY, INC.

DUT: CF-U1; Type: Tablet PC with 802.11abgn, Bluetooth and EVDO; Serial: DVT1-43

Communication System: Bluetooth; Frequency: 2441 MHz; Duty Cycle: 1:1

Medium: 2450 Muscle ($\sigma = 1.90$ mho/m, $\epsilon_r = 50.38$, $\rho = 1000$ kg/m³)

Phantom section: Flat Section; Space: 0.0 cm

Test Date: 04-16-2008; Ambient Temp: 23.1°C; Tissue Temp: 21.5°C

Probe: EX3DV4 - SN3561; ConvF(6.15, 6.15, 6.15); Calibrated: 8/30/2007

Sensor-Surface: 3mm (Mechanical Surface Detection)

Electronics: DAE4 Sn649; Calibrated: 1/30/2008

Phantom: SAM Main; Type: SAM 4.0; Serial: TP-1114

Measurement SW: DASY4, V4.7 Build 53; Postprocessing SW: SEMCAD, V1.8 Build 172

Mode: Bluetooth, Laptop position, Mid.ch

Area Scan (13x15x1): Measurement grid: dx=15mm, dy=15mm

Zoom Scan (5x5x7)/Cube 0: Measurement grid: dx=8mm, dy=8mm, dz=5mm

Reference Value = 4.02 V/m

Peak SAR (extrapolated) = 0.059 W/kg

SAR(1 g) = 0.029 mW/g; SAR(10 g) = 0.015 mW/g

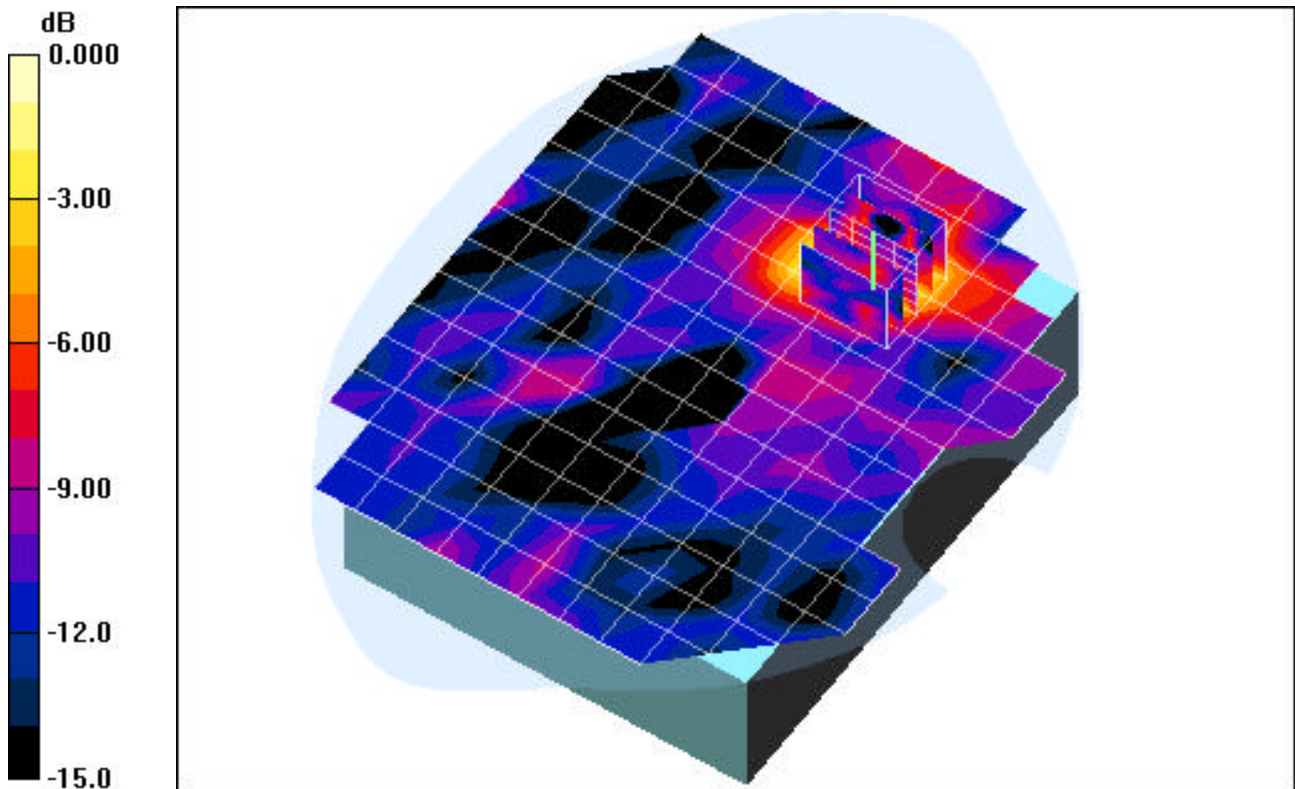

0 dB = 0.050mW/g

PCTEST ENGINEERING LABORATORY, INC.

DUT: CF-U1; Type: Tablet PC with 802.11abgn, Bluetooth and EVDO; Serial: DVT1-43

Communication System: Bluetooth; Frequency: 2441 MHz; Duty Cycle: 1:1

Medium: 2450 Muscle ($\sigma = 1.90$ mho/m, $\epsilon_r = 50.38$, $\rho = 1000$ kg/m³)

Phantom section: Flat Section; Space: 0.0 cm

Test Date: 04-16-2008; Ambient Temp: 23.1°C; Tissue Temp: 21.5°C

Probe: EX3DV4 - SN3561; ConvF(6.15, 6.15, 6.15); Calibrated: 8/30/2007

Sensor-Surface: 3mm (Mechanical Surface Detection)

Electronics: DAE4 Sn649; Calibrated: 1/30/2008

Phantom: SAM Main; Type: SAM 4.0; Serial: TP-1114

Measurement SW: DASY4, V4.7 Build 53; Postprocessing SW: SEMCAD, V1.8 Build 172

Mode: Bluetooth, Tablet position, Bottom side, Mid.ch

Area Scan (7x15x1): Measurement grid: dx=15mm, dy=15mm

Zoom Scan (5x5x7)/Cube 0: Measurement grid: dx=8mm, dy=8mm, dz=5mm

Reference Value = 2.85 V/m

Peak SAR (extrapolated) = 0.028 W/kg

SAR(1 g) = 0.015 mW/g; SAR(10 g) = 0.011 mW/g

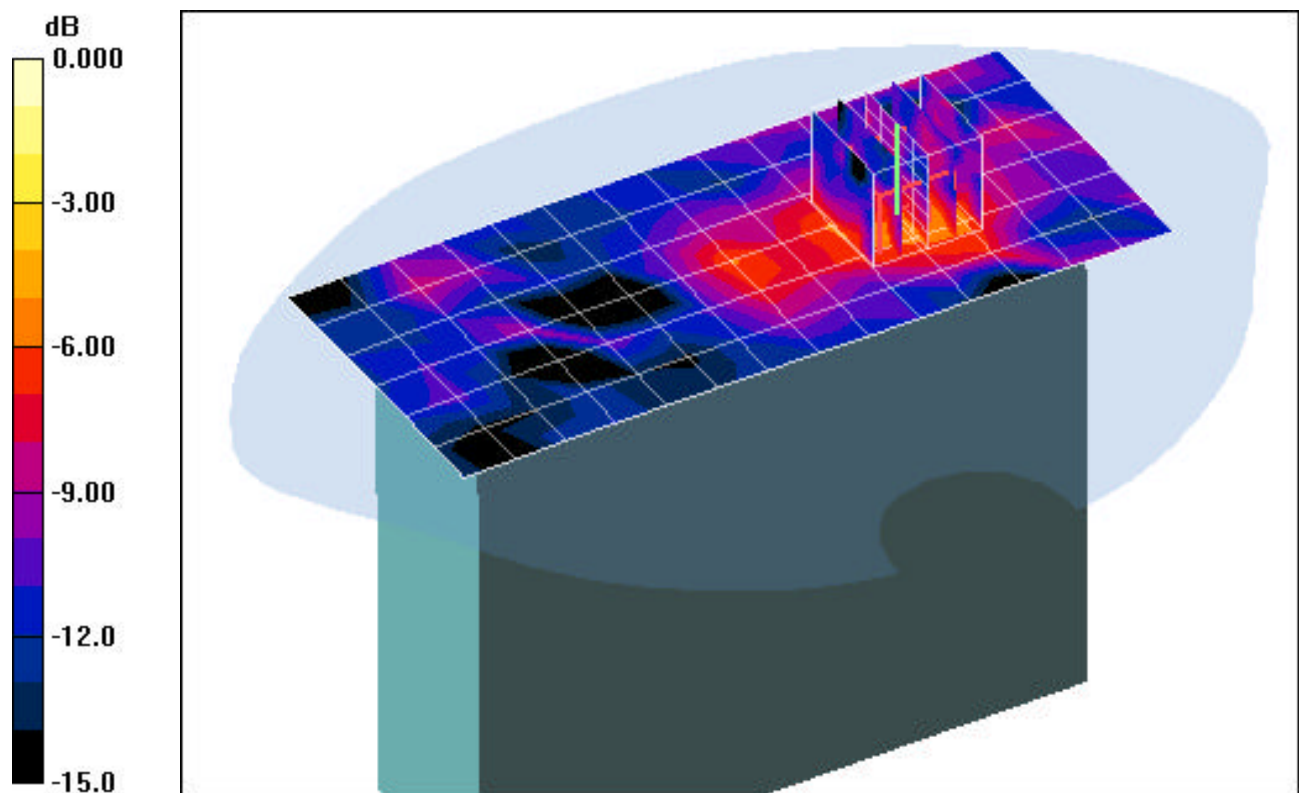

0 dB = 0.050mW/g

PCTEST ENGINEERING LABORATORY, INC.

DUT: CF-U1; Type: Tablet PC with 802.11abgn, Bluetooth and EVDO; Serial: DVT1-43

Communication System: IEEE 802.11b; Frequency: 2437 MHz; Duty Cycle: 1:1

Medium: 2450 Muscle ($\sigma = 1.90$ mho/m, $\epsilon_r = 50.38$, $\rho = 1000$ kg/m³)

Phantom section: Flat Section; Space: 0.0 cm

Test Date: 04-17-2008; Ambient Temp: 23.3°C; Tissue Temp: 21.5°C

Probe: EX3DV4 - SN3561; ConvF(6.15, 6.15, 6.15); Calibrated: 8/30/2007

Sensor-Surface: 3mm (Mechanical Surface Detection)

Electronics: DAE4 Sn649; Calibrated: 1/30/2008

Phantom: SAM Main; Type: SAM 4.0; Serial: TP-1114

Measurement SW: DASY4, V4.7 Build 53; Postprocessing SW: SEMCAD, V1.8 Build 172

Mode: 802.11b, Laptop position, 1Mbps, Mid.ch

Area Scan (13x15x1): Measurement grid: dx=15mm, dy=15mm

Zoom Scan (5x5x7)/Cube 0: Measurement grid: dx=8mm, dy=8mm, dz=5mm

Reference Value = 4.73 V/m

Peak SAR (extrapolated) = 0.078 W/kg

SAR(1 g) = 0.037 mW/g; SAR(10 g) = 0.020 mW/g

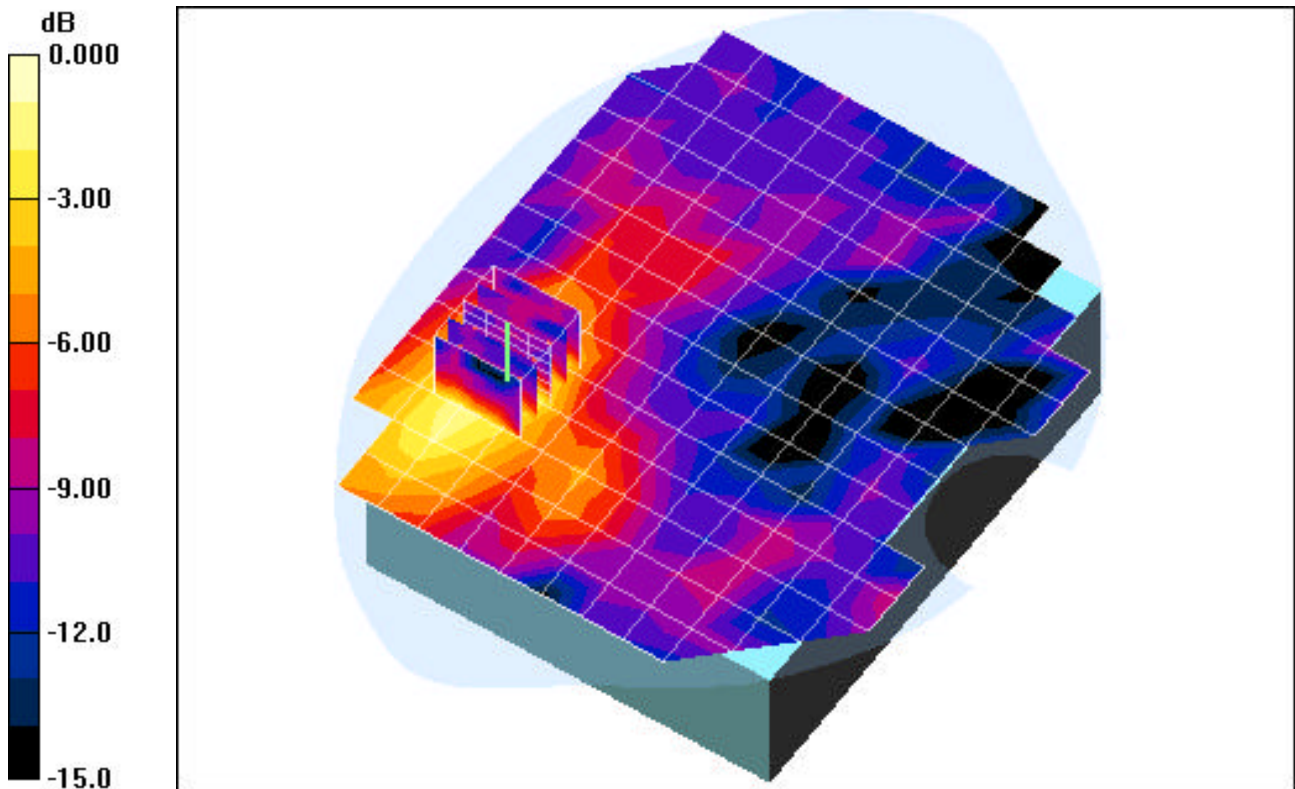

0 dB = 0.050mW/g

PCTEST ENGINEERING LABORATORY, INC.

DUT: CF-U1; Type: Tablet PC with 802.11abgn, Bluetooth and EVDO; Serial: DVT1-43

Communication System: IEEE 802.11b; Frequency: 2412 MHz; Duty Cycle: 1:1

Medium: 2450 Muscle ($\sigma = 1.90$ mho/m, $\epsilon_r = 50.38$, $\rho = 1000$ kg/m³)

Phantom section: Flat Section; Space: 0.0 cm

Test Date: 04-17-2008; Ambient Temp: 23.3°C; Tissue Temp: 21.5°C

Probe: EX3DV4 - SN3561; ConvF(6.15, 6.15, 6.15); Calibrated: 8/30/2007

Sensor-Surface: 3mm (Mechanical Surface Detection)

Electronics: DAE4 Sn649; Calibrated: 1/30/2008

Phantom: SAM Main; Type: SAM 4.0; Serial: TP-1114

Measurement SW: DASY4, V4.7 Build 53; Postprocessing SW: SEMCAD, V1.8 Build 172

Mode: 802.11b, Tablet position, Bottom side, 1Mbps, Low.ch

Area Scan (7x15x1): Measurement grid: dx=15mm, dy=15mm

Zoom Scan (5x5x7)/Cube 0: Measurement grid: dx=8mm, dy=8mm, dz=5mm

Reference Value = 1.48 V/m

Peak SAR (extrapolated) = 0.013 W/kg

SAR(1 g) = 0.008 mW/g; SAR(10 g) = 0.00532 mW/g

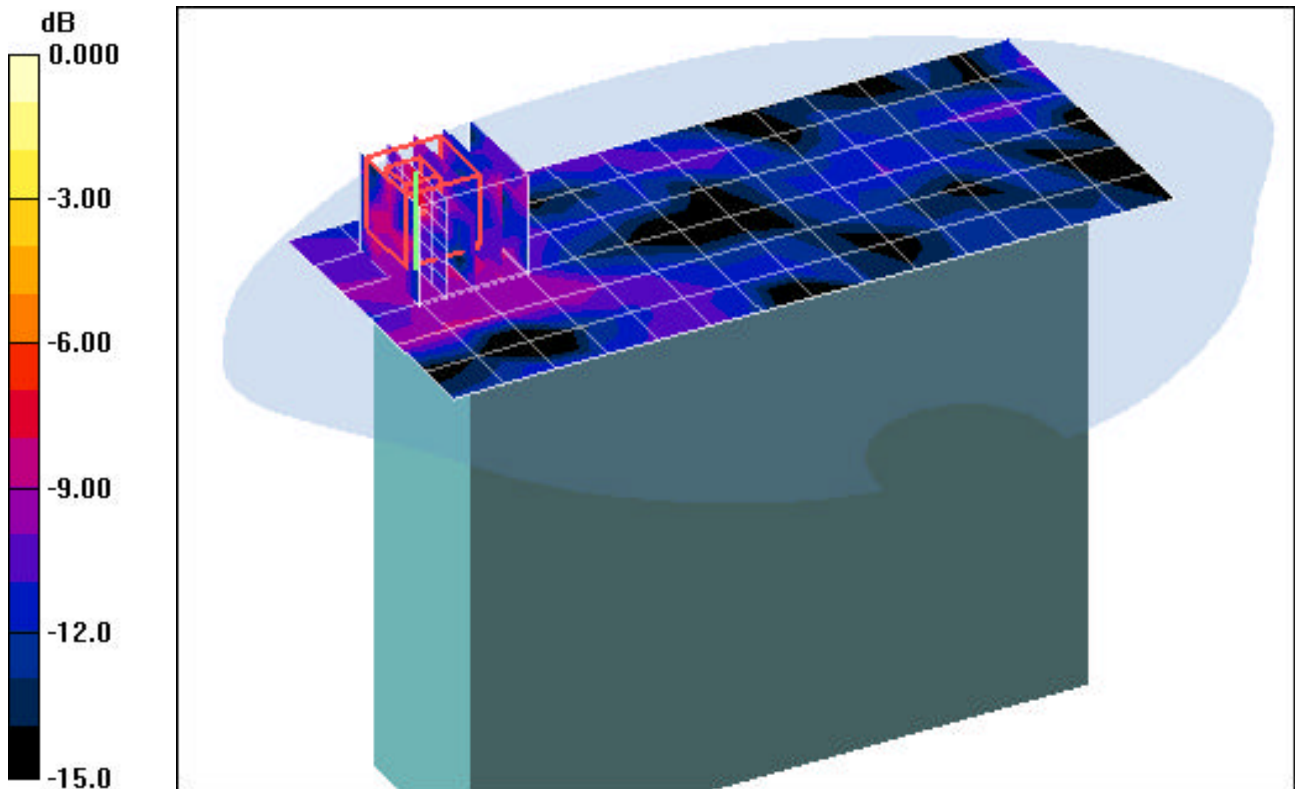

0 dB = 0.050mW/g

PCTEST ENGINEERING LABORATORY, INC.

DUT: CF-U1; Type: Tablet PC with 802.11abgn, Bluetooth and EVDO; Serial: DVT1-43

Communication System: IEEE 802.11g; Frequency: 2437 MHz; Duty Cycle: 1:1

Medium: 2450 Muscle ($\sigma = 1.90$ mho/m, $\epsilon_r = 50.38$, $\rho = 1000$ kg/m³)

Phantom section: Flat Section; Space: 0.0 cm

Test Date: 04-17-2008; Ambient Temp: 23.3°C; Tissue Temp: 21.5°C

Probe: EX3DV4 - SN3561; ConvF(6.15, 6.15, 6.15); Calibrated: 8/30/2007

Sensor-Surface: 3mm (Mechanical Surface Detection)

Electronics: DAE4 Sn649; Calibrated: 1/30/2008

Phantom: SAM Main; Type: SAM 4.0; Serial: TP-1114

Measurement SW: DASY4, V4.7 Build 53; Postprocessing SW: SEMCAD, V1.8 Build 172

Mode: 802.11g, Laptop position, 6Mbps, Mid.ch

Area Scan (13x15x1): Measurement grid: dx=15mm, dy=15mm

Zoom Scan (5x5x7)/Cube 0: Measurement grid: dx=8mm, dy=8mm, dz=5mm

Reference Value = 5.67 V/m

Peak SAR (extrapolated) = 0.091 W/kg

SAR(1 g) = 0.050 mW/g; SAR(10 g) = 0.029 mW/g

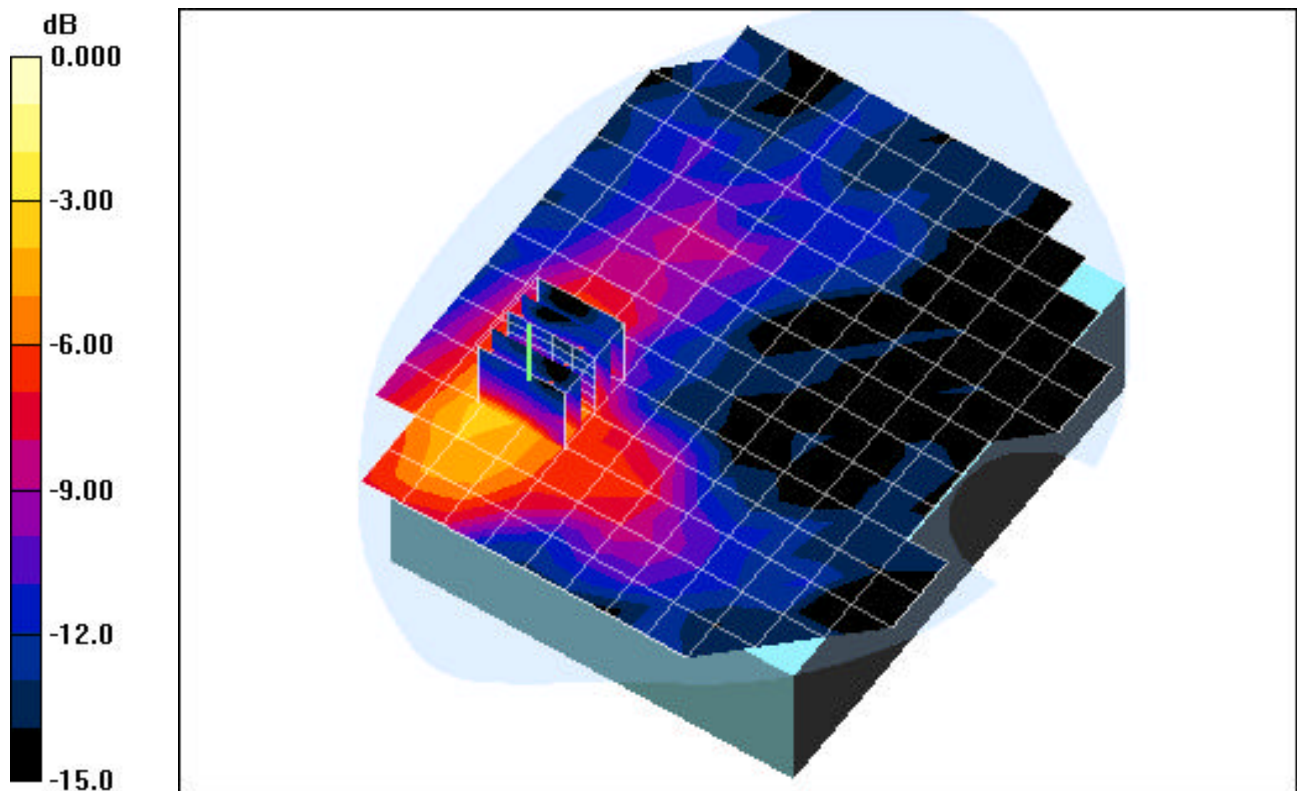

0 dB = 0.100mW/g

PCTEST ENGINEERING LABORATORY, INC.

DUT: CF-U1; Type: Tablet PC with 802.11abgn, Bluetooth and EVDO; Serial: DVT1-43

Communication System: IEEE 802.11g; Frequency: 2437 MHz; Duty Cycle: 1:1

Medium: 2450 Muscle ($\sigma = 1.90$ mho/m, $\epsilon_r = 50.38$, $\rho = 1000$ kg/m³)

Phantom section: Flat Section; Space: 0.0 cm

Test Date: 04-17-2008; Ambient Temp: 23.3°C; Tissue Temp: 21.5°C

Probe: EX3DV4 - SN3561; ConvF(6.15, 6.15, 6.15); Calibrated: 8/30/2007

Sensor-Surface: 3mm (Mechanical Surface Detection)

Electronics: DAE4 Sn649; Calibrated: 1/30/2008

Phantom: SAM Main; Type: SAM 4.0; Serial: TP-1114

Measurement SW: DASY4, V4.7 Build 53; Postprocessing SW: SEMCAD, V1.8 Build 172

Mode: 802.11g, Tablet position, Bottom side, 6Mbps, Mid.ch

Area Scan (7x15x1): Measurement grid: dx=15mm, dy=15mm

Zoom Scan (5x5x7)/Cube 0: Measurement grid: dx=8mm, dy=8mm, dz=5mm

Reference Value = 2.48 V/m

Peak SAR (extrapolated) = 0.015 W/kg

SAR(1 g) = 0.010 mW/g; SAR(10 g) = 0.00717 mW/g

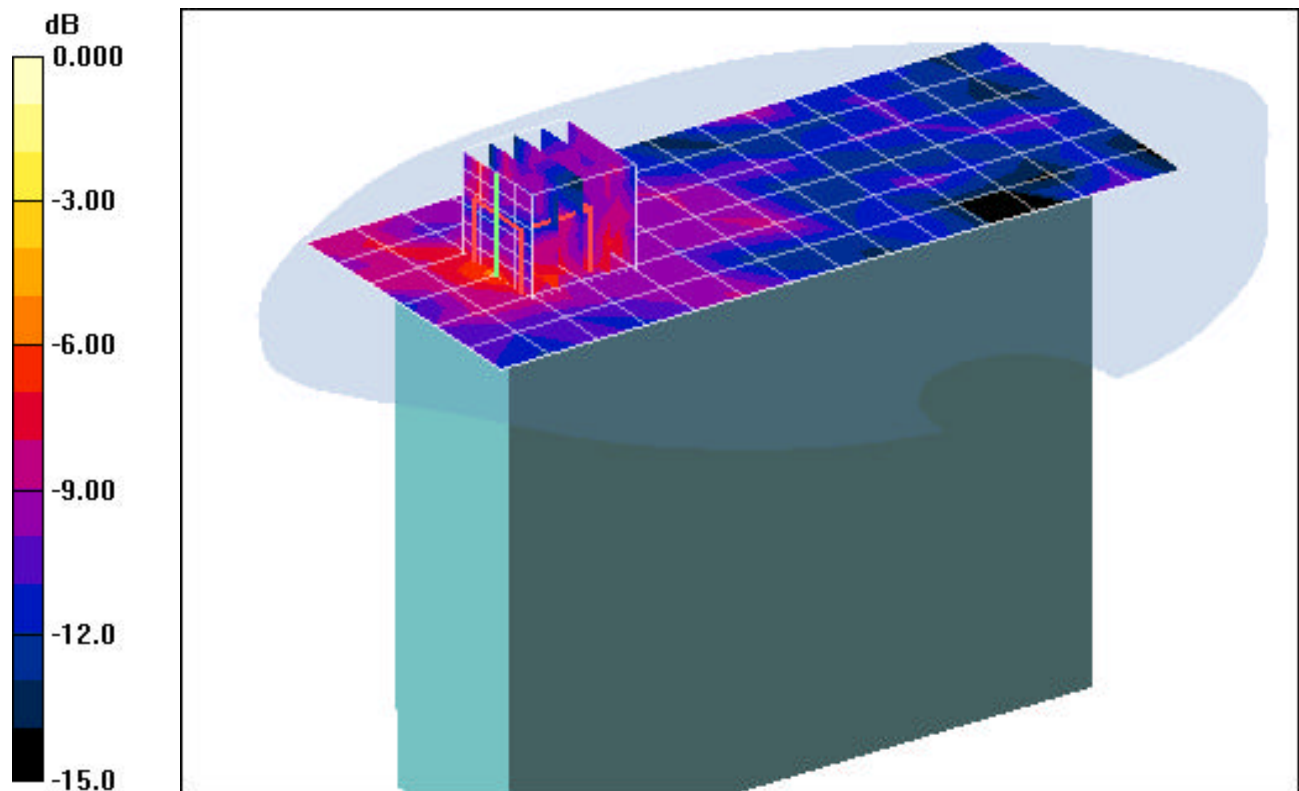

0 dB = 0.050mW/g

PCTEST ENGINEERING LABORATORY, INC.

DUT: CF-U1; Type: Tablet PC with 802.11abgn, Bluetooth and EVDO; Serial: DVT1-43

Communication System: IEEE 802.11n; Frequency: 2437 MHz; Duty Cycle: 1:1

Medium: 2450 Muscle ($\sigma = 1.90$ mho/m, $\epsilon_r = 50.38$, $\rho = 1000$ kg/m³)

Phantom section: Flat Section; Space: 0.0 cm

Test Date: 04-17-2008; Ambient Temp: 23.3°C; Tissue Temp: 21.5°C

Probe: EX3DV4 - SN3561; ConvF(6.15, 6.15, 6.15); Calibrated: 8/30/2007

Sensor-Surface: 3mm (Mechanical Surface Detection)

Electronics: DAE4 Sn649; Calibrated: 1/30/2008

Phantom: SAM Main; Type: SAM 4.0; Serial: TP-1114

Measurement SW: DASY4, V4.7 Build 53; Postprocessing SW: SEMCAD, V1.8 Build 172

Mode: 802.11n, Laptop position, 13.5Mbps, Mid.ch

Area Scan (13x15x1): Measurement grid: dx=15mm, dy=15mm

Zoom Scan (5x5x7)/Cube 0: Measurement grid: dx=8mm, dy=8mm, dz=5mm

Reference Value = 5.30 V/m

Peak SAR (extrapolated) = 0.096 W/kg

SAR(1 g) = 0.052 mW/g; SAR(10 g) = 0.028 mW/g

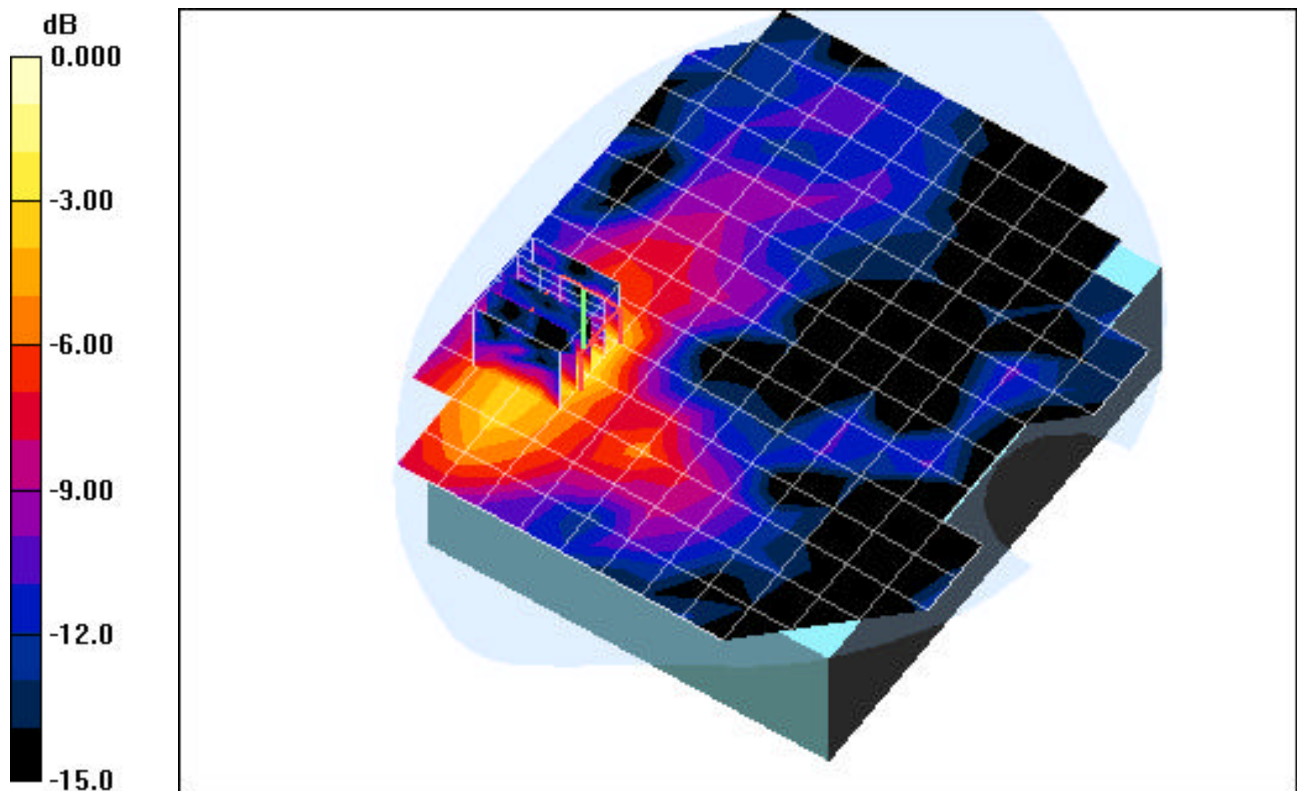

0 dB = 0.100mW/g

PCTEST ENGINEERING LABORATORY, INC.

DUT: CF-U1; Type: Tablet PC with 802.11abgn, Bluetooth and EVDO; Serial: DVT1-43

Communication System: IEEE 802.11n; Frequency: 2452 MHz; Duty Cycle: 1:1

Medium: 2450 Muscle ($\sigma = 1.90$ mho/m, $\epsilon_r = 50.38$, $\rho = 1000$ kg/m³)

Phantom section: Flat Section; Space: 0.0 cm

Test Date: 04-17-2008; Ambient Temp: 23.3°C; Tissue Temp: 21.5°C

Probe: EX3DV4 - SN3561; ConvF(6.15, 6.15, 6.15); Calibrated: 8/30/2007

Sensor-Surface: 3mm (Mechanical Surface Detection)

Electronics: DAE4 Sn649; Calibrated: 1/30/2008

Phantom: SAM Main; Type: SAM 4.0; Serial: TP-1114

Measurement SW: DASY4, V4.7 Build 53; Postprocessing SW: SEMCAD, V1.8 Build 172

Mode: 802.11n, Tablet position, Bottom side, 13.5Mbps, High.ch

Area Scan (7x15x1): Measurement grid: dx=15mm, dy=15mm

Zoom Scan (5x5x7)/Cube 0: Measurement grid: dx=8mm, dy=8mm, dz=5mm

Reference Value = 2.69 V/m

Peak SAR (extrapolated) = 0.018 W/kg

SAR(1 g) = 0.011 mW/g; SAR(10 g) = 0.00795 mW/g

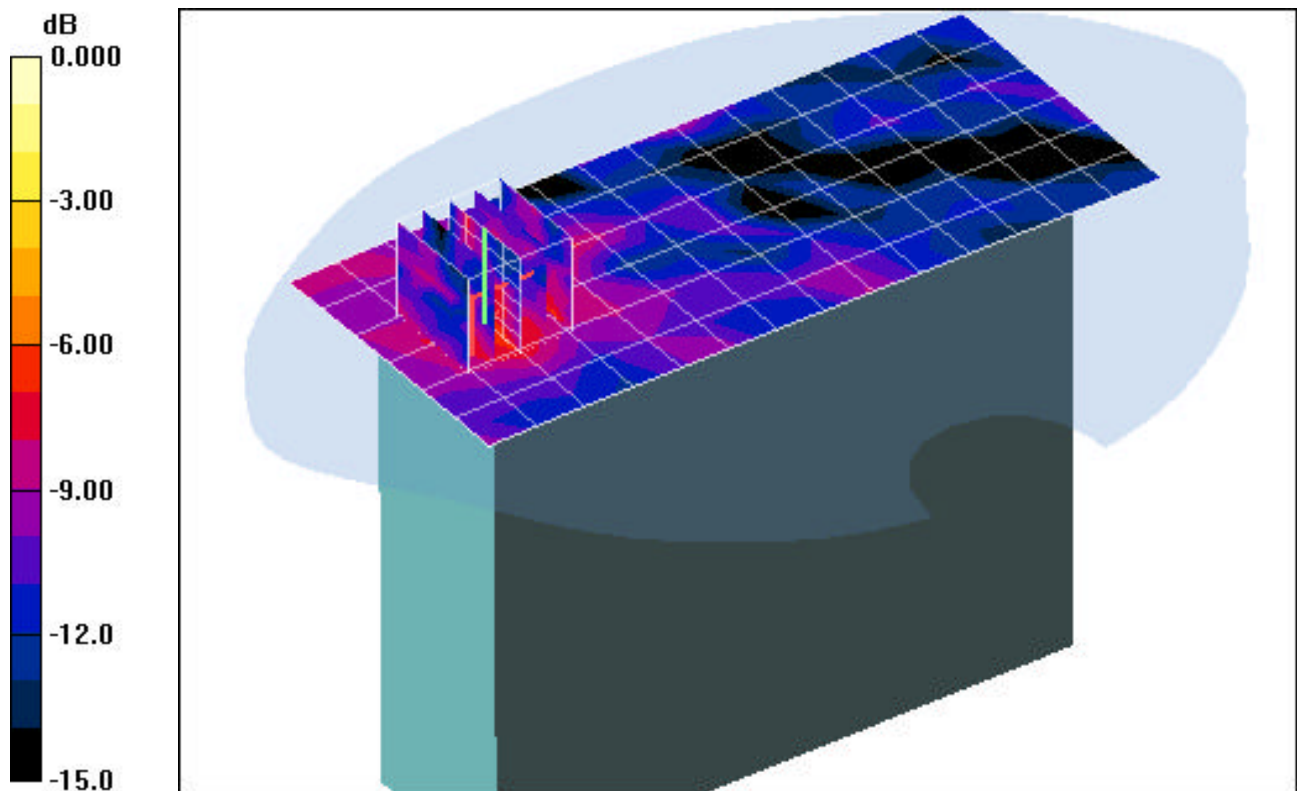

0 dB = 0.050mW/g

PCTEST ENGINEERING LABORATORY, INC.

DUT: CF-U1; Type: Tablet PC with 802.11abgn, Bluetooth and EVDO; Serial: DVT1-43

Communication System: IEEE 802.11a 5.2GHz Band; Frequency: 5200 MHz; Duty Cycle: 1:1

Medium: 5300 Muscle ($\sigma = 5.32$ mho/m, $\epsilon_r = 47.59$, $\rho = 1000$ kg/m³)

Phantom section: Flat Section; Space: 0.0 cm

Test Date: 04-18-2008; Ambient Temp: 22.7°C; Tissue Temp: 21.8°C

Probe: EX3DV4 - SN3561; ConvF(3.83, 3.83, 3.83); Calibrated: 8/30/2007

Sensor-Surface: 3mm (Mechanical Surface Detection)

Electronics: DAE4 Sn649; Calibrated: 1/30/2008

Phantom: SAM Main; Type: SAM 4.0; Serial: TP-1114

Measurement SW: DASY4, V4.7 Build 53; Postprocessing SW: SEMCAD, V1.8 Build 172

Mode: 802.11a, Laptop position, 6Mbps, Low.ch

Area Scan (18x21x1): Measurement grid: dx=10mm, dy=10mm

Zoom Scan (8x8x8)/Cube 0: Measurement grid: dx=4.3mm, dy=4.3mm, dz=3mm

Reference Value = 5.54 V/m

Peak SAR (extrapolated) = 0.815 W/kg

SAR(1 g) = 0.142 mW/g; SAR(10 g) = 0.057 mW/g

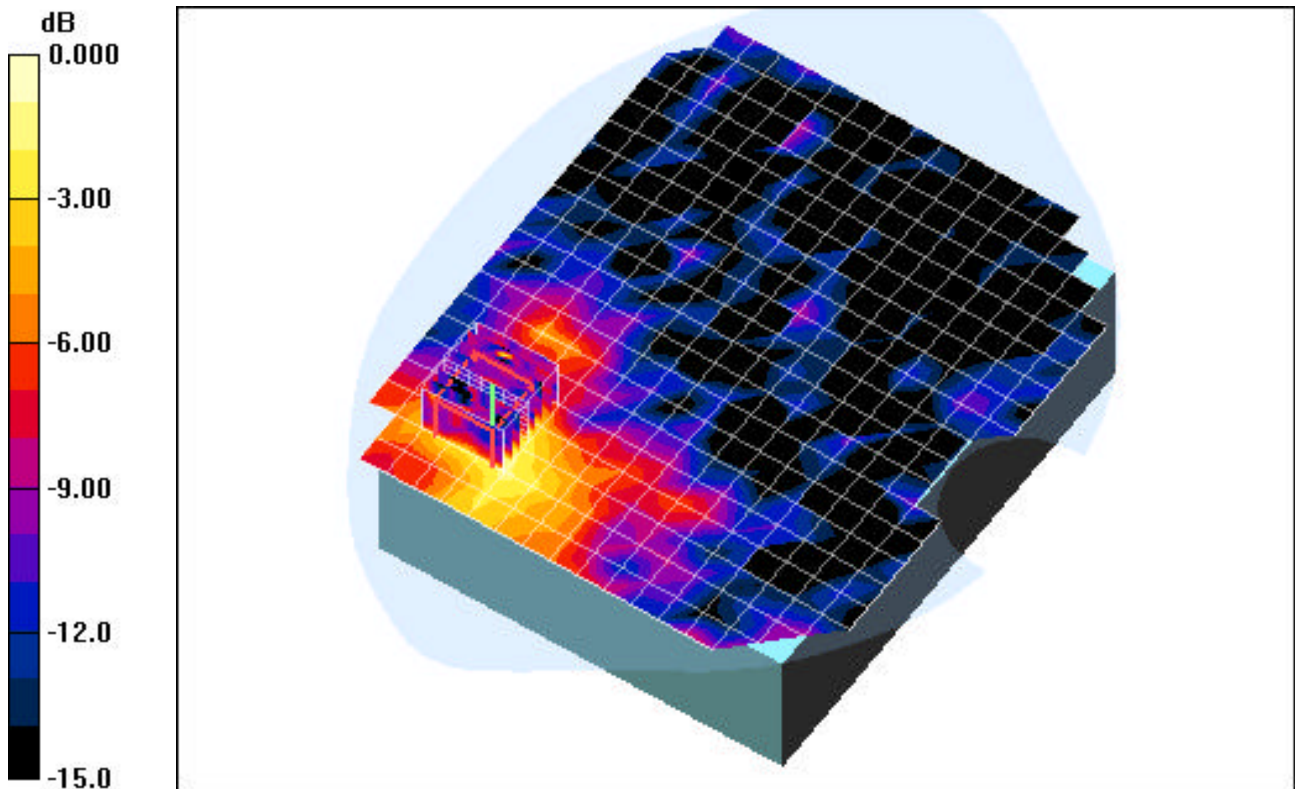

0 dB = 0.200mW/g

PCTEST ENGINEERING LABORATORY, INC.

DUT: CF-U1; Type: Tablet PC with 802.11abgn, Bluetooth and EVDO; Serial: DVT1-43

Communication System: IEEE 802.11a 5.2GHz Band; Frequency: 5200 MHz; Duty Cycle: 1:1

Medium: 5300 Muscle ($\sigma = 5.32$ mho/m, $\epsilon_r = 47.59$, $\rho = 1000$ kg/m³)

Phantom section: Flat Section; Space: 0.0 cm

Test Date: 04-18-2008; Ambient Temp: 22.7°C; Tissue Temp: 21.8°C

Probe: EX3DV4 - SN3561; ConvF(3.83, 3.83, 3.83); Calibrated: 8/30/2007

Sensor-Surface: 3mm (Mechanical Surface Detection)

Electronics: DAE4 Sn649; Calibrated: 1/30/2008

Phantom: SAM Main; Type: SAM 4.0; Serial: TP-1114

Measurement SW: DASY4, V4.7 Build 53; Postprocessing SW: SEMCAD, V1.8 Build 172

Mode: 802.11a, Tablet position, Bottom side, 6Mbps, Low.ch

Area Scan (8x21x1): Measurement grid: dx=10mm, dy=10mm

Zoom Scan (8x8x8)/Cube 0: Measurement grid: dx=4.3mm, dy=4.3mm, dz=3mm

Reference Value = 1.60 V/m

Peak SAR (extrapolated) = 0.056 W/kg

SAR(1 g) = 0.022 mW/g; SAR(10 g) = 0.016 mW/g

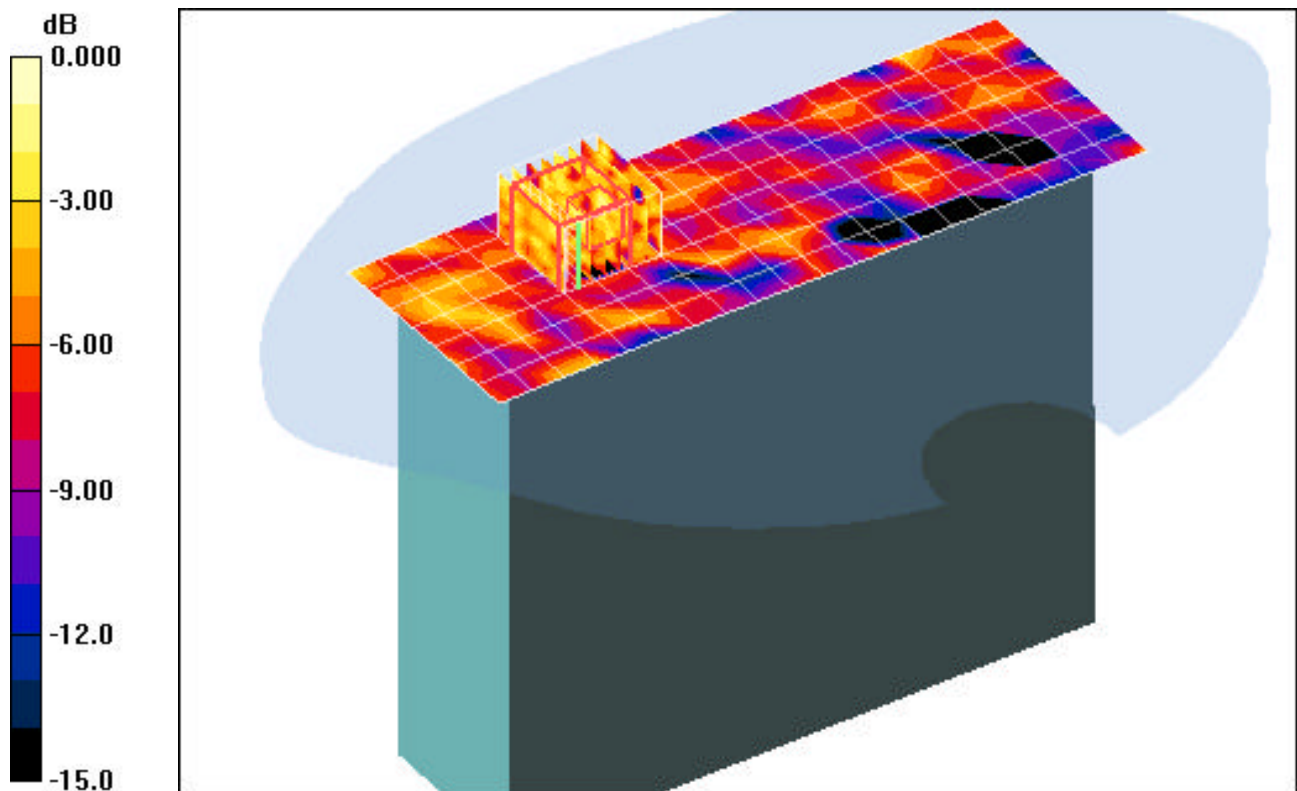

0 dB = 0.050mW/g

PCTEST ENGINEERING LABORATORY, INC.

DUT: CF-U1; Type: Tablet PC with 802.11abgn, Bluetooth and EVDO; Serial: DVT1-43

Communication System: IEEE 802.11n; Frequency: 5190 MHz; Duty Cycle: 1:1

Medium: 5300 Muscle ($\sigma = 5.32$ mho/m, $\epsilon_r = 47.59$, $\rho = 1000$ kg/m³)

Phantom section: Flat Section; Space: 0.0 cm

Test Date: 04-19-2008; Ambient Temp: 23.2°C; Tissue Temp: 21.8°C

Probe: EX3DV4 - SN3561; ConvF(3.83, 3.83, 3.83); Calibrated: 8/30/2007

Sensor-Surface: 3mm (Mechanical Surface Detection)

Electronics: DAE4 Sn649; Calibrated: 1/30/2008

Phantom: SAM Main; Type: SAM 4.0; Serial: TP-1114

Measurement SW: DASY4, V4.7 Build 53; Postprocessing SW: SEMCAD, V1.8 Build 172

Mode: 802.11n, Laptop position, 13.5Mbps, Low.ch

Area Scan (18x21x1): Measurement grid: dx=10mm, dy=10mm

Zoom Scan (8x8x8)/Cube 0: Measurement grid: dx=4.3mm, dy=4.3mm, dz=3mm

Reference Value = 5.19 V/m

Peak SAR (extrapolated) = 0.285 W/kg

SAR(1 g) = 0.102 mW/g; SAR(10 g) = 0.052 mW/g

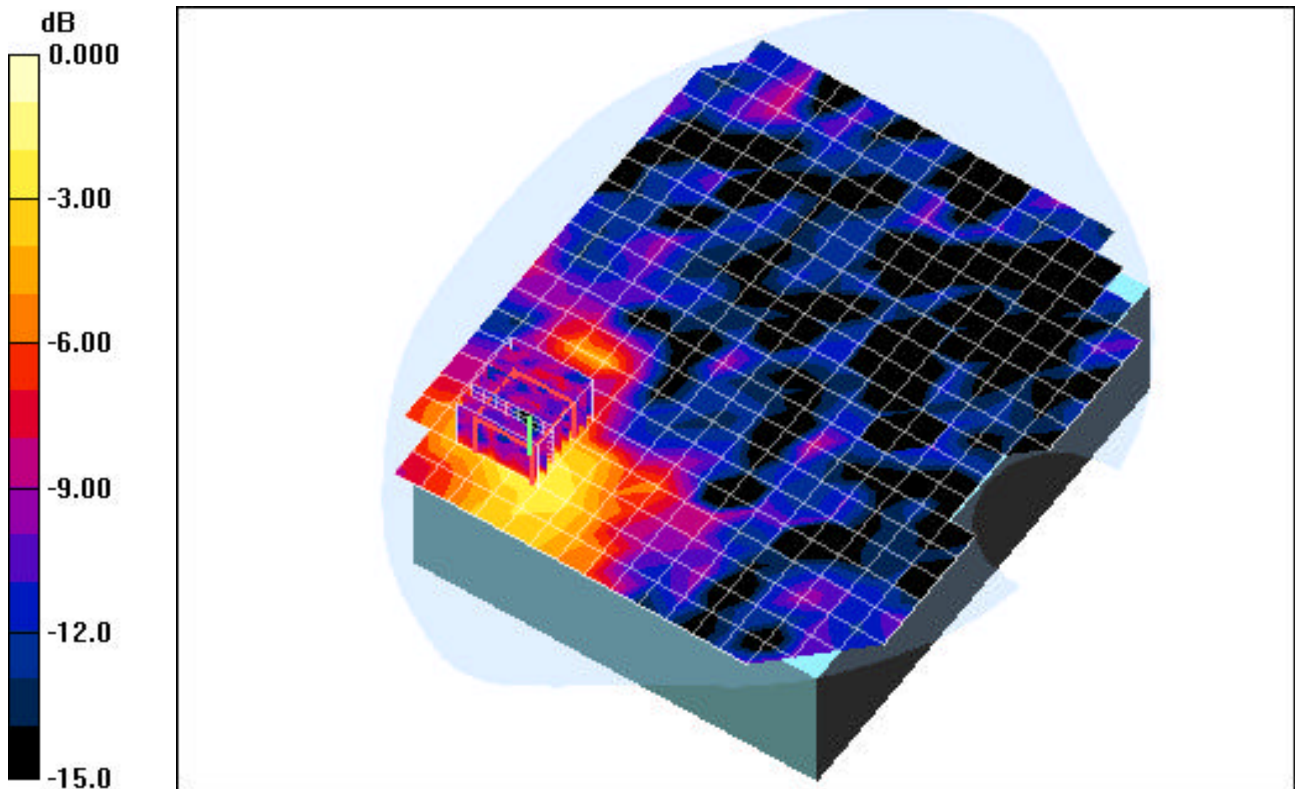

0 dB = 0.200mW/g

PCTEST ENGINEERING LABORATORY, INC.

DUT: CF-U1; Type: Tablet PC with 802.11abgn, Bluetooth and EVDO; Serial: DVT1-43

Communication System: IEEE 802.11n; Frequency: 5230 MHz; Duty Cycle: 1:1
Medium: 5300 Muscle ($\sigma = 5.32$ mho/m, $\epsilon_r = 47.59$, $\rho = 1000$ kg/m³)
Phantom section: Flat Section; Space: 0.0 cm

Test Date: 04-19-2008; Ambient Temp: 23.2°C; Tissue Temp: 21.8°C

Probe: EX3DV4 - SN3561; ConvF(3.83, 3.83, 3.83); Calibrated: 8/30/2007
Sensor-Surface: 3mm (Mechanical Surface Detection)
Electronics: DAE4 Sn649; Calibrated: 1/30/2008
Phantom: SAM Main; Type: SAM 4.0; Serial: TP-1114
Measurement SW: DASY4, V4.7 Build 53; Postprocessing SW: SEMCAD, V1.8 Build 172

Mode: 802.11n, Tablet position, Bottom side, 13.5Mbps, High.ch

Area Scan (8x21x1): Measurement grid: dx=10mm, dy=10mm
Zoom Scan (8x8x8)/Cube 0: Measurement grid: dx=4.3mm, dy=4.3mm, dz=3mm
Reference Value = 1.32 V/m
Peak SAR (extrapolated) = 0.073 W/kg
SAR(1 g) = 0.023 mW/g; SAR(10 g) = 0.014 mW/g

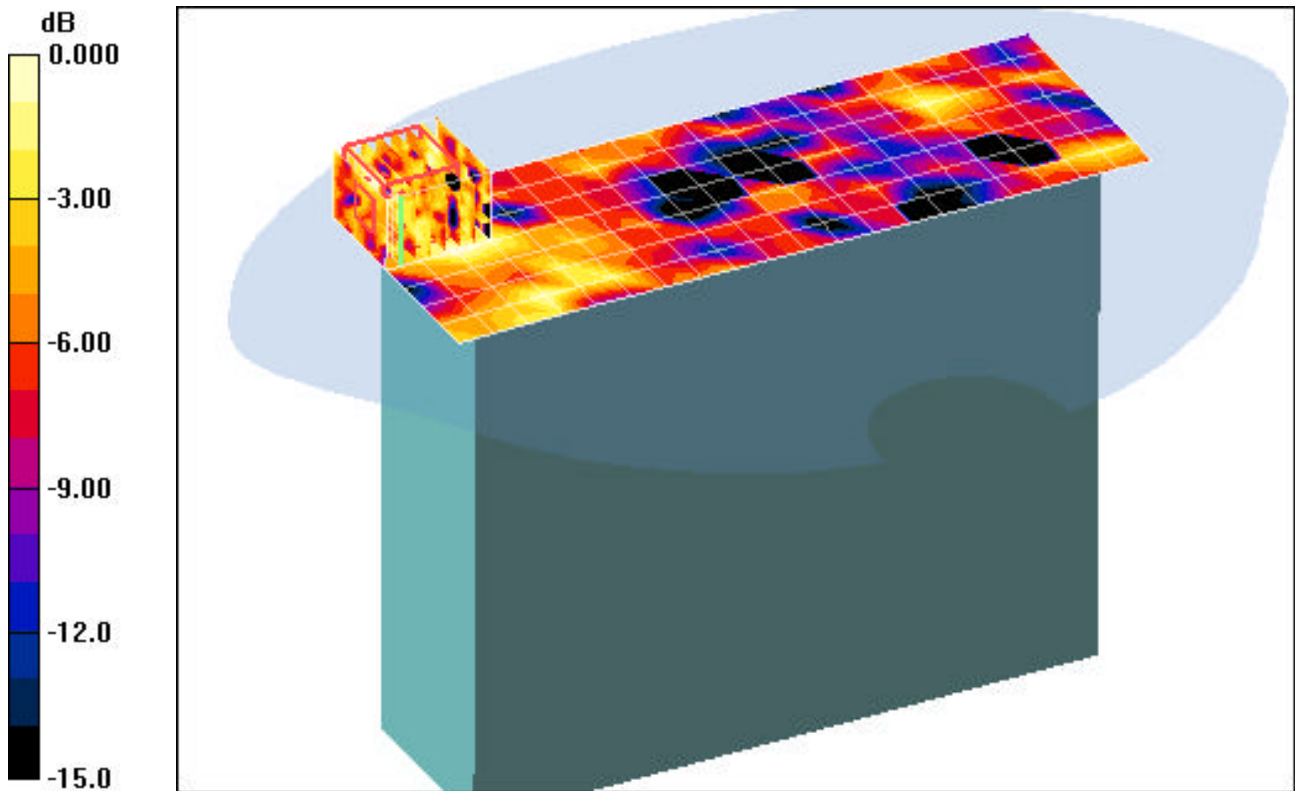

0 dB = 0.050mW/g

PCTEST ENGINEERING LABORATORY, INC.

DUT: CF-U1; Type: Tablet PC with 802.11abgn, Bluetooth and EVDO; Serial: DVT1-43

Communication System: IEEE 802.11a 5.3GHz Band; Frequency: 5280 MHz; Duty Cycle: 1:1

Medium: 5300 Muscle ($\sigma = 5.32$ mho/m, $\epsilon_r = 47.59$, $\rho = 1000$ kg/m³)

Phantom section: Flat Section; Space: 0.0 cm

Test Date: 04-18-2008; Ambient Temp: 22.7°C; Tissue Temp: 21.8°C

Probe: EX3DV4 - SN3561; ConvF(3.67, 3.67, 3.67); Calibrated: 8/30/2007

Sensor-Surface: 3mm (Mechanical Surface Detection)

Electronics: DAE4 Sn649; Calibrated: 1/30/2008

Phantom: SAM Main; Type: SAM 4.0; Serial: TP-1114

Measurement SW: DASY4, V4.7 Build 53; Postprocessing SW: SEMCAD, V1.8 Build 172

Mode: 802.11a, Laptop position, 6Mbps, Low.ch

Area Scan (18x21x1): Measurement grid: dx=10mm, dy=10mm

Zoom Scan (8x8x8)/Cube 0: Measurement grid: dx=4.3mm, dy=4.3mm, dz=3mm

Reference Value = 5.28 V/m

Peak SAR (extrapolated) = 0.361 W/kg

SAR(1 g) = 0.103 mW/g; SAR(10 g) = 0.055 mW/g

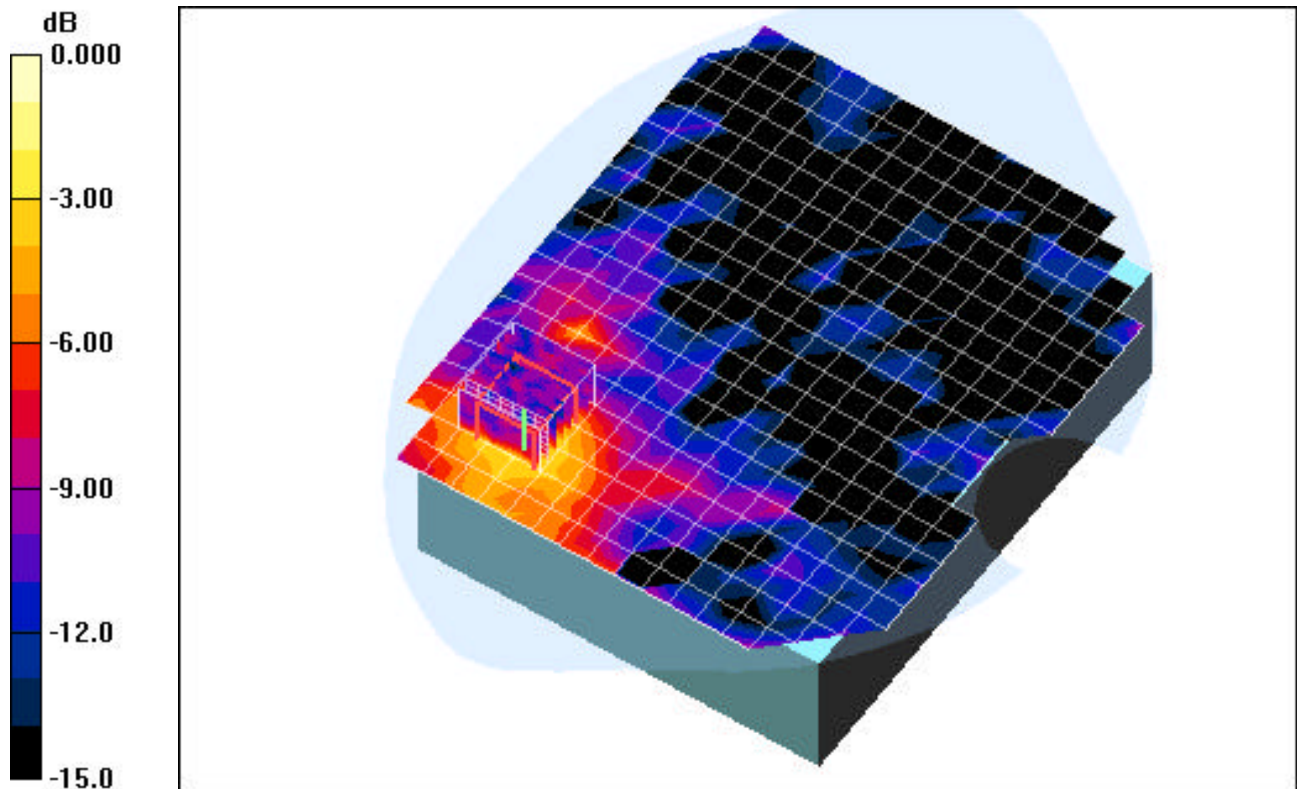

0 dB = 0.200mW/g

PCTEST ENGINEERING LABORATORY, INC.

DUT: CF-U1; Type: Tablet PC with 802.11abgn, Bluetooth and EVDO; Serial: DVT1-43

Communication System: IEEE 802.11a 5.3GHz Band; Frequency: 5280 MHz; Duty Cycle: 1:1

Medium: 5300 Muscle ($\sigma = 5.32$ mho/m, $\epsilon_r = 47.59$, $\rho = 1000$ kg/m³)

Phantom section: Flat Section; Space: 0.0 cm

Test Date: 04-19-2008; Ambient Temp: 23.2°C; Tissue Temp: 21.8°C

Probe: EX3DV4 - SN3561; ConvF(3.67, 3.67, 3.67); Calibrated: 8/30/2007

Sensor-Surface: 3mm (Mechanical Surface Detection)

Electronics: DAE4 Sn649; Calibrated: 1/30/2008

Phantom: SAM Main; Type: SAM 4.0; Serial: TP-1114

Measurement SW: DASY4, V4.7 Build 53; Postprocessing SW: SEMCAD, V1.8 Build 172

Mode: 802.11a, Tablet position, Bottom side, 6Mbps, Low.ch

Area Scan (8x21x1): Measurement grid: dx=10mm, dy=10mm

Zoom Scan (8x8x8)/Cube 0: Measurement grid: dx=4.3mm, dy=4.3mm, dz=3mm

Reference Value = 1.64 V/m

Peak SAR (extrapolated) = 0.145 W/kg

SAR(1 g) = 0.025 mW/g; SAR(10 g) = 0.017 mW/g

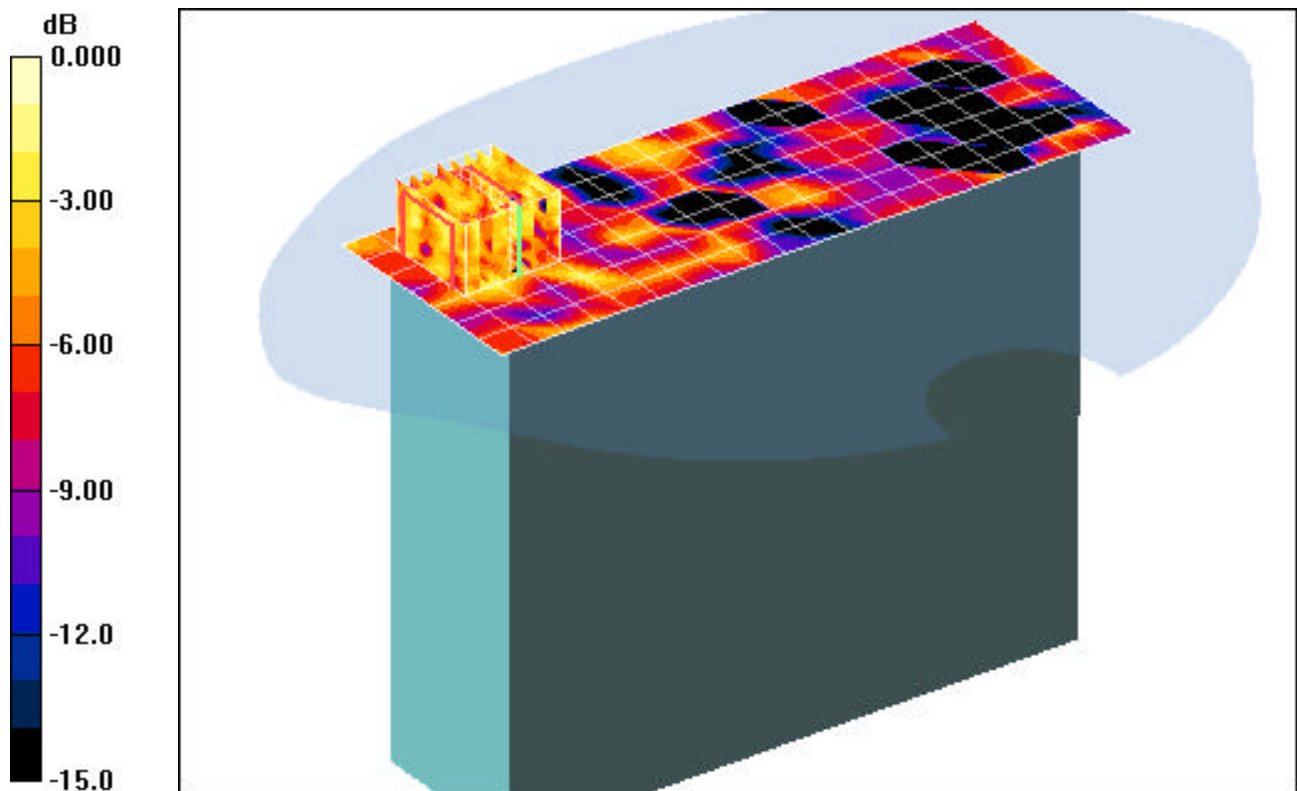

0 dB = 0.050mW/g

PCTEST ENGINEERING LABORATORY, INC.

DUT: CF-U1; Type: Tablet PC with 802.11abgn, Bluetooth and EVDO; Serial: DVT1-43

Communication System: IEEE 802.11n; Frequency: 5270 MHz; Duty Cycle: 1:1

Medium: 5300 Muscle ($\sigma = 5.32$ mho/m, $\epsilon_r = 47.59$, $\rho = 1000$ kg/m³)

Phantom section: Flat Section; Space: 0.0 cm

Test Date: 04-19-2008; Ambient Temp: 23.2°C; Tissue Temp: 21.8°C

Probe: EX3DV4 - SN3561; ConvF(3.67, 3.67, 3.67); Calibrated: 8/30/2007

Sensor-Surface: 3mm (Mechanical Surface Detection)

Electronics: DAE4 Sn649; Calibrated: 1/30/2008

Phantom: SAM Main; Type: SAM 4.0; Serial: TP-1114

Measurement SW: DASY4, V4.7 Build 53; Postprocessing SW: SEMCAD, V1.8 Build 172

Mode: 802.11n, Laptop position, 13.5Mbps, Low.ch

Area Scan (18x21x1): Measurement grid: dx=10mm, dy=10mm

Zoom Scan (8x8x8)/Cube 0: Measurement grid: dx=4.3mm, dy=4.3mm, dz=3mm

Reference Value = 4.55 V/m

Peak SAR (extrapolated) = 0.225 W/kg

SAR(1 g) = 0.077 mW/g; SAR(10 g) = 0.033 mW/g

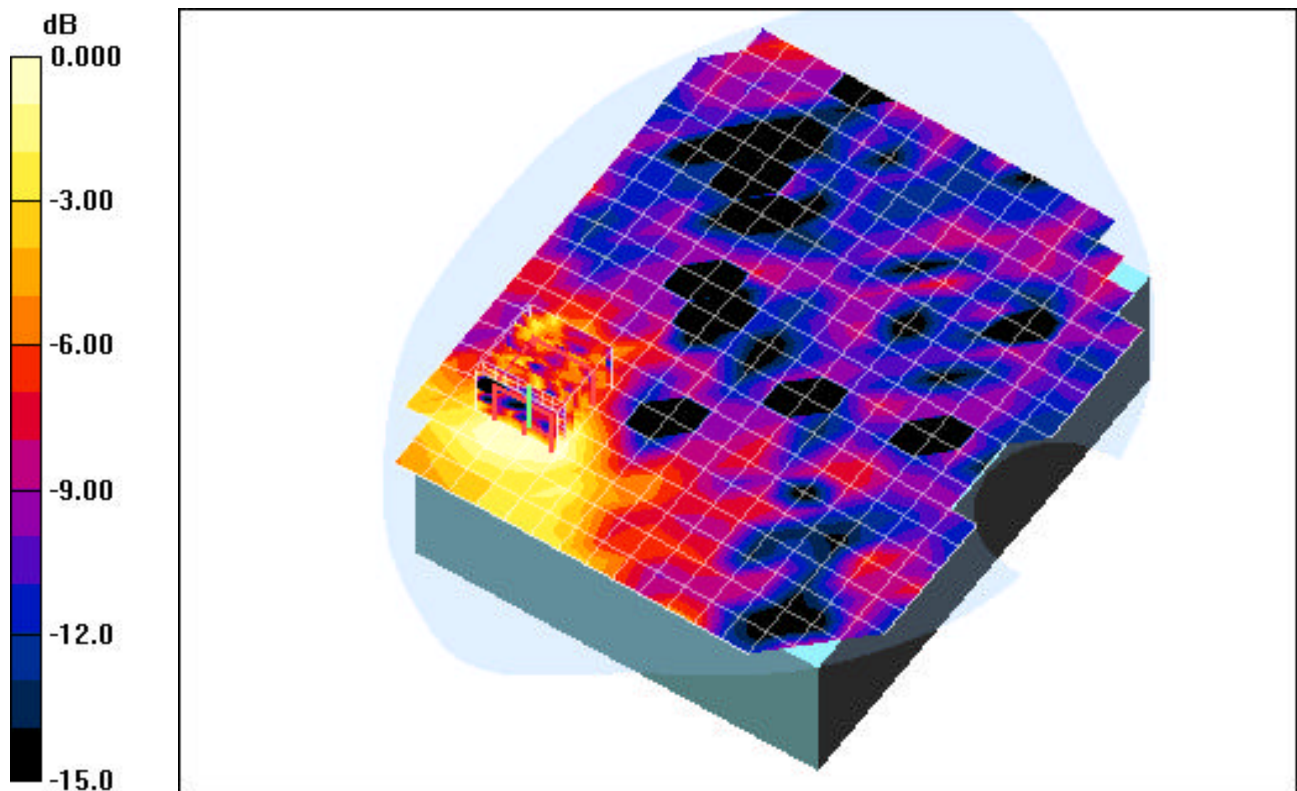

0 dB = 0.100mW/g

PCTEST ENGINEERING LABORATORY, INC.

DUT: CF-U1; Type: Tablet PC with 802.11abgn, Bluetooth and EVDO; Serial: DVT1-43

Communication System: IEEE 802.11n; Frequency: 5310 MHz; Duty Cycle: 1:1
Medium: 5300 Muscle ($\sigma = 5.32$ mho/m, $\epsilon_r = 47.59$, $\rho = 1000$ kg/m³)
Phantom section: Flat Section; Space: 0.0 cm

Test Date: 04-19-2008; Ambient Temp: 23.2°C; Tissue Temp: 21.8°C

Probe: EX3DV4 - SN3561; ConvF(3.67, 3.67, 3.67); Calibrated: 8/30/2007
Sensor-Surface: 3mm (Mechanical Surface Detection)
Electronics: DAE4 Sn649; Calibrated: 1/30/2008
Phantom: SAM Main; Type: SAM 4.0; Serial: TP-1114
Measurement SW: DASY4, V4.7 Build 53; Postprocessing SW: SEMCAD, V1.8 Build 172

Mode: 802.11n, Tablet position, Bottom side, 13.5Mbps, High.ch

Area Scan (8x21x1): Measurement grid: dx=10mm, dy=10mm
Zoom Scan (8x8x8)/Cube 0: Measurement grid: dx=4.3mm, dy=4.3mm, dz=3mm
Reference Value = 2.52 V/m
Peak SAR (extrapolated) = 0.242 W/kg
SAR(1 g) = 0.027 mW/g; SAR(10 g) = 0.017 mW/g

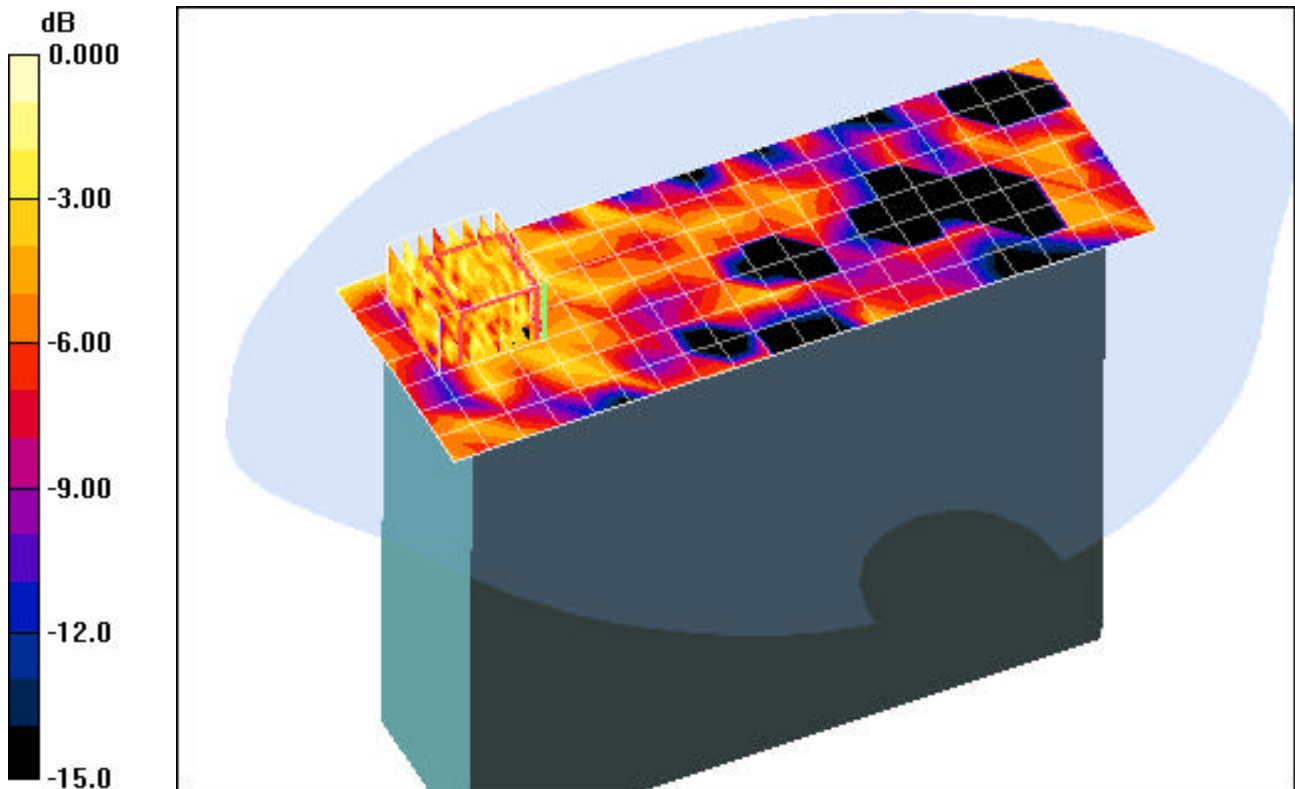

0 dB = 0.050mW/g

PCTEST ENGINEERING LABORATORY, INC.

DUT: CF-U1; Type: Tablet PC with 802.11abgn, Bluetooth and EVDO; Serial: DVT1-43

Communication System: IEEE 802.11a 5.8GHz Band; Frequency: 5745 MHz; Duty Cycle: 1:1

Medium: 5800 Muscle ($\sigma = 6.12$ mho/m, $\epsilon_r = 49.55$, $\rho = 1000$ kg/m³)

Phantom section: Flat Section; Space: 0.0 cm

Test Date: 04-19-2008; Ambient Temp: 22.9°C; Tissue Temp: 21.9°C

Probe: EX3DV4 - SN3561; ConvF(3.75, 3.75, 3.75); Calibrated: 8/30/2007

Sensor-Surface: 3mm (Mechanical Surface Detection)

Electronics: DAE4 Sn649; Calibrated: 1/30/2008

Phantom: SAM Main; Type: SAM 4.0; Serial: TP-1114

Measurement SW: DASY4, V4.7 Build 53; Postprocessing SW: SEMCAD, V1.8 Build 172

Mode: 802.11a, Laptop position, 6Mbps, Low.ch

Area Scan (18x21x1): Measurement grid: dx=10mm, dy=10mm

Zoom Scan (8x8x8)/Cube 0: Measurement grid: dx=4.3mm, dy=4.3mm, dz=3mm

Reference Value = 4.36 V/m

Peak SAR (extrapolated) = 0.240 W/kg

SAR(1 g) = 0.082 mW/g; SAR(10 g) = 0.046 mW/g

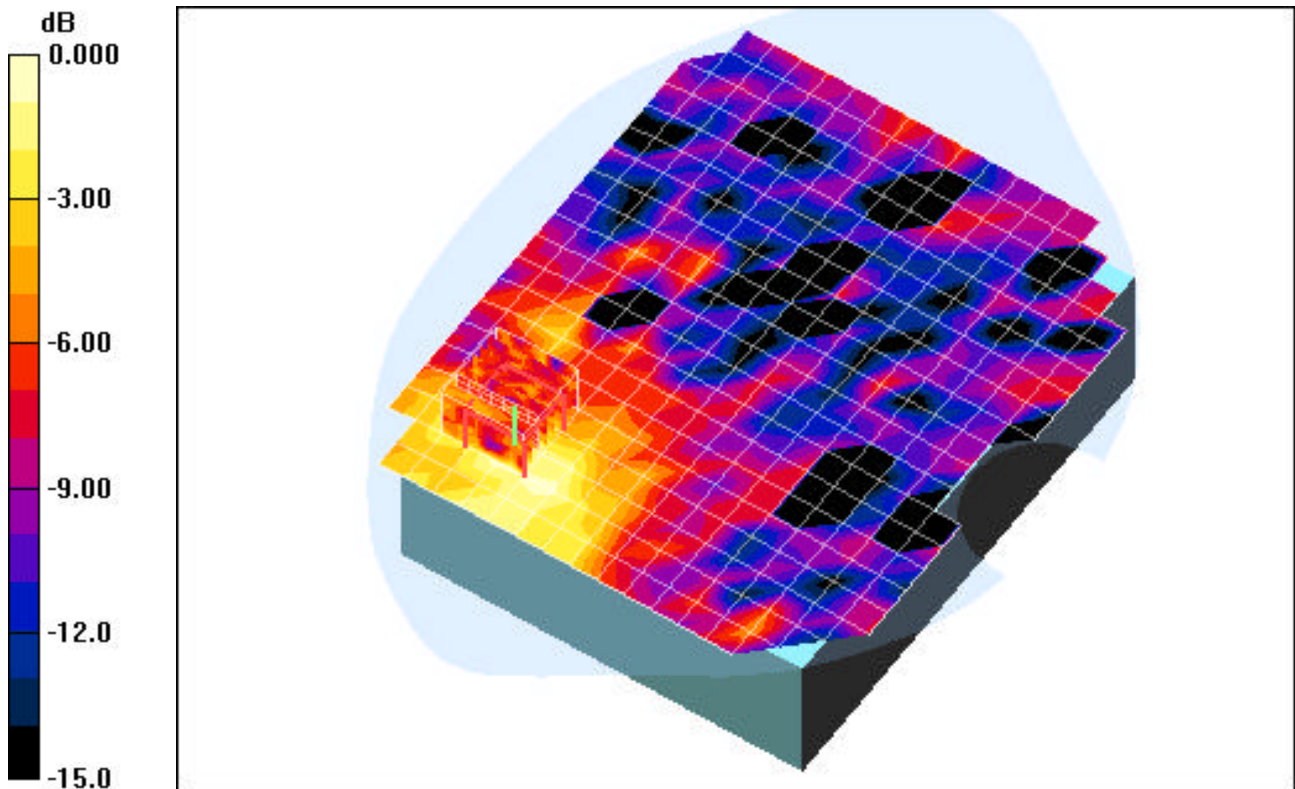

0 dB = 0.100mW/g

PCTEST ENGINEERING LABORATORY, INC.

DUT: CF-U1; Type: Tablet PC with 802.11abgn, Bluetooth and EVDO; Serial: DVT1-43

Communication System: IEEE 802.11a 5.8GHz Band; Frequency: 5785 MHz; Duty Cycle: 1:1

Medium: 5800 Muscle ($\sigma = 6.12$ mho/m, $\epsilon_r = 49.55$, $\rho = 1000$ kg/m³)

Phantom section: Flat Section; Space: 0.0 cm

Test Date: 04-19-2008; Ambient Temp: 22.9°C; Tissue Temp: 21.9°C

Probe: EX3DV4 - SN3561; ConvF(3.75, 3.75, 3.75); Calibrated: 8/30/2007

Sensor-Surface: 3mm (Mechanical Surface Detection)

Electronics: DAE4 Sn649; Calibrated: 1/30/2008

Phantom: SAM Main; Type: SAM 4.0; Serial: TP-1114

Measurement SW: DASY4, V4.7 Build 53; Postprocessing SW: SEMCAD, V1.8 Build 172

Mode: 802.11a, Tablet position, Bottom side, 6Mbps, Mid.ch

Area Scan (8x21x1): Measurement grid: dx=10mm, dy=10mm

Zoom Scan (8x8x8)/Cube 0: Measurement grid: dx=4.3mm, dy=4.3mm, dz=3mm

Reference Value = 2.27 V/mB

Peak SAR (extrapolated) = 0.128 W/kg

SAR(1 g) = 0.026 mW/g; SAR(10 g) = 0.012 mW/g

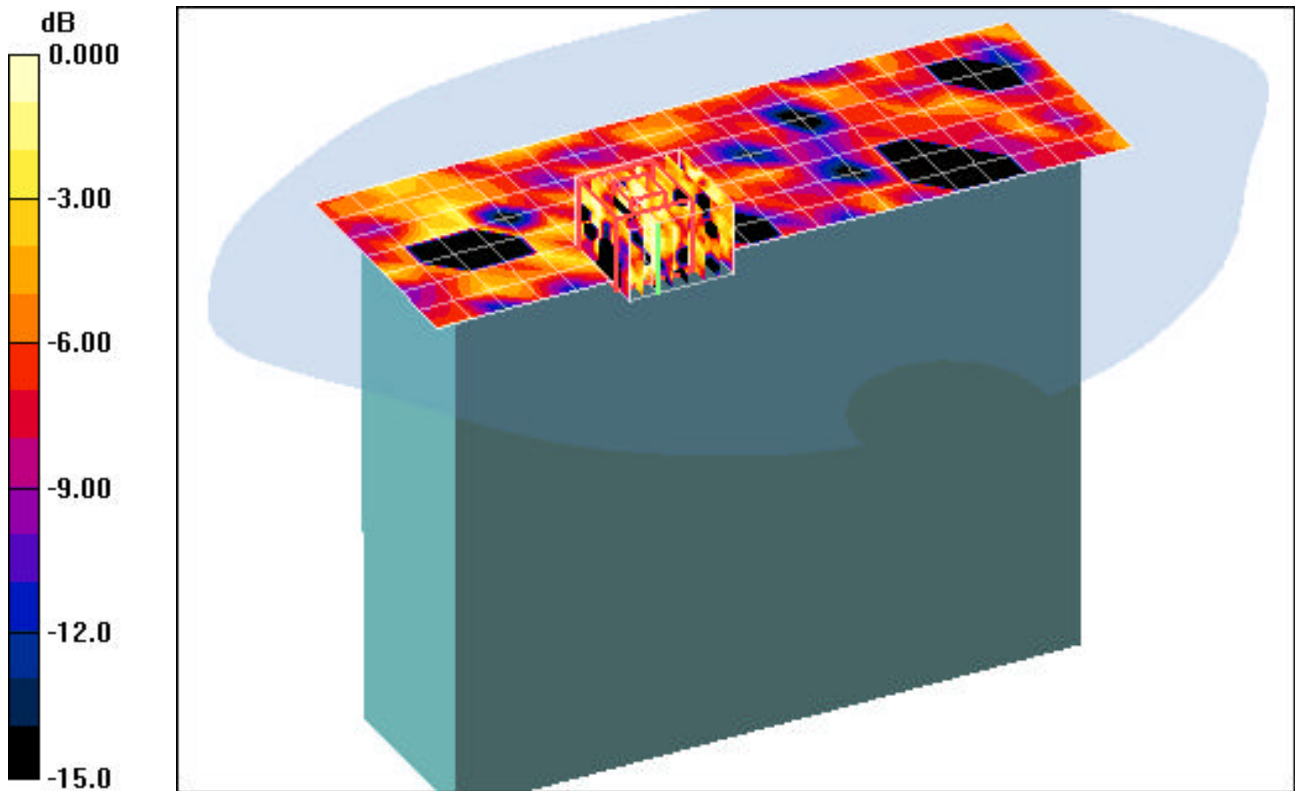

0 dB = 0.050mW/g

PCTEST ENGINEERING LABORATORY, INC.

DUT: CF-U1; Type: Tablet PC with 802.11abgn, Bluetooth and EVDO; Serial: DVT1-43

Communication System: IEEE 802.11n; Frequency: 5755 MHz; Duty Cycle: 1:1

Medium: 5800 Muscle ($\sigma = 6.12$ mho/m, $\epsilon_r = 49.55$, $\rho = 1000$ kg/m³)

Phantom section: Flat Section; Space: 0.0 cm

Test Date: 04-19-2008; Ambient Temp: 22.9°C; Tissue Temp: 21.9°C

Probe: EX3DV4 - SN3561; ConvF(3.75, 3.75, 3.75); Calibrated: 8/30/2007

Sensor-Surface: 3mm (Mechanical Surface Detection)

Electronics: DAE4 Sn649; Calibrated: 1/30/2008

Phantom: SAM Main; Type: SAM 4.0; Serial: TP-1114

Measurement SW: DASY4, V4.7 Build 53; Postprocessing SW: SEMCAD, V1.8 Build 172

Mode: 802.11n, Laptop position, 13.5Mbps, Low.ch

Area Scan (18x21x1): Measurement grid: dx=10mm, dy=10mm

Zoom Scan (8x8x8)/Cube 0: Measurement grid: dx=4.3mm, dy=4.3mm, dz=3mm

Reference Value = 4.15 V/m

Peak SAR (extrapolated) = 0.302 W/kg

SAR(1 g) = 0.075 mW/g; SAR(10 g) = 0.039 mW/g

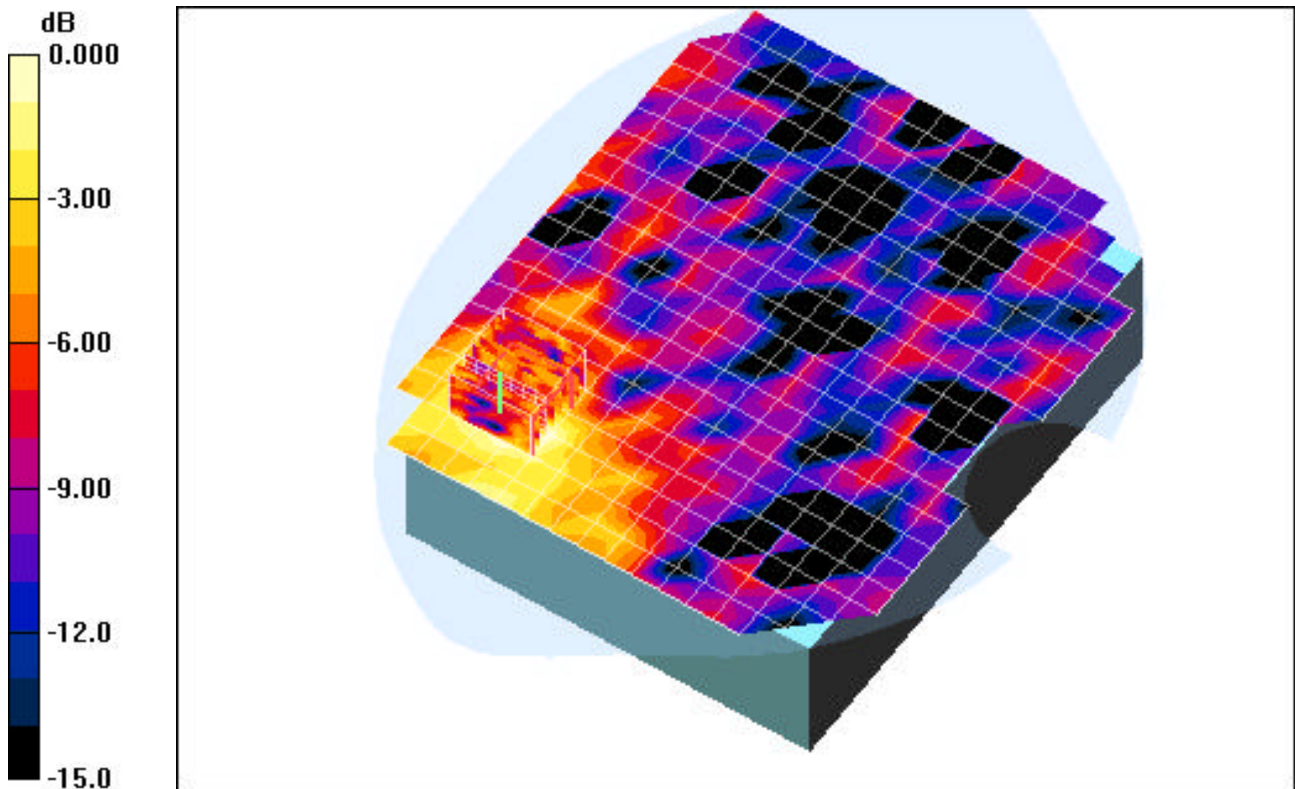

0 dB = 0.100mW/g

PCTEST ENGINEERING LABORATORY, INC.

DUT: CF-U1; Type: Tablet PC with 802.11abgn, Bluetooth and EVDO; Serial: DVT1-43

Communication System: IEEE 802.11n; Frequency: 5795 MHz; Duty Cycle: 1:1

Medium: 5800 Muscle ($\sigma = 6.12$ mho/m, $\epsilon_r = 49.55$, $\rho = 1000$ kg/m³)

Phantom section: Flat Section; Space: 0.0 cm

Test Date: 04-19-2008; Ambient Temp: 22.9°C; Tissue Temp: 21.9°C

Probe: EX3DV4 - SN3561; ConvF(3.75, 3.75, 3.75); Calibrated: 8/30/2007

Sensor-Surface: 3mm (Mechanical Surface Detection)

Electronics: DAE4 Sn649; Calibrated: 1/30/2008

Phantom: SAM Main; Type: SAM 4.0; Serial: TP-1114

Measurement SW: DASY4, V4.7 Build 53; Postprocessing SW: SEMCAD, V1.8 Build 172

Mode: 802.11n, Tablet position, Bottom side, 13.5Mbps, High.ch

Area Scan (8x21x1): Measurement grid: dx=10mm, dy=10mm

Zoom Scan (8x8x8)/Cube 0: Measurement grid: dx=4.3mm, dy=4.3mm, dz=3mm

Reference Value = 1.09 V/m

Peak SAR (extrapolated) = 0.094 W/kg

SAR(1 g) = 0.026 mW/g; SAR(10 g) = 0.011 mW/g

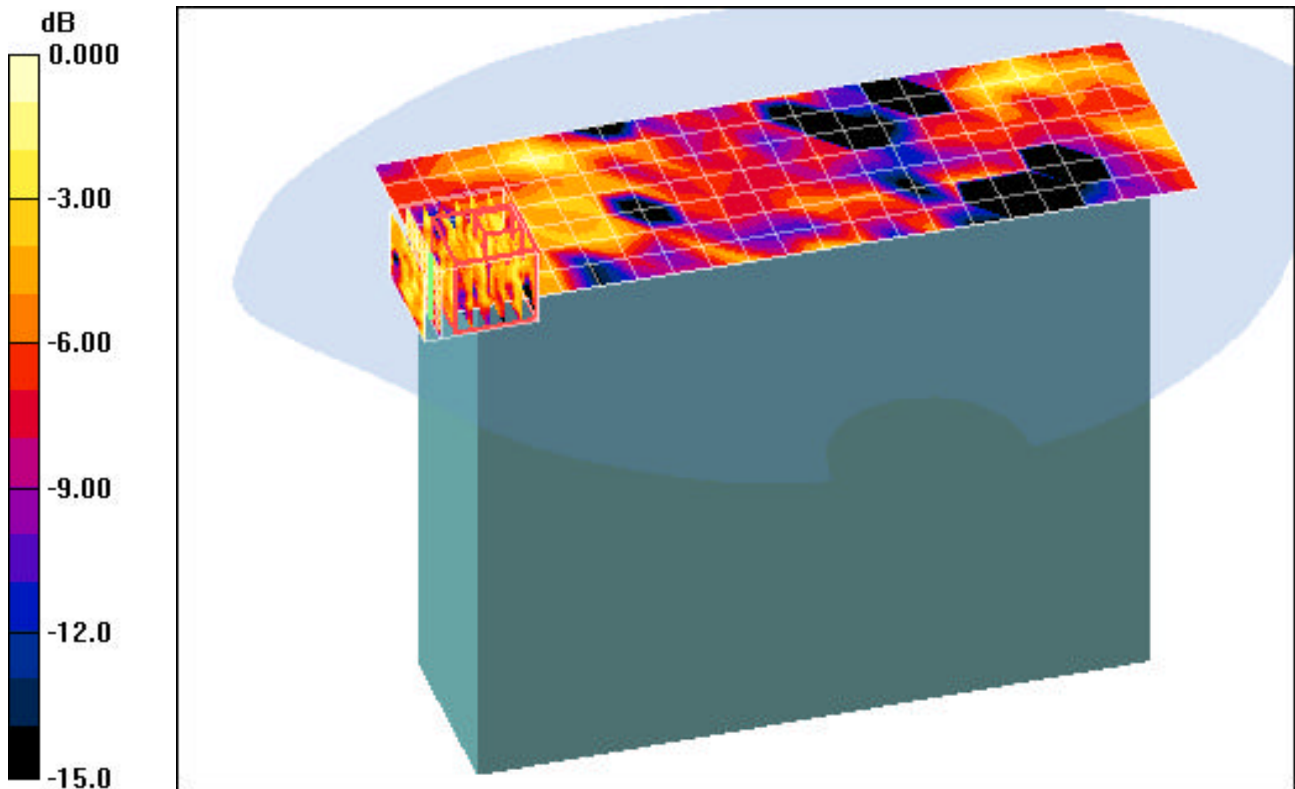

0 dB = 0.050mW/g

PCTEST ENGINEERING LABORATORY, INC.

DUT: CF-U1; Type: Tablet PC with 802.11abgn, Bluetooth and EVDO; Serial: DVT1-43

Communication System: Cellular CDMA; Frequency: 836.52 MHz; Duty Cycle: 1:1
Medium: 835 Muscle ($\sigma = 0.93$ mho/m, $\epsilon_r = 53.99$, $\rho = 1000$ kg/m³)
Phantom section: Flat Section; Space: 0.0 cm

Test Date: 04-16-2008; Ambient Temp: 23.5°C; Tissue Temp: 21.9°C

Probe: EX3DV4 - SN3561; ConvF(8.27, 8.27, 8.27); Calibrated: 8/30/2007
Sensor-Surface: 3mm (Mechanical Surface Detection)
Electronics: DAE4 Sn649; Calibrated: 1/30/2008
Phantom: SAM Main; Type: SAM 4.0; Serial: TP-1114
Measurement SW: DASY4, V4.7 Build 53; Postprocessing SW: SEMCAD, V1.8 Build 172

Mode: Cellular EVDO Rev.0, Laptop position, Mid.ch

Area Scan (13x15x1): Measurement grid: dx=15mm, dy=15mm
Zoom Scan (5x5x7)/Cube 0: Measurement grid: dx=8mm, dy=8mm, dz=5mm
Reference Value = 13.7 V/m
Peak SAR (extrapolated) = 0.218 W/kg
SAR(1 g) = 0.160 mW/g; SAR(10 g) = 0.114 mW/g

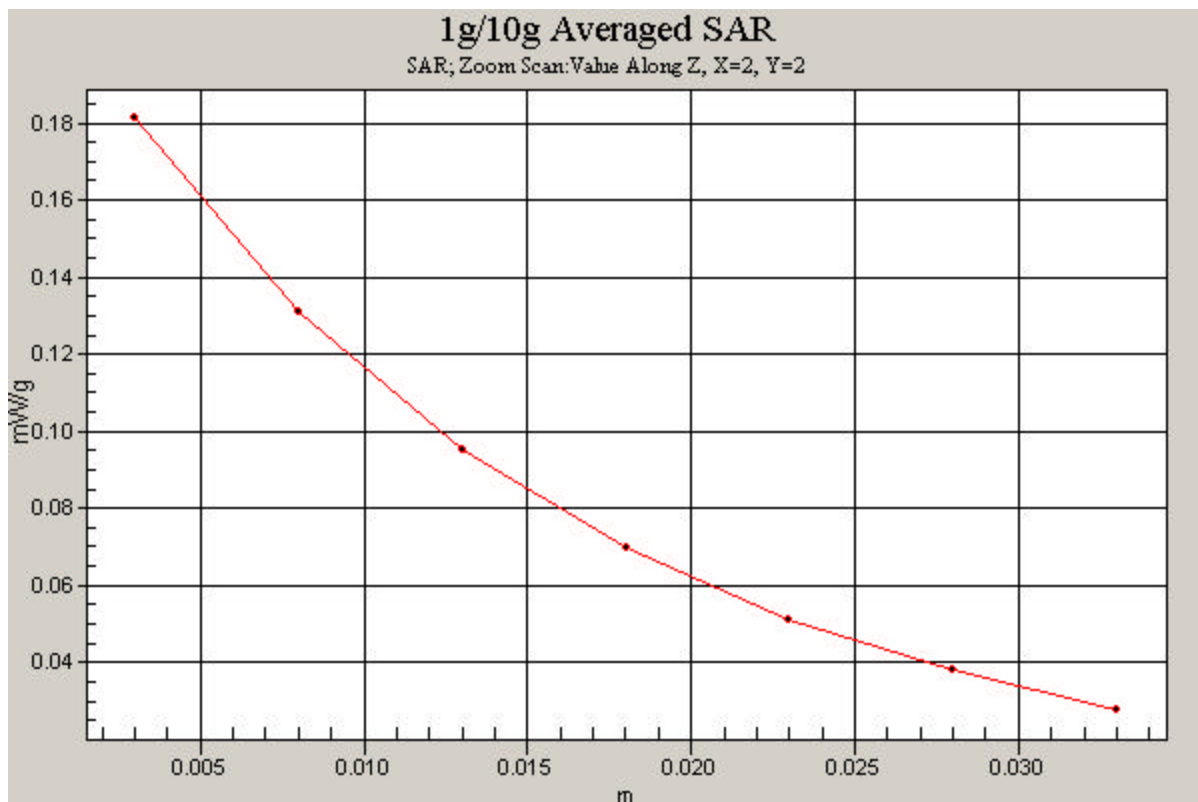

PCTEST ENGINEERING LABORATORY, INC.

DUT: CF-U1; Type: Tablet PC with 802.11abgn, Bluetooth and EVDO; Serial: DVT1-43

Communication System: PCS CDMA; Frequency: 1880 MHz; Duty Cycle: 1:1

Medium: 1900 Muscle ($\sigma = 1.59$ mho/m, $\epsilon_r = 54.87$, $\rho = 1000$ kg/m³)

Phantom section: Flat Section; Space: 0.0 cm

Test Date: 04-16-2008; Ambient Temp: 22.8°C; Tissue Temp: 21.4°C

Probe: EX3DV4 - SN3561; ConvF(6.6, 6.6, 6.6); Calibrated: 8/30/2007

Sensor-Surface: 3mm (Mechanical Surface Detection)

Electronics: DAE4 Sn649; Calibrated: 1/30/2008

Phantom: SAM Sub; Type: SAM 4.0; Serial: TP-1357

Measurement SW: DASY4, V4.7 Build 53; Postprocessing SW: SEMCAD, V1.8 Build 172

Mode: PCS EVDO Rev.0, Laptop position, Mid.ch

Area Scan (13x15x1): Measurement grid: dx=15mm, dy=15mm

Zoom Scan (5x5x7)/Cube 0: Measurement grid: dx=8mm, dy=8mm, dz=5mm

Reference Value = 7.51 V/m

Peak SAR (extrapolated) = 0.134 W/kg

SAR(1 g) = 0.076 mW/g; SAR(10 g) = 0.044 mW/g

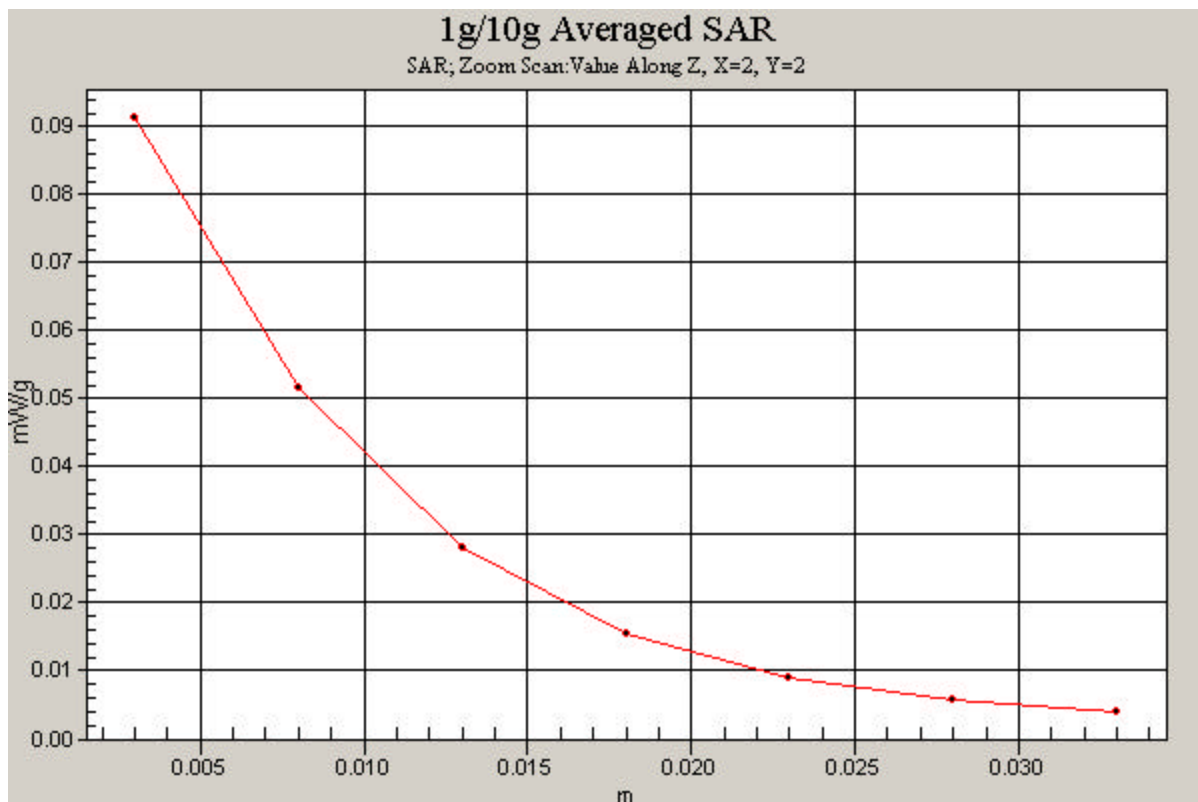

PCTEST ENGINEERING LABORATORY, INC.

DUT: CF-U1; Type: Tablet PC with 802.11abgn, Bluetooth and EVDO; Serial: DVT1-43

Communication System: IEEE 802.11n; Frequency: 2437 MHz; Duty Cycle: 1:1
Medium: 2450 Muscle ($\sigma = 1.90$ mho/m, $\epsilon_r = 50.38$, $\rho = 1000$ kg/m³)
Phantom section: Flat Section; Space: 0.0 cm

Test Date: 04-17-2008; Ambient Temp: 23.3°C; Tissue Temp: 21.5°C

Probe: EX3DV4 - SN3561; ConvF(6.15, 6.15, 6.15); Calibrated: 8/30/2007
Sensor-Surface: 3mm (Mechanical Surface Detection)
Electronics: DAE4 Sn649; Calibrated: 1/30/2008
Phantom: SAM Main; Type: SAM 4.0; Serial: TP-1114
Measurement SW: DASY4, V4.7 Build 53; Postprocessing SW: SEMCAD, V1.8 Build 172

Mode: 802.11n, Laptop position, 13.5Mbps, Mid.ch

Area Scan (13x15x1): Measurement grid: dx=15mm, dy=15mm
Zoom Scan (5x5x7)/Cube 0: Measurement grid: dx=8mm, dy=8mm, dz=5mm
Reference Value = 5.30 V/m
Peak SAR (extrapolated) = 0.096 W/kg
SAR(1 g) = 0.052 mW/g; SAR(10 g) = 0.028 mW/g

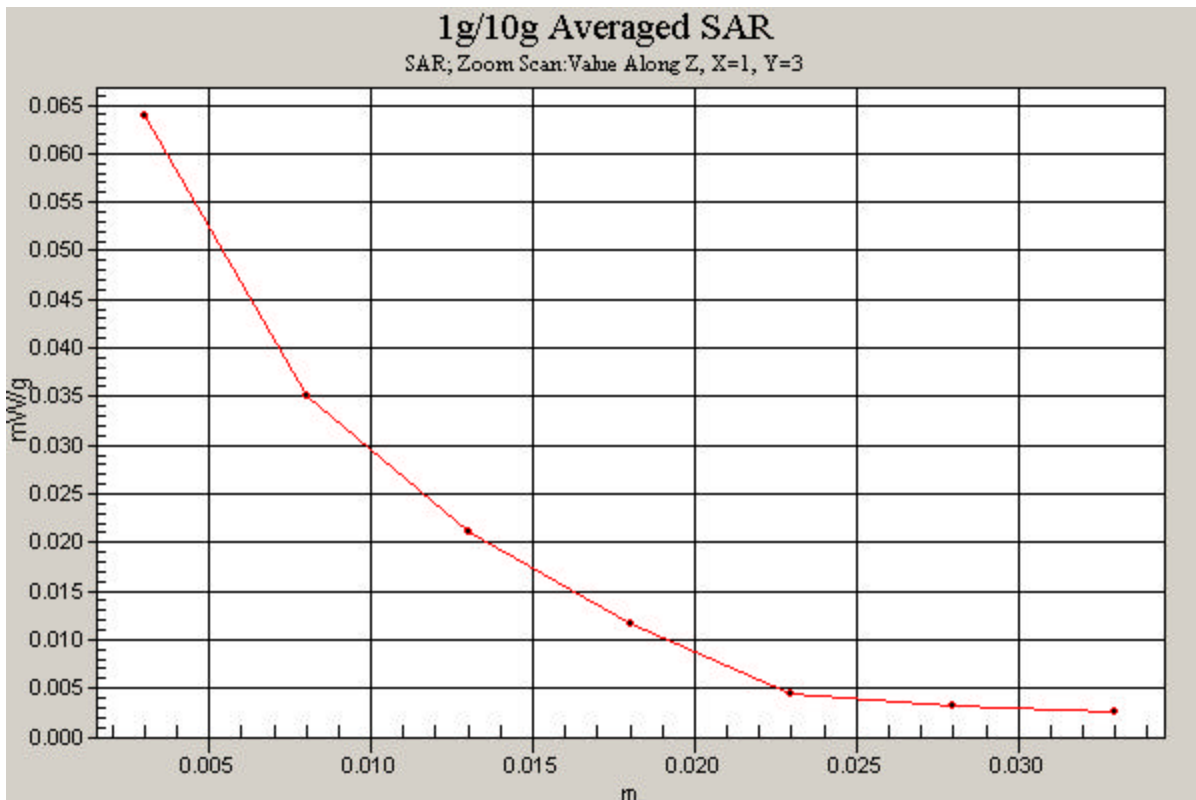

PCTEST ENGINEERING LABORATORY, INC.

DUT: CF-U1; Type: Tablet PC with 802.11abgn, Bluetooth and EVDO; Serial: DVT1-43

Communication System: IEEE 802.11a 5.2GHz Band; Frequency: 5200 MHz; Duty Cycle: 1:1
Medium: 5300 Muscle ($\sigma = 5.32$ mho/m, $\epsilon_r = 47.59$, $\rho = 1000$ kg/m³)
Phantom section: Flat Section; Space: 0.0 cm

Test Date: 04-18-2008; Ambient Temp: 22.7°C; Tissue Temp: 21.8°C

Probe: EX3DV4 - SN3561; ConvF(3.83, 3.83, 3.83); Calibrated: 8/30/2007
Sensor-Surface: 3mm (Mechanical Surface Detection)
Electronics: DAE4 Sn649; Calibrated: 1/30/2008
Phantom: SAM Main; Type: SAM 4.0; Serial: TP-1114
Measurement SW: DASY4, V4.7 Build 53; Postprocessing SW: SEMCAD, V1.8 Build 172

Mode: 802.11a, Laptop position, 6Mbps, Low.ch

Area Scan (18x21x1): Measurement grid: dx=10mm, dy=10mm
Zoom Scan (8x8x8)/Cube 0: Measurement grid: dx=4.3mm, dy=4.3mm, dz=3mm
Reference Value = 5.54 V/m
Peak SAR (extrapolated) = 0.815 W/kg
SAR(1 g) = 0.142 mW/g; SAR(10 g) = 0.057 mW/g

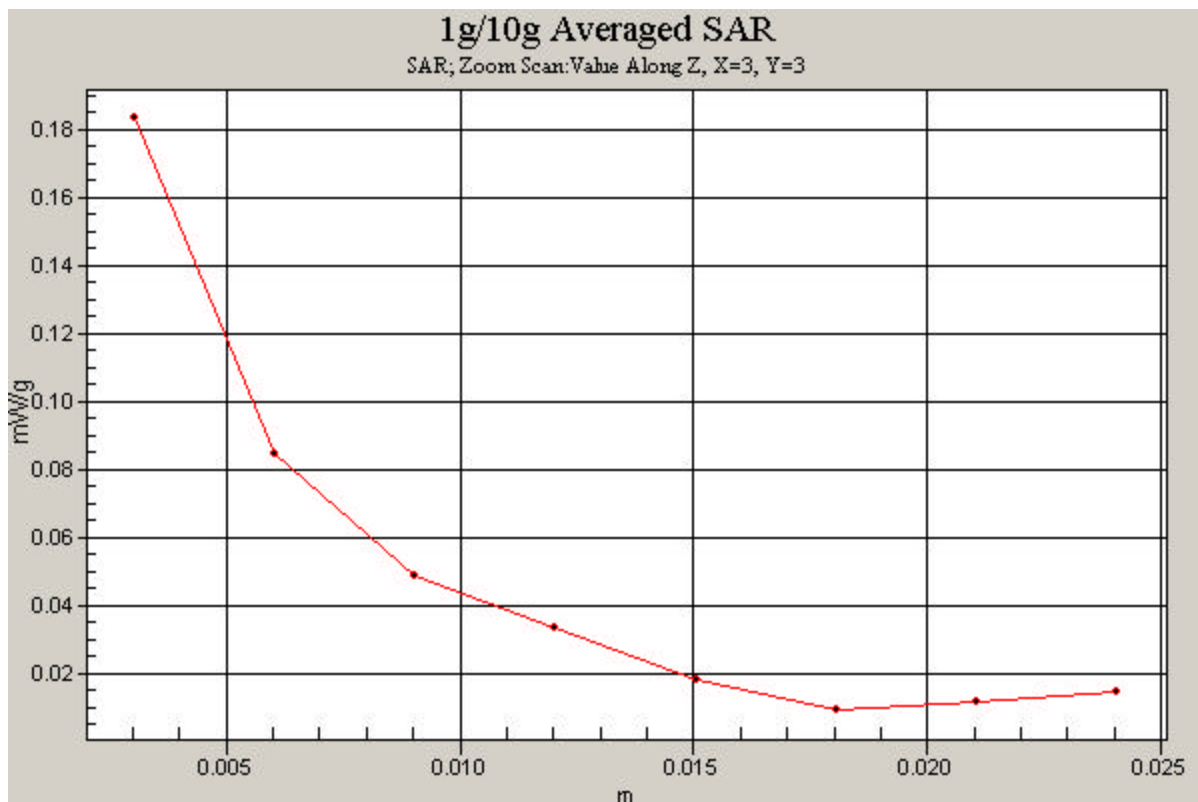

PCTEST ENGINEERING LABORATORY, INC.

DUT: CF -U1; Type: Tablet PC with 802.11abgn, Bluetooth and EVDO; Serial: DVT1 -43

Communication System: IEEE 802.11a 5.3GHz Band; Frequency: 5280 MHz; Duty Cycle: 1:1
Medium: 5300 Muscle ($\sigma = 5.32$ mho/m, $\epsilon_r = 47.59$, $\rho = 1000$ kg/m³)
Phantom section: Flat Section; Space: 0.0 cm

Test Date: 04-18-2008; Ambient Temp: 22.7°C; Tissue Temp: 21.8°C

Probe: EX3DV4 - SN3561; ConvF(3.67, 3.67, 3.67); Calibrated: 8/30/2007

Sensor-Surface: 3mm (Mechanical Surface Detection)

Electronics: DAE4 Sn649; Calibrated: 1/30/2008

Phantom: SAM Main; Type: SAM 4.0; Serial: TP-1114

Measurement SW: DASY4, V4.7 Build 53; Postprocessing SW: SEMCAD, V1.8 Build 172

Mode: 802.11a, Laptop position, 6Mbps, Low.ch

Area Scan (18x21x1): Measurement grid: dx=10mm, dy=10mm

Zoom Scan (8x8x8)/Cube 0: Measurement grid: dx=4.3mm, dy=4.3mm, dz=3mm

Reference Value = 5.28 V/m

Peak SAR (extrapolated) = 0.361 W/kg

SAR(1 g) = 0.103 mW/g; SAR(10 g) = 0.055 mW/g

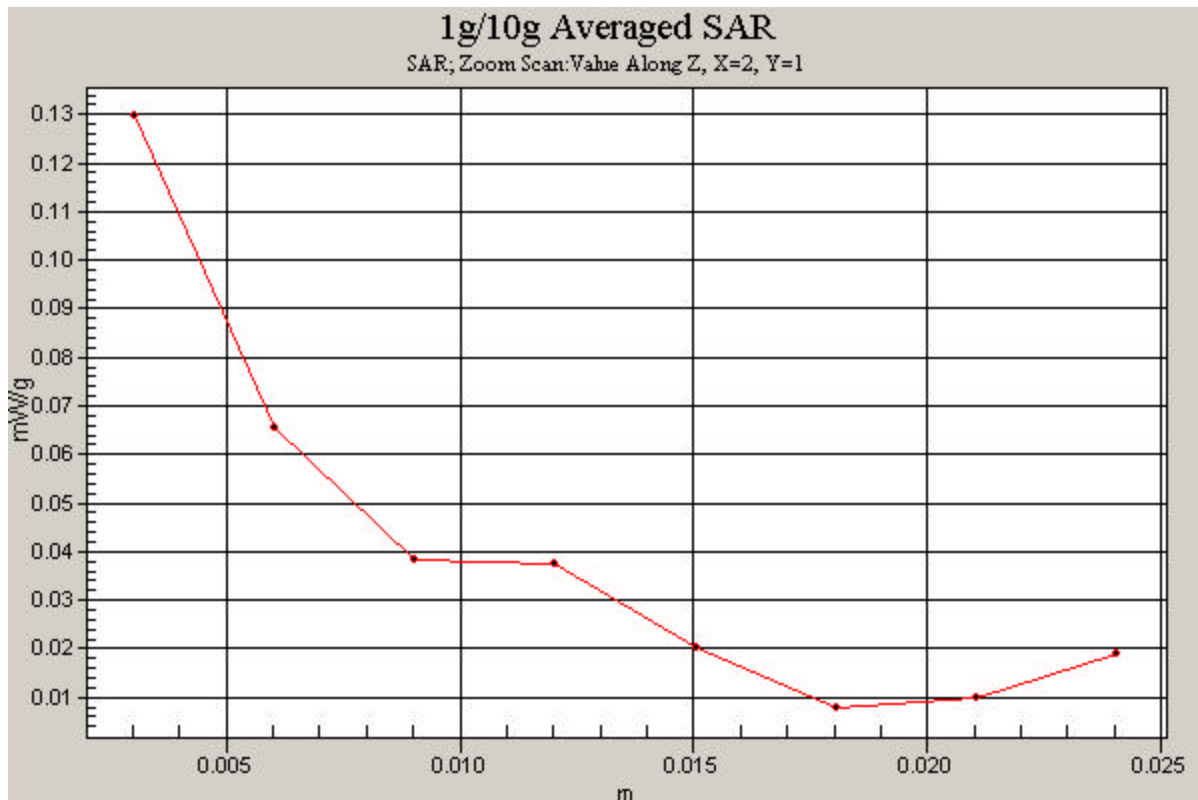

PCTEST ENGINEERING LABORATORY, INC.

DUT: CF-U1; Type: Tablet PC with 802.11abgn, Bluetooth and EVDO; Serial: DVT1-43

Communication System: IEEE 802.11a 5.8GHz Band; Frequency: 5745 MHz; Duty Cycle: 1:1
Medium: 5800 Muscle ($\sigma = 6.12 \text{ mho/m}$, $\epsilon_r = 49.55$, $\rho = 1000 \text{ kg/m}^3$)

Phantom section: Flat Section; Space: 0.0 cm

Test Date: 04-19-2008; Ambient Temp: 22.9°C; Tissue Temp: 21.9°C

Probe: EX3DV4 - SN3561; ConvF(3.75, 3.75, 3.75); Calibrated: 8/30/2007

Sensor-Surface: 3mm (Mechanical Surface Detection)

Electronics: DAE4 Sn649; Calibrated: 1/30/2008

Phantom: SAM Main; Type: SAM 4.0; Serial: TP-1114

Measurement SW: DASY4, V4.7 Build 53; Postprocessing SW: SEMCAD, V1.8 Build 172

Mode: 802.11a, Laptop position, 6Mbps, Low.ch

Area Scan (18x21x1): Measurement grid: dx=10mm, dy=10mm

Zoom Scan (8x8x8)/Cube 0: Measurement grid: dx=4.3mm, dy=4.3mm, dz=3mm

Reference Value = 4.36 V/m

Peak SAR (extrapolated) = 0.240 W/kg

SAR(1 g) = 0.082 mW/g; SAR(10 g) = 0.046 mW/g

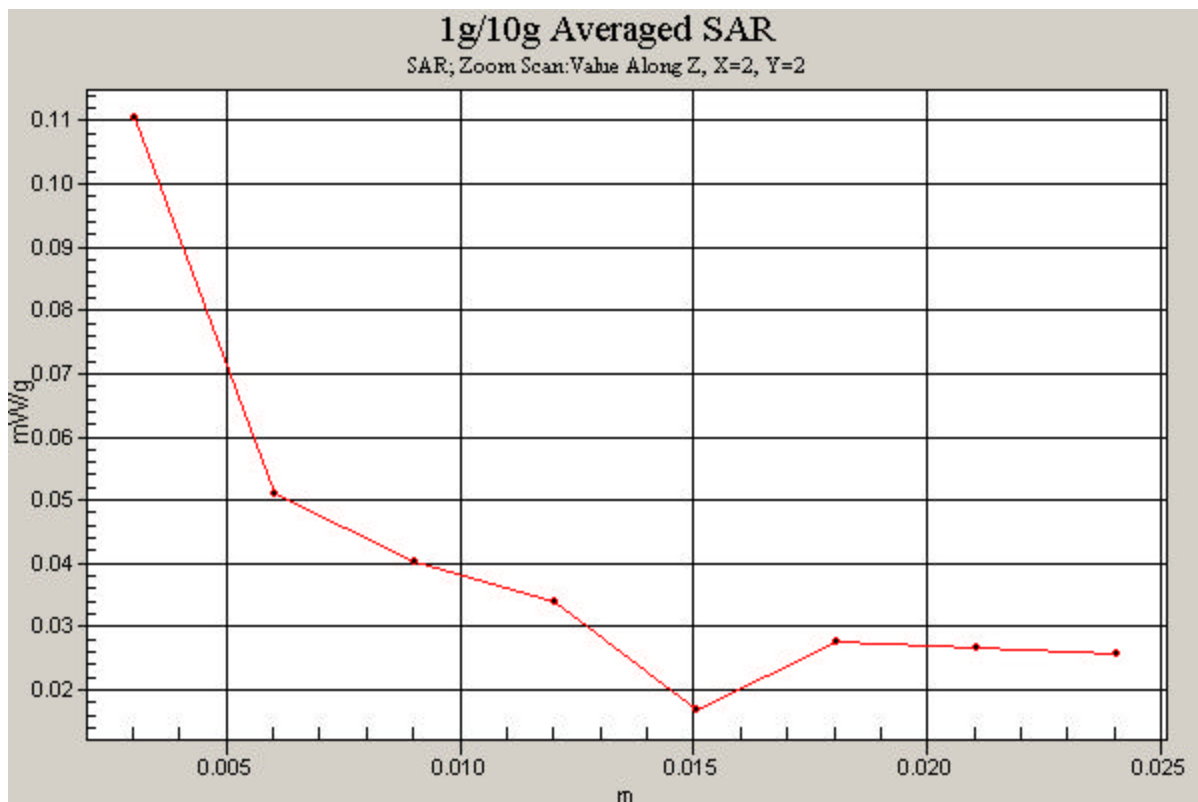

APPENDIX B: DIPOLE VALIDATION

PCTEST ENGINEERING LABORATORY, INC.

DUT: D835V2 - SN4d047; Type: 835MHz SAR Validation Dipole ; Serial: 4d047

Communication System: CW; Frequency: 835 MHz; Duty Cycle: 1:1

Medium: 835 Brain ($\sigma = 0.88$ mho/m, $\epsilon_r = 39.91$, $\rho = 1000$ kg/m³)

Phantom section: Flat Section; Space: 1.5 cm

Test Date: 04-16-2008; Ambient Temp: 23.2°C; Tissue Temp: 21.7°C

Probe: EX3DV4 - SN3561; ConvF(8.38, 8.38, 8.38); Calibrated: 8/30/2007

Sensor-Surface: 3mm (Mechanical Surface Detection)

Electronics: DAE4 Sn649; Calibrated: 1/30/2008

Phantom: SAM Main; Type: SAM 4.0; Serial: TP-1114

Measurement SW: DASY4, V4.7 Build 53; Postprocessing SW: SEMCAD, V1.8 Build 172

835MHz Dipole Validation

Area Scan (7x13x1): Measurement grid: dx=15mm, dy=15mm

Zoom Scan (5x5x7)/Cube 0: Measurement grid: dx=8mm, dy=8mm, dz=5mm

Input Power = 24.0 dBm (250 mW)

SAR(1 g) = 2.35 mW/g; SAR(10 g) = 1.54 mW/g

Target SAR(1g) = 2.29 mW/g; Deviation = +2.62%

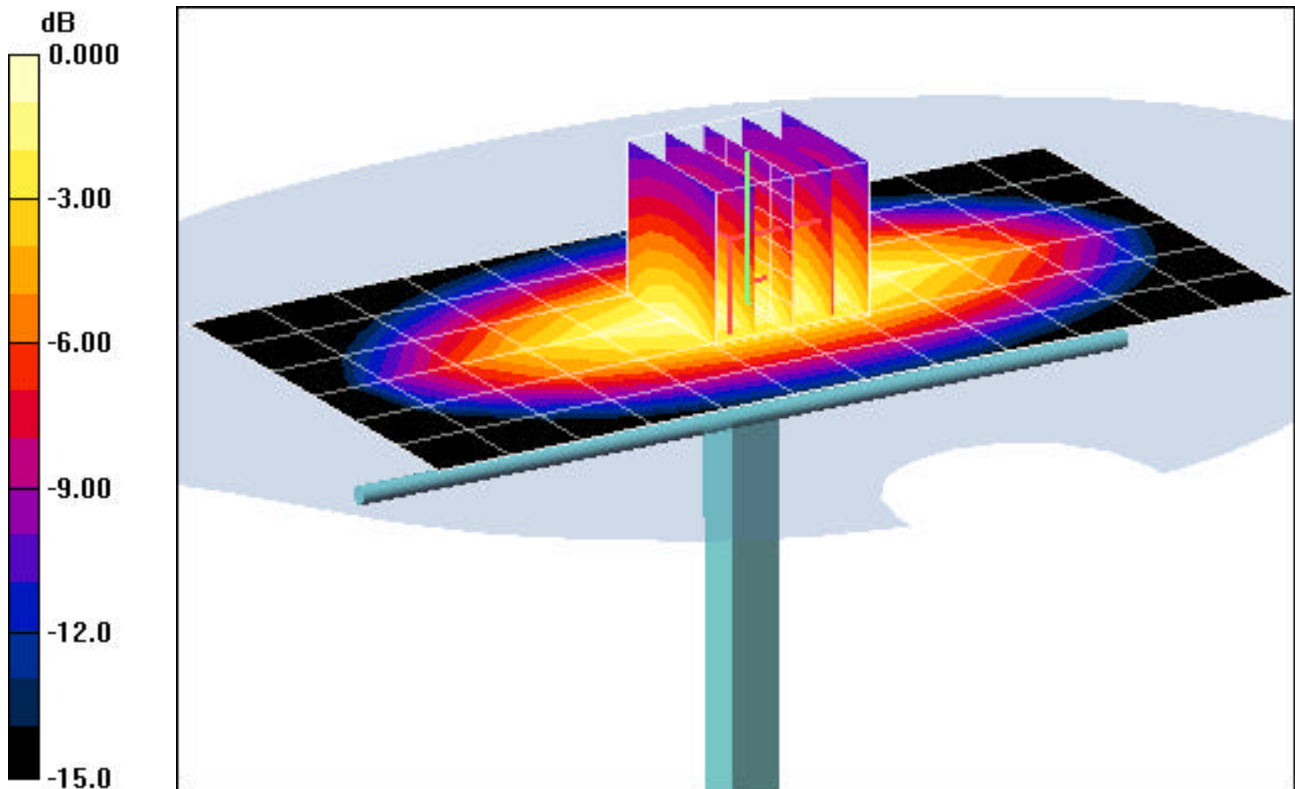

0 dB = 3.00mW/g

PCTEST ENGINEERING LABORATORY, INC.

DUT: D1900V2 - SN5d080; Type: 1900MHz SAR Validation Dipole; Serial: 5d080

Communication System: CW; Frequency: 1900 MHz; Duty Cycle: 1:1

Medium: 1900 Brain ($\sigma = 1.37$ mho/m, $\epsilon_r = 38.28$, $\rho = 1000$ kg/m³)

Phantom section: Flat Section; Space: 1.0 cm

Test Date: 04-16-2008; Ambient Temp: 23.0°C; Tissue Temp: 21.6°C

Probe: EX3DV4 - SN3561; ConvF(6.71, 6.71, 6.71); Calibrated: 8/30/2007

Sensor-Surface: 3mm (Mechanical Surface Detection)

Electronics: DAE4 Sn649; Calibrated: 1/30/2008

Phantom: SAM Sub; Type: SAM 4.0; Serial: TP-1357

Measurement SW: DASY4, V4.7 Build 53; Postprocessing SW: SEMCAD, V1.8 Build 172

1900MHz Dipole Validation

Area Scan (5x7x1): Measurement grid: dx=15mm, dy=15mm

Zoom Scan (5x5x7)/Cube 0: Measurement grid: dx=8mm, dy=8mm, dz=5mm

Input Power = 20.0 dBm (100 mW)

SAR(1 g) = 3.93 mW/g; SAR(10 g) = 2.03 mW/g

Target SAR(1g) = 3.77 mW/g; Deviation = +4.24%

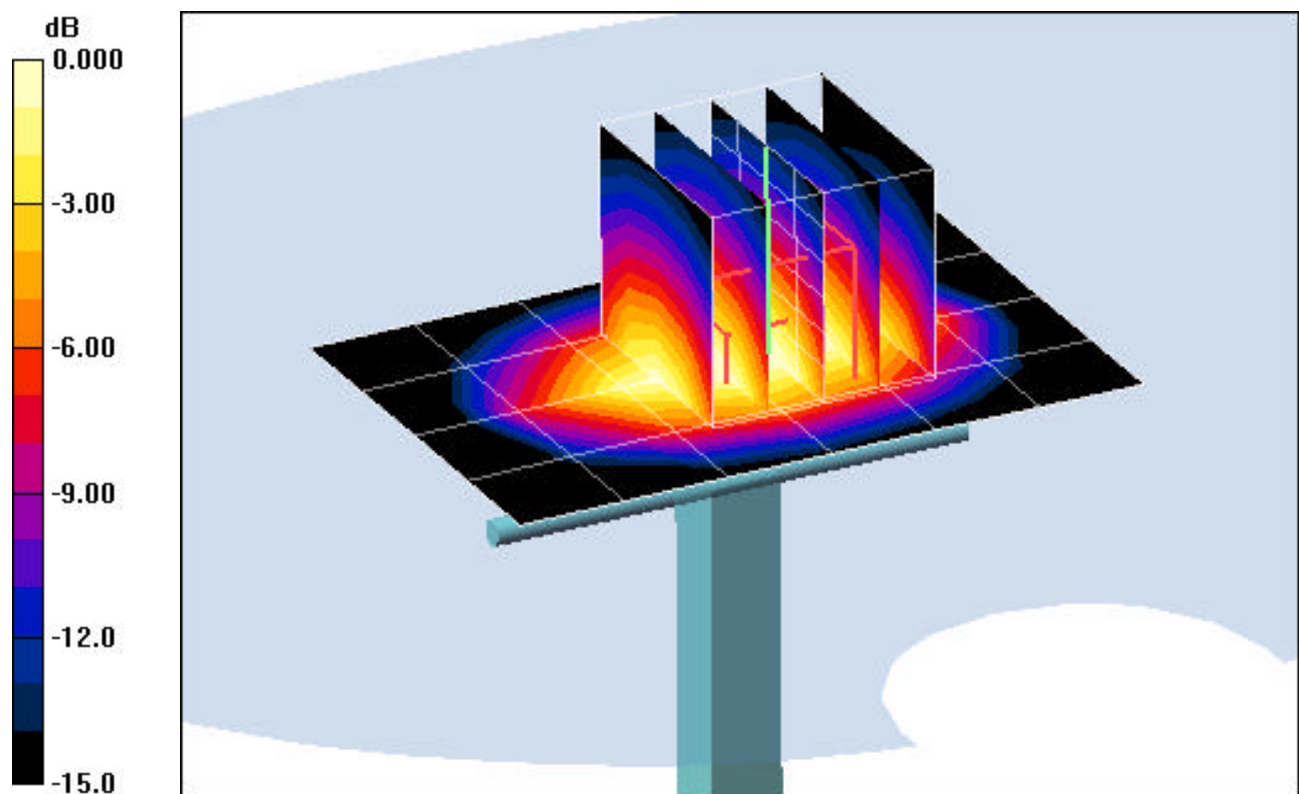

0 dB = 4.00mW/g

PCTEST ENGINEERING LABORATORY, INC.

DUT: D2450V2 - SN:797; Type: 2450MHz SAR Validation Dipole; Serial: 797

Communication System: CW; Frequency: 2450 MHz; Duty Cycle: 1:1
Medium: 2450 Brain ($\sigma = 1.76$ mho/m, $\epsilon_r = 38.42$, $\rho = 1000$ kg/m³)
Phantom section: Flat Section; Space: 1.0 cm

Test Date: 04-16-2008; Ambient Temp: 23.5°C; Tissue Temp: 21.8°C

Probe: EX3DV4 - SN3561; ConvF(6.26, 6.26, 6.26); Calibrated: 8/30/2007
Sensor-Surface: 3mm (Mechanical Surface Detection)
Electronics: DAE4 Sn649; Calibrated: 1/30/2008
Phantom: SAM Main; Type: SAM 4.0; Serial: TP-1114
Measurement SW: DASY4, V4.7 Build 53; Postprocessing SW: SEMCAD, V1.8 Build 172

2450MHz Dipole Validation

Area Scan (5x7x1): Measurement grid: dx=15mm, dy=15mm
Zoom Scan (5x5x7)/Cube 0: Measurement grid: dx=8mm, dy=8mm, dz=5mm
Input Power = 20.0 dBm (100 mW)
SAR(1 g) = 5.07 mW/g; SAR(10 g) = 2.35 mW/g
Target SAR(1g) = 5.41 mW/g; Deviation = - 6.28 %

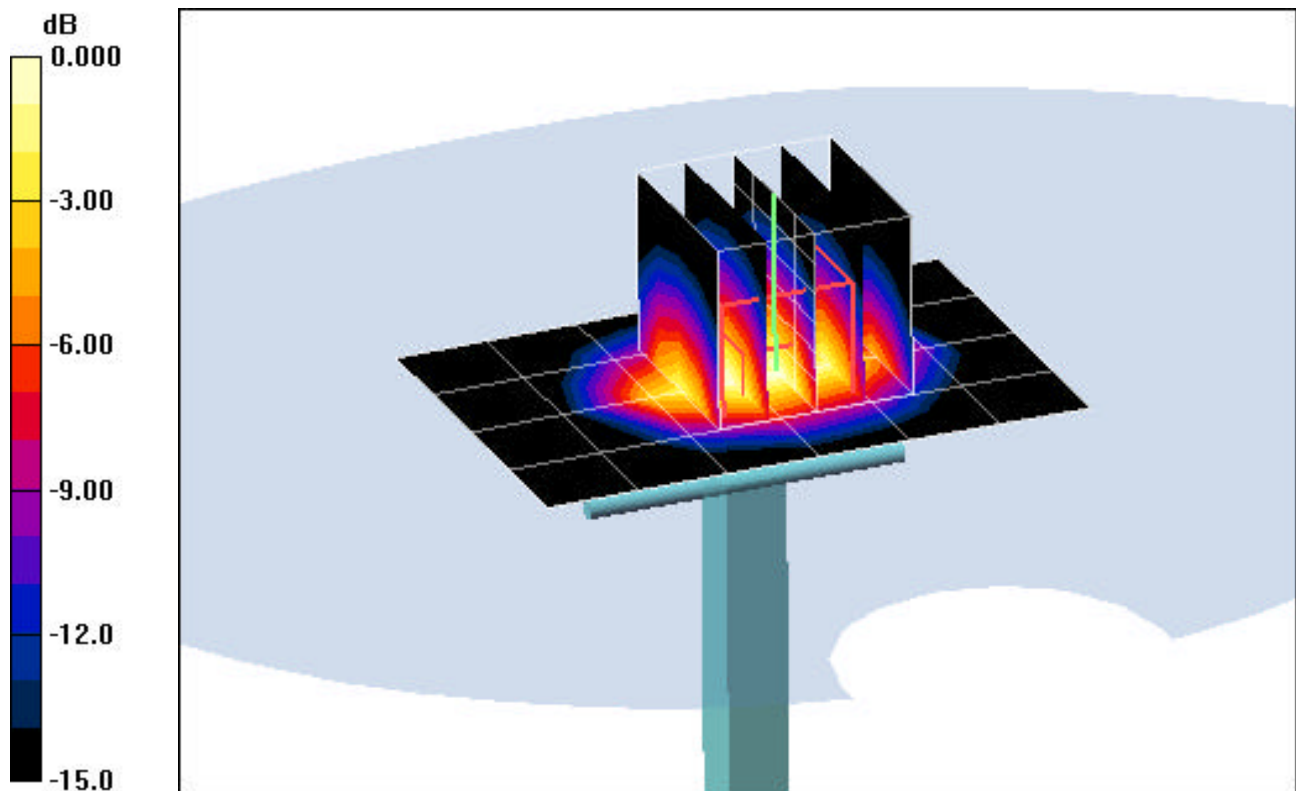

PCTEST ENGINEERING LABORATORY, INC.

DUT: D2450V2 - SN:797; Type: 2450MHz SAR Validation Dipole; Serial: 797

Communication System: CW; Frequency: 2450 MHz; Duty Cycle: 1:1
Medium: 2450 Brain ($\sigma = 1.76$ mho/m, $\epsilon_r = 38.42$, $\rho = 1000$ kg/m³)
Phantom section: Flat Section; Space: 1.0 cm

Test Date: 04-17-2008; Ambient Temp: 22.9°C; Tissue Temp: 21.6°C

Probe: EX3DV4 - SN3561; ConvF(6.26, 6.26, 6.26); Calibrated: 8/30/2007
Sensor-Surface: 3mm (Mechanical Surface Detection)
Electronics: DAE4 Sn649; Calibrated: 1/30/2008
Phantom: SAM Main; Type: SAM 4.0; Serial: TP-1114
Measurement SW: DASY4, V4.7 Build 53; Postprocessing SW: SEMCAD, V1.8 Build 172

2450MHz Dipole Validation

Area Scan (5x7x1): Measurement grid: dx=15mm, dy=15mm
Zoom Scan (5x5x7)/Cube 0: Measurement grid: dx=8mm, dy=8mm, dz=5mm
Input Power = 20.0 dBm (100 mW)
SAR(1 g) = 5.18 mW/g; SAR(10 g) = 2.41 mW/g
Target SAR(1g) = 5.41 mW/g; Deviation = -4.25 %

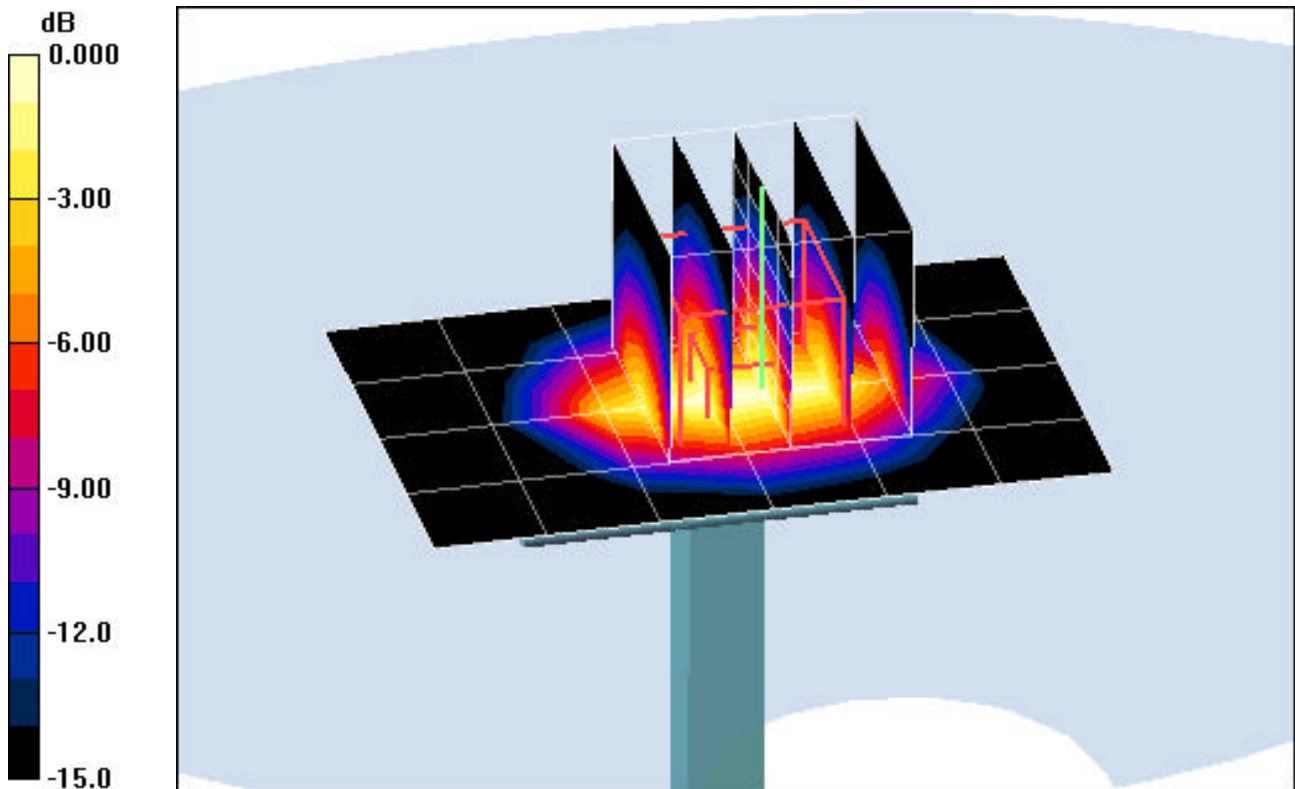

PCTEST ENGINEERING LABORATORY, INC.

DUT: D5GHzV2 - SN1057; Type: 5GHz SAR Validation Dipole; Serial: 1057

Communication System: CW; Frequency: 5200 MHz; Duty Cycle: 1:1
Medium: 5300 Brain ($\sigma = 4.69$ mho/m, $\epsilon_r = 34.21$, $\rho = 1000$ kg/m³)
Phantom section: Flat Section; Space: 1.0 cm

Test Date: 04-18-2008; Ambient Temp: 23.2°C; Tissue Temp: 21.5°C

Probe: EX3DV4 - SN3561; ConvF(4.56, 4.56, 4.56); Calibrated: 8/30/2007
Sensor-Surface: 3mm (Mechanical Surface Detection)
Electronics: DAE4 Sn649; Calibrated: 1/30/2008
Phantom: SAM Main; Type: SAM 4.0; Serial: TP-1114
Measurement SW: DASY4, V4.7 Build 53; Postprocessing SW: SEMCAD, V1.8 Build 172

5200MHz Dipole Validation

Area Scan (7x9x1): Measurement grid: dx=10mm, dy=10mm

Zoom Scan (8x8x8)/Cube 0: Measurement grid: dx=4.3mm, dy=4.3mm, dz=3mm

Input Power = 14.0 dBm (25 mW)

SAR(1 g) = 2.09 mW/g; SAR(10 g) = 0.585 mW/g

Target SAR(1g) = 2.1325 mW/g; Deviation = -1.99 %

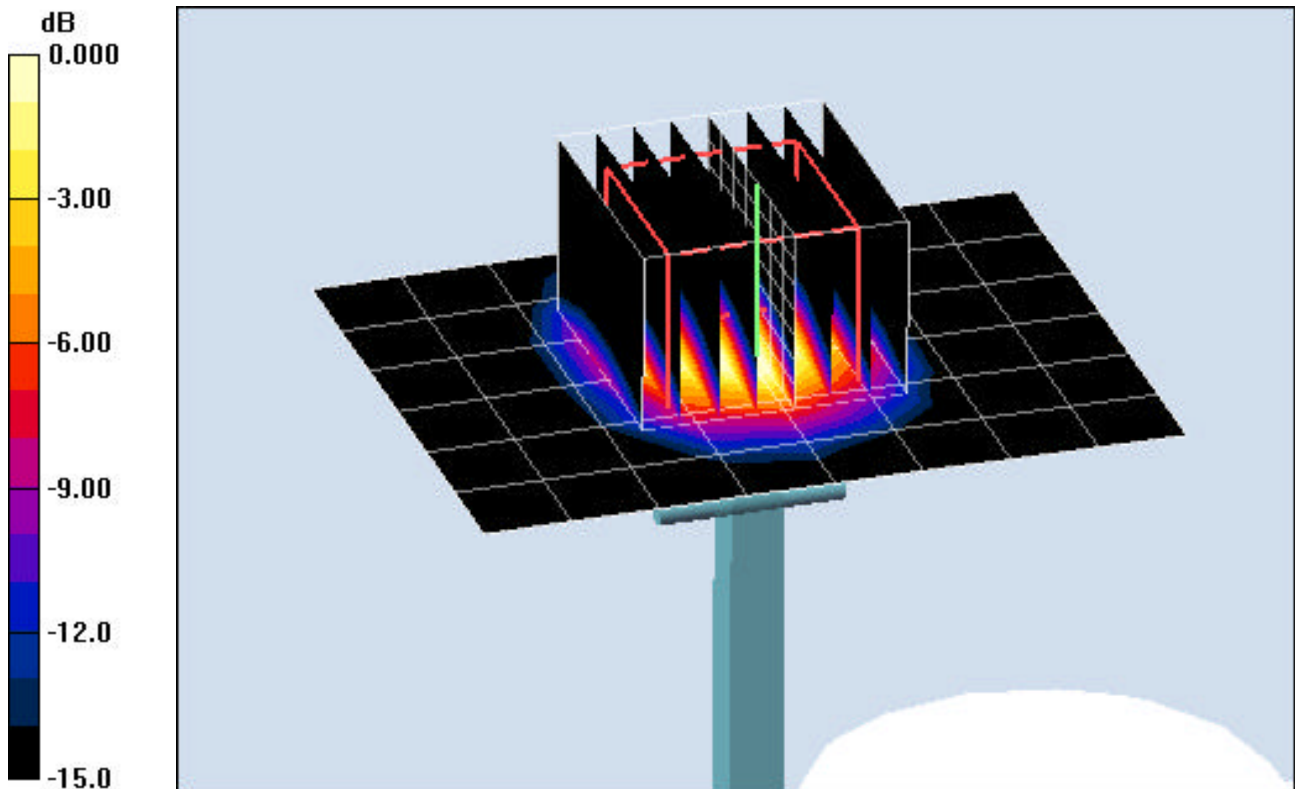

0 dB = 2.00mW/g

PCTEST ENGINEERING LABORATORY, INC.

DUT: D5GHzV2 - SN1057; Type: 5GHz SAR Validation Dipole; Serial: 1057

Communication System: CW; Frequency: 5200 MHz; Duty Cycle: 1:1
Medium: 5300 Brain ($\sigma = 4.69$ mho/m, $\epsilon_r = 34.21$, $\rho = 1000$ kg/m³)
Phantom section: Flat Section; Space: 1.0 cm

Test Date: 04-19-2008; Ambient Temp: 23.1°C; Tissue Temp: 21.9°C

Probe: EX3DV4 - SN3561; ConvF(4.56, 4.56, 4.56); Calibrated: 8/30/2007
Sensor-Surface: 3mm (Mechanical Surface Detection)
Electronics: DAE4 Sn649; Calibrated: 1/30/2008
Phantom: SAM Main; Type: SAM 4.0; Serial: TP-1114
Measurement SW: DASY4, V4.7 Build 53; Postprocessing SW: SEMCAD, V1.8 Build 172

5200MHz Dipole Validation

Area Scan (7x9x1): Measurement grid: dx=10mm, dy=10mm

Zoom Scan (8x8x8)/Cube 0: Measurement grid: dx=4.3mm, dy=4.3mm, dz=3mm

Input Power = 14.0 dBm (25 mW)

SAR(1 g) = 2.26 mW/g; SAR(10 g) = 0.630 mW/g

Target SAR(1g) = 2.1325 mW/g; Deviation = +5.98 %

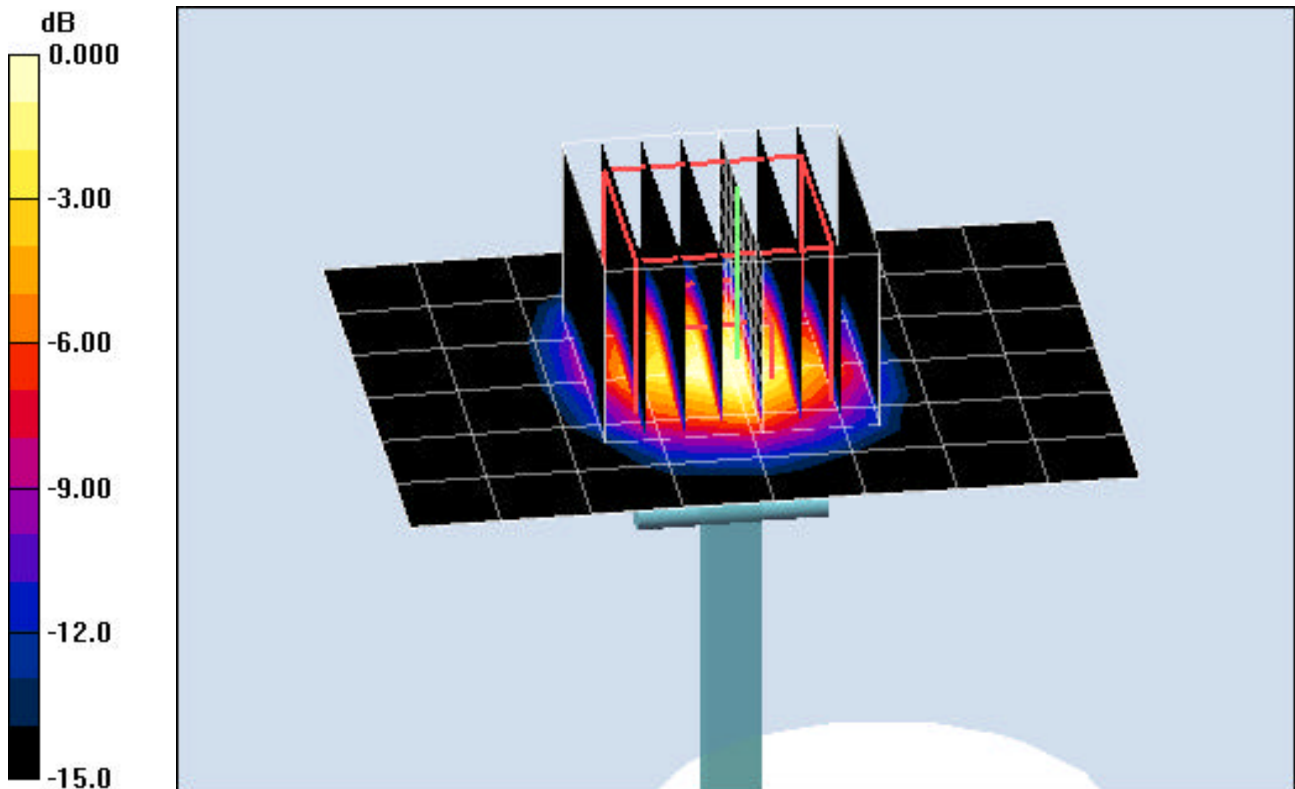

0 dB = 2.50mW/g

PCTEST ENGINEERING LABORATORY, INC.

DUT: D5GHzV2 - SN1057; Type: 5GHz SAR Validation Dipole; Serial: 1057

Communication System: CW; Frequency: 5800 MHz; Duty Cycle: 1:1
Medium: 5800 Brain ($\sigma = 5.08$ mho/m, $\epsilon_r = 36.98$, $\rho = 1000$ kg/m³)
Phantom section: Flat Section; Space: 1.0 cm

Test Date: 04-19-2008; Ambient Temp: 23.3°C; Tissue Temp: 21.7°C

Probe: EX3DV4 - SN3561; ConvF(4.05, 4.05, 4.05); Calibrated: 8/30/2007
Sensor-Surface: 3mm (Mechanical Surface Detection)
Electronics: DAE4 Sn649; Calibrated: 1/30/2008
Phantom: SAM Main; Type: SAM 4.0; Serial: TP-1114
Measurement SW: DASY4, V4.7 Build 53; Postprocessing SW: SEMCAD, V1.8 Build 172

5800MHz Dipole Validation

Area Scan (7x9x1): Measurement grid: dx=10mm, dy=10mm

Zoom Scan (8x8x8)/Cube 0: Measurement grid: dx=4.3mm, dy=4.3mm, dz=3mm

Input Power = 14.0 dBm (25 mW)

SAR(1 g) = 2.08 mW/g; SAR(10 g) = 0.567 mW/g

Target SAR(1g) = 2.1025 mW/g; Deviation = -1.07 %

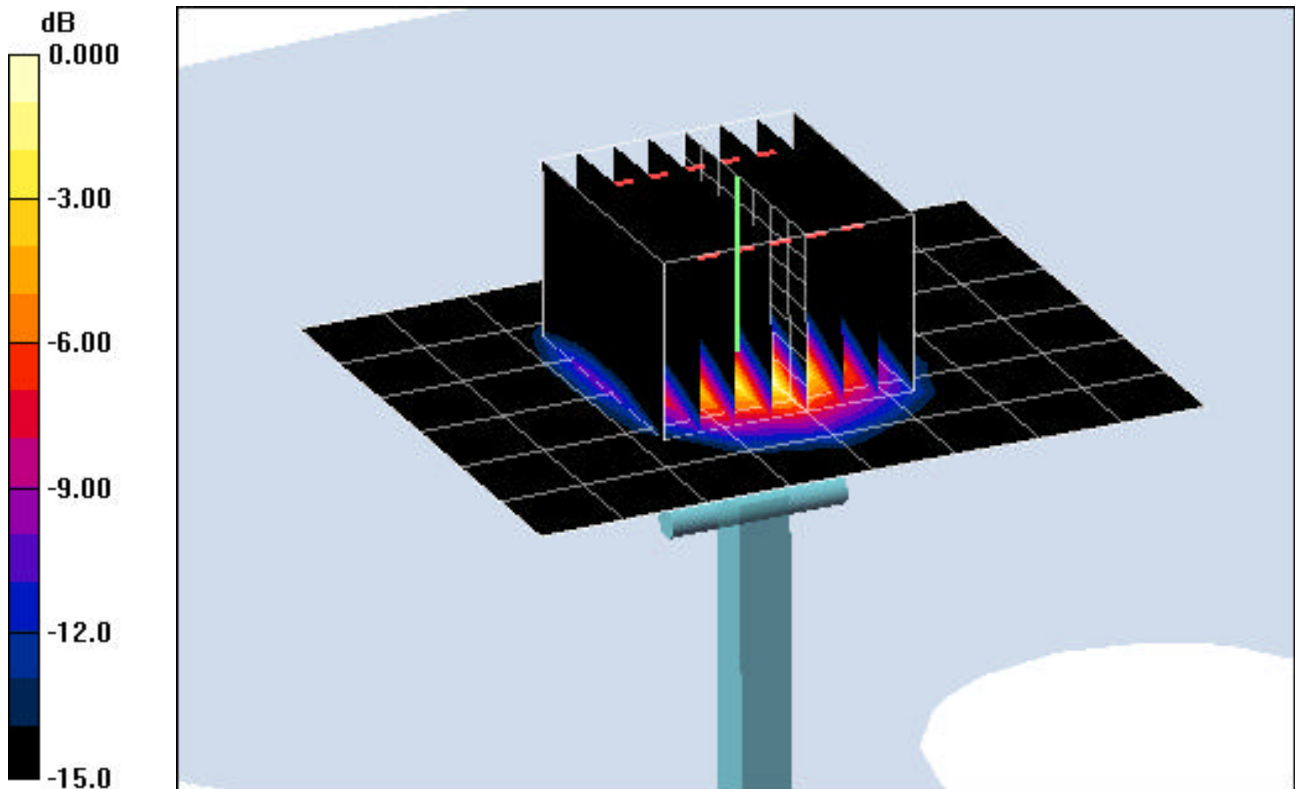

APPENDIX C: PROBE CALIBRATION



Accredited by the Swiss Federal Office of Metrology and Accreditation
**The Swiss Accreditation Service is one of the signatories to the EA
Multilateral Agreement for the recognition of calibration certificates**

Accreditation No.: **SCS 108**

Client **PC Test**

Certificate No: **EX3-3561_Aug07**

CALIBRATION CERTIFICATE

Object **EX3DV4 - SN:3561**

Calibration procedure(s) **QA CAL-01.v6 and QA CAL-14.v3
Calibration procedure for dosimetric E-field probes**

Calibration date: **August 30, 2007**

Condition of the calibrated item **In Tolerance**

This calibration certificate documents the traceability to national standards, which realize the physical units of measurements (SI).
The measurements and the uncertainties with confidence probability are given on the following pages and are part of the certificate.

All calibrations have been conducted in the closed laboratory facility: environment temperature (22 ± 3)°C and humidity < 70%.

Calibration Equipment used (M&TE critical for calibration)

Primary Standards	ID #	Cal Date (Calibrated by, Certificate No.)	Scheduled Calibration
Power meter E4419B	GB41293874	29-Mar-07 (METAS, No. 217-00670)	Mar-08
Power sensor E4412A	MY41495277	29-Mar-07 (METAS, No. 217-00670)	Mar-08
Power sensor E4412A	MY41498087	29-Mar-07 (METAS, No. 217-00670)	Mar-08
Reference 3 dB Attenuator	SN: S5054 (3c)	8-Aug-07 (METAS, No. 217-00719)	Aug-08
Reference 20 dB Attenuator	SN: S5086 (20b)	29-Mar-07 (METAS, No. 217-00671)	Mar-08
Reference 30 dB Attenuator	SN: S5129 (30b)	8-Aug-07 (METAS, No. 217-00720)	Aug-08
Reference Probe ES3DV2	SN: 3013	4-Jan-07 (SPEAG, No. ES3-3013_Jan07)	Jan-08
DAE4	SN: 654	20-Apr-07 (SPEAG, No. DAE4-654_Apr07)	Apr-08

Secondary Standards	ID #	Check Date (in house)	Scheduled Check
RF generator HP 8648C	US3642U01700	4-Aug-99 (SPEAG, in house check Nov-05)	In house check: Nov-07
Network Analyzer HP 8753E	US37390585	18-Oct-01 (SPEAG, in house check Oct-06)	In house check: Oct-07

Calibrated by: **Katja Pokovic** **Technical Manager**

Approved by: **Niels Kuster** **Quality Manager**

Issued: August 30, 2007

This calibration certificate shall not be reproduced except in full without written approval of the laboratory.



Accredited by the Swiss Federal Office of Metrology and Accreditation
The Swiss Accreditation Service is one of the signatories to the EA
Multilateral Agreement for the recognition of calibration certificates

Accreditation No.: SCS 108

Glossary:

TSL	tissue simulating liquid
NORM _{x,y,z}	sensitivity in free space
ConF	sensitivity in TSL / NORM _{x,y,z}
DCP	diode compression point
Polarization φ	φ rotation around probe axis
Polarization ϑ	ϑ rotation around an axis that is in the plane normal to probe axis (at measurement center), i.e., $\vartheta = 0$ is normal to probe axis

Calibration is Performed According to the Following Standards:

- IEEE Std 1528-2003, "IEEE Recommended Practice for Determining the Peak Spatial-Averaged Specific Absorption Rate (SAR) in the Human Head from Wireless Communications Devices: Measurement Techniques", December 2003
- IEC 62209-1, "Procedure to measure the Specific Absorption Rate (SAR) for hand-held devices used in close proximity to the ear (frequency range of 300 MHz to 3 GHz)", February 2005

Methods Applied and Interpretation of Parameters:

- NORM_{x,y,z}**: Assessed for E-field polarization $\vartheta = 0$ ($f \leq 900$ MHz in TEM-cell; $f > 1800$ MHz: R22 waveguide). NORM_{x,y,z} are only intermediate values, i.e., the uncertainties of NORM_{x,y,z} does not effect the E²-field uncertainty inside TSL (see below *ConvF*).
- NORM(f)_{x,y,z}** = NORM_{x,y,z} * *frequency_response* (see Frequency Response Chart). This linearization is implemented in DASY4 software versions later than 4.2. The uncertainty of the frequency response is included in the stated uncertainty of *ConvF*.
- DCP_{x,y,z}**: DCP are numerical linearization parameters assessed based on the data of power sweep (no uncertainty required). DCP does not depend on frequency nor media.
- ConvF and Boundary Effect Parameters**: Assessed in flat phantom using E-field (or Temperature Transfer Standard for $f \leq 800$ MHz) and inside waveguide using analytical field distributions based on power measurements for $f > 800$ MHz. The same setups are used for assessment of the parameters applied for boundary compensation (alpha, depth) of which typical uncertainty values are given. These parameters are used in DASY4 software to improve probe accuracy close to the boundary. The sensitivity in TSL corresponds to NORM_{x,y,z} * *ConvF* whereby the uncertainty corresponds to that given for *ConvF*. A frequency dependent *ConvF* is used in DASY version 4.4 and higher which allows extending the validity from ± 50 MHz to ± 100 MHz.
- Spherical isotropy (3D deviation from isotropy)**: in a field of low gradients realized using a flat phantom exposed by a patch antenna.
- Sensor Offset**: The sensor offset corresponds to the offset of virtual measurement center from the probe tip (on probe axis). No tolerance required.

Probe EX3DV4

SN:3561

Manufactured:	February 14, 2005
Last calibrated:	November 23, 2006
Recalibrated:	August 30, 2007

Calibrated for DASY Systems

(Note: non-compatible with DASY2 system!)

DASY - Parameters of Probe: EX3DV4 SN:3561**Sensitivity in Free Space^A****Diode Compression^B**

NormX	0.440 ± 10.1%	$\mu\text{V}/(\text{V}/\text{m})^2$	DCP X	85 mV
NormY	0.490 ± 10.1%	$\mu\text{V}/(\text{V}/\text{m})^2$	DCP Y	90 mV
NormZ	0.420 ± 10.1%	$\mu\text{V}/(\text{V}/\text{m})^2$	DCP Z	89 mV

Sensitivity in Tissue Simulating Liquid (Conversion Factors)

Please see Page 8.

Boundary Effect**TSL 835 MHz Typical SAR gradient: 5 % per mm**

Sensor Center to Phantom Surface Distance		2.0 mm	3.0 mm
SAR _{b0} [%]	Without Correction Algorithm	1.2	0.1
SAR _{b0} [%]	With Correction Algorithm	0.4	0.0

TSL 1900 MHz Typical SAR gradient: 10 % per mm

Sensor Center to Phantom Surface Distance		2.0 mm	3.0 mm
SAR _{b0} [%]	Without Correction Algorithm	3.0	5.0
SAR _{b0} [%]	With Correction Algorithm	0.2	0.1

Sensor OffsetProbe Tip to Sensor Center **1.0** mm

The reported uncertainty of measurement is stated as the standard uncertainty of measurement multiplied by the coverage factor k=2, which for a normal distribution corresponds to a coverage probability of approximately 95%.

^A The uncertainties of NormX,Y,Z do not affect the E²-field uncertainty inside TSL (see Page 8).^B Numerical linearization parameter: uncertainty not required.

Frequency Response of E-Field

(TEM-Cell:ifi110 EXX, Waveguide: R22)

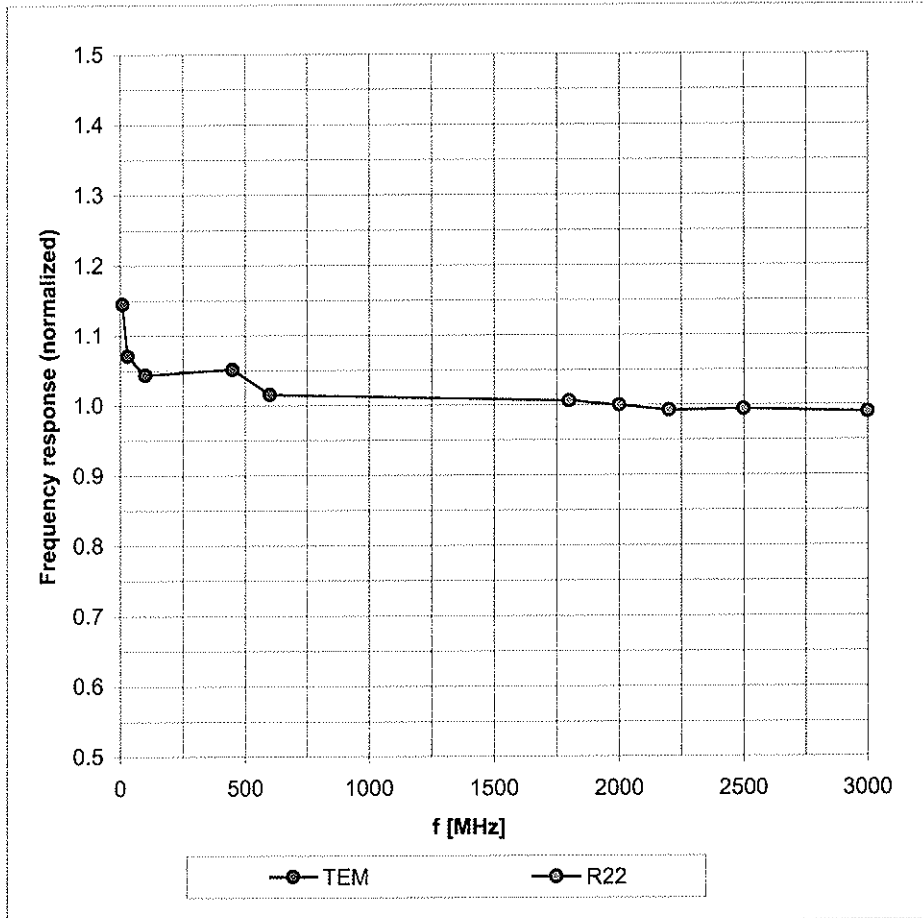

Uncertainty of Frequency Response of E-field: $\pm 6.3\%$ ($k=2$)

Receiving Pattern (ϕ), $\vartheta = 0^\circ$

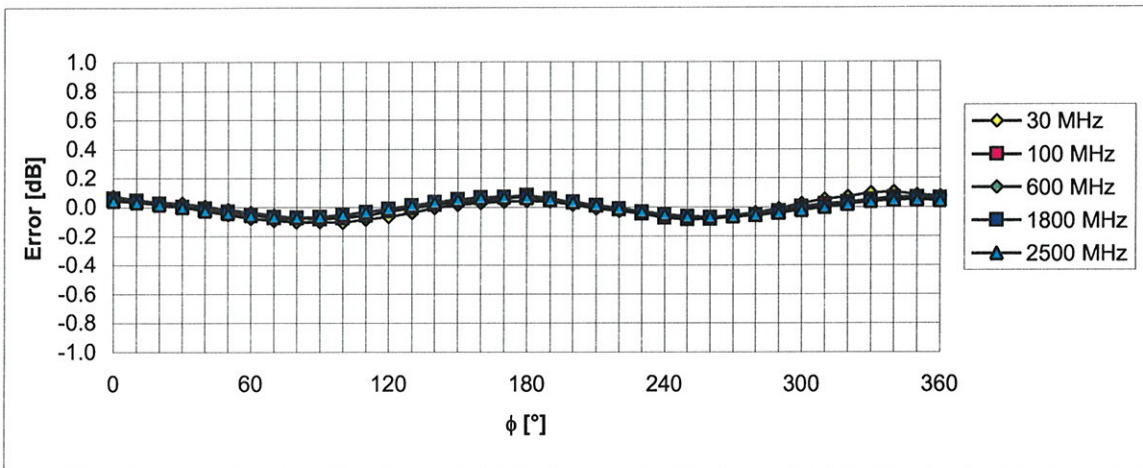
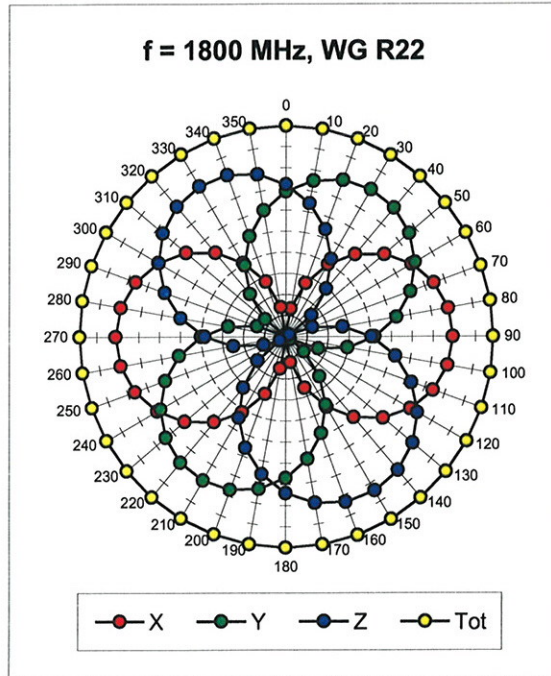
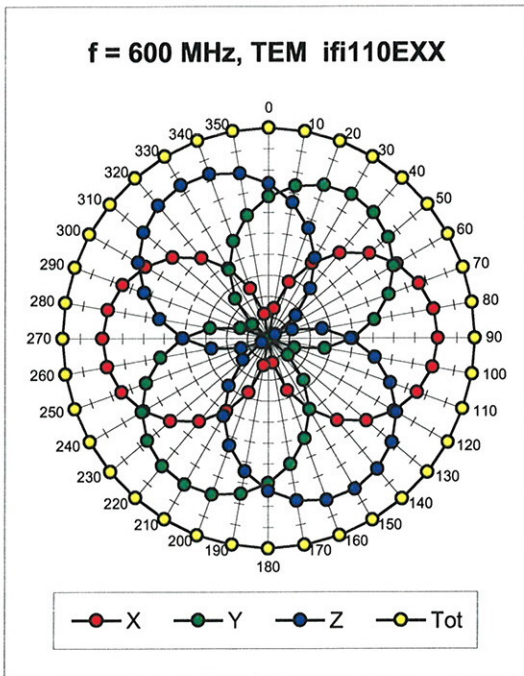

Uncertainty of Axial Isotropy Assessment: $\pm 0.5\%$ ($k=2$)

Dynamic Range $f(\text{SAR}_{\text{head}})$ (Waveguide R22, $f = 1800 \text{ MHz}$)

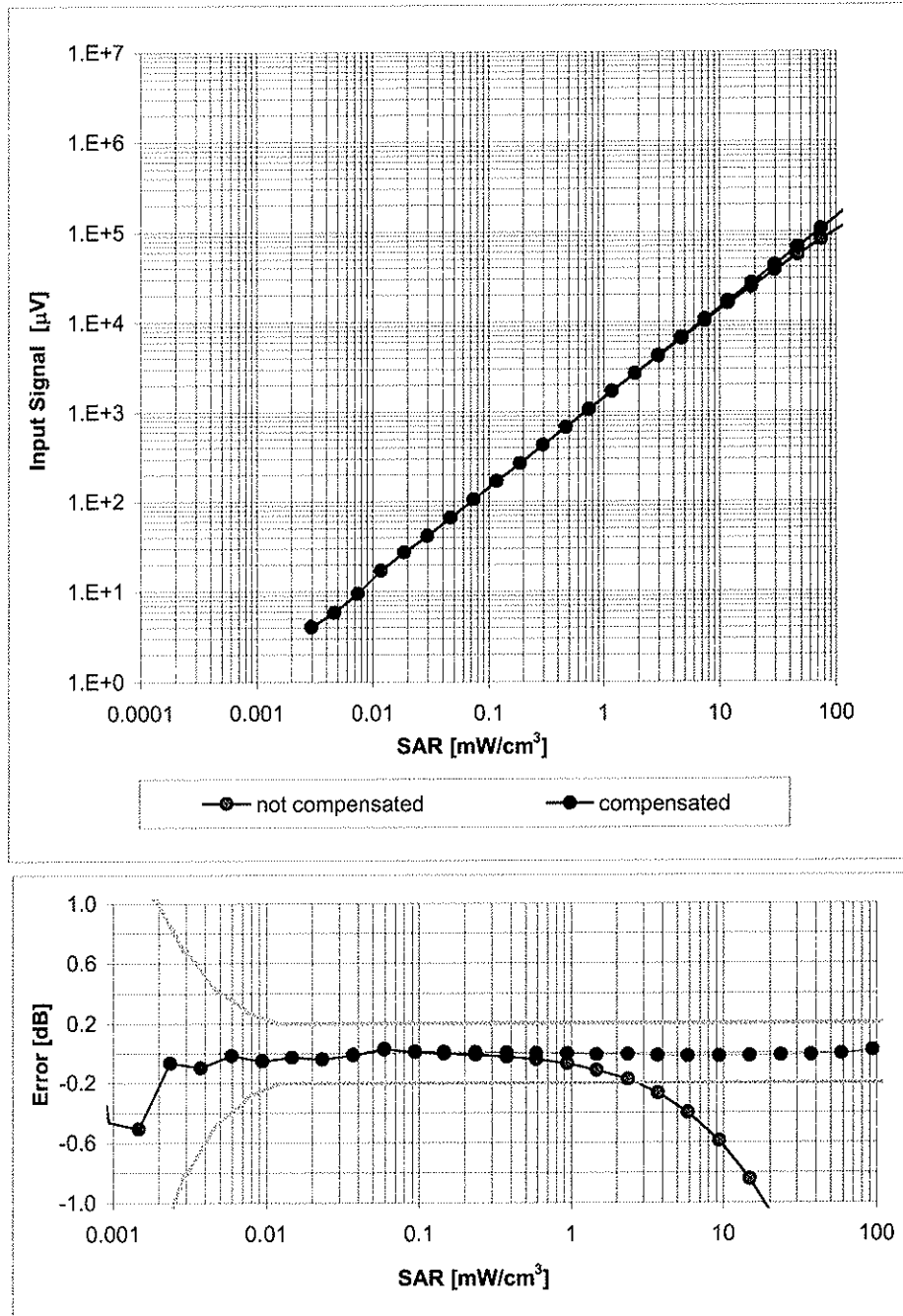

Uncertainty of Linearity Assessment: $\pm 0.6\%$ ($k=2$)

Conversion Factor Assessment

f [MHz]	Validity [MHz] ^c	TSL	Permittivity	Conductivity	Alpha	Depth	ConvF Uncertainty
835	± 50 / ± 100	Head	41.5 ± 5%	0.90 ± 5%	0.65	0.80	8.38 ± 11.0% (k=2)
1750	± 50 / ± 100	Head	40.1 ± 5%	1.37 ± 5%	0.29	1.00	6.85 ± 11.0% (k=2)
1900	± 50 / ± 100	Head	40.0 ± 5%	1.40 ± 5%	0.23	1.10	6.71 ± 11.0% (k=2)
2450	± 50 / ± 100	Head	39.2 ± 5%	1.80 ± 5%	0.41	1.00	6.26 ± 11.8% (k=2)
2600	± 50 / ± 100	Head	39.0 ± 5%	1.96 ± 5%	0.42	1.00	6.09 ± 11.8% (k=2)
4950	± 50 / ± 100	Head	36.3 ± 5%	4.40 ± 5%	0.44	1.45	4.77 ± 13.1% (k=2)
5200	± 50 / ± 100	Head	36.0 ± 5%	4.66 ± 5%	0.42	1.45	4.56 ± 13.1% (k=2)
5300	± 50 / ± 100	Head	35.9 ± 5%	4.76 ± 5%	0.40	1.45	4.26 ± 13.1% (k=2)
5500	± 50 / ± 100	Head	35.6 ± 5%	4.96 ± 5%	0.45	1.45	4.26 ± 13.1% (k=2)
5600	± 50 / ± 100	Head	35.5 ± 5%	5.07 ± 5%	0.42	1.45	4.06 ± 13.1% (k=2)
5800	± 50 / ± 100	Head	35.3 ± 5%	5.27 ± 5%	0.40	1.45	4.05 ± 13.1% (k=2)
835	± 50 / ± 100	Body	55.2 ± 5%	0.97 ± 5%	0.70	0.80	8.27 ± 11.0% (k=2)
1750	± 50 / ± 100	Body	53.4 ± 5%	1.49 ± 5%	0.19	1.26	6.82 ± 11.0% (k=2)
1900	± 50 / ± 100	Body	53.3 ± 5%	1.52 ± 5%	0.19	1.25	6.60 ± 11.0% (k=2)
2450	± 50 / ± 100	Body	52.7 ± 5%	1.95 ± 5%	0.48	1.00	6.15 ± 11.8% (k=2)
2600	± 50 / ± 100	Body	52.5 ± 5%	2.16 ± 5%	0.46	1.00	5.86 ± 11.8% (k=2)
4950	± 50 / ± 100	Body	49.4 ± 5%	5.01 ± 5%	0.43	1.65	4.06 ± 13.1% (k=2)
5200	± 50 / ± 100	Body	49.0 ± 5%	5.30 ± 5%	0.39	1.65	3.83 ± 13.1% (k=2)
5300	± 50 / ± 100	Body	48.9 ± 5%	5.42 ± 5%	0.38	1.65	3.67 ± 13.1% (k=2)
5500	± 50 / ± 100	Body	48.6 ± 5%	5.65 ± 5%	0.36	1.65	3.67 ± 13.1% (k=2)
5600	± 50 / ± 100	Body	48.5 ± 5%	5.77 ± 5%	0.36	1.65	3.81 ± 13.1% (k=2)
5800	± 50 / ± 100	Body	48.2 ± 5%	6.00 ± 5%	0.33	1.65	3.75 ± 13.1% (k=2)

^c The validity of ± 100 MHz only applies for DASY v4.4 and higher (see Page 2). The uncertainty is the RSS of the ConvF uncertainty at calibration frequency and the uncertainty for the indicated frequency band.

Deviation from Isotropy in HSL

Error (ϕ , ϑ), $f = 900$ MHz

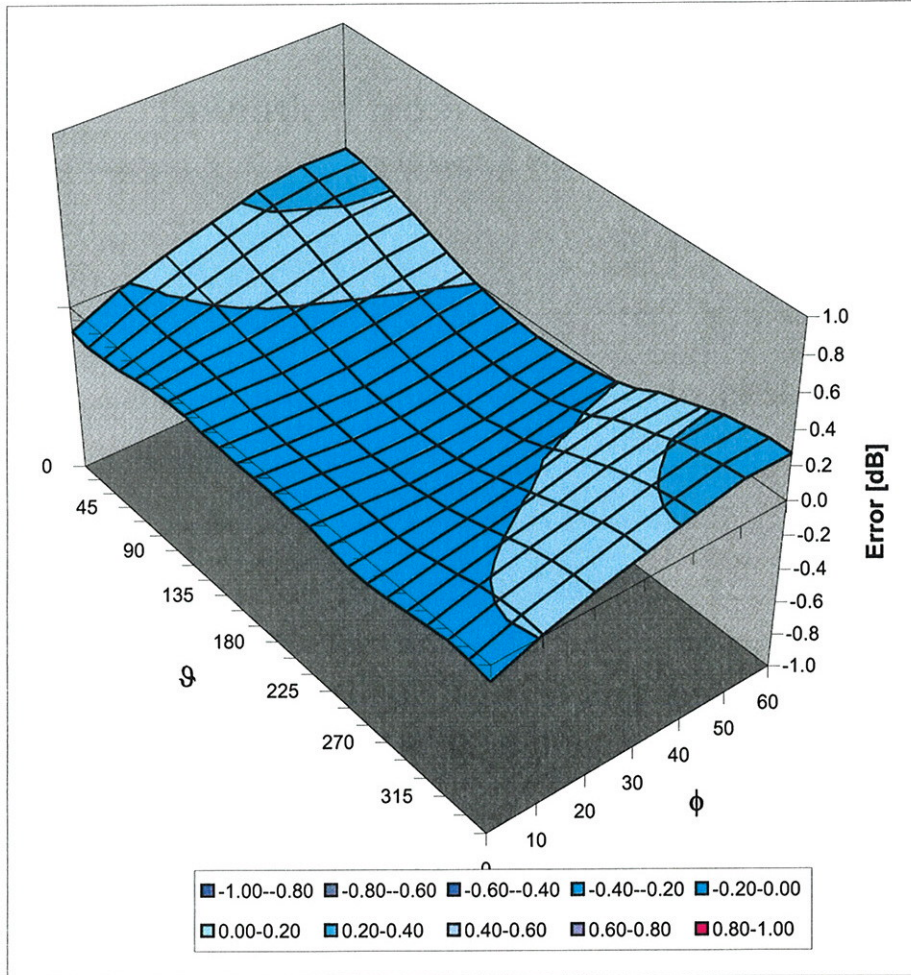

Uncertainty of Spherical Isotropy Assessment: $\pm 2.6\%$ ($k=2$)