



PCTEST ENGINEERING LABORATORY, INC.

6660-B Dobbin Road, Columbia, MD 21045 USA
Tel. 410.290.6652 / Fax 410.290.6554
<http://www.pctestlab.com>



CERTIFICATE OF COMPLIANCE FCC PART 15.407 (DFS Test Report)

Company Name:

Panasonic Corporation of North America
One Panasonic Way, 4B-8
Secaucus, NJ 07094
United States

Date of Testing:

June 4, 2007

Test Site/Location:

PCTEST Lab. Columbia, MD, USA

Test Report Serial No.:

0705140451.ACJ

| | |
|-----------------|---|
| FCC ID: | ACJ9TGCF-743 |
| COMPANY: | Panasonic Corporation of North America |

Model(s): CF-74
EUT Type: Toughbook Model CF-74
Type of Device: Client Only Device, No Radar Detection Capability
Frequency Range: 5260 – 5320 MHz (UNII-II Band)
Output Power: 19.69 dBm (0.093 W)
FCC Classification: Unlicensed National Information Infrastructure
FCC Rule Part(s): Part 15.407(UNII)
Class II Perm. Change: Add UNII high band
Original Grant Date: May 9, 2007

This equipment has been shown to be capable of compliance with the applicable technical standards as indicated in the measurement report and was tested in accordance with the measurement procedures specified in ANSI C63.4-2003 and FCC 06-96 Appendix B Compliance Measurement Procedures for Unlicensed-National Information Infrastructure Devices Operating in the 5.25 – 5.35 GHz and 5.47 – 5.725 GHz Bands Incorporating Dynamic Frequency Selection.

I attest to the accuracy of data. All measurements reported herein were performed by me or were made under my supervision and are correct to the best of my knowledge and belief. I assume full responsibility for the completeness of these measurements and vouch for the qualifications of all persons taking them.

PCTEST certifies that no party to this application has been denied the FCC benefits pursuant to Section 5301 of the Anti-Drug Abuse Act of 1988, 21 U.S.C. 862.

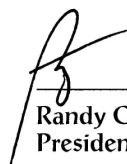

Randy Ortanez
President







| | | | | |
|------------------------------------|---|---|---|---------------------------------|
| FCC ID: ACJ9TGCF-743 |  | FCC Pt. 15.407 DFS TEST REPORT (CERTIFICATION) |  | Reviewed by: Quality Manager |
| Test Report S/N: 0705140451.ACJ | Test Dates: June 4, 2007 | EUT Type: Toughbook Model CF-74 | Page 1 of 17 | |

TABLE OF CONTENTS

| | | |
|--|--|----|
| FCC PART 15.407 MEASUREMENT REPORT..... | | 3 |
| 1.0 INTRODUCTION | | 4 |
| 1.1 SCOPE..... | | 4 |
| 1.2 EVALUATION PROCEDURE..... | | 4 |
| 1.3 SUMMARY OF TEST RESULTS..... | | 4 |
| 2.0 PRODUCT INFORMATION..... | | 5 |
| 2.1 EQUIPMENT DESCRIPTION | | 5 |
| 2.2 MODIFICATIONS..... | | 5 |
| 3.0 DESCRIPTION OF DYNAMIC FREQUENCY SELECTION TEST..... | | 6 |
| 3.1 APPLICABILITY..... | | 6 |
| 3.2 REQUIREMENTS | | 6 |
| 3.3 DFS DETECTION THRESHOLD VALUES..... | | 8 |
| 3.4 PARAMETERS OF DFS TEST SIGNALS..... | | 8 |
| 3.5 PROCEDURE..... | | 9 |
| 4.0 TEST EQUIPMENT | | 11 |
| 4.1 ADDITIONAL EQUIPMENT..... | | 11 |
| 5.0 TEST PLOTS AND DATA | | 12 |
| 6.0 CONCLUSION | | 17 |

| | | | | |
|---|---|---|---|---------------------------------|
| FCC ID: ACJ9TGCF-743 |  | FCC Pt. 15.407 DFS TEST REPORT (CERTIFICATION) |  | Reviewed by: Quality Manager |
| Test Report S/N: 0705140451.ACJ | Test Dates: June 4, 2007 | EUT Type: Toughbook Model CF-74 | Page 2 of 17 | |

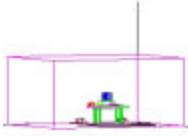

DFS MEASUREMENT REPORT

FCC Part 15.407

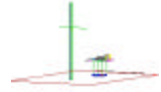

§ 2.1033 General Information

APPLICANT: Panasonic Corporation of North America
APPLICANT ADDRESS: One Panasonic Way, 4B-8
 Secaucus, NJ 07094, United States
TEST SITE: PCTEST ENGINEERING LABORATORY, INC.
TEST SITE ADDRESS: 6660-B Dobbin Road, Columbia, MD 21045 USA
FCC RULE PART(S): Part 15.407(h)
BASE MODEL : CF-74
FCC ID: ACJ9TGCF-743
Test Device Serial No.: N/A Production Pre-Production Engineering
DEVICE CLASSIFICATION: Client Only, No Radar Detection
DATE(S) OF TEST: June 4, 2007
TEST REPORT S/N: 0705140451.ACJ

Test Facility / Accreditations

Measurements were performed at PCTEST Engineering Lab located in Columbia, MD 21045, U.S.A.

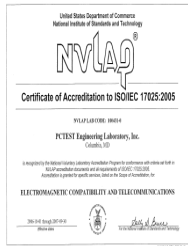

- PCTEST facility is an FCC registered (PCTEST Reg. No. 90864) test facility with the site description report on file and has met all the requirements specified in Section 2.948 of the FCC Rules and Industry Canada (IC-2451).
- PCTEST Lab is accredited to ISO 17025 by U.S. National Institute of Standards and Technology (NIST) under the National Voluntary Laboratory Accreditation Program (NVLAP Lab code: 100431-0) in EMC, FCC and Telecommunications.
- PCTEST Lab is accredited to ISO 17025-2005 by the American Association for Laboratory Accreditation (A2LA) in Specific Absorption Rate (SAR) testing, Hearing Aid Compatibility (HAC) testing, CTIA Test Plans, and wireless testing for FCC and Industry Canada Rules.
- PCTEST Lab is a recognized U.S. Conformity Assessment Body (CAB) in EMC and R&TTE (n.b. 0982) under the U.S.-EU Mutual Recognition Agreement (MRA).
- PCTEST TCB is a Telecommunication Certification Body (TCB) accredited to ISO/IEC Guide 65 by the American National Standards Institute (ANSI) in all scopes of FCC Rules and Industry Canada Standards (RSS).
- PCTEST facility is an IC registered (IC-2451) test laboratory with the site description on file at Industry Canada.
- PCTEST is a CTIA Authorized Test Laboratory (CATL) for AMPS, CDMA, and EvDO wireless devices and for Over-the-Air (OTA) Antenna Performance testing for AMPS, CDMA, GSM, GPRS, EGPRS, UMTS (W-CDMA), CDMA 1xEVDO, and CDMA 1xRTT.

| | | | | |
|---|------------------------------------|---|--------------|--|
| FCC ID: ACJ9TGCF-743 | | FCC Pt. 15.407 DFS TEST REPORT (CERTIFICATION) | | Reviewed by: Quality Manager |
| Test Report S/N: 0705140451.ACJ | Test Dates: June 4, 2007 | EUT Type: Toughbook Model CF-74 | Page 3 of 17 | |

1.0 INTRODUCTION

1.1 Scope

This report has been prepared to demonstrate compliance with the requirements for Dynamic Frequency Selection (DFS) as stated in FCC 06-96. Testing was performed on the Panasonic Corporation of North America CF-74 in accordance with the measurement procedure described in Appendix B of FCC 06-96. As of July 20, 2007 all devices operating in the 5250 – 5350 MHz and/or the 5470 – 5725 MHz bands must comply with the DFS requirements. As the EUT does not have radar detection capability it was evaluated as a Client Only Device.

All test results reported herein are applicable to the sample selected for testing. The unit used for testing was supplied by Panasonic Corporation of North America.

1.2 Evaluation Procedure

A radiated test methodology was used for the DFS evaluation procedure of the **Toughbook Model CF-74**.



No deviations to the test procedure and test methods occurred during the evaluation of the EUT.

1.3 Summary of Test Results

The **Toughbook Model CF-74** was found to be compliant with the requirements for DFS as required for a Client Device per Part 15.407(h) and FCC 06-96. The following table lists the measured parameters and the actual data and plots can be found in Section 5.0 of this report.

| Parameter | Measured | Limit | Result |
|-----------------------------------|---|---|--------|
| Channel Move Time | 451.67 ms | 10 seconds | Pass |
| Channel Closing Transmission Time | < 200ms + 651.84 ms (aggregate) | 200ms + aggregate of 60ms over remaining 10 second period | Pass |
| Non-occupancy Period | Monitored > 30 minutes (No transmission occurred) | 30 minutes | Pass |

Table 1-1. DFS Test Results Summary

| | | | | |
|------------------------------------|---|---|---|---------------------------------|
| FCC ID: ACJ9TGCF-743 |  | FCC Pt. 15.407 DFS TEST REPORT (CERTIFICATION) |  | Reviewed by: Quality Manager |
| Test Report S/N: 0705140451.ACJ | Test Dates: June 4, 2007 | EUT Type: Toughbook Model CF-74 | Page 4 of 17 | |

2.0 PRODUCT INFORMATION

2.1 Equipment Description

The Equipment Under Test (EUT) is the **Panasonic Toughbook Model CF-74 FCC ID: ACJ9TGCF-743**. Table 2-1 lists the manufacturer and model number of the WLAN card contained in the EUT.

| Manufacturer | Model | FCC ID: | Driver Version | Description |
|--------------|--------|-----------|----------------|------------------------|
| Intel | 4965AG | PD94965AG | 11.1.0.86 | 802.11ag Wireless Card |

Table 2-1. EUT Equipment Description



Mode of Operation:

| | |
|------------------------------------|-------------------------------------|
| Master Device | <input type="checkbox"/> |
| Client Device (No radar detection) | <input checked="" type="checkbox"/> |
| Client Device with Radar Detection | <input type="checkbox"/> |

| Parameters of EUT: | |
|--------------------------|-----------------------------------|
| Frequency | 5260 – 5320 MHz |
| Output Power: | 19.69 dBm (0.093 W) |
| Driver Software Version: | 11.1.0.86 |
| Modulation: | OFDM |
| Data Rates Supported: | 54, 48, 36, 24, 18, 12, 9, 6 Mbps |
| Number of Channels: | 4 (5260, 5280, 5300, 5320) |
| Channel Bandwidth: | 20 MHz |

2.2 Modifications

No modifications to the EUT were required in order to comply with the DFS specifications.

| | | | | |
|------------------------------------|---|---|---|---------------------------------|
| FCC ID: ACJ9TGCF-743 |  | FCC Pt. 15.407 DFS TEST REPORT (CERTIFICATION) |  | Reviewed by: Quality Manager |
| Test Report S/N: 0705140451.ACJ | Test Dates: June 4, 2007 | EUT Type: Toughbook Model CF-74 | Page 5 of 17 | |

3.0 DESCRIPTION OF DYNAMIC FREQUENCY SELECTION TEST

3.1 Applicability

The following table from FCC 06-96 lists the applicable requirements for the DFS testing. The device evaluated in this report is considered a client device without radar detection capability.

| Requirement | Operational Mode | | |
|---------------------------------|------------------|--------------------------------|-----------------------------|
| | Master | Client Without Radar Detection | Client With Radar Detection |
| Non-Occupancy Period | Yes | Not required | Yes |
| DFS Detection Threshold | Yes | Not required | Yes |
| Channel Availability Check Time | Yes | Not required | Not required |
| Uniform Spreading | Yes | Not required | Not required |
| U-NII Detection Bandwidth | Yes | Not required | Yes |

Table 3-1. DFS Applicability



| Requirement | Operational Mode | | |
|-----------------------------------|------------------|--------------------------------|-----------------------------|
| | Master | Client Without Radar Detection | Client With Radar Detection |
| DFS Detection Threshold | Yes | Not required | Yes |
| Channel Closing Transmission Time | Yes | Yes | Yes |
| Channel Move Time | Yes | Yes | Yes |
| U-NII Detection Bandwidth | Yes | Not required | Yes |

Table 3-2. DFS Applicability During Normal Operation

3.2 Requirements

Per FCC 06-96 the following are the requirements for Client Devices:

- a) A Client Device will not transmit before having received appropriate control signals from a Master Device.
- b) A Client Device will stop all its transmissions whenever instructed by a Master Device to which it is associated and will meet the Channel Move Time and Channel Closing Transmission Time requirements.

| | | | | |
|------------------------------------|---|---|---|---------------------------------|
| FCC ID: ACJ9TGCF-743 |  | FCC Pt. 15.407 DFS TEST REPORT (CERTIFICATION) |  | Reviewed by: Quality Manager |
| Test Report S/N: 0705140451.ACJ | Test Dates: June 4, 2007 | EUT Type: Toughbook Model CF-74 | Page 6 of 17 | |



The Client Device will not resume any transmissions until it has again received control signals from a Master Device.

- c) If a Client Device is performing In-Service Monitoring and detects a Radar Waveform above the DFS Detection Threshold, it will inform the Master Device. This is equivalent to the Master Device detecting the Radar Waveform and d) through f) of section 5.1.1 apply.
- d) Irrespective of Client Device or Master Device detection the Channel Move Time and Channel Closing Transmission Time requirements remain the same.

Channel Move Time and Channel Closing Transmission Time requirements are listed in the following table.

| Parameter | Value |
|---|--|
| Non-occupancy period | Minimum 30 minutes |
| Channel Availability Check Time | 60 seconds |
| Channel Move Time | 10 seconds See Note 1. |
| Channel Closing Transmission Time | 200 milliseconds + an aggregate of 60 milliseconds over remaining 10 second period. See Notes 1 and 2. |
| U-NII Detection Bandwidth | Minimum 80% of the U-NII 99% transmission power bandwidth. See Note 3. |
| <p>Note 1: The instant that the Channel Move Time and the Channel Closing Transmission Time begins is as follows:</p> <ul style="list-style-type: none"> • For the Short Pulse Radar Test Signals this instant is the end of the Burst. • For the Frequency Hopping radar Test Signal, this instant is the end of the last radar Burst generated. • For the Long Pulse Radar Test Signal this instant is the end of the 12 second period defining the Radar Waveform. <p>Note 2: The Channel Closing Transmission Time is comprised of 200 milliseconds starting at the beginning of the Channel Move Time plus any additional intermittent control signals required to facilitate a Channel move (an aggregate of 60 milliseconds) during the remainder of the 10 second period. The aggregate duration of control signals will not count quiet periods in between transmissions.</p> <p>Note 3: During the U-NII Detection Bandwidth detection test, radar type 1 is used and for each frequency step the minimum percentage of detection is 90 percent. Measurements are performed with no data traffic.</p> | |

Table 3-3: DFS Response Requirements

| | | | | |
|------------------------------------|-----------------------------|---|--------------|---------------------------------|
| FCC ID: ACJ9TGCF-743 | | FCC Pt. 15.407 DFS TEST REPORT (CERTIFICATION) | | Reviewed by: Quality Manager |
| Test Report S/N: 0705140451.ACJ | Test Dates: June 4, 2007 | EUT Type: Toughbook Model CF-74 | Page 7 of 17 | |

3.3 DFS Detection Threshold Values

The DFS detection thresholds are defined for Master devices and Client Devices with In-service monitoring. These detection thresholds are listed in the following table.

| Maximum Transmit Power | Value (See Notes 1 and 2) |
|--|------------------------------|
| = 200 milliwatt | -64 dBm |
| < 200 milliwatt | -62 dBm |
| Note 1: This is the level at the input of the receiver assuming a 0 dBi receive antenna. Note 2: Throughout these test procedures an additional 1 dB has been added to the amplitude of the test transmission waveforms to account for variations in measurement equipment. This will ensure that the test signal is at or above the detection threshold level to trigger a DFS response. | |

Table 3-4: Detection Thresholds for Master Devices and Client Devices with Radar Detection

3.4 Parameters of DFS Test Signals



As the EUT is a Client Device with no Radar Detection only one type radar pulse is required for the testing. Radar Pulse type 1 was used in the evaluation of the Client device for the purpose of measuring the Channel Move Time and the Channel Closing Transmission Time. Table 3-5 lists the parameters for the Short Pulse Radar Waveforms. A plot of the Radar Pulse Type 1 used for testing is included in Section 5.0 of this report.

| Radar Type | Pulse Width (μ sec) | PRI (μ sec) | Number of Pulses | Minimum Percentage of Successful Detection | Minimum Number of Trials |
|-----------------------------|-----------------------------|---------------------|------------------------|---|--------------------------------|
| 1 | 1 | 1428 | 18 | 60% | 30 |
| 2 | 1-5 | 150-230 | 23-29 | 60% | 30 |
| 3 | 6-10 | 200-500 | 16-18 | 60% | 30 |
| 4 | 11-20 | 200-500 | 12-16 | 60% | 30 |
| Aggregate (Radar Types 1-4) | | | | 80% | 120 |

Table 3-5: Parameters for Short Pulse Radar Waveforms

| Radar Type | Pulse Width (μ sec) | Chirp Width (MHz) | PRI (μ sec) | Number of Pulses per <i>Burst</i> | Number of <i>Bursts</i> | Minimum Percentage of Successful Detection | Minimum Number of Trials |
|------------|-----------------------------|----------------------|---------------------|---|----------------------------|---|--------------------------------|
| 5 | 50 - 100 | 5 - 20 | 5 - 20 | 1 - 3 | 8 - 20 | 60% | 30 |

Table 3-6. Parameters for Long Pulse Radar Waveforms

| | | | | |
|------------------------------------|---|---|---|---------------------------------|
| FCC ID: ACJ9TGCF-743 |  | FCC Pt. 15.407 DFS TEST REPORT (CERTIFICATION) |  | Reviewed by: Quality Manager |
| Test Report S/N: 0705140451.ACJ | Test Dates: June 4, 2007 | EUT Type: Toughbook Model CF-74 | Page 8 of 17 | |

| Radar Type | Pulse Width (μsec) | PRI (μsec) | Pulses per Hop | Hopping Rate (kHz) | Hopping Sequence Length (msec) | Minimum Percentage of Successful Detection | Minimum Number of Trials |
|------------|--------------------|------------|----------------|--------------------|--------------------------------|--|--------------------------|
| 6 | 1 | 333 | 9 | 0.333 | 300 | 70% | 30 |

Table 3-7. Parameters for Frequency Hopping Radar Waveforms

3.5 Procedure

The FCC 06-96 describes a radiated test setup and a conducted test setup. A radiated test setup was used for this testing. Figure 3-1 shows the typical test setup. One channel selected between 5260 and 5350 MHz is chosen for the testing.

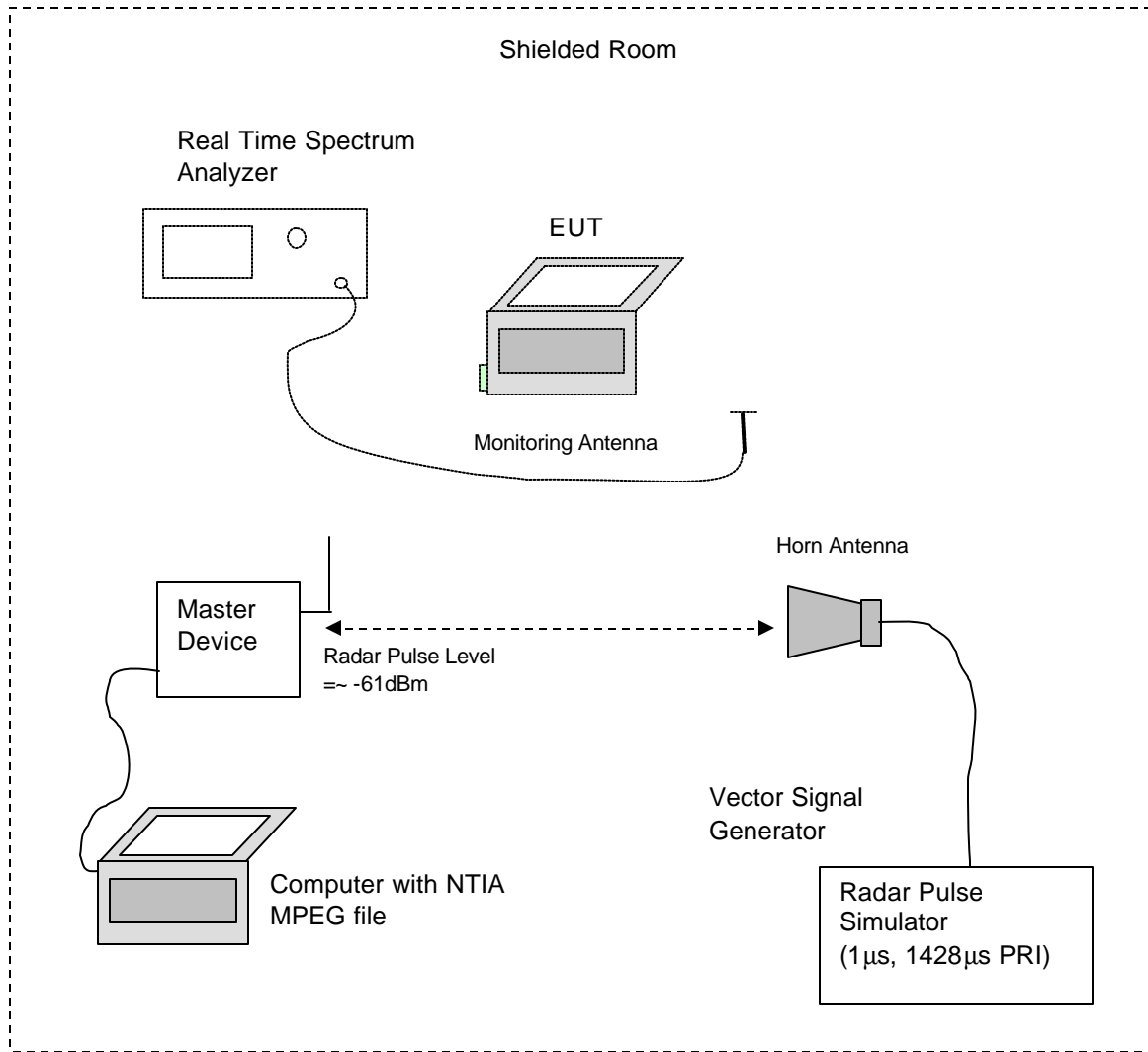



Figure 3-1. Radiated Test Setup for DFS

| | | | | |
|------------------------------------|-----------------------------|---|--|---------------------------------|
| FCC ID: ACJ9TGCF-743 | | FCC Pt. 15.407 DFS TEST REPORT (CERTIFICATION) | | Reviewed by: Quality Manager |
| Test Report S/N: 0705140451.ACJ | Test Dates: June 4, 2007 | EUT Type: Toughbook Model CF-74 | | Page 9 of 17 |

1. The radar pulse generator is setup to provide a pulse at the frequency that the Master and Client are operating. A Type 1 radar pulse with a 1μs pulse width and a 1428μs PRI is used for the testing.
2. The vector signal generator is adjusted to provide the radar burst (18 pulses) at a level of approximately -62dBm at the antenna of the Master device.
3. A trigger is provided from the pulse generator to the DFS monitoring system in order to capture the traffic and the occurrence of the radar pulse.
4. The Client Device (EUT) is set up per the diagram in Figure 3-1 and communications between the Master device and the Client is established.
5. The MPEG file specified by the FCC (“6 ½ *Magic Hours*”) is streamed from the “file computer” through the Master to the Slave Device and played in full motion video using Media Player Classic Version. 6.4.8.6 in order to properly load the network.
6. The real time spectrum analyzer is set to record a 16sec window to any transmissions occurring up to and after 10sec.
7. The system is again setup and the monitoring time is shortened in order to capture the Channel Closing Transmission Time. This time is measured to insure that the Client ceases transmission within 200ms and the aggregate of emissions occurring after 200ms up to 10 sec do not exceed 60ms.

(Note: the channel may be different since the Master and Client have changed channels due to the detection of the initial radar pulse.)

8. After the initial radar burst the channel is monitored for 30 minutes to insure no transmissions occur.

| | | | | |
|------------------------------------|---|------------------------------------|---|---------------------------------|
| FCC ID: ACJ9TGCF-743 |  FCC Pt. 15.407 DFS TEST REPORT (CERTIFICATION) | |  | Reviewed by: Quality Manager |
| Test Report S/N: 0705140451.ACJ | Test Dates: June 4, 2007 | EUT Type: Toughbook Model CF-74 | | Page 10 of 17 |

4.0 TEST EQUIPMENT

Test Equipment Calibration is traceable to the National Institute of Standards and Technology (NIST).

| Manufacturer | Model / Equipment | Calibration Date | Cal Interval | Calibration Due | Serial No. |
|--------------|--|------------------|--------------|-----------------|------------|
| EMCO | Model 3115 (1-18GHz) Horn Antenna | 08/24/06 | Biennial | 08/23/08 | 9203-2178 |
| EMCO | Model 3115 (1-18GHz) Horn Antenna | 08/25/06 | Biennial | 08/24/08 | 9704-5182 |
| Agilent | Model E8267C Vector Signal Generator | 05/07/07 | Annual | 05/07/08 | US42340152 |
| Tektronix | RSA 6114A Real Time Spectrum Analyzer | 02/21/07 | Annual | 02/21/08 | 3144A02458 |
| Agilent | PSA E4448A (3Hz-50GHz) Spectrum Analyzer | 09/22/06 | Annual | 09/22/07 | US42510244 |



Table 4-1. Annual Test Equipment Calibration Schedule

4.1 Additional Equipment

The following equipment was used in support of the DFS testing.

| Device | Manufacturer | Model/Description | Description | S/N: | FCC ID: |
|--------|---------------|---------------------------|--------------|-------------|-----------|
| Master | Cisco Systems | Aironet AIR-AP1242AG-A-K9 | Access Point | FTX1114B151 | LDK102056 |

Table 4-2. Support Equipment

| | | | | |
|------------------------------------|---|---|---|---------------------------------|
| FCC ID: ACJ9TGCF-743 |  | FCC Pt. 15.407 DFS TEST REPORT (CERTIFICATION) |  | Reviewed by: Quality Manager |
| Test Report S/N: 0705140451.ACJ | Test Dates: June 4, 2007 | EUT Type: Toughbook Model CF-74 | Page 11 of 17 | |

5.0 TEST PLOTS AND DATA

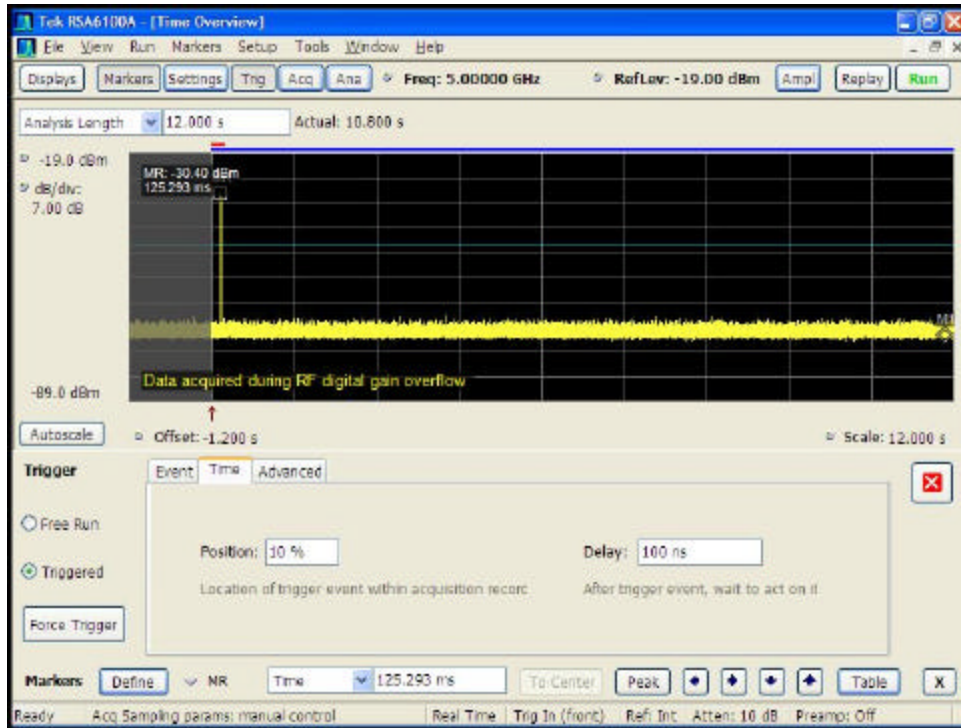

Figure 5-1. Type 1 Radar Pulse

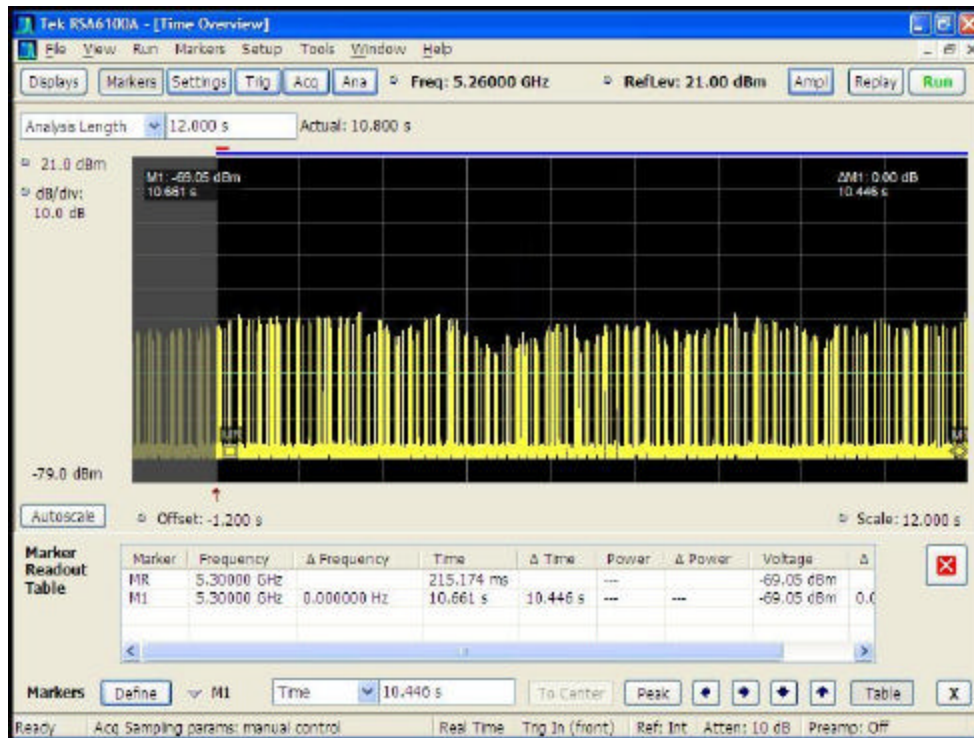

Figure 5-2. Time Display WLAN Channel Traffic (Streaming Video)

| | | | | |
|------------------------------------|-----------------------------|---|--|---------------------------------|
| FCC ID: ACJ9TGCF-743 | | FCC Pt. 15.407 DFS TEST REPORT (CERTIFICATION) | | Reviewed by: Quality Manager |
| Test Report S/N: 0705140451.ACJ | Test Dates: June 4, 2007 | EUT Type: Toughbook Model CF-74 | | Page 12 of 17 |

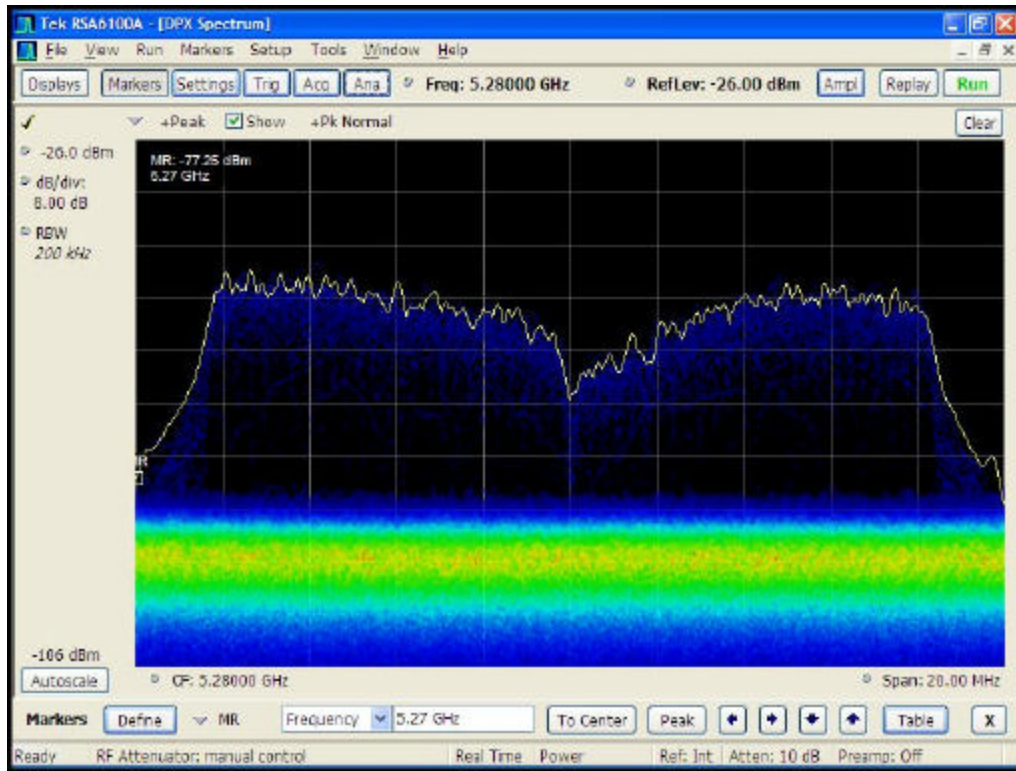

Figure 5-3. Real-Time Spectrum Display, No WLAN Traffic

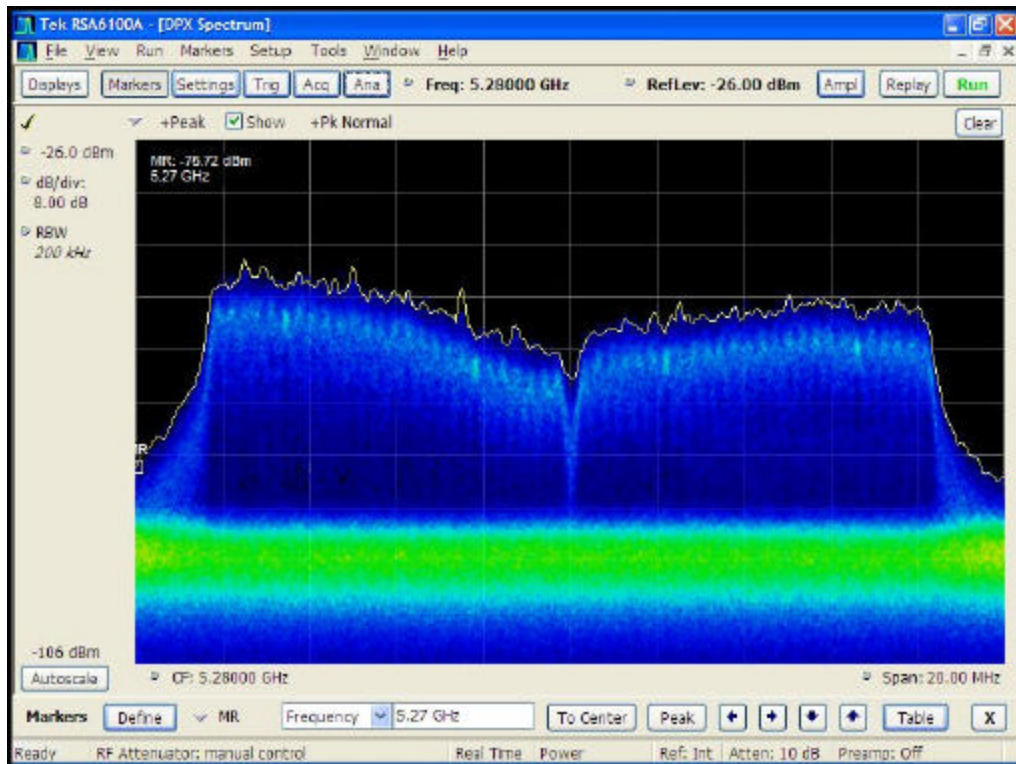

Figure 5-4. Real-Time Spectrum Display, WLAN Traffic (Streaming Video)

| | | | | |
|------------------------------------|-----------------------------|---|--|---------------------------------|
| FCC ID: ACJ9TGCF-743 | | FCC Pt. 15.407 DFS TEST REPORT (CERTIFICATION) | | Reviewed by: Quality Manager |
| Test Report S/N: 0705140451.ACJ | Test Dates: June 4, 2007 | EUT Type: Toughbook Model CF-74 | | Page 13 of 17 |

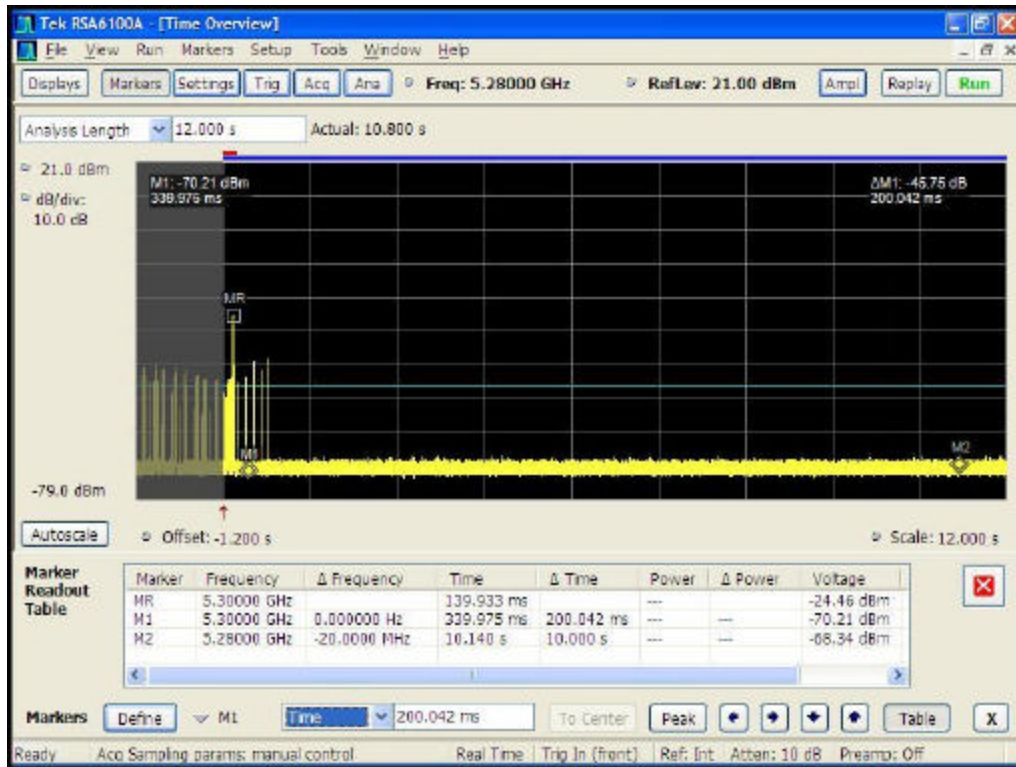

Figure 5-5. Channel Move Time (< 10sec)

Marker Descriptions:

MR = End of Radar Burst

M1 = 200ms from end of Radar Burst

M2 = 10sec from end of Burst

| | | | | |
|------------------------------------|-----------------------------|---|--|---------------------------------|
| FCC ID: ACJ9TGCF-743 | | FCC Pt. 15.407 DFS TEST REPORT (CERTIFICATION) | | Reviewed by: Quality Manager |
| Test Report S/N: 0705140451.ACJ | Test Dates: June 4, 2007 | EUT Type: Toughbook Model CF-74 | | Page 14 of 17 |

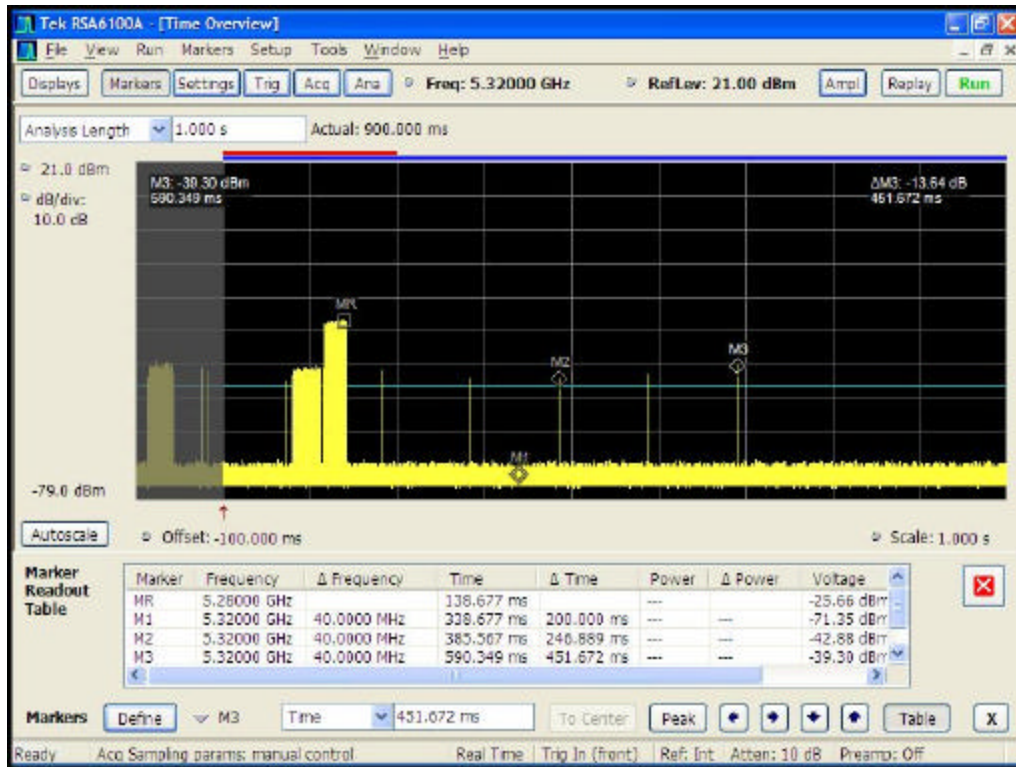

Figure 5-6. Channel Closing Transmission Time, Aggregate Time After 200ms

Calculation of Aggregate Time:

Pulse width = 217.28 μ s (Reference Figure 5-7)

Number of pulses occurring after 200ms from end of burst = 3

Aggregate time from 200ms to 10sec after burst = 3 x 217.28 μ s = 651.84 μ s

Aggregate Time: 651.84 μ s

Limit: 60ms

| | | | | |
|------------------------------------|-----------------------------|---|--|---------------------------------|
| FCC ID: ACJ9TGCF-743 | | FCC Pt. 15.407 DFS TEST REPORT (CERTIFICATION) | | Reviewed by: Quality Manager |
| Test Report S/N: 0705140451.ACJ | Test Dates: June 4, 2007 | EUT Type: Toughbook Model CF-74 | | Page 15 of 17 |

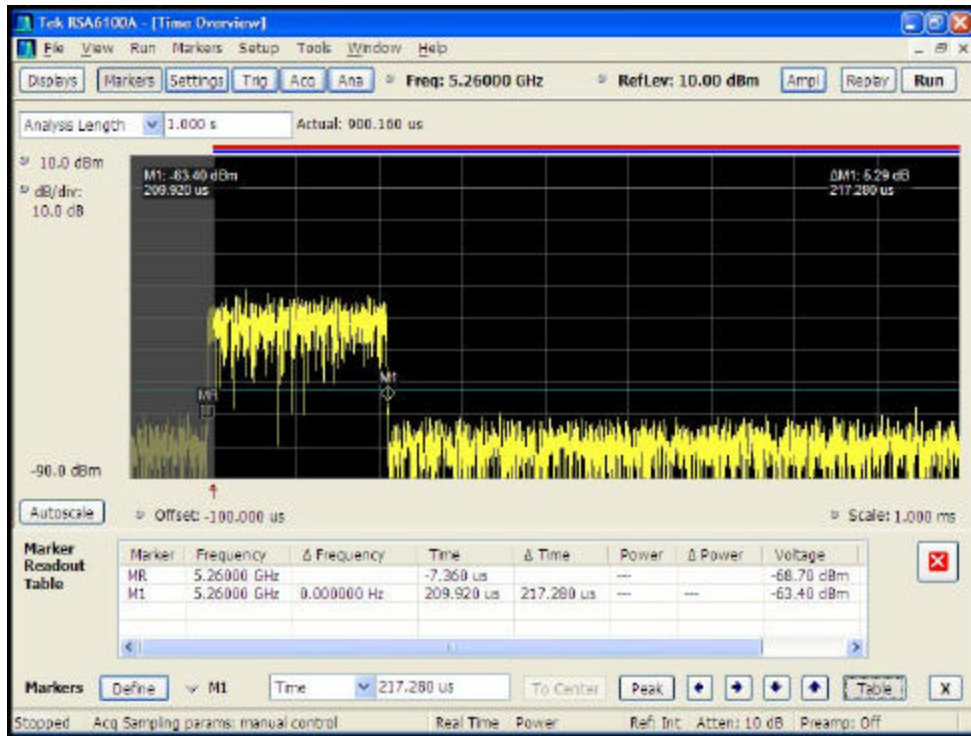

Figure 5-7. Pulse Width After 200ms

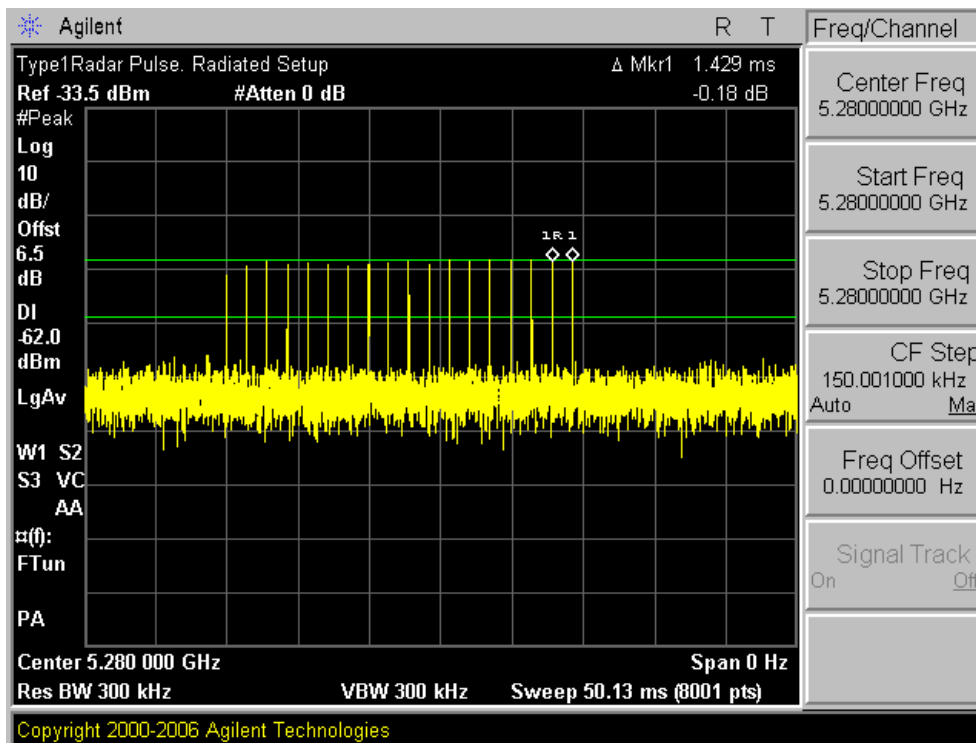



Figure 5-8. Radar Type1 Pulse

| | | | | |
|------------------------------------|-----------------------------|---|--|---------------------------------|
| FCC ID: ACJ9TGCF-743 | | FCC Pt. 15.407 DFS TEST REPORT (CERTIFICATION) | | Reviewed by: Quality Manager |
| Test Report S/N: 0705140451.ACJ | Test Dates: June 4, 2007 | EUT Type: Toughbook Model CF-74 | | Page 16 of 17 |

6.0 CONCLUSION

The data collected relate only to the item(s) tested and show that the Panasonic **Toughbook Model CF-74** **FCC ID: ACJ9TGCF-743** is in compliance with the DFS requirements for a Client Device without radar detection in accordance with Part 15.407 of the FCC Rules.

| | | | | |
|------------------------------------|---|---|---|---------------------------------|
| FCC ID: ACJ9TGCF-743 |  | FCC Pt. 15.407 DFS TEST REPORT (CERTIFICATION) |  | Reviewed by: Quality Manager |
| Test Report S/N: 0705140451.ACJ | Test Dates: June 4, 2007 | EUT Type: Toughbook Model CF-74 | Page 17 of 17 | |