

## Supplementary Instructions for EDGE Modem

Model No. **CF-18/CF-29/CF-73 Series**

This manual contains supplementary instructions regarding the use of the computer. It explains the cases where the operation of the computer differs from that in the Operating Instructions.

Your computer is equipped with EDGE modem enabling you to communicate using radio frequencies.

### Contents

Precautions .....	2
Names and Functions of Parts .....	6
Installing/Removing a SIM Card .....	9
Installing the Software .....	11
Appendix.....	14
Specifications .....	15

### Illustrations and Terminology in this Manual

**NOTE:**

**CAUTION:**

**NOTE** provides a useful fact or helpful information.

**CAUTION** indicates a condition that may result in minor or moderate injury.

**Windows XP**

: Information for Microsoft® Windows® XP Professional Service Pack 2 with Advanced Security Technologies users.

**Tablet PC**

: Information for Microsoft® Windows® XP Tablet PC Edition 2005 users.

[start] - [Run]: This illustration means to click [start], then to click [Run].  
(For some applications, you may need to double-click.)

- About the abbreviations in this manual, refer to the table on page 14.

# Precautions

## Safety Precautions

The following safety precautions must be observed during all phases of the operation, usage, service or repair of any Personal Computer or Handheld Computer incorporating EDGE modem. Manufacturers of the cellular terminal are advised to convey the following safety information to users and operating personnel and to incorporate these guidelines into all manuals supplied with the product. Failure to comply with these precautions violates safety standards of design, manufacture and intended use of the product. Panasonic assumes no liability for customer failure to comply with these precautions.



When in a hospital or other health care facility, observe the restrictions on the use of mobiles. Switch Personal Computer or Handheld Computer incorporating EDGE modem off, if instructed to do so by the guidelines posted in sensitive areas. Medical equipment may be sensitive to RF energy.

The operation of cardiac pacemakers, other implanted medical equipment and hearing aids can be affected by interference from Personal Computer or Handheld Computer incorporating EDGE modem placed close to the device. If in doubt about potential danger, contact the physician or the manufacturer of the device to verify that the equipment is properly shielded. Pacemaker patients are advised to keep their Personal Computer or Handheld Computer incorporating EDGE modem away from the pacemaker, while it is on.



Switch off Personal Computer or Handheld Computer incorporating EDGE modem before boarding an aircraft. Make sure it cannot be switched on inadvertently. The operation of wireless appliances in an aircraft is forbidden to prevent interference with communications systems. Failure to observe these instructions may lead to the suspension or denial of cellular services to the offender, legal action, or both.



Do not operate Personal Computer or Handheld Computer incorporating EDGE modem in the presence of flammable gases or fumes. Switch off the cellular terminal when you are near petrol stations, fuel depots, chemical plants or where blasting operations are in progress. Operation of any electrical equipment in potentially explosive atmospheres can constitute a safety hazard.



Your Personal Computer or Handheld Computer incorporating EDGE modem receives and transmits radio frequency energy while switched on. Remember that interference can occur if it is used close to TV sets, radios, computers or inadequately shielded equipment. Follow any special regulations and always switch off Personal Computer or Handheld Computer incorporating EDGE modem wherever forbidden, or when you suspect that it may cause interference or danger.



Road safety comes first! Do not use a Personal Computer or Handheld Computer incorporating EDGE modem while driving a vehicle. Do not place the computer with EDGE modem in an area where it could cause personal injury to the driver or passengers. It is recommended to stow the unit in the boot or secure stowage area while driving.

---

Do not place the computer with EDGE modem in an area over an air bag or in the vicinity where an air bag may deploy.

Air bags inflate with great force and if the computer with EDGE modem is placed in the air bag deployment area may be propelled with great force and cause serious injury to occupants of the vehicle.

SOS

**IMPORTANT!**

Personal Computer or Handheld Computer incorporating EDGE modem operate using radio signals and cellular networks cannot be guaranteed to connect in all conditions. Therefore, you should never rely solely upon any wireless device for essential communications, for example emergency calls.

Remember, in order to make or receive calls, Personal Computer or Handheld Computer incorporating EDGE modem must be switched on and in a service area with adequate cellular signal strength.

Some networks do not allow for emergency calls if certain network services or phone features are in use (e.g. lock functions, fixed dialing etc.). You may need to deactivate those features before you can make an emergency call.

Some networks require that a valid SIM card be properly inserted in Personal Computer or Handheld Computer incorporating EDGE modem.

# Precautions

## For U.S.A.

### <CF-18 Series>

#### Federal Communications Commission Radio Frequency Interference Statement

Note: This equipment has been tested and found to comply with the limits for a Class B digital device, pursuant to Part 15 of the FCC Rules. These limits are designed to provide reasonable protection against harmful interference in a residential installation. This equipment generates, uses and can radiate radio frequency energy and, if not installed and used in accordance with the instructions, may cause harmful interference to radio communications. However, there is no guarantee that interference will not occur in a particular installation. If this equipment does cause harmful interference to radio or television reception, which can be determined by turning the equipment off and on, the user is encouraged to try to correct the interference by one or more of the following measures:

- Reorient or relocate the receiving antenna.
- Increase the separation between the equipment and receiver.
- Connect the equipment into an outlet on a circuit different from that to which the receiver is connected.
- Consult the Panasonic Service Center or an experienced radio/TV technician for help.

#### Warning

To assure continued compliance, use only shielded interface cables when connecting to a computer or peripheral. Also, any changes or modifications not expressly approved by the party responsible for compliance could void the user's authority to operate this equipment.

FCC RF Exposure Warning:

- This equipment is provided with PC Card slot that could be used with wireless transmitters, which will be specifically recommended when they become available. Other third-party wireless transmitters have not been RF exposure evaluated for use with this computer and may not comply with FCC RF exposure requirements.
- This equipment complies with FCC radiation exposure limits set forth for an uncontrolled environment.
- This equipment has been approved for portable operation, and unless otherwise advised in separate supplemental instructions for individual wireless transmitter(s), requires minimum 1.5 cm spacing be provided between antenna(s) and all person's body (excluding extremities of hands, wrist and feet) during wireless modes of operation.
- This equipment may use multiple installed transmitters, which may be capable of simultaneous transmission.
- This equipment is provided with external antenna connector(s) for connection to optional Car Mounter or Port Replicator for mobile external mounted antenna(s). External antenna(s) must be professionally installed and cannot exceed recommended maximum antenna gain as described in individual provided supplement instructions for wireless transmitters. Also, user must maintain minimum 20 cm spacing between external antenna(s) and all person's body (excluding extremities of hands, wrist and feet) during wireless modes of operation.

This device complies with Part 15 of the FCC Rules. Operation is subject to the following two conditions:

- (1) This device may not cause harmful interference, and
- (2) This device must accept any interference received, including interference that may cause undesired operation.

Responsible Party: Panasonic Corporation of North America  
One Panasonic Way  
Secaucus, NJ 07094  
Tel No: 1-800-LAPTOP5 (1-800-527-8675)

---

## <CF-29/CF-73 Series>

### Federal Communications Commission Radio Frequency Interference Statement

Note: This equipment has been tested and found to comply with the limits for a Class B digital device, pursuant to Part 15 of the FCC Rules. These limits are designed to provide reasonable protection against harmful interference in a residential installation. This equipment generates, uses and can radiate radio frequency energy and, if not installed and used in accordance with the instructions, may cause harmful interference to radio communications. However, there is no guarantee that interference will not occur in a particular installation. If this equipment does cause harmful interference to radio or television reception, which can be determined by turning the equipment off and on, the user is encouraged to try to correct the interference by one or more of the following measures:

- Reorient or relocate the receiving antenna.
- Increase the separation between the equipment and receiver.
- Connect the equipment into an outlet on a circuit different from that to which the receiver is connected.
- Consult the Panasonic Service Center or an experienced radio/TV technician for help.

### Warning

To assure continued compliance, use only shielded interface cables when connecting to a computer or peripheral. Also, any changes or modifications not expressly approved by the party responsible for compliance could void the user's authority to operate this equipment.

### FCC RF Exposure Warning:

- This equipment is provided with PC Card slot that could be used with wireless transmitters, which will be specifically recommended when they become available.  
Other third-party wireless transmitters have not been RF exposure evaluated for use with this computer and may not comply with FCC RF exposure requirements.
- This equipment complies with FCC radiation exposure limits set forth for an uncontrolled environment.
- This equipment has been approved for mobile operation, and unless otherwise advised in separate supplemental instructions for individual wireless transmitter(s), requires minimum 20 cm spacing be provided between antenna(s) and all person's body (excluding extremities of hands, wrist and feet) during wireless modes of operation.
- This equipment may use multiple installed transmitters, which may be capable of simultaneous transmission.
- <CF-29 Series>

This equipment is provided with external antenna connector(s) for connection to optional Car Mounter or Port Replicator for mobile external mounted antenna(s). External antenna(s) must be professionally installed and cannot exceed recommended maximum antenna gain as described in individual provided supplement instructions for wireless transmitters. Also, user must maintain minimum 20 cm spacing between external antenna(s) and all person's body (excluding extremities of hands, wrist and feet) during wireless modes of operation.

This device complies with Part 15 of the FCC Rules. Operation is subject to the following two conditions:

- (1) This device may not cause harmful interference, and
- (2) This device must accept any interference received, including interference that may cause undesired operation.

Responsible Party: Panasonic Corporation of North America  
One Panasonic Way  
Secaucus, NJ 07094  
Tel No: 1-800-LAPTOP5 (1-800-527-8675)

# Names and Functions of Parts

Except the followings, refer to the Operating Instructions for the computer.

## <CF-18 Series>

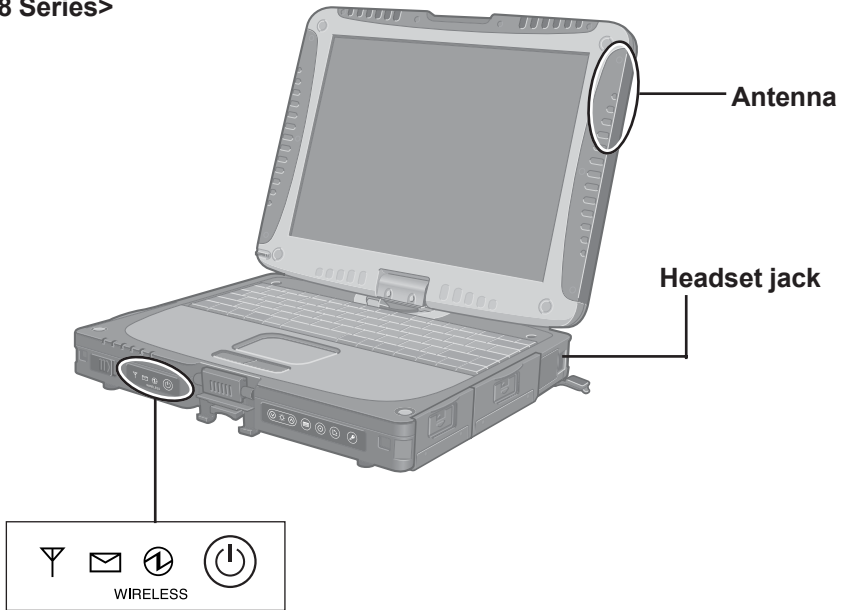

### LED Indicators

(☞ page 8)

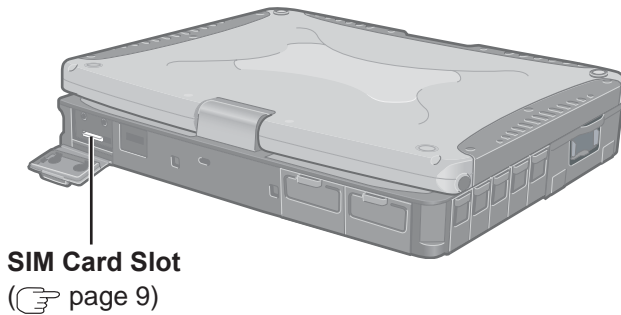

(Appearance may differ depending on specifications.)

---

<CF-29 Series>

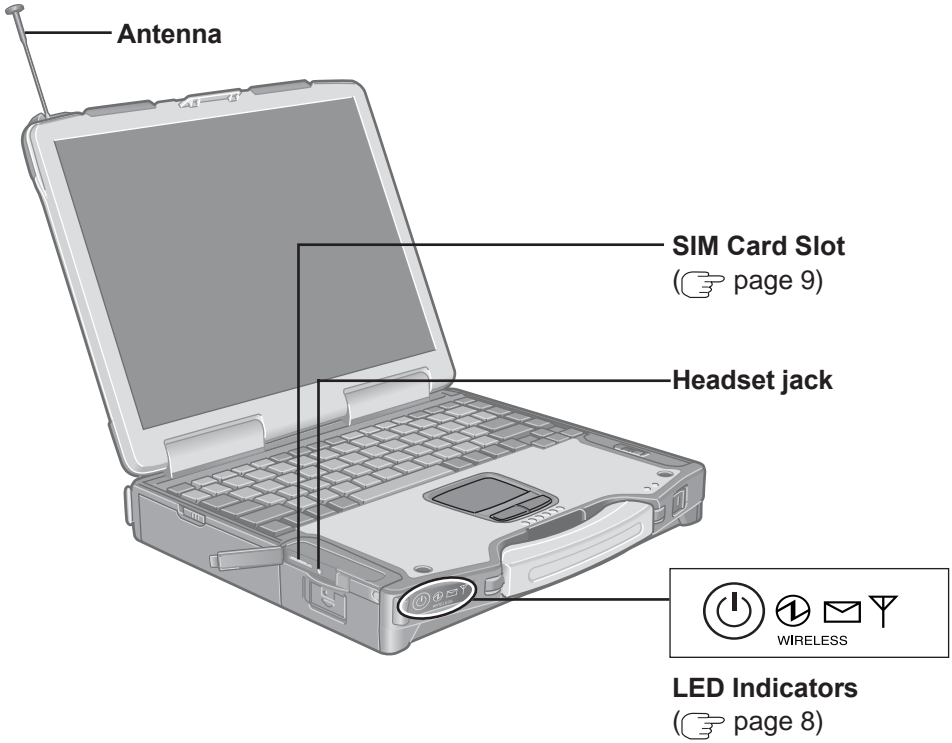

(Appearance may differ depending on specifications.)

# Names and Functions of Parts

---

<CF-73 Series>



**LED Indicators**

(☞ page 6)

**Antenna**

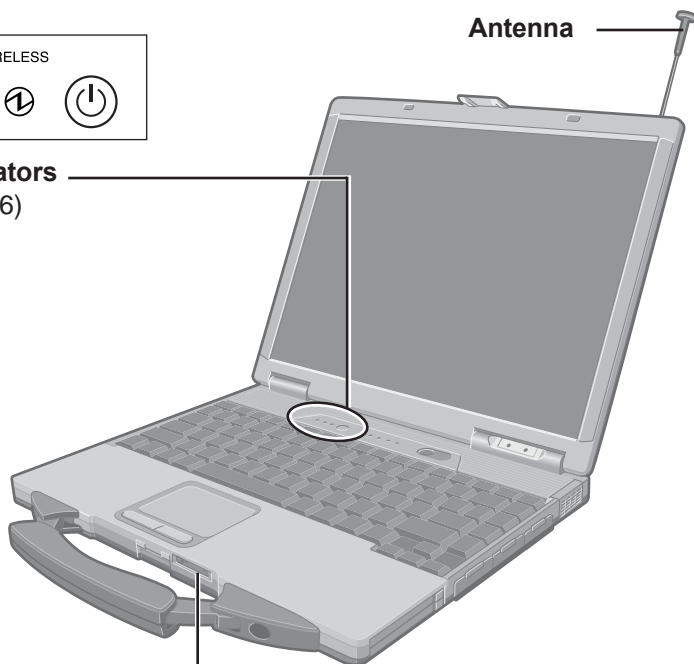

**SIM Card Slot**

(☞ page 7)

(Appearance may differ depending on specifications.)

---

## ● LED Description



### EDGE Modem Switch

The EDGE modem powers up independently from the computer regardless of the computer power status and will remain on when the computer's power is off. This function depends on the setting of the Setup Utility.



### Power On Indication:

A green LED will be used to signal when the EDGE modem has been powered on.



### Ring Indication:

The LED will flash when the EDGE modem has received a ring.



### Status Indication:

The LED will light while communicating.

Mode	Function
Off	EDGE modem is off or running in SLEEP mode.
600 ms On/ 600 ms Off	No SIM card inserted or no PIN entered, or network search in progress, or ongoing user authentication, or network login in progress.
75 ms On/3 s Off	Logged to network (monitoring control channels and user interactions). No call in progress.
75ms On/75ms Off/ 75 ms On/3 s Off	One or more EDGE/GPRS contexts activated.
500 ms On/ 25 ms Off	Indicates EDGE/GPRS data transfer.
On	Depending on type of call: Voice call: Connected to remote party. Data call: Connected to remote party or exchange of parameters while setting up or disconnecting a call.

# Installing/Removing a SIM Card

Before using the EDGE modem, set a SIM card to the SIM card slot.

## CAUTION

- Do not install/remove the SIM card when the EDGE modem's power is on.

## CF-18/CF-29 Series

**1** Power off your computer and EDGE modem.

**2** ● Installing a SIM card

<CF-18 Series>

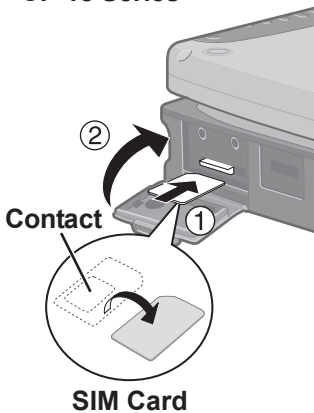

- ① Insert the SIM card into the SIM card slot with the contact side facing downward and with the cut corner in front.

## CAUTION

- Do not insert the SIM card upside down.

- ② Close the cover.

If the cover is not closed, the SIM card may jump out when the computer falls.

<CF-29 Series>

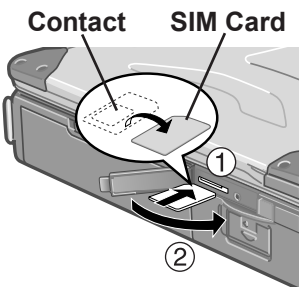

---

### <CF-18 Series>

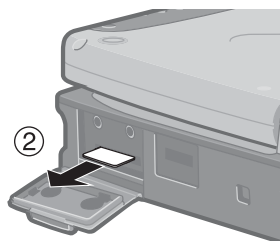
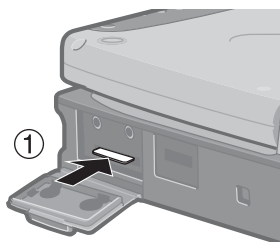

### ● Removing a SIM card

- ① Press the card.  
It will come out of the slot a little bit.
- ② Pull the card all the way out.

### <CF-29 Series>

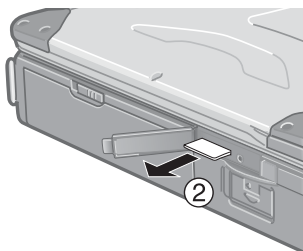
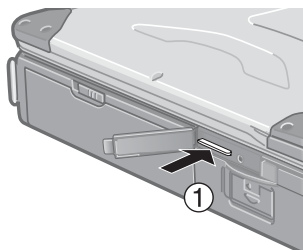

# Installing/Removing a SIM Card

## CF-73 Series

**1** Power off your computer and EDGE modem.

## **2** ● Installing a SIM card

- ① Set the SIM card into the socket with the contact facing upward.

### CAUTION

- Do not insert the SIM card upside down.

- ② Turn the socket over.

- ③ Insert the socket to the SIM card slot.

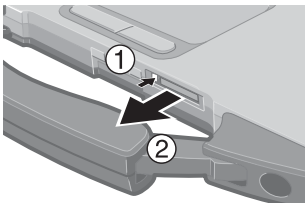
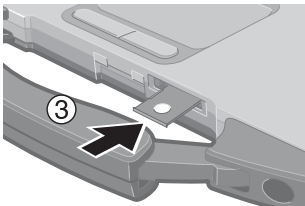
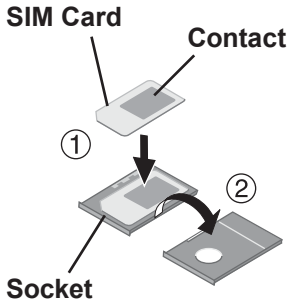

## ● Removing a SIM card

- ① Press the button with a pointed object (e.g., the tip of a ballpoint pen).
- ② Remove the socket.
- ③ Remove the SIM card from the socket.

A CD-ROM drive is necessary for the installation.

## CAUTION

<CF-73 Series>

- When using the internal modem, change the COM port with the following procedure before installation.

- 1 Select [Device Manager]\*<sup>1</sup> - [Modems] - [Panasonic V.92 MDC Modem] - [Advanced] - [Advanced Port Settings].
- 2 Select [COM6] at [COM Port Number] and select [OK].
- 3 Select [OK] and restart the computer.

\*<sup>1</sup> in [start] - [Control Panel] - [Performance and Maintenance] - [System] - [Hardware]

## 1 Turn on or restart the computer.

Press **(F2)** while [Panasonic] screen is displayed soon after the computer begins the startup procedure.

If [Enter Password] is displayed, enter your password.

## 2 Select the [Advanced] menu and confirm the followings.

(☞ page 14)

- The serial port's setting is optimal.
- [On & Off] is selected at [Power SYNC with PC].

If [On & Off] is not set, confirm the power to the EDGE modem is on.

## 3 Save the settings and exit the Setup Utility.

## 4 Log on to Windows with the administrator authority.

## 5 Insert the CheckNet CD-ROM into the drive.

## 6 At [Welcome to the Found New Hardware Wizard], select [No, not this time], and then select [Next].



# Installing the Software

**7** Select [Install from a list or specific location (Advanced)], then select [Next].

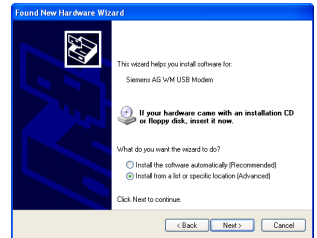

**8** Select [Search for the best driver in these locations], add the check mark for [Include this location in the search:], input [x:\]\*2, and then select [Next].

\*2 “x:” is the drive letter of the CD-ROM drive. Change this to match the drive letter on your own computer.

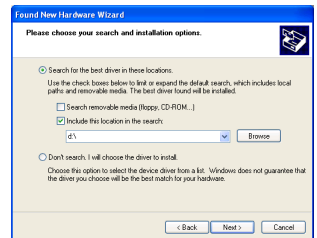

**9** Select [Finish].

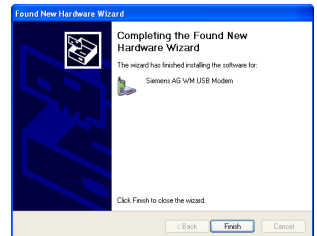

**10** Input [x:\setup\setup.exe]\*2 in [start] - [Run] and select [OK].

Follow the on-screen instructions.

\*2 “x:” is the drive letter of the CD-ROM drive. Change this to match the drive letter on your own computer.

**11** Select [Yes, I want to restart my computer now.], then select [Finish].

The computer will restart.

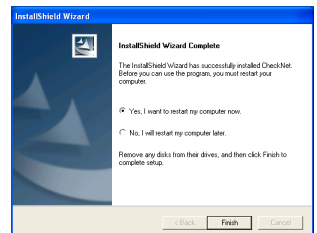

---

## 12 Log on to Windows with the administrator authority.

## 13 Making extra settings for the EDGE modem.

- ① Select [start] - [Control Panel] - [Printers and Other Hardware] - [Phone and Modem Options] - [Modems], select your EDGE modem, and then select [Properties].
- ② In [Advanced], enter the extra initialization commands as follows.  
AT+CGDCONT=<cid>,<pdp type>,<apn>  
<RETURN>  
**Example:** <cid>:1, <pdp type>:ip, <apn>:internet.t-d1.de  
AT+CGDCONT=1,ip,internet.t-d1.de  
<RETURN>  
(Note that the APN shown here represents the German network provider T-D1 and needs to be replaced with the APN address supplied by your own network provider.)
- ③ Select [OK].

## Opening the Online Manual

“Operating Instructions for using EDGE Modem” explains how to access the network using the EDGE modem.

It can be accessed from the following menu.

[start] - [All Programs] - [Panasonic] - [CheckNet] - [Manual]

## Uninstalling the Software

### ● CheckNet

Use the following menu.

[start] - [Control Panel] - [Add or Remove Programs]

### ● Wireless modem driver

Select [Device Manager]\*1- [Modems] - [Siemens AG WM USB Modem] and uninstall the driver.

\*1 in [start] - [Control Panel] - [Performance and Maintenance] - [System] - [Hardware]

# Appendix

## Setup Utility

The following parameters have been added in [Advanced] menu of the Setup Utility.

<CF-18 Series>

### Tablet PC

Wireless Modem	Disable	<u>Enable</u>	
Power SYNC with PC	Independent	<u>On &amp; Off</u>	Off Only

### Windows XP

Wireless Modem	Disable	Enable	<u>Auto</u>	
Port1 I/O IRQ*	3F8/IRQ4	2F8/IRQ3	3E8/IRQ7	2E8/IRQ5
Port2 I/O IRQ*	3F8/IRQ4	2F8/IRQ3	3E8/IRQ7	2E8/IRQ5
Power SYNC with PC	Independent	<u>On &amp; Off</u>	Off Only	

<CF-29 Series>

<CF-73 Series>

Wireless Modem	Disable	Enable	<u>Auto</u>	
I/O IRQ*	2F8/IRQ3	2E8/IRQ10	338/IRQ7	238/IRQ5
Power SYNC with PC	Independent	<u>On &amp; Off</u>	Off Only	

\* This item is displayed only when [Wireless Modem] is set to [Enable].

### NOTE

<CF-29 Series>

- For details on the COM ports assigned to wireless modem, refer to “Technical Information” in the Reference Manual.

---

## Abbreviations

APN	Access Point Name
CID	Context Identity
EDGE	Enhanced Data rates for Global Evolution
GPRS	General Packet Radio Service
GSM	Global System of Mobile Communication
IP	Internet Protocol
PDP	Packet Data Protocol
PIN	Personal Identification Number
PLMN	Public Land Mobile Network
PPP	Point to Point Protocol
QoS	Quality of Service
SIM	Subscriber Identity Module
TCP	Transmission Control Protocol

# Specifications

<b>Frequency Band &amp; Power Class</b>	<b>GSM/GPRS</b>	GSM850 Class 4 (2 W) PCS1900 Class 1 (1 W)
	<b>EDGE (EGPRS)</b>	GSM850 Class E2 (0.5 W) PCS1900 Class E2 (0.4 W)
<b>Data Communication</b>	<b>EDGE (EGPRS)</b>	MultiSlot Class 10 Mobile station Class B
	<b>GPRS</b>	MultiSlot Class 12 Mobile station Class B
	<b>CSD</b>	Analog & ISDN Baud rate: 9600 bps / 14400 bps
<b>Other Features</b>	<b>SMS</b>	Point-to-point Mobile Originated and Mobile Terminated
	<b>FAX</b>	Group 3, Class 1
	<b>Voice*<sup>1</sup></b>	HR (Half rate) FR (Full rate) EFR (Enhanced full rate) AMR (Adaptive Multi Rate)
<b>Interface</b>	<b>USB</b>	Full speed (12 Mbps)
	<b>Serial</b>	1.2 kbps - 115 kbps
<b>SIM</b>		Supported SIM card: 3 V
<b>Data Storage</b>	<b>SMS</b>	SIM card plus 25 SMS messages

\*<sup>1</sup> Supported models only.

© 2005 Matsushita Electric Industrial Co., Ltd. All Rights Reserved.  
Printed in Japan

FJ0505-0  
DFQX5545ZA

