



PCTEST ENGINEERING LABORATORY, INC.

6660 – B Dobbin Road · Columbia, MD 21045 · USA

Telephone 410.290.6652 / Fax 410.290.6654

<http://www.pctestlab.com> (email: randy@pctestlab.com)



CERTIFICATE OF COMPLIANCE (SAR EVALUATION)

APPLICANT NAME & ADDRESS:

Matsushita Electric Industrial Co., Ltd.
1006 Oaza Kadoma, Kadoma,
Osaka, 571 JAPAN

DATE & LOCATION OF TESTING:

Dates of Tests: March 25, 2004
Test Report S/N: SAR.240303161.ACJ
Test Site: PCTEST Lab, Columbia, MD USA
Project No: ITPD-04-F012A

FCC ID: ACJ9TGCF-503

APPLICANT: MATSUSHITA ELECTRIC INDUSTRIAL CO., LTD.

EUT Type: TOUGHBOOK CF-50 w/ Intel WLAN Model: WM3B2200BG
Tx Frequency: 2412 – 2462 MHz (DSSS)
Rx Frequency: 2412 – 2462 MHz (DSSS)
Max. RF Output Power: 56.4 mW (17.5 dBm) Conducted
Max. SAR Measurement: 0.03 W/kg Body SAR (Lap)
0.52 W/kg Body SAR (Side)
Trade Name/Model(s): PANASONIC CF-50
FCC Classification: Digital Transmission System (DTS)
FCC Rule Part(s): §2.1093; FCC/OET Bulletin 65 Supplement C [July 2001]
Application Type: Certification
Test Device Serial No.: Identical Prototype [S/N: 4GMTA00006]

This wireless portable device has been shown to be capable of compliance for localized specific absorption rate (SAR) for uncontrolled environment/general population exposure limits specified in ANSI/IEEE Std. C95.1-1992 and had been tested in accordance with the measurement procedures specified in FCC/OET Bulletin 65 Supplement C (2001) and IEEE Std. P1528 D1.2 (April 2003).

I attest to the accuracy of data. All measurements reported herein were performed by me or were made under my supervision and are correct to the best of my knowledge and belief. I assume full responsibility for the completeness of these measurements and vouch for the qualifications of all persons taking them.

Grant Conditions: Power output is conducted. This device is authorized to operate with a specific computer as described in this filing and has been tested for SAR compliance for portable configurations. This device must not be co-located or operating with any other antenna or transmitter except the Bluetooth described in this filing. End-users must be provided with operating conditions for satisfying RF exposure compliance.

PCTEST certifies that no party to this application has been denied the FCC benefits pursuant to Section 5301 of the Anti-Drug Abuse Act of 1988, 21 U.S.C. 862.

Alfred Cirwithian
Vice President Engineering







PCTEST [®] SAR TEST REPORT	 FCC MEASUREMENT REPORT			Reviewed by: Quality Manager
SAR Filename: SAR.240303161.ACJ	Test Dates: Mar. 25, 2004	TOUGHBOOK CF-50 w/ Intel WLAN Model: WM3B2200BG	FCC ID: ACJ9TGCF-503	Page 1 of 22

TABLE OF CONTENTS

1.	INTRODUCTION / SAR DEFINITION.....	3
2.	SAR MEASUREMENT SETUP.....	4
3.	ALIDX-500 E-FIELD PROBE SYSTEM.....	5
4.	PROBE CALIBRATION PROCESS.....	6
5.	PHANTOM & EQUIVALENT TISSUES.....	7
6.	TEST SYSTEM SPECIFICATIONS.....	8
7.	TEST CONFIGURATION POSITION.....	9
8.	ANSI/IEEE C95.1 - 1992 RF EXPOSURE LIMITS.....	10
9.	MEASUREMENT UNCERTAINTIES.....	11
10.	SYSTEM VERIFICATION.....	12
11.	SAR TEST DATA SUMMARY.....	13
12.	SAR DATA SUMMARY.....	14
13.	SAR TEST EQUIPMENT.....	16
14.	CONCLUSION.....	17

PCTEST SAR TEST REPORT		FCC MEASUREMENT REPORT		Reviewed by: Quality Manager
SAR Filename: SAR.240303161.ACJ	Test Dates: Mar. 25, 2004	TOUGHBOOK CF-50 w/ Intel WLAN Model: WM3B2200BG	FCC ID: ACJ9TGCF-503	Page 2 of 22

1. INTRODUCTION / SAR DEFINITION

The FCC has adopted the guidelines for evaluating the environmental effects of radiofrequency radiation in ET Docket 93-62 on Aug. 6, 1996 to protect the public and workers from the potential hazards of RF emissions due to FCC-regulated portable devices.[1]

The safety limits used for the environmental evaluation measurements are based on the criteria published by the American National Standards Institute (ANSI) for localized specific absorption rate (SAR) in *IEEE/ANSI C95.1-1992 Standard for Safety Levels with Respect to Human Exposure to Radio Frequency Electromagnetic Fields, 3 kHz to 300 GHz*. (c) 1992 by the Institute of Electrical and Electronics Engineers, Inc., New York, New York 10017.[2] The measurement procedure described in *IEEE/ANSI C95.3-1992 Recommended Practice for the Measurement of Potentially Hazardous Electromagnetic Fields - RF and Microwave*[3] is used for guidance in measuring SAR due to the RF radiation exposure from the Equipment Under Test (EUT). These criteria for SAR evaluation are similar to those recommended by the National Council on Radiation Protection and Measurements (NCRP) in *Biological Effects and Exposure Criteria for Radiofrequency Electromagnetic Fields*, NCRP Report No. 86 (c) NCRP, 1986, Bethesda, MD 20814.[6] SAR is a measure of the rate of energy absorption due to exposure to an RF transmitting source. SAR values have been related to threshold levels for potential biological hazards.

Specific Absorption Rate (SAR) is defined as the time derivative (rate) of the incremental energy (dU) absorbed by (dissipated in) an incremental mass (dm) contained in a volume element (dV) of a given density (r). It is also defined as the rate of RF energy absorption per unit mass at a point in an absorbing body (see Fig. 1.1).

$$SAR = \frac{d}{dt} \left(\frac{dU}{dm} \right) = \frac{d}{dt} \left(\frac{dU}{r \, dV} \right)$$

Figure 1.1
SAR Mathematical Equation



SAR is expressed in units of Watts per Kilogram (W/kg).

$$SAR = s E^2 / r$$

where:

- s = conductivity of the tissue-simulant material (S/m)
- r = mass density of the tissue-simulant material (kg/m³)
- E = Total RMS electric field strength (V/m)

NOTE: The primary factors that control rate of energy absorption were found to be the wavelength of the incident field in relations to the dimensions and geometry of the irradiated organism, the orientation of the organism in relation to the polarity of field vectors, the presence of reflecting surfaces, and whether conductive contact is made by the organism with a ground plane.[6]

PCTEST SAR TEST REPORT	 FCC MEASUREMENT REPORT			Reviewed by: Quality Manager
SAR Filename: SAR.240303161.ACJ	Test Dates: Mar. 25, 2004	TOUGHBOOK CF-50 w/ Intel WLAN Model: WM3B2200BG	FCC ID: ACJ9TGCF-503	Page 3 of 22

2. SAR MEASUREMENT SETUP

Measurements are performed using the ALIDX-500 automated dosimetric assessment system. The ALIDX-500 is made by IDX Robotics, Inc. (IDX) in the United States and consists of high precision robotics system (CRS), robot controller, Pentium 4 computer, near-field probe, probe alignment sensor, and the Left and Right SAM phantoms containing the head/brain equivalent tissue, and the flat phantoms for body/muscle equivalent. The robot is a six-axis industrial robot performing precise movements to position the probe to the location (points) of maximum electromagnetic field (EMF) (see Fig. 2.1).

The Robot table consists of the power supply, robot controller, safety computer, teach pendant (Joystick), six-axis robot arm, and the probe. The cell controller consists of DELL Dimension 4300 Pentium-4 1.6 GHz computer with Windows 2000 system and SAR Measurement software, National Instruments analog card, monitor, keyboard, and mouse. The robot controller is connected to the cell controller to communicate between the two computers. The probe data is connected to the cell controller via data acquisition cables.

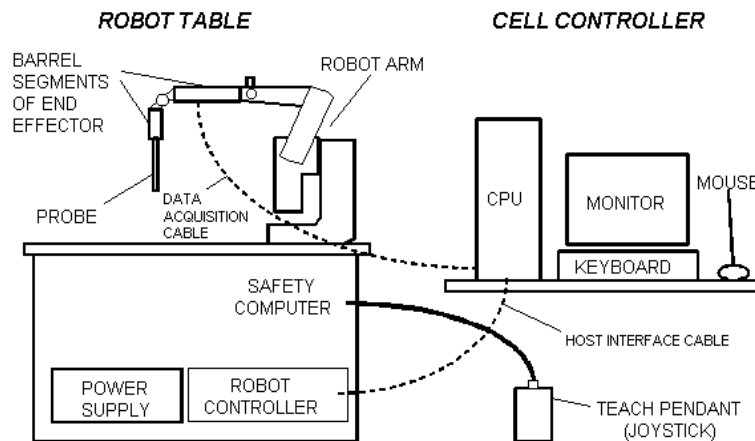



Figure 2.1
SAR Measurement System Setup

When the Robot is in the home position, the Y-axis of the coordinate system parallels the line of intersection between the tabletop and the long axis of the Robot's Large Shoulder. The Teach Pendant may be used to establish the X,Y coordinate directions by depressing the 0-X and 0-Y MOTOR/AXIS switches while in axis mode.

The robot is first taught to position the probe sensor following a specific pattern of points. In the first sweep the sensor enclosure touches the inside of the phantom head. The SAR is measured on a defined grid of points that are concentrated on the surface of the head closest to the antenna of the transmitting device (EUT).

PCTEST SAR TEST REPORT	 FCC MEASUREMENT REPORT			Reviewed by: Quality Manager
SAR Filename: SAR.240303161.ACJ	Test Dates: Mar. 25, 2004	TOUGHBOOK CF-50 w/ Intel WLAN Model: WM3B2200BG	FCC ID: ACJ9TGCF-503	Page 4 of 22

3. ALIDX-500 E-FIELD PROBE SYSTEM



Fig 3.1
IDX System

The near-field probe is an implantable isotropic E-field probe that measures the voltages proportional to the $|E|^2$ (electric) or $|H|^2$ (magnetic) fields. The probe is enclosed in a hollow glass protective cylinder 9-mm. outer diameter, 0.5 mm. thickness and 30 cm. in length. The E-probe contains three electrically small array of orthogonal dipoles strategically placed to provide greater accuracy and to compensate for near-field spatial gradients. The probe contains diodes that are placed over the gap of the dipoles to improve RF detection. The electrical signal detected by each diode is amplified by three DC amplifiers and are contained in a shielded container in the robot end effector so its performance is not affected by the presence of incident electromagnetic fields (see Fig. 3.1).

- Frequency Range: 10 kHz – 6.0 GHz
- Calibration: In air from 10 MHz to 6.0 GHz
In brain and muscle simulating tissue at Frequencies from 835 up to 5800MHz
- Sensitivity: 3.5 mV/mW/cm² (air – typical)
- DC Resistance: 300 kohm
- Isotropic Response: 0.25 dB
- Dynamic Range: 10 mW/kg – 100 W/kg
- Resistance to Pull: 25 N
- Probe Length: 290 mm
- Probe Tip Material: Glass
- Probe Tip Length: 40 mm
- Probe Tip Diameter: 7 ± 0.2 mm
- Application: SAR Dosimetry Testing
HAC (Hearing Aid Compatibility)
Compliance tests of mobile phones

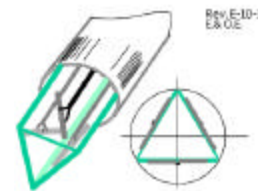

Figure 3.2
Triangular Probe Configuration

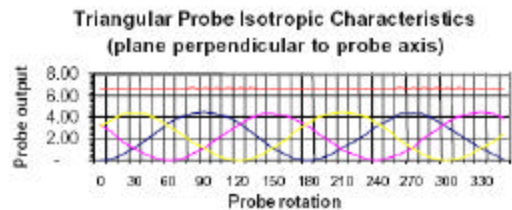



Figure 3.3
Probe Characteristics

PCTEST SAR TEST REPORT	 FCC MEASUREMENT REPORT			Reviewed by: Quality Manager
SAR Filename: SAR.240303161.ACJ	Test Dates: Mar. 25, 2004	TOUGHBOOK CF-50 w/ Intel WLAN Model: WM3B2200BG	FCC ID: ACJ9TGCF-503	Page 5 of 22

4. PROBE CALIBRATION PROCESS

Each E-Probe/Probe amplifier combination has unique calibration parameters. A TEM calibration procedure is conducted to determine the proper amplifier settings to enter in the probe parameters. The amplifier settings are determined for a given frequency by subjecting the Probe to a known E-field density (1mW/cm²) using an RF Signal generator, TEM cell, and RF Power Meter. The SAR measurement software is used for Probe calibration.

The free space E-field from amplified probe outputs is determined in a test chamber. This calibration can be performed in a TEM cell if the frequency is below 1 GHz and in a waveguide or some other methodologies above 1 GHz for free space. For the free space calibration, we place the probe in the volumetric center of the cavity and at the proper orientation with the field. We then rotate the probe 360 degrees until the three channels show the maximum reading. The power density readings equates to 1mW/cm².

E-field temperature correlation calibration is performed in a flat phantom filled with the appropriate simulated brain tissue. The measured free space E-field in the medium correlates to temperature rise in a dielectric medium. For temperature correlation calibration a RF transparent thermistor-based temperature probe is used in conjunction with the E-field probe.

$$SAR = C \frac{\Delta T}{\Delta t}$$

where:

- Δt = exposure time (30 seconds),
- C = heat capacity of tissue (brain or muscle),
- ΔT = temperature increase due to RF exposure.

SAR is proportional to $\Delta T / \Delta t$, the initial rate of tissue heating, before thermal diffusion takes place. Now it's possible to quantify the electric field in the simulated tissue by equating the thermally derived SAR to the E- field;

$$SAR = \frac{|E|^2 \cdot \sigma}{\rho}$$

where:

- σ = simulated tissue conductivity,
- ρ = Tissue density (1.25 g/cm³ for brain tissue)

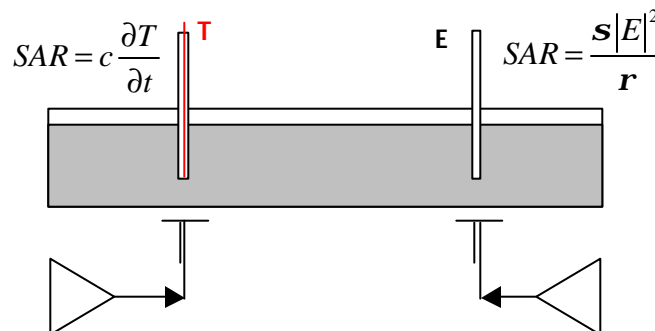



Figure 4.1 Temperature Assessment Test Configuration

PCTEST SAR TEST REPORT	 FCC MEASUREMENT REPORT			Reviewed by: Quality Manager
SAR Filename: SAR.240303161.ACJ	Test Dates: Mar. 25, 2004	TOUGHBOOK CF-50 w/ Intel WLAN Model: WM3B2200BG	FCC ID: ACJ9TGCF-503	Page 6 of 22

5. PHANTOM & EQUIVALENT TISSUES



Figure 5.1
SAM Phantoms

The Left and Right SAM Phantoms are constructed of a vivac composite integrated in a corian stand. The shape of the shell is based on data from an anatomical study designed to determine the maximum exposure in at least 90% of all users [7][8]. It enables the dosimetric evaluation of left and right hand phone usage as well as body mounted usage at the flat phantom region. A cover prevents the evaporation of the liquid. Reference markings on the Phantom allow the complete setup of all predefined phantom positions and measurement grids by manually teaching three points in the robot. (see Fig. 5.1)

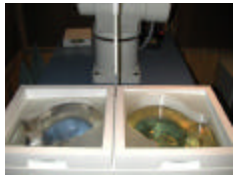

Figure 5.2
Head Simulated Tissue

The brain and muscle mixtures consist of a viscous gel using hydroxethylcellulose (HEC) gelling agent and saline solution (see Table 6.1). Preservation with a bactericide is added and visual inspection is made to make sure air bubbles are not trapped during the mixing process. The mixture is calibrated to obtain proper dielectric constant (permittivity) and conductivity of the desired tissue. The head tissue dielectric parameters recommended by the IEEE SCC-34/SC-2 have been incorporated in the following table. Other head and body tissue parameters that have not been specified in P1528 are derived from the issue dielectric parameters computed from the 4-Cole-Cole equations. The mixture characterizations used for the brain and muscle tissue simulating liquids are according to the data by C. Gabriel and G. Hartsgrove [9].(see Table 5.1)

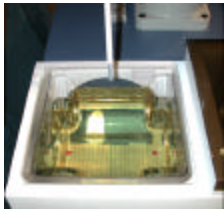

Figure 5.3
Body/Muscle Simulated Tissue

(% by weight)	Frequency (MHz)									
	450		835		915		1900		2450	
Tissue Type	Head	Body	Head	Body	Head	Body	Head	Body	Head	Body
Water	38.56	51.16	41.45	52.4	41.05	56.0	54.9	40.4	58.55	73.2
Salt (NAC1)	3.95	1.49	1.45	1.4	1.35	0.76	0.18	0.5	0.11	0.4
Sugar	56.32	46.78	56.0	45.0	56.0	41.76	0.0	58.0	0.0	0.0
HEC	0.98	0.52	1.0	1.0	1.0	1.21	0.0	1.0	0.0	0.0
Bacteride	0.19	0.05	0.1	0.1	0.27	0.0	0.1	0.0	0.0	0.0
Triton X-100	0.0	0.0	0.0	0.0	0.0	0.0	0.0	0.0	35.38	0.0
DGBE	0.0	0.0	0.0	0.0	0.0	0.0	44.92	0.0	6.96	26.7



Table 5.1
Composition of the Brain & Muscle Tissue Equivalent Matter



Figure 5.4
Device Positioner

In combination with the SAM Phantom, the EUT Holder (see Fig. 6.2) enables the rotation of the mounted transmitter in spherical coordinates whereby the rotation point is the ear opening. Device positioning is accurate and repeatable according to the FCC and CENELEC specifications. The device holder can be locked at different phantom locations (left head, right head, flat phantom).

* Note: A simulating human hand is not used due to the complex anatomical and geometrical structure of the hand that may produce infinite number of configurations [8]. To produce the worst-case condition (the hand absorbs antenna output power), the hand is omitted during the tests.

PCTEST SAR TEST REPORT		 FCC MEASUREMENT REPORT			Reviewed by: Quality Manager
SAR Filename: SAR.240303161.ACJ	Test Dates: Mar. 25, 2004	TOUGHBOOK CF-50 w/ Intel WLAN Model: WM3B2200BG	FCC ID: ACJ9TGCF-503	Page 7 of 22	

6. TEST SYSTEM SPECIFICATIONS

Positioner

Robot: CRS Robotics, Inc. Robot Model: F3
Repeatability: ± 0.05 mm (0.002 in.)
No. Of axes: 6

Data Acquisition Electronic (DAE) System

Cell Controller

Processor: Pentium 4
Clock Speed: 1.6 GHz
Operating System: Windows 2000™ Professional
Data Card: NI DAQ Card (in CPU)

Data Converter

Software: IDX Flexware
Connecting Lines: Data Acquisition Cable
 RS-232 Host Interface Cable
Sampling Rate: 6000 samples/sec





Figure 6.1
ALIDX-500 Test System

E-Field Probes

Model: E-010 S/N: PCT003
Construction: Triangular core absolute encoder system
Frequency: 10 MHz to 6.0 GHz

Phantom

Phantom: SAM Phantoms (Left & Right)
Shell Material: Vivac Composite
Thickness: 2.0 ± 0.2 mm

PCTEST SAR TEST REPORT	 FCC MEASUREMENT REPORT			Reviewed by: Quality Manager
SAR Filename: SAR.240303161.ACJ	Test Dates: Mar. 25, 2004	TOUGHBOOK CF-50 w/ Intel WLAN Model: WM3B2200BG	FCC ID: ACJ9TGCF-503	Page 8 of 22

7. TEST CONFIGURATION POSITION

Body-worn operating configurations are tested with the notebook positioned touching against a flat phantom (lap) in a normal use configuration (see Figure 7.1). Body dielectric parameters are used.

In addition to the typical lap position test configuration, a bystander position (See Figure 7.2) is also evaluated for RF safety. The antenna is placed 1.5 cm from the flat phantom from the antenna side of the unit. This ensures that any other part of the body or other bodies touching the transmitting antenna on the notebook meets RF exposure compliance.

In all cases SAR measurements are performed to investigate the worst-case positioning. Worst-case positioning is then documented and used to perform Body SAR testing.

In order for users to be aware of the body-worn operating requirements for meeting RF exposure compliance, operating instructions and a caution statement must be included in the user's manual.

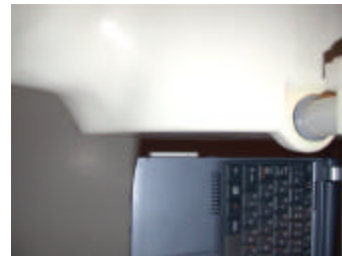



Figure 7.1 Body SAR Laptop and Bvstander Confiurations

PCTEST SAR TEST REPORT		FCC MEASUREMENT REPORT		Reviewed by: Quality Manager
SAR Filename: SAR.240303161.ACJ	Test Dates: Mar. 25, 2004	TOUGHBOOK CF-50 w/ Intel WLAN Model: WM3B2200BG	FCC ID: ACJ9TGCF-503	Page 9 of 22

8. ANSI/IEEE C95.1 - 1992 RF EXPOSURE LIMITS

UNCONTROLLED ENVIRONMENTS are defined as locations where there is the exposure of individuals who have no knowledge or control of their exposure. The general population/uncontrolled exposure limits are applicable to situations in which the general public may be exposed or in which persons who are exposed as a consequence of their employment may not be made fully aware of the potential for exposure or cannot exercise control over their exposure. Members of the general public would come under this category when exposure is not employment-related; for example, in the case of a wireless transmitter that exposes persons in its vicinity.

CONTROLLED ENVIRONMENTS are defined as locations where there is exposure that may be incurred by persons who are aware of the potential for exposure, (i.e. as a result of employment or occupation). In general, occupational/controlled exposure limits are applicable to situations in which persons are exposed as a consequence of their employment, who have been made fully aware of the potential for exposure and can exercise control over their exposure. This exposure category is also applicable when the exposure is of a transient nature due to incidental passage through a location where the exposure levels may be higher than the general population/uncontrolled limits, but the exposed person is fully aware of the potential for exposure and can exercise control over his or her exposure by leaving the area or by some other appropriate means.



Table 8.1. Safety Limits for Partial Body Exposure [2]

	HUMAN EXPOSURE LIMITS	
	UNCONTROLLED ENVIRONMENT General Population (W/kg) or (mW/g)	CONTROLLED ENVIRONMENT General Population (W/kg) or (mW/g)
SPATIAL PEAK SAR 1 Brain	1.60	8.00
SPATIAL AVERAGE SAR 2 Whole Body	0.08	0.40
SPATIAL PEAK SAR 3 Hands, Feet, Ankles, Wrists	4.00	20.00

1 The Spatial Peak value of the SAR averaged over any 1 gram of tissue (defined as a tissue volume in the shape of a cube) and over the appropriate averaging time.

2 The Spatial Average value of the SAR averaged over the whole body.



3 The Spatial Peak value of the SAR averaged over any 10 grams of tissue (defined as a tissue volume in the shape of a cube) and over the appropriate averaging time.

PCTEST SAR TEST REPORT	 FCC MEASUREMENT REPORT 		Reviewed by: Quality Manager
SAR Filename: SAR.240303161.ACJ	Test Dates: Mar. 25, 2004	TOUGHBOOK CF-50 w/ Intel WLAN Model: WM3B2200BG	FCC ID: ACJ9TGCF-503 Page 10 of 22

9. MEASUREMENT UNCERTAINTIES

a	b	c	d	e = f(d,k)	f	g	h = cxf/e	i = cxg/e	k
Uncertainty Component	Sec.	Tol. (± %)	Prob. Dist.	Div.	c _i (1 - g)	c _i (10 - g)	1 - g u _i (± %)	10 - g u _i (± %)	v _i
Measurement System									
Probe Calibration	E1.1	11.4	N	$\sqrt{3}$	1	1	6.6	6.6	∞
Axial Isotropy	E1.2	3.4	R	$\sqrt{3}$	0.7	0.7	1.4	1.4	∞
Hemishperical Isotropy	E1.2	5.2	R	$\sqrt{3}$	1	1	3.0	3.0	∞
Boundary Effect	E1.3	4.7	R	$\sqrt{3}$	1	1	2.7	2.7	∞
Linearity	E1.4	5.9	R	$\sqrt{3}$	1	1	3.4	3.4	∞
System Detection Limits	E1.5	1.0	R	$\sqrt{3}$	1	1	0.6	0.6	∞
Readout Electronics	E1.6	1.0	R	1	1	1	1.0	1.0	∞
Response Time	E1.7	0.8	R	$\sqrt{3}$	1	1	0.5	0.5	∞
Integration Time	E1.8	1.7	R	$\sqrt{3}$	1	1	1.0	1.0	∞
RF Ambient Conditions	E5.1	1.2	R	$\sqrt{3}$	1	1	0.7	0.7	∞
Probe Positioner Mechanical Tolerance	E5.2	0.4	R	$\sqrt{3}$	1	1	0.2	0.2	∞
Probe Positioning w/ respect to Phantom Shell	E5.3	2.9	R	$\sqrt{3}$	1	1	1.7	1.7	∞
Extrapolation, Interpolation & Integration Algorithms for Max. SAR Evaluation	E4.2	3.9	R	$\sqrt{3}$	1	1	2.3	2.3	∞
Test Sample Related									
Test Sample Positioning	E3.2.1	10.6	R	$\sqrt{3}$	1	1	6.1	6.1	11
Device Holder Uncertainty	E3.1.1	8.7	R	$\sqrt{3}$	1	1	5.0	5.0	8
Output Power Variation - SAR drift measurement	5.6.2	5.0	R	$\sqrt{3}$	1	1	2.9	2.9	∞
Phantom & Tissue Parameters									
Phantom Uncertainty (Shape & Thickness tolerances)	E2.1	4.0	R	$\sqrt{3}$	1	1	2.3	2.3	∞
Liquid Conductivity - deviation from target values	E2.2	5.0	R	$\sqrt{3}$	0.7	0.5	2.0	1.4	∞
Liquid Conductivity - measurement uncertainty	E2.2	5.0	R	$\sqrt{3}$	0.7	0.5	2.0	1.4	∞
Liquid Permittivity - deviation from target values	E2.2	5.0	R	$\sqrt{3}$	0.6	0.5	1.7	1.4	∞
Liquid Permittivity - measurement uncertainty	E2.2	5.0	R	$\sqrt{3}$	0.6	0.5	1.7	1.4	∞
Combined Standard Uncertainty (k=1)			RSS				13.2	13.0	
Expanded Uncertainty (k=2) (95% CONFIDENCE LEVEL)							26.6	26.2	

The above measurement uncertainties are according to IEEE Std. P1528 D1.2 (April 2003)

PCTEST SAR TEST REPORT	 FCC MEASUREMENT REPORT			Reviewed by: Quality Manager
SAR Filename: SAR.240303161.ACJ	Test Dates: Mar. 25, 2004	TOUGHBOOK CF-50 w/ Intel WLAN Model: WMM3B2200BG	FCC ID: ACJ9TGCF-503	Page 11 of 22

10. SYSTEM VERIFICATION

Table 10.1 Simulated Tissue Verification

MEASURED TISSUE PARAMETERS					
Date(s)	03/25/04	2450MHz Brain		2450MHz Muscle	
Liquid Temperature (°C)	19.5	Target	Measured	Target	Measured
Dielectric Constant: ϵ		39.20	39.3	52.70	55.00
Conductivity: σ		1.800	1.83	1.950	1.97

Prior to assessment, the system is verified to the $\pm 10\%$ of the specifications at 2450 MHz by using the system validation kits. (Graphic Plots Attached)

Table 10.2 System Verification

System Validation TARGET & MEASURED							
Date:	Amb. Temp (°C)	Liquid Temp(°C)	Input Power (W)	Tissue	Targeted SAR _{1g} (mW/g)	Measured SAR _{1g} (mW/g)	Deviation (%)
03/25/04	23.1	20.8	0.050	2450MHz Brain	2.620	2.47	- 5.62 %

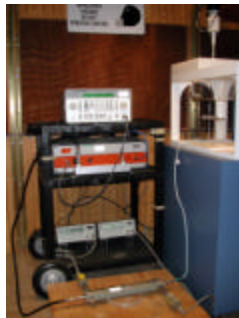



Figure 10.1 Dipole Validation Test Setup

PCTEST SAR TEST REPORT	 FCC MEASUREMENT REPORT			Reviewed by: Quality Manager
SAR Filename: SAR.240303161.ACJ	Test Dates: Mar. 25, 2004	TOUGHBOOK CF-50 w/ Intel WLAN Model: WM3B2200BG	FCC ID: ACJ9TGCF-503	Page 12 of 22



11. SAR TEST DATA SUMMARY

See Measurement Result Data Pages

The EUT was placed into continuous transmit mode using the manufacturer's software. Such test signals offer a consistent means for testing SAR and are recommended for evaluating SAR [4].

Device Test Conditions

The EUT is powered through the internal battery. In order to verify that the device was tested at full power, conducted output power measurements were performed before and after each SAR measurement to confirm the maximum output power. If a power deviation of more than 5% occurred, the test was repeated.

PCTEST SAR TEST REPORT		FCC MEASUREMENT REPORT		Reviewed by: Quality Manager
SAR Filename: SAR.240303161.ACJ	Test Dates: Mar. 25, 2004	TOUGHBOOK CF-50 w/ Intel WLAN Model: WM3B2200BG	FCC ID: ACJ9TGCF-503	Page 13 of 22

12. SAR DATA SUMMARY

Mixture Type: 2450MHz Muscle

A.1 MEASUREMENT RESULTS (Body SAR - Bystander)

FREQUENCY		Modulation	POWER		Data Rate	Battery	Separation Distance (cm) ^{††}	Antenna Position	SAR (W/kg)
MHz	Ch.		Start	End	(Mbps)				
2412	1	DSSS	17.50	17.39	1	Standard	TOUCH	FIXED	0.52
2437	6	DSSS	17.19	17.09	1	Standard	TOUCH	FIXED	0.28
2462	11	DSSS	16.88	16.90	1	Standard	TOUCH	FIXED	0.28
2412	1	DSSS	17.15	17.37	2	Standard	TOUCH	FIXED	0.50
2412	1	DSSS	16.88	17.07	5.5	Standard	TOUCH	FIXED	0.44
2412	1	DSSS	16.37	16.44	11	Standard	TOUCH	FIXED	0.43
2412	1	OFDM	15.65	15.40	6	Standard	TOUCH	FIXED	0.34
2437	6	OFDM	15.31	15.25	6	Standard	TOUCH	FIXED	0.23
2462	11	OFDM	14.75	14.99	6	Standard	TOUCH	FIXED	0.20
2412	1	OFDM	14.57	14.15	24	Standard	TOUCH	FIXED	0.19
2412	1	OFDM	13.18	13.48	54	Standard	TOUCH	FIXED	0.16
ANSI / IEEE C95.1 1992 - SAFETY LIMIT Spatial Peak Uncontrolled Exposure/General Population							Muscle 1.6 W/kg (mW/g) averaged over 1 gram		

NOTES:

1. The test data reported are the worst-case SAR value with the body-worn position set in a typical configuration. Test procedures used are according to FCC/OET Bulletin 65, Supp.C [July 2001].
 2. All modes of operation were investigated, and worst-case results are reported.
 3. Battery is fully charged for all readings.
- | | | | |
|---------------------------|---|--|------------------------------------|
| *Power Measured | <input checked="" type="checkbox"/> Conducted | <input type="checkbox"/> ERP | <input type="checkbox"/> EIRP |
| 4. SAR Measurement System | <input type="checkbox"/> DASY3 | <input checked="" type="checkbox"/> IDX | <input type="checkbox"/> |
| Phantom Configuration | <input type="checkbox"/> Left Head | <input checked="" type="checkbox"/> Flat Phantom | <input type="checkbox"/> Left Head |
| 5. SAR Configuration | <input type="checkbox"/> Head | <input checked="" type="checkbox"/> Body | <input type="checkbox"/> Hand |
| 6. Test Signal Call Mode | <input checked="" type="checkbox"/> Software | <input type="checkbox"/> Base Station Simulator | |
7. Tissue parameters and temperatures are listed on the SAR plots.
 8. Liquid tissue depth is 15 cm. ± 0.1



Alfred Cirvithian
Vice President Engineering

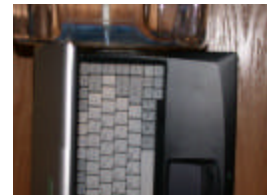



Figure 12.1 Body SAR - Side Position -

PCTEST SAR TEST REPORT		FCC MEASUREMENT REPORT		Reviewed by: Quality Manager
SAR Filename: SAR.240303161.ACJ	Test Dates: Mar. 25, 2004	TOUGHBOOK CF-50 w/ Intel WLAN Model: WM3B2200BG	FCC ID: ACJ9TGCF-503	Page 14 of 22

12. SAR DATA SUMMARY (CONTINUED)

Mixture Type: 2450MHz Muscle

A.2 MEASUREMENT RESULTS (Body SAR - Lap)									
FREQUENCY		Modulation	POWER [†]		Data Rate (Mbps)	Battery	Separation Distance (cm) ^{††}	Antenna Position	SAR (W/kg)
MHz	Ch.		Start	End					
2412	1	DSSS	17.28	17.18	1	Standard	TOUCH	FIXED	0.03
2437	6	DSSS	17.14	17.07	1	Standard	TOUCH	FIXED	0.01
2462	11	DSSS	16.93	16.88	1	Standard	TOUCH	FIXED	0.01
2412	1	OFDM	15.54	15.42	6	Standard	TOUCH	FIXED	0.01
ANSI / IEEE C95.1 1992 - SAFETY LIMIT Spatial Peak Uncontrolled Exposure/General Population							Muscle 1.6 W/kg (mW/g) averaged over 1 gram		



NOTES:

1. The test data reported are the worst-case SAR value with the body-worn position set in a typical configuration. Test procedures used are according to FCC/OET Bulletin 65, Supp.C [July 2001].
 2. All modes of operation were investigated, and worst-case results are reported.
 3. Battery is fully charged for all readings.
- | | | | | | | |
|---------------------------|-------------------------------------|-----------|-------------------------------------|------------------------|--------------------------|-----------|
| *Power Measured | <input checked="" type="checkbox"/> | Conducted | <input type="checkbox"/> | ERP | <input type="checkbox"/> | EIRP |
| 4. SAR Measurement System | <input type="checkbox"/> | DASY3 | <input checked="" type="checkbox"/> | IDX | <input type="checkbox"/> | |
| Phantom Configuration | <input type="checkbox"/> | Left Head | <input checked="" type="checkbox"/> | Flat Phantom | <input type="checkbox"/> | Left Head |
| 5. SAR Configuration | <input type="checkbox"/> | Head | <input checked="" type="checkbox"/> | Body | <input type="checkbox"/> | Hand |
| 6. Test Signal Call Mode | <input checked="" type="checkbox"/> | Software | <input type="checkbox"/> | Base Station Simulator | | |
7. Tissue parameters and temperatures are listed on the SAR plots.
 8. Liquid tissue depth is 15 cm. ± 0.1

 Alfred Cirwithian
 Vice President Engineering



**Figure 12.1 Body SAR
- Lap Position -**

PCTEST SAR TEST REPORT		FCC MEASUREMENT REPORT		Reviewed by: Quality Manager
SAR Filename: SAR.240303161.ACJ	Test Dates: Mar. 25, 2004	TOUGHBOOK CF-50 w/ Intel WLAN Model: WM3B2200BG	FCC ID: ACJ9TGCF-503	Page 15 of 22



13. SAR TEST EQUIPMENT

Table 13.1 Test Equipment Calibration

EQUIPMENT SPECIFICATIONS		
Type	Calibration Date	Serial Number
CRS Robot F3	February 2004	RAF0134133
CRS C500C Motion Controller	February 2004	RCB0003303
CRS Teach Pendant (Joystick)	February 2004	STP0132231
DELL Computer, Pentium 4 1.6 GHz, Windows 2000™	February 2004	4PIZ111
E-Field Probe E-010	January 2004	PCT003
Right Ear SAM Phantom (P-SAM-R)	February 2004	94X-113
Left Ear SAM Phantom (P-SAM-L)	February 2004	94X-019
Flat SAM Phantom (P-SAM-FLAT)	February 2004	94X-097
IDX Robot End Effector (EE-103-C)	February 2004	07111223
IDX Probe Amplifier	February 2004	07111113
Validation Dipole D-835S	October 2003	PCT640
Validation Dipole D-1900S	October 2003	PCT641
Brain Equivalent Matter (835MHz)	March 2004	PCTBEM101
Brain Equivalent Matter (1900MHz)	March 2004	PCTBEM301
Brain Equivalent Matter (2450MHz)	March 2004	PCTBEM501
Muscle Equivalent Matter (835MHz)	March 2004	PCTMEM201
Muscle Equivalent Matter (1900MHz)	March 2004	PCTMEM401
Muscle Equivalent Matter (2450MHz)	March 2004	PCTMEM601
Microwave Amp. Model: 5S1G4, (800MHz - 4.2GHz)	January 2004	22332
Gigatronics 8651A Power Meter	January 2004	1835299
HP-8648D (9kHz ~ 4GHz) Signal Generator	January 2004	PCT530
Amplifier Research 5S1G4 Power Amp	January 2004	PCT540
HP-8753E (30kHz ~ 3GHz) Network Analyzer	January 2004	PCT552
HP85070B Dielectric Probe Kit	January 2004	PCT501
Ambient Noise/Reflection, etc.	January 2004	Anechoic Room PCT01

NOTE:



Dipole Validation measurement was performed by PCTEST Lab before each test. The brain simulating material is calibrated by PCTEST using the dielectric probe system and network analyzer to determine the conductivity and permittivity (dielectric constant) of the brain-equivalent material.

PCTEST SAR TEST REPORT		FCC MEASUREMENT REPORT		Reviewed by: Quality Manager
SAR Filename: SAR.240303161.ACJ	Test Dates: Mar. 25, 2004	TOUGHBOOK CF-50 w/ Intel WLAN Model: WM3B2200BG	FCC ID: ACJ9TGCF-503	Page 16 of 22

14. CONCLUSION

The SAR measurement indicates that the EUT complies with the RF radiation exposure limits of the FCC. These measurements are taken to simulate the RF effects exposure under worst-case conditions. Precise laboratory measures were taken to assure repeatability of the tests. The tested device complies with the requirements in respect to all parameters subject to the test. The test results and statements relate only to the item(s) tested.

Please note that the absorption and distribution of electromagnetic energy in the body are very complex phenomena that depend on the mass, shape, and size of the body, the orientation of the body with respect to the field vectors, and the electrical properties of both the body and the environment. Other variables that may play a substantial role in possible biological effects are those that characterize the environment (e.g. ambient temperature, air velocity, relative humidity, and body insulation) and those that characterize the individual (e.g. age, gender, activity level, debilitation, or disease). Because innumerable factors may interact to determine the specific biological outcome of an exposure to electromagnetic fields, any protection guide shall consider maximal amplification of biological effects as a result of field-body interactions, environmental conditions, and physiological variables.[3]

PCTEST SAR TEST REPORT	 FCC MEASUREMENT REPORT			Reviewed by: Quality Manager
SAR Filename: SAR.240303161.ACJ	Test Dates: Mar. 25, 2004	TOUGHBOOK CF-50 w/ Intel WLAN Model: WM3B2200BG	FCC ID: ACJ9TGCF-503	Page 17 of 22

15. REFERENCES

- [1] Federal Communications Commission, ET Docket 93-62, Guidelines for Evaluating the Environmental Effects of Radiofrequency Radiation, Aug. 1996.
- [2] ANSI/IEEE C95.1 - 1991, *American National Standard safety levels with respect to human exposure to radio frequency electromagnetic fields, 300kHz to 100GHz*, New York: IEEE, Aug. 1992.
- [3] ANSI/IEEE C95.3 - 1991, *IEEE Recommended Practice for the Measurement of Potentially Hazardous Electromagnetic Fields - RF and Microwave*, New York: IEEE, 1992.
- [4] Federal Communications Commission, OET Bulletin 65 (Edition 97-01), Supplement C (Edition 01-01), *Evaluating Compliance with FCC Guidelines for Human Exposure to Radiofrequency Electromagnetic Fields*, July 2001.
- [5] IEEE Standards Coordinating Committee 34 – IEEE Std. P1528 D1.2 (April 2003), *Draft Recommended Practice for Determining the Peak Spatial-Average Specific Absorption Rate (SAR) in the Human Body Due to Wireless Communications Devices: Experimental Techniques*.
- [6] NCRP, National Council on Radiation Protection and Measurements, *Biological Effects and Exposure Criteria for RadioFrequency Electromagnetic Fields*, NCRP Report No. 86, 1986. Reprinted Feb. 1995.
- [7] V. Hombach, K. Meier, M. Burkhardt, E. Kuhn, N. Kuster, *The Dependence of EM Energy Absorption upon Human Head Modeling at 900 MHz*, IEEE Transaction on Microwave Theory and Techniques, vol. 44 no. 10, Oct. 1996, pp. 1865-1873.
- [8] N. Kuster and Q. Balzano, *Energy absorption mechanism by biological bodies in the near field of dipole antennas above 300MHz*, IEEE Transaction on Vehicular Technology, vol. 41, no. 1, Feb. 1992, pp. 17-23.
- [9] G. Hartsgrove, A. Kraszewski, A. Surowiec, *Simulated Biological Materials for Electromagnetic Radiation Absorption Studies*, University of Ottawa, Bioelectromagnetics, Canada: 1987, pp. 29-36.
- [10] Q. Balzano, O. Garay, T. Manning Jr., *Electromagnetic Energy Exposure of Simulated Users of Portable Cellular Telephones*, IEEE Transactions on Vehicular Technology, vol. 44, no.3, Aug. 1995.
- [11] W.H. Press, S.A. Teukolsky, W.T. Vetterling, and B.P. Flannery, *Numerical Recipes in C, The Art of Scientific Computing*, Second edition, Cambridge University Press, 1992.
- [12] Federal Communications Commission, OET Bulletin 65, Evaluating Compliance with FCC Guidelines for Human Exposure to Radiofrequency Electromagnetic Fields. Supplement C, Dec. 1997.
- [13] CENELEC CLC/SC111B, European Prestandard (prENV 50166-2), Human Exposure to Electromagnetic Fields High-frequency: 10kHz-300GHz, Jan. 1995.





PCTEST SAR TEST REPORT	 FCC MEASUREMENT REPORT			Reviewed by: Quality Manager
SAR Filename: SAR.240303161.ACJ	Test Dates: Mar. 25, 2004	TOUGHBOOK CF-50 w/ Intel WLAN Model: WM3B2200BG	FCC ID: ACJ9TGCF-503	Page 18 of 22

EXHIBIT J – SAR TEST DATA

PCTEST SAR TEST REPORT		FCC MEASUREMENT REPORT		Reviewed by: Quality Manager
SAR Filename: SAR.240303161.ACJ	Test Dates: Mar. 25, 2004	TOUGHBOOK CF-50 w/ Intel WLAN Model: WM3B2200BG	FCC ID: ACJ9TGCF-503	Page 19 of 22

SAR Data Report 04032514

Start : 25-Mar-04 11:16:37 am
End : 25-Mar-04 11:23:20 am
Code Version : 4.08
Robot Version: 4.08

Product Data:

Type : PANASONIC
Model Number : CF-50
Serial Number : 4GMTA00006
Frequency : 2412 MHz
Transmit Pwr : 0.054 W
Antenna Type : Inverted F
Antenna Posn. : Fixed

Measurement Data:

Phantom Name : SAM-FLAT-BP
Phantom Type : Uniphantom
Tissue Type : Muscle
Tissue Dielectric : 55.000
Tissue Conductivity : 1.970
Tissue Density : 1.000
Robot Name : CRS

Probe Data:

Probe Name : PCT003
Probe Type : E Fld Triangle
Frequency : 2450 MHz
Tissue Type : Muscle
Calibrated Dielectric : 54.370
Calibrated Conductivity : 1.970
Calibrated Density : 1.000
Probe Offset : 2.400 mm
Conversion Factor : 6.700
Probe Sensitivity : 3.285 3.652 4.167 mV/(mW/cm^2)
Amplifier Gains : 20.00 20.00 20.00

Sample:

Rate: 6000 Samples/Sec
Count: 1000 Samples
NIDAQ Gain: 5

Comments:

DSSS MODE CH-1
BODY SAR
CF=1; Amb. Temp= 23.1 'C; Liq. Temp=20.8 'C

Power Drop Test:

Reading @ start = 0.088
Reading @ End = 0.088
Power at End = 99.6%

Area Scan - Max Peak SAR Value at x=24.0 y=-7.0 = 0.50 W/kg

Zoom Scan - Max Peak SAR Value at x=20.0 y=-7.0 z=0.0 = 1.26 W/kg

Max 1g SAR at x=22.0 y=-7.0 z=0.0 = 0.52 W/kg

Max 10g SAR at x=24.0 y=-6.0 z=0.0 = 0.22 W/kg

SAR - Z Axis
at Hotspot x:20.0 y:-7.0

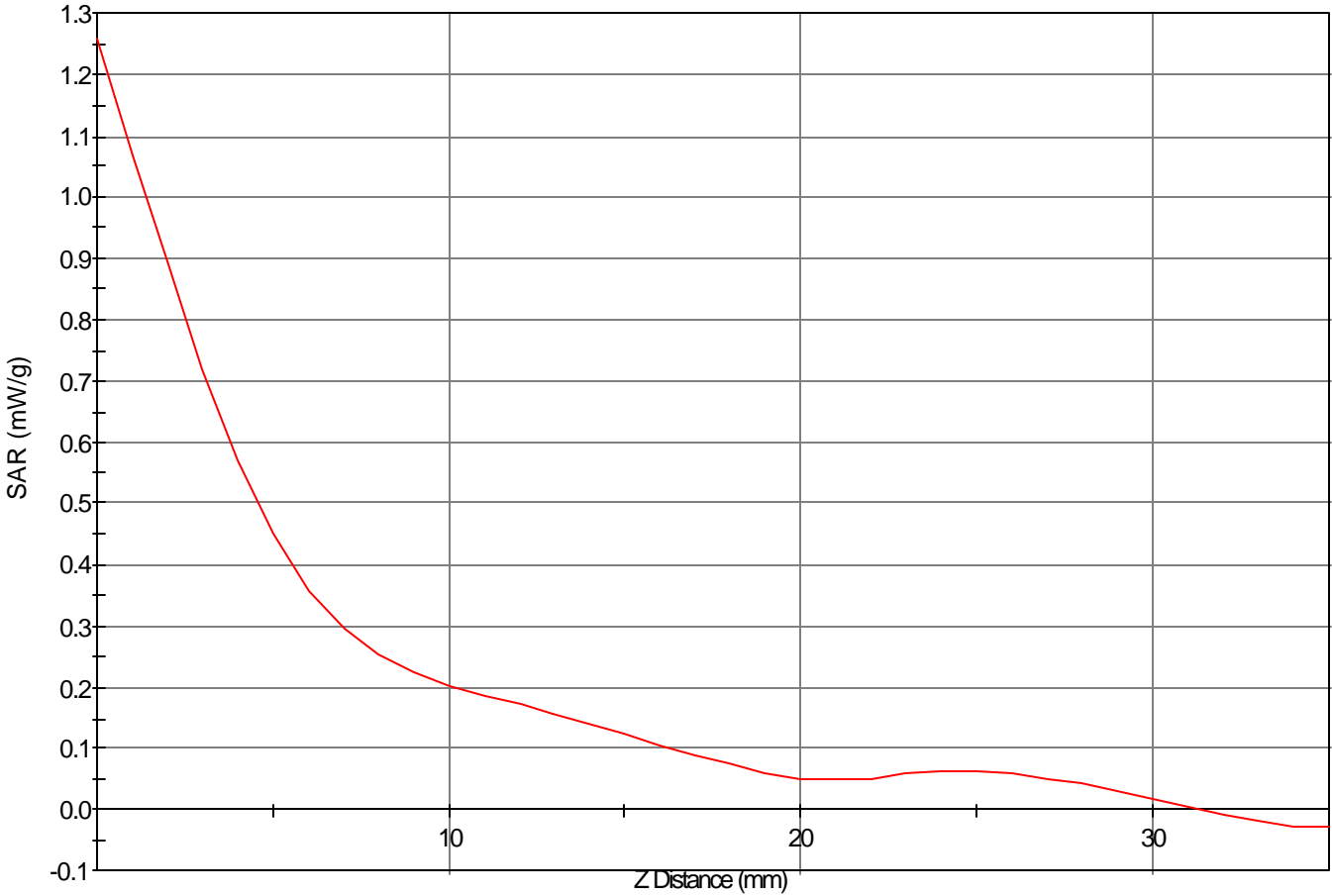

1g SAR Values

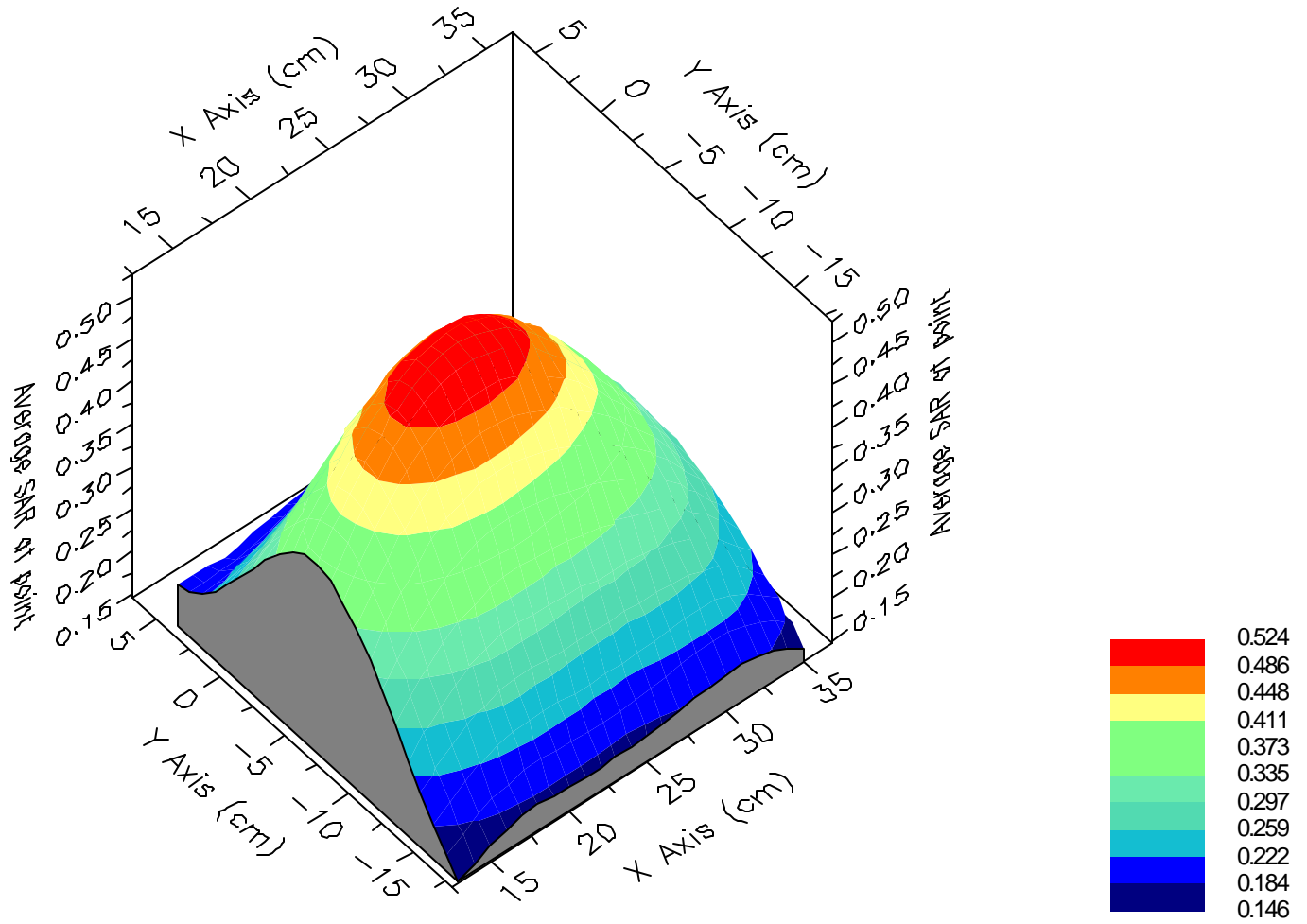

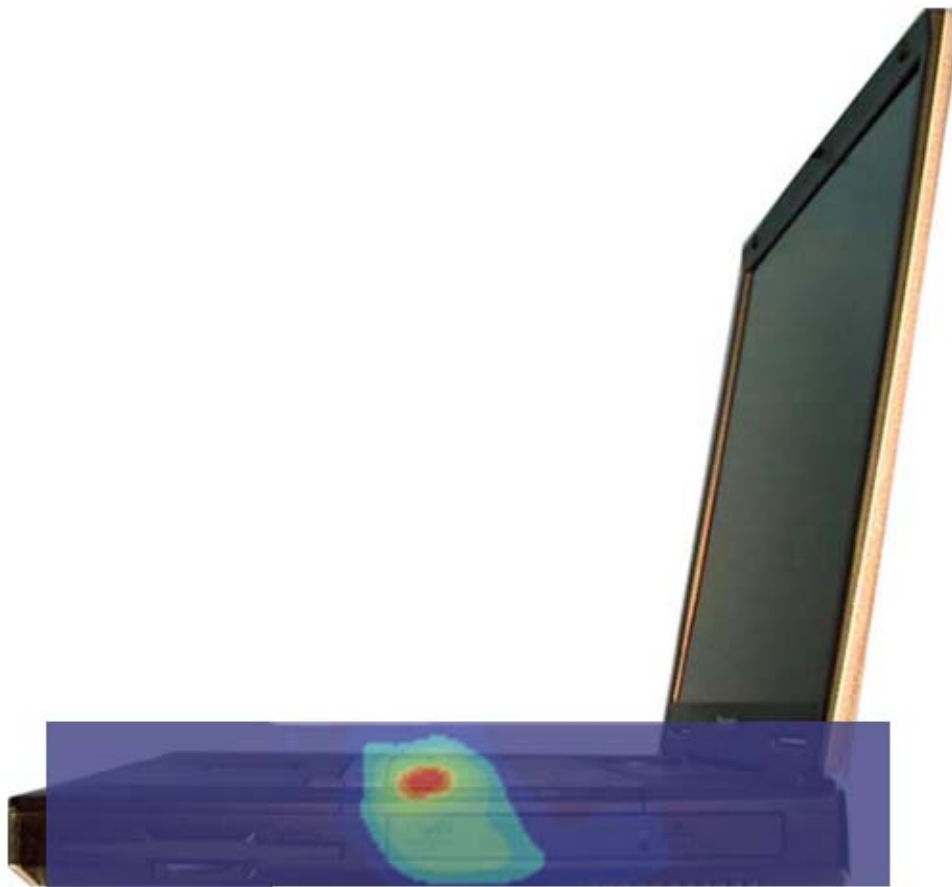

SAR Data Report 04032526

Start : 25-Mar-04 01:10:10 pm
End : 25-Mar-04 01:16:58 pm
Code Version : 4.08
Robot Version: 4.08

Product Data:

Type : PANASONIC
Model Number : CF-50
Serial Number : 4GMTA00006
Frequency : 2412 MHz
Transmit Pwr : 0.054 W
Antenna Type : Inverted F
Antenna Posn. : Fixed

Measurement Data:

Phantom Name : SAM-FLAT-BP
Phantom Type : Uniphantom
Tissue Type : Muscle
Tissue Dielectric : 55.000
Tissue Conductivity : 1.970
Tissue Density : 1.000
Robot Name : CRS

Probe Data:

Probe Name : PCT003
Probe Type : E Fld Triangle
Frequency : 2450 MHz
Tissue Type : Muscle
Calibrated Dielectric : 54.370
Calibrated Conductivity : 1.970
Calibrated Density : 1.000
Probe Offset : 2.400 mm
Conversion Factor : 6.700
Probe Sensitivity : 3.285 3.652 4.167 mV/(mW/cm^2)
Amplifier Gains : 20.00 20.00 20.00

Sample:

Rate: 6000 Samples/Sec
Count: 1000 Samples
NIDAQ Gain: 5

Comments:

DSSS MODE CH-1
BODY SAR
CF=1; Amb. Temp= 23.1 'C; Liq. Temp=20.8 'C

Power Drop Test:

Reading @ start = 0.005
Reading @ End = 0.005
Power at End = 102.0%

Area Scan - Max Peak SAR Value at x=33.0 y=2.0 = 0.02 W/kg

Zoom Scan - Max Peak SAR Value at x=38.0 y=0.0 z=0.0 = 0.07 W/kg

Max 1g SAR at x=38.0 y=1.0 z=0.0 = 0.03 W/kg

Max 10g SAR at x=35.0 y=2.0 z=0.0 = 0.01 W/kg

SAR - Z Axis
at Hotspot x:38.0 y:0.0

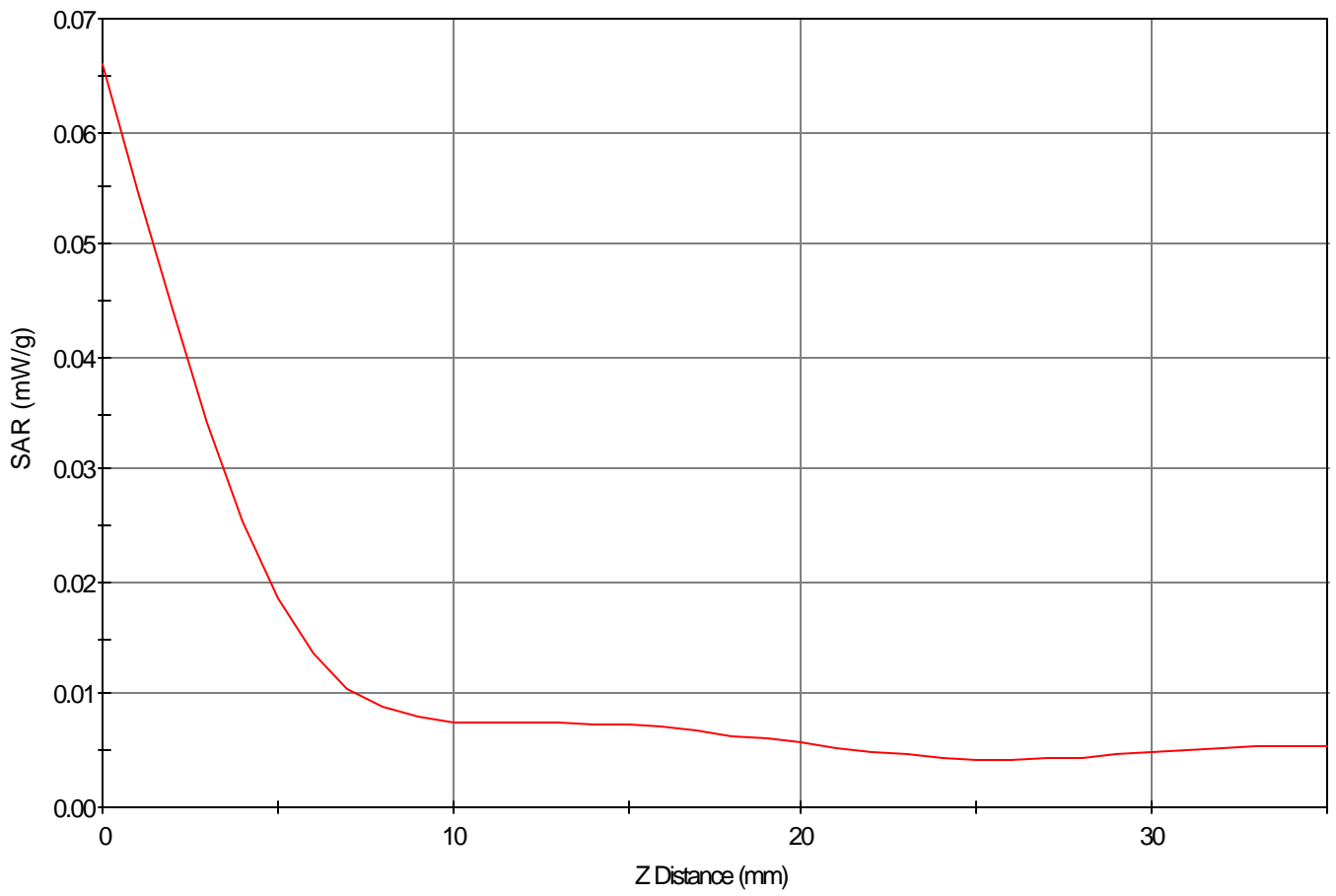

1g SAR Values

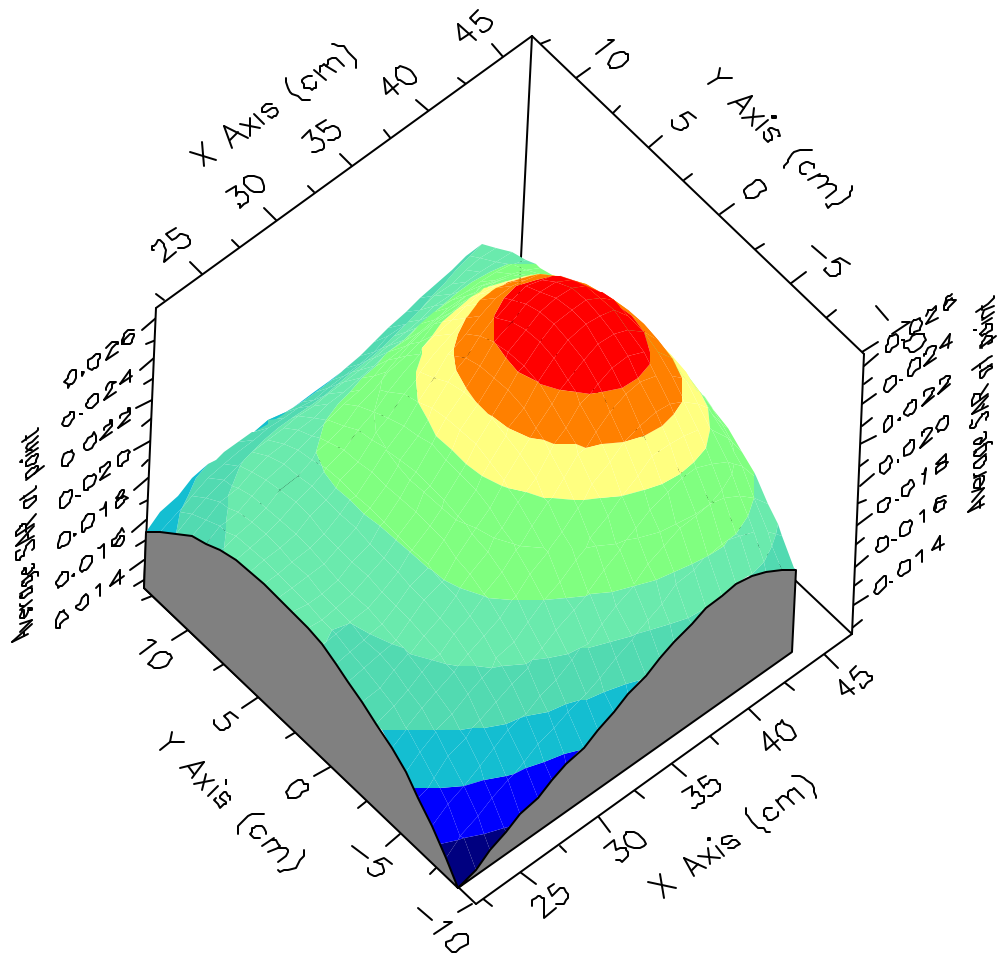

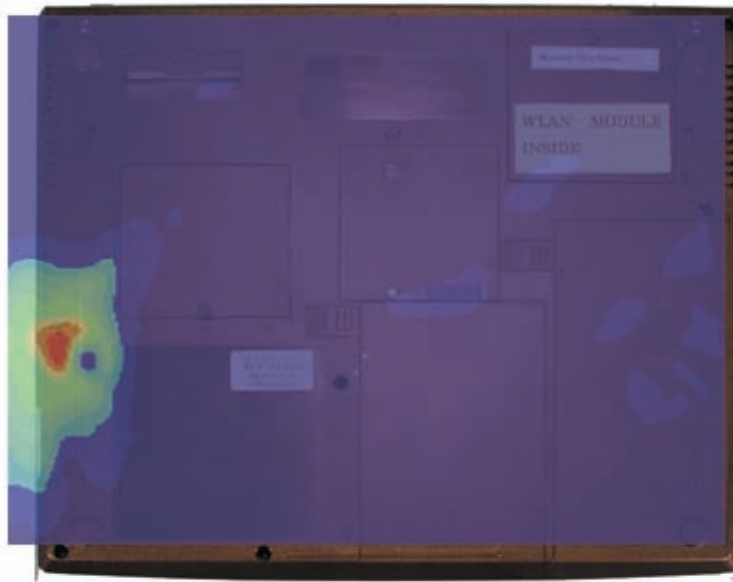

EXHIBIT K – SAR TEST SETUP PHOTOGRAPHS





PCTEST SAR TEST REPORT		FCC MEASUREMENT REPORT		Reviewed by: Quality Manager
SAR Filename: SAR.240303161.ACJ	Test Dates: Mar. 25, 2004	TOUGHBOOK CF-50 w/ Intel WLAN Model: WM3B2200BG	FCC ID: ACJ9TGCF-503	Page 20 of 22

EXHIBIT L – DIPOLE VALIDATION

PCTEST SAR TEST REPORT		FCC MEASUREMENT REPORT		Reviewed by: Quality Manager
SAR Filename: SAR.240303161.ACJ	Test Dates: Mar. 25, 2004	TOUGHBOOK CF-50 w/ Intel WLAN Model: WM3B2200BG	FCC ID: ACJ9TGCF-503	Page 21 of 22

SAR Data Report 04032507

Start : 25-Mar-04 10:06:48 am
End : 25-Mar-04 10:12:47 am
Code Version : 4.08
Robot Version: 4.08

Product Data:

Type : Verification
Model Number : E-010
Serial Number : PCT003
Frequency : 2450 MHz
Transmit Pwr : 0.050 W
Antenna Type : Dipole
Antenna Posn. : Verification

Measurement Data:

Phantom Name : SAM-FLAT-BP
Phantom Type : Uniphantom
Tissue Type : Brain
Tissue Dielectric : 39.300
Tissue Conductivity : 1.830
Tissue Density : 1.000
Robot Name : CRS

Probe Data:

Probe Name : PCT003
Probe Type : E Fld Triangle
Frequency : 2450 MHz
Tissue Type : Brain
Calibrated Dielectric : 39.900
Calibrated Conductivity : 1.830
Calibrated Density : 1.300
Probe Offset : 2.400 mm
Conversion Factor : 6.100
Probe Sensitivity : 3.285 3.652 4.167 mV/(mW/cm^2)
Amplifier Gains : 20.00 20.00 20.00

Sample:

Rate: 6000 Samples/Sec
Count: 1000 Samples
NIDAQ Gain: 5

Comments:

System Verification

CF=1; Amb. Temp= 23.1 'C; Liq. Temp=20.8 'C

Power Drop Test:

Reading @ start = 1.566
Reading @ End = 1.606
Power at End = 102.6%

Area Scan - Max Peak SAR Value at x=0.0 y=2.0 = 2.20 W/kg

Zoom Scan - Max Peak SAR Value at x=0.0 y=2.0 z=0.0 = 5.07 W/kg

Max 1g SAR at x=1.0 y=3.0 z=0.0 = 2.47 W/kg

Max 10g SAR at x=1.0 y=3.0 z=0.0 = 1.07 W/kg

Validation Results at 0.05 W:

Peak Nominal = 5.2, Error: -2.65 %
1g Nominal = 2.6, Error: -5.62 %

SAR - Z Axis
at Hotspot x:0.0 y:2.0

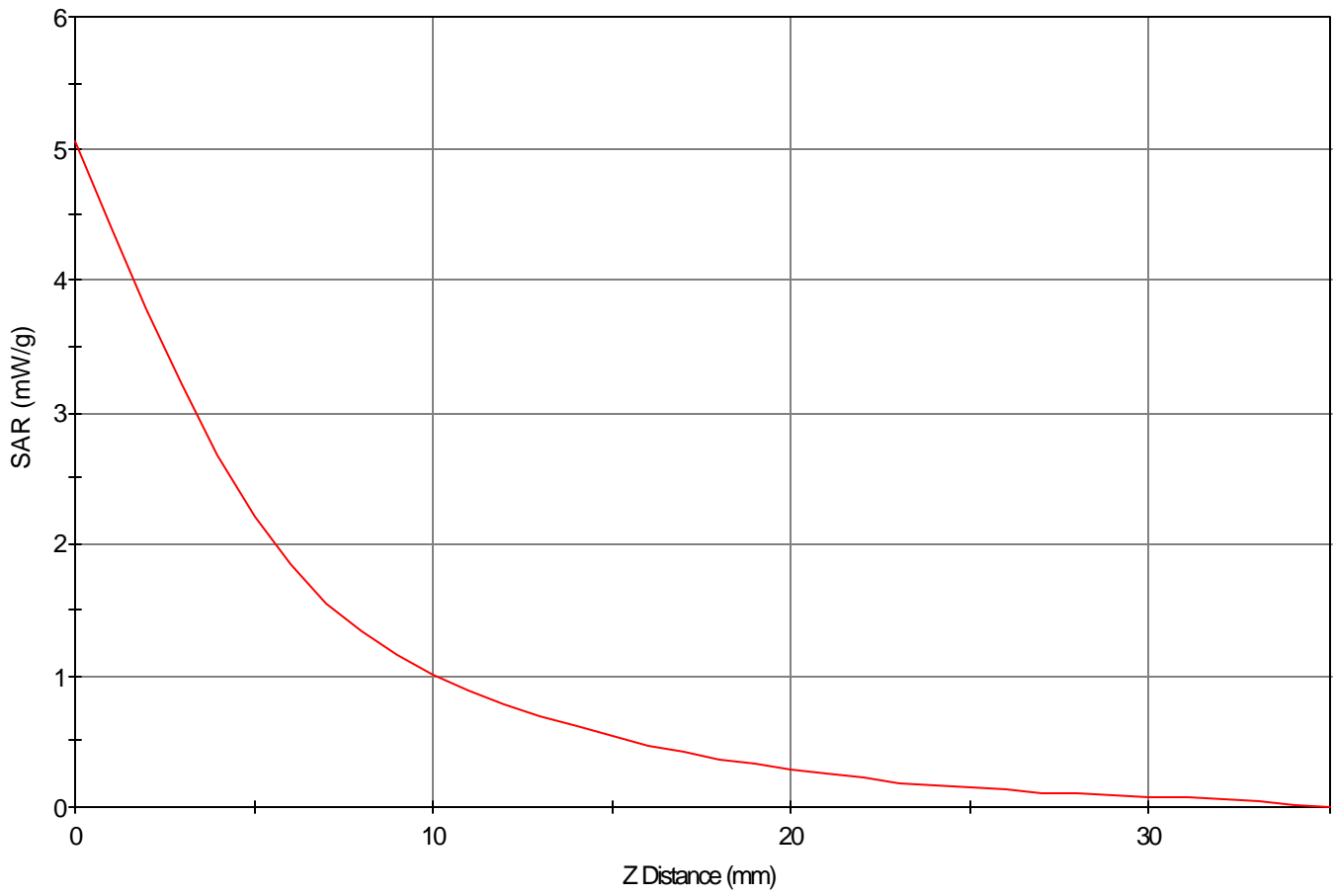

1g SAR Values

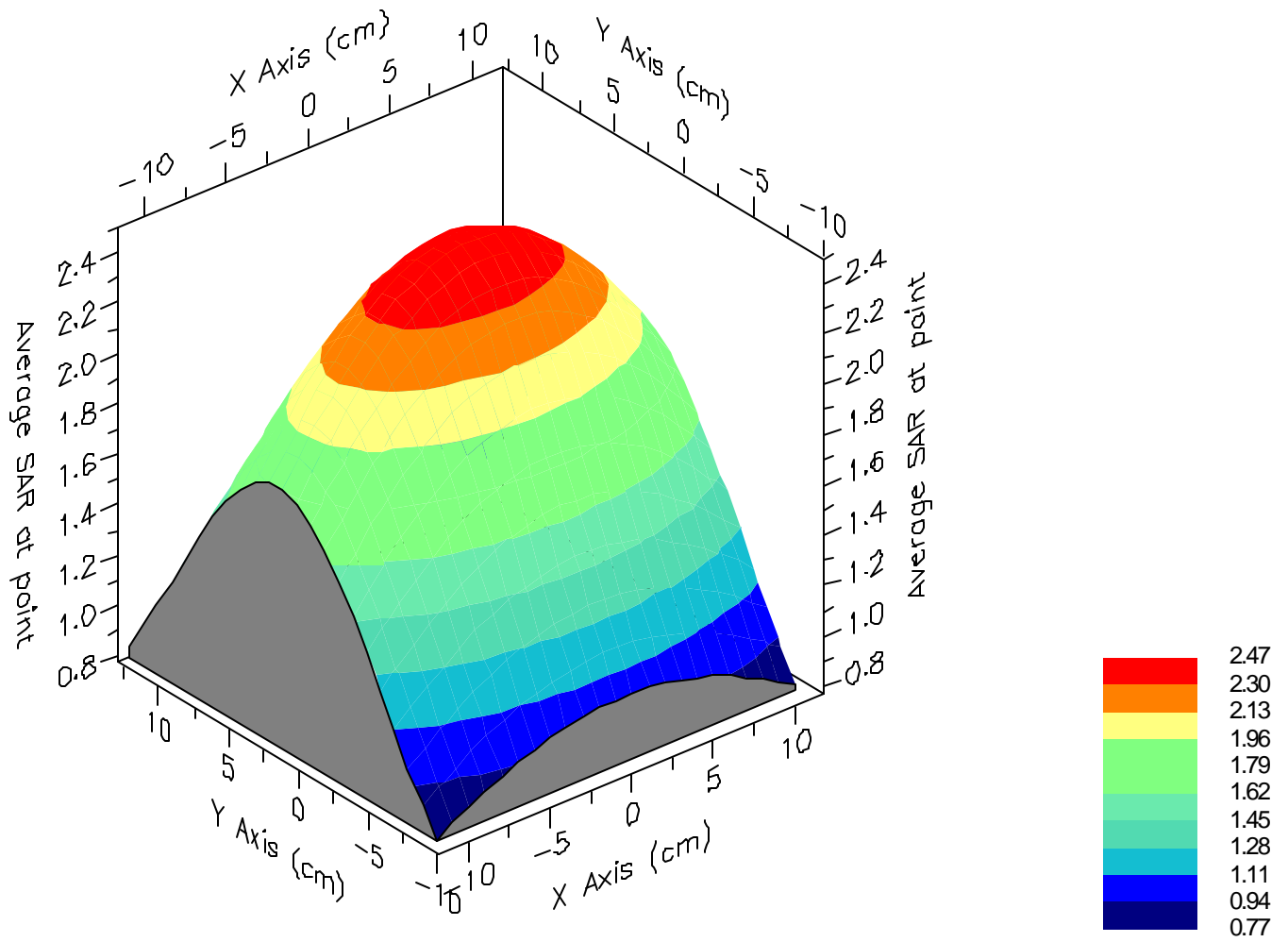

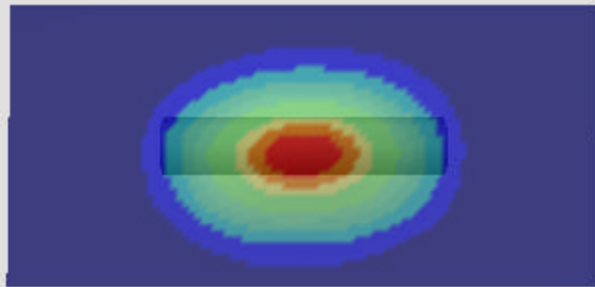



EXHIBIT M – PROBE CALIBRATION

PCTEST SAR TEST REPORT		FCC MEASUREMENT REPORT		Reviewed by: Quality Manager
SAR Filename: SAR.240303161.ACJ	Test Dates: Mar. 25, 2004	TOUGHBOOK CF-50 w/ Intel WLAN Model: WM3B2200BG	FCC ID: ACJ9TGCF-503	Page 22 of 22

Probe E-010

SN: PCT003

Manufactured:	November 4, 2002
Calibrated:	January 3, 2003
Re-calibrated:	January 6, 2004

Calibrated for the IDX System

PCTEST Calibration Laboratory

Approved By:



Alfred Cirwithian
Vice President Engineering

Calibration is performed according to IEEE Std. P1528 D1.2 (April, 2003)
and all test equipment used is traceable to U.S. NIST.

PCTEST Calibration Laboratory

6660-B Dobbin Road
Columbia, Maryland 21045 USA

Calibration Summary

Model: E-010

S/N: PCT003

OFFSET (cm)	ANGLE (deg)
0.24	54.73

Tissue Type	Frequency (MHz)	Dielectric Constant ϵ_r	Conductivity (S/m) S	Conversion Factor g_x, g_y, g_z
Brain	835	40.24	0.90	5.60
Brain	1900	41.89	1.39	5.77
Brain	2450	39.90	1.83	6.10
Muscle	835	54.03	0.98	6.00
Muscle	1900	51.77	1.58	6.30
Muscle	2450	54.37	1.97	6.70

Frequency (MHz)	Isotropy	
	%	dB
835	5.26	0.22
1900	3.83	0.16
2450	5.45	0.23

Boundary Effect < 2%, 2.6 mm from probe tip to phantom

Diode Compression Point: 76 mV

Environmental Conditions:

Temperature: 22.6 °C
Relative Humidity: 41%
Barometer: 101.2 kPa

This probe was calibrated under the IEEE Std 1309-1966, *IEEE Standard for Calibration of Electromagnetic Field Sensors and Probes, Excluding Antennas*, from 9 kHz to 40 GHz.

PCTEST Calibration Laboratory

6660-B Dobbin Road
 Columbia, Maryland 21045 USA

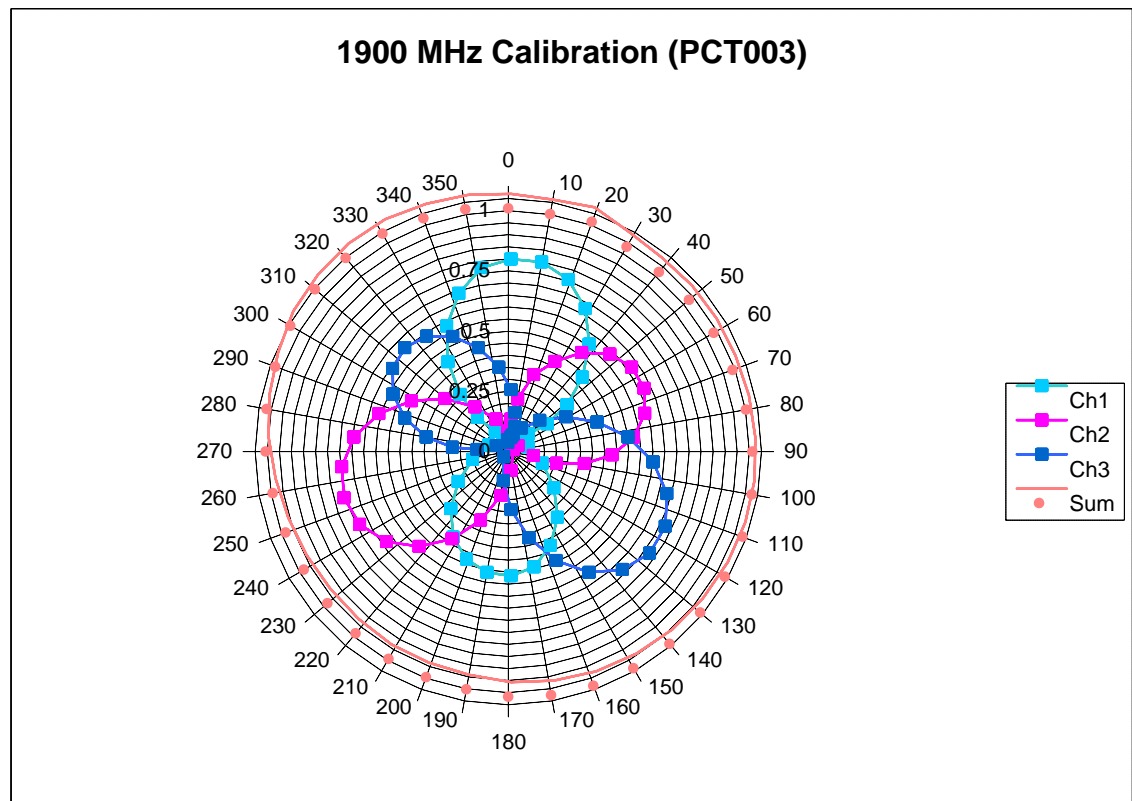
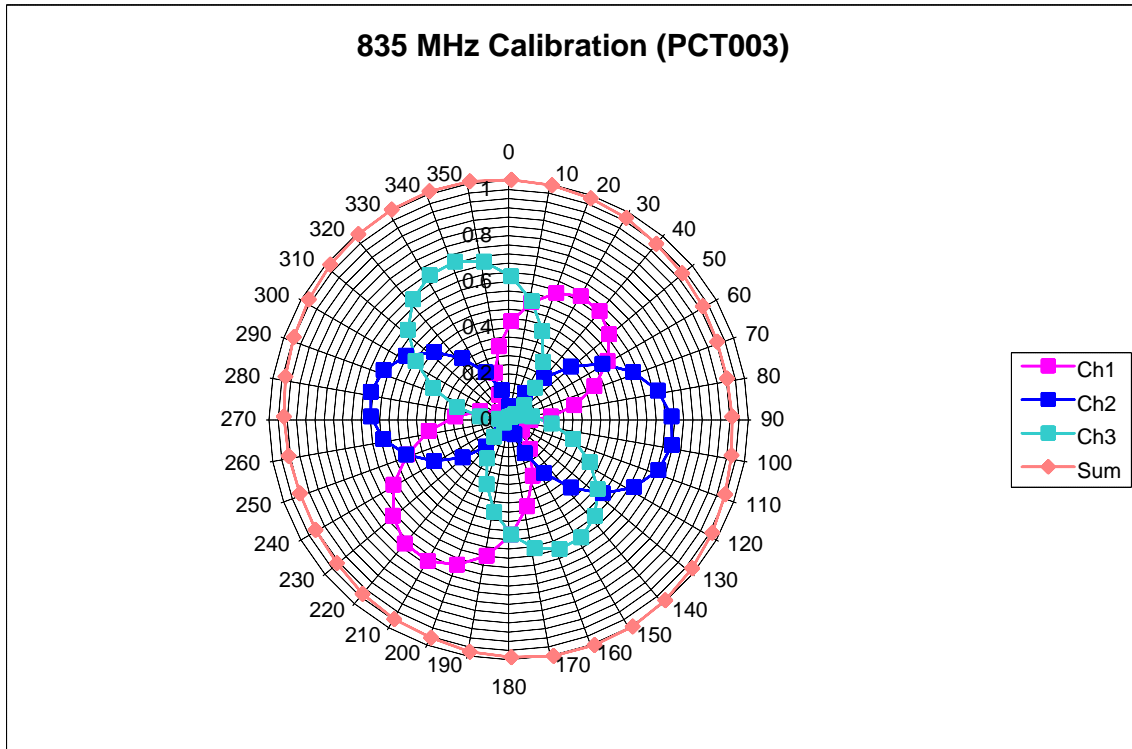

PCTEST Calibration Laboratory

6660-B Dobbin Road
 Columbia, Maryland 21045 USA

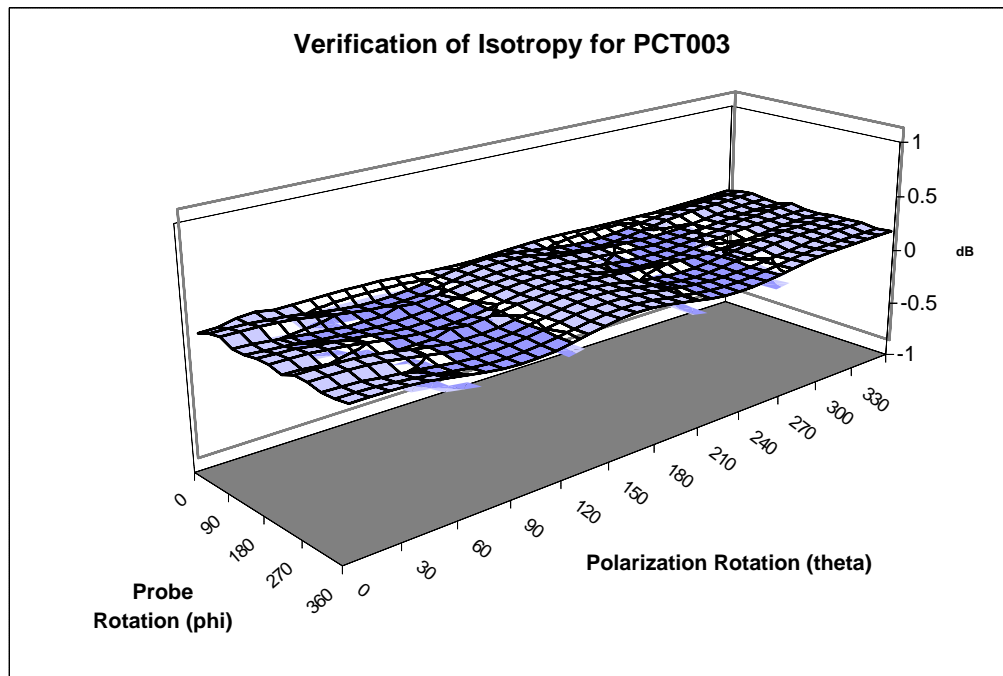
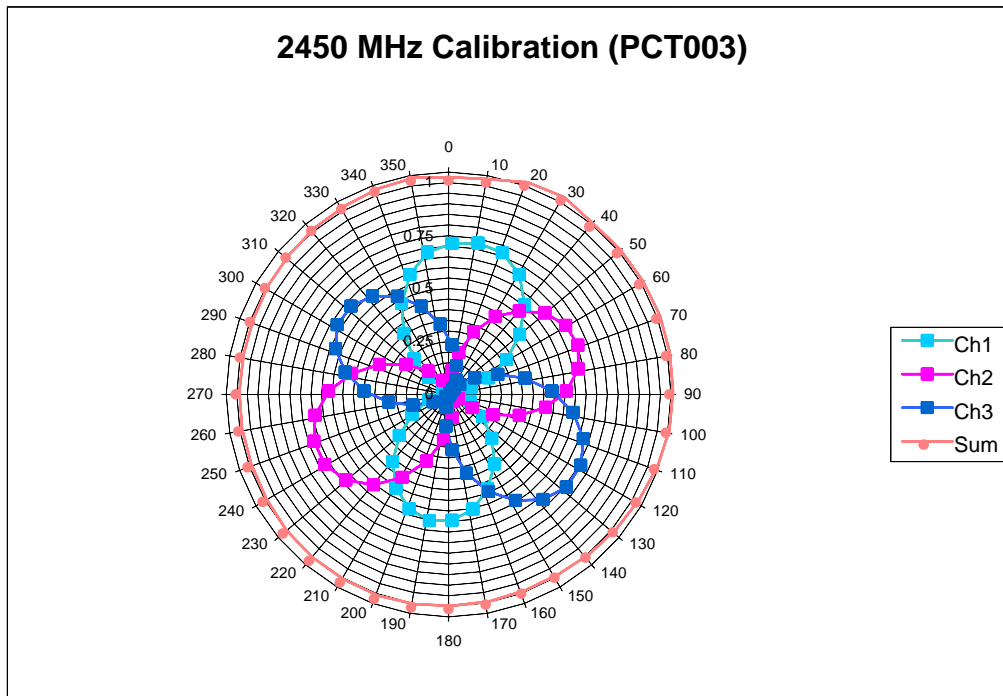

PCTEST Calibration Laboratory

6660-B Dobbin Road
Columbia, Maryland 21045 USA

TEM Calibration Plot
Date: 5-Jan-04 01:54:12 pm
Probe Name: PCT003
Frequency: 835

Sensitivity: Ch1: 2.809 Ch2: 3.327 Ch3: 3.274 mV/(mW/cm²)
Isotropicity: 5.26% 0.22 db Min=0.949 Max=1.054

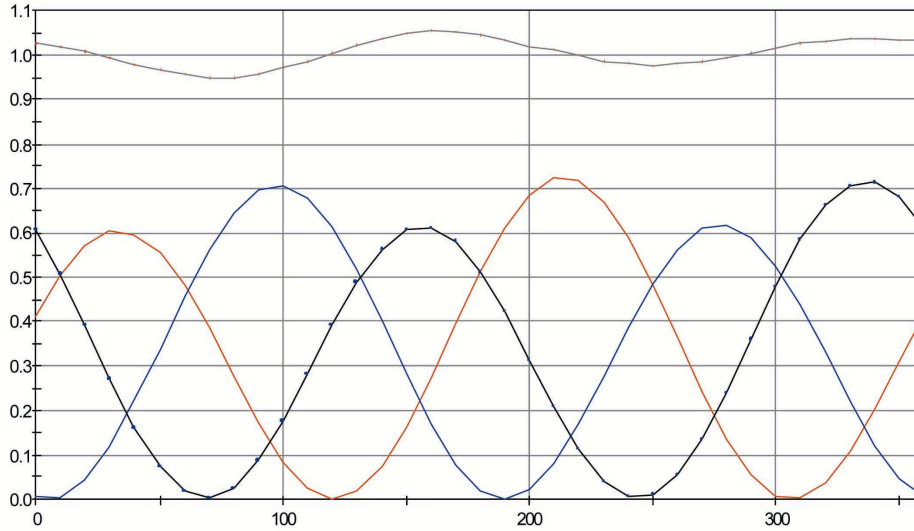

TEM Calibration Plot
Date: 6-Jan-04 12:13:36 pm
Probe Name: PCT003
Frequency: 1900

Sensitivity: Ch1: 3.331 Ch2: 3.804 Ch3: 3.975 mV/(mW/cm²)
Isotropicity: 3.83% 0.16 db Min=0.972 Max=1.049

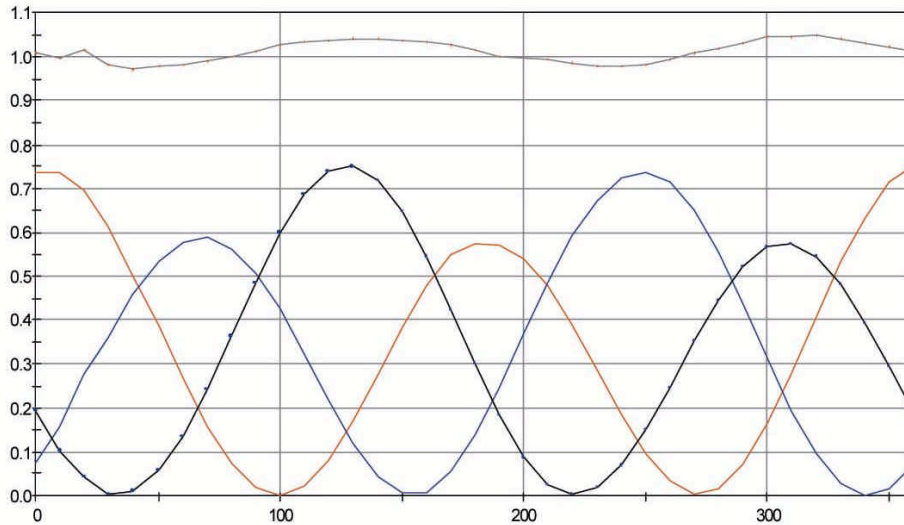

PCTEST Calibration Laboratory

6660-B Dobbin Road
Columbia, Maryland 21045 USA

TEM Calibration Plot
Date: 6-Jan-04 1:10:39 pm
Probe Name: PCT003
Frequency: 2450

Sensitivity: Ch1: 3.285 Ch2: 3.652 Ch3: 4.167 mV/(mW/cm²)
Isotropy: 2.99% 0.13 db Min=0.997 Max=1.057

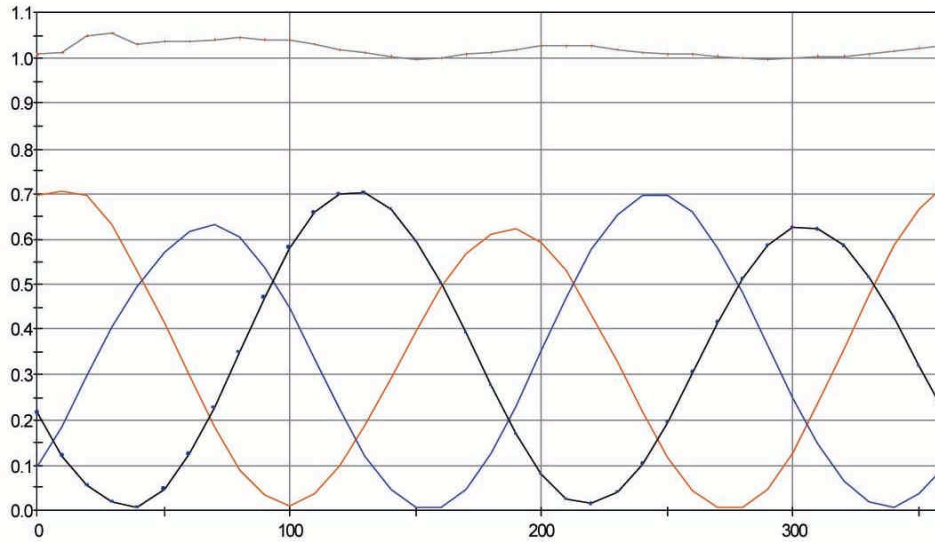

PCTEST Calibration Laboratory

6660-B Dobbin Road
Columbia, Maryland 21045 USA

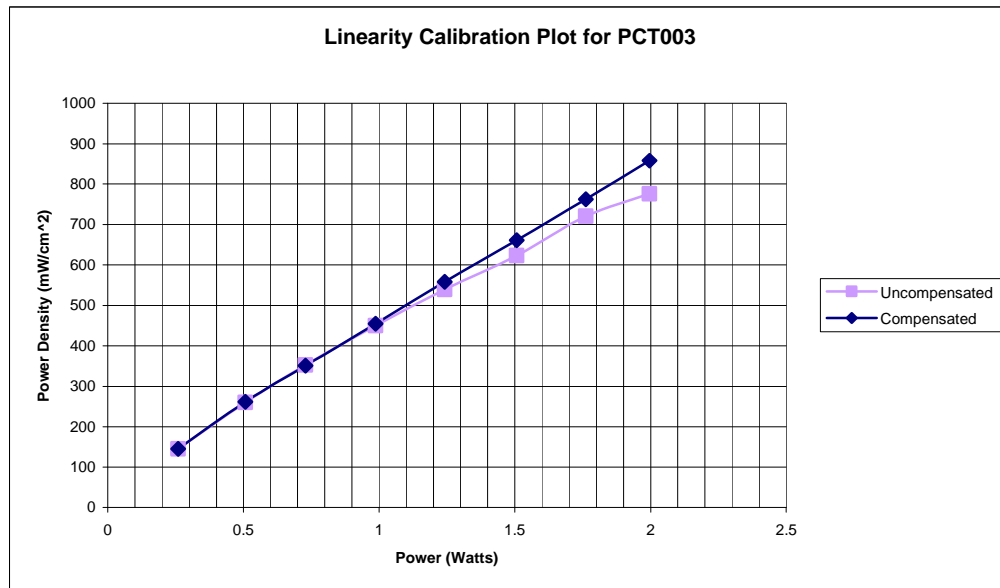

Probe Physical Characteristics

Serial Number:	PCT003
Sensor Offset:	2.4 mm
Sensor Length:	2.5 mm
Tip Enclosure:	Glass
Tip Diameter:	7 mm
Tip Length:	40 mm
Total Length:	290 mm

PCTEST Calibration Laboratory

6660-B Dobbin Road
Columbia, Maryland 21045 USA

Test Equipment

The test equipment used during the probe calibration are listed as follows:

EQUIPMENT SPECIFICATIONS		
Type	Calibration Due	Asset Number/ Serial Number
CRS Robot F3	February 2004	RAF0134133
CRS C500C Motion Controller	February 2004	RCB0003303
CRS Teach Pendant (Joystick)	February 2004	STP0132231
DELL Computer, Pentium 4 1.6 GHz, Windows 2000™	February 2004	4PJZ111
Flat SAM Phantom (P-SAM-FLAT)	February 2004	94X-097
IDX Robot End Effector (EE-103-C)	February 2004	07111223
IDX Probe Amplifier	February 2004	07111113
Validation Dipole D-835S	October 2004	PCT441
Validation Dipole D1900V2	February 2005	PCT512
Validation Dipole D-2450S	October 2004	PCT641
HP-778D Dual-Directional Coupler (0.1 ~ 2.0 GHz)	November 2004	PCT664
MicroCircuits Directional Coupler (4.0 ~ 8.0 GHz)	November 2004	PE2204-6
Amplifier Research 5S1G4 Power Amp	January 2005	PCT540
IFI T184-10 Power Amplifier (4.0 ~ 18.0 GHz)	December 2004	5957
HP-8648D (9kHz ~ 4 GHz) Signal Generator	January 2005	PCT526
HP-8753E (30kHz ~ 6GHz) Network Analyzer	January 2005	PCT552
Rohde & Schwarz Power Meter NRVS 1020.1809.02	January 2005	835360/079
Rohde & Schwarz Power Sensor NRV-Z53 858.0500.02	April 2005	846076/007
HP85070B Dielectric Probe Kit	January 2005	PCT501
IFI CC110EXX TEM Cell (DC to 2000 MHz)	January 2005	PCT498
EMCO 3115 Horn Antenna (2.0 ~ 18.0 GHz)	August 2004	PCT496
Guidline 5150 Precision Dual-Thermometer	November 2004	66145