

Test Report

Product	DECT Wireless Headset		
Name and address of the applicant	Panasonic Corporation of North America Two Riverside Plaza, Newark New Jersey, United States		
Name and address of the manufacturer	Panasonic Entertainment & Communications Co., Ltd. 4-1-62 Minoshima, Hakata-ku Fukuoka, 812-8531 Japan		
Model	WX-CH458P		
Rating	1.2 V DC (NiMH battery, 1x AA cell)		
Trademark	Panasonic		
Additional information	DECT 6.0		
Tested according to	FCC Part 15, subpart D Isochronous UPCS Device, 1920 – 1930 MHz ISED Canada RSS-213, Issue 3 2 GHz License-Exempt Personal Communications Services (LE-PCS) Devices		
Order number	PRJ0067093		
Tested in period	2024-11-13 to 2024-11-15		
Issue date	2024-12-04		
Name and address of the testing laboratory	 Nemko Scandinavia AS Instituttveien 6 2007 Kjeller, Norway www.nemko.com	CAB Number: FCC: NO0001 ISED: NO0470 ISED No: 2040D-1	 
An accredited technical test executed under the Norwegian accreditation scheme			
 Prepared by [Frode Sveinsen]		 Approved by [Jan G Eriksen]	
This report was originally distributed electronically with digital signatures. For more information, please contact Nemko Scandinavia AS.			

Revision history

Revision	Date	Comment	Sign
A	2024-12-04	First Edition	FS

GENERAL REMARKS

This report applies only to the sample(s) tested. It is the manufacturer's responsibility to ensure the additional production units of this product are manufactured with identical electrical and mechanical components. The manufacturer is solely responsible for any modifications to the product that could result in non-compliance with the relevant regulations.

This report shall not be reproduced except in full without the written approval of Nemko.

Any use which a third party makes of this report, or any reliance on or decisions to be made based on it, are the responsibility of such third parties. Nemko Group accepts no responsibility for damage suffered by any third party because of decisions made or actions based on this report.

Opinions expressed within this report regarding general assessments and qualifications for PASS or FAIL to the standards limits and requirements, are not part of the current accreditation. Neither are opinions expressed regarding model variants covered by the testing of this report.

CALIBRATION

All instruments used in the tests given in this test report are calibrated and traceable to national or international standards. Between calibrations all test set-ups are controlled and verified on a regular basis by periodic checks to ensure, with 95% confidence, that the instruments remain within the calibrated levels.

MEASUREMENT UNCERTAINTY

Measurement uncertainties are calculated or considered for all instruments and instrument set-ups used during these tests. Uncertainty figures are found in a separate clause in this report.

CONTENTS

1	INFORMATION	4
1.1	Tested Item	4
1.2	Description of Tested Device	4
1.3	Test Conditions	4
1.4	Test Engineers	4
1.5	Digital Modulation Techniques	5
1.6	Antenna Requirement	5
1.7	Channel Frequencies	5
1.8	Other Comments	5
2	TEST REPORT SUMMARY	6
2.1	General	6
2.2	Test Summary	6
3	TEST RESULTS	8
3.1	Automatic Discontinuation of Transmission	8
3.2	Peak Power Output	9
3.3	Emission Bandwidth B	11
3.4	Power Spectral Density	13
3.5	In-Band Unwanted Emissions, Conducted	15
3.6	Out-of-band Emissions, Conducted	17
3.7	Carrier Frequency Stability	22
3.8	Frame Repetition Stability	23
3.9	Frame Period and Jitter	23
3.10	Monitoring Threshold, Least Interfered Channel	25
3.11	Threshold Monitoring Bandwidth	27
3.12	Reaction Time and Monitoring Interval	28
3.13	Time and Spectrum Window Access Procedure	30
3.14	Acknowledgements and Transmission Duration	31
3.15	Dual Access Criteria Check	33
3.16	Alternative Monitoring Interval	35
4	MEASUREMENT UNCERTAINTY	36
5	TEST SETUPS	37
5.1	Frequency Measurements	37
5.2	Timing Measurements	37
5.3	Conducted Emission Test	37
5.4	Power Line Conducted Emissions Test	37
5.5	Monitoring Tests	38
6	TEST EQUIPMENT USED	39

1 INFORMATION

1.1 Tested Item

Product	DECT Wireless Headset
Manufacturer	Panasonic
Model	WX-CH458P
Serial number	Conducted Sample: PRJ00670930001 Monitoring Sample: PRJ00670930002 Radiated Sample: PRJ00670930003
FCC ID	ACJ9TAWX-CH458P
ISED ID	216A-WXCH458P
Hardware version	PULB1123ZA-GL
Software version	Ver1.00R00
Frequency Range	1921.536 – 1928.448 MHz
Number of Channels	5 RF Channels, 5x12 = 60 TDMA Duplex Channels
Type of Modulation	Digital (Gaussian Frequency Shift Keying)
Conducted Output Power	83 mW (Peak)
Antenna Connector	None
Number of Antennas	1
Antenna Diversity	No
Desktop Charger	N/A
Power Supply	Secondary Battery (1x AA NiMH cell)
Interfaces	USB-C for service-use only
Companion Device	WX-CC412BP

1.2 Description of Tested Device

The EUT is a DECT Headset and is an initiating device as described in ANSI C63.17 and is designed to operate together with a DECT Base Station, which is the responding device.

1.3 Test Conditions

Temperature:	20 – 24 °C
Relative humidity:	30 – 50 %
Normal test voltage:	1.2 V DC

The values are the limit registered during the test period. All tests were performed with a fully charged battery.

1.4 Test Engineers

Frode Sveinsen

1.5 Digital Modulation Techniques

The EUT uses Multi Carrier / Time Division Multiple Access / Time Division Duplex and Digital GFSK modulation. For further details see the operational description provided by the applicant.

Requirement, FCC 15.319(b), RSS-213 Issue 3, clause 5.1:

All transmissions must use only digital modulation techniques.

1.6 Antenna Requirement

Does the EUT have detachable antenna(s)?	<input type="checkbox"/> YES	<input checked="" type="checkbox"/> NO
If detachable, is the antenna connector(s) non-standard?	<input type="checkbox"/> YES	<input type="checkbox"/> NO
The tested equipment has only integral antennas. The conducted tests were performed on a sample with a temporary antenna connector.		

Requirement: FCC 15.203, 15.204, 15.317, RSS-GEN Issue 5, clause 6.8

1.7 Channel Frequencies

UPCS CHANNEL	FREQUENCY (MHz)
Upper Band Edge	1930.000
0 (Highest)	1928.448
1	1926.720
2	1924.992
3	1923.264
4 (Lowest)	1921.536
Lower Band Edge	1920.000

Requirement: FCC 15.303, RSS-213 Issue 3, clause 5.1:

Within 1920 -1930 MHz band for isochronous devices.

1.8 Other Comments

The Monitoring and Time and Spectrum Window Access tests were performed with Test Set-Up 6 (Ref. clause 5). A clock signal from the Base Station was used to synchronize the Pulse Pattern Generator and the Spectrum Analyzer to the start of the DECT time window. The EUT was limited by administrative commands to operate on only two frequency carriers. For the tests where the EUT was required to operate on only one frequency carrier, one carrier was blocked by applying a CW interfering signal from RF Generator 3. The Pulse Pattern Generator was used to apply time synchronized interference to time windows where this was required.

Since the EUT was programmed to operate on only two RF carriers, it was only necessary with two RF generators for the monitoring tests, however a third generator was applied for the tests that required specific time slots to be blocked.

This EUT supports Least Interfered Channel procedure (LIC), the Monitoring and Time and Spectrum Window Access tests were conducted as specified for EUTs that support LIC procedure.

All tests were performed in conducted mode with a temporary antenna connector.

2 TEST REPORT SUMMARY

2.1 General

The tests were conducted on a sample of the equipment for demonstrating compliance with one or more of the following standards:

Standard	Description
FCC CFR 47 Part 15D	Unlicensed Personal Communications Service Devices
ISED RSS-213, Issue 3	2 GHz Licence-Exempt Personal Communications Services (LE-PCS) Devices
ISED RSS-GEN Issue 5	General Requirements for Compliance of Radio Apparatus

The following standards and documents were used for one or more measurements:

Standard	Description
ANSI C63.4-2014	Unintentional Radiators
ANSI C63.17-2013	Unlicensed Personal Communications Service (UPCS) Devices
FCC KDB 412172 D01	Determining ERP and EIRP

All measurements are traceable to national standards.

A description of the test facility is on file with FCC and ISED Canada.

<input checked="" type="checkbox"/> New Submission	<input checked="" type="checkbox"/> Production Unit
<input type="checkbox"/> Class II Permissive Change	<input type="checkbox"/> Pre-production Unit
PUE Equipment Class	<input type="checkbox"/> Family Listing

2.2 Test Summary

Name of test	FCC CFR 47 Paragraph #	ISED RSS-213 Paragraph #	Verdict
Power-Line Conducted Emission	15.107(a) 15.207(a)	5.4 RSS-GEN 7.2 / 8.8	N/A ¹
Digital Modulation Techniques	15.319(b)	5.1	Complies
Labeling requirements	15.19(a)(3)	RSP-100 3.1	Complies
Antenna Requirement	15.317, 15.203	RSS-GEN 6.8	Complies
Channel Frequencies	15.303	5.1	Complies
Automatic discontinuation of transmission	15.319(f)	5.2	Complies
Emission Bandwidth	15.323(a)	5.5	Complies
Occupied Bandwidth	N/A	RSS-GEN 6.7	Complies
In-band emissions	15.323(d)	5.8.2	Complies
Out-of-band emissions	15.323(d)	5.8.1	Complies
Peak Transmit Power and Antenna Gain	15.319(c)(e), 15.31(e)	5.6 RSS-GEN 8.3	Complies
Power Spectral Density	15.319(d)	5.7	Complies
Carrier frequency stability	15.323(f)	5.3	Complies
Frame repetition stability	15.323(e)	5.2 (13)	Complies
Frame period and jitter	15.323(e)	5.2 (13)	Complies
Monitoring threshold, Least interfered channel	15.323(c)(2)(5)(9)	5.2 (2)(5)(9)	Complies
Monitoring of intended transmit window and maximum reaction time	15.323(c)(1)	5.2 (1)	Complies

Name of test	FCC CFR 47 Paragraph #	ISED RSS-213 Paragraph #	Verdict
Threshold monitoring bandwidth	15.323(c)(7)	5.2 (7)	Complies
Reaction time and monitoring interval	15.323(c)(1)(5)(7)	5.2 (1)(5)(7)	Complies
Access criteria test interval	15.323(c)(4)(6)	5.2 (4)(6)	N/A ²
Access Criteria functional test	15.323(c)(4)(6)	5.2 (4)(6)	N/A ²
Acknowledgements	15.323(c)(4)	5.2 (4)	Complies
Transmission duration	15.323(c)(3)	5.2 (3)	Complies
Dual access criteria	15.323(c)(10)	5.2 (10)	Complies
Alternative monitoring interval	15.323(c)(11)(12)	5.2 (11)(12)	N/A ³
Spurious Emissions (Radiated)	15.319(g) 15.109(a) 15.209(a)	RSS-GEN 7.3 / 8.9	N/A ⁴

¹ USB-C connector is for service-use only and does not support charging

² Only applies for equipment that transmits unacknowledged control and signaling information

³ The client declares that the tested equipment does not implement this provision

⁴ Not required if the Conducted Out-of-Band Emissions test is Passed

3 TEST RESULTS

3.1 Automatic Discontinuation of Transmission

Does the EUT transmit Control and Signaling Information?	<input type="checkbox"/> YES	<input checked="" type="checkbox"/> NO
TYPE OF EUT :	<input checked="" type="checkbox"/> INITIATING DEVICE	<input type="checkbox"/> RESPONDING DEVICE

The following tests simulate the reaction of the EUT in case of either absence of information to transmit or operational failure after a connection with the companion device is established.

Number	Test	EUT Reaction	Verdict
1	Power removed from EUT	C	Pass
2	Switch Off EUT	C	Pass
3	Hook-On by EUT	C	Pass
4	Power Removed from Companion Device	A	Pass
5	Switch Off Companion Device	A	Pass
6	Hook-On by Companion Device	N/A	Pass

- A - Connection breakdown, Cease of all transmissions
- B - Connection breakdown, EUT transmits control and signaling information
- C - Connection breakdown, Companion Device transmits control and signaling information
- N/A - Not Applicable (Companion Device does not have On/Off switch and cannot perform Hook-On)

Requirements, FCC 15.319(f), RSS-213 Issue 3, Clause 5.2:

The device shall automatically discontinue transmission in case of either absence of information to transmit or operational failure. These provisions are not intended to preclude transmission of control and signaling information or use of repetitive codes used by certain digital technologies to complete frame or burst intervals.

3.2 Peak Power Output

Test Method:

ANSI C63.17, clause 6.1.2.

Test Results: Complies

Measurement Data:

Maximum Conducted Output Power

Channel No.	Frequency (MHz)	Maximum Conducted Output Power (dBm)
4	1921.536	19.15
2	1924.992	19.18
0	1928.448	19.20

Limit:

Conducted: $100 \mu\text{W} \times \text{SQRT}(B)$ where B is the measured Emission Bandwidth in Hz

FCC 15.319(c)(e): 20.71 dBm (118 mW)

ISED RSS-213, Issue 3: 20.49 dBm (112 mW)

Antenna gain is below 3 dBi, no reduction in transmit power limit is necessary.

Requirements,

FCC 15.319(c)(e):

Peak transmit power shall not exceed 100 microwatts multiplied by the square root of the emission bandwidth in Hertz.

RSS-213 Issue 3, clause 5.6:

Peak transmit power shall not exceed 100 microwatts multiplied by the square root of the occupied bandwidth in Hertz.

FCC 15.319(c)(e); RSS-213 Issue 3, clause 5.6:

The peak transmit power shall be reduced by the amount in decibels that the maximum directional gain of the antenna exceeds 3 dBi.

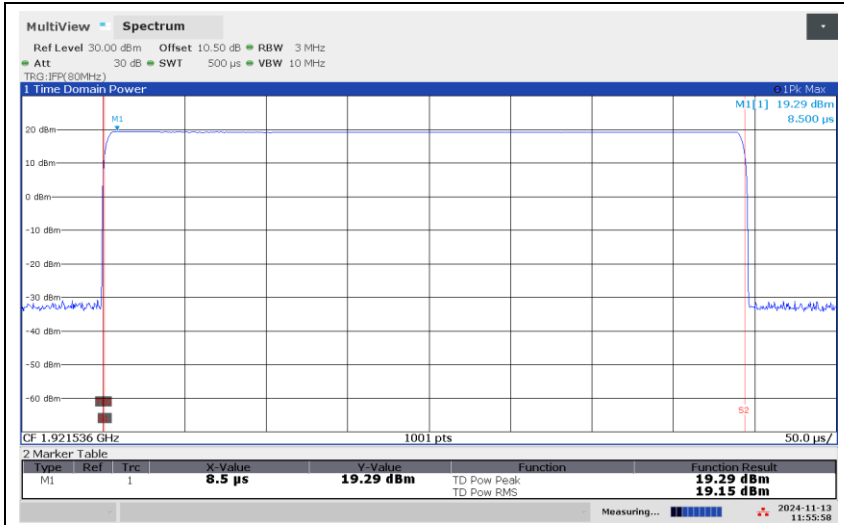

Conducted Peak Output Power, Lower Channel



Conducted Peak Output Power, Middle Channel



Conducted Peak Output Power, Upper Channel

3.3 Emission Bandwidth *B*

Test Method:

ANSI C63.17, clause 6.1.3.

Test Results: Complies

Measurement Data:

Channel No.	Frequency (MHz)	Emission Bandwidth <i>B</i> (MHz)
4	1921.536	1.39
0	1928.448	1.39

Channel No.	Frequency (MHz)	Occupied Bandwidth (kHz)
2	1924.992	1255

Requirements, FCC 15.323(a), RSS-213 Issue 3, clause 5.5:

The Emission Bandwidth *B* shall be larger than 50 kHz and less than 2.5 MHz.

No requirements for 6 and 12 dB Bandwidth, these values are only used for testing Monitoring Bandwidth if the Simple Compliance test fails (ANSI C63.17, clause 7.4).

RSS-GEN Issue 5, clause 6.7:

Occupied Bandwidth (99%) is measured according to RSS-GEN Issue 5, clause 6.7. No requirement specified.

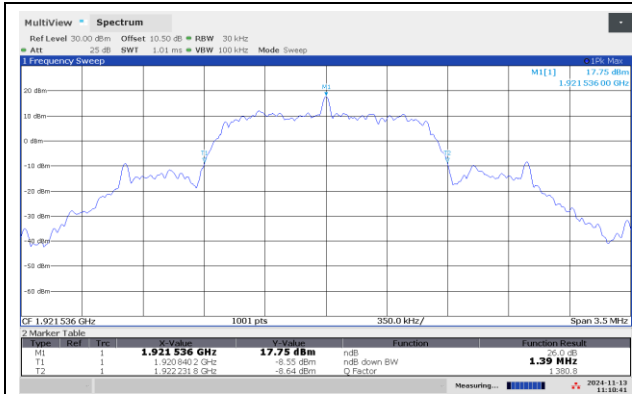

Emission Bandwidth B, Lower Channel

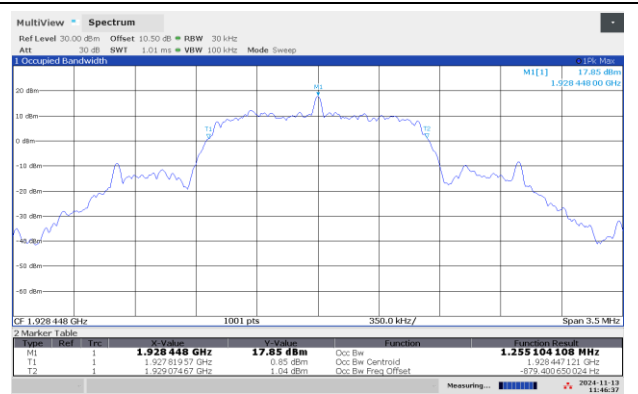

99% Bandwidth, Middle Channel

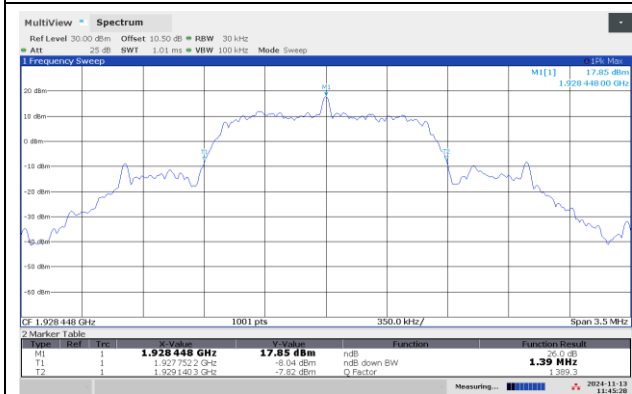

Emission Bandwidth B, Upper Channel

3.4 Power Spectral Density

Test Method:

ANSI C63.17, clause 6.1.5.

Test Results: Complies

Measurement Data:

Channel No.	Frequency (MHz)	Power Spectral Density (dBm)
4	1921.536	-2.5
0	1928.448	-2.6

Averaged over 500 sweeps.

Requirements, FCC 15.319(d), RSS-213 Issue 3, clause 5.7

The Power Spectral Density shall be less than 3 mW (4.77 dBm) when averaged over at least 100 sweeps.

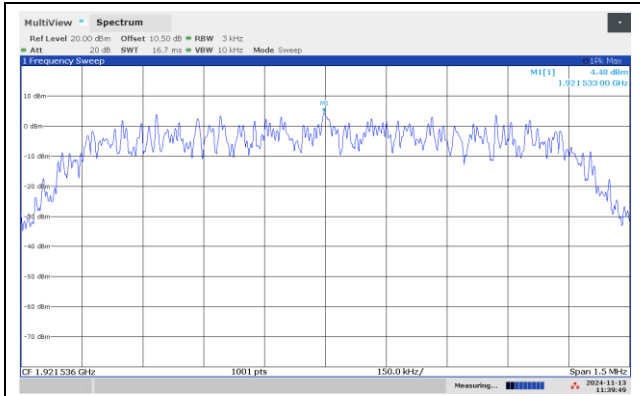

PSD Overview, Lower Channel

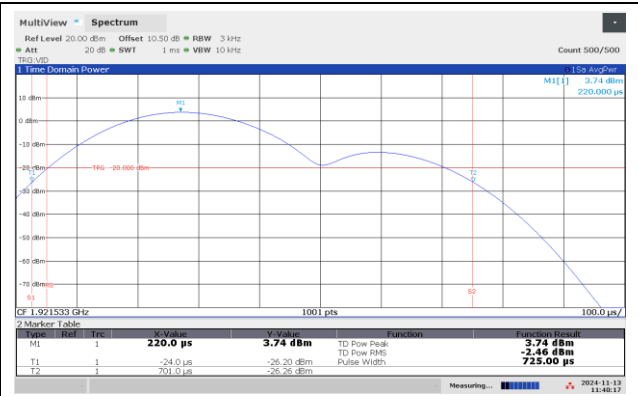

PSD Averaged, 1000 Sweeps, Lower Channel

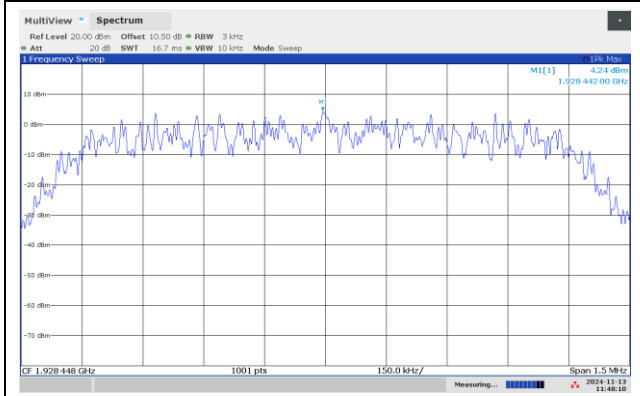

PSD Overview, Upper Channel

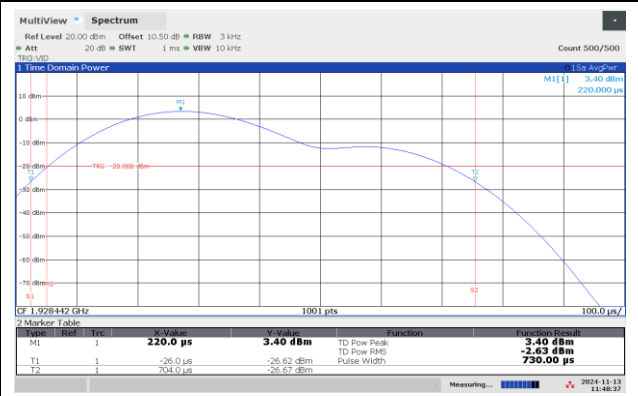

PSD Averaged, 1000 Sweeps, Upper Channel

3.5 In-Band Unwanted Emissions, Conducted

Test Method:

ANSI C63.17, clause 6.1.6.1.

Test Results: Complies

Measurement Data:

See plots.

Requirements, FCC 15.323(d), RSS-213 Issue 3, clause 5.8.2:

$B < f \leq 2B$: at least 30 dB below max. permitted peak power

$2B < f \leq 3B$: at least 50 dB below max. permitted peak power

$3B < f \leq$ UPCS Band Edge : at least 60 dB below max. permitted peak power

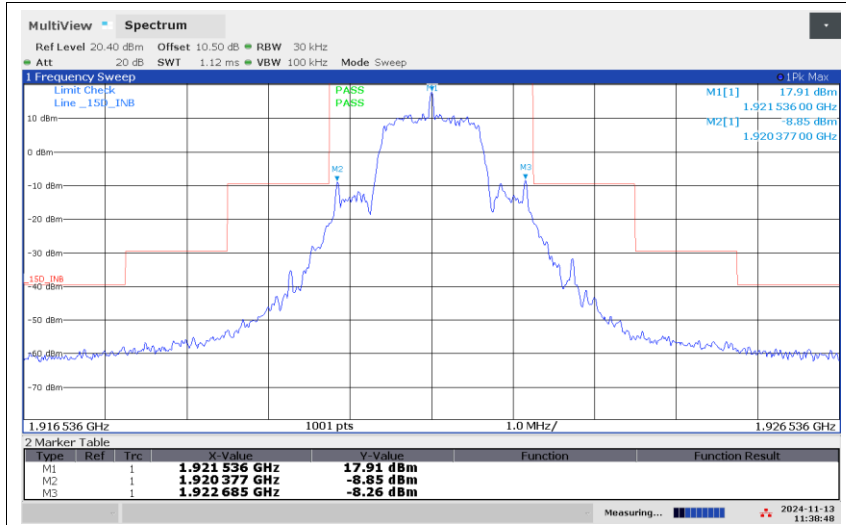

In-Band Unwanted Emissions, Lower Channel

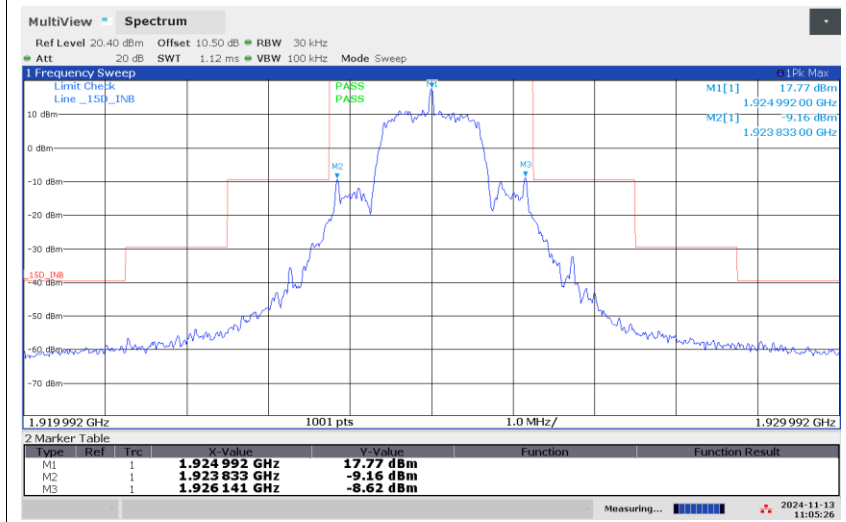

In-Band Unwanted Emissions, Middle Channel

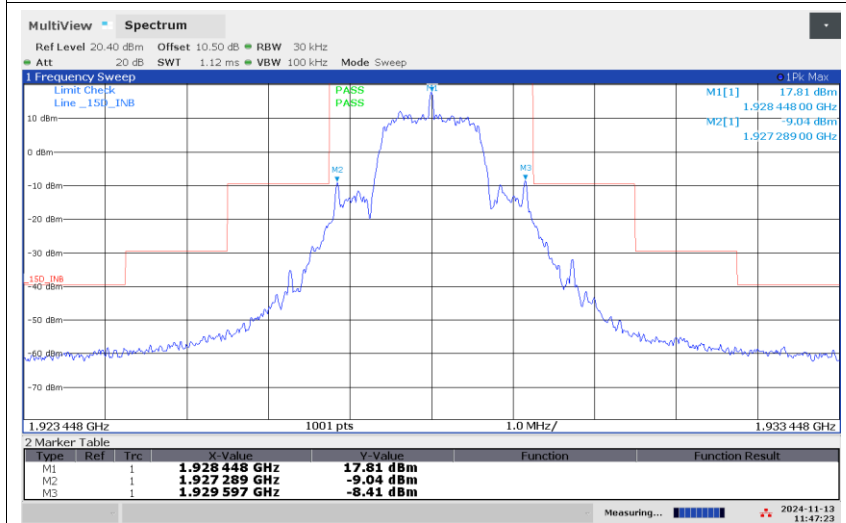

In-Band Unwanted Emissions, Upper Channel

3.6 Out-of-band Emissions, Conducted

Test Method:

ANSI C63.17, clause 6.1.6.2.

Test Results: Complies

Measurement Data:

Carrier #	Frequency (MHz)	Emission Level (dBm)	Limit (dBm)	Margin (dB)
04	1838.46	-58.1	-39.5	18.6
	3843.07	-52.4	-39.5	12.9
02	1842.05	-57.1	-39.5	17.6
	3849.98	-51.5	-39.5	12.0
00	1845.54	-55.8	-39.5	16.3
	3856.87	-52.2	-39.5	12.7

Total Emission Level is calculated using the method described in KDB 662911 D01 clause E) 3) a) (iii)

Requirements, FCC 15.323(d), RSS-213 Issue 3, clause 5.8.1:

- $f \leq 1.25\text{MHz}$ outside UPCS band : $\leq -9.5\text{dBm}$
- $1.25\text{MHz} \leq f \leq 2.5\text{MHz}$ outside UPCS band : $\leq -29.5\text{ dBm}$
- $f \geq 2.5\text{MHz}$ outside UPCS band : $\leq -39.5\text{ dBm}$

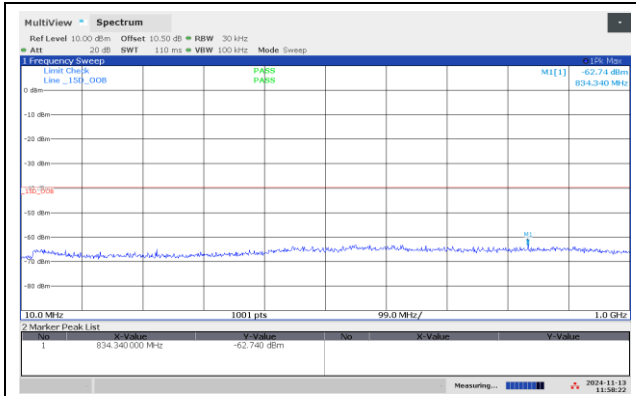

Out-of-Band Emissions, Lower Channel

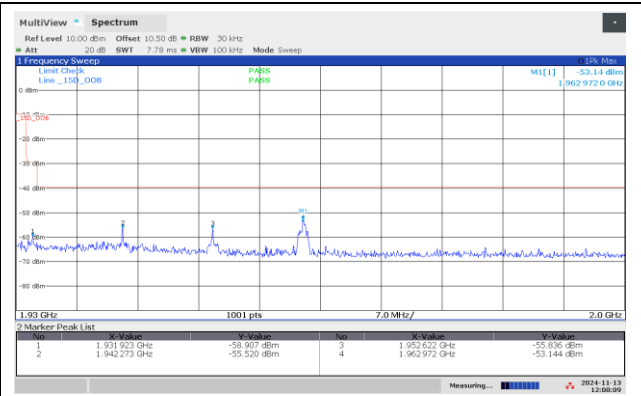

Out-of-Band Emissions, Lower Channel

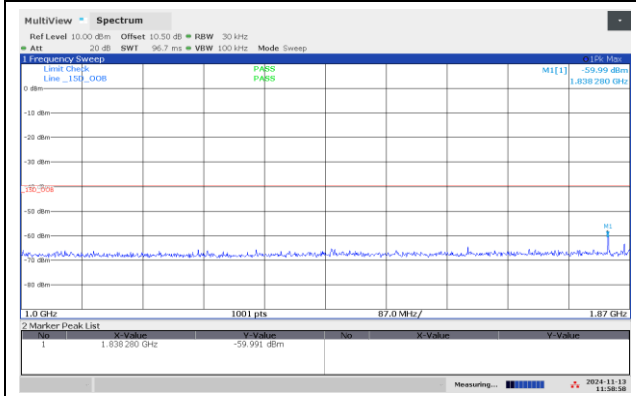

Out-of-Band Emissions, Lower Channel

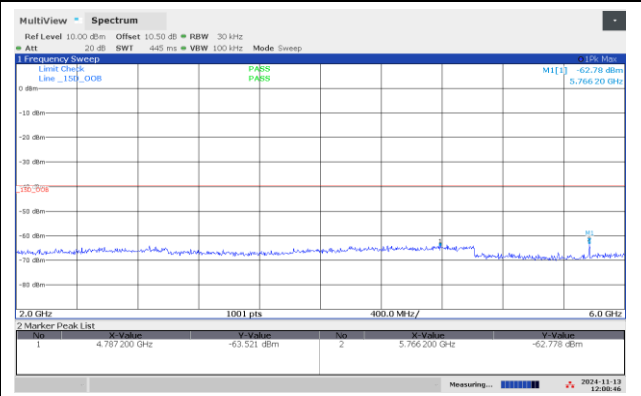

Out-of-Band Emissions, Lower Channel

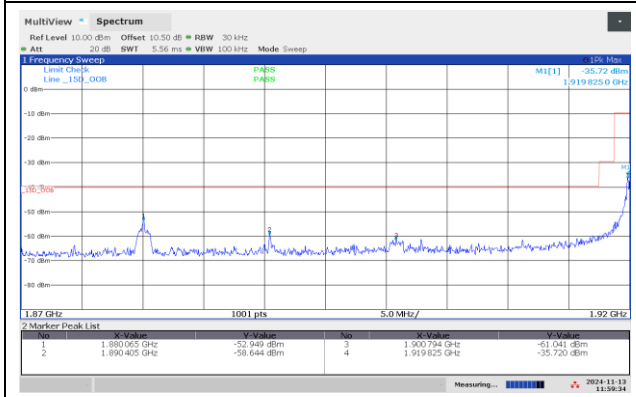

Out-of-Band Emissions, Lower Channel

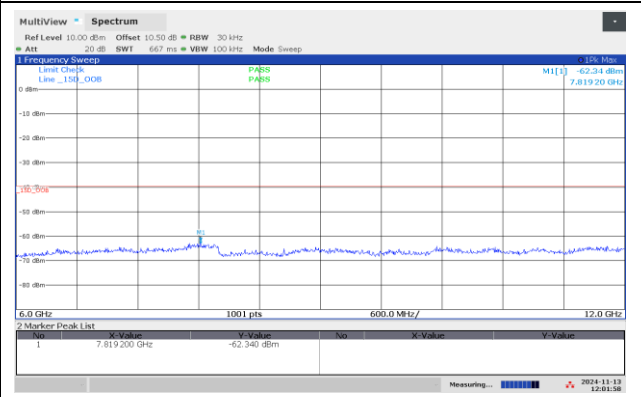

Out-of-Band Emissions, Lower Channel

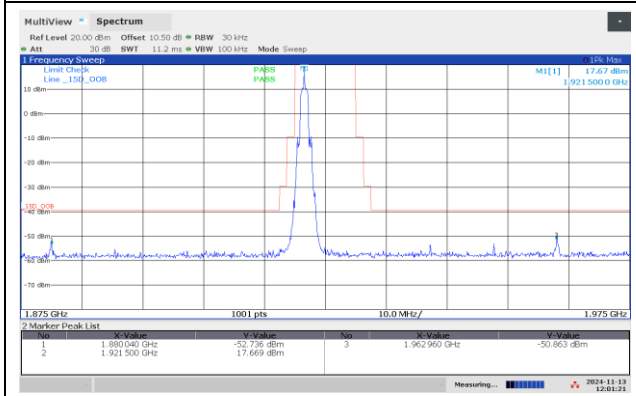

Out-of-Band Emissions, Lower Channel

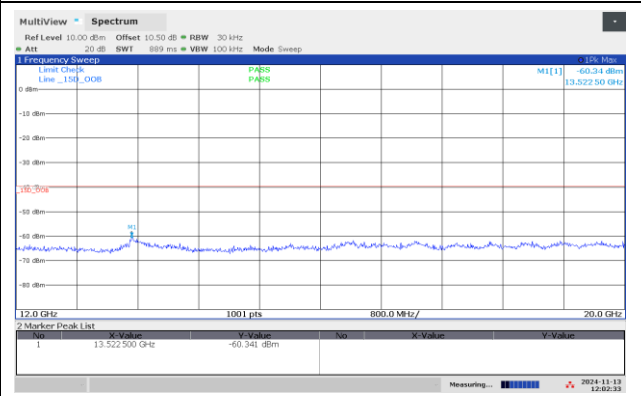

Out-of-Band Emissions, Lower Channel

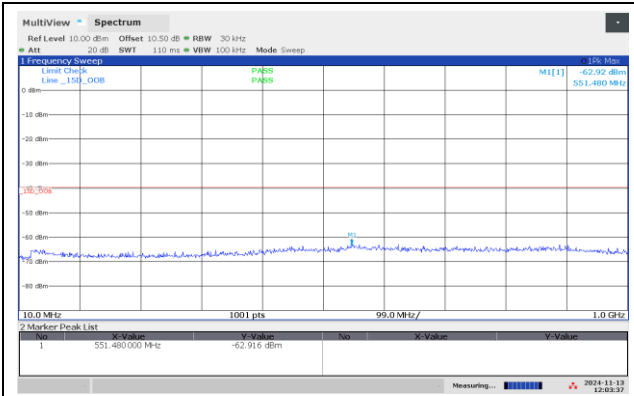

Out-of-Band Emissions, Middle Channel

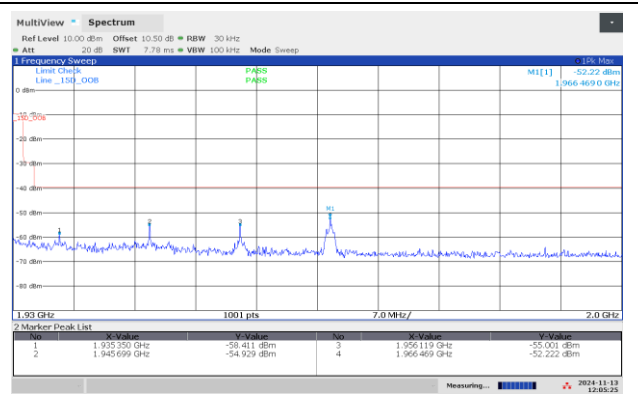

Out-of-Band Emissions, Middle Channel

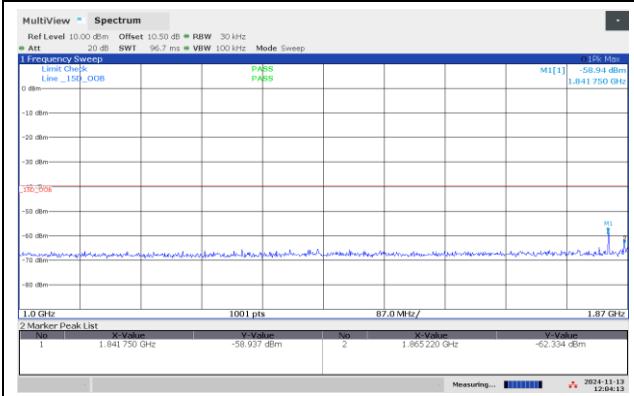

Out-of-Band Emissions, Middle Channel

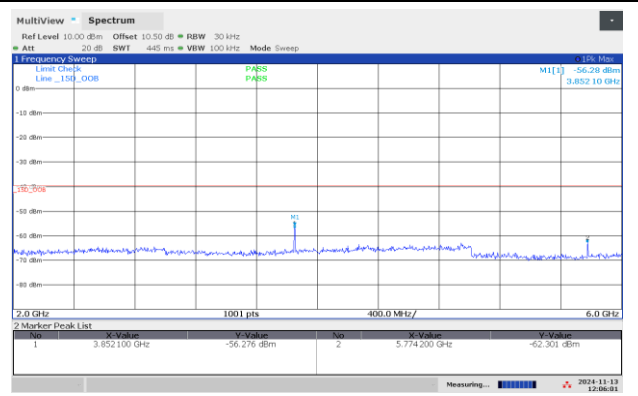

Out-of-Band Emissions, Middle Channel

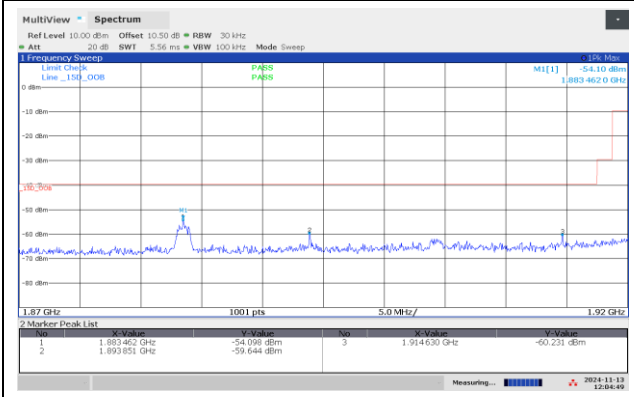

Out-of-Band Emissions, Middle Channel

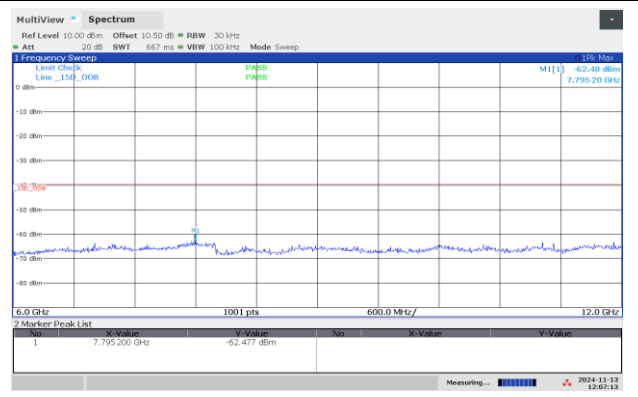

Out-of-Band Emissions, Middle Channel

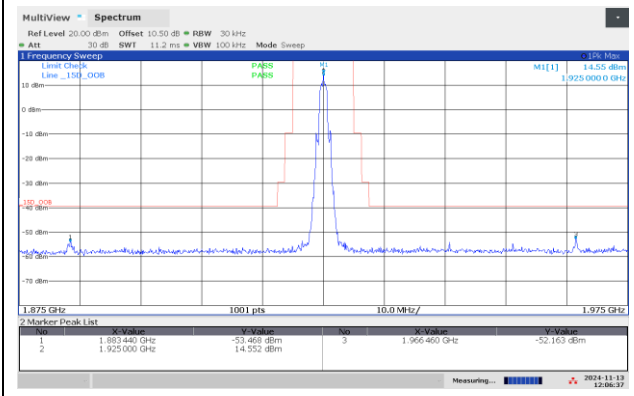

Out-of-Band Emissions, Middle Channel

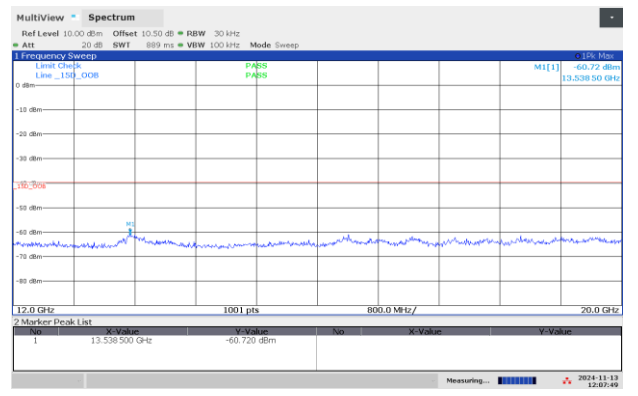

Out-of-Band Emissions, Middle Channel

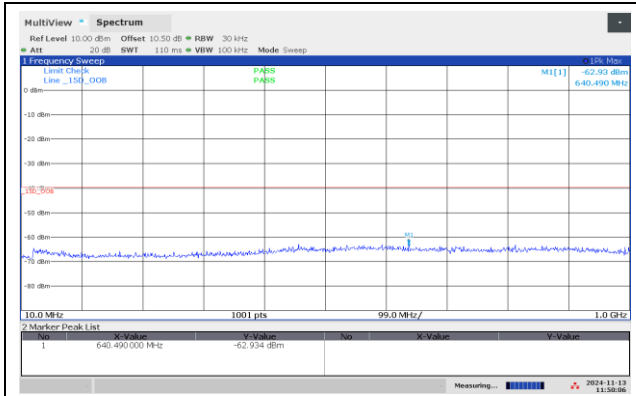

Out-of-Band Emissions, Upper Channel

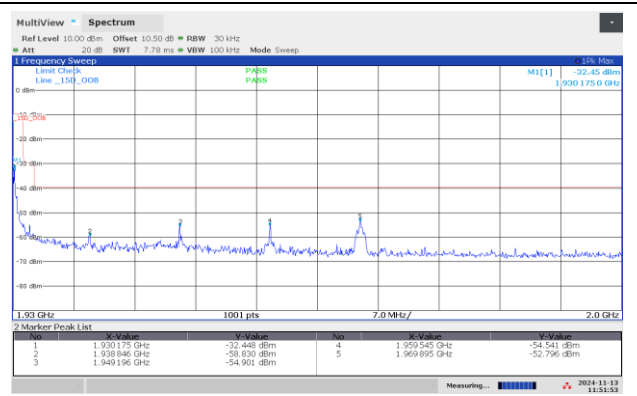

Out-of-Band Emissions, Upper Channel

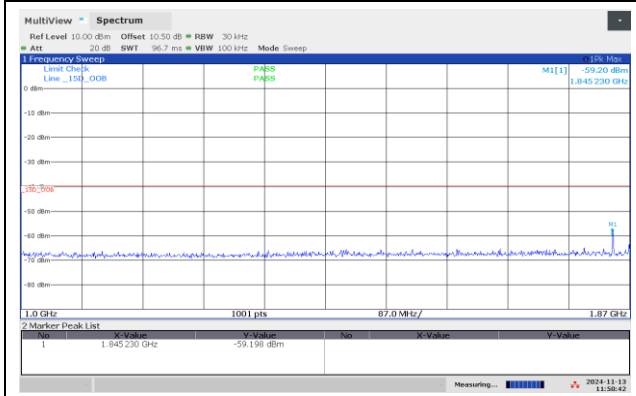

Out-of-Band Emissions, Upper Channel

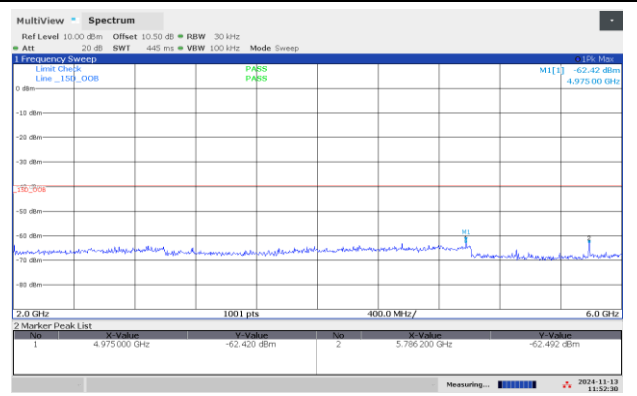

Out-of-Band Emissions, Upper Channel

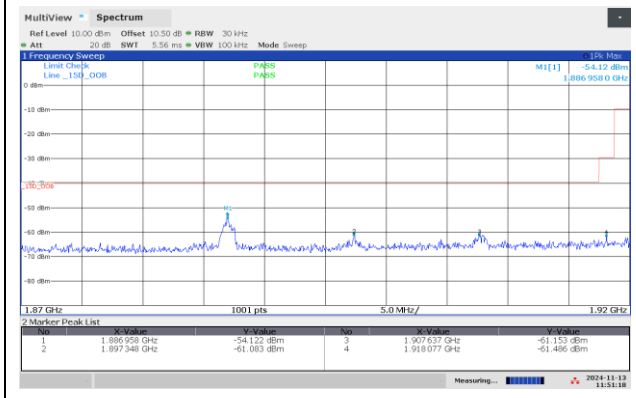

Out-of-Band Emissions, Upper Channel

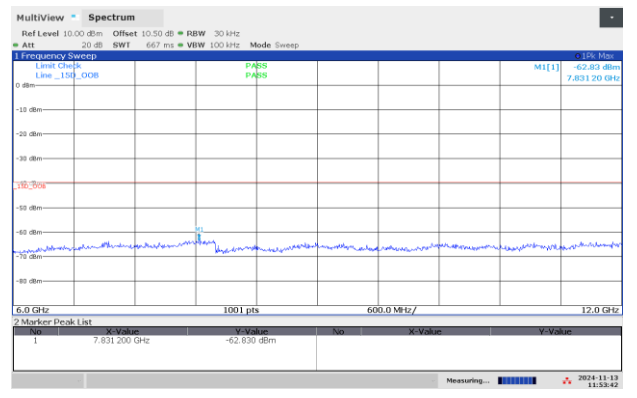

Out-of-Band Emissions, Upper Channel

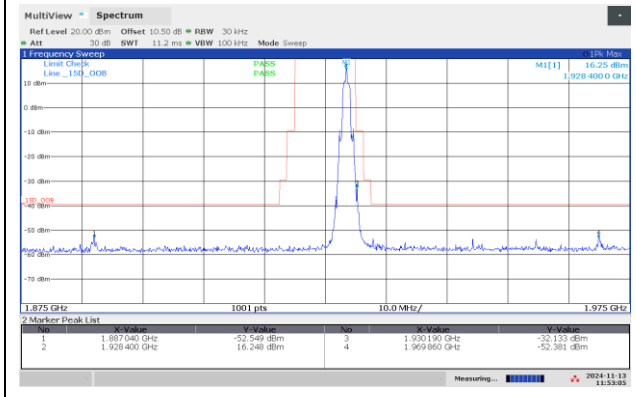

Out-of-Band Emissions, Upper Channel

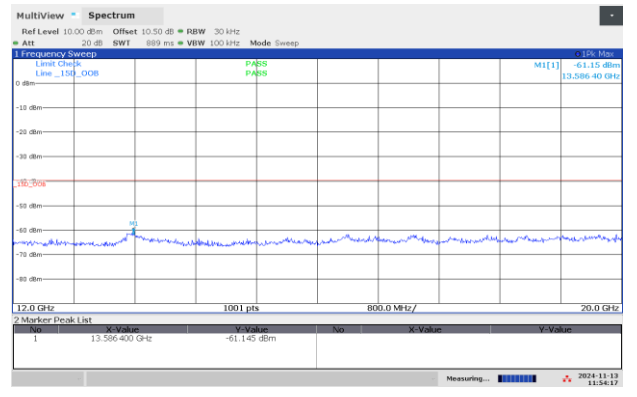

Out-of-Band Emissions, Upper Channel

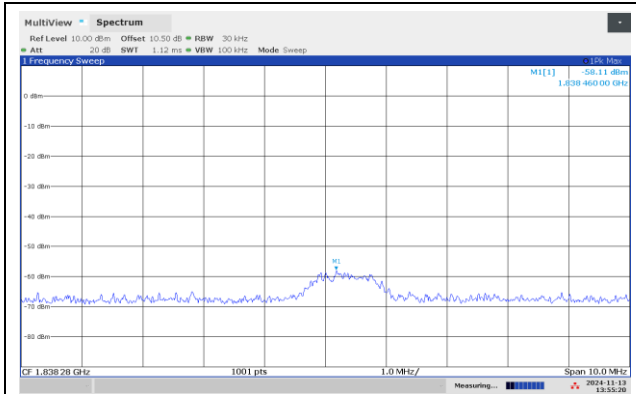

Out-of-Band Emissions, Lower Channel

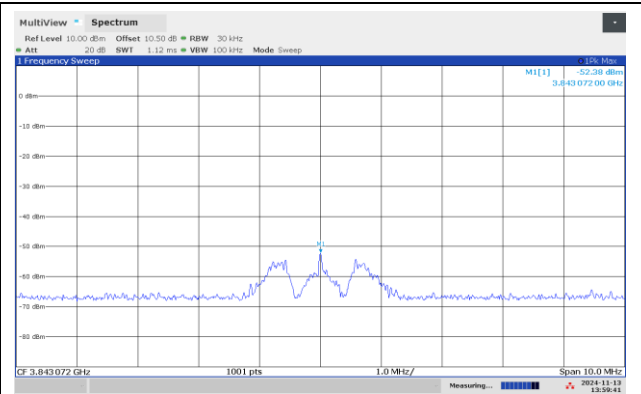

Out-of-Band Emissions, Middle Channel

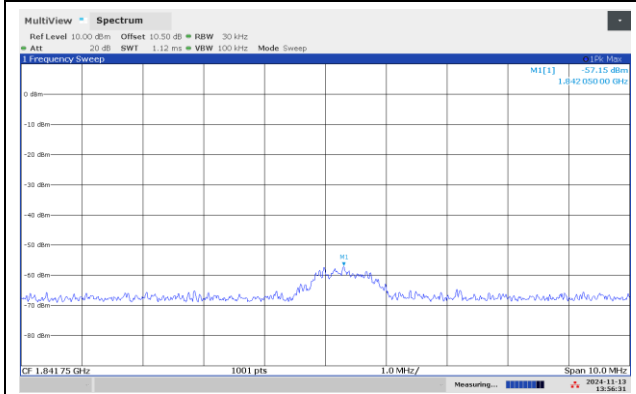

Out-of-Band Emissions, Middle Channel

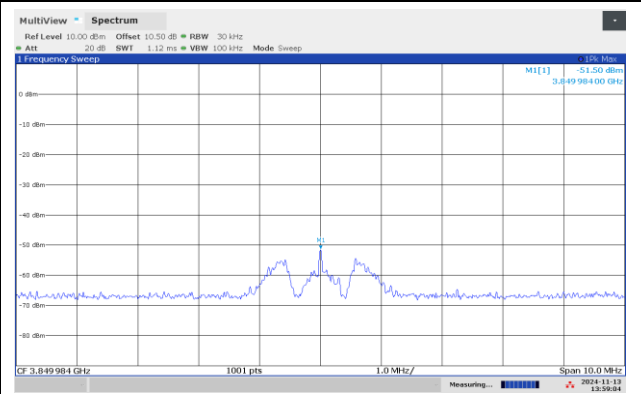

Out-of-Band Emissions, Upper Channel

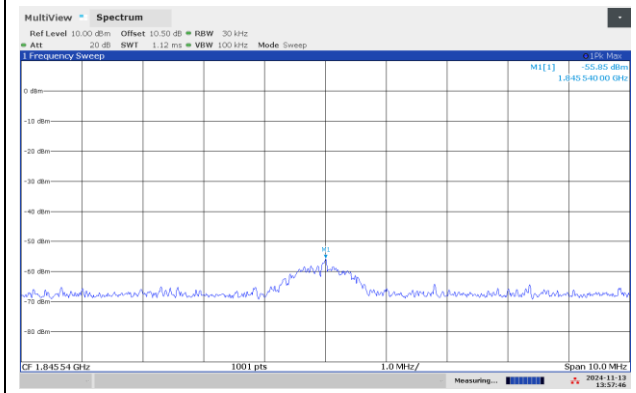

Out-of-Band Emissions, Upper Channel

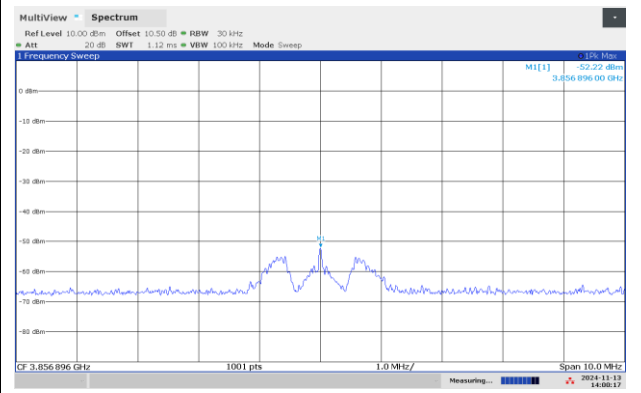

Out-of-Band Emissions, Upper Channel

3.7 Carrier Frequency Stability

Test Method:

ANSI C63.17, clause 6.2.1.

Test Results: Complies

Measurement Data:

Long Term Frequency Stability is measured with the HP53310A Modulation Domain analyzer. The HP53310A is logged by a computer programmed to get new readings as fast as possible over the noted time period or number of readings. The peak-to-peak difference was recorded and the mean value and deviation in ppm was calculated.

The Carrier Frequency Stability over Power Supply Voltage and over Temperature is measured with a Frequency Domain Analyzer in histogram mode.

Carrier Frequency Stability over Time at Nominal Temperature

Average Mean Carrier Frequency (MHz)	Max. Diff. (kHz)	Min. Diff. (kHz)	Max. Dev. (ppm)	Limit
1924.996623	6.412	2.662	-1.0	±10 ppm

Deviation ppm = ((Diff. - Mean Diff) / Mean Carrier Freq.) x 10⁶

Deviation (ppm) is calculated from 3000 readings.

Frequency Stability over Power Supply Voltage at Nominal Temperature

Voltage	Measured Carrier Frequency (MHz)	Difference (kHz)	Deviation (ppm)	Limit
V _{nom}	/	0	0	±10 ppm
85% of V _{nom}	/	/	/	
115% of V _{nom}	/	/	/	

Deviation ppm = ((Mean – Measured Frequency) / Mean) x 10⁶

This test does not apply for EUT that is powered from batteries.

Frequency Stability over Temperature

Temperature	Measured Carrier Frequency (MHz)	Difference (kHz)	Deviation (ppm)	Limit
T = +20 °C	1924.9908	0	0	±10 ppm
T = -20 °C	1924.9942	3.4	1.8	
T = +50 °C	1924.9877	-3.1	-1.6	

Deviation ppm = ((Mean – Measured Frequency) / Mean) x 10⁶

Ref. FCC 15.323(e), RSS-213 Issue 3, clause 5.3

3.8 Frame Repetition Stability

Test Method:

ANSI C63.17, clause 6.2.2.

Test Results: Complies

Measurement Data:

The envelope of the RF signal from the EUT is detected with a Crystal Detector and the mean and standard deviation of the frame repetition frequency is then gated over 100 frames and measured with a Frequency Domain Analyzer. The frame repetition stability is 3 times the standard deviation.

Carrier Frequency (MHz)	Mean (Hz)	Standard Deviation (µHz)	Frame Repetition Stability (ppm)
1924.992	100.000	0.007	0.020

Limit:

Frame Repetition Stability	±10 ppm (TDMA)
----------------------------	----------------

Ref. FCC 15.323(e), RSS-213 Issue 3, clause 5.2

3.9 Frame Period and Jitter

Test Method:

ANSI C63.17, clause 6.2.3.

Test Results: Complies

Measurement Data:

The envelope of the RF signal from the EUT is detected with a Crystal Detector and the frame period and jitter is measured with a Frequency Domain Analyzer over at least 100.000 frames.

Carrier Frequency (MHz)	Frame Period (ms)	Max Jitter (µs)	3xStandard Deviation of Jitter (µs)
1924.992	10.000	-0.044	-0.019

Max Jitter = (1/ (Frame period + Pk-Pk/2)) - (1/Frame Period), when Pk-Pk and Frame Period are in Hz

3xSt.Dev.Jitter = 3x (1/(Frame Period + St.Dev) – 1/St.Dev) x 10⁶

Limit:

Frame Period	20 or 10 ms
Max Jitter	25 µs
3 times St.Dev of Jitter	12.5 µs

Ref. FCC 15.323(e), RSS-213 Issue 3, clause 5.2

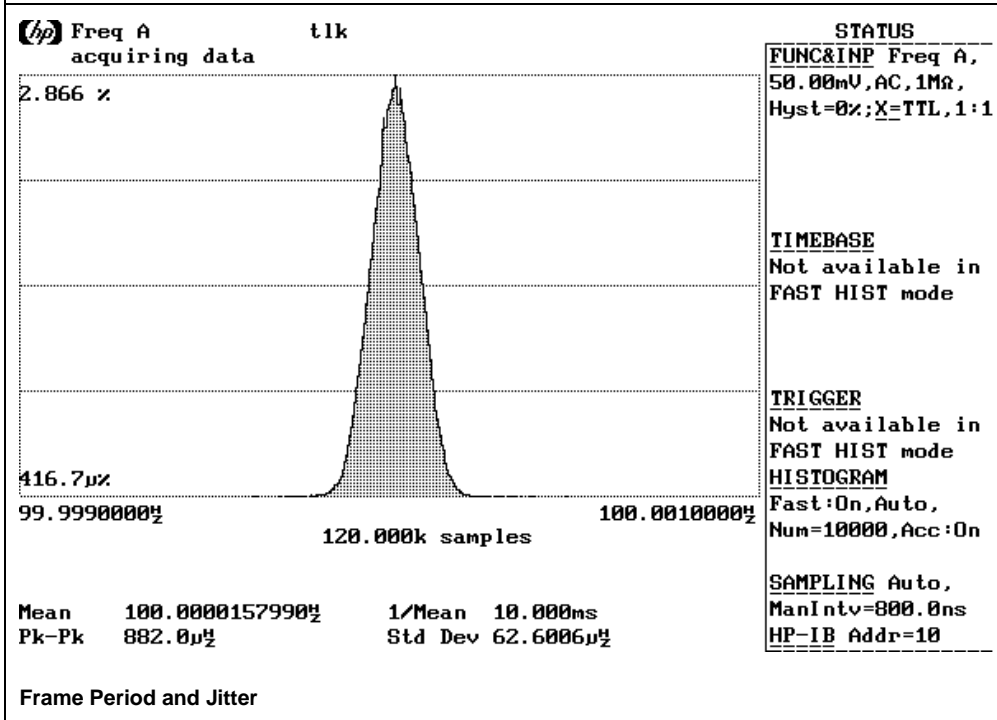
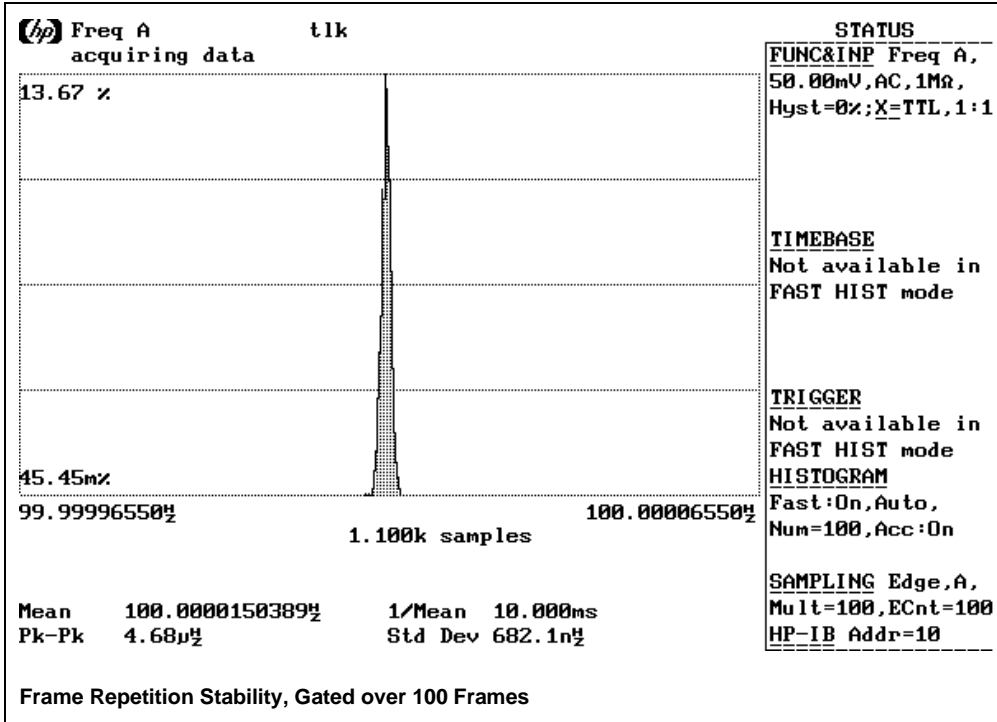

3.10 Monitoring Threshold, Least Interfered Channel

Monitoring Threshold Limits:

Threshold Level:

$$T_L = -174 + 10 \log B + 30 + P_{MAX} - P_{EUT} \text{ (dBm)}$$

B is measured Emission Bandwidth (FCC 15.323) or Occupied Bandwidth (RSS-213 Issue 3) in Hz

P_{MAX} is the power limit in dBm

P_{EUT} is measured Transmitter Power in dBm

Calculated values:

	FCC 15.323, RSS-213 Issue 3, clause 5.2
Threshold Level (FCC 15.323)	-81.1 dBm
Threshold Level (RSS-213 Issue 3)	-81.8 dBm

Least Interfered Channel Procedure (LIC) may only be used by systems with more than 20 duplex system access channels. Systems with less than 20 duplex system access channels are not allowed to transmit when interferer level is above Threshold Level.

Measurement Procedure:

Test only when Least Interfered Channel Procedure is NOT used:	
Lower Threshold	N/A The EUT uses LIC procedure

Least Interfered Channel (LIC) Procedure Test, FCC 15.323(b), (c)(2) and (c)(5)

ANSI C63.17 clause 7.3.2 ref.	Observation	Verdict
b) f_1 at $T_L + U_M + 7$ dB, f_2 at $T_L + U_M$	Transmission always on f_2	Pass
c) f_1 at $T_L + U_M$, f_2 at $T_L + U_M + 7$ dB	Transmission always on f_1	Pass
d) f_1 at $T_L + U_M + 1$ dB, f_2 at $T_L + U_M - 6$ dB	Transmission always on f_2	Pass
e) f_1 at $T_L + U_M - 6$ dB, f_2 at $T_L + U_M + 1$ dB	Transmission always on f_1	Pass

Selected Channel Confirmation, FCC 15.323(c)(1) and (5)

ANSI C63.17 clause 7.3.3	Observation	Verdict
b) Shall not transmit on f_1	EUT transmits on f_2	Pass
d) Shall not transmit on f_2	EUT transmits on f_1	Pass

Limits:

	FCC 15.323, RSS-213 Issue 3, clause 5.2
Threshold Level + 6 dB margin (FCC 15.323)	-75.1 dBm
Threshold Level + 6 dB margin (RSS-213 Issue 3)	-75.8 dBm

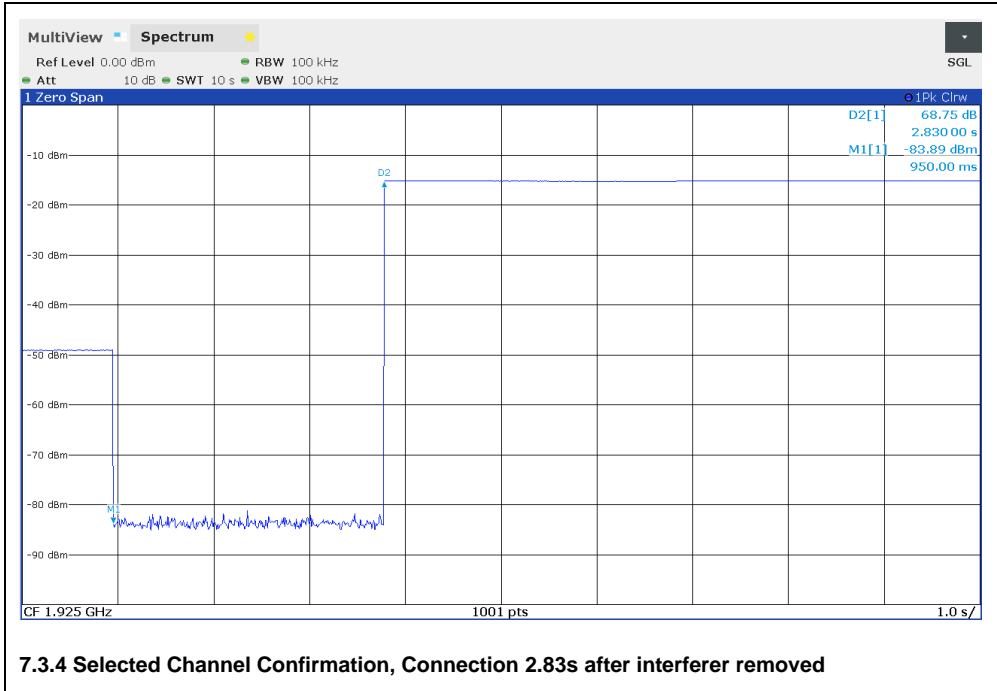

3.11 Threshold Monitoring Bandwidth

This test is only required if a dedicated monitoring receiver is used. However, if the test is not carried out the manufacturer shall declare and provide proper evidence that the monitoring is made through the radio receiver used for communication.

Measurement Procedure:

Simple Compliance Test, ANSI C63.17, clause 7.4.1

More Detailed Test, ANSI C63.17, clause 7.4.2

The test is passed if **either** the Simple Compliance Test or the More Detailed test is passed.

During this test the spectrum analyzer is observed visually to see if the EUT transmits or not.

Test Results:

Test performed	Observation	Verdict
Simple Compliance test, at $\pm 30\%$ of <i>B</i>	N/A	N/A
More Detailed Test, at -6 dB points	N/A	N/A
More Detailed Test, at -12 dB points	N/A	N/A

The more detailed test must be pass at both the -6 and -12 dB points if the Simple Compliance test fails.

Comment: The manufacturer declares that the tested EUT uses the same receiver for monitoring and communication, this test is therefore not required.

Limits, FCC 15.323(c)(7), RSS-213 Issue 3, clause 5.2:

The monitoring system bandwidth must be equal to or greater than the emission bandwidth of the intended transmission.

3.12 Reaction Time and Monitoring Interval

Measurement Procedure

ANSI C63.17, clause 7.5

Test results:

By administrative commands and out-of-operating region interference, the EUT is restricted to operate on two RF carrier frequencies.

A CW interferer signal at a level T_L is applied on f_1 and time-synchronized pulsed interference at a level $T_L + U_M$ dB is applied on f_2 . The level on f_2 was raised 6 dB for part d) with 35 μ s pulses.

The pulses are synchronized with the EUT timeslots and applied centered within all timeslots.

For both tests the test is passed if the EUT transmits on f_1 .

Pulse Width, ref. to ANSI C63.17 clause 7.5	Observation	Verdict
c) > largest of 50 μ s and $50 \cdot \text{SQRT}(1.25/B)$	EUT transmits on f_1	Pass
d) > largest of 35 μ s and $35 \cdot \text{SQRT}(1.25/B)$, and with interference level raised 6 dB	EUT transmits on f_1	Pass

Comment: The test was performed with pulse lengths of 50 μ s and 35 μ s.

Limits, FCC 15.323(c)(1), (5) and (7), RSS-213 Issue 3, clause 5.2:

The maximum reaction time must be less than $50 \cdot \text{SQRT}(1.25/\text{emission bandwidth in MHz})$ microseconds for signals at the applicable threshold level but shall not be required to be less than 50 μ s.

If a signal is detected that is 6 dB or more above the applicable threshold level, the maximum reaction time shall be $35 \cdot \text{SQRT}(1.25/\text{emission bandwidth in MHz})$ microseconds but shall not be required to be less than 35 μ s.

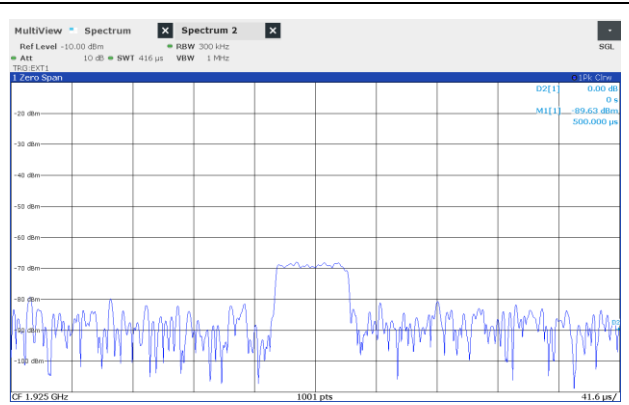
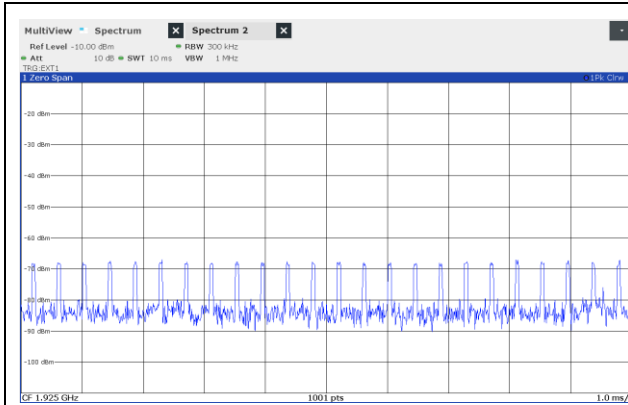

50 µs Pulses

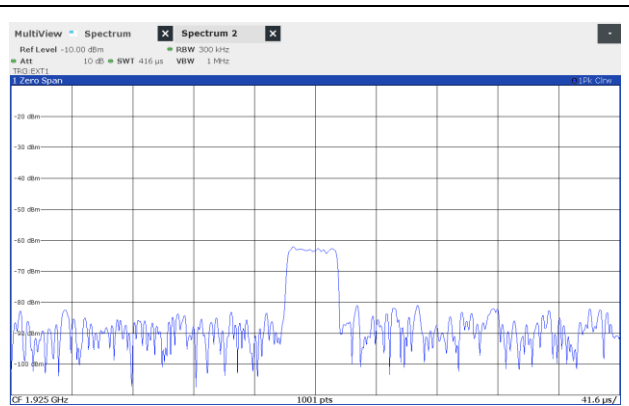
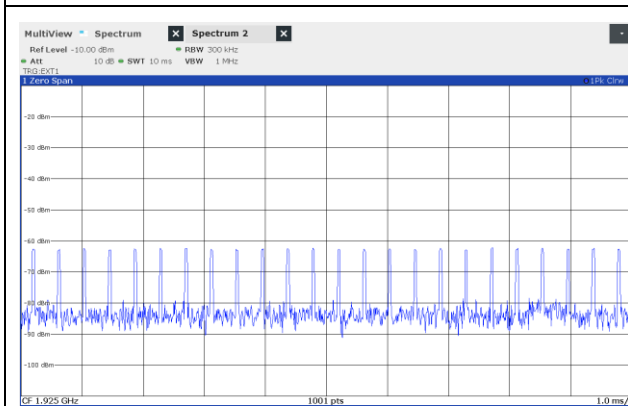

35 µs Pulses

3.13 Time and Spectrum Window Access Procedure

This requirement is only for EUTs which transmit unacknowledged control and signaling information.

Measurement Procedure:

Timing for EUTs using control and signaling channel type transmissions: ANSI C63.17, clause 8.1

Test results:

Access Criteria, ref. to ANSI C63.17 clause 8.1.1	Observation	Verdict
b) Check that the EUT transmits on the interference free time-slot	N/A	N/A
b) The EUT must terminate or pause in its repetitive transmission of the control and signalling channel on the open channel to repeat the access criteria not less frequently than every 30 s	N/A	N/A

If FCC 15.323(c)(6) option, **If Random Waiting Interval is NOT implemented**

Access Criteria, ref. to ANSI C63.17 clause 8.1.2	Observation	Verdict
b) Check that the EUT changes to an interference-free slot when interference is introduced on the time slot in use	N/A	N/A

If FCC 15.323(c)(6) option, **Only if Random Waiting Interval is implemented**

Access Criteria, ref. to ANSI C63.17 clause 8.1.3	Observation	Verdict
b-d) Check that the EUT uses random waiting interval before continuing transmission on an interfered time slot	N/A	N/A

Comment: The tested EUT does not transmit unacknowledged control and signaling information.

Limits:

FCC 15.323(c)(4), RSS-213 Issue 3, clause 5.2, RSS-213 Issue 3, clause 5.2:

Once access to specific combined time and spectrum windows is obtained an acknowledgement from a system participant must be received by the initiating transmitter within one second or transmission must cease. Periodic acknowledgements must be received at least every 30 seconds or transmission must cease. Channels used exclusively for control and signaling information may transmit continuously for 30 seconds without receiving an acknowledgement, at which time the access criteria must be repeated.

FCC 15.323(c)(6), RSS-213 Issue 3, clause 5.2, RSS-213 Issue 3, clause 5.2:

If the selected combined time and spectrum windows are unavailable, the device may either monitor and select different windows or seek to use the same windows after waiting an amount of time, randomly chosen from a uniform random distribution between 10 and 150 milliseconds, commencing when the channel becomes available

3.14 Acknowledgements and Transmission Duration

Measurement Procedure:

Acknowledgements: ANSI C63.17, clause 8.2.1

Transmission Duration: ANSI C63.17, clause 8.2.2

During the test **Initial transmission without acknowledgements** the signal from the EUT to the companion device is blocked by circulators in addition to the tunable attenuator.

The test **Transmission time after loss of acknowledgements** is performed by cutting-off the signal from the companion device by a RF switch and measuring the time until the EUT stops transmitting.

The **Transmission Duration** test is performed by monitoring the slot in use and measuring the time until the EUT changes to a different slot.

Test Results:

Acknowledgements		
Test ref. to ANSI C63.17 clause 8.2.1	Observation	Verdict
a) Initial transmission without acknowledgements	< 0.001 sec	Pass
c) Transmission time after loss of acknowledgements	10 sec	Pass

Transmission Duration		
Test ref. to ANSI C63.17 clause 8.2.2	Observation	Verdict
b) Transmission duration on same time and frequency window	1.0 hour	Pass

Comment: /

Limits, FCC 15.323(c)(3) and (4), RSS-213 Issue 3, clause 5.2:

Occupation of the same combined time and spectrum windows by a device or group of cooperating devices continuously over a period of time longer than 8 hours is not permitted without repeating the access criteria.

Once access to specific combined time and spectrum windows is obtained an acknowledgement from a system participant must be received by the initiating transmitter within one second or transmission must cease.

Periodic acknowledgements must be received at least every 30 seconds or transmission must cease. Channels used exclusively for control and signaling information may transmit continuously for 30 seconds without receiving an acknowledgement, at which time the access criteria must be repeated.

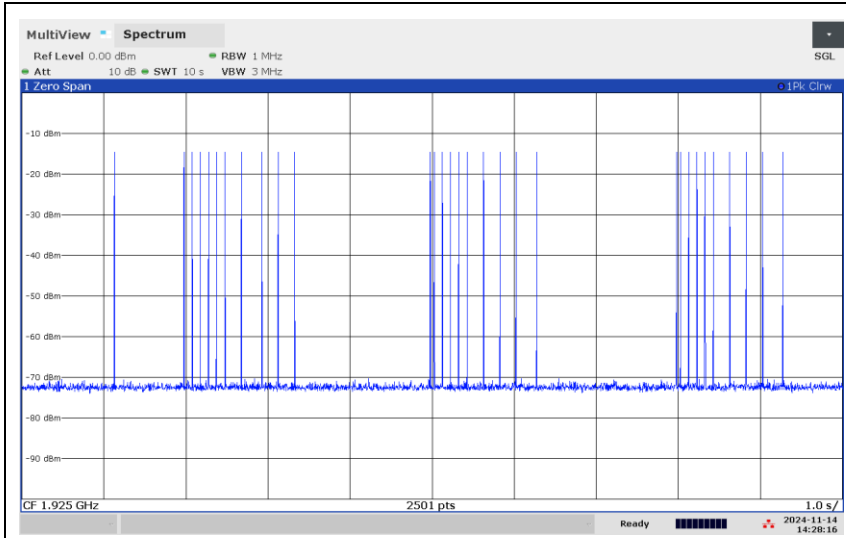

Initial Transmission without Acknowledgements

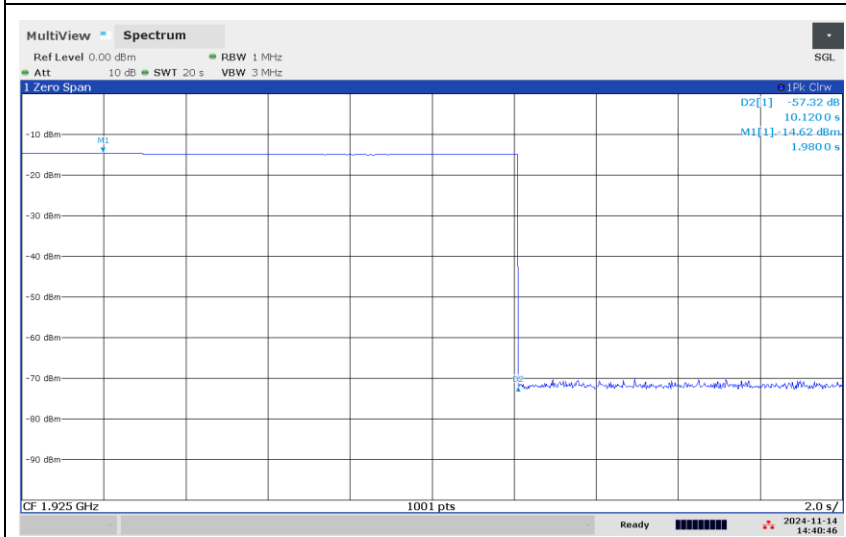

Transmission time after loss of Acknowledgements

3.15 Dual Access Criteria Check

Measurement Procedure:

EUTs that does not implement the LIC procedure: ANSI C63.17, clause 8.3.1

EUTs that implement the LIC procedure: ANSI C63.17, clause 8.3.2

This test is required for equipment that uses the access criteria in FCC 15.323(c)(10).

Test Results:

EUTs that do NOT implements the LIC procedure:

Test ref. to ANSI C63.17 clause 8.3.1	Observation	Verdict
b) EUT is restricted to a single carrier f_i for TDMA systems. The Test is Pass if EUT can transmit	N/A	N/A
c) d) Interference at level $T_L + U_M$ on all timeslots except one receive slot where interference is at least 10 dB below T_L	N/A	N/A
e) f) Interference at level $T_L + U_M$ on all timeslots except one transmit slot where interference is at least 10 dB below T_L	N/A	N/A

EUTs that implements the LIC procedure:

Test ref. to ANSI C63.17 clause 8.3.2	Observation	Verdict
b) EUT is restricted to a single carrier f_i for TDMA systems. The Test is Pass if EUT can transmit	EUT can transmit	Pass
c) d) Transmission on interference-free receive time/spectrum window	EUT transmits on interference free receive slot	Pass
e) f) Transmission on interference-free transmit time/spectrum window	EUT transmits on interference free transmit slot	Pass

Comment: See plots.

Limits, FCC 15.323(c)(10), RSS-213 Issue 3, clause 5.2:

An initiating device may attempt to establish a duplex connection by monitoring both its intended transmit and receive time and spectrum windows. If both the intended transmit and receive time and spectrum windows meet the access criteria, then the initiating device can initiate a transmission in the intended transmit time and spectrum window. If the power detected by the responding device can be decoded as a duplex connection signal from the initiating device, then the responding device may immediately begin transmitting on the receive time and spectrum window monitored by the initiating device.

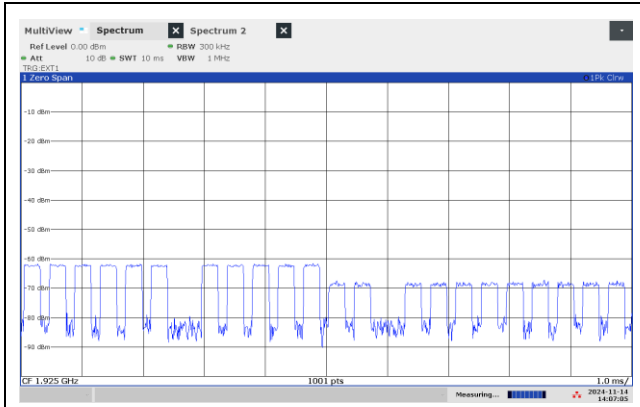

EUT Transmits on Free RECEIVE Slot, BEFORE

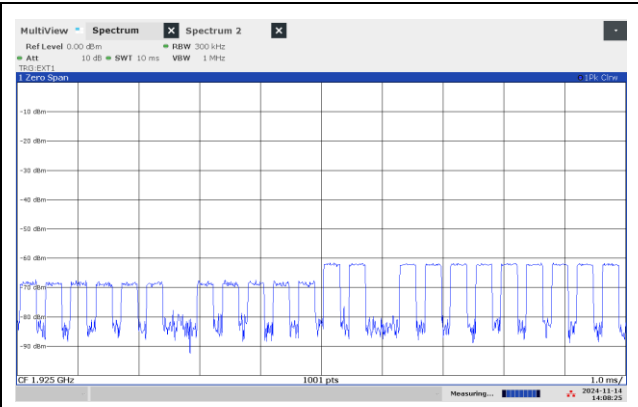

EUT Transmits on Free TRANSMIT Slot, BEFORE

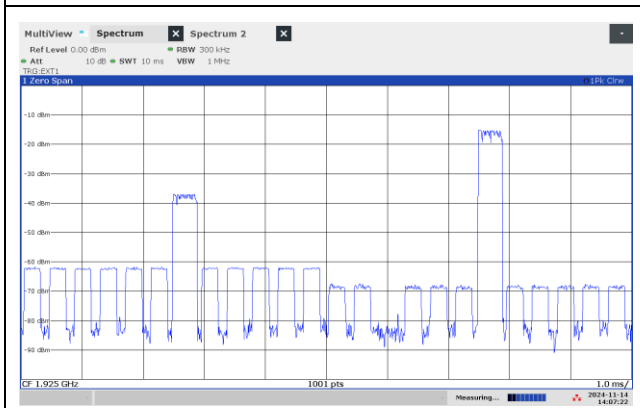

EUT Transmits on Free RECEIVE Slot, AFTER

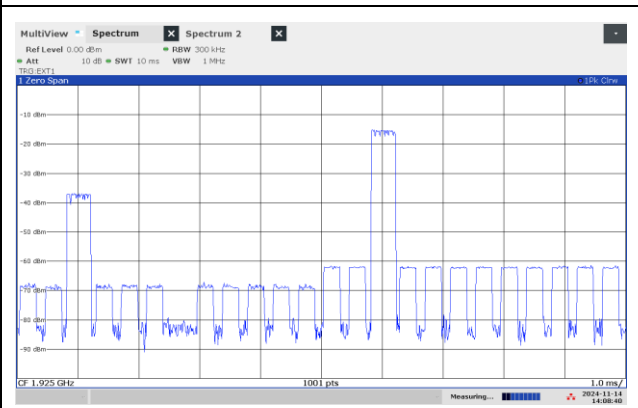

EUT Transmits on Free TRANSMIT Slot, AFTER

3.16 Alternative Monitoring Interval

Test procedure described in ANSI C63.17 clause 8.4.

This test is required if the EUT implements the provisions of FCC 15.323(c)(11).

Test result:

Not Tested. The tested EUT does not implement this provision. See manufacturers' declaration.

4 Measurement Uncertainty

Measurement Uncertainty Values		
Test Item		Uncertainty
Output Power		±0.5 dB
Power Spectral Density		±0.5 dB
Out of Band Emissions, Conducted (RBW < 100 kHz)	< 3.6 GHz	±0.6 dB
	> 3.6 GHz	±0.9 dB
Spurious Emissions, Radiated	< 1 GHz	±2.5 dB
	> 1 GHz	±2.2 dB
Emission Bandwidth		±4 %
Power Line Conducted Emissions		+2.9 / -4.1 dB
Spectrum Mask Measurements	Frequency	±5 %
	Amplitude	±1.0 dB
Frequency Error		±0.6 ppm
Timing and Jitter Measurements		±2.0 ns
Frame Timing Measurements		±1.4 ppm
Receiver Blocking Levels		±1.0 dB
Temperature Uncertainty		±1 °C

All uncertainty values are expanded standard uncertainty to give a confidence level of 95%, based on coverage factor k=2

5 Test Setups

5.1 Frequency Measurements



Test Set-up 1

This setup is used for measuring Carrier frequency stability at normal and extreme temperatures. The EUT is placed inside a temperature chamber.

5.2 Timing Measurements

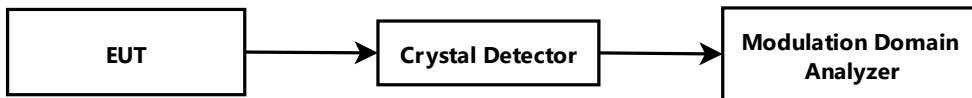

Test Set-up 2

This setup is used for measuring Frame repetition stability and Frame period and Jitter.

5.3 Conducted Emission Test



Test Set-up 3

This setup is used for all conducted emission tests.

5.4 Power Line Conducted Emissions Test

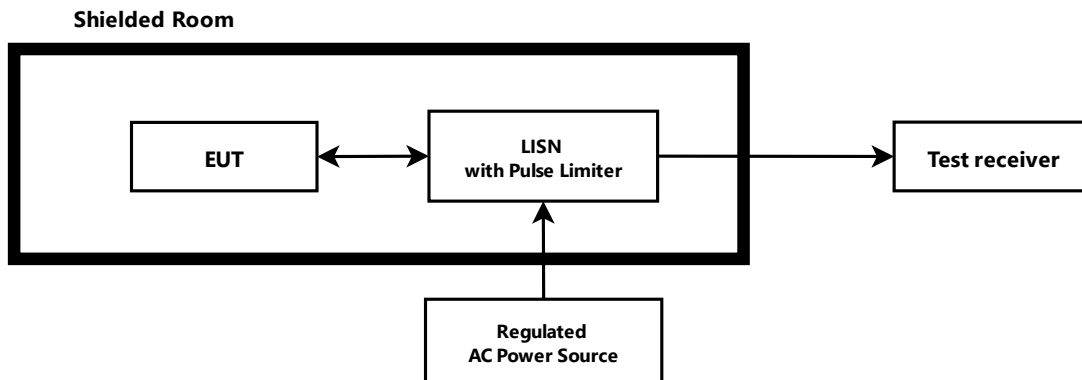

Test Set-Up 4

5.5 Monitoring Tests

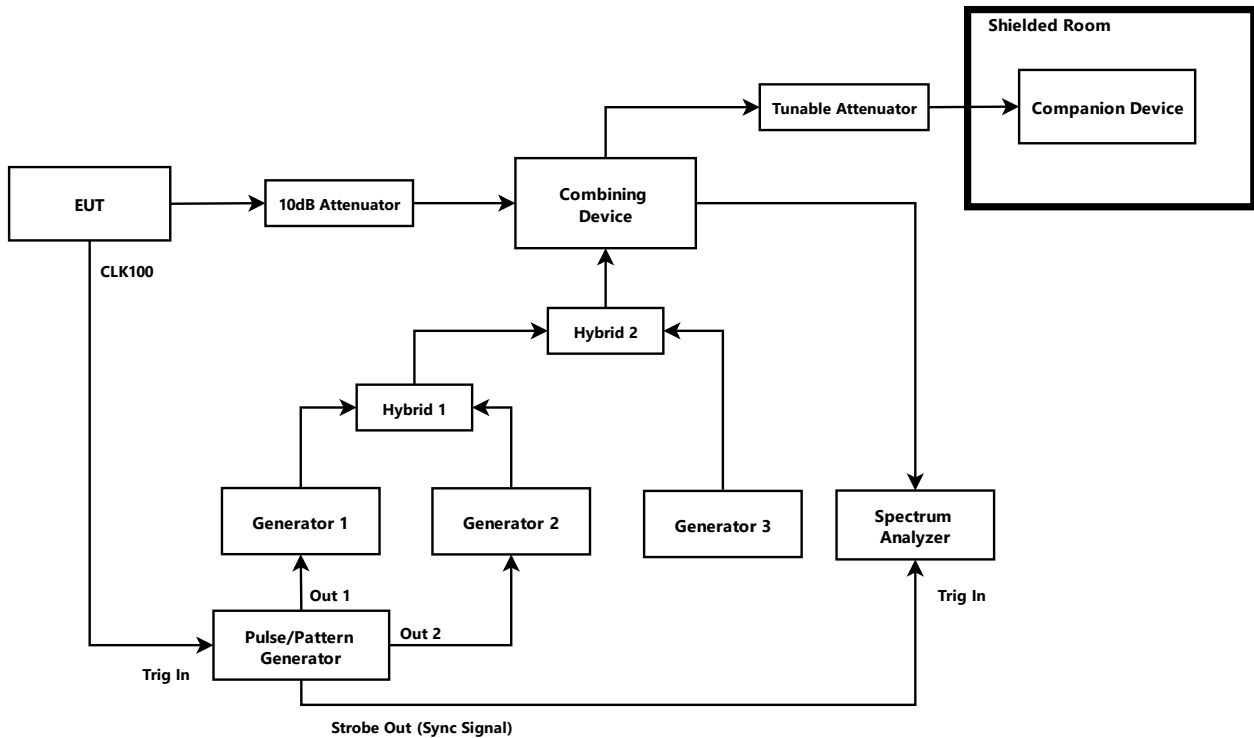

Test Set-Up 5

This test setup is used for all Monitoring and Time and Spectrum Access Procedure tests. The path loss from the signal generators to the EUT is measured with a power meter before the testing is started.

The CLK100 is used to synchronize the Pulse-/ Pattern generator to the start of the DECT frame, this signal always comes from the base station. If the EUT is a DECT Portable Part (i.e. a handset) the CLK100 signal will come from the Companion Device.

The sync signal to the Spectrum Analyzer is the CLK100 signal that is regenerated in the Pulse-/ Pattern Generator, this is used to synchronize the Spectrum Analyzer to the DECT frame when in zero span. The Pulse-/ Pattern Generator is used for tests that require time synchronized pulses or blocking of specific time slots.

6 Test Equipment Used

To facilitate inclusion on each page of the test equipment used for related tests, each item of test equipment and ancillaries are identified (numbered) by the Testhouse.

No.	Model number	Description	Manufacturer	Ref. no.	Cal. date	Cal. Due
1	FSW43	Spectrum Analyzer	Rohde & Schwarz	LR 1690	2024.01	2025.01
2	SMBV100B	Signal generator	Rohde & Schwarz	LR 1743	2024.01	2027.01
3	SMBV100A	Signal generator	Rohde & Schwarz	LR 1655	2024.01	2027.01
4	SMB100A	Signal generator	Rohde & Schwarz	LR 1790	2023.01	2025.01
5	53310A	Modulation Domain Analyzer	Hewlett Packard	LR 1483	2022.12	2024.12
6	81110A	Pulse-/ Pattern Generator	Agilent	LR 1725	COU	
7	8470B	Crystal Detector	Hewlett Packard	LR 1207	N/A	
8	6810.17B	Attenuator	Suhner	LR 1831	COU	
9	745-69	Step Attenuator	Narda	LR 1442	N/A	
10	WE 1506A	Power Splitter	Weinchel	LR 244	COU	
11	WE 1506A	Power Splitter	Weinchel	LR 245	COU	
12	H-9	Hybrid	Anzac	LR 086	COU	
13	H-9	Hybrid	Anzac	LR 257	COU	
14	S212DS	RF Switch	Narda	LR 1244	N/A	
15	ESR7	Measuring Receiver	Rohde & Schwarz	LR 1675	2024-01	2026-01
16	ENV216	Two Line V-Network	Rohde & Schwarz	LR 1665	2024-01	2026-01
17	6812B	AC Power Source	Agilent	LR 1515	2022-11	2024-11
18	87H35-1	Circulator	Racal-MESL	s.no.: 140	N/A	
19	87H35-1	Circulator	Racal-MESL	s.no.: 141	N/A	
20	87H35-1	Circulator	Racal-MESL	s.no.: 142	N/A	
21	TY80	Climatic Chamber	ACS	LR 1083	2024.04	2025.04
22	U2000A	Average Power Sensor	Agilent	LR 1523	2023.01	2025.01
23	ST18/SMA/N/36	RF Cable	Suhner	LR 1627	COU	

COU = Cal on use

The software listed below has been used for one or more tests.

No.	Manufacturer	Name	Version	Comment
1	Rohde & Schwarz	EMC32	10.60.20	Power Line Conducted test software
2	Rohde & Schwarz	EMC32	10.60.20	Radiated Emission test software
3	Nemko AS	RSPlot	1.0.8.0	Screenshots from R&S Spectrum Analyzers
4	Agilent	Intuitlink Data Capture	2.1.0	Screenshots from HP 53310A