



Test report no. : 201776-5

Item tested : KX-UDT121

Type of equipment : UPCS Handset

FCC ID : ACJ96NKX-UDT121

Client : Panasonic System Networks Co., Ltd.

FCC Part 15, subpart D

Isochronous UPCS Device
1920 - 1930 MHz

Industry Canada RSS-213, Issue 2

2 GHz Licence-exempt Personal
Communications Service Devices
(LE-PCS)

14 May 2012

Authorized by :

G. Suhanthakumar
Technical Vericator



CONTENTS

1	GENERAL INFORMATION	3
1.1	Testhouse Info	3
1.2	Client Information	3
1.3	Manufacturer (if other than client)	3
2	TEST INFORMATION	4
2.1	Tested Item	4
2.2	Description of Tested Device	4
2.3	Exposure Evaluation	4
2.4	Test Environment	5
2.5	Test Period	5
2.6	Test Engineer(s)	5
2.7	Test Equipment	5
2.8	Other Comments	5
3	TEST REPORT SUMMARY	6
3.1	General	6
3.2	Test Summary	7
4	TEST RESULTS	8
4.1	Power Line Conducted Emissions	8
4.2	Coordination with fixed microwave	9
4.3	Digital Modulation Techniques	9
4.4	Labeling Requirements	9
4.5	Antenna Requirement	10
4.6	Channel Frequencies	10
4.7	Automatic Discontinuation of Transmission	11
4.8	Peak Power Output	12
4.9	Emission Bandwidth <i>B</i>	17
4.10	Power Spectral Density	20
4.11	In-Band Unwanted Emissions, Conducted	23
4.12	Out-of-band Emissions, Conducted	25
4.13	Carrier Frequency Stability	30
4.14	Frame Repetition Stability	31
4.15	Frame Period and Jitter	31
4.16	Monitoring Threshold, Least Interfered Channel	33
4.17	Threshold Monitoring Bandwidth	35
4.18	Reaction Time and Monitoring Interval	36
4.19	Time and Spectrum Window Access Procedure	38
4.20	Acknowledgements and Transmission Duration	39
4.21	Dual Access Criteria Check	41
4.22	Alternative Monitoring Interval	45
5	TEST SETUPS	46
5.1	Frequency Measurements	46
5.2	Timing Measurements	46
5.3	Conducted Emission Test	46
5.4	Power Line Conducted Emissions Test	47
5.5	Monitoring Tests	47
5.6	Radiated Emissions Test, Fully Anechoic Chamber	48
6	TEST EQUIPMENT USED	49

1 GENERAL INFORMATION

1.1 Testhouse Info

Name : Nemko AS
Address : Nemko Kjeller
Instituttveien 6
N-2007 Kjeller, NORWAY
Telephone : +47 64 84 57 00
Fax : +47 64 84 57 05
E-mail: comlab@nemko.com
FCC test firm registration # : 994405
IC OATS registration # : 2040D-1
Total Number of Pages: 49

1.2 Client Information

Name : Panasonic System Networks Co., Ltd.
Address : 1-62, 4-chome Minoshima, Hakata-ku, Fukuoka, 812-8531, Japan
Telephone : +81-92-477-1405

Contact:

Name : Mr. Michihito Miyazaki
Telephone : +81-92-477-1405
E-mail : michihito.miyazaki@jp.panasonic.com

1.3 Responsible Manufacturer (if other than client)

Same as client.

2 Test Information

2.1 Tested Item

Name :	Panasonic
Model name :	KX-UDT121
FCC ID :	ACJ96NKX-UDT121
Industry Canada ID :	216A-KXUDT121
Serial number :	/
Hardware identity and/or version:	PNLB2026ZBxx
Software identity and/or version :	SW045
Tested to IC Radio Standard (RSS) :	RSS-213 Issue 2, RSS-GEN Issue 3
Test Site IC Reg. Number :	IC 2040D-1
Frequency Range :	1921.536 – 1928.448 MHz
Number of Channels :	5 RF Channels, 5x12 = 60 TDMA Duplex Channels
Type of Modulation :	Digital (Gaussian Frequency Shift Keying)
Conducted Output Power :	72 mW (Peak)
Antenna Connector :	None
Number of Antennas :	2
Antenna Diversity Supported :	Yes
Desktop Charger :	PNLC1032ZA with Power Adaptor PNLV226
Power Supply :	Secondary Battery (3.7V Li-Ion)

2.2 Description of Tested Device

The EUT is a DECT Handset and is an initiating device as described in ANSI C63.17 and is designed to operate together with a DECT fixed part (i.e. a base station), which is the responding device.

2.3 Exposure Evaluation

The EUT is a portable device and is designed to be held to ear or worn in a belt clip when used. A test reports with the measured SAR values for both configurations are submitted with the application.

2.4 Test Environment

Temperature:	20 – 25 °C
Relative humidity:	30 – 50 %
Normal test voltage:	3.7 V DC (Secondary Battery, Li-Ion)

The values are the limit registered during the test period. All tests were performed with a fully charged battery.

2.5 Test Period

Item received date:	2012-03-22
Test period :	from 2012-04-11 to 2012-05-09

2.6 Test Engineer(s)

Frode Sveinsen / Thomas Dangle

2.7 Test Equipment

See list of test equipment in clause 6.

2.8 Other Comments

The Monitoring and Time and Spectrum Window Access tests were performed with Test Set-Up 6 (Ref. clause 5). A clock signal from the companion device was used to synchronize the Pulse Pattern Generator and the Spectrum Analyzer to the start of the DECT time window. The EUT was limited by administrative commands to operate on only two frequency carriers. For the tests where the EUT was required to operate on only one frequency carrier, one carrier was blocked by applying a CW interfering signal from RF Generator 3. The Pulse Pattern Generator was used to apply time synchronized interference to time windows where this was required.

Since the EUT was programmed to operate on only two RF carriers, it was only necessary with two RF generators for the monitoring tests, however a third generator was applied for the tests that required specific time slots to be blocked.

The tested EUT supports both normal DECT slot length and DECT Long slot. Long slot is effectively two normal DECT slots that is bonded together to allow a higher data rate for speech codecs with bit rate higher than 32kbps.

This EUT supports Least Interfered Channel procedure (LIC), the Monitoring and Time and Spectrum Window Access tests were conducted as specified for EUTs that support LIC procedure.

All tests except Antenna Gain and Power-Line Conducted Emissions were performed in conducted mode with a temporary antenna connector.

3 TEST REPORT SUMMARY

3.1 General

Manufacturer: Panasonic
Model No.: KX-UDT121
Serial No.: /

All measurements are traceable to national standards.

The tests were conducted on a sample of the equipment for the purpose of demonstrating compliance with FCC CFR47 Part 15D for Isochronous UPCS Devices and Industry Canada RSS-213 Issue 2 / RSS-GEN Issue 3.

All tests were conducted in accordance with ANSI C63.4-2009 and ANSI C63.17-2006. Antenna Gain tests were made in a 3m fully-anechoic chamber.

A description of the test facility is on file with the FCC and Industry Canada.

- | | |
|---|---|
| <input checked="" type="checkbox"/> New Submission | <input checked="" type="checkbox"/> Production Unit |
| <input type="checkbox"/> Class II Permissive Change | <input type="checkbox"/> Pre-production Unit |
| PUE Equipment Code | <input type="checkbox"/> Family Listing |

THIS TEST REPORT APPLIES ONLY TO THE ITEM(S) AND CONFIGURATIONS TESTED.

Deviations from, additions to, or exclusions from the test specifications are described in "Summary of Test Data".



TEST REPORT NO: 201776-5

TESTED BY : Frode Sveinsen
Frode Sveinsen, Chief Engineer

DATE: 10 May 2012

Nemko Group authorizes the above named company to reproduce this report provided it is reproduced in its entirety and for use by the company's employees only. Any reproduction of parts of this report requires approval in writing from Nemko Group.

Any use which a third party makes of this report, or any reliance on or decisions to be made based on it, are the responsibility of such third parties. Nemko Group accepts no responsibility for damages suffered by any third party as a result of decisions made or actions based on this report.

3.2 Test Summary

Name of test	FCC CFR 47 Paragraph #	IC RSS-213 Paragraph #	Verdict
Coordination with fixed microwave	15.307(b)	N/A	Complies
Digital Modulation Techniques	15.319(b)	6.1	Complies
Labeling requirements	15.19(a)(3)	3 RSS-GEN 5.2	Complies
Antenna Requirement	15.317, 15.203	RSS-GEN 7.1.2	Complies
Power Line Conducted Emission	15.107(a) 15.207(a)	6.3 RSS-GEN 7.2.2	Complies
Emission Bandwidth	15.323(a)	6.4	Complies
In-band emissions	15.323(d)	6.7.2	Complies
Out-of-band emissions	15.323(d)	6.7.1	Complies
Output Power and Antenna Gain	15.319(c)(e), 15.31(e)	6.5 and 4.1(e)	Complies
Power Spectral Density	15.319(d)	4.3.2.1	Complies
Automatic discontinuation of transmission	15.319(f)	4.3.4(a)	Complies
Carrier frequency stability	15.323(f)	6.2	Complies
Frame repetition stability	15.323(e)	4.3.4(c)	Complies
Frame period and jitter	15.323(e)	4.3.4(c)	Complies
Monitoring threshold, Least interfered channel	15.323(c)(2);(5); (9)	4.3.4(b)	Complies
Monitoring of intended transmit window and maximum reaction time	15.323(c)(1)	4.3.4(b)	Complies
Threshold monitoring bandwidth	15.323(c)(7)	4.3.4(b)	Complies
Reaction time and monitoring interval	15.323(c)(1);(5); (7)	4.3.4(b)	Complies
Access criteria test interval	15.323(c)(4);(6)	4.3.4(b)	N/A ¹
Access Criteria functional test	15.323(c)(4);(6)	4.3.4(b)	N/A ¹
Acknowledgements	15.323(c)(4)	4.3.4(b)	Complies
Transmission duration	15.323(c)(3)	4.3.4(b)	Complies
Dual access criteria	15.323(c)(10)	4.3.4(b)	Complies
Alterative monitoring interval	15.323(c)(10);(11)	4.3.4(b)	N/A ²
Spurious Emissions (Radiated)	15.319(g) 15.109(a) 15.209(a)	4.3.3 RSS-GEN 7.2.3	N/A ³

¹ Only applies for equipment that transmits unacknowledged control and signaling information

² The client declares that the tested equipment does not implement this provision

³ Not required if the Conducted Out-of-Band Emissions test is Passed

4 TEST RESULTS

4.1 Power Line Conducted Emissions

Para. No.: 15.207 (a)

Test Performed By: Thomas Dangle	Date of Test: 23 April 2012
----------------------------------	-----------------------------

Measurement procedure: ANSI C63.4-2009 using 50 μ H/50 ohms LISN.

Test Results: **Complies**

Measurement Data: See attached graph, (Peak detector).

Highest measured value (L1 and N):

In Charger, Charging, Phase L1 and N, 120V 60Hz:

Frequency [MHz]	Level [dBuV]	Af [dB]	Limit [dBuV]	Margin [dB]	Det	Position	Verdict [Pass/Fail]
0.355000	28.20	10.20	48.80	20.60	AV	N	Pass
1.735000	22.00	10.20	46.00	24.00	AV	L1	Pass
2.270000	19.80	10.30	46.00	26.20	AV	N	Pass

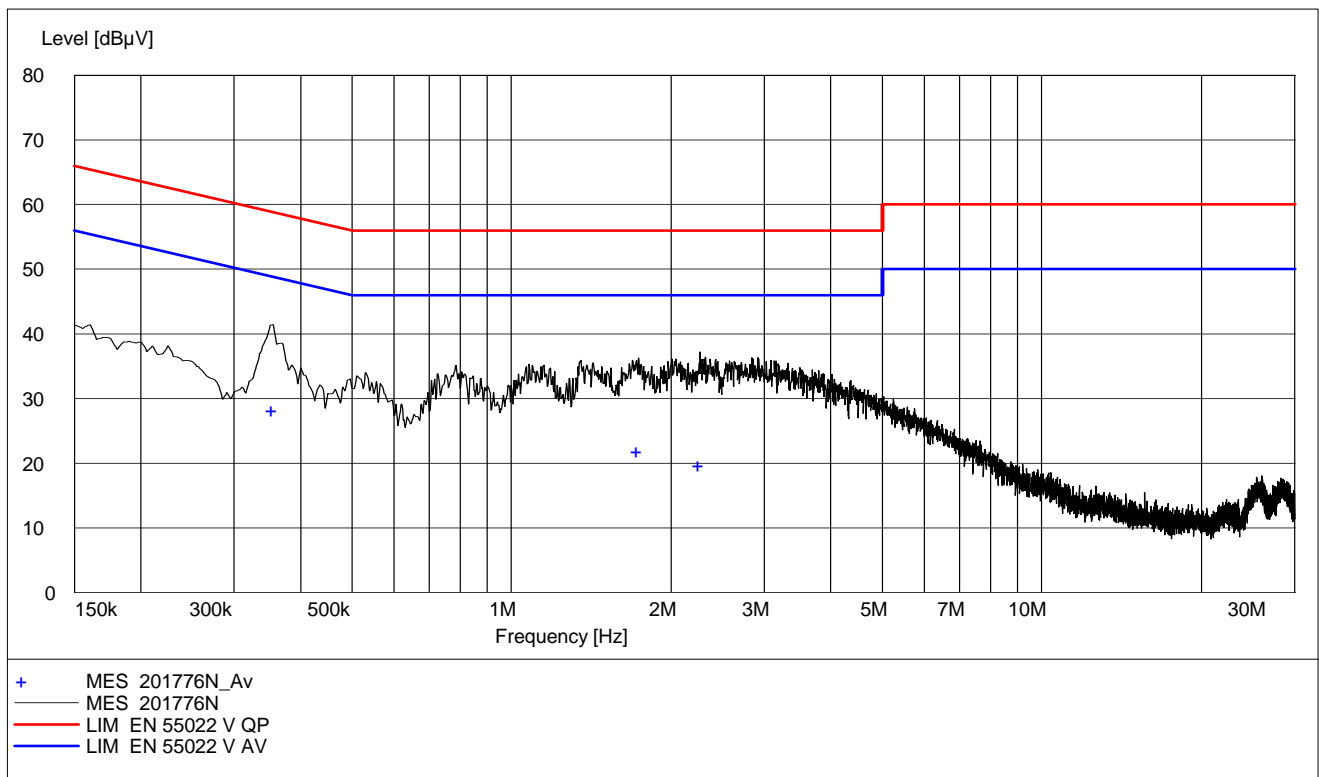

Plot shows maximum of both phases

4.2 Coordination with fixed microwave

The affidavit from UTAM, Inc. is included in the documentation supplied by the applicant:

Yes

No

Requirement, FCC 15.307 (b):

Each application for certification of equipment operating under the provisions of this Subpart must be accompanied by an affidavit from UTAM, Inc. certifying that the applicant is a participating member of UTAM, Inc. In the event a grantee fails to fulfill the obligations attendant to participation in UTAM, Inc., the Commission may invoke administrative sanctions as necessary to preclude continued marketing and installation of devices covered by the grant of certification, including but not limited to revoking certification.

4.3 Digital Modulation Techniques

The EUT uses Multi Carrier / Time Division Multiple Access / Time Division Duplex and Digital GFSK modulation. For further details see the operational description provided by the applicant.

Requirement, FCC 15.319(b):

All transmissions must use only digital modulation techniques.

4.4 Labeling Requirements

See separate documents showing the label design and the placement of the label on the EUT.

Requirements FCC 15.19

The FCC Identifier shall be displayed on the label, and the device(s) shall bear the following statement in a conspicuous location on the device or in the user manual if the device is too small:

This device complies with Part 15 of the FCC Rules. Operation is subject to the following two conditions: (1) this device may not cause harmful interference, and (2) this device must accept any interference received, including interference that may cause undesired operation.

The label itself shall be of a permanent type, not a paper label, and shall last the lifetime of the equipment.

4.5 Antenna Requirement

Does the EUT have detachable antenna(s)? Yes No

If detachable, is the antenna connector(s) non-standard? Yes No

The tested equipment has only integral antennas. The conducted tests were performed on a sample with a temporary antenna connector.

Requirement: FCC 15.203, 15.204, 15.317.

4.6 Channel Frequencies

UPCS CHANNEL	FREQUENCY (MHz)
Upper Band Edge	1930.000
0 (Highest)	1928.448
1	1926.720
2	1924.992
3	1923.264
4 (Lowest)	1921.536
Lower Band Edge	1920.000

Requirement: FCC 15.303 (d), (g)

Within 1920 -1930 MHz band for isochronous devices.

4.7 Automatic Discontinuation of Transmission

Does the EUT transmit Control and Signaling Information?	<input type="checkbox"/> YES	<input checked="" type="checkbox"/> NO
TYPE OF EUT :	<input checked="" type="checkbox"/> INITIATING DEVICE	<input type="checkbox"/> RESPONDING DEVICE

The following tests simulate the reaction of the EUT in case of either absence of information to transmit or operational failure after a connection with the companion device is established.

Number	Test	EUT Reaction	Verdict
1	Power removed from EUT	C	Pass
2	Switch Off EUT	C	Pass
3	Hook-On by EUT	C	Pass
4	Power Removed from Companion Device	A	Pass
5	Switch Off Companion Device	N/A	Pass
6	Hook-On by Companion Device	N/A	Pass

- A - Connection breakdown, Cease of all transmissions
- B - Connection breakdown, EUT transmits control and signaling information
- C - Connection breakdown, Companion Device transmits control and signaling information
- N/A - Not Applicable (Companion Device does not have On/Off switch and cannot perform Hook-On)

Requirements, FCC 15.319(f)

The device shall automatically discontinue transmission in case of either absence of information to transmit or operational failure. These provisions are not intended to preclude transmission of control and signaling information or use of repetitive codes used by certain digital technologies to complete frame or burst intervals.

4.8 Peak Power Output

Test Method:

ANSI C63.17, clause 6.1.2.

Test Results: Complies

Measurement Data:

Maximum Conducted Output Power

Channel No.	Frequency (MHz)	Maximum Conducted Output Power (dBm)	Maximum Radiated Output Power (dBm)	Maximum Antenna Gain (dBi)
4	1921.536	18.1	15.1	-3.0
2	1924.992	18.3	15.0	-3.3
0	1928.448	18.6	14.9	-3.7

Substitution:

Frequency MHz	Measured value dBm	Subst. Gen. (incl. corr.) dBm	Attenuator and Cable dB	Gain Subst. Antenna dB	Result dBm
1921.536	15.3	21.8	-15.0	8.3	15.1
1924.992	15.2	21.7	-15.0	8.3	15.0
1928.448	15.1	21.6	-15.0	8.3	14.9

Result = Subst.Gen. + Attenuator + Cable + Antenna Gain

Limit:

Conducted: $100 \mu\text{W} \times \text{SQRT}(B)$ where B is the measured Emission Bandwidth in Hz

FCC 15.319(c)(e): 21.1 dBm (127 mW)

RSS-213, Issue 2: 20.5 dBm (112 mW)

The antenna gain is below 3 dBi, no reduction in transmit power is necessary.

Requirements, FCC 15.319(c)(e), RSS-213, Issue 2

Peak transmit power shall not exceed 100 microwatts multiplied by the square root of the emission bandwidth in Hertz.

The peak transmit power shall be reduced by the amount in decibels that the maximum directional gain of the antenna exceeds 3 dBi.

Conducted Peak Output Power

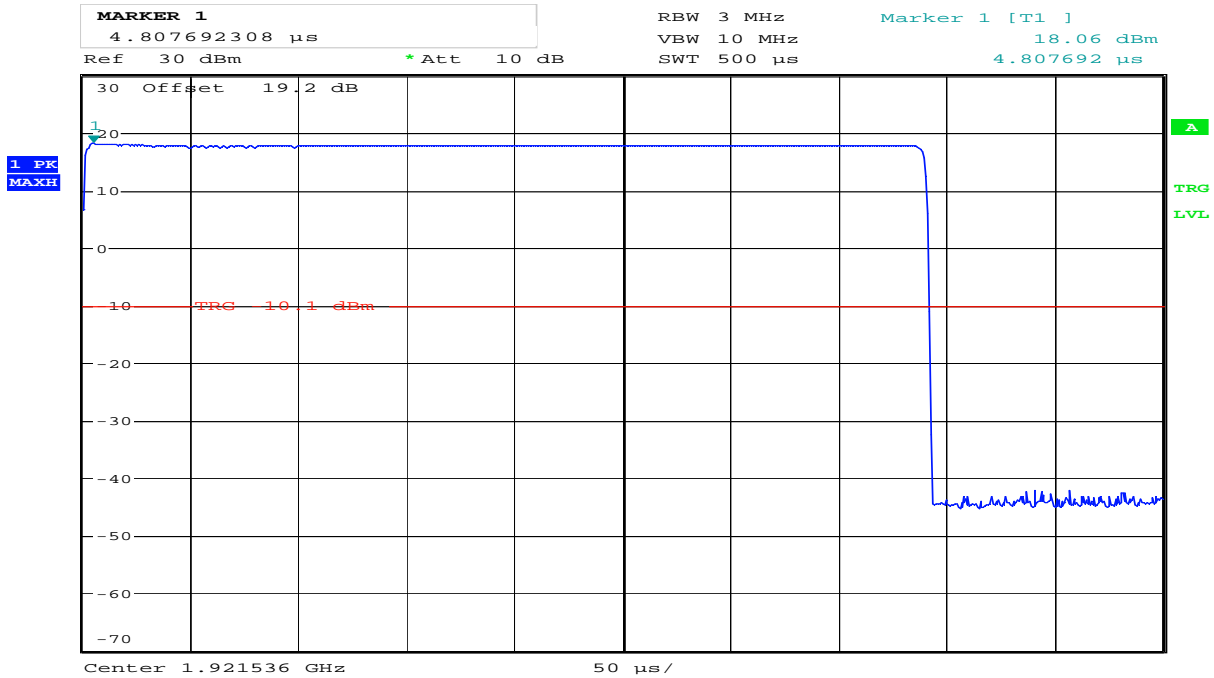

Date: 11.APR.2012 13:54:38

Lower Channel

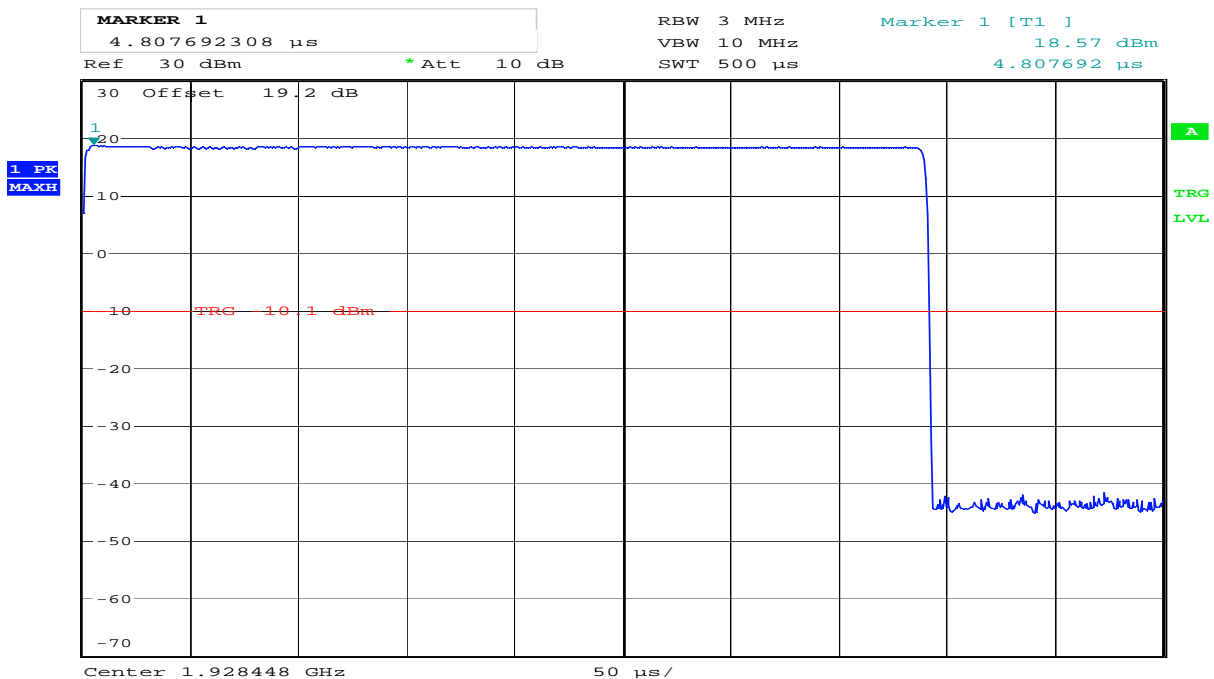

Date: 11.APR.2012 13:53:31

Upper Channel

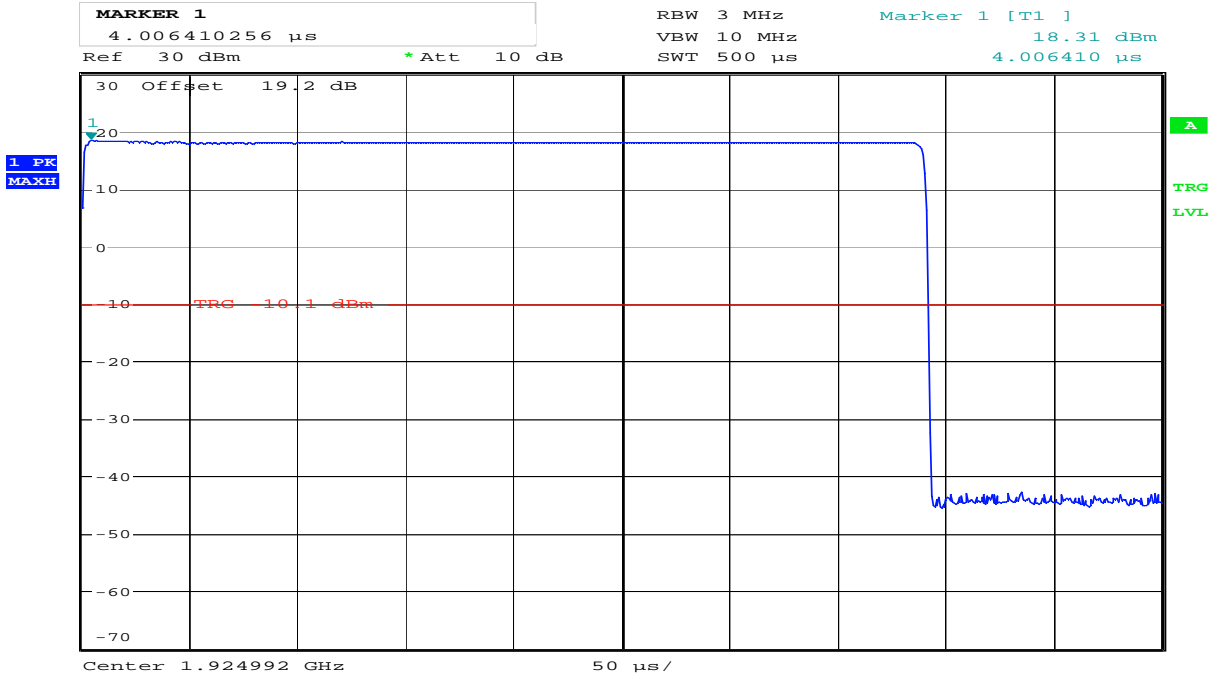

Date: 11.APR.2012 13:54:03

Middle Channel

Radiated Peak Output Power

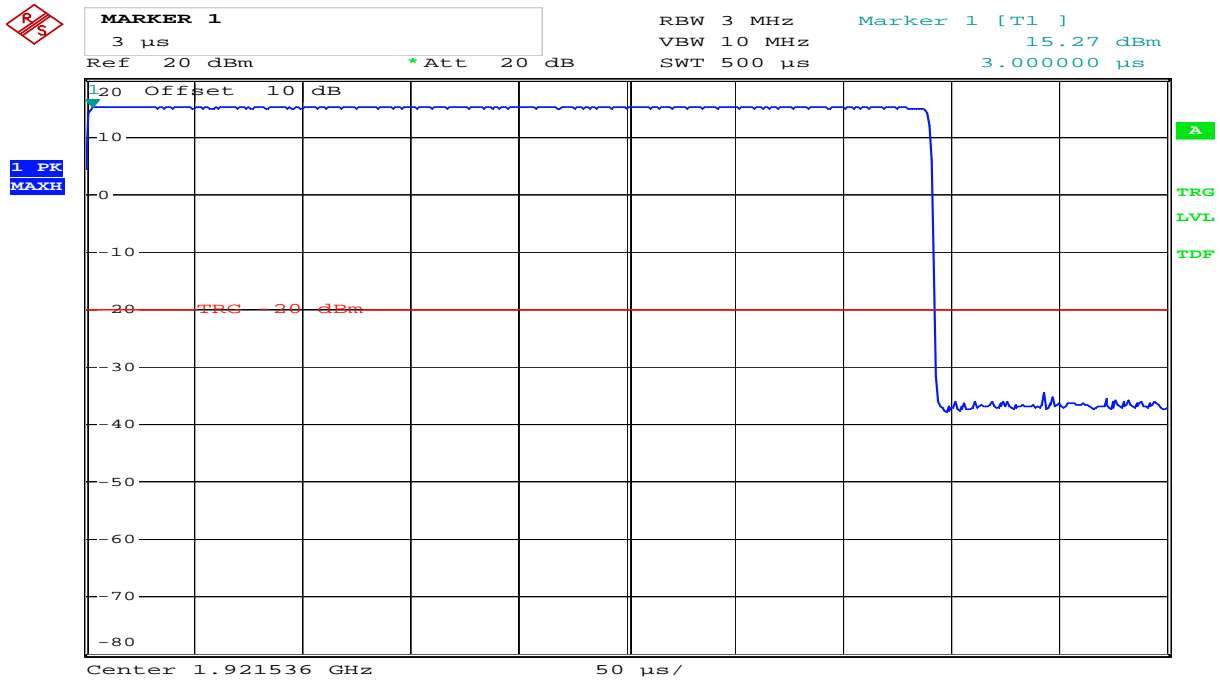

Date: 18.APR.2012 14:11:07

Lower Channel (Max: EUT H1, Ant 1, HP)

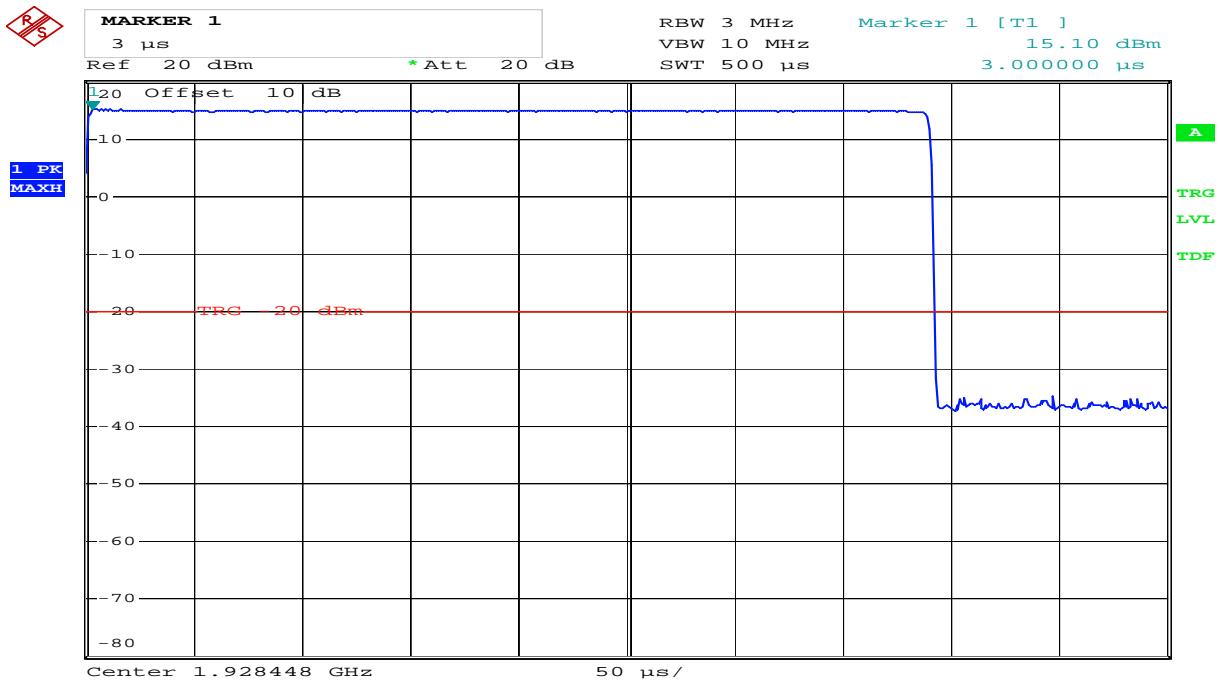

Date: 18.APR.2012 14:09:44

Upper Channel (Max: EUT H1, Ant 1, HP)



MARKER 1
 4 μ s
 Ref 20 dBm *Att 20 dB

RBW 3 MHz Marker 1 [T1]
 VBW 10 MHz 15.18 dBm
 SWT 500 μ s 4.000000 μ s

1 PK
 MAXH

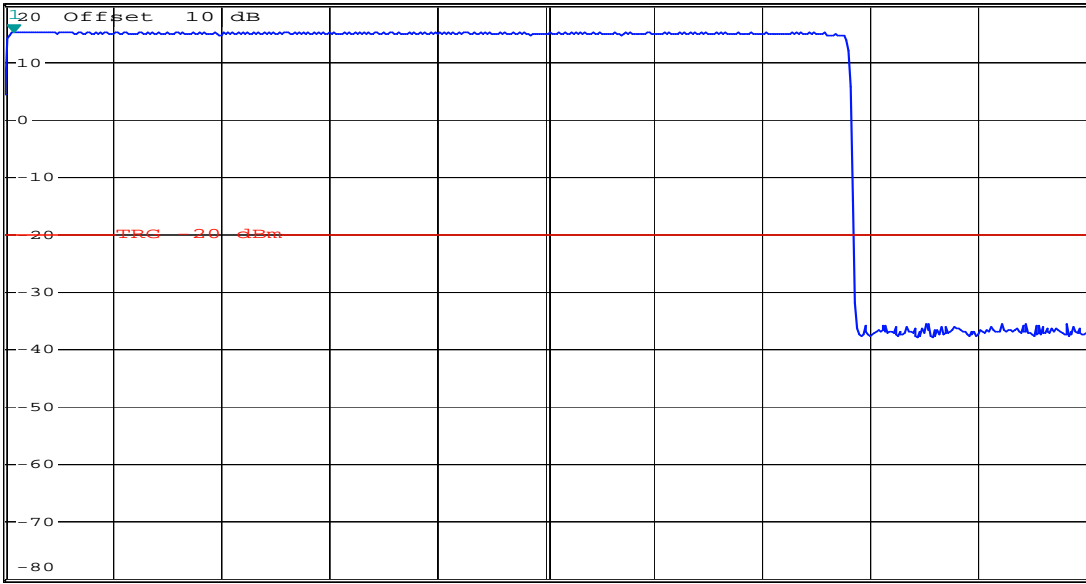

Center 1.924992 GHz 50 μ s/

Date: 18.APR.2012 14:06:23

Middle Channel (Max: EUT H1, Ant 1, HP)

4.9 Emission Bandwidth *B*

Test Method:

ANSI C63.17, clause 6.1.3.

Test Results: Complies

Measurement Data:

Channel No.	Frequency (MHz)	26 dB Bandwidth <i>B</i> (kHz)
4	1921.536	1618.6
0	1928.448	1634.6

Channel No.	Frequency (MHz)	99% Bandwidth (kHz)
2	1924.992	1250.0

Channel No.	Frequency (MHz)	6 dB Bandwidth (kHz)
4	1921.536	N/A
0	1928.448	N/A

Channel No.	Frequency (MHz)	12 dB Bandwidth (kHz)
4	1921.536	N/A
0	1928.448	N/A

Requirements, FCC 15.323(a)

The 26 dB Bandwidth *B* shall be larger than 50 kHz and less than 2.5 MHz.

Requirements, RSS-213 Issue 2, clause 6.4

The 99% Bandwidth shall be larger than 50 kHz and less than 2.5 MHz.

No requirements for 6 and 12 dB Bandwidth, these values are only used for testing Monitoring Bandwidth if the Simple Compliance test fails (ANSI C63.17, clause 7.4).

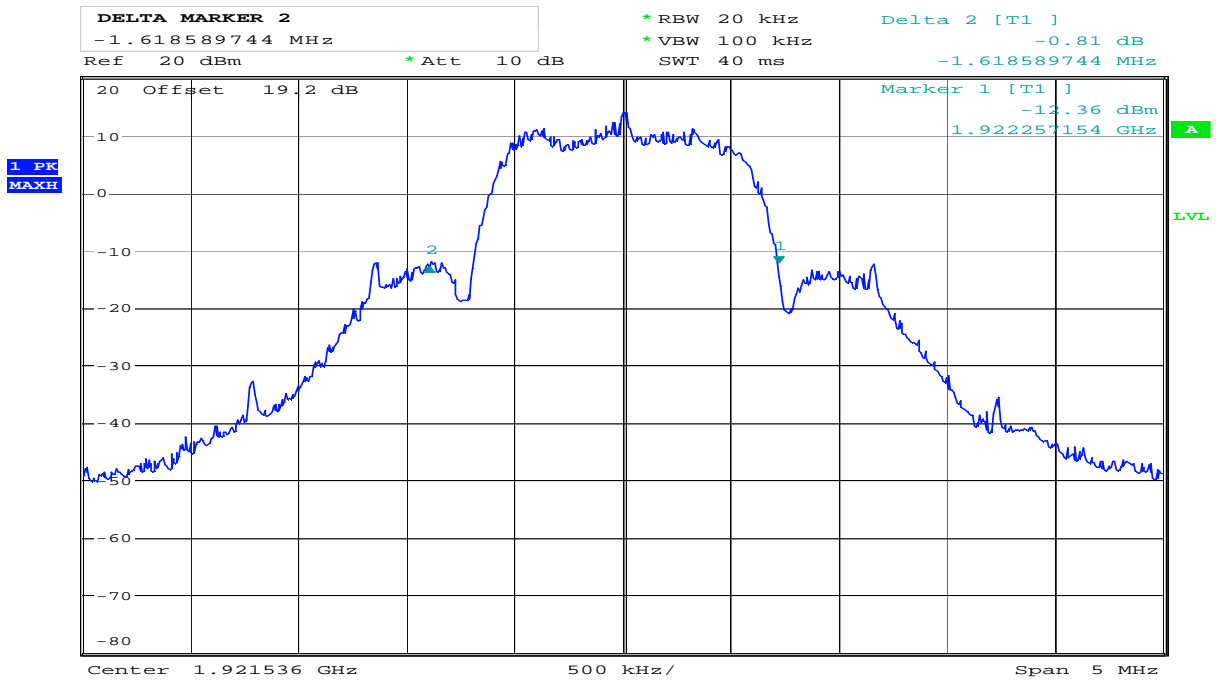

Date: 11.APR.2012 14:53:42

Emission Bandwidth B, Lower Channel

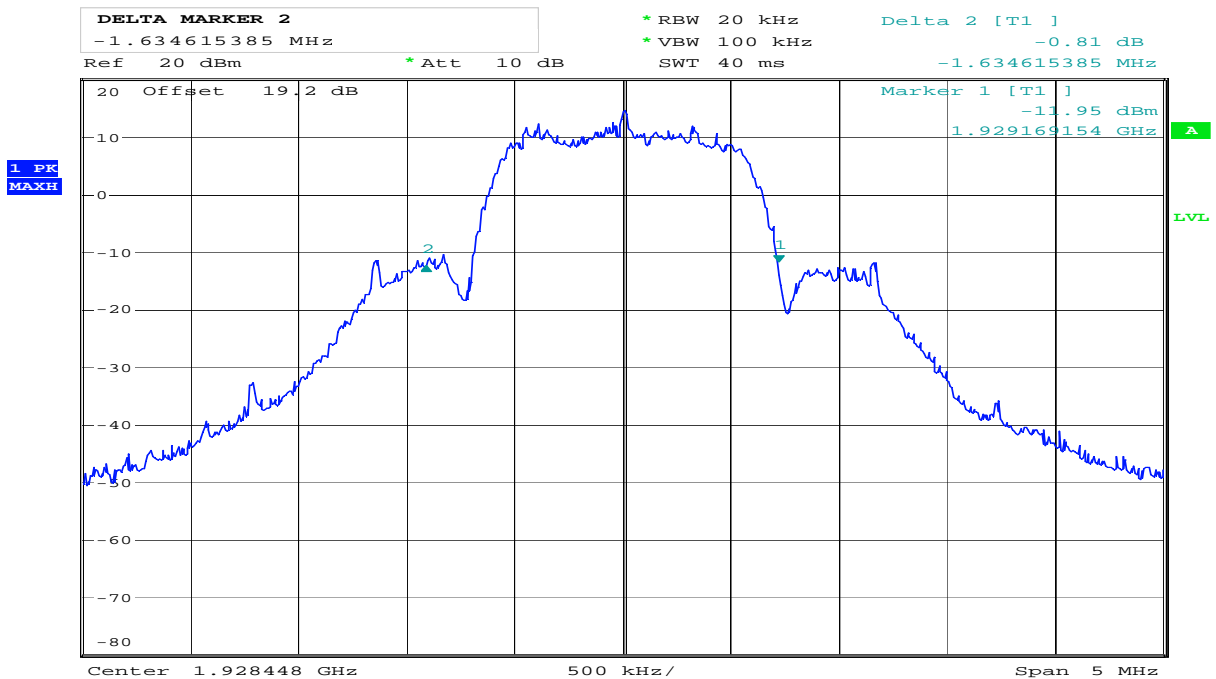

Date: 11.APR.2012 14:45:29

Emission Bandwidth B, Upper Channel

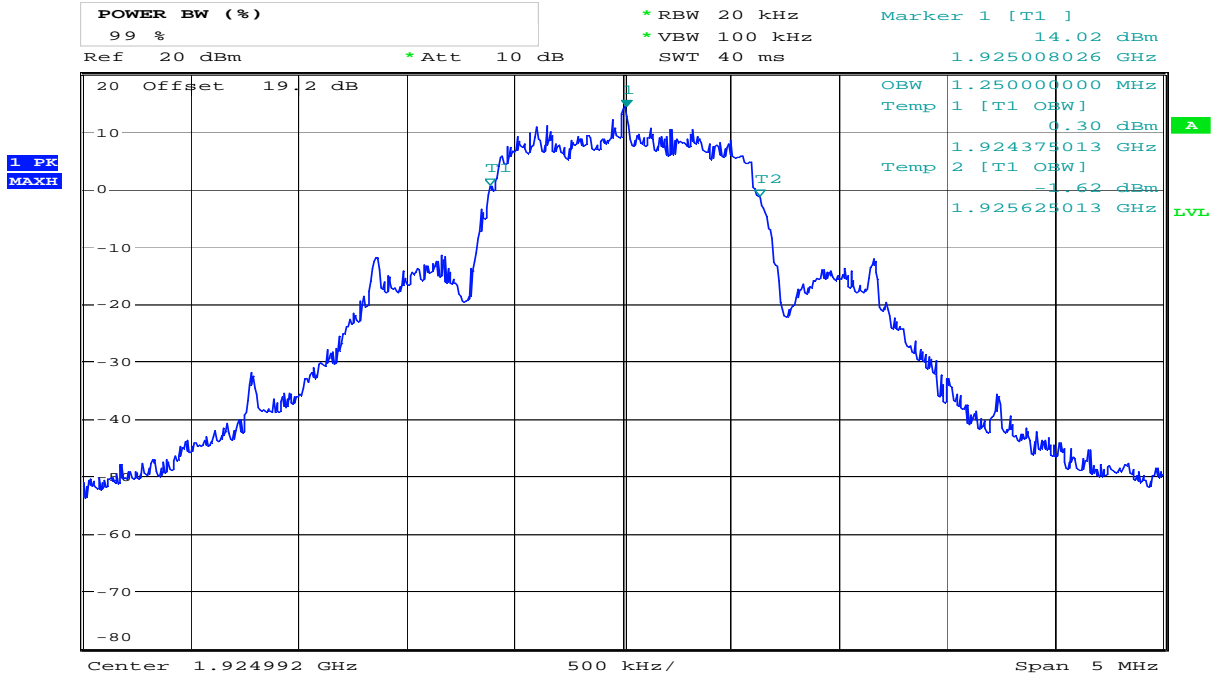

Date: 11.APR.2012 14:55:16

99% Bandwidth, Middle Channel

4.10 Power Spectral Density

Test Method:

ANSI C63.17, clause 6.1.5.

Test Results: Complies

Measurement Data:

Channel No.	Frequency (MHz)	Power Spectral Density (dBm)
4	1921.536	-0.8
0	1928.448	0.9

Averaged over 1000 sweeps.

Requirements, FCC 15.319(d)

The Power Spectral Density shall be less than 3 mW (4.77 dBm) when averaged over at least 100 sweeps.

Power Spectral Density

Lower Channel:

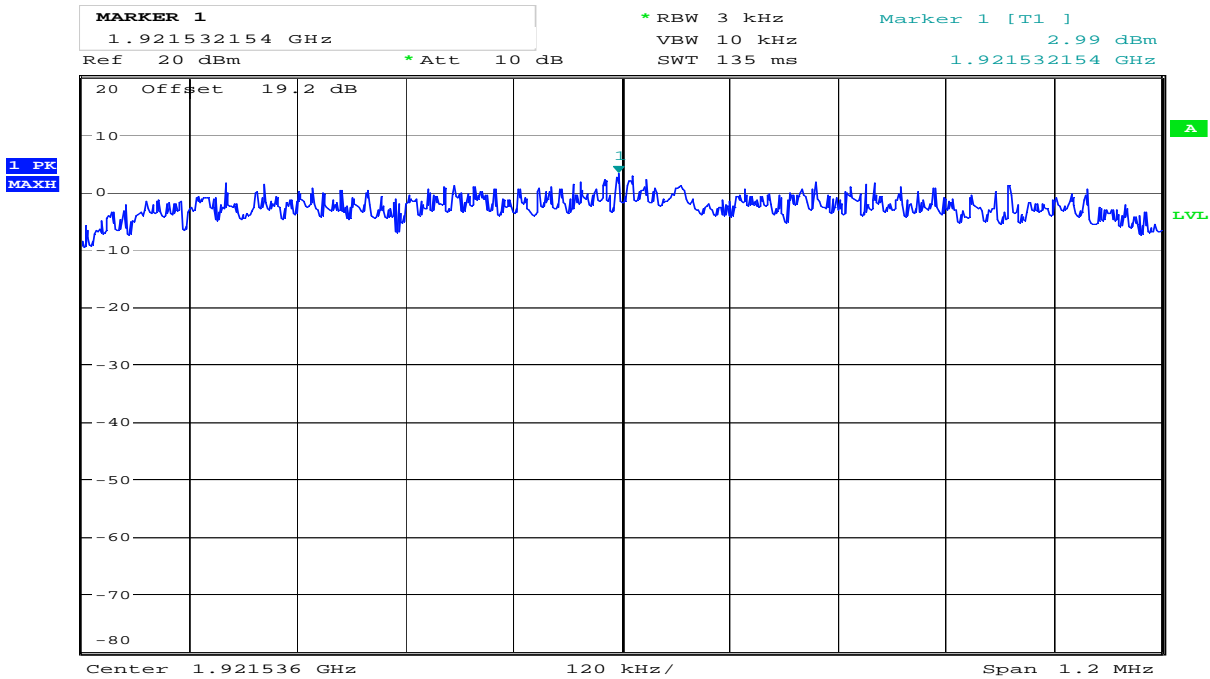

Date: 11.APR.2012 15:04:28

Overview

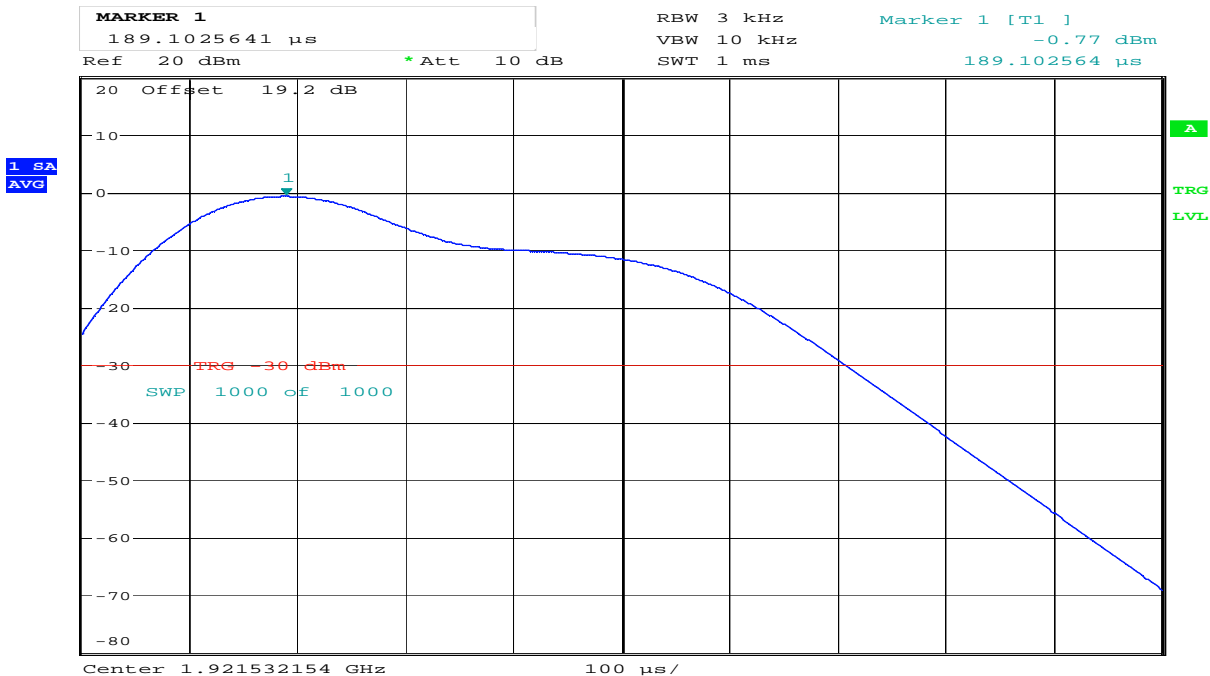

Date: 11.APR.2012 15:05:41

Averaged, 1000 Sweeps

Upper Channel:

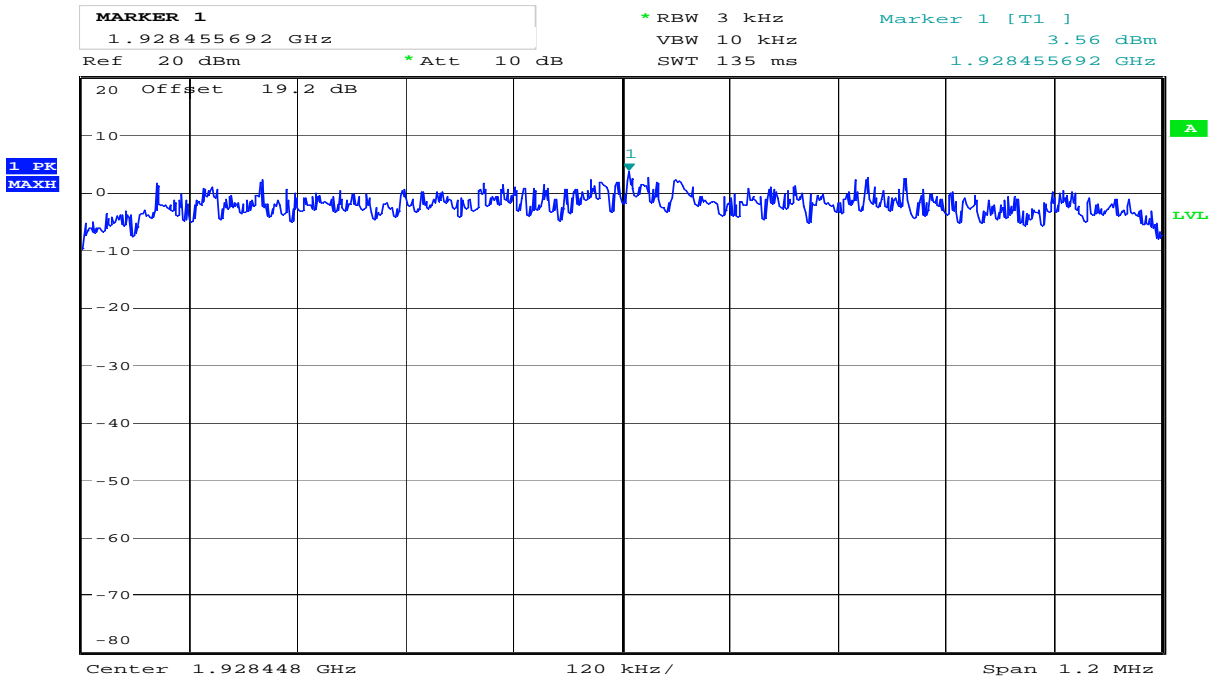

Date: 11.APR.2012 15:01:22

Overview

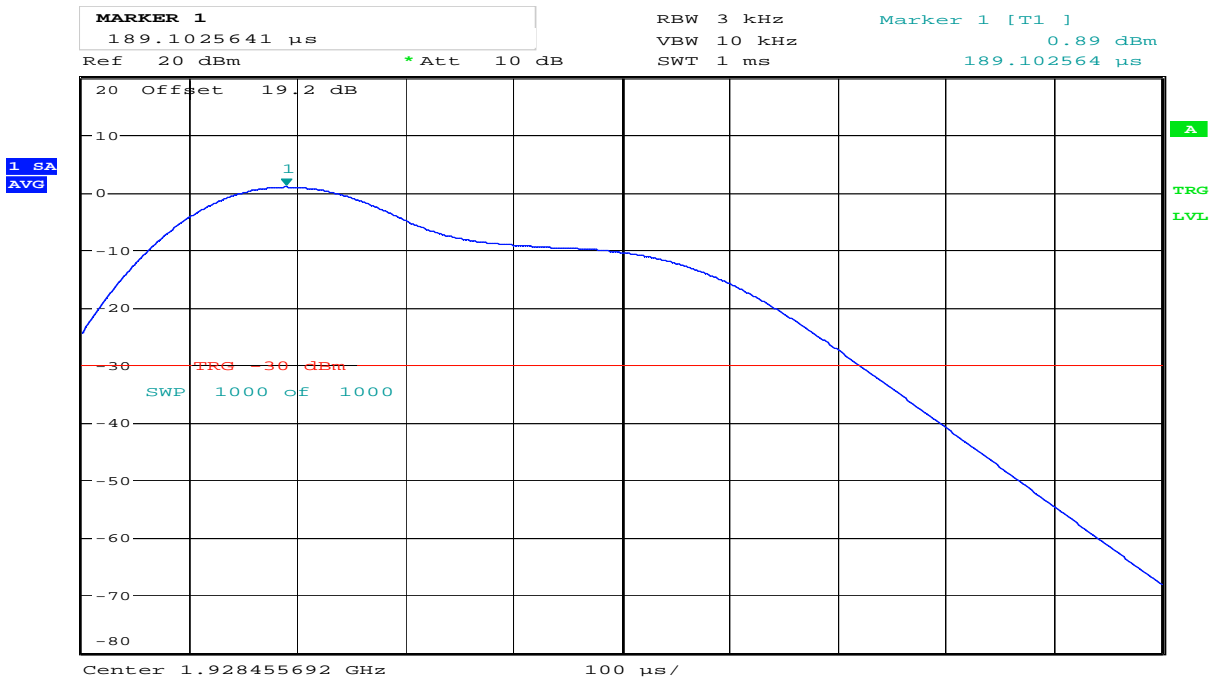

Date: 11.APR.2012 15:02:36

Averaged, 1000 Sweeps

4.11 In-Band Unwanted Emissions, Conducted

Test Method:

ANSI C63.17, clause 6.1.6.1.

Test Results: Complies

Measurement Data:

See plots.

Requirements, FCC 15.323(d):

$B < f \leq 2B$: at least 30 dB below max. permitted peak power

$2B < f \leq 3B$: at least 50 dB below max. permitted peak power

$3B < f \leq$ UPCS Band Edge : at least 60 dB below max. permitted peak power

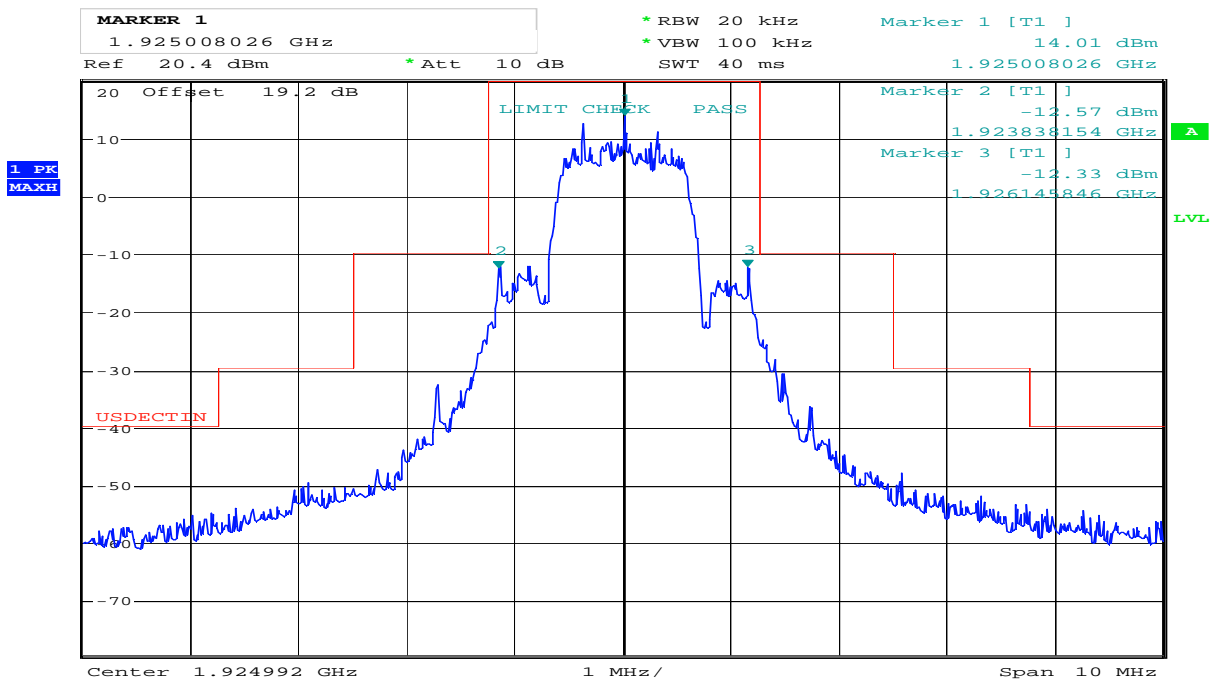

Date: 11.APR.2012 13:42:42

Middle Channel

In-Band Unwanted Emissions, Conducted

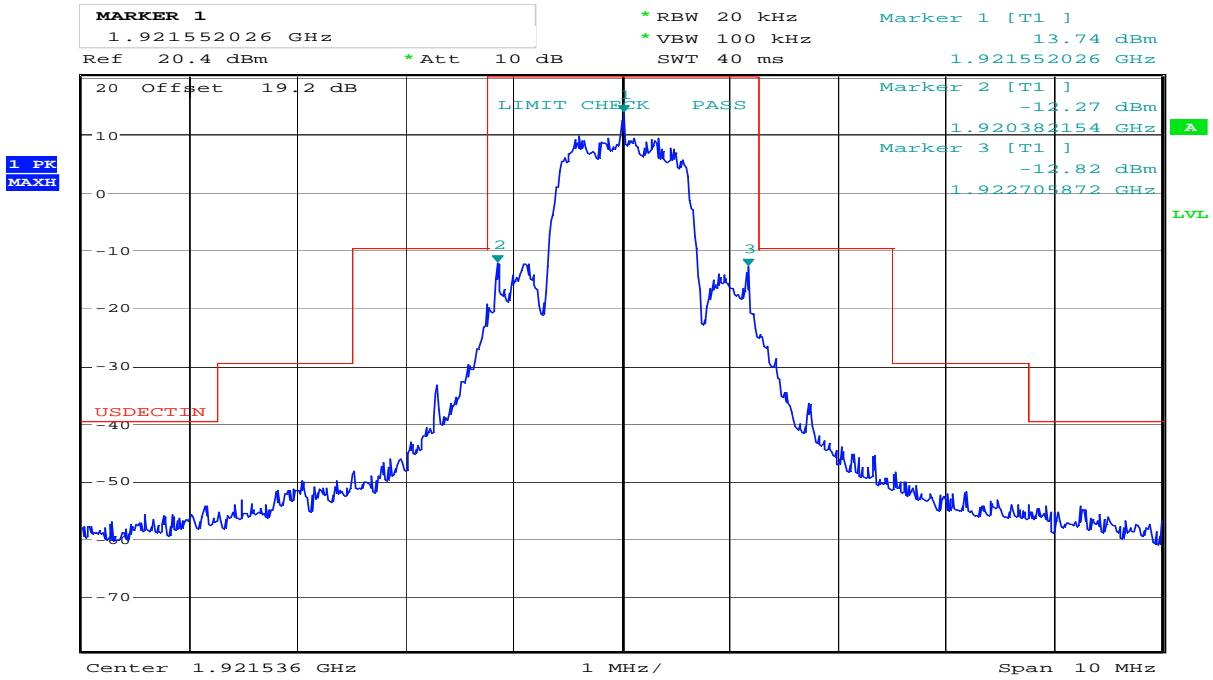

Date: 11.APR.2012 13:44:47

Lower Channel

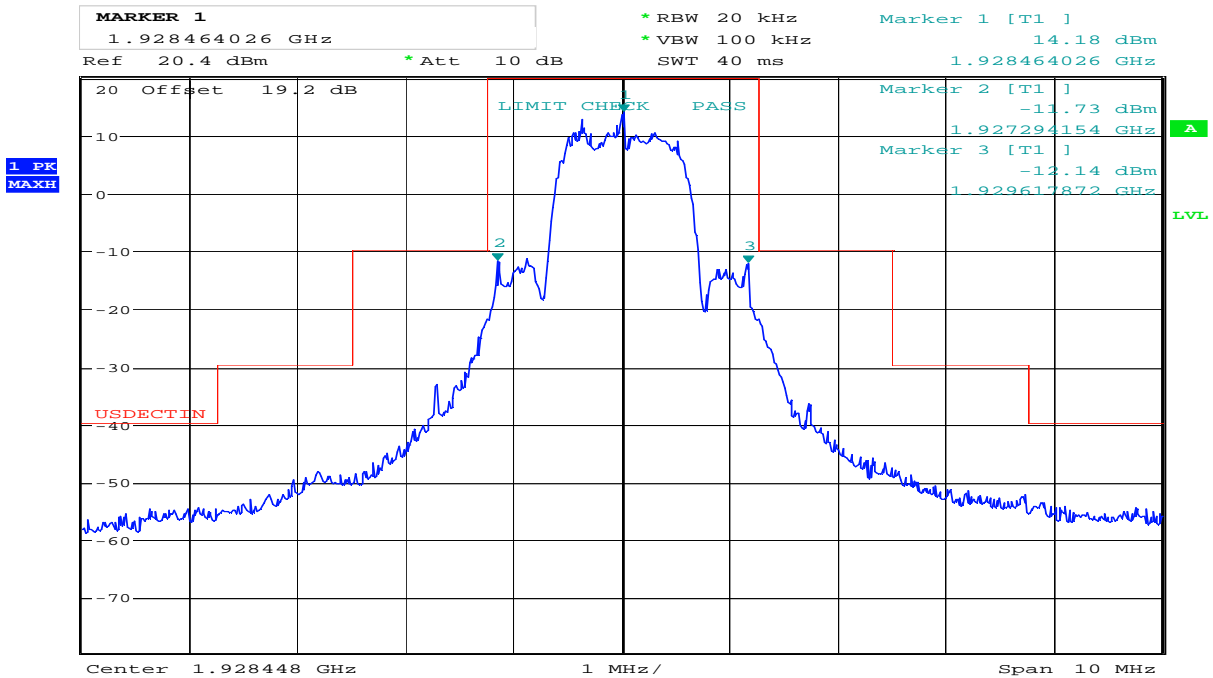

Date: 11.APR.2012 13:52:38

Upper Channel

4.12 Out-of-band Emissions, Conducted

Test Method:

ANSI C63.17, clause 6.1.6.2.

Test Results: Complies

Measurement Data:

See plots.

Requirements, FCC 15.323(d):

$f \leq 1.25\text{MHz}$ outside UPCS band : $\leq -9.5\text{dBm}$
 $1.25\text{MHz} \leq f \leq 2.5\text{MHz}$ outside UPCS band : $\leq -29.5\text{ dBm}$
 $f \geq 2.5\text{MHz}$ outside UPCS band : $\leq -39.5\text{ dBm}$

Out-of-Band Emissions, Conducted

Lower Channel:

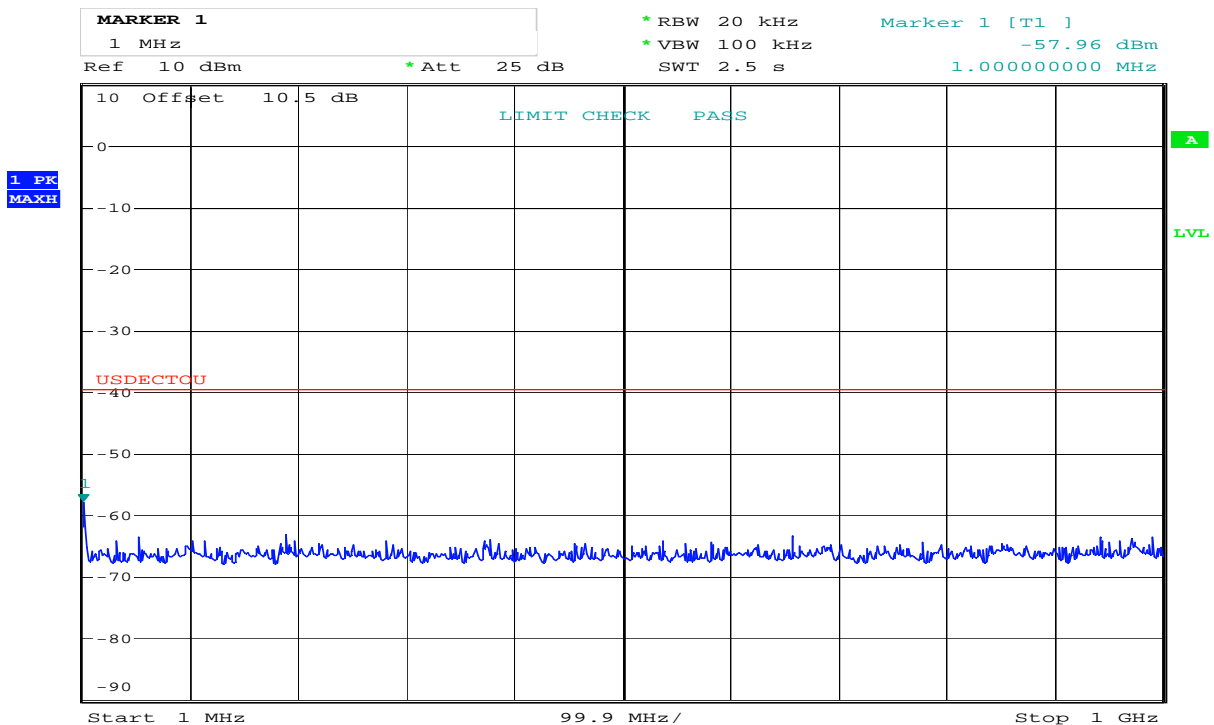

Date: 19.APR.2012 12:18:51

Out-of-Band Emissions, Conducted

Lower Channel:

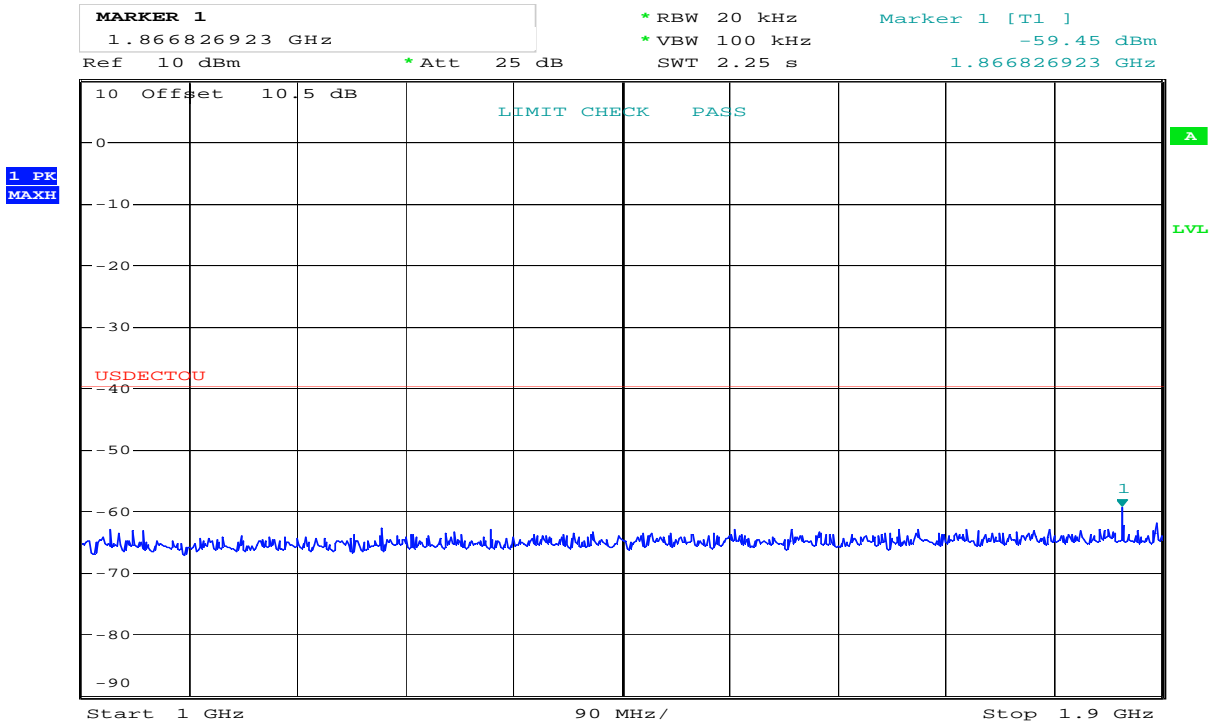

Date: 19.APR.2012 12:18:19

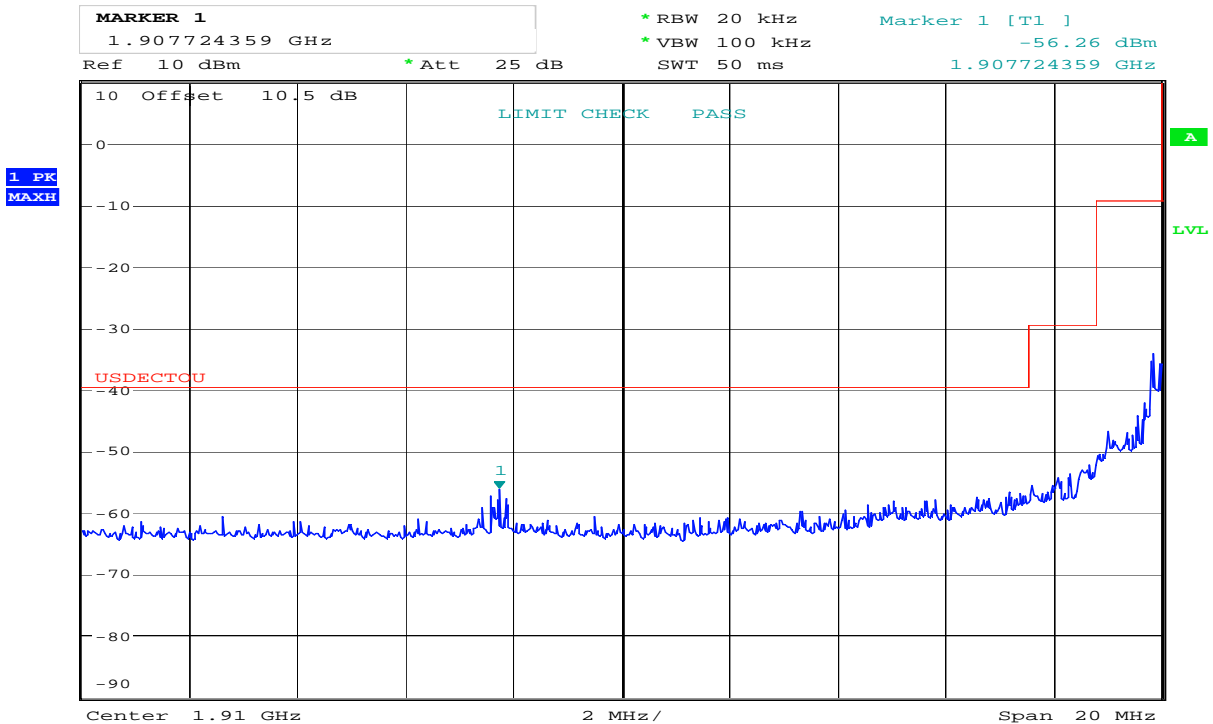

Date: 19.APR.2012 12:17:30

Out-of-Band Emissions, Conducted

Upper Channel:

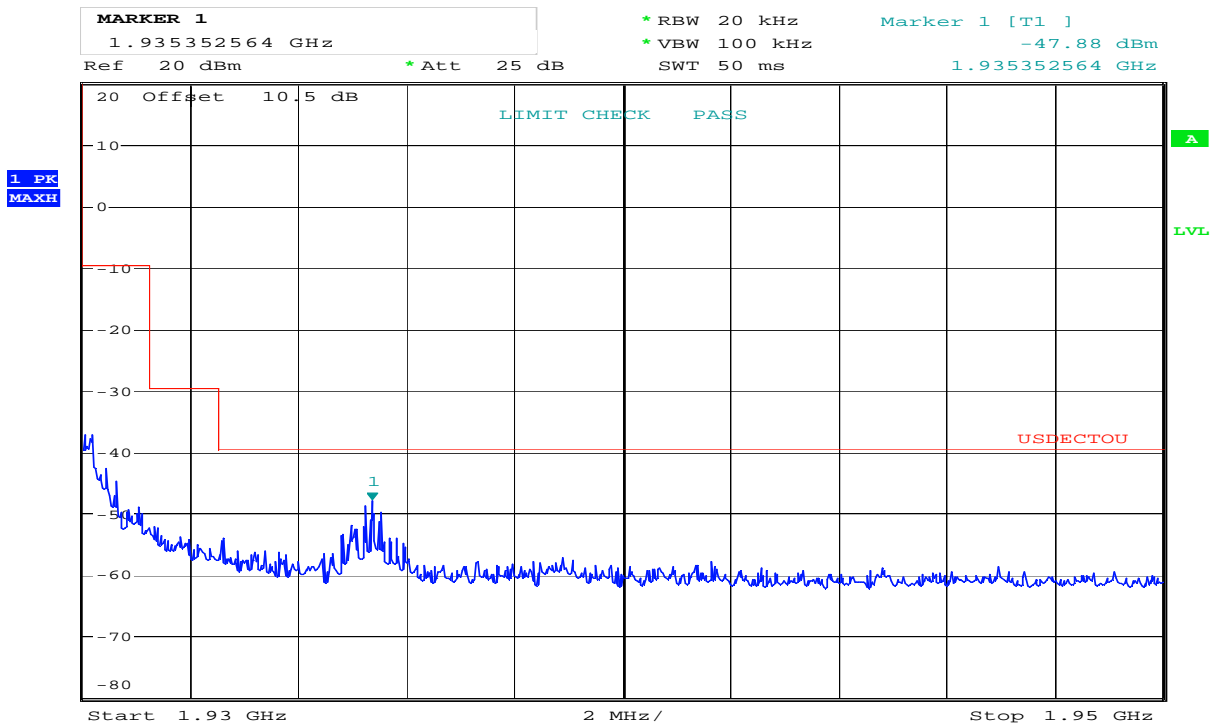

Date: 19.APR.2012 12:20:43

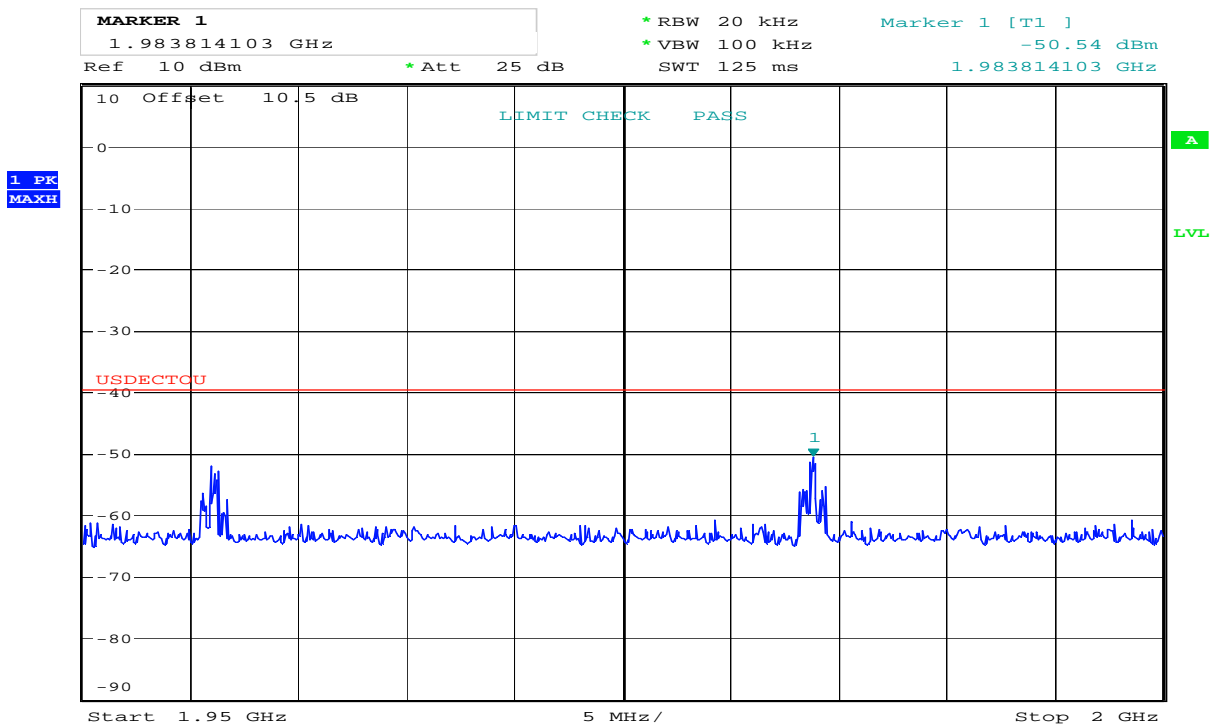

Date: 19.APR.2012 12:22:36

Out-of-Band Emissions, Conducted

Upper Channel:

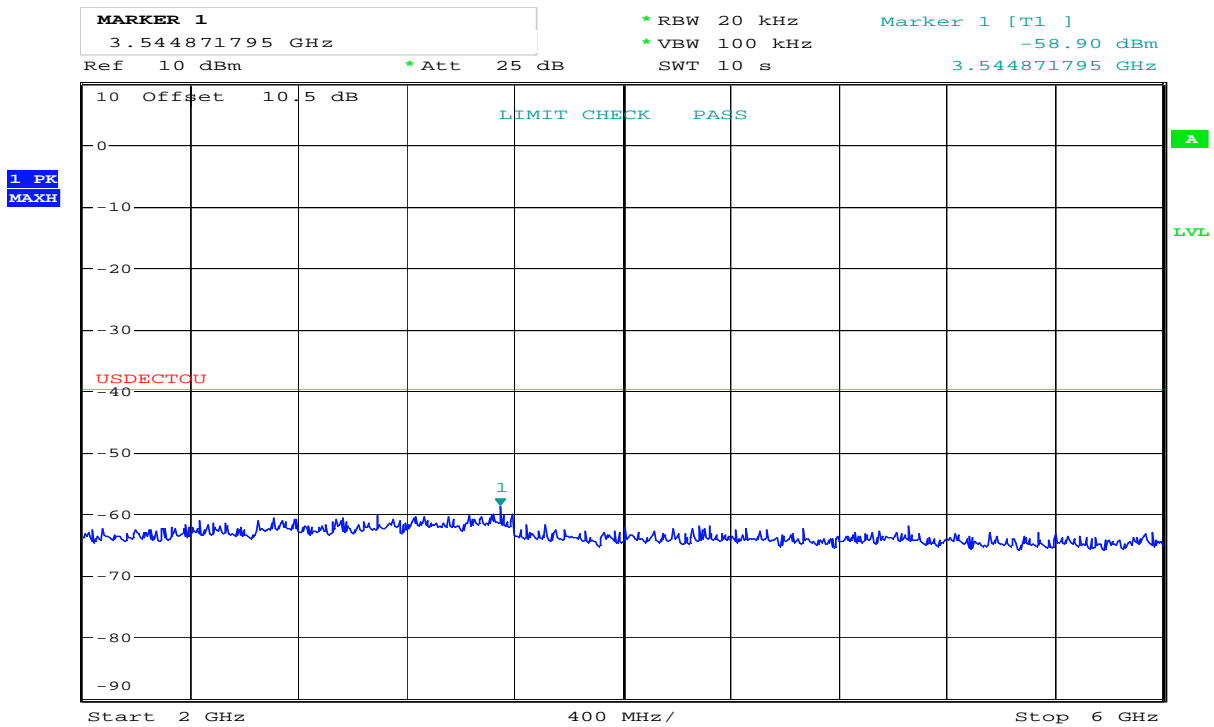

Date: 19.APR.2012 12:23:19

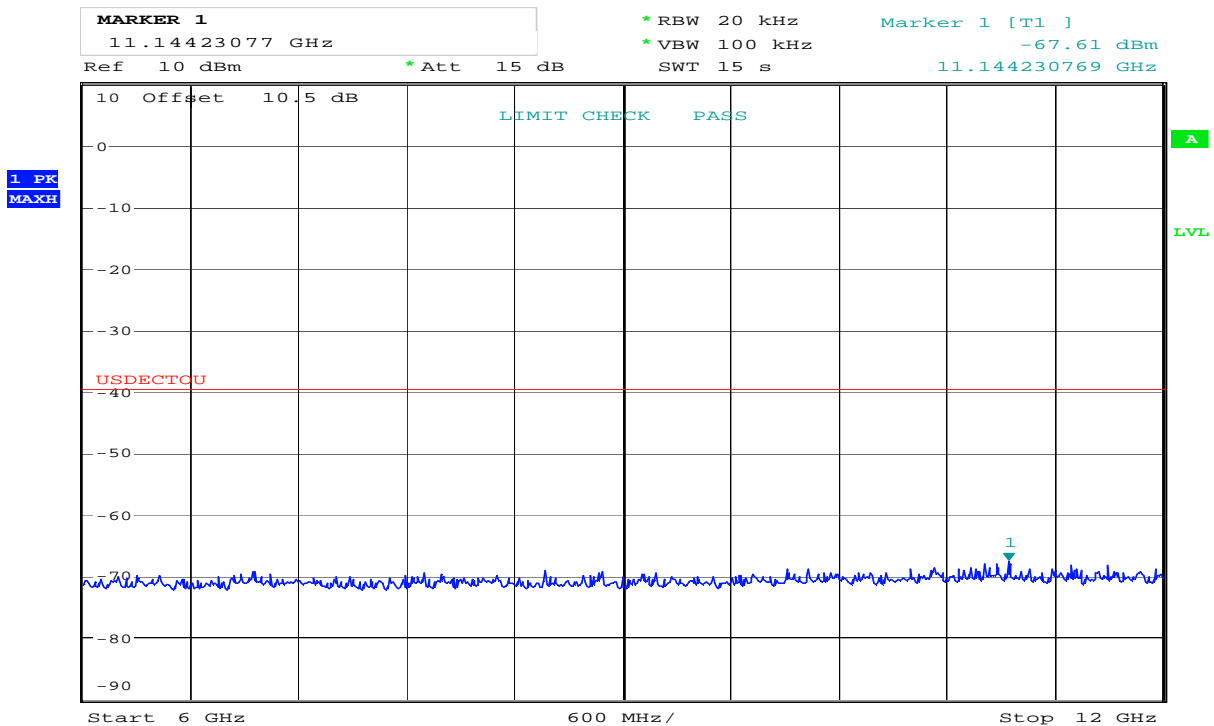

Date: 19.APR.2012 12:24:30

Out-of-Band Emissions, Conducted

Upper Channel:

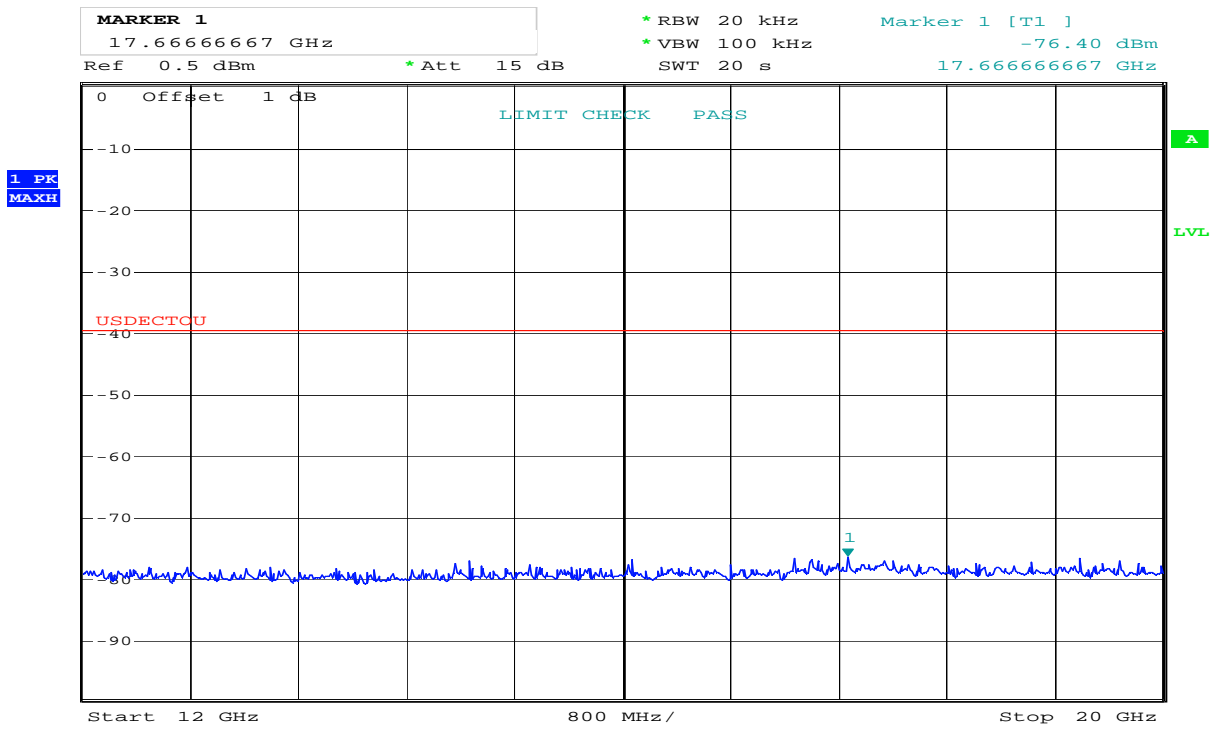

Date: 19.APR.2012 12:27:04

4.13 Carrier Frequency Stability

Test Method:

ANSI C63.17, clause 6.2.1.

Test Results: Complies

Measurement Data:

The Frequency Stability is measured with the CMD60. The CMD60 was logged by a computer programmed to get new readings as fast as possible (about 3 readings per second) over the noted time period or number of readings. The peak-to-peak difference was recorded and the mean value and deviation in ppm was calculated.

The Carrier Frequency Stability over Power Supply Voltage and over Temperature is measured with a Frequency Domain Analyzer in histogram mode.

Carrier Frequency Stability over Time at Nominal Temperature

Average Mean Carrier Frequency (MHz)	Min Diff. (kHz)	Mean Diff. (kHz)	Max. Dev. (ppm)	Limit
1924.99885	4.77	6.85	0.7	±10 ppm

Deviation ppm = ((Diff. - Mean Diff) / Mean Carrier Freq.) x 10⁶

Deviation (ppm) is calculated from 3000 readings.

Frequency Stability over Power Supply Voltage at Nominal Temperature

Voltage	Measured Carrier Frequency (MHz)	Difference (kHz)	Deviation (ppm)	Limit
V _{nom}	/	0	0	±10 ppm
85% of V _{nom}	/	/	/	
115% of V _{nom}	/	/	/	

Deviation ppm = ((Mean – Measured Frequency) / Mean) x 10⁶

This test does not apply for EUT that is powered from batteries.

Frequency Stability over Temperature

Temperature	Measured Carrier Frequency (MHz)	Difference (kHz)	Deviation (ppm)	Limit
T = +20 °C	1924.975727	0	0	±10 ppm
T = -20 °C	1924.976275	0.5	0.3	
T = +50 °C	1924.975671	-0.1	0.0	

Deviation ppm = ((Mean – Measured Frequency) / Mean) x 10⁶

4.14 Frame Repetition Stability

Test Method:

ANSI C63.17, clause 6.2.2.

Test Results: Complies

Measurement Data:

The envelope of the RF signal from the EUT is detected with a Crystal Detector and the mean and standard deviation of the frame repetition frequency is then gated over 100 frames and measured with a Frequency Domain Analyzer. The frame repetition stability is 3 times the standard deviation.

Carrier Frequency (MHz)	Mean (Hz)	Standard Deviation (Hz)	Frame Repetition Stability (ppm)
1924.992	100.000	0.000002	0.068

Limit:

Frame Repetition Stability	±10 ppm (TDMA)
----------------------------	----------------

Ref. FCC 15.323(e), ANSI C63.17, clause 6.2.2

4.15 Frame Period and Jitter

Test Method:

ANSI C63.17, clause 6.2.3.

Test Results: Complies

Measurement Data:

Carrier Frequency (MHz)	Frame Period (ms)	Max Jitter (µs)	3xStandard Deviation of Jitter (µs)
1924.992	10.000	-0.094	-0.065

Max Jitter = (1/ (Frame period + Pk-Pk/2)) - (1/Frame Period), when Pk-Pk and Frame Period are in Hz

3xSt.Dev.Jitter = 3x (1/(Frame Period + St.Dev) – 1/St.Dev) x 10⁶

Limit:

Frame Period	20 or 10 ms
Max Jitter	25 µs
3 times St.Dev of Jitter	12.5 µs

Ref. FCC 15.323(e), ANSI C63.17, clause 6.2.3

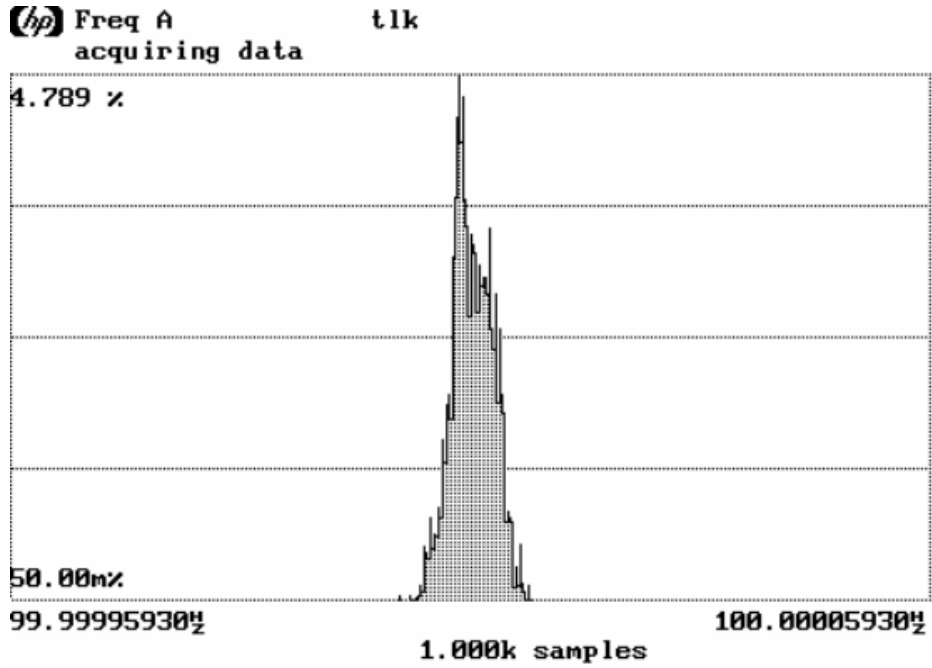

Mean 100.0000094935 MHz 1/Mean 10.000ms
 Pk-Pk 14.48 μV Std Dev 2.2653 μV

Frame Repetition Stability, Gated over 100 Frames

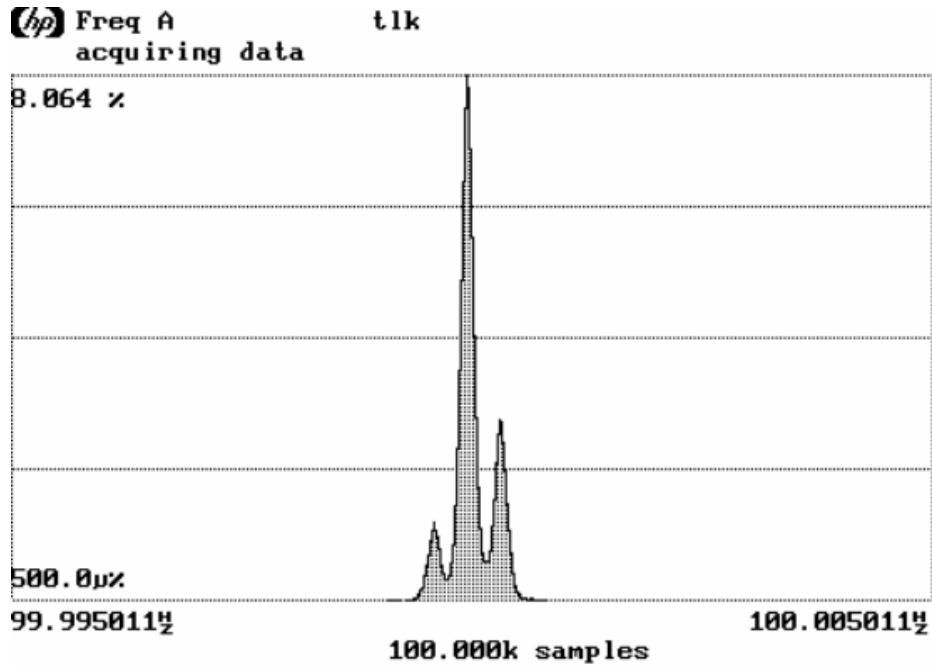

Mean 100.000010128 MHz 1/Mean 10.000ms
 Pk-Pk 1.871mV Std Dev 216.212 μV

Frame Period and Jitter

4.16 Monitoring Threshold, Least Interfered Channel

Monitoring Threshold Limits:

Lower Threshold:

$$T_L = 15 \log B - 184 + 30 - P_{EUT} \quad (\text{dBm})$$

Upper Threshold:

$$T_U = 15 \log B - 184 + 50 - P_{EUT} \quad (\text{dBm})$$

B is measured Emission Bandwidth in Hz
 P_{EUT} is measured Transmitter Power in dBm

Calculated values:

	FCC 15.323	RSS-213, Issue 2
Lower Threshold	-79.0 dBm	-80.6 dBm
Upper Threshold	-59.0 dBm	-60.6 dBm

The Lower Threshold is applicable for systems which have defined less than 40 duplex system access channels. The Upper Threshold is applicable for systems with more than 40 duplex system access channels and that implements the Least Interfered Channel Procedure (LIC).

Measurement Procedure:

The Upper or Lower Threshold is found by the procedure defined in ANSI C63.17 clause 7.3.1 or 7.3.2.

Least Interfered Channel Procedure NOT used:	
Measured Lower Threshold	N/A dBm
Least Interfered Channel Procedure:	
Measured Upper Threshold	-63.6 dBm

Least Interfered Channel (LIC) Procedure Test, FCC 15.323(b), (c)(2) and (c)(5)

ANSI C63.17 clause 7.3.3 ref.	Observation	Verdict
b) $f_1 T_L + 13$ dB, f_2 at $T_L + 6$ dB	Transmission always on f_2	Pass
c) $f_1 T_L + 6$ dB, f_2 at $T_L + 13$ dB	Transmission always on f_1	Pass
d) $f_1 T_L + 7$ dB, f_2 at T_L	Transmission always on f_2	Pass
e) $f_1 T_L$, f_2 at $T_L + 7$ dB	Transmission always on f_1	Pass

Selected Channel Confirmation, FCC 15.323(c)(1) and (5)

ANSI C63.17 clause 7.3.4	Observation	Verdict
b) Shall not transmit on f_1	EUT transmits on f_2	Pass
d) Shall not transmit on f_2	EUT transmits on f_1	Pass

Limits:

	FCC 15.323	RSS-213, Issue 2
Lower Threshold + 6 dB margin	-73.0 dBm	-74.6 dBm
Upper Threshold + 6 dB margin	-53.0 dBm	-54.6 dBm

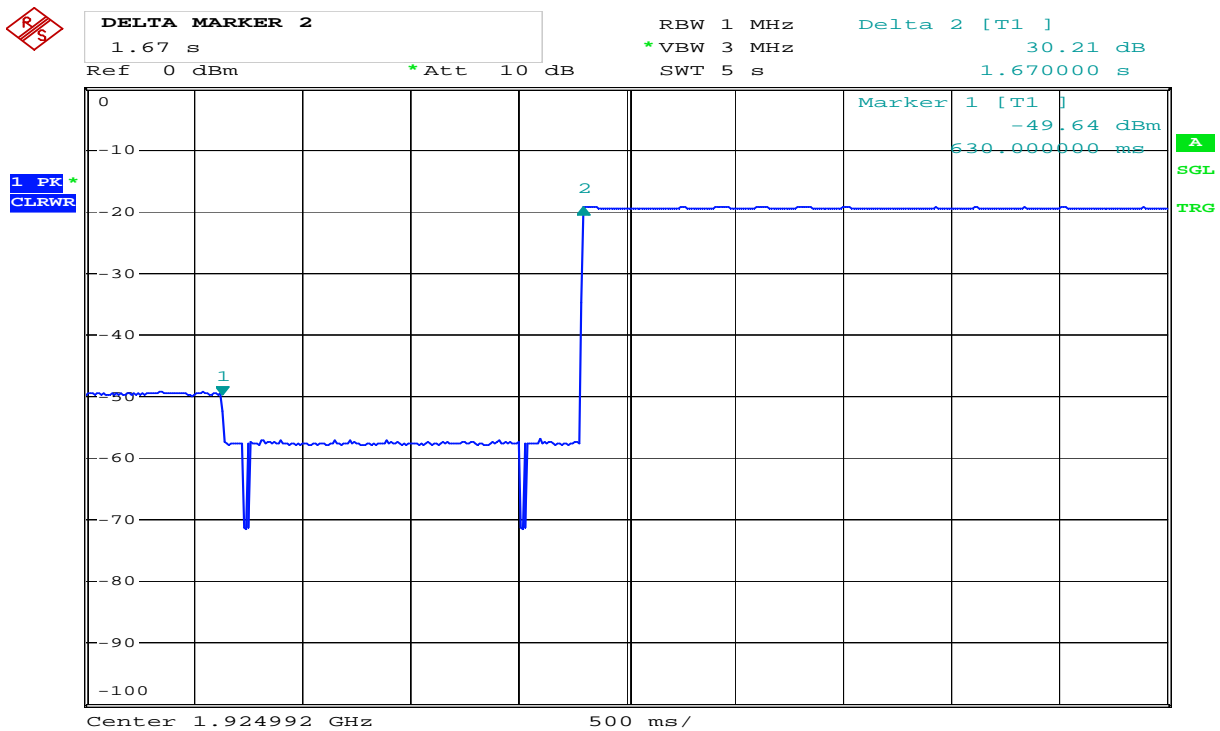

Date: 9.MAY.2012 10:28:48

7.3.4 Selected Channel Confirmation, Connection 1.67s After Interferer Removed

4.17 Threshold Monitoring Bandwidth

This test is only required if a dedicated monitoring receiver is used. However, if the test is not carried out the manufacturer shall declare and provide proper evidence that the monitoring is made through the radio receiver used for communication.

Measurement Procedure:

Simple Compliance Test, ANSI C63.17, clause 7.4.1

More Detailed Test, ANSI C63.17, clause 7.4.2

The test is passed if **either** the Simple Compliance Test or the More Detailed test is passed.

During this test the spectrum analyzer is observed visually to see if the EUT transmits or not.

Test Results:

Test performed	Observation	Verdict
Simple Compliance test, at $\pm 30\%$ of B	No transmissions	Pass
More Detailed Test, at -6 dB points	N/A	N/A
More Detailed Test, at -12 dB points	N/A	N/A

The more detailed test must be pass at both the -6 and -12 dB points if the Simple Compliance test fails.

Comment: The Simple Compliance Test was performed with the level at $T_U + U_M + 10$ dB to check that the EUT did not transmit at all.

The tested EUT uses the same receiver for monitoring and communication, this test is therefore not required. However the test has been performed nonetheless and the test is passed.

Limits, FCC 15.323(c)(7):

The monitoring system bandwidth must be equal to or greater than the emission bandwidth of the intended transmission.

4.18 Reaction Time and Monitoring Interval

Measurement Procedure

ANSI C63.17, clause 7.5

Test results:

By administrative commands and out-of-operating region interference, the EUT is restricted to operate on a single carrier frequency.

Time-synchronized pulsed interference was then applied on the carrier at pulsed levels $T_U + U_M$ to check that the EUT does not transmit at all. The level was raised 6 dB for part d) with 35 μ s pulses.

The pulses are synchronized with the EUT timeslots and applied centered within all timeslots.

Pulse Width, ref. to ANSI C63.17 clause 7.5	Observation	Verdict
c) > largest of 50 μ s and $50 \cdot \text{SQRT}(1.25/B)$	No transmissions	Pass
d) > largest of 35 μ s and $35 \cdot \text{SQRT}(1.25/B)$, and with interference level raised 6 dB	No transmissions	Pass

Comment: Since B is larger than 1.25 MHz the test was performed with pulse lengths of 50 μ s and 35 μ s.

Limits, FCC 15.323(c)(1), (5) and (7)

The maximum reaction time must be less than $50 \cdot \text{SQRT}(1.25/\text{emission bandwidth in MHz})$ microseconds for signals at the applicable threshold level but shall not be required to be less than 50 microseconds.

If a signal is detected that is 6 dB or more above the applicable threshold level, the maximum reaction time shall be $35 \cdot \text{SQRT}(1.25/\text{emission bandwidth in MHz})$ microseconds but shall not be required to be less than 35 microseconds.



SWEEP TIME
 10 ms
 Ref 0 dBm * Att 10 dB

RBW 300 kHz
 VBW 1 MHz
 SWT 10 ms

1 PK *
 CLRWR

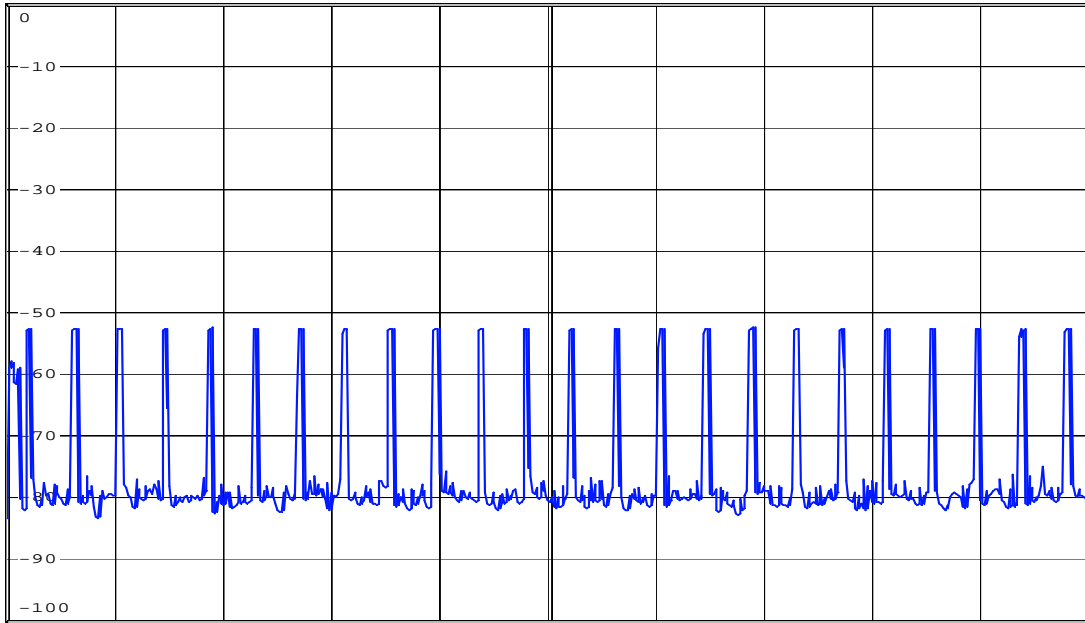

Center 1.924992 GHz 1 ms/

Date: 9.MAY.2012 10:37:20

50 μs Pulses



CENTER FREQUENCY
 1.924992 GHz
 Ref 0 dBm * Att 10 dB

RBW 300 kHz
 VBW 1 MHz
 SWT 10 ms

1 PK *
 CLRWR

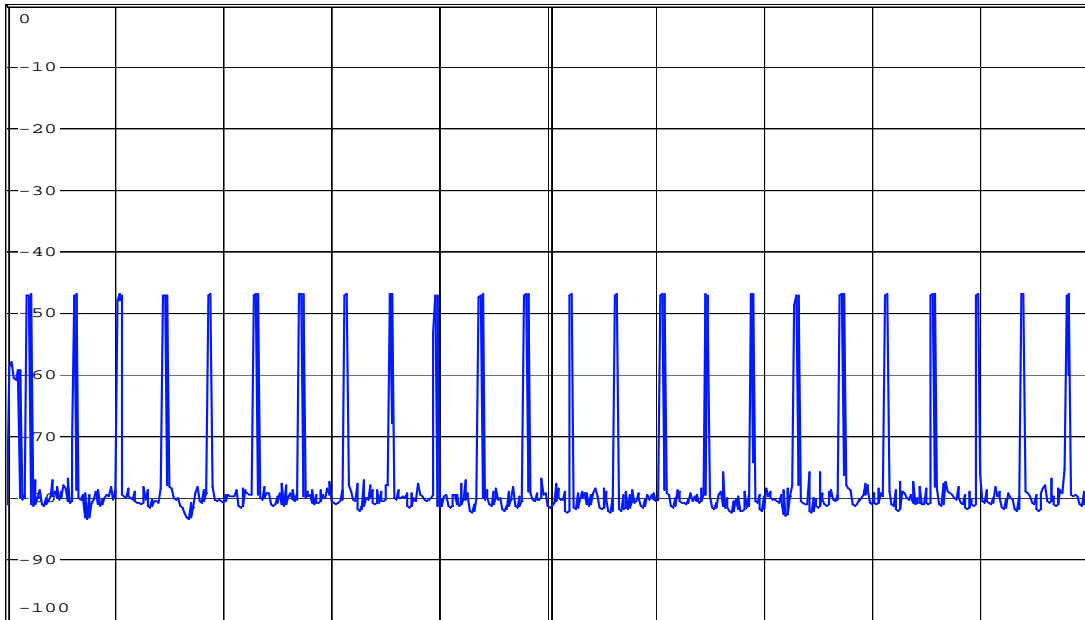

Center 1.924992 GHz 1 ms/

Date: 9.MAY.2012 10:35:39

35 μs Pulses

4.19 Time and Spectrum Window Access Procedure

This requirement is only for EUTs that transmit unacknowledged control and signaling information.

Measurement Procedure:

Timing for EUTs using control and signaling channel type transmissions: ANSI C63.17, clause 8.1

Test results:

Access Criteria, ref. to ANSI C63.17 clause 8.1.1	Observation	Verdict
b) Check that the EUT transmits on the interference free time-slot	N/A	N/A
b) The EUT must terminate or pause in its repetitive transmission of the control and signalling channel on the open channel to repeat the access criteria not less frequently than every 30 s	N/A	N/A

If FCC 15.323(c)(6) option, **If Random Waiting Interval is NOT implemented**

Access Criteria, ref. to ANSI C63.17 clause 8.1.2	Observation	Verdict
b) Check that the EUT changes to an interference-free slot when interference is introduced on the time slot in use	N/A	N/A

If FCC 15.323(c)(6) option, **Only if Random Waiting Interval is implemented**

Access Criteria, ref. to ANSI C63.17 clause 8.1.3	Observation	Verdict
b-d) Check that the EUT uses random waiting interval before continuing transmission on an interfered time slot	N/A	N/A

Comment: The tested EUT does not transmit unacknowledged control and signaling information.

Limits:

FCC 15.323(c)(4):

Once access to specific combined time and spectrum windows is obtained an acknowledgement from a system participant must be received by the initiating transmitter within one second or transmission must cease. Periodic acknowledgements must be received at least every 30 seconds or transmission must cease. Channels used exclusively for control and signaling information may transmit continuously for 30 seconds without receiving an acknowledgement, at which time the access criteria must be repeated.

FCC 15.323(c)(6):

If the selected combined time and spectrum windows are unavailable, the device may either monitor and select different windows or seek to use the same windows after waiting an amount of time, randomly chosen from a uniform random distribution between 10 and 150 milliseconds, commencing when the channel becomes available.

4.20 Acknowledgements and Transmission Duration

Measurement Procedure:

Acknowledgements: ANSI C63.17, clause 8.2.1

Transmission Duration: ANSI C63.17, clause 8.2.2

During the test **Initial transmission without acknowledgements** the signal from the EUT to the companion device is blocked by circulators in addition to the tunable attenuator.

The test **Transmission time after loss of acknowledgements** is performed by cutting-off the signal from the companion device by a RF switch and measuring the time until the EUT stops transmitting.

The **Transmission Duration** test is performed by monitoring the slot in use and measuring the time until the EUT changes to a different slot.

Test Results:

Acknowledgements

Test ref. to ANSI C63.17 clause 8.2.1	Observation	Verdict
a) Initial transmission without acknowledgements	0.4 sec	Pass
c) Transmission time after loss of acknowledgements	5.0 sec	Pass

Transmission Duration

Test ref. to ANSI C63.17 clause 8.2.2	Observation	Verdict
b) Transmission duration on same time and frequency window	1.0 hour	Pass

Comment: /

Limits, FCC 15.323(c)(3) and (4)

Occupation of the same combined time and spectrum windows by a device or group of cooperating devices continuously over a period of time longer than 8 hours is not permitted without repeating the access criteria.

Once access to specific combined time and spectrum windows is obtained an acknowledgement from a system participant must be received by the initiating transmitter within one second or transmission must cease.

Periodic acknowledgements must be received at least every 30 seconds or transmission must cease. Channels used exclusively for control and signaling information may transmit continuously for 30 seconds without receiving an acknowledgement, at which time the access criteria must be repeated.

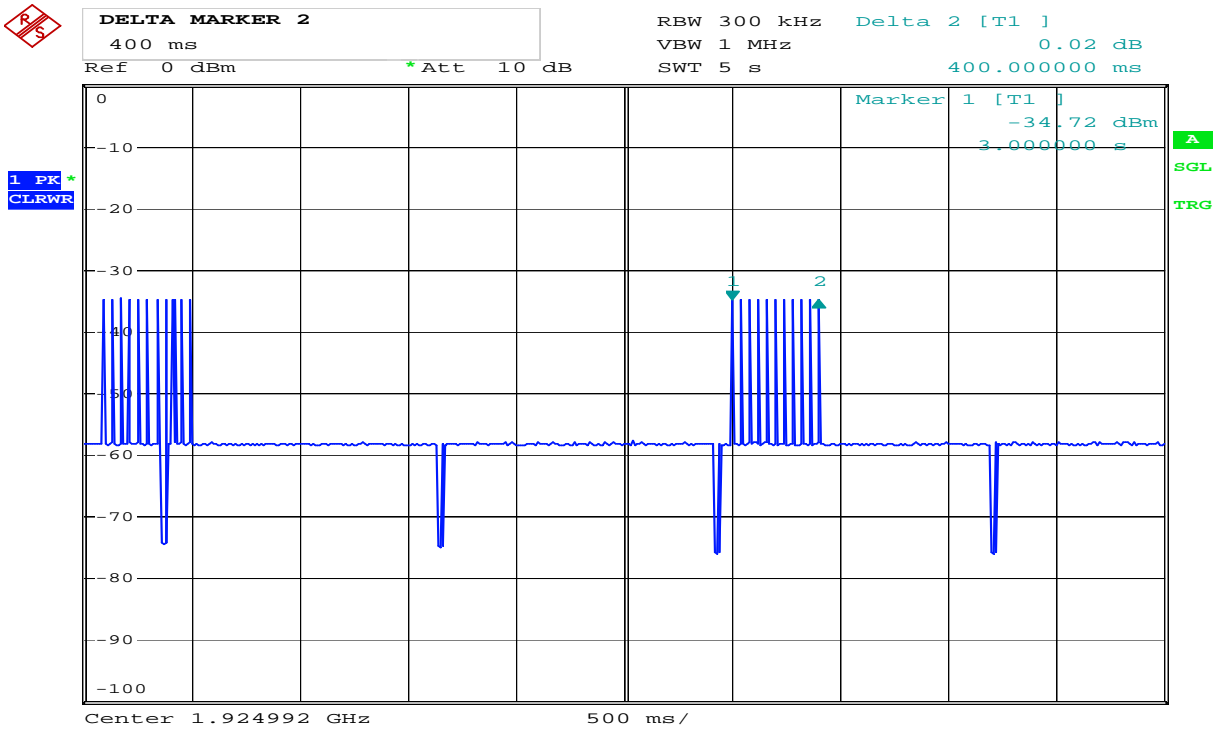

Date: 4.MAY.2012 12:22:41

8.2.1a) Initial Transmission Without Acknowledgements

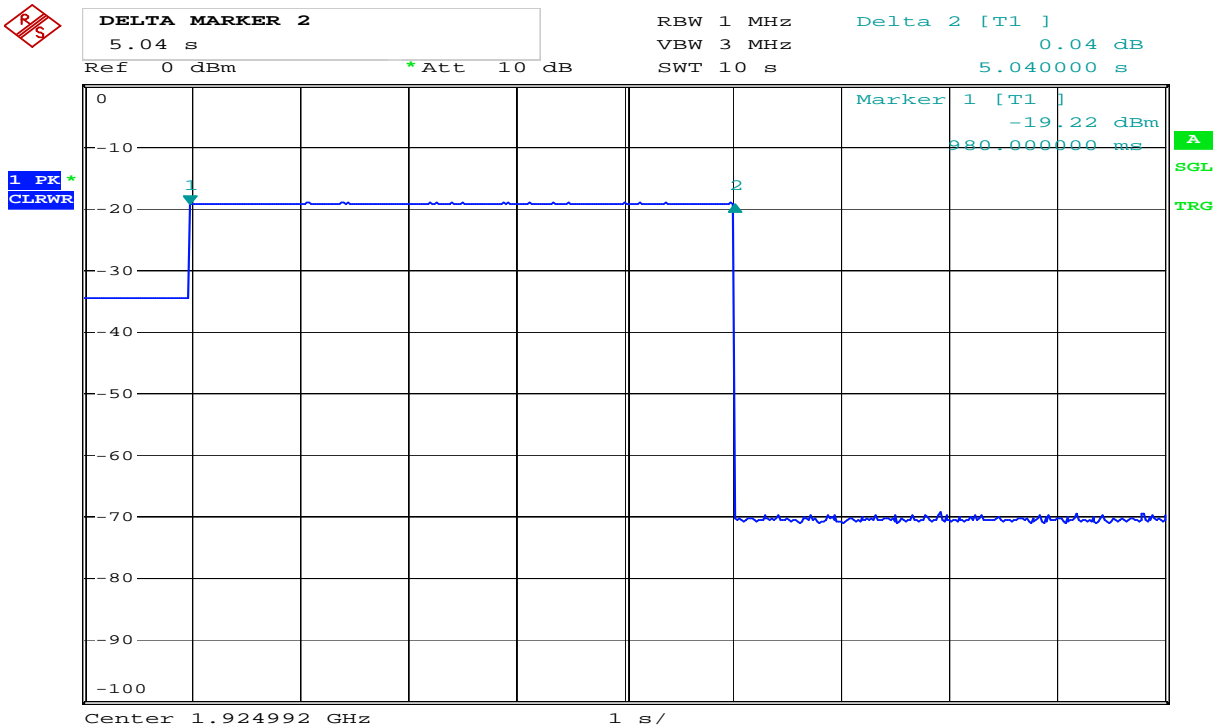

Date: 9.MAY.2012 11:01:07

8.2.1c) Transmission Time After Loss of Acknowledgements

4.21 Dual Access Criteria Check

Measurement Procedure:

EUTs that does not implement the Upper Threshold: ANSI C63.17, clause 8.3.1

EUTs that implement the Upper Threshold: ANSI C63.17, clause 8.3.2

This test is required for equipment that uses the access criteria in FCC 15.323(c)(10).

Test Results:

EUTs that do NOT Implement the Upper Threshold:

Test ref. to ANSI C63.17 clause 8.3.1	Observation	Verdict
b) EUT is restricted to a single carrier f_i for TDMA systems. The Test is Pass if EUT can transmit	N/A	N/A
c) d) No transmissions on interference-free receive time/spectrum window. All transmit slots blocked.	N/A	N/A
e) f) No transmission on interference-free transmit time/spectrum window. All receive slots blocked.	N/A	N/A

EUTs that Implements the Upper Threshold:

Test ref. to ANSI C63.17 clause 8.3.2	Observation	Verdict
b) EUT is restricted to a single carrier f_i for TDMA systems. The Test is Pass if EUT can transmit	EUT can transmit	Pass
c) d) Transmission on interference-free receive time/spectrum window	EUT transmits on interference free receive slot	Pass
e) f) Transmission on interference-free transmit time/spectrum window	EUT transmits on interference free transmit slot	Pass
g) Transmission not possible on any time/spectrum window	No connection possible	Pass

Comment: See plots.

Limits, FCC 15.323(c)(10)

An initiating device may attempt to establish a duplex connection by monitoring both its intended transmit and receive time and spectrum windows. If both the intended transmit and receive time and spectrum windows meet the access criteria, then the initiating device can initiate a transmission in the intended transmit time and spectrum window. If the power detected by the responding device can be decoded as a duplex connection signal from the initiating device, then the responding device may immediately begin transmitting on the receive time and spectrum window monitored by the initiating device.

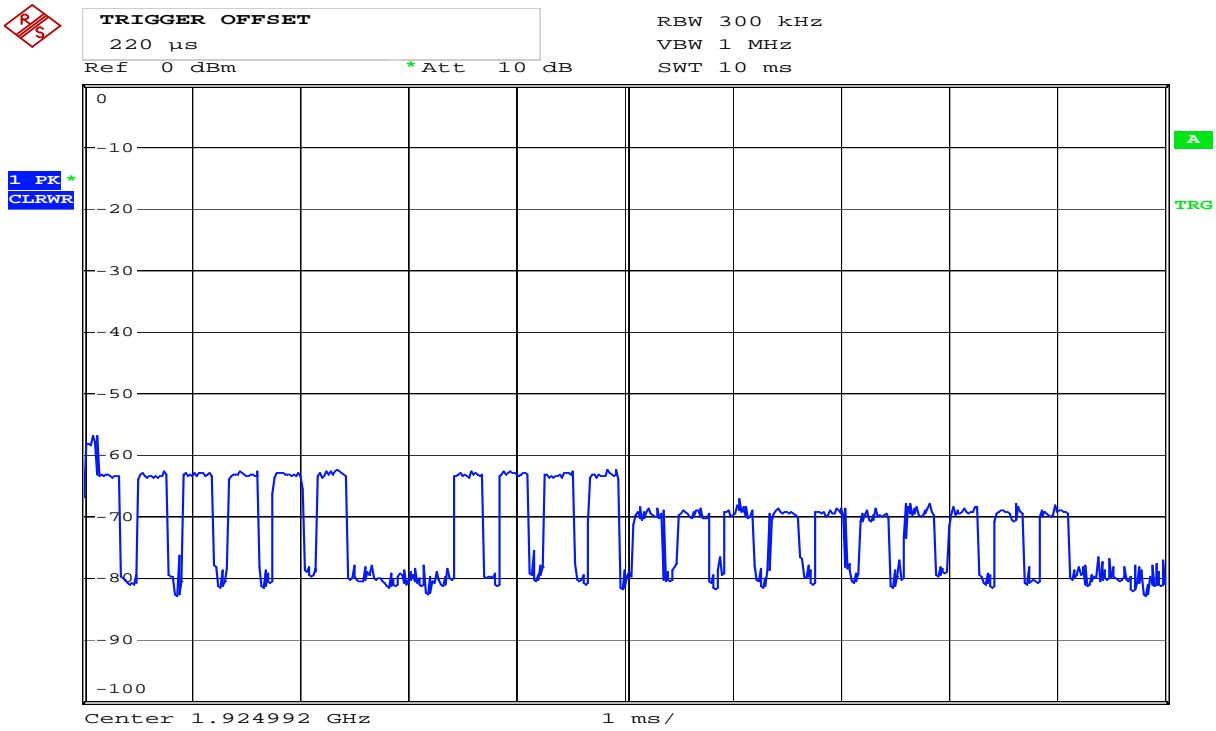

Date: 9.MAY.2012 10:50:52

8.3.2c) EUT Transmits on Interference Free RECEIVE Slot, BEFORE

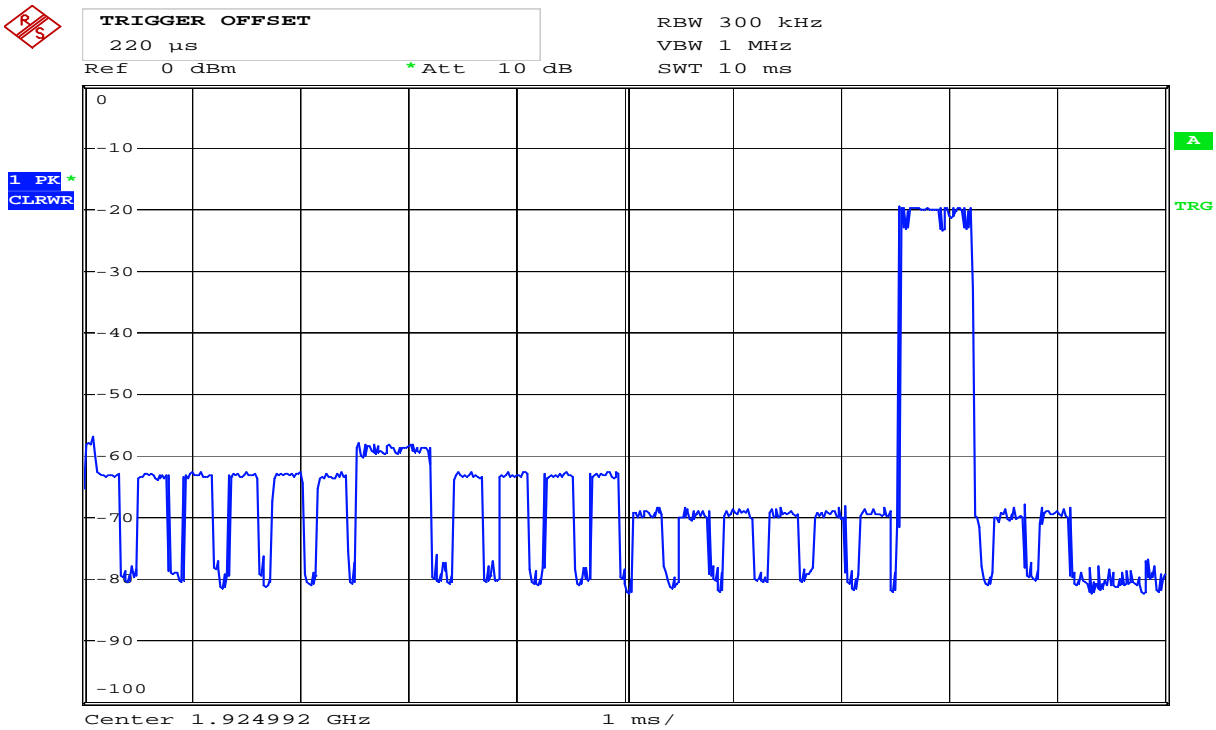

Date: 9.MAY.2012 10:51:34

8.3.2c) EUT Transmits on Interference Free RECEIVE Slot, AFTER

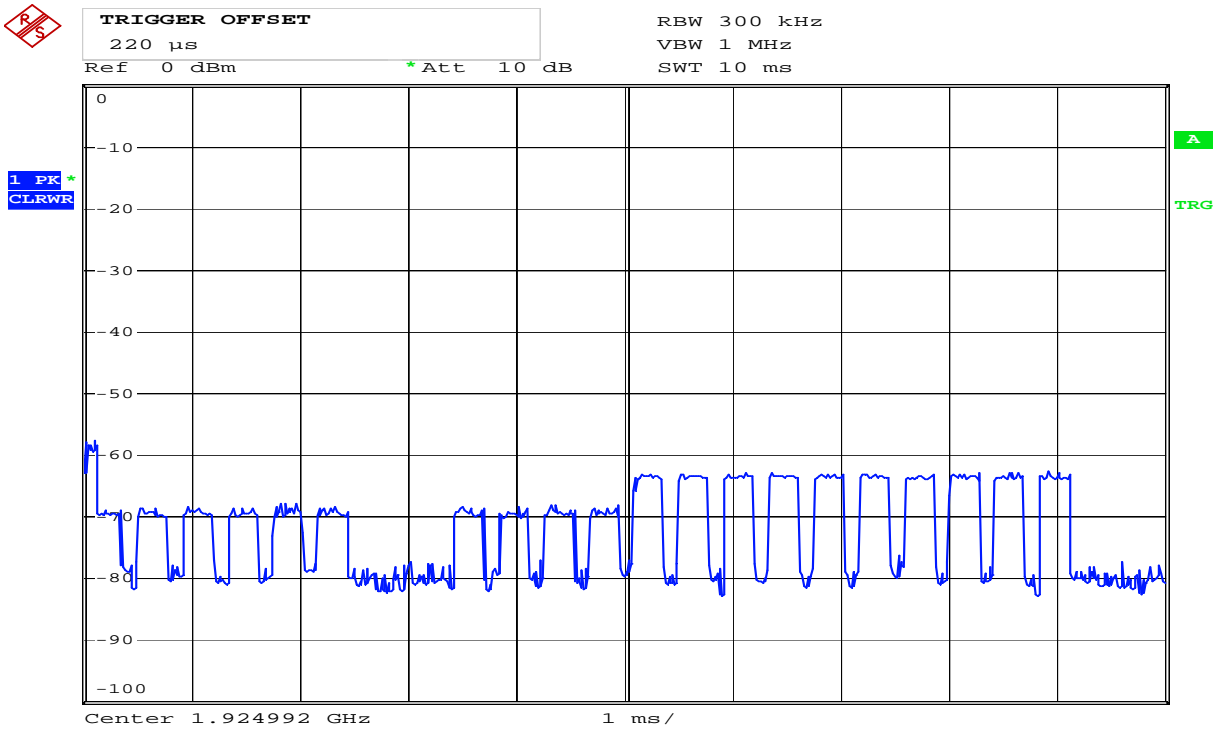

Date: 9.MAY.2012 10:52:13

8.3.2e) EUT Transmits on Interference Free TRANSMIT Slot, BEFORE

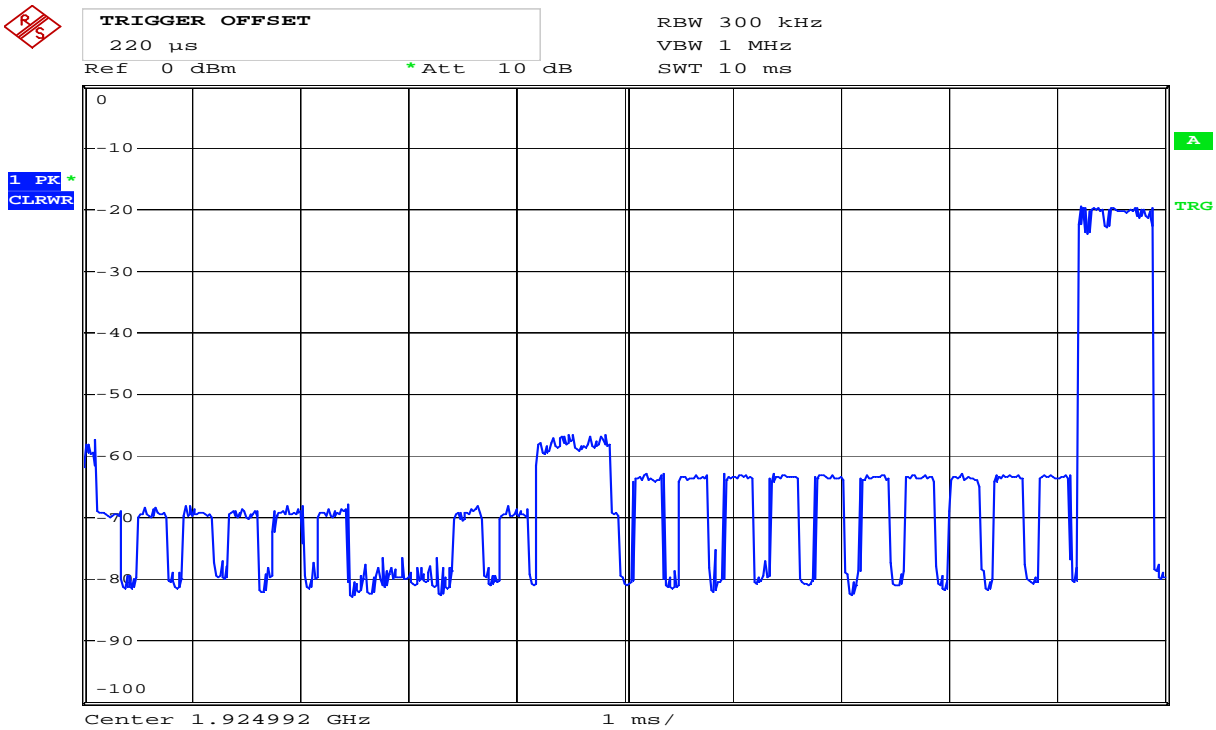

Date: 9.MAY.2012 10:52:45

8.3.2e) EUT Transmits on Interference Free TRANSMIT Slot, AFTER



TRIGGER OFFSET
220 μ s
Ref 0 dBm * Att 10 dB

RBW 300 kHz
VBW 1 MHz
SWT 10 ms

1 PK *
CLRWR

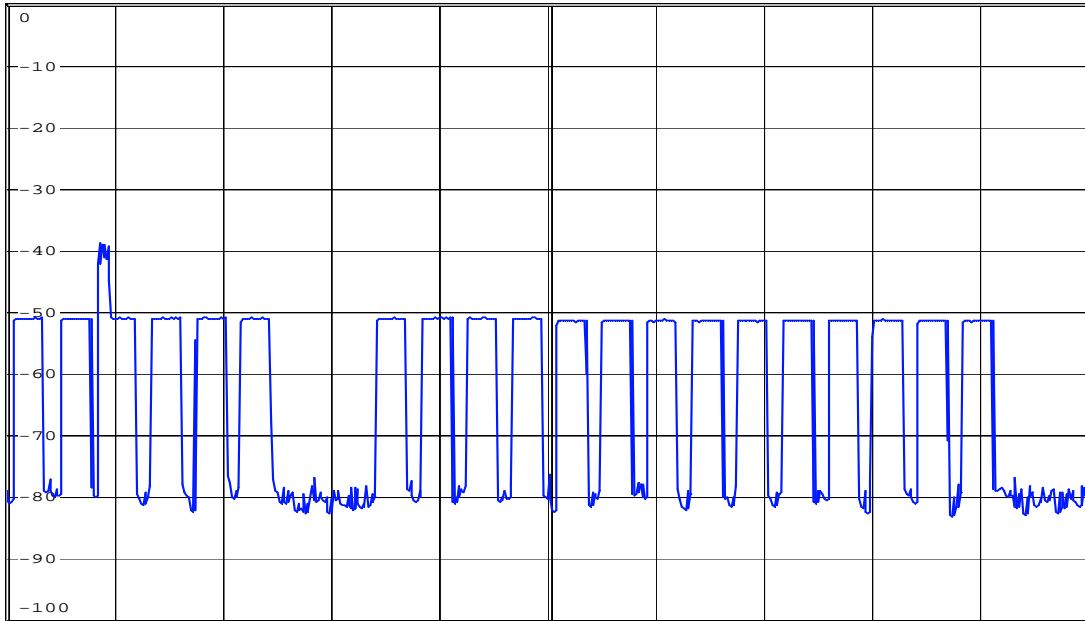

Center 1.924992 GHz 1 ms/

Date: 9.MAY.2012 10:53:31

8.3.2g) No Connection

4.22 Alternative Monitoring Interval

Test procedure described in ANSI C63.17 clause 8.4.

This test is required if the EUT implements the provisions of FCC 15.323(c)(11).

Test result:

Not Tested. The tested EUT does not implement this provision. See manufacturers' declaration.

5 Test Setups

5.1 Frequency Measurements



Test equipment included: 5, 9, 28

Test Set-up 1

This setup is used for measuring Carrier frequency stability at normal and extreme temperatures.

The EUT was in loopback-mode and was controlled with the CMD60 for this test. The modulation pattern was set to 01010101...

5.2 Timing Measurements

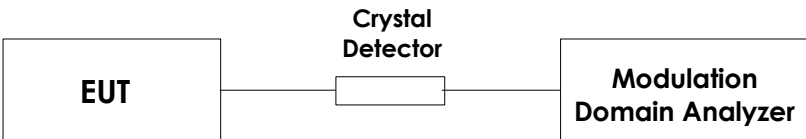

Test equipment included: 5, 7, 9, 28

Test Set-up 2

This setup is used for measuring Frame repetition stability, Frame period and Jitter.

The EUT was in loopback-mode and was controlled with the CMD60 for this test. The modulation pattern was set to 01010101...

5.3 Conducted Emission Test

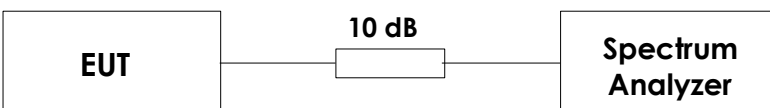

Test equipment included: 1, 2, 9, 26

Test Set-up 3

This setup is used for all conducted emission tests.

The EUT was in loopback-mode and was controlled with the CMD60 for this test. The modulation pattern was set to Pseudo-Random bit sequence to simulate normal speech.

5.4 Power Line Conducted Emissions Test

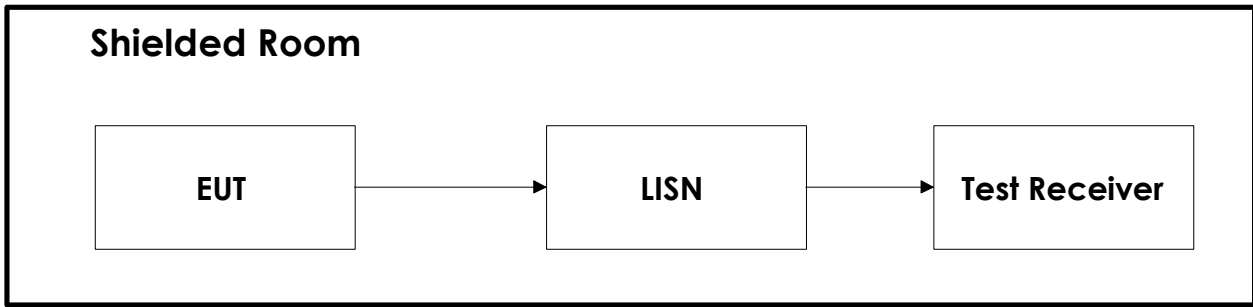

Test equipment: 8, 17, 18, 22, 27

Test Set-Up 5

5.5 Monitoring Tests

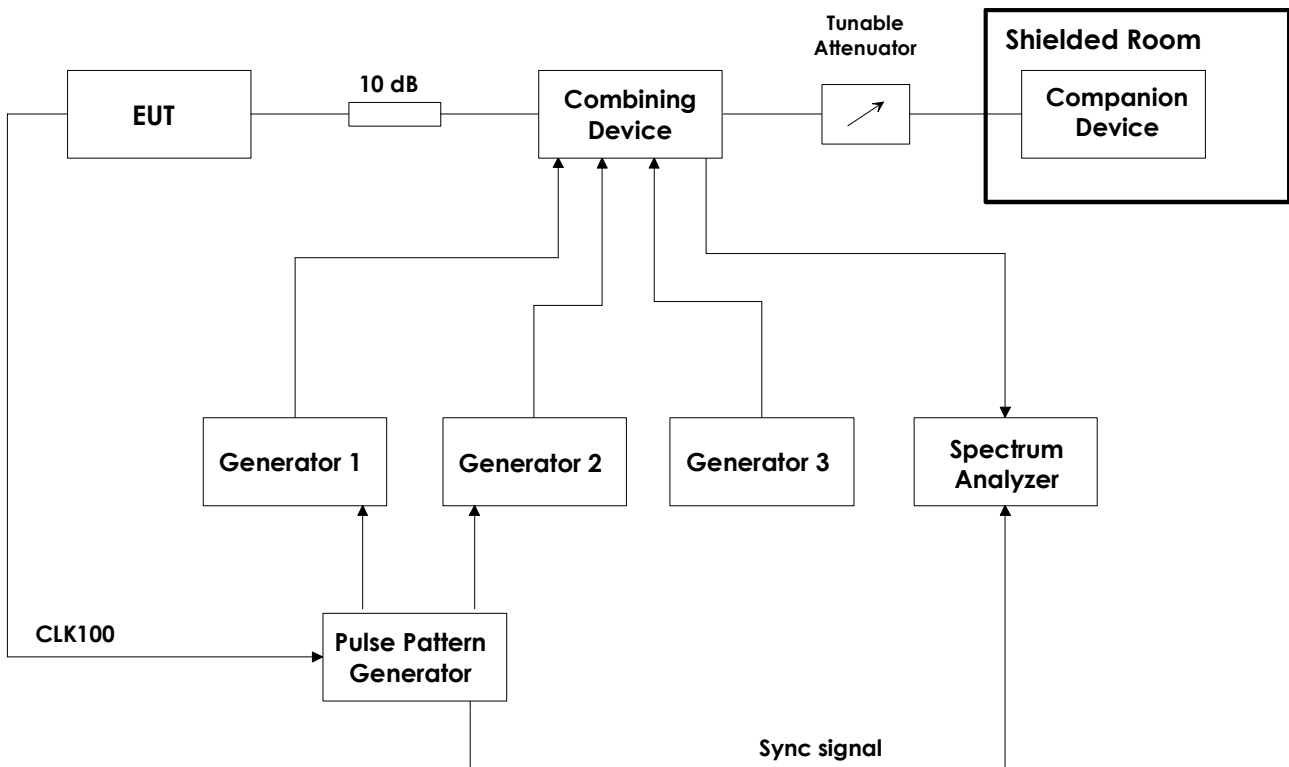

Test equipment: 1, 2, 3, 4, 6, 9, 10, 11, 12, 13, 14, 15, 19, 23, 24, 25, 26

Test Set-Up 6

This test setup is used for all Monitoring and Time and Spectrum Access Procedure tests. The path loss from the signal generators to the EUT is measured with a power meter before the testing is started.

The CLK100 is used to synchronize the Pulse-/ Pattern generator to the start of the DECT frame, this signal always comes from the base station. If the EUT is a DECT Portable Part (i.e. a handset) the CLK100 signal will come from the Companion Device.

The sync signal to the Spectrum Analyzer is the CLK100 signal that is regenerated in the Pulse-/ Pattern Generator, this is used to synchronize the Spectrum Analyzer to the DECT frame when in zero span. The Pulse-/ Pattern Generator is used for tests that require time synchronized pulses or blocking of specific time slots.

5.6 Radiated Emissions Test, Fully Anechoic Chamber

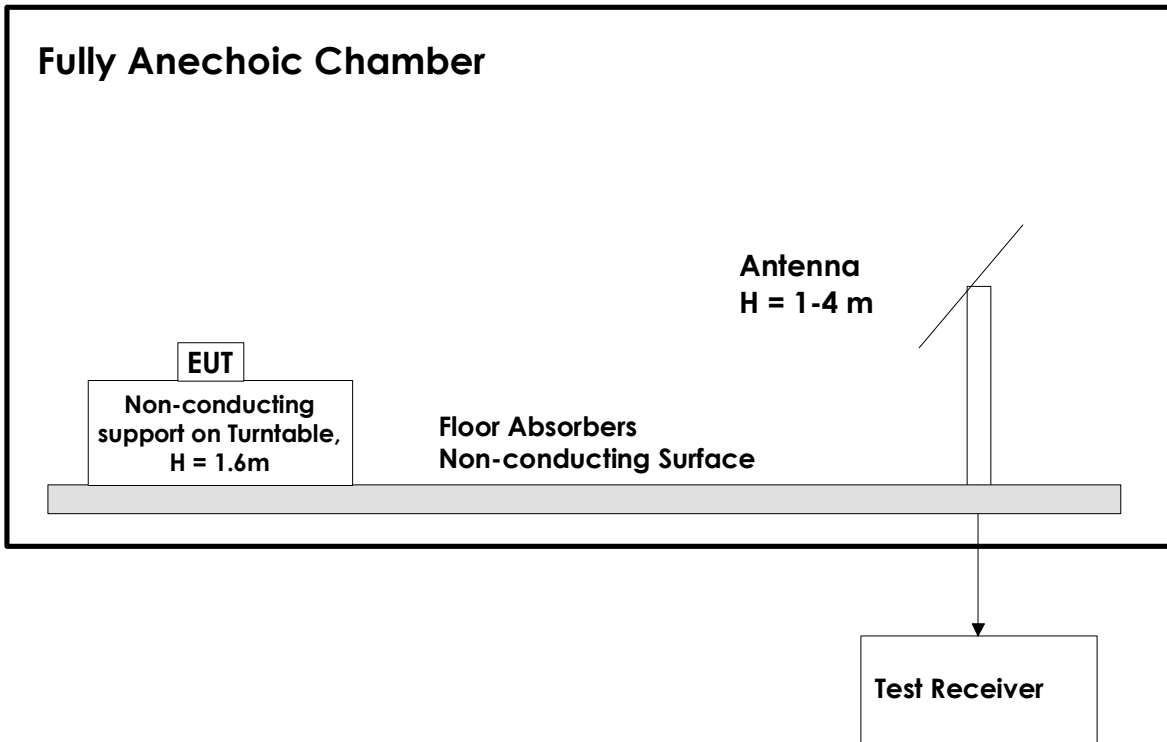

Test equipment: 9, 16, 19, 20, 21, 29, 30

Test Set-Up 7

This test setup is used for measuring radiated output power. The measurements are performed in a 3m Fully Anechoic Chamber with a Spectrum Analyzer and Horn Antenna, a preamplifier may be used after the antenna. The measuring distance is 3m.

6 Test Equipment Used

To facilitate inclusion on each page of the test equipment used for related tests, each item of test equipment and ancillaries are identified (numbered) by the Testhouse.

No.	Model number	Description	Manufacturer	Ref. no.	Cal. date	Cal. Due
1	FSU26	Spectrum Analyzer	Rohde & Schwarz	LR 1504	2011.11.03	2013.11.03
2	SME03	Signal generator	Rohde & Schwarz	LR 1238	2011.04.11	2013.04.11
3	SMIQ03B	Signal generator	Rohde & Schwarz	LR 1516	Cal b4 use	
4	SMP22	Signal generator	Rohde & Schwarz	LR 1287	Cal b4 use	
5	53310A	Modulation Domain Analyzer	Hewlett Packard	LR 1483	2011.12.13	2013.12.13
6	81104A	Pulse-/ Pattern Generator	Agilent	LR 1502	2012.04.26	2013.04.26
7	8470B	Crystal Detector	Hewlett Packard	LR 1207	N/A	
8	ESHS10	Measuring Receiver	Rohde & Schwarz	N- 3528	2011.06.21	2012.06.21
9	6810.17B	Attenuator	Suhner	LR1212	2010.09.15	2012.09.15
10	745-69	Step Attenuator	Narda	LR 1442	2011.10.19	2013.10.19
11	WE 1506A	Power Splitter	Weinchel	LR 244	Cal b4 use	
12	WE 1506A	Power Splitter	Weinchel	LR 245	Cal b4 use	
13	H-9	Hybrid	Anzac	LR 86	Cal b4 use	
14	H-9	Hybrid	Anzac	LR 257	Cal b4 use	
15	S212DS	RF Switch	Narda	LR 1244	N/A	
16	3115	Double Ridged Horn Antenna	EMCO	LR 1226	N/A	
17	ESH3-Z5	Two Line V-Network	Rohde & Schwarz	LR 1076	2011.11.03	2013.11.03
18	80S	Signal Generator	Powertron	LT 502	Cal b4 use	
19	6812B	AC Power Source	Agilent	LR 1515	Cal b4 use	
20	FSP30	Spectrum Analyzer	Rohde & Schwarz	LR 1551	2011.04.04	2013.04.04
21	JS4	Pre-Amplifier	Miteq	LR 1552	2011.09.28	2012.09.28
22	Model 87 V	Multimeter	Fluke	LR 1600	2010.12.15	2012.12.15
23	87H35-1	Circulator	Racal-MESL	s.no.: 140	N/A	
24	87H35-1	Circulator	Racal-MESL	s.no.: 141	N/A	
25	87H35-1	Circulator	Racal-MESL	s.no.: 142	N/A	
26	U2000A	USB Power Sensor	Agilent	LR 1523	2011.03.26	2013.03.26
27	ESH3-Z2	Pulse Limiter	Rohde & Schwarz	LR 285	2010.10.08	2013.10.08
28	CMD60	DECT Tester	Rohde & Schwarz	LR 1335	2010.06.09	2012.06.09
29	Model 7200	Signal generator	Gigatronics	LR 1188	2010.11.02	2012.11.02
30	3115	Double Ridged Horn Antenna	EMCO	LR 1330	2010.08.05	2013.08.05