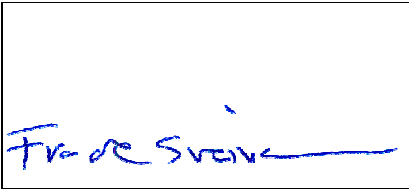
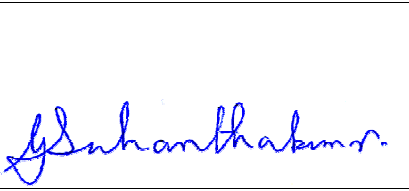

Test Report

Product	DECT Handset	
Name and address of the applicant	Panasonic Corporation of North America	
Name and address of the manufacturer	Panasonic System Networks Co., Ltd. 1-62, 4-chome, Minoshima, Hakata-ku Fukuoka 812-8531, Japan	
Model	KX-TGFA51 KX-TGFA59	
Rating	2.4V DC (Secondary Batteries, 2xAAA NiMH cells)	
Trademark	Panasonic	
Serial number	/	
Additional information	DECT 6.0	
Tested according to	FCC Part 15, subpart D Isochronous UPCS Device, 1920 – 1930 MHz Industry Canada RSS 213, Issue 3 2 GHz License-Exempt Personal Communications Services (LE-PCS) Devices	
Order number	319568	
Tested in period	2016.11.08 to 2016.11.11	
Issue date	2016.11.15	
Name and address of the testing laboratory	 Instituttveien 6 Kjeller, Norway	FCC No: 994405 IC OATS: 2040D-1 TEL: +47 22 96 03 30 FAX: +47 22 96 05 50
		
	Prepared by [Frode Sveinsen]	Approved by [G.Suhandhakumar]
This report shall not be reproduced except in full without the written approval of Nemko. Opinions and interpretations expressed within this report are not part of the current accreditation. This report was originally distributed electronically with digital signatures. For more information please contact Nemko.		

CONTENTS

1	INFORMATION	3
1.1	Tested Item.....	3
1.2	Description of Tested Device	3
1.3	Test Environment.....	4
1.4	Test Engineer(s)	4
1.5	Other Comments	4
2	TEST REPORT SUMMARY	5
2.1	General.....	5
2.2	Test Summary	6
3	TEST RESULTS.....	7
3.1	Power Line Conducted Emissions	7
3.2	Digital Modulation Techniques	8
3.3	Labeling Requirements	8
3.4	Channel Frequencies.....	8
3.5	Antenna Requirement.....	9
3.6	Automatic Discontinuation of Transmission	9
3.7	Peak Power Output.....	10
3.8	Emission Bandwidth B	13
3.9	Power Spectral Density	16
3.10	In-Band Unwanted Emissions, Conducted.....	19
3.11	Out-of-band Emissions, Conducted	21
3.12	Carrier Frequency Stability	26
3.13	Frame Repetition Stability.....	27
3.14	Frame Period and Jitter	27
3.15	Monitoring Threshold, Least Interfered Channel.....	29
3.16	Threshold Monitoring Bandwidth.....	31
3.17	Reaction Time and Monitoring Interval	32
3.18	Time and Spectrum Window Access Procedure.....	34
3.19	Acknowledgements and Transmission Duration	35
3.20	Dual Access Criteria Check	37
3.21	Alternative Monitoring Interval	40
4	MEASUREMENT UNCERTAINTY	41
5	TEST SETUPS	42
5.1	Frequency Measurements	42
5.2	Timing Measurements	42
5.3	Conducted Emission Test.....	42
5.4	Power Line Conducted Emissions Test	42
5.5	Monitoring Tests	43
6	TEST EQUIPMENT USED	44

1 INFORMATION

1.1 Tested Item

Name :	Panasonic
Model name :	KX-TGFA51 (US model) KX-TGFA59 (Canadian model)
FCC ID :	ACJ96NKX-TGFA51
Industry Canada ID :	216A-KXTGFA59
Serial number :	/
Hardware identity and/or version:	PNLB2672xx
Software identity and/or version :	SW400
Tested to IC Radio Standard (RSS) :	RSS-213 Issue 3, RSS-GEN Issue 4
Test Site IC Reg. Number :	IC 2040D-1
Frequency Range :	1921.536 – 1928.448 MHz
Number of Channels :	5 RF Channels, 5x12 = 60 TDMA Duplex Channels
Type of Modulation :	Digital (Gaussian Frequency Shift Keying)
Conducted Output Power :	70 mW (Peak)
Antenna Connector :	None
Number of Antennas :	1
Antenna Diversity Supported :	N/A
Desktop Charger :	PNLC1078 Charger with PNLV233(UC) AC Adaptor
Power Supply :	Secondary Batteries (2xAAA NiMH cells)
Interface :	None
Companion Device :	KX-TGF570

1.2 Description of Tested Device

The EUT is a DECT Handset and is an initiating device as described in ANSI C63.17 and is designed to operate together with a DECT Base Station, which is the responding device.

The US and Canadian models KX-TGFA51 and KX-TGFA59, are identical.

1.3 Test Environment

Temperature:	21.0 – 23.1 °C
Relative humidity:	22 – 40 %
Normal test voltage:	2.4 V DC (Nominal)

The values are the limit registered during the test period.

All tests were performed with fully charged batteries.

1.4 Test Engineer(s)

Frode Sveinsen

1.5 Other Comments

The Monitoring and Time and Spectrum Window Access tests were performed with Test Set-Up 6 (Ref. clause 5). A clock signal from the companion device was used to synchronize the Pulse Pattern Generator and the Spectrum Analyzer to the start of the DECT time window. The EUT was limited by administrative commands to operate on only two frequency carriers. For the tests where the EUT was required to operate on only one frequency carrier, one carrier was blocked by applying a CW interfering signal from RF Generator 3. The Pulse Pattern Generator was used to apply time synchronized interference to time windows where this was required.

Since the EUT was programmed to operate on only two RF carriers, it was only necessary with two RF generators for the monitoring tests, however a third generator was applied for the tests that required specific time slots to be blocked.

This EUT supports Least Interfered Channel procedure (LIC), the Monitoring and Time and Spectrum Window Access tests were conducted as specified for EUTs that support LIC procedure.

All tests except Power-Line Conducted Emissions were performed in conducted mode with a temporary antenna connector.

The Power-Line Conducted Emissions tests was performed with all ports populated and operating.

2 TEST REPORT SUMMARY

2.1 General

All measurements are traceable to national standards.

The tests were conducted on a sample of the equipment for the purpose of demonstrating compliance with FCC CFR47 Part 15D for Isochronous UPCS Devices and Industry Canada RSS-213 Issue 3 / RSS-GEN Issue 4 / RSP-100 Issue 11.

All tests were conducted in accordance with ANSI C63.4-2014 and ANSI C63.17-2013. Antenna Gain tests were made in a 3m fully-anechoic chamber.

A description of the test facility is on file with the FCC and Industry Canada.

New Submission

Production Unit

Class II Permissive Change

Pre-production Unit

PUE Equipment Code

Family Listing



THIS TEST REPORT APPLIES ONLY TO THE ITEM(S) AND CONFIGURATIONS TESTED.

Deviations from, additions to, or exclusions from the test specifications are described in "Summary of Test Data".

Nemko Group authorizes the above named company to reproduce this report provided it is reproduced in its entirety and for use by the company's employees only. Any reproduction of parts of this report requires approval in writing from Nemko Group.

Any use which a third party makes of this report, or any reliance on or decisions to be made based on it, are the responsibility of such third parties. Nemko Group accepts no responsibility for damages suffered by any third party as a result of decisions made or actions based on this report.

2.2 Test Summary

Name of test	FCC CFR 47 Paragraph #	IC RSS-213 Paragraph #	Verdict
Power Line Conducted Emission	15.107(a) 15.207(a)	5.4 RSS-GEN 8.8	Complies
Digital Modulation Techniques	15.319(b)	5.1	Complies
Labeling requirements	15.19(a)(3)	RSP-100 3.1	Complies
Antenna Requirement	15.317, 15.203	RSS-GEN 8.3	Complies
Channel Frequencies	15.303	5.1	Complies
Automatic discontinuation of transmission	15.319(f)	5.2 (4)	Complies
Emission Bandwidth	15.323(a)	5.5 RSS-GEN 6.6	Complies
In-band emissions	15.323(d)	5.8.2	Complies
Out-of-band emissions	15.323(d)	5.8.1	Complies
Peak Transmit Power and Antenna Gain	15.319(c)(e), 15.31(e)	5.6 RSS-GEN 8.3	Complies
Power Spectral Density	15.319(d)	5.7	Complies
Carrier frequency stability	15.323(f)	5.3	Complies
Frame repetition stability	15.323(e)	5.2 (13)	Complies
Frame period and jitter	15.323(e)	5.2 (13)	Complies
Monitoring threshold, Least interfered channel	15.323(c)(2)(5)(9)	5.2 (2)(5)(9)	Complies
Monitoring of intended transmit window and maximum reaction time	15.323(c)(1)	5.2 (1)	Complies
Threshold monitoring bandwidth	15.323(c)(7)	5.2 (7)	Complies
Reaction time and monitoring interval	15.323(c)(1)(5)(7)	5.2 (1)(5)(7)	Complies
Access criteria test interval	15.323(c)(4)(6)	5.2 (4)(6)	N/A ¹
Access Criteria functional test	15.323(c)(4)(6)	5.2 (4)(6)	N/A ¹
Acknowledgements	15.323(c)(4)	5.2 (4)	Complies
Transmission duration	15.323(c)(3)	5.2 (3)	Complies
Dual access criteria	15.323(c)(10)	5.2 (10)	Complies
Alterative monitoring interval	15.323(c)(11)(12)	5.2 (11)(12)	N/A ²
Spurious Emissions (Radiated)	15.319(g) 15.109(a) 15.209(a)	RSS-GEN 8.9	N/A ³

¹ Only applies for equipment that transmits unacknowledged control and signaling information

¹ Only applies for EUT that can be initiating device

² The client declares that the tested equipment does not implement this provision

³ Not required if the Conducted Out-of-Band Emissions test is Passed

3 TEST RESULTS

3.1 Power Line Conducted Emissions

FCC Part 15.207(a)

RSS-213 Clause 6.3, RSS-GEN Clause 8.8

Test Performed By: Tore Løvlien	Date of Test: 8-Nov-2016
---------------------------------	--------------------------

Measurement procedure: ANSI C63.4-2014 using 50 μ H/50 ohms LISN.

Test Results: Complies

Measurement Data: See attached graph, (Peak detector)
 Tested with EUT Charging in Desktop Charger

Highest measured value (L1 and N):

Frequency (MHz)	QuasiPeak (dB μ V)	Average (dB μ V)	Limit (dB μ V)	Margin (dB)	Meas. Time (ms)	Bandwidth (kHz)	Line	PE	Corr. (dB)
---	---	---	---	---	---	---			---

Full Spectrum

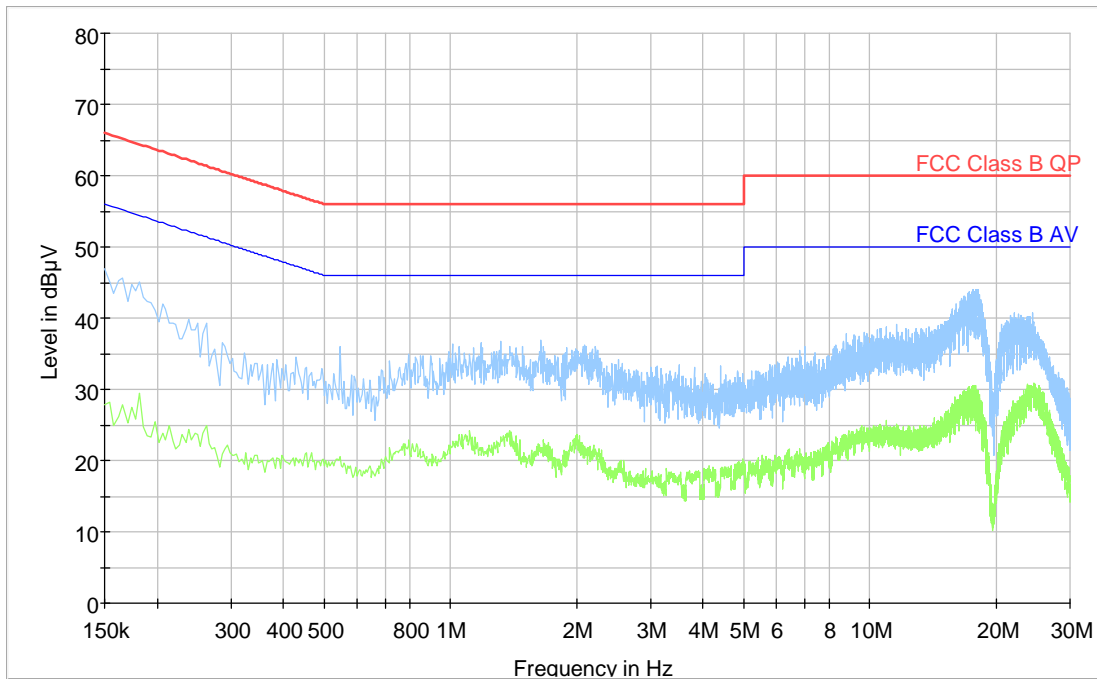

3.2 Digital Modulation Techniques

The EUT uses Multi Carrier / Time Division Multiple Access / Time Division Duplex and Digital GFSK modulation. For further details see the operational description provided by the applicant.

Requirement, FCC 15.319(b):

All transmissions must use only digital modulation techniques.

3.3 Labeling Requirements

See separate documents showing the label design and the placement of the label on the EUT.

Requirements FCC 15.19

The FCC Identifier shall be displayed on the label, and the device(s) shall bear the following statement in a conspicuous location on the device or in the user manual if the device is too small:

This device complies with Part 15 of the FCC Rules. Operation is subject to the following two conditions: (1) this device may not cause harmful interference, and (2) this device must accept any interference received, including interference that may cause undesired operation.

The label itself shall be of a permanent type, not a paper label, and shall last the lifetime of the equipment.

3.4 Channel Frequencies

UPCS CHANNEL	FREQUENCY (MHz)
Upper Band Edge	1930.000
0 (Highest)	1928.448
1	1926.720
2	1924.992
3	1923.264
4 (Lowest)	1921.536
Lower Band Edge	1920.000

Requirement: FCC 15.303

Within 1920 -1930 MHz band for isochronous devices.

3.5 Antenna Requirement

Does the EUT have detachable antenna(s)?	<input type="checkbox"/> YES	<input checked="" type="checkbox"/> NO
If detachable, is the antenna connector(s) non-standard?	<input type="checkbox"/> YES	<input type="checkbox"/> NO
The tested equipment has only integral antennas. The conducted tests were performed on a sample with a temporary antenna connector.		

Requirement: FCC 15.203, 15.204, 15.317.

3.6 Automatic Discontinuation of Transmission

Does the EUT transmit Control and Signaling Information?	<input type="checkbox"/> YES	<input checked="" type="checkbox"/> NO
TYPE OF EUT :	<input checked="" type="checkbox"/> INITIATING DEVICE	<input type="checkbox"/> RESPONDING DEVICE

The following tests simulate the reaction of the EUT in case of either absence of information to transmit or operational failure after a connection with the companion device is established.

Number	Test	EUT Reaction	Verdict
1	Power removed from EUT	C	Pass
2	Switch Off EUT	C	Pass
3	Hook-On by EUT	C	Pass
4	Power Removed from Companion Device	A	Pass
5	Switch Off Companion Device	N/A	Pass
6	Hook-On by Companion Device	N/A	Pass

- A - Connection breakdown, Cease of all transmissions
- B - Connection breakdown, EUT transmits control and signaling information
- C - Connection breakdown, Companion Device transmits control and signaling information
- N/A - Not Applicable (Companion Device does not have On/Off switch and cannot perform Hook-On)

Requirements, FCC 15.319(f)

The device shall automatically discontinue transmission in case of either absence of information to transmit or operational failure. These provisions are not intended to preclude transmission of control and signaling information or use of repetitive codes used by certain digital technologies to complete frame or burst intervals.

3.7 Peak Power Output

Test Method:

ANSI C63.17, clause 6.1.2.

Test Results: Complies

Measurement Data:

Maximum Conducted Output Power

Channel No.	Frequency (MHz)	Maximum Conducted Output Power (dBm)	Maximum Antenna Gain (dBi)	Maximum Radiated Output Power (dBm)
4	1921.536	18.2	0.0*	18.2
2	1924.992	18.2	0.0*	18.2
0	1928.448	18.5	0.0*	18.5

*Antenna Gain is value declared by manufacturer

Limit:

Conducted: $100 \mu\text{W} \times \text{SQRT}(B)$ where B is the measured Emission Bandwidth in Hz

FCC 15.319(c)(e) and RSS-213, Issue 3: 20.76 dBm (119 mW)

The antenna gain is below 3 dBi, no reduction in transmit power is necessary.

Requirements, FCC 15.319(c)(e); RSS-213, Issue 3; RSS-GEN, Issue 4

Peak transmit power shall not exceed 100 microwatts multiplied by the square root of the emission bandwidth in Hertz.

The peak transmit power shall be reduced by the amount in decibels that the maximum directional gain of the antenna exceeds 3 dBi.

Conducted Peak Output Power

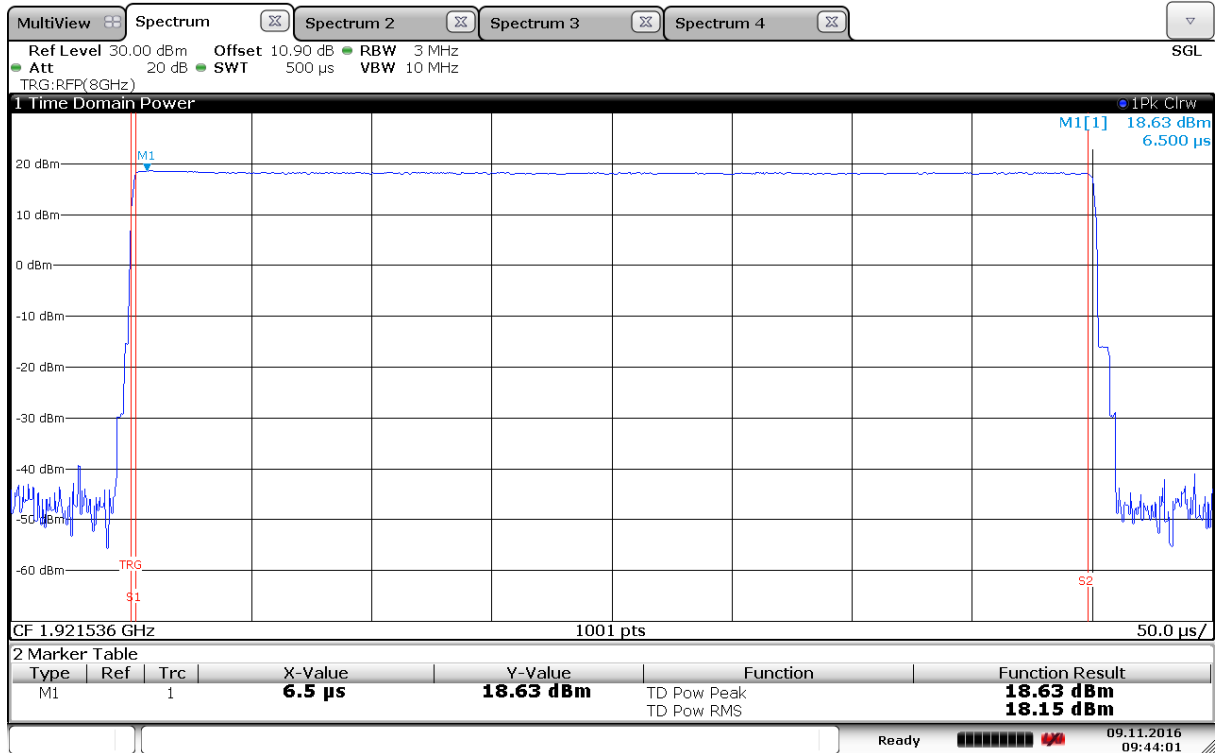

Lower Channel

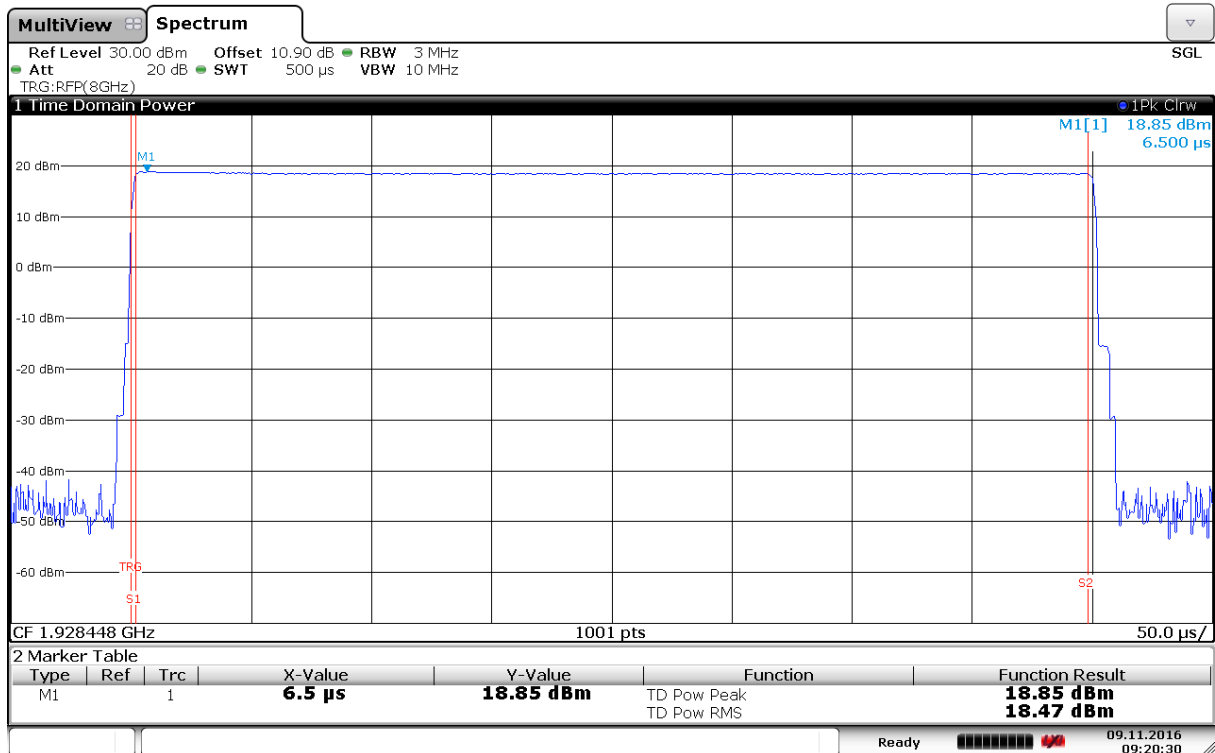

Upper Channel

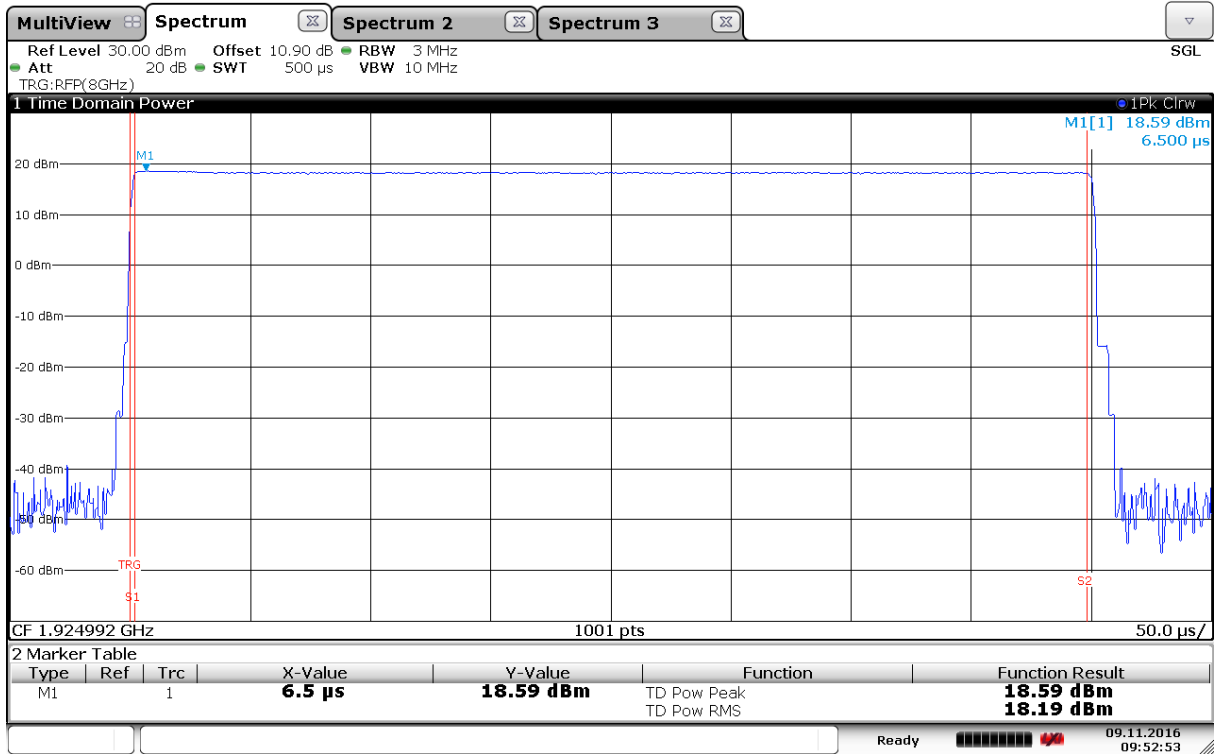

Middle Channel

3.8 Emission Bandwidth *B*

Test Method:

ANSI C63.17, clause 6.1.3.

Test Results: Complies

Measurement Data:

Channel No.	Frequency (MHz)	Emission Bandwidth <i>B</i> (MHz)
4	1921.536	1.43
2	1924.992	1.42
0	1928.448	1.43

Channel No.	Frequency (MHz)	Occupied Bandwidth (MHz)
2	1924.992	1.28

Requirements, FCC 15.323(a), RSS-213 Issue 3, clause 5.5

The Emission Bandwidth *B* shall be larger than 50 kHz and less than 2.5 MHz.

No requirements for 6 and 12 dB Bandwidth, these values are only used for testing Monitoring Bandwidth if the Simple Compliance test fails (ANSI C63.17, clause 7.4).

Occupied Bandwidth (99%) is measured according to RSS-GEN Issue 4, clause 6.6. This value is reported for information only.

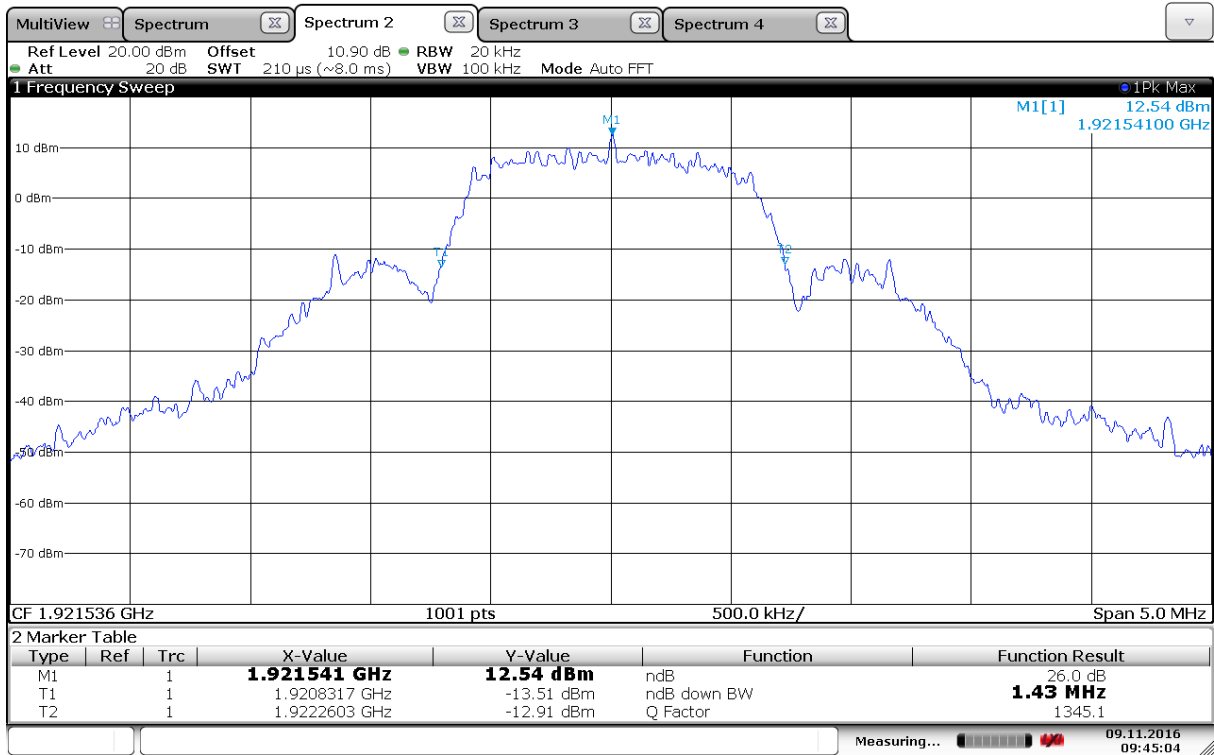

Emission Bandwidth B, Lower Channel

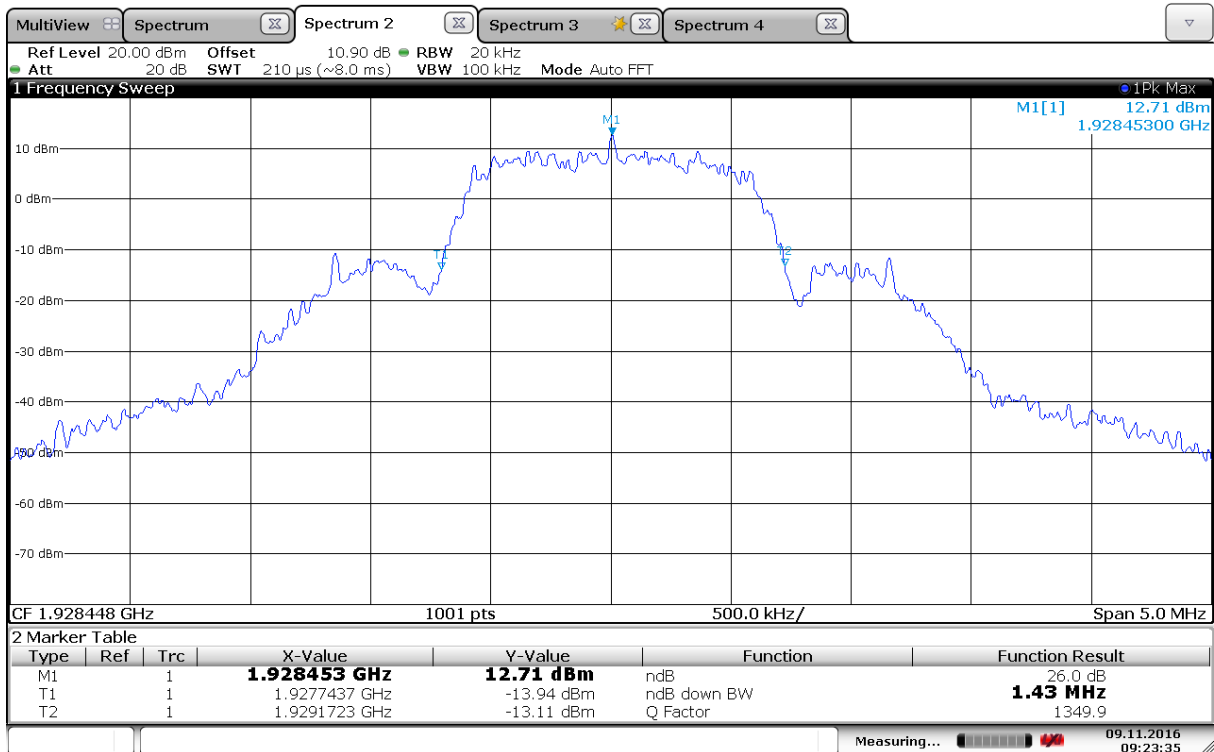

Emission Bandwidth B, Upper Channel

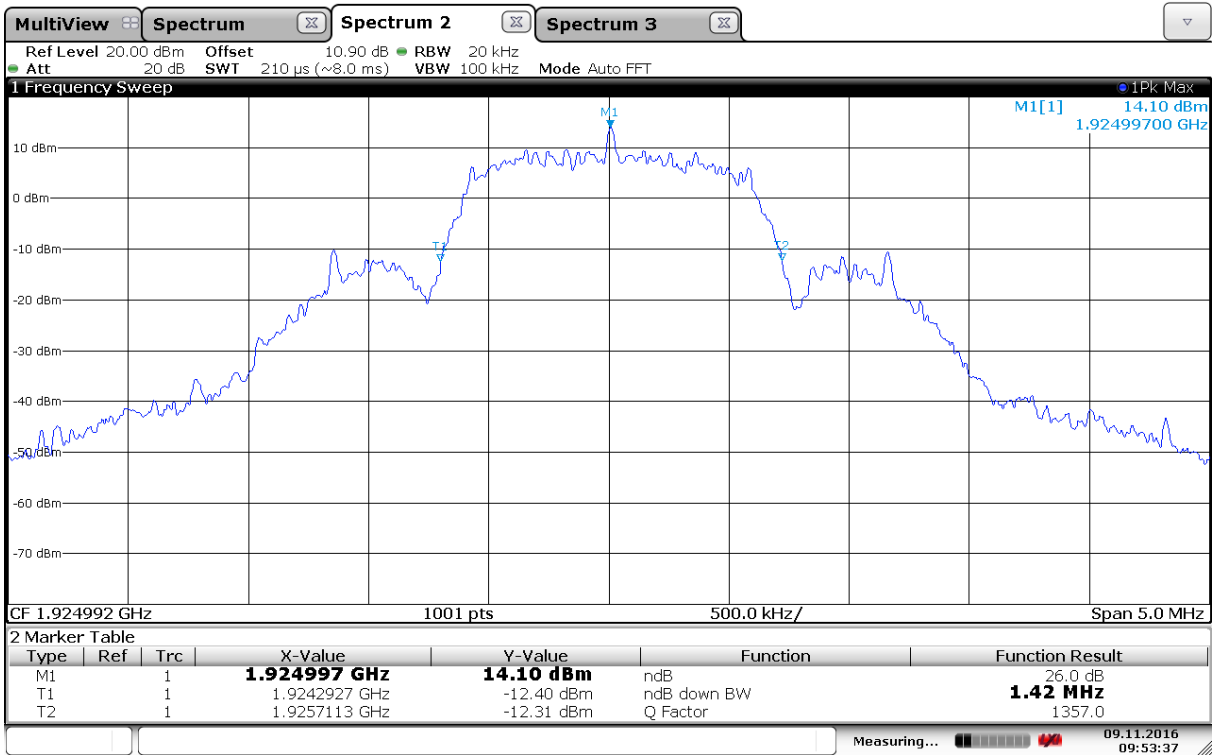

Emission Bandwidth B, Mid Channel

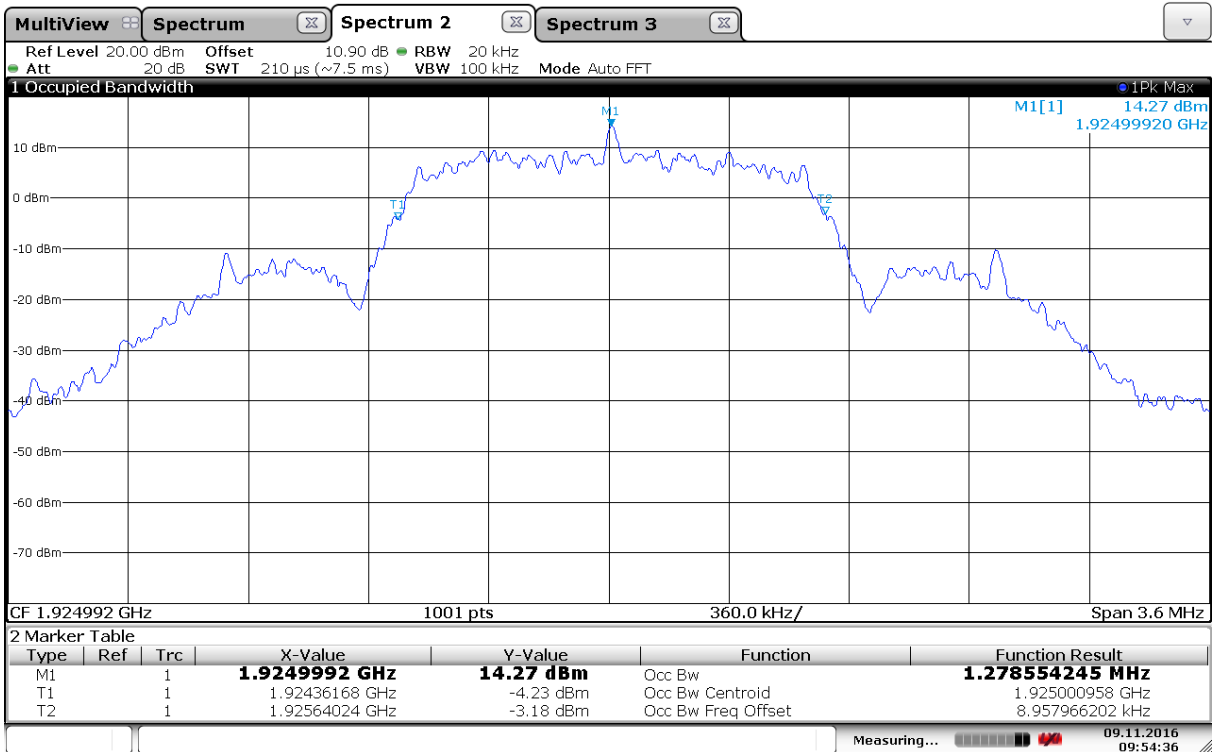

99% Bandwidth, Mid Channel

3.9 Power Spectral Density

Test Method:

ANSI C63.17, clause 6.1.5.

Test Results: Complies

Measurement Data:

Channel No.	Frequency (MHz)	Power Spectral Density (dBm)
4	1921.536	1.7
0	1928.448	1.9

Averaged over 1000 sweeps.

Requirements, FCC 15.319(d)

The Power Spectral Density shall be less than 3 mW (4.77 dBm) when averaged over at least 100 sweeps.

Power Spectral Density

Lower Channel:

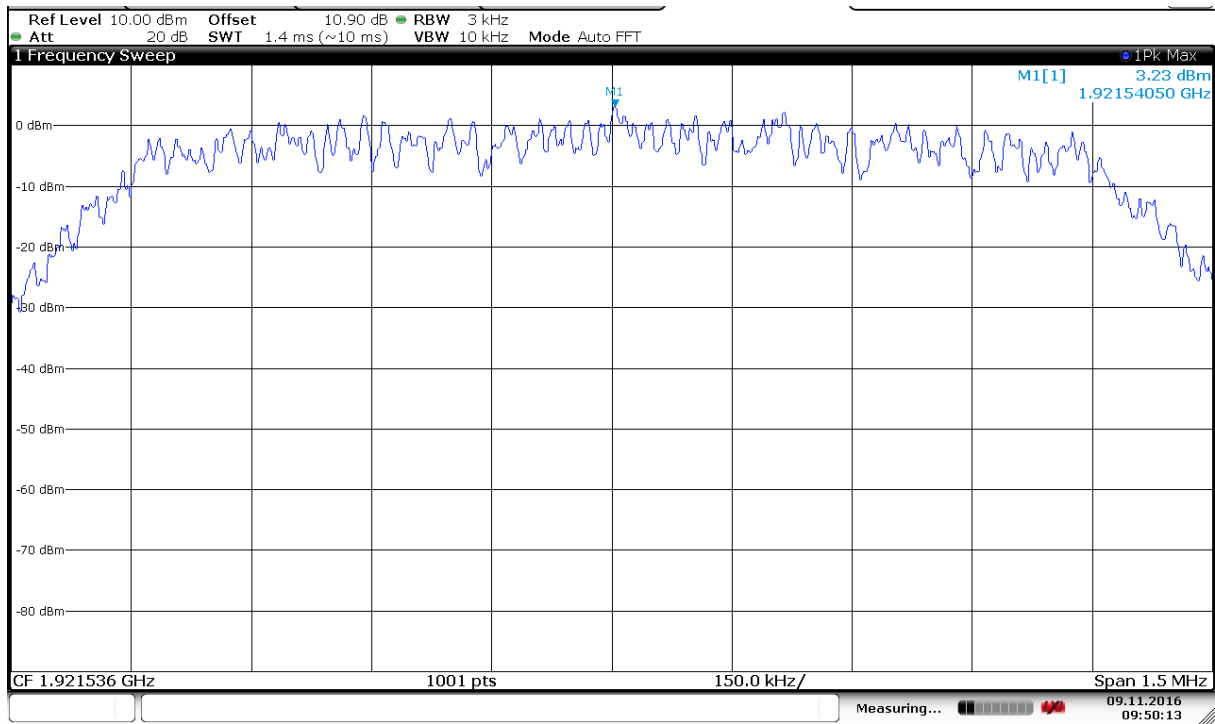

Overview

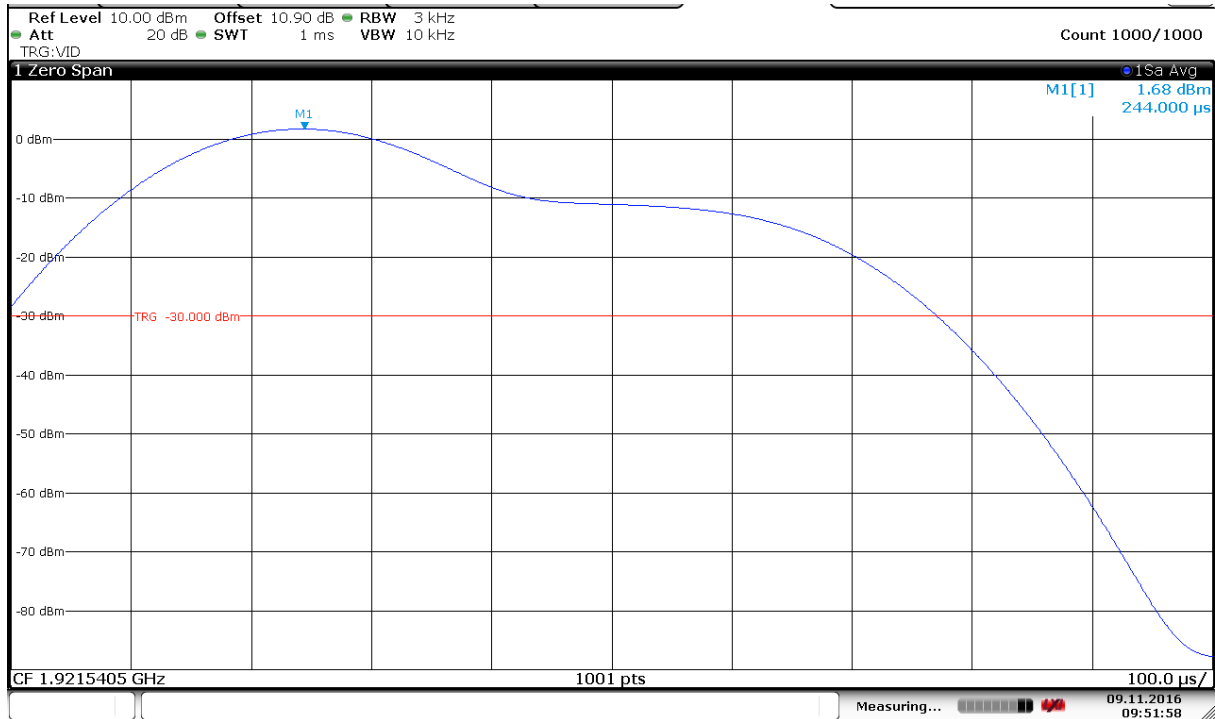

Averaged, 1000 Sweeps

Upper Channel:

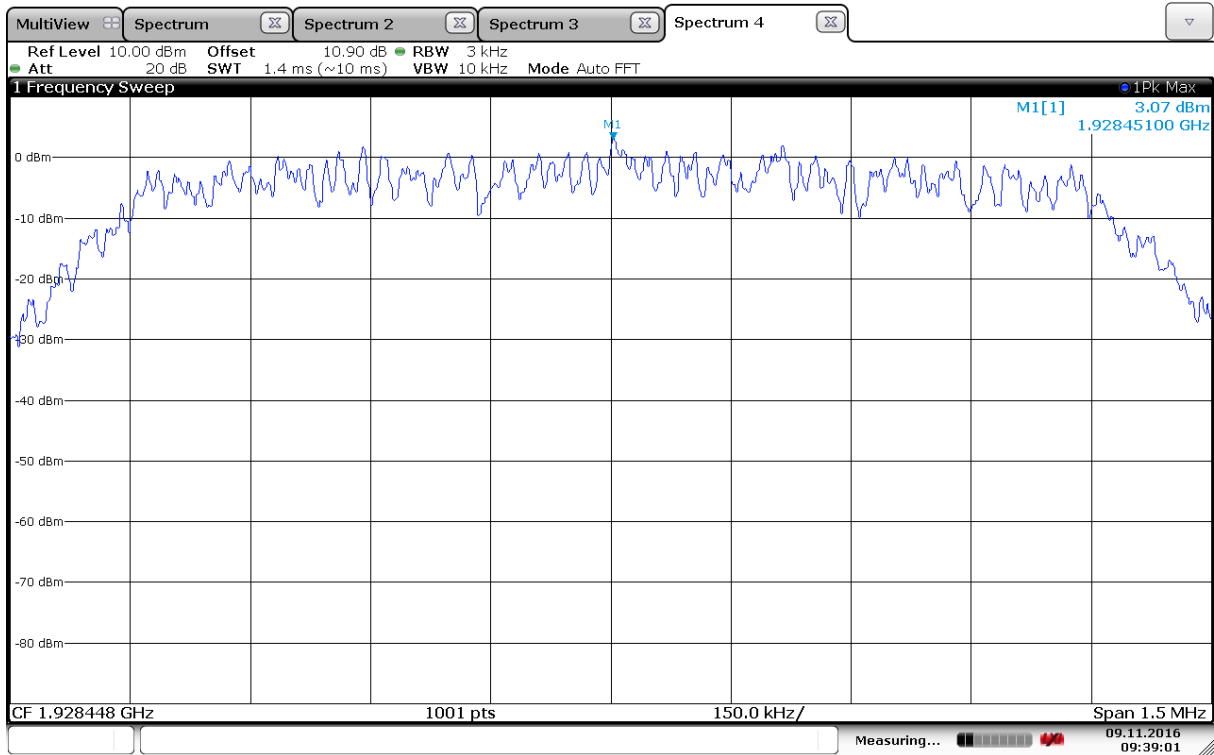

Overview

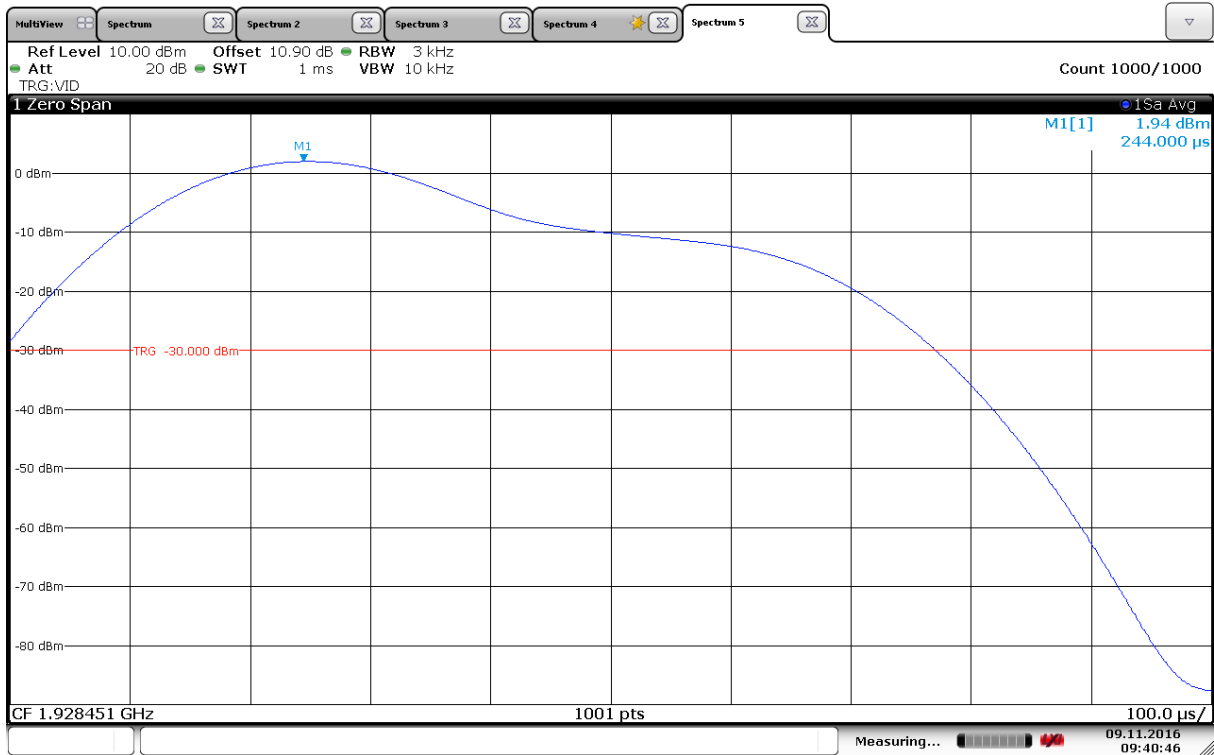

Averaged, 1000 Sweeps

3.10 In-Band Unwanted Emissions, Conducted

Test Method:

ANSI C63.17, clause 6.1.6.1.

Test Results: Complies

Measurement Data:

See plots.

Requirements, FCC 15.323(d):

- $B < f \leq 2B$: at least 30 dB below max. permitted peak power
- $2B < f \leq 3B$: at least 50 dB below max. permitted peak power
- $3B < f \leq$ UPCS Band Edge : at least 60 dB below max. permitted peak power

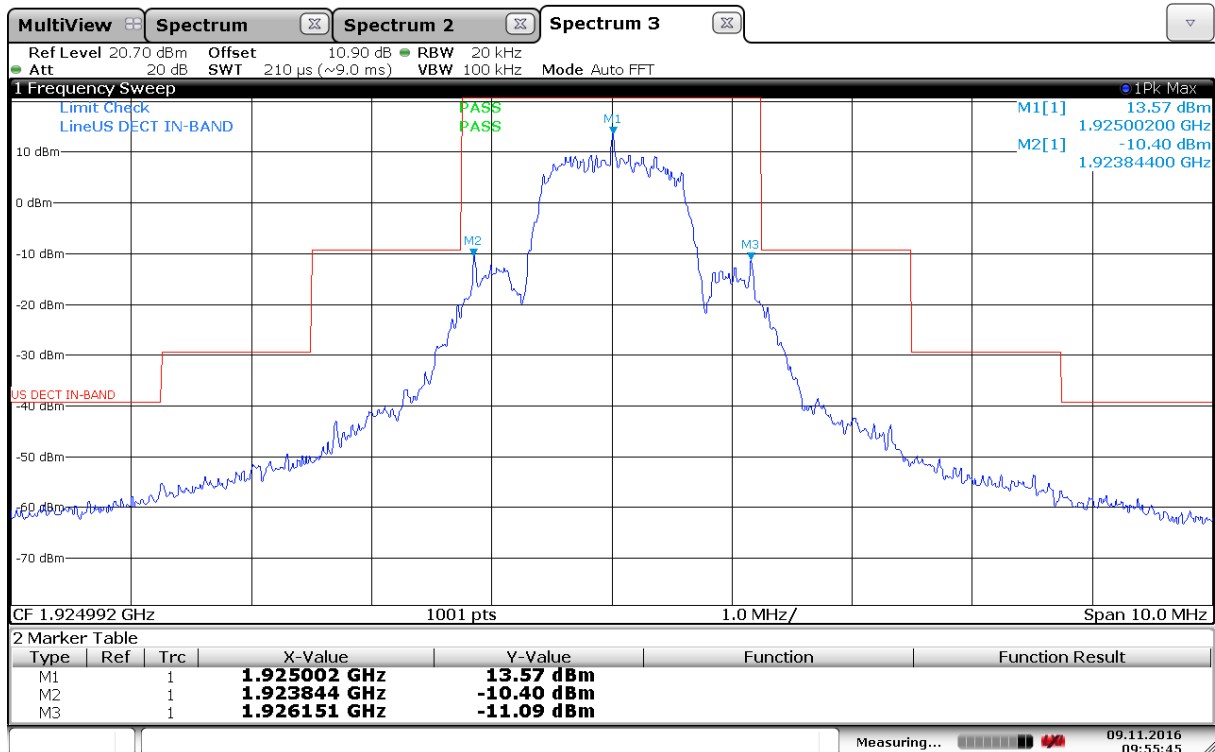

Middle Channel

In-Band Unwanted Emissions, Conducted

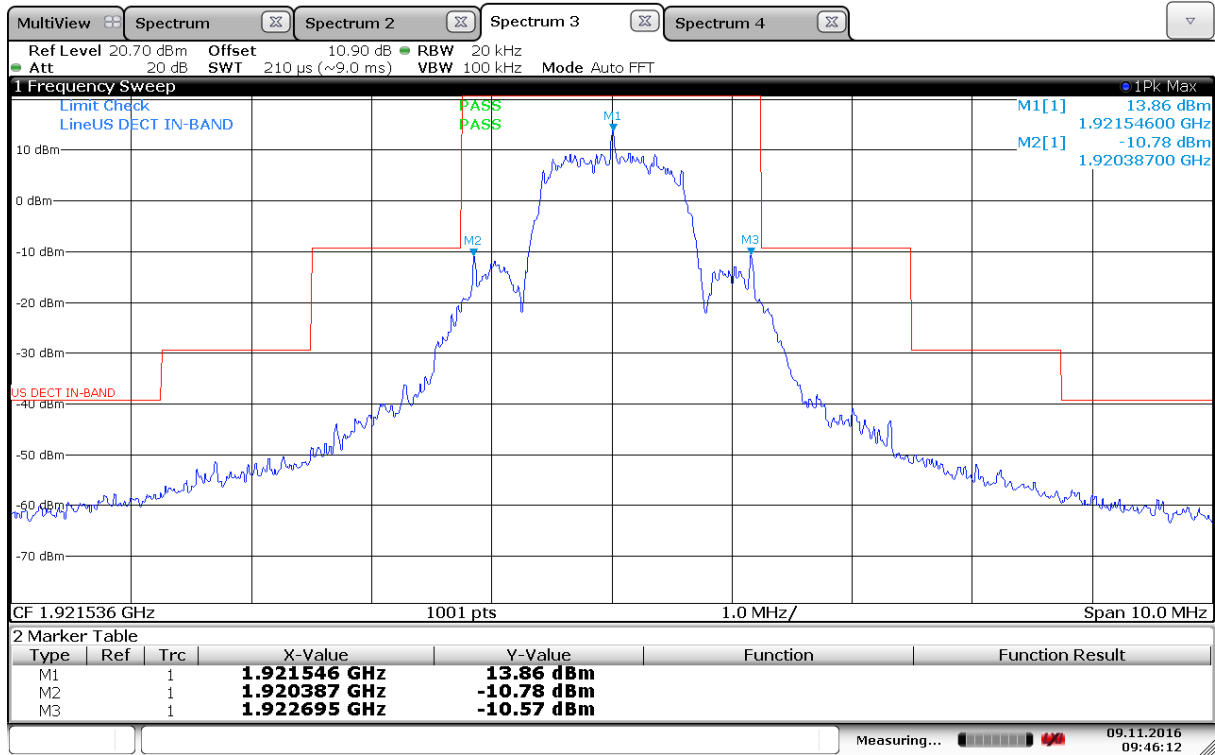

Lower Channel

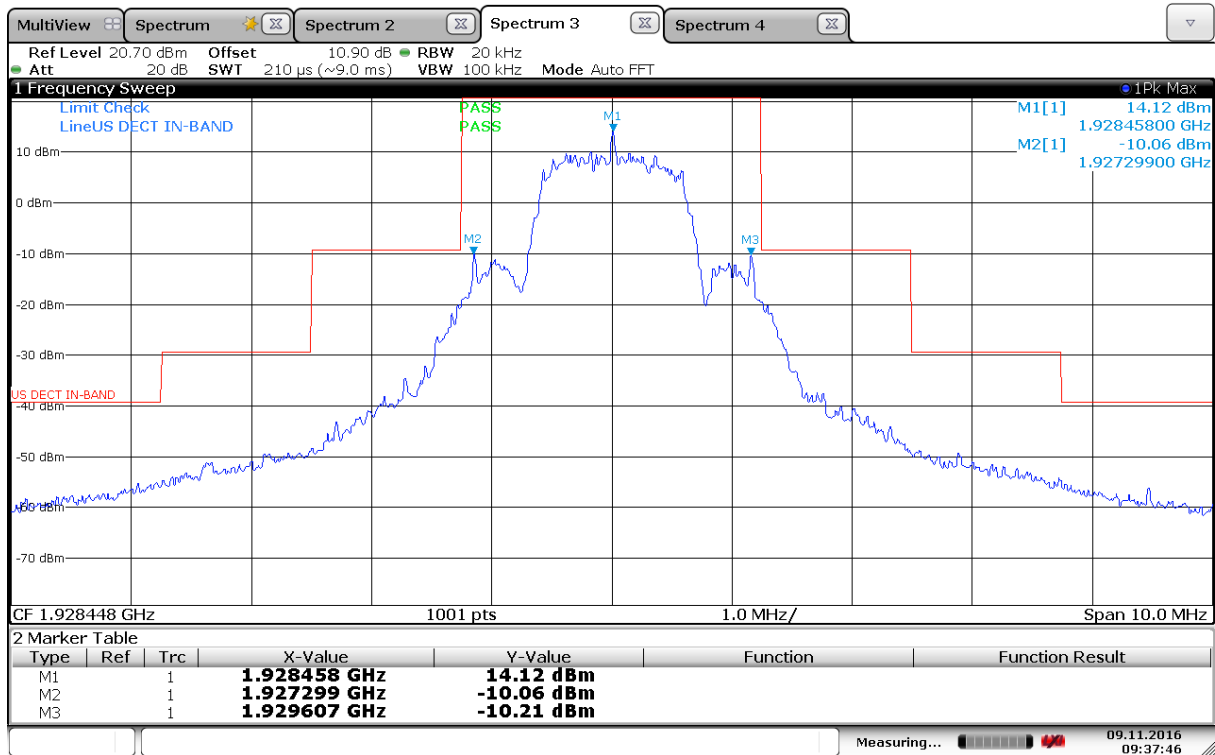

Upper Channel

3.11 Out-of-band Emissions, Conducted

Test Method:

ANSI C63.17, clause 6.1.6.2.

Test Results: Complies

Measurement Data:

See plots.

Requirements, FCC 15.323(d):

- $f \leq 1.25\text{MHz}$ outside UPCS band : $\leq -9.5\text{dBm}$
- $1.25\text{MHz} \leq f \leq 2.5\text{MHz}$ outside UPCS band : $\leq -29.5\text{ dBm}$
- $f \geq 2.5\text{MHz}$ outside UPCS band : $\leq -39.5\text{ dBm}$

Out-of-Band Emissions, Conducted

Lower Channel:

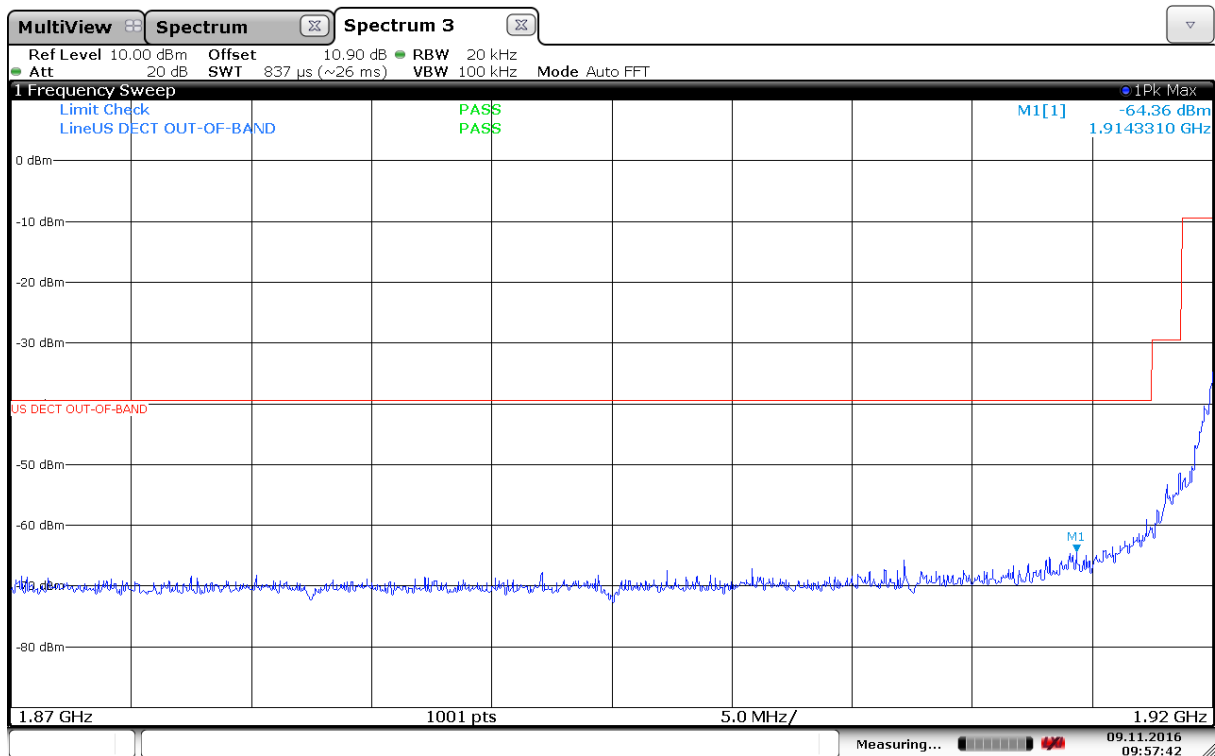

Out-of-Band Emissions, Conducted

Lower Channel:

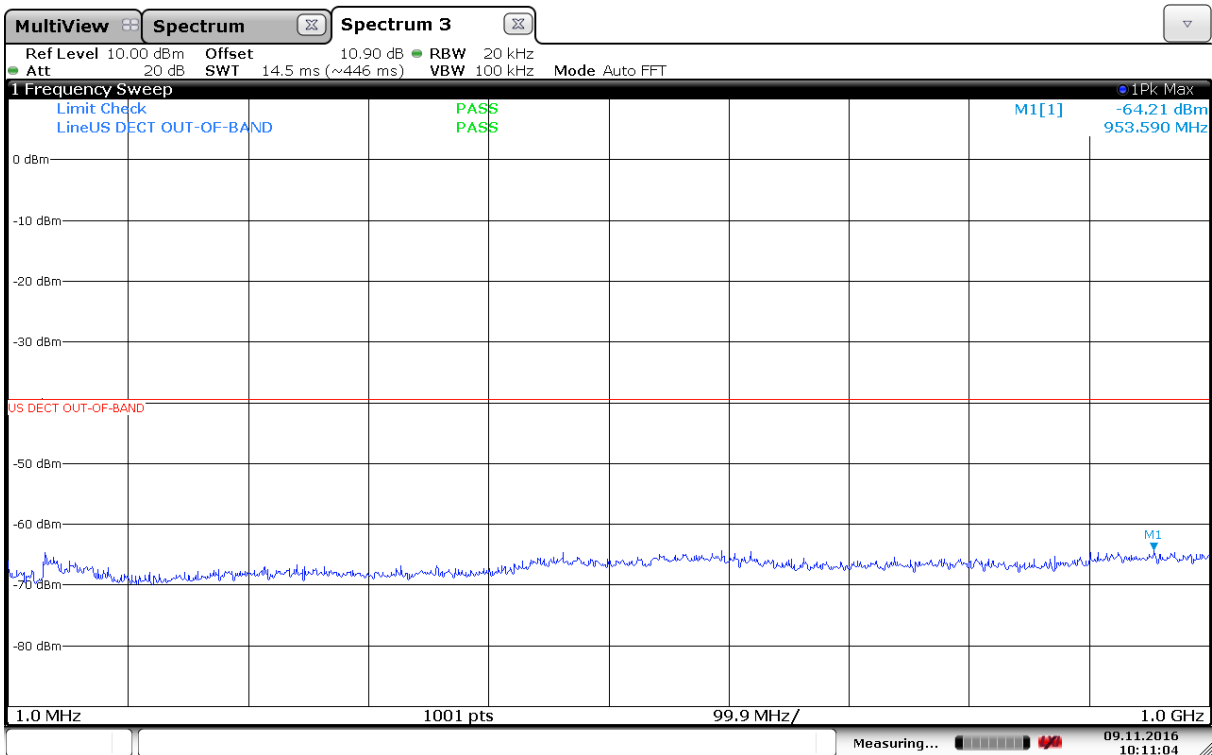
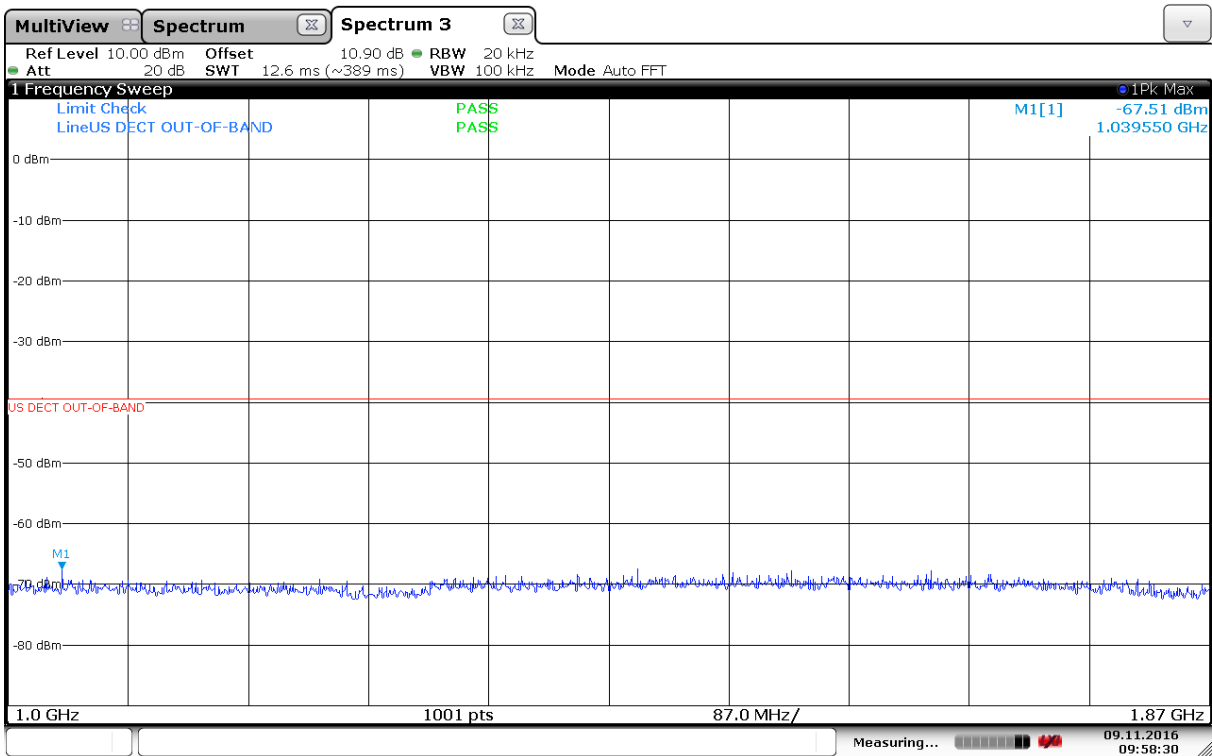

Out-of-Band Emissions, Conducted

Upper Channel:

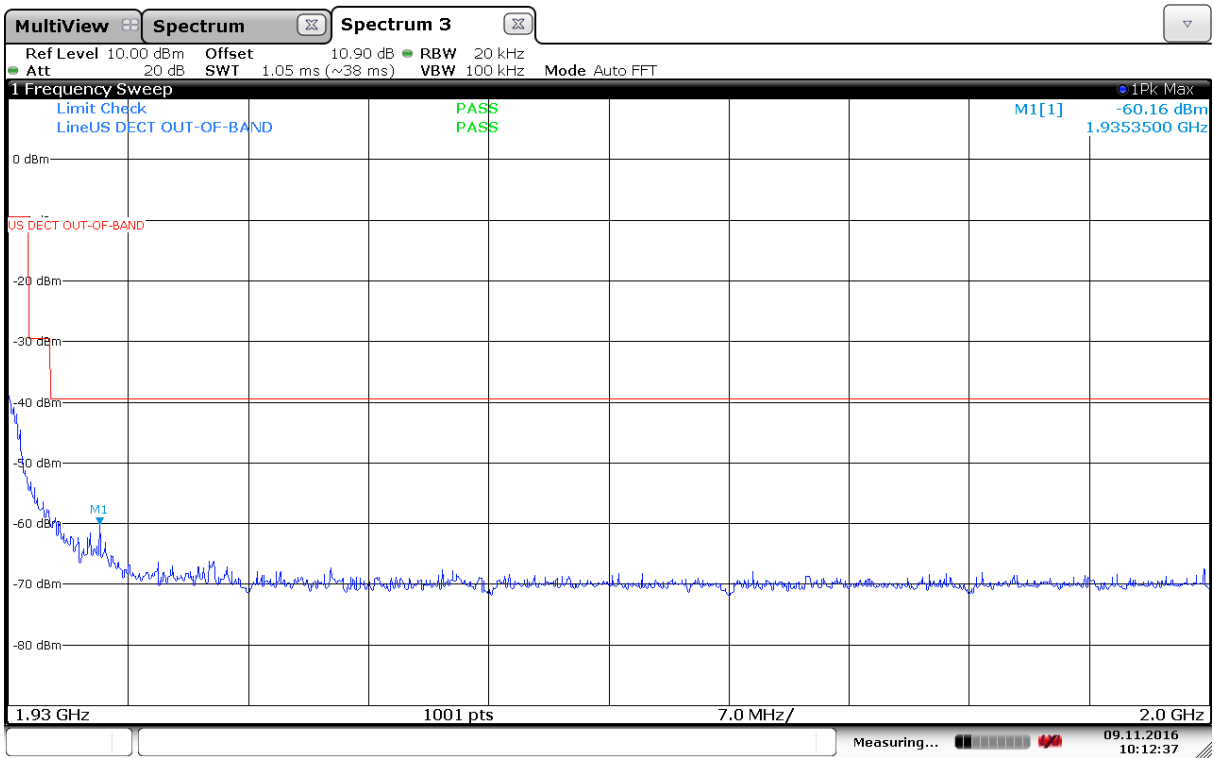

Mid Channel:

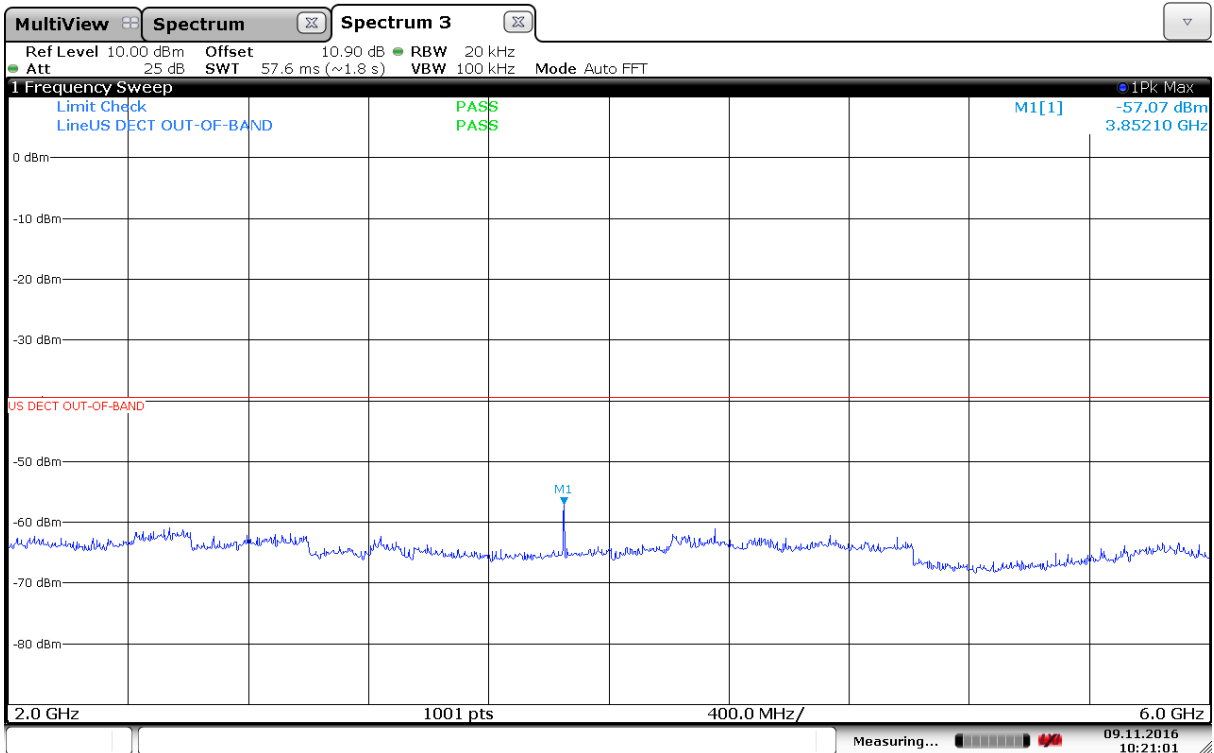

Out-of-Band Emissions, Conducted

Mid Channel:

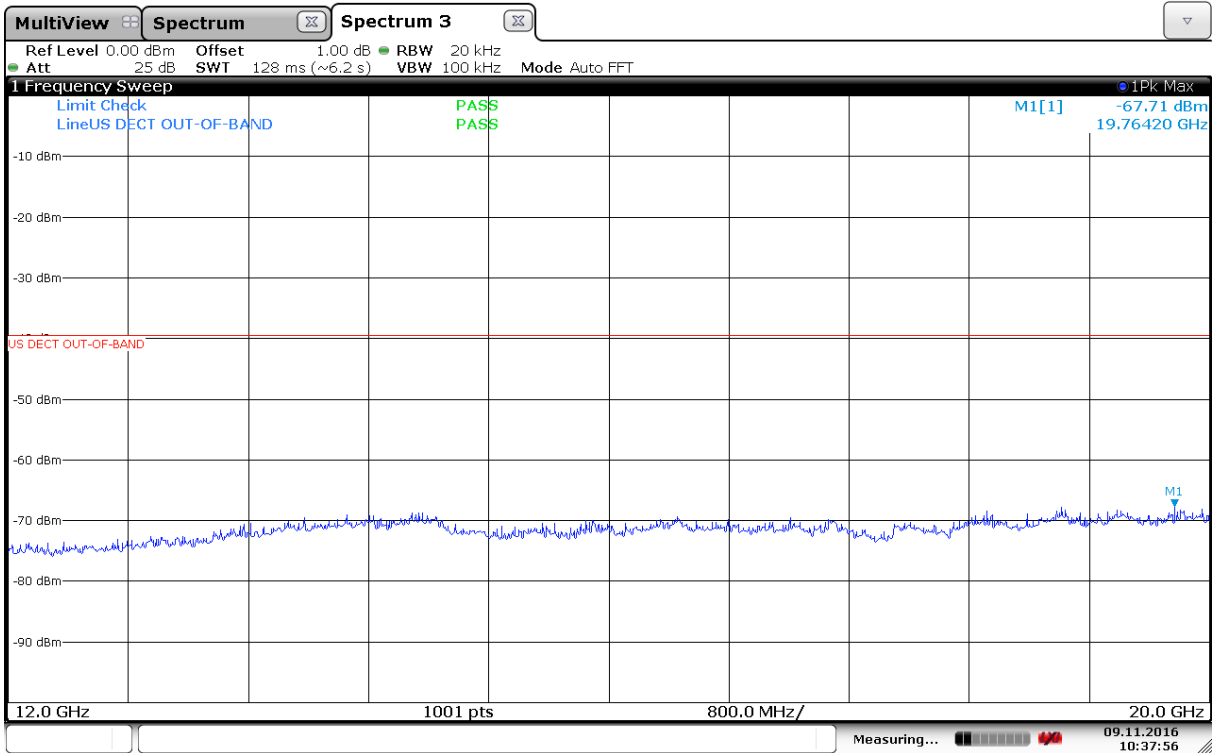
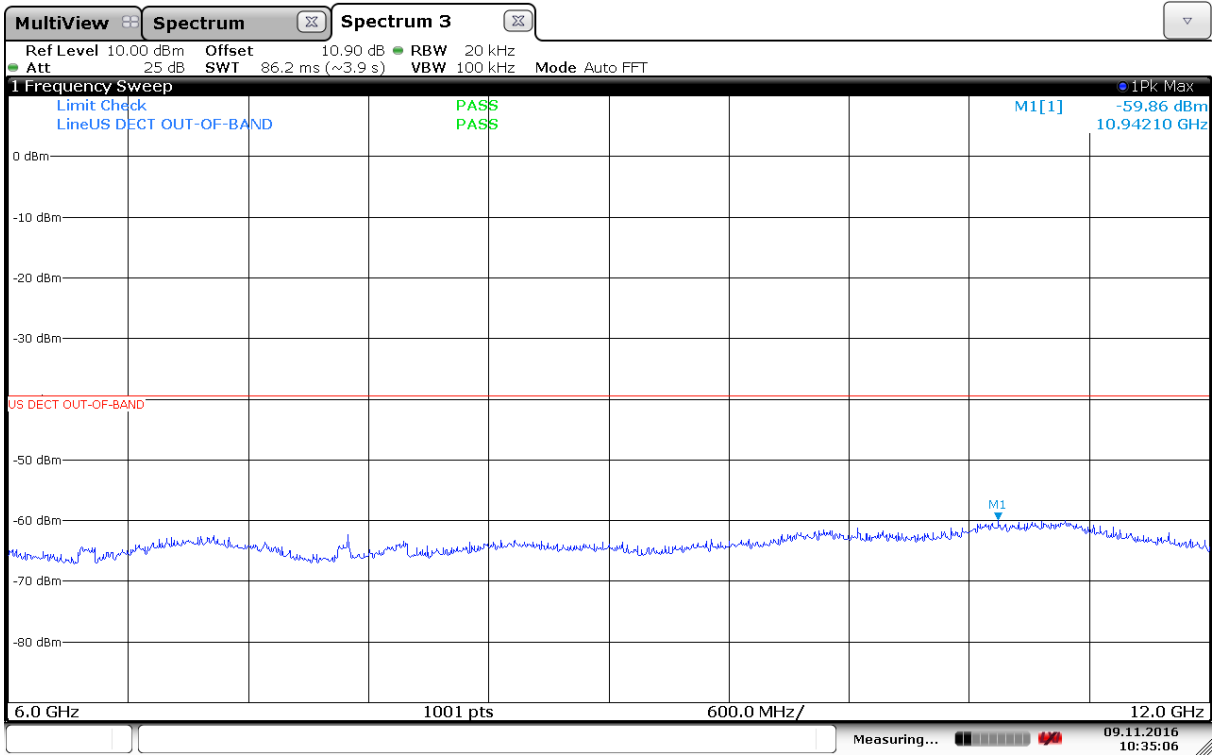

Out-of-Band Emissions, Conducted

Mid Channel:

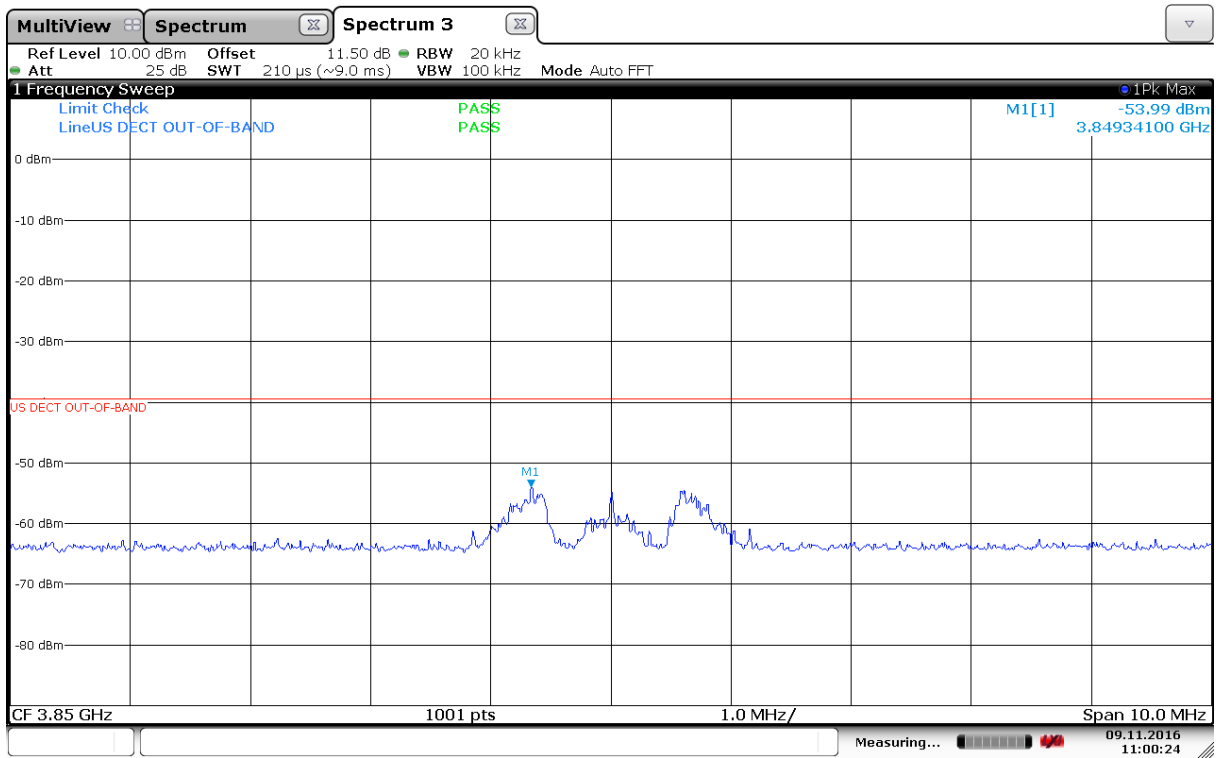

3.12 Carrier Frequency Stability

Test Method:

ANSI C63.17, clause 6.2.1.

Test Results: Complies

Measurement Data:

Long Term Frequency Stability is measured with the HP53310A Modulation Domain Analyzer. The HP53310A was logged by a computer programmed to get new readings as fast as possible (about 1 reading per second) over the noted time period or number of readings. The peak-to-peak difference was recorded and the mean value and deviation in ppm was calculated.

The Carrier Frequency Stability over Power Supply Voltage and over Temperature is measured with a Frequency Domain Analyzer in histogram mode.

Carrier Frequency Stability over Time at Nominal Temperature

Average Mean Carrier Frequency (MHz)	Max. Diff. (kHz)	Min. Diff. (kHz)	Max. Dev. (ppm)	Limit
1925.001145	13.235	4.746	-2.3	±10 ppm

Deviation ppm = ((Diff. - Mean Diff) / Mean Carrier Freq.) x 10⁶

Deviation (ppm) is calculated from 3000 readings.

Frequency Stability over Power Supply Voltage at Nominal Temperature

Voltage	Measured Carrier Frequency (MHz)	Difference (kHz)	Deviation (ppm)	Limit
V _{nom}	/	0	0	±10 ppm
85% of V _{nom}	/	/	/	
115% of V _{nom}	/	/	/	

Deviation ppm = ((Mean – Measured Frequency) / Mean) x 10⁶

This test does not apply for EUT that is powered from batteries.

Frequency Stability over Temperature

Temperature	Measured Carrier Frequency (MHz)	Difference (kHz)	Deviation (ppm)	Limit
T = +20 °C	1925.0031	0	0	±10 ppm
T = -20 °C	1925.0020	-1.1	-0.6	
T = +50 °C	1925.0008	-2.3	-1.2	

Deviation ppm = ((Mean – Measured Frequency) / Mean) x 10⁶

3.13 Frame Repetition Stability

Test Method:

ANSI C63.17, clause 6.2.2.

Test Results: Complies

Measurement Data:

The envelope of the RF signal from the EUT is detected with a Crystal Detector and the mean and standard deviation of the frame repetition frequency is then gated over 100 frames and measured with a Frequency Domain Analyzer. The frame repetition stability is 3 times the standard deviation.

Carrier Frequency (MHz)	Mean (Hz)	Standard Deviation (µHz)	Frame Repetition Stability (ppm)
1924.992	100.000	1.023	0.031

Limit:

Frame Repetition Stability	±10 ppm (TDMA)
-----------------------------------	----------------

Ref. FCC 15.323(e), ANSI C63.17, clause 6.2.2

3.14 Frame Period and Jitter

Test Method:

ANSI C63.17, clause 6.2.3.

Test Results: Complies

Measurement Data:

The envelope of the RF signal from the EUT is detected with a Crystal Detector and the frame period and jitter is measured with a Frequency Domain Analyzer over at least 100.000 frames.

Carrier Frequency (MHz)	Frame Period (ms)	Max Jitter (µs)	3xStandard Deviation of Jitter (µs)
1924.992	10.000	-0.033	-0.027

Max Jitter = (1/ (Frame period + Pk-Pk/2)) - (1/Frame Period), when Pk-Pk and Frame Period are in Hz

3xSt.Dev.Jitter = 3x (1/(Frame Period + St.Dev) – 1/St.Dev) x 10⁶

Limit:

Frame Period	20 or 10 ms
Max Jitter	25 µs
3 times St.Dev of Jitter	12.5 µs

Ref. FCC 15.323(e), ANSI C63.17, clause 6.2.3

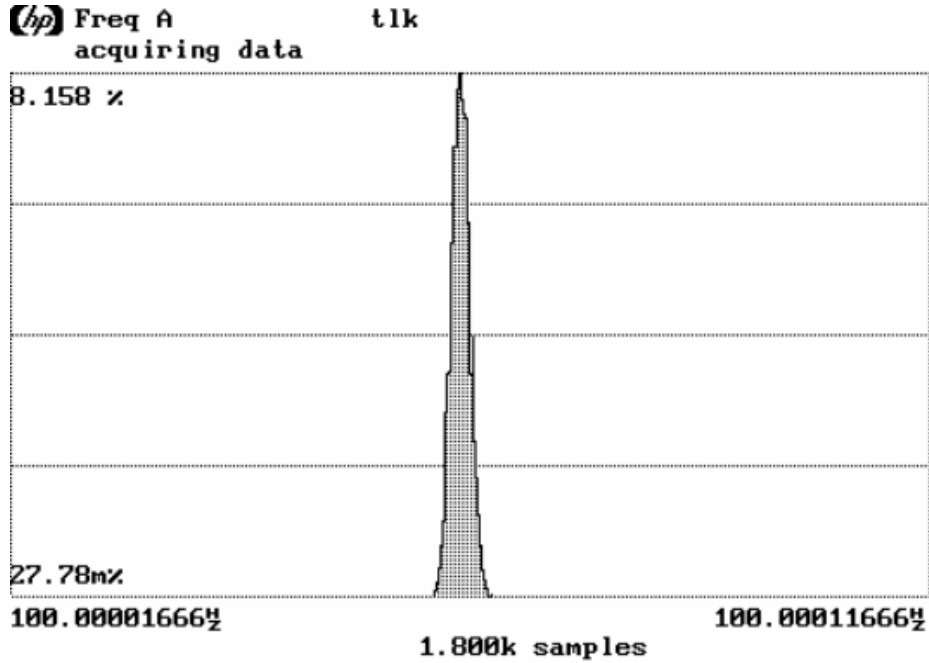

Mean 100.0000656027 MHz 1/Mean 10.000ms
 Pk-Pk 6.24 μHz Std Dev 1.0229 μHz

Frame Repetition Stability, Gated over 100 Frames

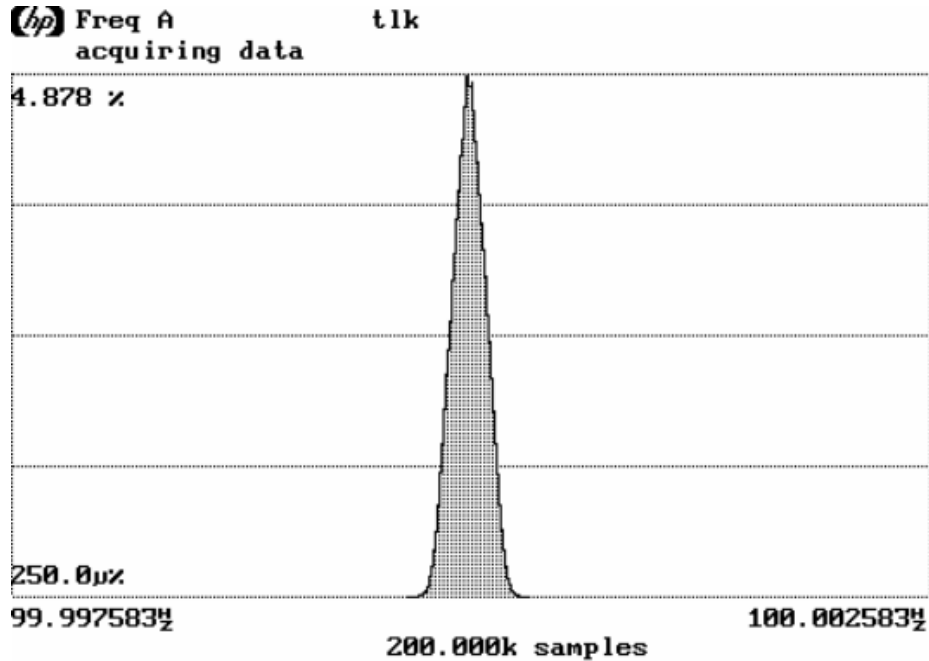

Mean 100.000071819 MHz 1/Mean 10.000ms
 Pk-Pk 657 μHz Std Dev 88.562 μHz

Frame Period and Jitter

3.15 Monitoring Threshold, Least Interfered Channel

Monitoring Threshold Limits:

Lower Threshold:

$$T_L = 15 \log B - 184 + 30 - P_{EUT} \quad (\text{dBm})$$

Upper Threshold:

$$T_U = T_L + 20 \quad (\text{dBm})$$

B is measured Emission Bandwidth in Hz
 P_{EUT} is measured Transmitter Power in dBm

Calculated values:

	FCC 15.323, RSS-213, Issue 3
Lower Threshold	-80.2 dBm

Least Interfered Channel Procedure (LIC) may only be used by systems with more than 20 duplex system access channels. Systems with less than 20 duplex system access channels are not allowed to transmit when interferer level is above Lower Threshold.

Measurement Procedure:

Least Interfered Channel Procedure NOT used:	
Lower Threshold	N/A The EUT uses LIC procedure

Least Interfered Channel (LIC) Procedure Test, FCC 15.323(b), (c)(2) and (c)(5)

ANSI C63.17 clause 7.3.2 ref.	Observation	Verdict
b) f_1 at $T_L + U_M + 7$ dB, f_2 at $T_L + U_M$	Transmission always on f_2	Pass
c) f_1 at $T_L + U_M$, f_2 at $T_L + U_M + 7$ dB	Transmission always on f_1	Pass
d) f_1 at $T_L + U_M + 1$ dB, f_2 at $T_L + U_M - 6$ dB	Transmission always on f_2	Pass
e) f_1 at $T_L + U_M - 6$ dB, f_2 at $T_L + U_M + 1$ dB	Transmission always on f_1	Pass

Selected Channel Confirmation, FCC 15.323(c)(1) and (5)

ANSI C63.17 clause 7.3.3	Observation	Verdict
b) Shall not transmit on f_1	EUT transmits on f_2	Pass
d) Shall not transmit on f_2	EUT transmits on f_1	Pass

Limits:

FCC 15.323, RSS-213, Issue 3	
Lower Threshold + 6 dB margin	-74.2 dBm

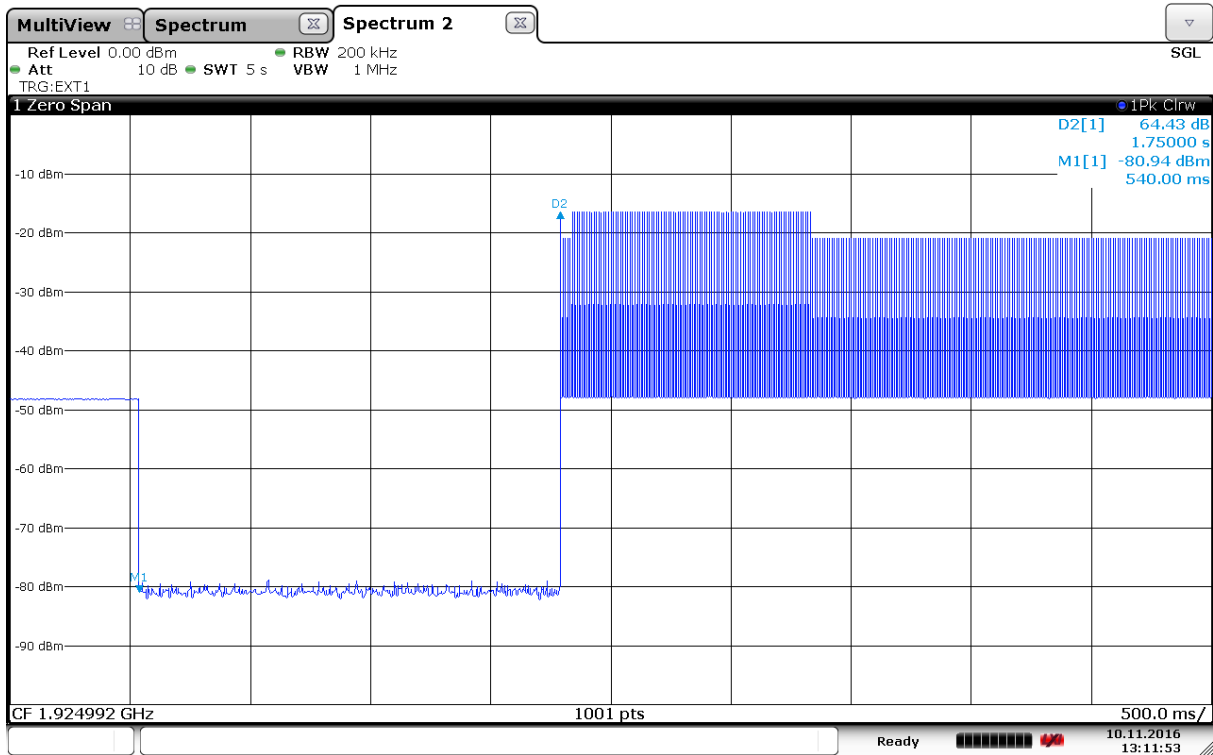

7.3.4 Selected Channel Confirmation, Connection 1.75s After Interferer Removed

3.16 Threshold Monitoring Bandwidth

This test is only required if a dedicated monitoring receiver is used. However, if the test is not carried out the manufacturer shall declare and provide proper evidence that the monitoring is made through the radio receiver used for communication.

Measurement Procedure:

Simple Compliance Test, ANSI C63.17, clause 7.4.1

More Detailed Test, ANSI C63.17, clause 7.4.2

The test is passed if **either** the Simple Compliance Test or the More Detailed test is passed.

During this test the spectrum analyzer is observed visually to see if the EUT transmits or not.

Test Results:

Test performed	Observation	Verdict
Simple Compliance test, at $\pm 30\%$ of B	N/A	N/A
More Detailed Test, at -6 dB points	N/A	N/A
More Detailed Test, at -12 dB points	N/A	N/A

The more detailed test must be pass at both the -6 and -12 dB points if the Simple Compliance test fails.

Comment: The manufacturer declares that the tested EUT uses the same receiver for monitoring and communication, this test is therefore not required.

Limits, FCC 15.323(c)(7):

The monitoring system bandwidth must be equal to or greater than the emission bandwidth of the intended transmission.

3.17 Reaction Time and Monitoring Interval

Measurement Procedure

ANSI C63.17, clause 7.5

Test results:

By administrative commands and out-of-operating region interference, the EUT is restricted to operate on two RF carrier frequencies.

A CW interferer signal at a level T_L is applied on f_1 and time-synchronized pulsed interference at a level $T_L + U_M$ dB is applied on f_2 . The level on f_2 was raised 6 dB for part d) with 35 μ s pulses.

The pulses are synchronized with the EUT timeslots and applied centered within all timeslots.

For both tests the test is passed if the EUT transmits on f_1 .

Pulse Width, ref. to ANSI C63.17 clause 7.5	Observation	Verdict
c) > largest of 50 μ s and $50 \cdot \text{SQRT}(1.25/B)$	EUT transmits on f_1	Pass
d) > largest of 35 μ s and $35 \cdot \text{SQRT}(1.25/B)$, and with interference level raised 6 dB	EUT transmits on f_1	Pass

Comment: Since B is larger than 1.25 MHz the test was performed with pulse lengths of 50 μ s and 35 μ s.

Limits, FCC 15.323(c)(1), (5) and (7)

The maximum reaction time must be less than $50 \cdot \text{SQRT}(1.25/\text{emission bandwidth in MHz})$ microseconds for signals at the applicable threshold level but shall not be required to be less than 50 μ s.

If a signal is detected that is 6 dB or more above the applicable threshold level, the maximum reaction time shall be $35 \cdot \text{SQRT}(1.25/\text{emission bandwidth in MHz})$ microseconds but shall not be required to be less than 35 μ s.

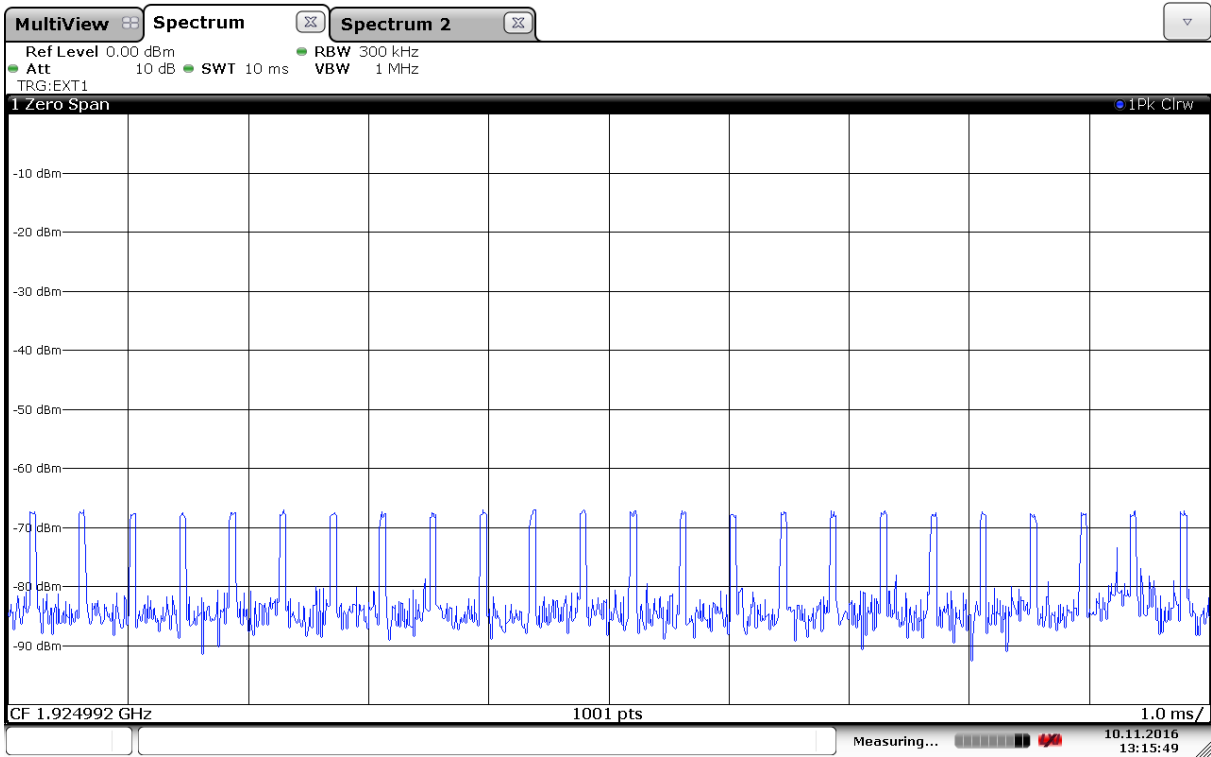

50 μ s Pulses

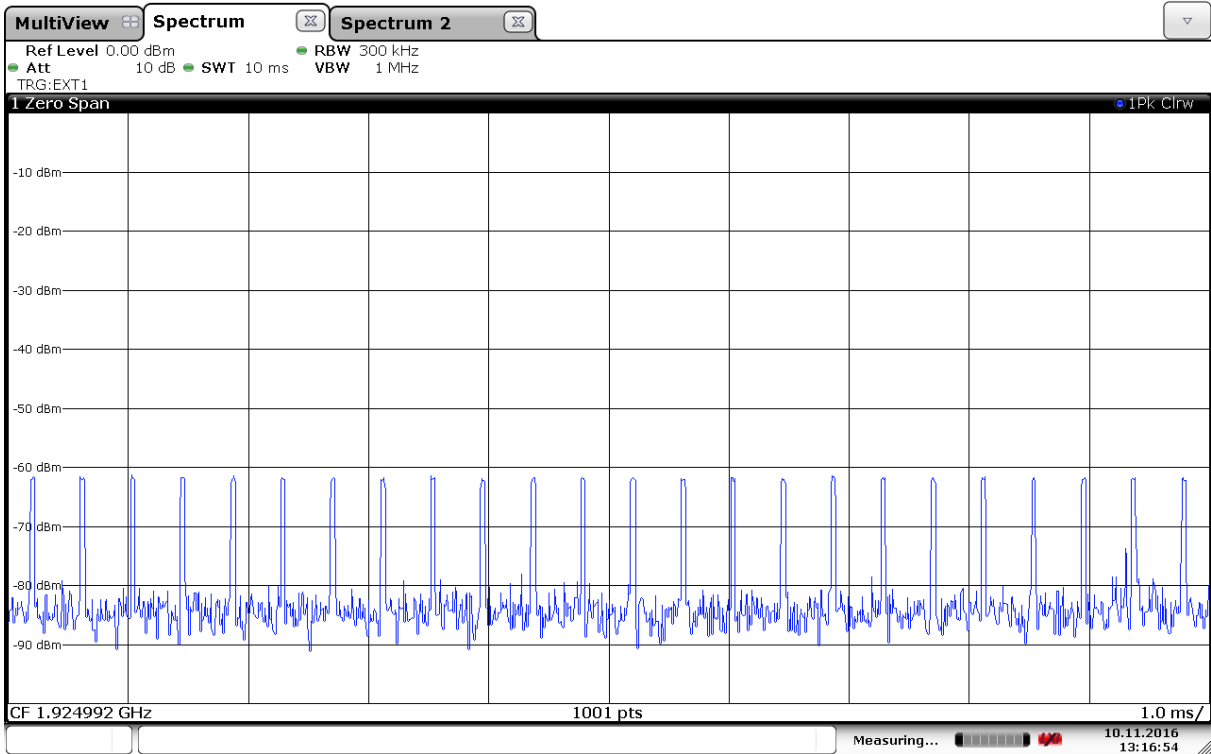

35 μ s Pulses

3.18 Time and Spectrum Window Access Procedure

This requirement is only for EUTs which transmit unacknowledged control and signaling information.

Measurement Procedure:

Timing for EUTs using control and signaling channel type transmissions: ANSI C63.17, clause 8.1

Test results:

Access Criteria, ref. to ANSI C63.17 clause 8.1.1	Observation	Verdict
b) Check that the EUT transmits on the interference free time-slot	N/A	N/A
b) The EUT must terminate or pause in its repetitive transmission of the control and signalling channel on the open channel to repeat the access criteria not less frequently than every 30 s	N/A	N/A

If FCC 15.323(c)(6) option, **If Random Waiting Interval is NOT implemented**

Access Criteria, ref. to ANSI C63.17 clause 8.1.2	Observation	Verdict
b) Check that the EUT changes to an interference-free slot when interference is introduced on the time slot in use	N/A	N/A

If FCC 15.323(c)(6) option, **Only if Random Waiting Interval is implemented**

Access Criteria, ref. to ANSI C63.17 clause 8.1.3	Observation	Verdict
b-d) Check that the EUT uses random waiting interval before continuing transmission on an interfered time slot	N/A	N/A

Comment: The tested EUT does not transmit unacknowledged control and signaling information.

Limits:

FCC 15.323(c)(4):

Once access to specific combined time and spectrum windows is obtained an acknowledgement from a system participant must be received by the initiating transmitter within one second or transmission must cease. Periodic acknowledgements must be received at least every 30 seconds or transmission must cease. Channels used exclusively for control and signaling information may transmit continuously for 30 seconds without receiving an acknowledgement, at which time the access criteria must be repeated.

FCC 15.323(c)(6):

If the selected combined time and spectrum windows are unavailable, the device may either monitor and select different windows or seek to use the same windows after waiting an amount of time, randomly chosen from a uniform random distribution between 10 and 150 milliseconds, commencing when the channel becomes available

3.19 Acknowledgements and Transmission Duration

Measurement Procedure:

Acknowledgements: ANSI C63.17, clause 8.2.1

Transmission Duration: ANSI C63.17, clause 8.2.2

During the test **Initial transmission without acknowledgements** the signal from the EUT to the companion device is blocked by circulators in addition to the tunable attenuator.

The test **Transmission time after loss of acknowledgements** is performed by cutting-off the signal from the companion device by a RF switch and measuring the time until the EUT stops transmitting.

The **Transmission Duration** test is performed by monitoring the slot in use and measuring the time until the EUT changes to a different slot.

Test Results:

Acknowledgements

Test ref. to ANSI C63.17 clause 8.2.1	Observation	Verdict
a) Initial transmission without acknowledgements	0.001 sec	Pass
c) Transmission time after loss of acknowledgements	10 sec	Pass

Transmission Duration

Test ref. to ANSI C63.17 clause 8.2.2	Observation	Verdict
b) Transmission duration on same time and frequency window	1:00 hour	Pass

Comment: /

Limits, FCC 15.323(c)(3) and (4)

Occupation of the same combined time and spectrum windows by a device or group of cooperating devices continuously over a period of time longer than 8 hours is not permitted without repeating the access criteria.

Once access to specific combined time and spectrum windows is obtained an acknowledgement from a system participant must be received by the initiating transmitter within one second or transmission must cease.

Periodic acknowledgements must be received at least every 30 seconds or transmission must cease. Channels used exclusively for control and signaling information may transmit continuously for 30 seconds without receiving an acknowledgement, at which time the access criteria must be repeated.

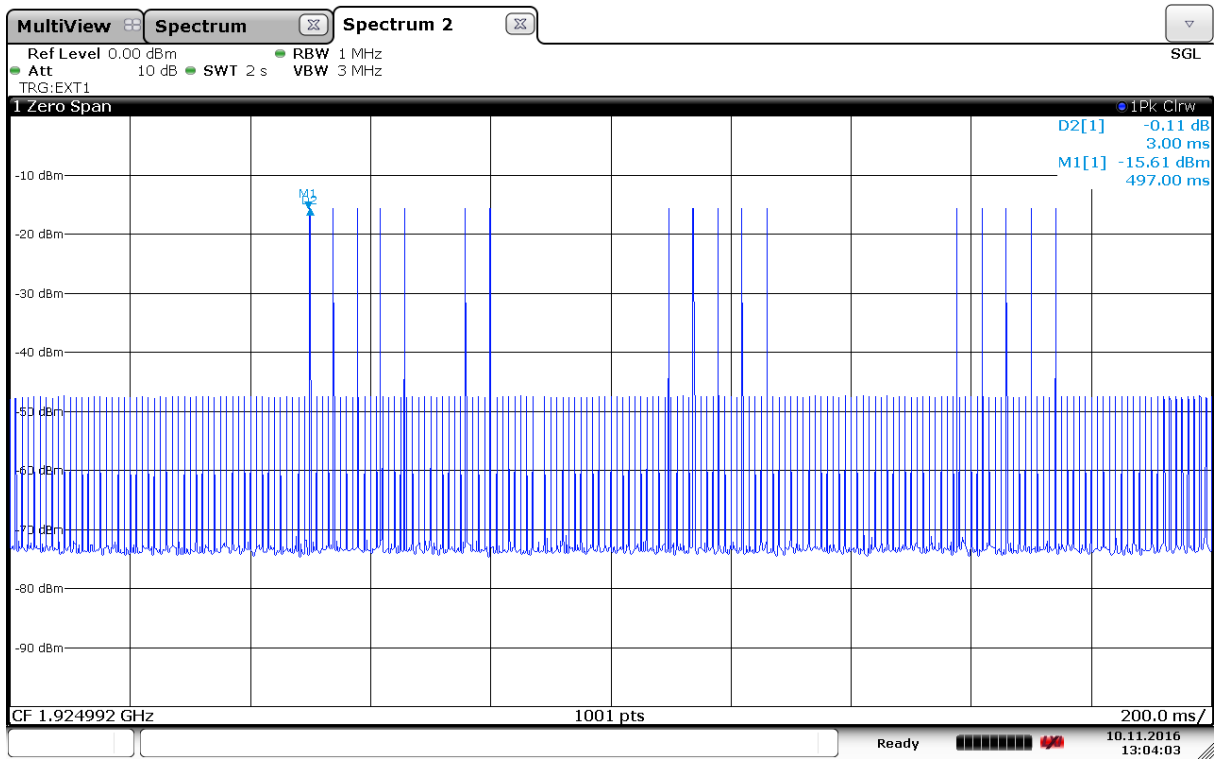

8.2.1a) Initial Transmission Without Acknowledgements

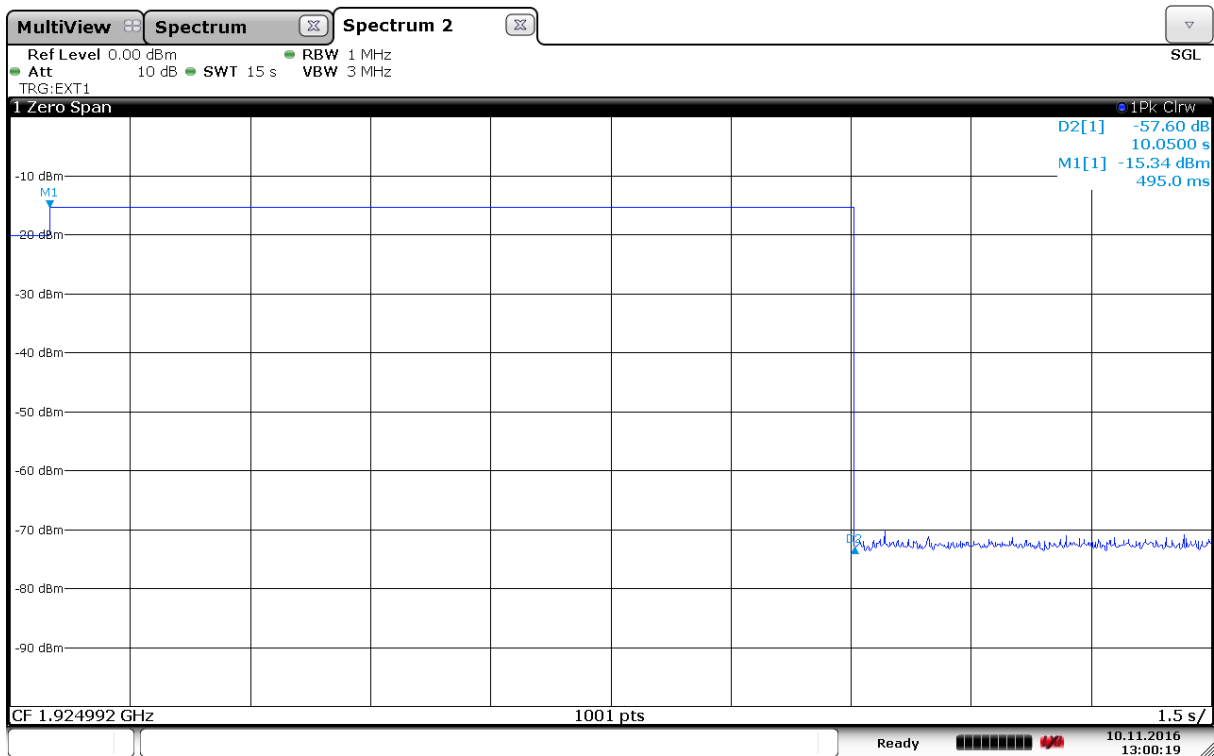

8.2.1c) Transmission Time After Loss of Acknowledgements

3.20 Dual Access Criteria Check

Measurement Procedure:

EUTs that does not implement the LIC procedure: ANSI C63.17, clause 8.3.1

EUTs that implement the LIC procedure: ANSI C63.17, clause 8.3.2

This test is required for equipment that uses the access criteria in FCC 15.323(c)(10).

Test Results:

EUTs that do NOT implements the LIC procedure:

Test ref. to ANSI C63.17 clause 8.3.1	Observation	Verdict
b) EUT is restricted to a single carrier f_i for TDMA systems. The Test is Pass if EUT can transmit	N/A	N/A
c) d) Interference at level $T_L + U_M$ on all timeslots except one receive slot where interference is at least 10 dB below T_L	N/A	N/A
e) f) Interference at level $T_L + U_M$ on all timeslots except one transmit slot where interference is at least 10 dB below T_L	N/A	N/A

EUTs that implements the LIC procedure:

Test ref. to ANSI C63.17 clause 8.3.2	Observation	Verdict
b) EUT is restricted to a single carrier f_i for TDMA systems. The Test is Pass if EUT can transmit	EUT can transmit	Pass
c) d) Transmission on interference-free receive time/spectrum window	EUT transmits on interference free receive slot	Pass
e) f) Transmission on interference-free transmit time/spectrum window	EUT transmits on interference free transmit slot	Pass

Comment: See plots.

Limits, FCC 15.323(c)(10)

An initiating device may attempt to establish a duplex connection by monitoring both its intended transmit and receive time and spectrum windows. If both the intended transmit and receive time and spectrum windows meet the access criteria, then the initiating device can initiate a transmission in the intended transmit time and spectrum window. If the power detected by the responding device can be decoded as a duplex connection signal from the initiating device, then the responding device may immediately begin transmitting on the receive time and spectrum window monitored by the initiating device.

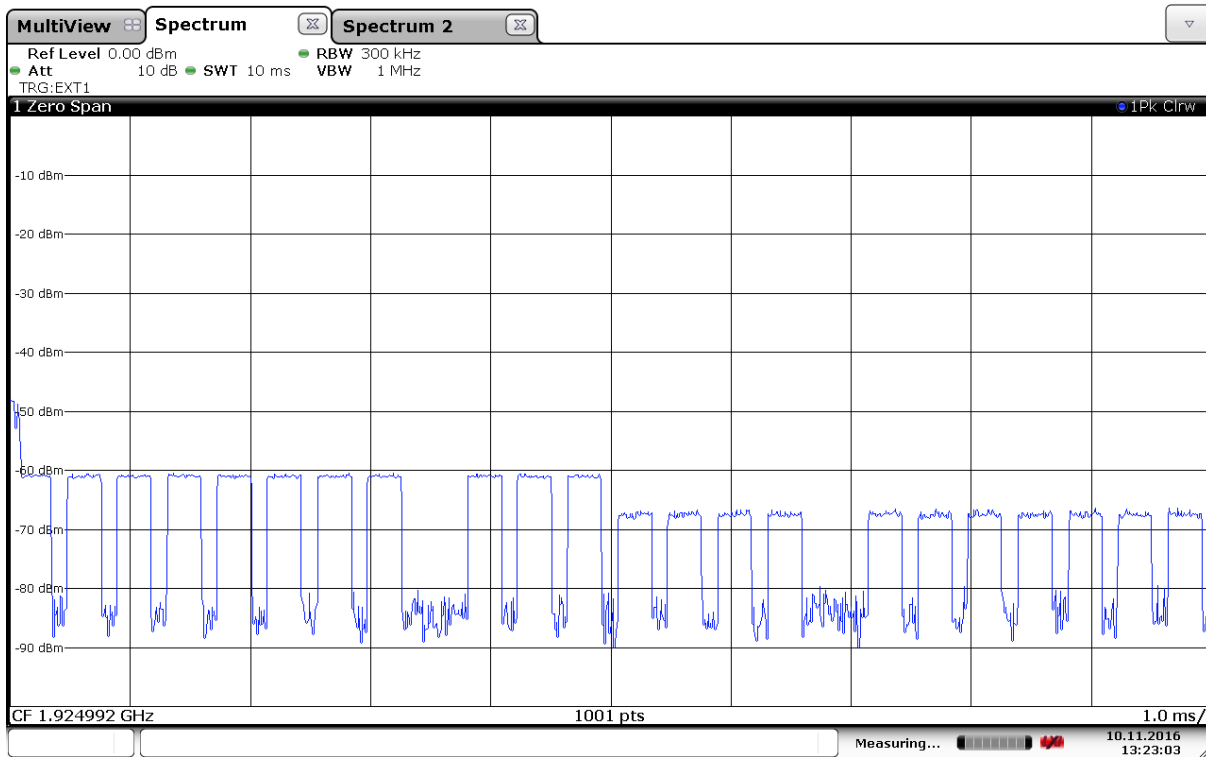

8.3.2c) EUT Transmits on Interference Free RECEIVE Slot, BEFORE

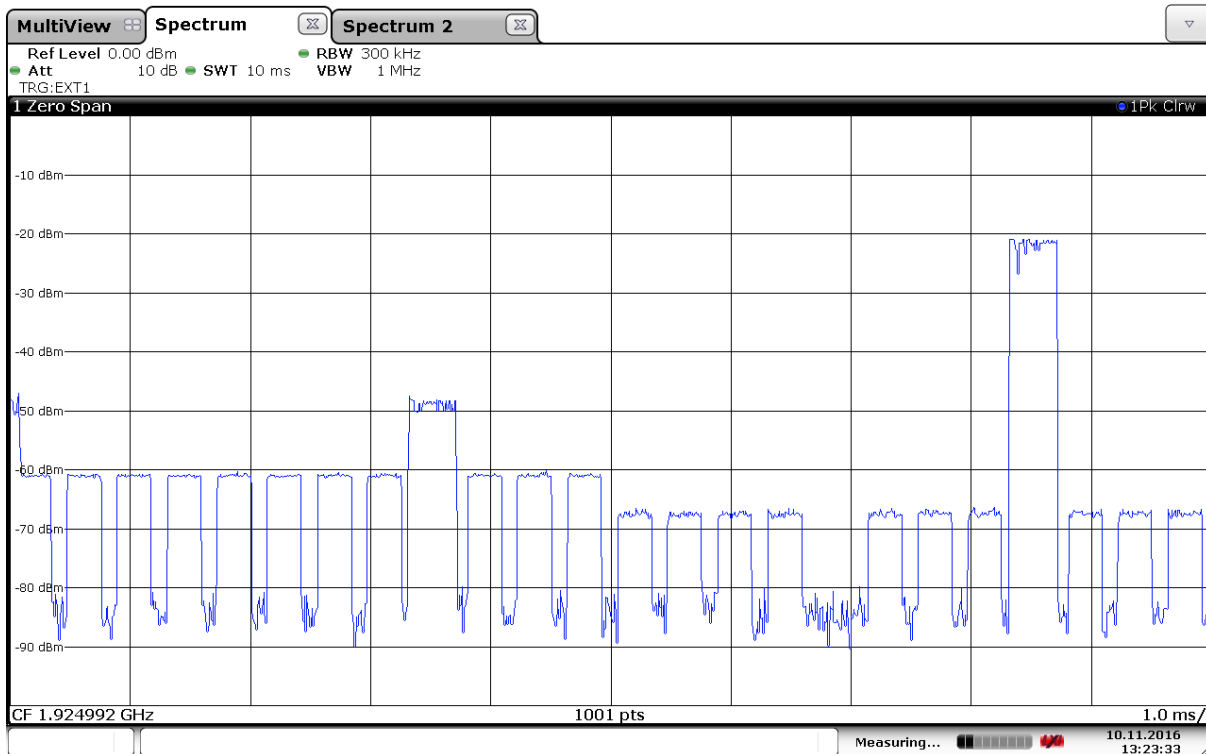

8.3.2c) EUT Transmits on Interference Free RECEIVE Slot, AFTER

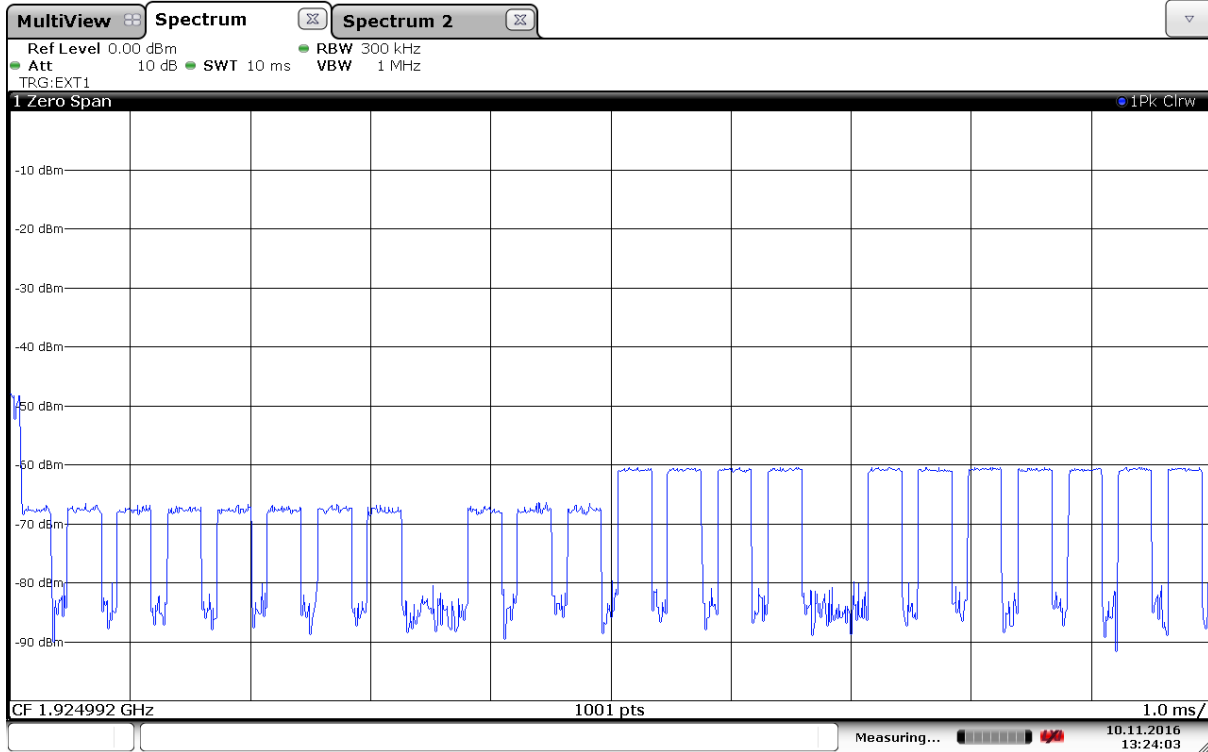

8.3.2e) EUT Transmits on Interference Free TRANSMIT Slot, BEFORE

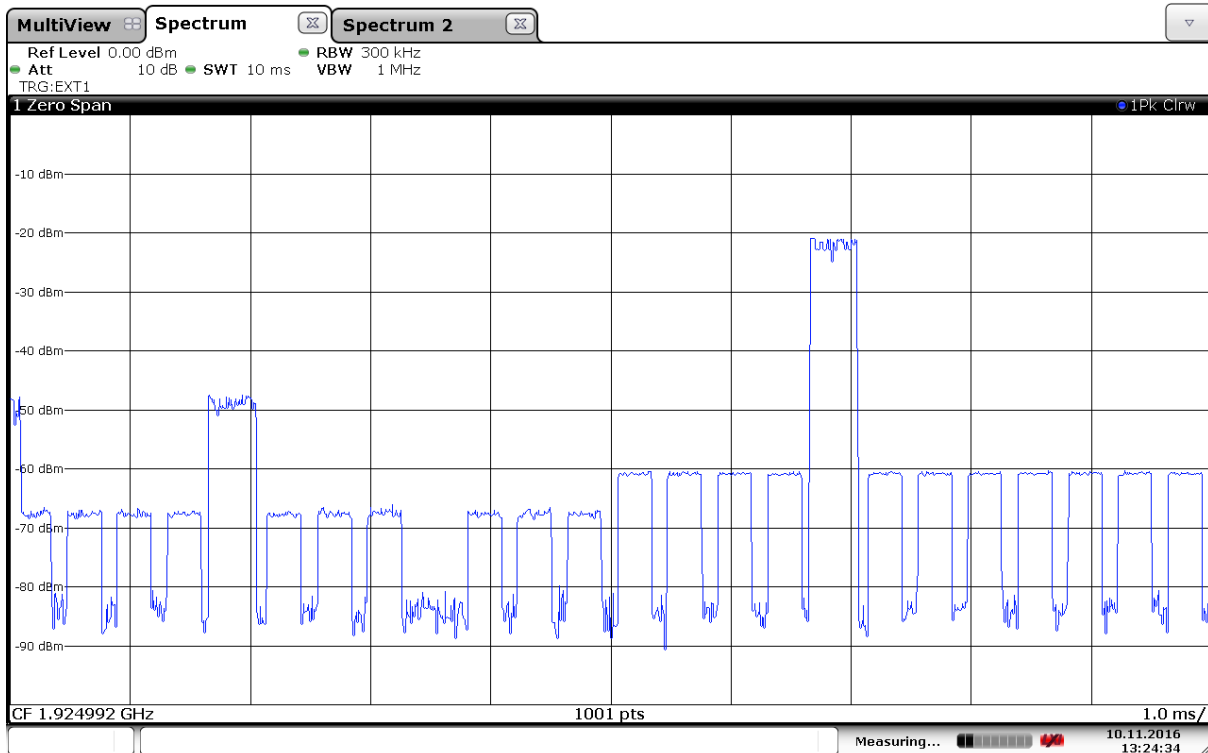

8.3.2e) EUT Transmits on Interference Free TRANSMIT Slot, AFTER

3.21 Alternative Monitoring Interval

Test procedure described in ANSI C63.17 clause 8.4.

This test is required if the EUT implements the provisions of FCC 15.323(c)(11).

Test result:

Not Tested. The tested EUT does not implement this provision. See manufacturers' declaration.

4 Measurement Uncertainty

Measurement Uncertainty Values		
Test Item		Uncertainty
Output Power		±0.5 dB
Power Spectral Density		±0.5 dB
Out of Band Emissions, Conducted (RBW < 100 kHz)	< 3.6 GHz	±0.6 dB
	> 3.6 GHz	±0.9 dB
Spurious Emissions, Radiated	< 1 GHz	±2.5 dB
	> 1 GHz	±2.2 dB
Emission Bandwidth		±4 %
Power Line Conducted Emissions		+2.9 / -4.1 dB
Spectrum Mask Measurements	Frequency	±5 %
	Amplitude	±1.0 dB
Frequency Error		±0.6 ppm
Timing and Jitter Measurements		±2.0 ns
Frame Timing Measurements		±1.4 ppm
Receiver Blocking Levels		±1.0 dB
Temperature Uncertainty		±1 °C

All uncertainty values are expanded standard uncertainty to give a confidence level of 95%, based on coverage factor k=2

5 Test Setups

5.1 Frequency Measurements



Test equipment included: 5, 9, 18

Test Set-up 1

This setup is used for measuring Carrier frequency stability at normal and extreme temperatures.

5.2 Timing Measurements

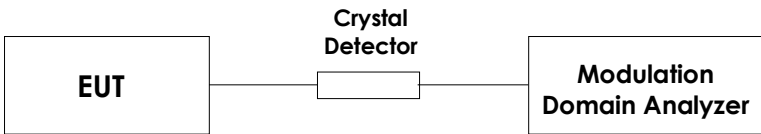

Test equipment included: 5, 7, 9, 18

Test Set-up 2

This setup is used for measuring Frame repetition stability, Frame period and Jitter.

5.3 Conducted Emission Test

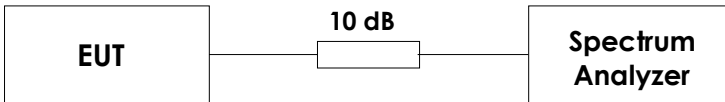

Test equipment included: 1, 2, 9, 18

Test Set-up 3

This setup is used for all conducted emission tests.

5.4 Power Line Conducted Emissions Test

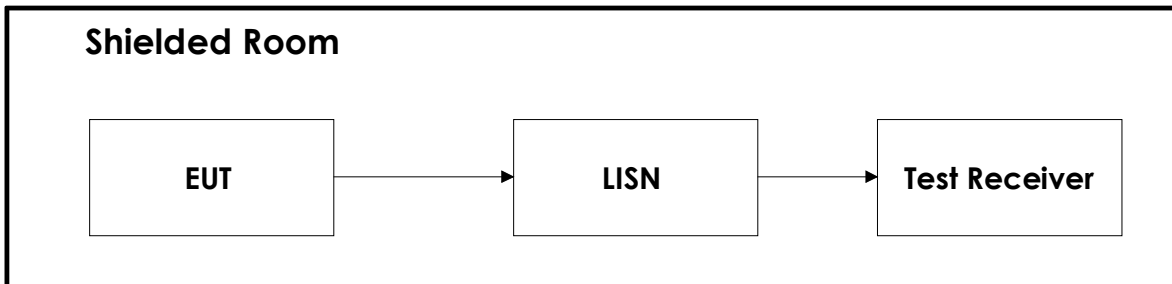

Test equipment: 8, 16, 17, 18

Test Set-Up 5

5.5 Monitoring Tests

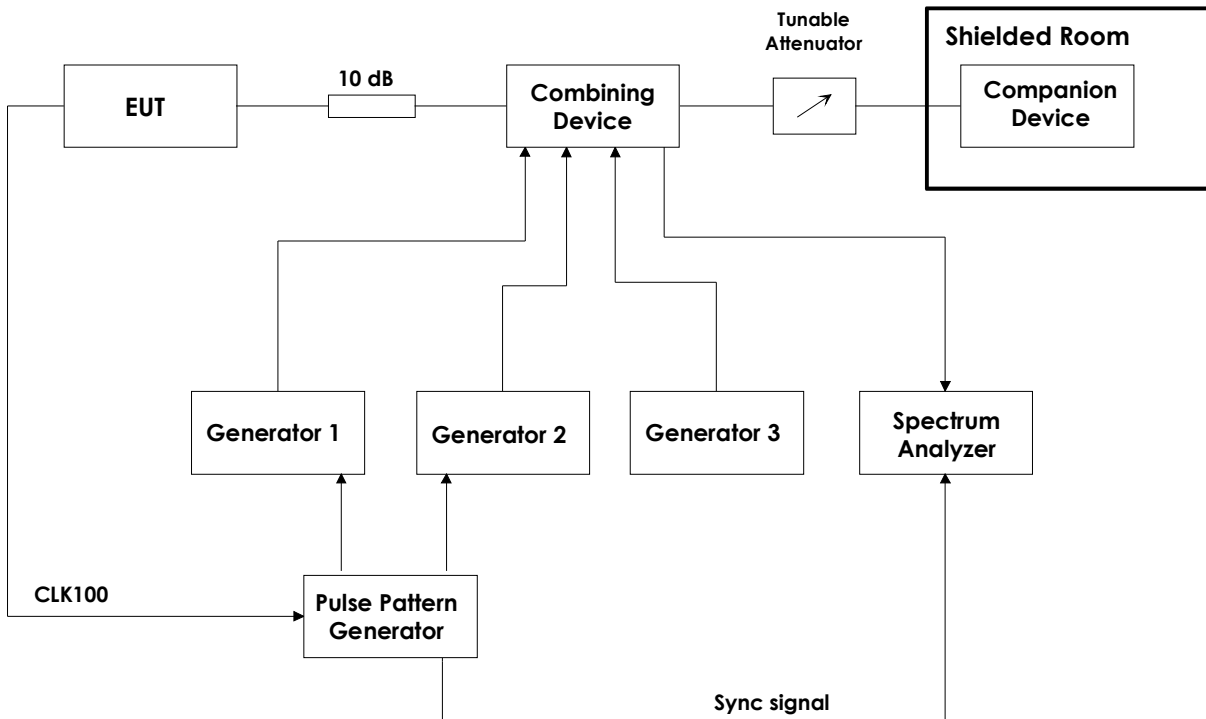

Test equipment: 1, 2, 3, 4, 6, 9, 10, 11, 12, 13, 14, 15, 18, 19, 20, 21, 22, 23

Test Set-Up 6

This test setup is used for all Monitoring and Time and Spectrum Access Procedure tests. The path loss from the signal generators to the EUT is measured with a power meter before the testing is started.

The CLK100 is used to synchronize the Pulse-/ Pattern generator to the start of the DECT frame, this signal always comes from the base station. If the EUT is a DECT Portable Part (i.e. a handset) the CLK100 signal will come from the Companion Device.

The sync signal to the Spectrum Analyzer is the CLK100 signal that is regenerated in the Pulse-/ Pattern Generator, this is used to synchronize the Spectrum Analyzer to the DECT frame when in zero span. The Pulse-/ Pattern Generator is used for tests that require time synchronized pulses or blocking of specific time slots.

6 Test Equipment Used

To facilitate inclusion on each page of the test equipment used for related tests, each item of test equipment and ancillaries are identified (numbered) by the Testhouse.

No.	Model number	Description	Manufacturer	Ref. no.	Cal. date	Cal. Due
1	FSW43	Spectrum Analyzer	Rohde & Schwarz	LR 1690	2016.07	2017.07
2	SME03	Signal generator	Rohde & Schwarz	LR 1238	2015.05	2017.05
3	SMIQ03B	Signal generator	Rohde & Schwarz	LR 1516	2015.05	2017.05
4	SMHU52	Signal generator	Rohde & Schwarz	LR 1240	Cal b4 use	
5	53310A	Modulation Domain Analyzer	Hewlett Packard	LR 1483	2016.01	2018.01
6	81104A	Pulse-/ Pattern Generator	Agilent	LR 1502	2015.05	2017.05
7	8470B	Crystal Detector	Hewlett Packard	LR 1207	N/A	
8	ESC13	EMI Test Receiver	Rohde & Schwarz	N- 4259	2015.08	2017.08
9	6810.17B	Attenuator	Suhner	LR1669	Cal b4 use	
10	745-69	Step Attenuator	Narda	LR 1442	N/A	
11	WE 1506A	Power Splitter	Weinchel	LR 244	Cal b4 use	
12	WE 1506A	Power Splitter	Weinchel	LR 245	Cal b4 use	
13	H-9	Hybrid	Anzac	LR 86	Cal b4 use	
14	H-9	Hybrid	Anzac	LR 257	Cal b4 use	
15	S212DS	RF Switch	Narda	LR 1244	N/A	
16	ESH3-Z5	Two Line V-Network	Rohde & Schwarz	N-3403	2015.07	2017.07
17	ESH3-Z2	Pulse Limiter	Rohde & Schwarz	N-3932	2015.03	2017.03
18	6812B	AC Power Source	Agilent	LR 1515	2015.12	2016.12
19	Model 87 V	Multimeter	Fluke	N-4669	2016.10	2017.10
20	87H35-1	Circulator	Racal-MESL	s.no.: 140	N/A	
21	87H35-1	Circulator	Racal-MESL	s.no.: 141	N/A	
22	87H35-1	Circulator	Racal-MESL	s.no.: 142	N/A	
23	NRP-Z81	Wideband Power Sensor	Rohde Schwarz	LR 1644	2015.11	2016.11
24	VMT 08/64	Climatic chamber	Vötsch	LR 323	2016.03	2017.03

The software listed below has been used for one or more tests.

No.	Manufacturer	Name	Version	Comment
1	Rohde & Schwarz	EMC32	9.26.00	Power-Line Conducted Emissions test software
2	Agilent	Intuitlink Data Capture	2.1.0	Screenshots from HP 53310A

Revision history

Version	Date	Comment	Sign
1.0	2016.11.15	First Edition	FS