

Panasonic®

Operating Instructions

2-in-1 Corded | Cordless Phone

Model No. **KX-TGF880**
KX-TGF882
KX-TGF883

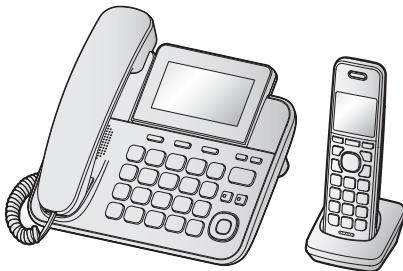

Model shown is KX-TGF880.

Before initial use, see “Getting Started” on page 10.

Thank you for purchasing a Panasonic product.

Please read these operating instructions before using the unit and save them for future reference.

Consulte “Guía Rápida Española”, página 88.

For assistance, visit our Web site: <http://shop.panasonic.com/support> for customers in the U.S.A.

Please register your product: <http://shop.panasonic.com/support>

Table of Contents

Introduction		
Model composition	3	
Accessory information	3	
Graphical symbols for use on equipment and their descriptions	5	
Important Information		
For your safety	6	
Important safety instructions	7	
For best performance	7	
Other information	8	
Specifications	8	
Getting Started		
Setting up	10	
Controls	13	
Display icons/Indicators	14	
Language settings	16	
Date and time	16	
Recording your greeting message	17	
Other settings	17	
Link to Cell		
Link to cell feature	18	
Pairing a cellular phone	18	
Link to cell settings	19	
Making/Answering Calls Using the Handset		
Making cellular calls	22	
Making landline calls	22	
Answering calls	23	
Useful features during a call	23	
Making/Answering Calls Using the Base Unit		
Making cellular calls	27	
Making landline calls	27	
Answering calls	28	
Useful features during a call	28	
Answer by Voice Command		
Answer by voice command	31	
Intercom		
Intercom	32	
Call Block		
Call block	33	
Storing unwanted callers	33	
Enhanced Call Block		
Automated call block	36	
Telemarketing call block	38	
Phonebook		
Phonebook	39	
Speed dial	42	
One-touch dial buttons	43	
Programming		
Menu list	45	
Alarm	53	
Silent mode	53	
Baby monitor	54	
Other programming	56	
Registering a unit	56	
Caller ID Service		
Using Caller ID service	58	
Caller list	58	
Using Bluetooth® Devices		
Copying phonebook from a cellular phone (phonebook transfer)	61	
Link to Cell app	62	
Text message (SMS) alert	63	
Alert settings for your DECT phone	63	
Remote voice assist	63	
Using a Bluetooth headset (optional)	64	
Answering System for Landline		
Answering system for landline	67	
Turning the answering system on/off	67	
Greeting message	67	
Listening to messages	68	
Advanced new message alerting features	69	
Remote operation	71	
Answering system settings	72	
Useful Information		
Voicemail service for landline	74	
Wall mounting	75	
Error messages	76	
Troubleshooting	77	
FCC and other information	85	
Guía Rápida Española		
Guía Rápida Española	88	
Appendix		
Customer services	99	
Limited Warranty (ONLY FOR U.S.A.)	100	
Index		
Index	102	

Model composition

Series	Model No.	Base unit	Handset	
		Part No.	Part No.	Quantity
KX-TGF880 series	KX-TGF880	KX-TGF880	KX-TGFA88	1
	KX-TGF882	KX-TGF880	KX-TGFA88	2
	KX-TGF883	KX-TGF880	KX-TGFA88	3

Accessory information

Supplied accessories

No.	Accessory item/Part number	Quantity		
		KX-TGF880	KX-TGF882	KX-TGF883
①	AC adaptor/PNLV226-0X	1	1	1
②	Telephone line cord/PNJA1186Z	1	1	1
③	Desk stand/Wall mounting adaptor*1 PNKL1077Z1	1	1	1
④	Base battery cover*2/PNYNTGF850BH	1	1	1
⑤	Corded handset/PNLXP1015Y	1	1	1
⑥	Corded handset cord/PQJA212V	1	1	1
⑦	Rechargeable batteries*3	2	4	6
⑧	Handset cover*4/PNYNTGFA88BR	1	2	3
⑨	Belt clip/PNKE2142Z1	1	2	3
⑩	Charger/PNLC1084ZB	1	2	3

*1 The desk stand/wall mounting adaptor comes attached to the base unit.

*2 The base battery cover comes attached to the base unit.

*3 See page 4 for replacement battery information.

*4 The handset cover comes attached to the handset.

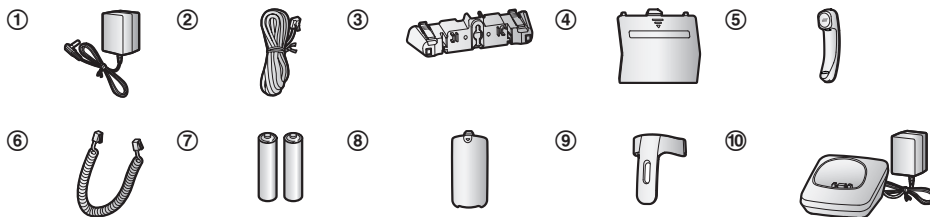

Introduction

Additional/replacement accessories

Please contact your nearest Panasonic dealer for sales information (page 99).

Accessory item	Model number/Specifications
Rechargeable batteries	HHR-4DPA*1 ● To order, please visit http://shop.panasonic.com/support
	Battery type: – Nickel metal hydride (Ni-MH) – 2 x AAA (R03) size for each handset
Headset	KX-TCA93, KX-TCA430
Range extender	KX-TGA407*2
Key detector	KX-TGA20*3

*1 Replacement batteries may have a different capacity from that of the supplied batteries.

*2 By installing this unit, you can extend the range of your phone system to include areas where reception was previously not available. This product can be purchased online. Please visit our Web site: <http://shop.panasonic.com/support>

*3 By registering the key detector (4 max.) to a Panasonic Digital Cordless Phone and attaching it to an easy-to-lose item in advance, you can locate and find the mislaid item to which the key detector is attached. Please visit our Web site: <http://www.panasonic.com/tga20>

Other information



- Design and specifications are subject to change without notice.
- The illustrations in these instructions may vary slightly from the actual product.

Expanding your phone system

Handset (optional): KX-TGFA88	
You can expand your phone system by registering optional handsets (6 max.) to a single base unit. <ul style="list-style-type: none">● Optional handsets may be a different color from that of the supplied handsets.● To order, please visit http://shop.panasonic.com/support	

Bluetooth® devices

You can expand your phone system by pairing the following units to a single base unit.

Your Bluetooth cellular phone *1: 2 max. (for cellular calls: page 18)	
Your Bluetooth headset *1: 1 max. (for a wireless hands-free conversation: page 64)	













Introduction

- *1 Your cellular phone and headset must be Bluetooth wireless technology compatible. For more details and the list of compatible cellular phones, please visit our Web site: <http://shop.panasonic.com/bluetooth-phone>

Trademarks

- The Bluetooth® word mark and logos are registered trademarks owned by Bluetooth SIG, Inc. and any use of such marks by Panasonic Corporation is under license.
- iPhone and Siri are registered trademarks of Apple Inc.
- Android, Gmail, Google Calendar and Google Now are trademarks of Google LLC.
- Facebook and Instagram are trademarks of Facebook, Inc.
- Twitter is a trademark of Twitter, Inc.
- S Voice is a trademark of Samsung Electronics Co., Ltd.
- All other trademarks identified herein are the property of their respective owners.

Graphical symbols for use on equipment and their descriptions

Symbol	Explanation	Symbol	Explanation
	Alternating current (A.C.)		Class II equipment (equipment in which protection against electric shock relies on Double Insulation or Reinforced Insulation)
	Direct current (D.C.)		"ON" (power)
	Protective earth		"OFF" (power)
	Protective bonding earth		Stand-by (power)
	Caution, risk caused by visible radiation		"ON"/"OFF" (power; push-push)
	For indoor use only		Caution, risk of electric shock

Important Information

For your safety

To prevent severe injury and loss of life/property, read this section carefully before using the product to ensure proper and safe operation of your product.

WARNING

Power connection

- Use only the power source marked on the product.
- Do not overload power outlets and extension cords. This can result in the risk of fire or electric shock.
- Completely insert the AC adaptor/power plug into the power outlet. Failure to do so may cause electric shock and/or excessive heat resulting in a fire.
- Regularly remove any dust, etc. from the AC adaptor/power plug by pulling it from the power outlet, then wiping with a dry cloth. Accumulated dust may cause an insulation defect from moisture, etc. resulting in a fire.
- Unplug the product from power outlets if it emits smoke, an abnormal smell, or makes an unusual noise. These conditions can cause fire or electric shock. Confirm that smoke has stopped emitting and contact us at <http://shop.panasonic.com/support>
- Unplug from power outlets and never touch the inside of the product if its casing has been broken open.
- Never touch the plug with wet hands. Danger of electric shock exists.

Installation

- To prevent the risk of fire or electrical shock, do not expose the product to rain or any type of moisture.
- Do not place or use this product near automatically controlled devices such as automatic doors and fire alarms. Radio waves emitted from this product may cause such devices to malfunction resulting in an accident.
- Do not allow the AC adaptor or telephone line cord to be excessively pulled, bent or placed under heavy objects.
- Disconnect the telephone cord before opening battery cover of base unit.

Operating safeguards

- Unplug the product from power outlets before cleaning. Do not use liquid or aerosol cleaners.
- Do not disassemble the product.
- Do not spill liquids (detergents, cleansers, etc.) onto the telephone line cord plug, or allow it to become wet at all. This may cause a fire. If the telephone line cord plug becomes wet, immediately pull it from the telephone wall jack, and do not use.
- Do not excessively pull the corded handset cord from the base unit. This may cause the base unit to fall, resulting in injury.

Medical

- Consult the manufacturer of any personal medical devices, such as pacemakers or hearing aids, to determine if they are adequately shielded from external RF (radio frequency) energy. (The product operates in the frequency range of 1.92 GHz to 1.93 GHz, and the RF transmission power is 115 mW (max.))
- Do not use the product in health care facilities if any regulations posted in the area instruct you not to do so. Hospitals or health care facilities may be using equipment that could be sensitive to external RF energy.

CAUTION

Installation and location

- Never install telephone wiring during an electrical storm.
- Never install telephone line jacks in wet locations unless the jack is specifically designed for wet locations.
- Never touch uninsulated telephone wires or terminals unless the telephone line has been disconnected at the network interface.
- Use caution when installing or modifying telephone lines.
- The AC adaptor is used as the main disconnect device. Ensure that the AC outlet is installed near the product and is easily accessible.
- The product is only use for mounting at heights ≤ 2 m.

Note:

- This height is not guaranteed for product reliability.

Important Information

- To prevent serious injuries due to the product unexpectedly falling, the product must be installed at a height of 1.5 m or lower.
- This product is unable to make calls when:
 - the handset batteries need recharging or have failed.
 - there is a power failure.

Ni-MH rechargeable batteries

- We recommend using the batteries noted on page 4. **USE ONLY rechargeable Ni-MH batteries AAA (R03) size.**
- Do not mix old and new batteries.
- Do not open or mutilate the batteries. Released electrolyte from the batteries is corrosive and may cause burns or injury to the eyes or skin. The electrolyte is toxic and may be harmful if swallowed.
- Exercise care when handling the batteries. Do not allow conductive materials such as rings, bracelets, or keys to touch the batteries, otherwise a short circuit may cause the batteries and/or the conductive material to overheat and cause burns.
- Charge the batteries provided with or identified for use with this product only, in accordance with the instructions and limitations specified in this manual.
- Only use a compatible base unit (or charger) to charge the batteries. Do not tamper with the base unit (or charger). Failure to follow these instructions may cause the batteries to swell or explode.
- Avoid the use in the following conditions
 - High or low extreme temperatures during use, storage or transportation.
 - Replacement of a battery with an incorrect type that can defeat a safeguard.
 - Disposal of a battery into fire or a hot oven, or mechanically crushing or cutting of a battery, that can result in an explosion.
 - Extremely high temperature and/or extremely low air pressure that can result in an explosion or the leakage of flammable liquid or gas.

Attention:



A nickel metal hydride battery that is recyclable powers the product you have purchased. Please call 1-800-8-BATTERY (1-800-822-8837) for information on how to recycle this battery.

Note when using alkaline batteries for power backup

- The batteries should be used correctly, otherwise the unit may be damaged due to battery leakage.
- Do not charge, short-circuit, disassemble, or heat the batteries.
- Do not dispose of batteries in a fire.
- Remove all the batteries when replacing.
- Do not mix old, new or different types of batteries.
- It is recommended that batteries are replaced annually.

Important safety instructions

When using your product, basic safety precautions should always be followed to reduce the risk of fire, electric shock, and injury to persons, including the following:

1. Do not use this product near water for example, near a bathtub, washbowl, kitchen sink, or laundry tub, in a wet basement or near a swimming pool.
2. Avoid using a telephone (other than a cordless type) during an electrical storm. There may be a remote risk of electric shock from lightning.
3. Do not use the telephone to report a gas leak in the vicinity of the leak.
4. Use only the power cord and batteries indicated in this manual. Do not dispose of batteries in a fire. They may explode. Check with local codes for possible special disposal instructions.

SAVE THESE INSTRUCTIONS

For best performance

Base unit location/avoiding noise

The base unit and other compatible Panasonic units use radio waves to communicate with each other.

Important Information

- For maximum coverage and noise-free communications, place your base unit:
 - at a convenient, high, and central location with no obstructions between the cordless handset and base unit in an indoor environment.
 - away from electronic appliances such as TVs, radios, personal computers, wireless devices, or other phones.
 - facing away from radio frequency transmitters, such as external antennas of mobile phone cell stations. (Avoid putting the base unit on a bay window or near a window.)
- Coverage and voice quality depends on the local environmental conditions.
- If the reception for a base unit location is not satisfactory, move the base unit to another location for better reception.

Environment

- Keep the product away from electrical noise generating devices, such as fluorescent lamps and motors.
- The product should be kept free from excessive smoke, dust, high temperature, and vibration.
- The product should not be exposed to direct sunlight.
- Do not place heavy objects on top of the product.
- When you leave the product unused for a long period of time, unplug the product from the power outlet.
- The product should be kept away from heat sources such as heating devices, cooking appliances, etc. It should not be placed in rooms where the temperature is less than 0 °C (32 °F) or greater than 40 °C (104 °F). Damp basements should also be avoided.
- The maximum calling distance may be shortened when the product is used in the following places: Near obstacles such as hills, tunnels, underground, near metal objects such as wire fences, etc.
- Operating the product near electrical appliances may cause interference. Move away from the electrical appliances.

Routine care

- **Wipe the outer surface of the product with a soft moist cloth.**
- Do not use benzine, thinner, or any abrasive powder.

Other information

- The applied nameplate is located at the bottom or rear of the product.
- ⚠ **CAUTION:** Risk of explosion if battery is replaced by an incorrect type. Dispose of used batteries according to the instructions.

Notice for product disposal, transfer, or return

- This product can store your private/confidential information. To protect your privacy/confidentiality, we recommend that you erase information such as phonebook or caller list entries from the memory before you dispose of, transfer, or return the product.

Notice

- This product is designed for use in the United States of America. Sale or use of this product in other countries may violate local laws.
- Cet appareil est conçu pour être utilisé aux États-Unis d'Amérique. La vente ou l'emploi de cet appareil dans certains autres pays peut constituer une infraction à la législation locale.
- Este producto está diseñado para usarse en los Estados Unidos de América. La venta o el empleo de este producto en ciertos países puede constituir violación de la legislación local.
- 本產品專為美國使用而設。若在其他國家銷售或使用，可能會違反當地法例。
- この製品は、日本国外での使用を目的として設計されており、日本国内での使用は法律違反となります。従って、当社では日本国内においては原則として修理などのサービスは致しかねます。

Specifications

- **Standard:**
 - Bluetooth wireless technology 2.1
 - Hands Free Profile (HFP)
 - Headset Profile (HSP)
 - Phone Book Access Profile (PBAP)
 - Object Push Profile (OPP)
 - Serial Port Profile (SPP)
 - Message Access Profile (MAP)
- **Frequency range:**
 - 1.92 GHz to 1.93 GHz (DECT)
 - 2.402 GHz to 2.48 GHz (Bluetooth)
- **RF transmission power:**
 - 115 mW (max.)
- **Power source:**
 - 120 V AC, 60 Hz

Important Information

- **Power consumption:**
 - Base unit:**
 - Standby: 0.8 W
 - Maximum: 3.0 W
 - Charger:**
 - Standby: 0.1 W
 - Maximum: 1.8 W
- **Operating conditions:**
 - 0 °C – 40 °C (32 °F – 104 °F), 20 % – 80 %
relative air humidity (dry)

Getting Started

Setting up

Connections

- If you do not connect the telephone line cord and use only cellular lines, set the cellular line only mode to use this unit more conveniently (page 20).

■ Base unit

- ① Connect the AC adaptor to the unit by pressing the plug firmly.
- ② Connect the telephone line cord to the unit until you hear a click.
- ③ Fasten the AC adaptor cord and the telephone line cord by hooking it.
- ④ Connect the AC adaptor to the power outlet.
- ⑤ Connect the telephone line cord to the single-line telephone jack (RJ11C) until you hear a click.
- ⑥ A DSL/ADSL filter (not supplied) is required if you have a DSL/ADSL service.
- ⑦ Connect the corded handset cord to the corded handset and the base unit until you hear a click.

Note:

- Use only the supplied Panasonic AC adaptor PNLV226.

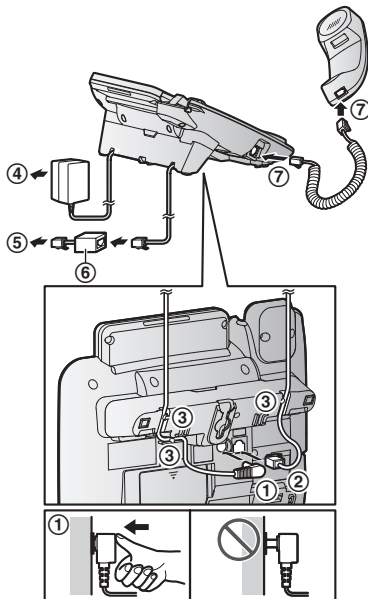

- Follow the directions on the display to set up the unit.

■ Charger

- ① Connect the AC adaptor to the power outlet.

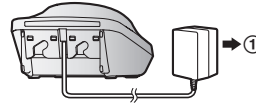

Handset battery installation

- USE ONLY rechargeable Ni-MH batteries AAA (R03) size (A).
- Do NOT use alkaline/manganese/Ni-Cd batteries.
- Confirm correct polarities (+, -).

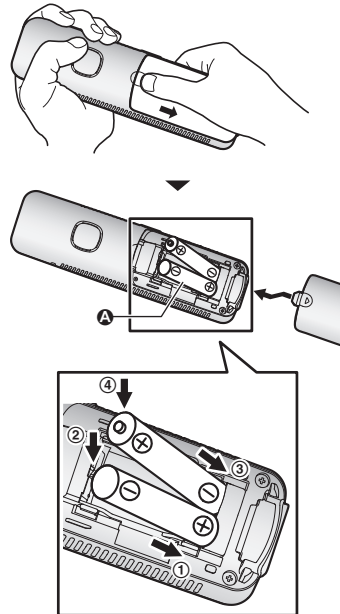

- Follow the directions on the display to set up the unit.

Removing the battery

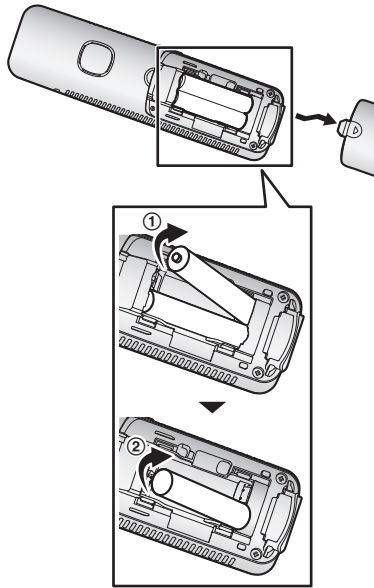

Note:

- At the end of each call, the unit displays a large icon for a few moments to indicate the battery level.
- You can set the unit to play a voice announcement when the battery is low or needs charging. (page 17)

Ni-MH battery performance (supplied batteries)

Operation	Operating time
In continuous use	10 hours max.*1
Not in use (standby)	5 days max.*1

*1 If eco mode is on except when using link to cell function.

Note:

- Actual battery performance depends on usage and ambient environment.

Handset battery charging

Charge for about 7 hours.

- Confirm “Charging” is displayed (A).
- When the batteries are fully charged, “Fully charged” is displayed.



Base unit battery installation (for power backup)

You can insert 2 AAA (R03) batteries (not supplied) into the base unit that will power the unit temporarily in the event of a power failure.

Important:

- The following batteries can be used with the base unit:
 - Rechargeable Ni-MH batteries*1, *2 (including the batteries used in your handset(s))
 - Standard (non-rechargeable) alkaline batteries*3
- Do NOT use manganese batteries.
- Confirm correct polarities (⊕, ⊖).

*1 The base unit can fully charge Ni-MH batteries in about 15 hours.

*2 We recommend using HHR-4DPA batteries (page 4).

*3 Only insert alkaline batteries once a power failure occurs. Remove the alkaline batteries when power is restored.

Handset battery level

Icon	Battery level
	High
	Medium
	Low
	Needs charging.
	Empty

Getting Started

- 1 Disconnect the telephone line cord (1).
- 2 Open the battery cover (2).
- 3 Install the batteries in the battery compartment (3).
- 4 Close the cover, then reconnect the telephone line cord (4).

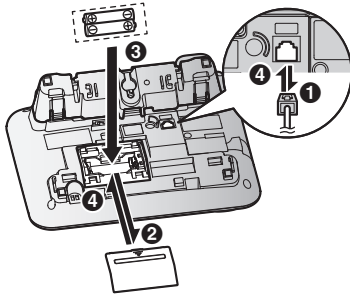

Note:

- If your phone service provider requires additional devices in order to make and receive calls, such as a modem, you may still not be able to make and receive calls even if the base unit's power backup feature is functioning.

Base unit battery status when a power failure occurs

Icon	Battery status
	Power backup mode is on.
	Battery power is low.*1

- *1 If begins flashing on the base unit, replace the batteries with new ones as soon as possible. If you replace Ni-MH batteries with alkaline batteries, insert the Ni-MH batteries into the base unit again after the power is restored so that they will be recharged.

Battery saving mode setting

This feature allows the base unit to reduce its power consumption by limiting the available functions and therefore extend battery life during a power failure.

The following settings are available:

- “On”: The unit will work as a standard telephone. Only the corded handset can be used to make and receive calls. (You cannot use the base unit display, phonebook,

one-touch dial, answering system, speakerphone, Bluetooth functions, etc.)

The base unit display is blank.

- “Off” (default): You can use the full functions of the base unit, but battery life is not extended. The brightness level for the base unit display is lowered.

Base unit

- 1 [MENU]#150
- 2 [↕]: Select the desired setting.
- 3 [SAVE] → [EXIT]

Note:

- Once the battery saving mode is set to “On”, the unit rings with the volume level 1 even if the ringer volume for the base unit is set to “Off” to let you know an incoming call is being received.

Ni-MH battery performance (optional batteries) when operating on backup battery power

Operation	Saving mode	
	Off	On
In continuous use	1.5 hours max.	5 hours max.
Not in use (standby)	2 hours max.	6 hours max.

Note:

- Battery performance depends on the type of batteries.
- Actual battery performance depends on usage and ambient environment.

Note when setting up

Note for connections

- The AC adaptor must remain connected at all times. (It is normal for the adaptor to feel warm during use.)
- The AC adaptor should be connected to a vertically oriented or floor-mounted AC outlet. Do not connect the AC adaptor to a horizontally oriented AC outlet that faces the floor, such as an AC outlet installed on a ceiling or under a table, as the weight of the adaptor may cause it to become disconnected.

Note for Ni-MH battery installation



- **Handset:** Use the supplied rechargeable batteries.
- **Handset/Base unit:** For replacement, we recommend using the Panasonic rechargeable batteries noted on page 4, 7.

Note for battery charging





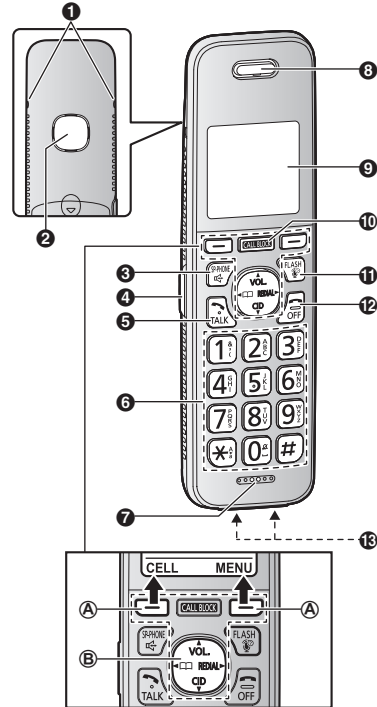

- It is normal for the handset to feel warm during charging.
- Clean the charge contacts of the handset and charger with a soft and dry cloth once a month. Before cleaning the unit, disconnect from power outlets and any telephone line cords. Clean more often if the unit is exposed to grease, dust, or high humidity.

Intelligent eco mode

This feature automatically reduces handset power consumption by suppressing handset transmission power when the handset is close to the base unit.

- When this feature is activated,  is displayed.
- Even though this feature is activated,  is not displayed:
 - during a cellular call.
 - when answer by voice command is turned on (page 31).

Controls**Handset**

- ❶ Belt clip holes
- ❷ Speaker
- ❸  (SP-PHONE: Speakerphone)
- ❹ Headset jack
- ❺  (TALK)
- ❻ Dial keypad
 - : Temporary tone dialing
 - : (X) Ringer off
- ❼ Microphone
- ❽ Receiver
- ❾ Display
- ❿ [CALL BLOCK]
- ⓫  (Assist) [FLASH]
 - You can use the handset to operate the voice recognition feature of your cellular phone by pressing . (page 63)
- ⓫ [OFF] 
- ⓬ Charge contacts

Getting Started

■ Control type

Ⓐ Soft keys

By pressing a soft key, you can select the feature shown directly above it on the display. After a cellular phone is paired, **[CELL]** is displayed.

Ⓑ Navigator key

- **[▲]**, **[▼]**, **[◀]**, or **[▶]**: Scroll through various lists and items.
- **VOL.** (Volume: **[▲]** or **[▼]**): Adjust the receiver or speaker volume while talking.
- **[◀]** : View the phonebook entry.
- **[▶]** : View the redial list.
- **[▼]** : View the caller list.

Base unit

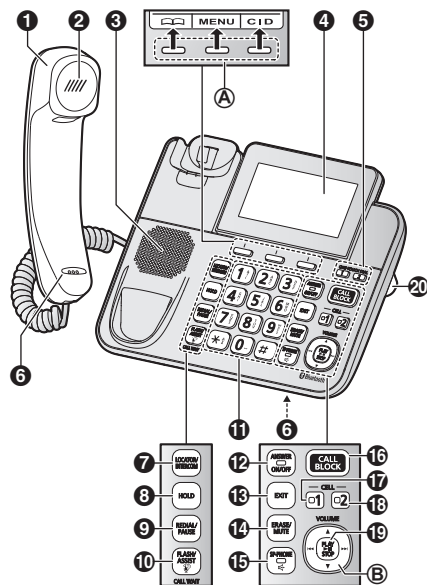

- 1** Corded handset
- 2** Receiver
- 3** Speaker
- 4** Display
 - The display can be moved back and forth to select the desired angle.
- 5** **ONE-TOUCH DIAL** buttons
- 6** Microphone
- 7** **[LOCATOR]** **[INTERCOM]**
 - You can locate a misplaced handset by pressing **[LOCATOR]**.
- 8** **[HOLD]**
- 9** **[REDIAL]** **[PAUSE]**

10 **(ASSIST)** **[FLASH]** **[CALL WAIT]**

- You can use the base unit to operate the voice recognition feature of your cellular phone by pressing . (page 63)

11 Dial keypad

- : Temporary tone dialing

12 **[ANSWER ON/OFF]**

ANSWER ON/OFF indicator

13 **[EXIT]**

14 **[ERASE]** **[MUTE]**

15 **(SP-PHONE: Speakerphone)**

SP-PHONE indicator

16 **[CALL BLOCK]**

17 **[CELL 1]**

CELL 1 indicator

18 **[CELL 2]**

CELL 2 indicator

19 **[▶■]** **(PLAY/STOP)**

Message indicator

20 **Desk stand/Wall mounting adaptor**

- The adaptor is a removable attachment for desk stand or wall mounting use (page 75).

■ Control type

Ⓐ Soft keys

By pressing a soft key, you can select the feature shown directly above it on the display.



















Ⓑ Navigator key

- **[▲]**, **[▼]**, **[◀]**, or **[▶]**: Scroll through various lists and items.
- **VOLUME** (**[▲]** or **[▼]**): Adjust the receiver or speaker volume while talking.
- **[◀◀]/[▶▶]**: Repeat/skip messages during playback.

Display icons/Indicators

Handset display items

Item	Meaning
	Within base unit range
	Out of base unit range
	The landline is in use. <ul style="list-style-type: none"> • When flashing slowly: The call is on hold. • When flashing rapidly: An incoming call is now being received.

Item	Meaning
 ¹	<ul style="list-style-type: none"> – A cellular line is in use.*¹ <ul style="list-style-type: none"> • When flashing slowly: The cellular call is on hold. • When flashing rapidly: A cellular call is being received. – The remote voice assist feature is in use.*¹
	Eco mode is on.* ² (page 13)
 ²	<p>A cellular phone is connected.*¹ Ready to make/receive cellular calls.</p> <ul style="list-style-type: none"> • When turned off: A cellular phone is not connected to the base unit. (page 20)
 ¹  ²	<ul style="list-style-type: none"> – A cellular call is in progress on that line. – The cellular line is selected for the setting.
	Noise reduction is set. (page 24)
	Equalizer is set. (page 24)
	Speakerphone is on. (page 22)
 ¹	Ringer volume is off.* ³ (page 23, 47, 49)
	Silent mode is on. (page 53)
	Call sharing mode is off. (page 51)
	Alarm is on. (page 53)
	Handset number
	Battery level
	Answer by voice command is on. (page 31)
	Blocked call (page 59)
	<ul style="list-style-type: none"> – Automated call block is set to “Block”. (page 36) – Blocked automated call (page 59)
	Baby monitor is activated. The name/number displayed next to the icon indicates the monitoring unit. (page 54)
In use	Answering system is being used by another unit.











Item	Meaning
Cell11 in use	Someone is using the corresponding line.
Cell12 in use	
Line in use	

*¹ Corresponding lines (1, 2: cellular line) are indicated next to the item.





*² During a cellular call, the item is not displayed even though the feature is activated.

*³ Corresponding lines (1, 2: cellular line, L: landline) are indicated next to the item. If all lines are turned off, no line is indicated.

Base unit display items

Item	Meaning
	<p>The landline is in use.</p> <ul style="list-style-type: none"> • When flashing slowly: The call is on hold. • When flashing rapidly: An incoming call is now being received.
 ¹	<ul style="list-style-type: none"> – A cellular line is in use.*¹ <ul style="list-style-type: none"> • When flashing slowly: The cellular call is on hold. • When flashing rapidly: A cellular call is being received. – The remote voice assist feature is in use.*¹
 ¹	Ringer volume is off.* ² (page 27, 47, 49)
	Silent mode is on. (page 53)
	Call sharing mode is off. (page 51)
	“Greeting only” is selected. Caller messages are not recorded. (page 73)
 ¹  ²	<ul style="list-style-type: none"> – A cellular call is in progress on that line. – The cellular line is selected for the setting.
	Power backup mode is on. (page 12)
	Answer by voice command is on. (page 31)

Getting Started

Item	Meaning
	Blocked call (page 59)
	<ul style="list-style-type: none"> Automated call block is set to "Block". (page 36) Blocked automated call (page 59)
	A Bluetooth headset is connected to the base unit. It is ready for use.
	A Bluetooth headset is in use.
In use	Answering system is being used by the handset.
Cell1 in use	Someone is using the corresponding line.
Cell2 in use	
Line in use	

*1 Corresponding lines (1, 2: cellular line) are indicated next to the item.

*2 Corresponding lines (1, 2: cellular line, L: landline) are indicated next to the item. If all lines are turned off, no line is indicated.

CELL indicators on the base unit

The CELL indicators show each cellular line status.

Status	Meaning
On	A cellular phone is connected. Ready to make/receive cellular calls.
Flashing slowly	<ul style="list-style-type: none"> The cellular line is in use. Phonebook entries are being copied from a cellular phone. (page 61) The base unit is searching for the paired cellular phone. The base unit is pairing a cellular phone. A cellular call is on hold. The remote voice assist feature is in use (page 63).
Flashing rapidly	A cellular call is being received.
Light off	<ul style="list-style-type: none"> A cellular phone is not paired to the base unit. A cellular phone is not connected to the base unit. (page 20)

Language settings

Display language

Handset / Base unit

- [MENU]#110
- [↕]: Select the desired setting. → [SAVE]
- Proceed with the operation for your unit.
Handset: [OFF]
Base unit: [EXIT]

Note for handset:

- The language selected will also be used for the low battery alert announcement (page 17).

Voice announcement language

You can select the language used for the following features.

- Answering system guidance
- Automated call block guidance
- Telemarketing call block guidance
- Talking Caller ID
- Answer by voice command announcement
- 2-way recording announcement
- Application (App) alert announcement
- Text message (SMS) alert announcement

Handset / Base unit

- [MENU]#112
- [↕]: Select the desired setting. → [SAVE]
- Proceed with the operation for your unit.
Handset: [OFF]
Base unit: [EXIT]

Date and time

Handset / Base unit

- [MENU]#101
- Enter the current month, date, and year by selecting 2 digits for each.
Example: July 12, 2020
07 12 20
- [OK]

- 4 Enter the current hour and minute (12-hour clock format) by selecting 2 digits for each.
Example: 9:30
[0][9][3][0]
- 5 Proceed with the operation for your unit.
Handset: [X]: Select "AM" or "PM".
Base unit: [AM/PM]: Select "AM" or "PM".
- 6 [SAVE]
- 7 Proceed with the operation for your unit.
Handset: [OFF]
Base unit: [EXIT]

Note:

- When English is selected as the display language, 12-hour clock format is used. When Spanish is selected, 24-hour clock format is used.

Recording your greeting message

You can record your own greeting message instead of using a pre-recorded greeting message. See page 67 for details.

Handset / Base unit

- 1 [MENU][#][3][0][2]
- 2 [↕]: "Yes" → [SELECT]
- 3 Record a greeting message. → [STOP]
- 4 Proceed with the operation for your unit.
Handset: [OFF]
Base unit: [EXIT]

Other settings

Dialing mode

If you cannot make calls, change this setting according to your telephone line service. The default setting is "Tone".

"Tone": For tone dial service.

"Pulse": For rotary/pulse dial service.

Handset / Base unit

- 1 [MENU][#][1][2][0]
- 2 [↕]: Select the desired setting. → [SAVE]

- 3 Proceed with the operation for your unit.
Handset: [OFF]
Base unit: [EXIT]

Low battery alert

This feature plays a voice announcement when the handset battery is low or needs charging. When this feature is turned on, the unit notifies you as follows.

- **When you end a call:**

- The unit plays a voice announcement when the battery is low or needs charging.

- **When the handset is in standby mode:**

- If the battery is low or needs charging, the unit plays a voice announcement at the selected interval up to 3 times.

Note for handset:

- At the end of each call, the unit displays a large icon for a few moments to indicate the battery level.

Setting low battery alert

To turn this feature on, select the desired announcement interval, or select "off" to turn this feature off. The default setting is "Every hour".

Handset

- 1 [MENU][#][1][7][6]
- 2 [↕]: Select the desired setting. → [SAVE]
→ [OFF]

Link to Cell

Link to cell feature

You can connect your base unit and cellular phone using Bluetooth wireless technology, so that you can make or answer cellular calls using your phone system. This allows you to:

- use the unit to talk on cellular calls even if some areas of your home have poor cellular reception, simply by placing your cellular phone in an area with good reception.
- talk on cellular calls even if your cellular phone is in your pocket or bag.
- enjoy cordless cellular calls even if your cellular phone plugged in and charging.

Important:

- Your cellular phone must support the Hands Free Profile (HFP) specification.
- You may pair 2 cellular phones and 1 Bluetooth headset.
- The unit cannot be used to talk on 2 cellular lines at the same time.
- Only 1 Bluetooth device can be used with the unit at a time*1.
- Locate your cellular phone near the base unit. If the cellular phone is too close to the base unit during a cellular call, you may hear noise. For best performance, we recommend placing the cellular phone between 0.6 m to 3 m (2 feet to 10 feet) away from the base unit.

*1 You cannot use a Bluetooth headset to talk on a cellular line.

Pairing a cellular phone

Important:

- For more details and the list of compatible cellular phones, please visit our Web site: <http://shop.panasonic.com/bluetooth-phone>
- Before pairing a Bluetooth enabled cellular phone to the base unit, make sure that no other Bluetooth device such as a Bluetooth headset is connected to your cellular phone.

1 Base unit:

Press and hold **[CELL 1]** or **[CELL 2]** for about 5 seconds.

- After the corresponding CELL indicator on the base unit starts flashing, the rest of the procedure must be completed within 5 minutes.

2 Your cellular phone:

While the corresponding CELL indicator is flashing, follow the instructions of your cellular phone to enter the pairing mode.

- Depending on your cellular phone, it may ask you to enter the Bluetooth PIN (default: "0000"). If your cellular phone shows PassKey confirmation on its display, follow the directions to proceed.

3 Base unit:

Wait until a long beep sounds.

- It may take more than 10 seconds to complete pairing.
- When the corresponding CELL indicator lights up, the cellular phone is connected to the base unit. You are ready to make cellular calls.

Note:

- If the cellular phone has already paired to the base unit, its pairing is overwritten.
- Make sure that your cellular phone is set to connect to this product automatically. Refer to your cellular phone's operating instructions.
- Make sure you cancel your cellular phone's current pairing if you want to pair it to the other line (page 18).
- The default setting for the alert feature is "On", so when you pair your cellular phone to the base unit, this feature may be activated (page 63). (This depends on the version and type of cellular phone you are using.)

Unpairing a cellular phone

You can cancel the pairing of a cellular phone that is stored in the base unit.

Handset / Base unit

1 For CELL 1: **[MENU]#6111**

For CELL 2: **[MENU]#6112**

2 **[↕]: "Yes" → [SELECT]**

- When the cellular phone is unpaired, the CELL indicator is turned off.

3 Proceed with the operation for your unit.

Handset: [OFF]

Base unit: [EXIT]

Link to cell settings

Selecting which unit receives cellular calls

You can select which unit rings and receives calls for a cellular line. When “**All**” is selected, all handsets and the base unit ring.

Handset / Base unit

- For CELL 1: **[MENU]** **#** **6** **2** **7** **1**
For CELL 2: **[MENU]** **#** **6** **2** **7** **2**
- [↕]**: Select the desired handset or “**All**”. → **[SAVE]**
- Proceed with the operation for your unit.
Handset: [OFF]
Base unit: [EXIT]

Note:

- When you select a specific handset to receive calls for a cellular line:
 - other handsets cannot answer the calls.
 - the base unit can answer the calls even though it does not ring. However, you can make the base unit ring by adjusting the base unit ringer volume (page 47).
- When you change to “**All**” from another setting, the base unit ringer volume also returns to the lowest level even if the ringer volume was changed.
- The units selected with this setting have the alert feature (page 63) applied to them.

Ring as cell mode

Once this feature is turned on, the handset and base unit ring using the same ringer tone as your cellular phone.

The following settings are available:

- “**OFF**”: Turn this feature off to use the ringer tones of the handset and base unit. Caller information is announced depending on the Talking Caller ID setting (page 49).
- “**On (with Talking CID)**” (default): The handset and base unit use your cellular phone’s ringer tone. Caller information is announced even if the Talking Caller ID is turned off.
- “**On (without Talking CID)**”: The handset and base unit use your cellular phone’s ringer tone. Caller information is not announced even if the Talking Caller ID is turned on.

Important:

- To use this feature, your cellular phone must support Bluetooth in-band ringtone. Refer to your cellular phone’s operating instructions.

Handset / Base unit

- For CELL 1: **[MENU]** **#** **6** **1** **4** **1**
For CELL 2: **[MENU]** **#** **6** **1** **4** **2**
- [↕]**: Select the desired setting. → **[SAVE]**
- Proceed with the operation for your unit.
Handset: [OFF]
Base unit: [EXIT]

Note:

- The units use the preset ringer tones instead of your cellular phone’s ringer tone when a cellular call is being received if:
 - your cellular phone is in silent mode (depending on your cellular phone).
 - the base unit is in use.
 - 2 units are sharing a landline call.
 - answer by voice command feature is turned on (page 31).
- If your cellular phone is in silent mode with “**On (with Talking CID)**” set, the unit announces caller information even when Talking Caller ID is turned off (page 49).

To use the handset ringer tone instead of your cellular phone’s ringer tone

Select “**Off**” in step 2, “Ring as cell mode”, page 19.

To change the handset ringer tone for a cellular line, see page 47.

Auto connection to the Bluetooth devices (cellular phones)

After pairing, your Bluetooth devices are connected to the base unit. If you move the Bluetooth devices out of base unit range, the Bluetooth devices are disconnected from the base unit. This feature allows the base unit to try to reconnect the Bluetooth devices at regular intervals when it returns within base unit range. You can set the interval. The default setting is “**1 min**”.

Important:

- Only 1 Bluetooth device can be used with the unit at a time, and the base unit loses its connection from other Bluetooth devices. To

Link to Cell

automatically resume the connection to Bluetooth devices, leave the auto connection on.

- Some cellular phones lose connection after usage, please check the specifications of your cellular phone for more details.

Handset / Base unit

- 1 **[MENU]** **#** **6** **3** **2**
- 2 **[↕]**: Select the desired setting. → **[SAVE]**
- 3 Proceed with the operation for your unit.
Handset: [OFF]
Base unit: [EXIT]

Note:

- Some cellular phones may ask you if you accept the connection requirement from the base unit. In that case, select “**OFF**” in step 2. Check the specifications of your cellular phone.

Connecting/disconnecting the cellular phone manually

If you will not be using the paired cellular phone's link to cell feature temporarily (for example, you do not want the unit to ring when your cellular line receives a call), you can disconnect your cellular phone from the base unit. If you want to use it again, reconnect the cellular phone to the base unit.

Note:

- After you disconnect a paired cellular phone from the base unit manually, it will automatically be connected to the base unit in 30 minutes. If you do not use the link to cell feature anymore, unpair the cellular phone (page 18).
- A disconnected cellular phone is not unpaired from the base unit, so pairing it to the base unit again is unnecessary.

Handset / Base unit

- 1 **To connect/disconnect:**
For CELL 1: **[MENU]** **#** **6** **2** **5** **1**
For CELL 2: **[MENU]** **#** **6** **2** **5** **2**
 - A long beep sounds.
- 2 Proceed with the operation for your unit.
Handset: [OFF]
Base unit: [EXIT]

Cellular line only mode (If you do not use the landline)

If you do not use the landline, we recommend setting the unit to the cellular line only mode. The default setting is “**OFF**”.

Important:

- If you turn on the “**Cell line only mode**”, disconnect the telephone line cord from the base unit. Otherwise the “**Cell line only mode**” cannot be activated.

Handset / Base unit

- 1 **[MENU]** **#** **1** **5** **7**
- 2 **To turn on:**
[↕]: “**On**” → **[SELECT]** → **[↕]**: “**Yes**” → **[SELECT]**
To turn off:
[↕]: “**OFF**” → **[SELECT]**

Note:

- Once you set this mode, you can use the following buttons to make cellular calls:
 - for the handset, press **[↶]** or **[↷]** instead of **[CELL]** (page 22).
 - for the base unit, lift the corded handset or press **[↷]** without pressing **[CELL 1]** or **[CELL 2]** set for the cellular line selection (page 21, 27).
- Once you set this mode, the following features cannot be used:
 - Landline features (Incoming ringer volume, incoming ringer tone, dial mode, flash time, and line mode)
 - Answering system (page 67)
Messages cannot be received.
 - Voicemail features (page 74)
- After this mode is turned on or off, the base unit reboots.
 - Bluetooth connections from cellular phones or Bluetooth headset are disconnected. If the auto connection is turned on (page 19), the cellular phones are reconnected.
 - **☒** will be displayed on the handset momentarily. The handset can be used once **☒** is displayed.

When you use the landline again

Before connecting the telephone line to the base unit, select “**OFF**” in step 2, “**Cellular line only mode (If you do not use the landline)**”, page 20.

Cellular line selection

This feature determines which cellular line is selected to make cellular calls when:

- you press **[CELL]** on the handset.
- you press **[↶]** or **[↷]** on the handset while the cellular line only mode is turned on.
- you lift the corded handset or press **[↷]** on the base unit while the cellular line only mode is turned on.

The following settings are available:

- “**Manual**” (handset only: default): You can select the desired cellular line when making a call.
- “**Cellphone 1**”^{*1} (base unit default): CELL 1 is selected.
- “**Cellphone 2**”^{*1}: CELL 2 is selected.

Handset / Base unit

- 1 **[MENU][#][6][3][4]**
- 2 **[↕]**: Select the desired setting. → **[SAVE]**
- 3 Proceed with the operation for your unit.
Handset: [OFF]
Base unit: [EXIT]

*1 After the Bluetooth device is paired, the device name is displayed.

Storing your area code (for dialing only a 7-digit phone number to make a local call)

You need to add your area code when making cellular calls to a phone number in your area. Once you store your area code, it is automatically added to the beginning of the 7-digit phone number when making cellular calls.

Handset / Base unit

- 1 **[MENU][#][6][3][3]**
- 2 Enter the 3-digit area code.
 - To correct a digit, press **[CLEAR]**.
- 3 **[SAVE]**
- 4 Proceed with the operation for your unit.
Handset: [OFF]
Base unit: [EXIT]

Changing the Bluetooth PIN (Personal Identification Number)

The PIN is used to pair cellular phones to the base unit. The default PIN is “0000”. To prevent unauthorized access to this product, we recommend that you change the PIN, and keep it confidential.

Important:

- Please make note of your new PIN. The unit does not reveal the PIN to you. If you forget your PIN, see page 84.

Handset / Base unit

- 1 **[MENU][#][6][1][9]**
 - If the unit prompts you to enter the old PIN (when the default has been changed), enter the current 4-digit PIN. → **[OK]**
- 2 Enter the new 4-digit PIN. → **[OK]**
- 3 Enter the new 4-digit PIN again. → **[SAVE]**
- 4 Proceed with the operation for your unit.
Handset: [OFF]
Base unit: [EXIT]

Making/Answering Calls Using the Handset

Making cellular calls

Important:

- The unit cannot be used to talk on 2 cellular lines at the same time.
- Only 1 Bluetooth device can be used with the unit at a time*1.
- Before making calls, confirm that the corresponding  on the handset is displayed (page 15).

*1 You cannot use a Bluetooth headset to talk on a cellular line.

- 1 Lift the handset and then dial the phone number.
 - To correct a digit, press **[CLEAR]**.
- 2 **[CELL]**
 - The unit starts dialing immediately in the following situations.
 - Only 1 cellular phone is paired.
 - A specific line is set to make cellular calls (page 21).

3 **[↕]**: Select the desired cellular phone. → **[SELECT]**

4 When you finish talking, press **[OFF]** or place the handset on the charger.

Note:

- To switch to the speaker, press **[🔊]**.
To switch back to the receiver, press **[🔊]/[📞]**.
- In step 1, you can store the dialed phone number to the phonebook by pressing and holding **[◀] □□** for a few seconds.

Adjusting the receiver or speaker volume

Press **[▲]** or **[▼]** repeatedly while talking.

Note:

- The receiver*1 or speaker volume you set is kept for each line (landline and cellular lines).

*1 If the receiver volume is set to level 5 (max.), it will be changed to level 4 in the next call.

Making a call using the redial list

The last 5 phone numbers dialed are stored in the redial list (48 digits max. each).

- 1 **[▶] REDIAL**
- 2 **[↕]**: Select the desired entry.

3 **[CELL]**

- The unit starts dialing immediately in the following situations.
 - Only 1 cellular phone is paired.
 - A specific line is set to make cellular calls (page 21).

4 **[↕]**: Select the desired cellular phone. → **[SELECT]**

Erasing a number in the redial list

■ When a cellular phone is paired:

- 1 **[▶] REDIAL**
- 2 **[↕]**: Select the desired entry. → **[MENU]**
- 3 **[↕]**: “Erase” → **[SELECT]**
- 4 **[↕]**: “Yes” → **[SELECT]** → **[OFF]**

■ When a cellular phone is not paired:

- 1 **[▶] REDIAL**
- 2 **[↕]**: Select the desired entry. → **[ERASE]**
- 3 **[↕]**: “Yes” → **[SELECT]** → **[OFF]**

Making landline calls

- 1 Lift the handset and then dial the phone number.
 - To correct a digit, press **[CLEAR]**.
- 2 Press **[📞]** to make the call.
 - To make the call using the speakerphone, press **[🔊]**.
- 3 When you finish talking, press **[OFF]** or place the handset on the charger.

Note:

- To switch to the speaker, press **[🔊]**.
To switch back to the receiver, press **[🔊]/[📞]**.
- In step 1, you can store the dialed phone number to the phonebook by pressing and holding **[◀] □□** for a few seconds.

Making a call using the redial list

The last 5 phone numbers dialed are stored in the redial list (48 digits max. each).

- 1 **[▶] REDIAL**
- 2 **[↕]**: Select the desired entry.
- 3 Press **[📞]** or **[🔊]**.

Pause (for PBX/long distance service users)

A pause is sometimes required when making calls using a PBX or long distance service. When storing a calling card access number and/or PIN in the phonebook, a pause is also needed (page 42).

Example: If you need to dial the line access number "9" when making outside calls with a PBX:

- 1 **[9]** → **[▲]** (Pause)
- 2 Dial the phone number. → **[↶]**

Note:

- A 3.5 second pause is inserted each time **[▲]** (Pause) is pressed.

Answering calls

- 1 Lift the handset and then press **[↶]** or **[↷]** when the unit rings.
 - To answer a cellular call, you can also press **[CELL]**.
- 2 When you finish talking, press **[OFF]** or place the handset on the charger.

Any key answer: You can answer the call by pressing any dial key (except **[0]** key).

Auto talk: You can answer calls simply by lifting the handset (page 51).

Temporary handset ringer off: You can turn the ringer off temporarily by pressing **[⌘]** (left soft key).

Adjusting the handset ringer volume

Press **[▲]** or **[▼]** repeatedly to select the desired volume while ringing.

- To turn the ringer off, press **[▼]** repeatedly.

Note:

- You can adjust the ringer volume for cellular call and landline call by programming (page 47, 49).
- The ringer volume you set is kept for each line (landline and cellular lines).

One-touch ringer off for the handset

Press and hold **[0]** (**[⌘]**) until the unit beeps to turn the ringer off. While the ringer is turned off, the handset will not ring for calls.

- You can turn the ringer on again by pressing and holding **[0]** (**[⌘]**) until the unit beeps.

Useful features during a call

Hold

- 1 Press **[MENU]** during an outside call.
- 2 **[↕]**: "Hold" → **[SELECT]**
- 3 **To release hold on the cellular line:**
Press **[CELL]**.^{*1}
 - Another handset user can take the call by pressing **[CELL]**.^{*1}
 - ^{*1} If you press **[CELL]** and the selection list is displayed, select the desired cellular line and press **[SELECT]**.
 - The base unit user can take the call by pressing **[CELL 1]** or **[CELL 2]**. → Lift the corded handset.

To release hold on the landline:

Press **[↶]**.

- Another handset user can take the call by pressing **[↶]**.
- The base unit user can take the call by lifting the corded handset.

Note:

- After holding for 10 minutes, the call is disconnected.

Mute

- 1 Press **[MUTE]** during a call.
- 2 To return to the call, press **[MUTE]**.

Note:

- **[MUTE]** is a soft key visible on the display during a call.

Flash for landline calls

[FLASH] allows you to use the special features of your host PBX such as transferring an extension call, or accessing optional telephone services.

Note:

- To change the flash time, see page 51.

Making/Answering Calls Using the Handset

For call waiting or Call Waiting Caller ID service users

To use call waiting or Call Waiting Caller ID, you must first subscribe with your phone service provider.

This feature allows you to receive calls while you are already talking on the phone. If you receive a call while on the phone, you will hear a call waiting tone.

If you subscribe to both Caller ID and Call Waiting with Caller ID services, the 2nd caller's information is displayed on the unit that is in use after you hear the call waiting tone.

- 1 Press **[FLASH]** to answer the 2nd call.
- 2 To switch between calls, press **[FLASH]**.

Note:

- Please contact your phone service provider for details and availability of this service in your area.

Temporary tone dialing for landline calls (for rotary/pulse service users)

Press **[*]** before entering access numbers which require tone dialing.

Handset noise reduction

This feature allows you to hear the voice of the person you are talking to more clearly, by reducing the surrounding noise coming from the other party's telephone.

- 1 Press **[MENU]** while talking.
- 2 **[↕]**: "Noise reduction on" or "Noise reduction off" → **[SELECT]**

Note:

- The setting you made is kept for each line (landline and cellular lines).
The default settings are as follows:
 - for landline: "Noise reduction off"
 - for cellular lines: "Noise reduction on"
- Depending on the environment where this handset is being used, this feature may not be effective.
- This feature is not available while using the speakerphone.

Handset equalizer

This feature clarifies the voice of the person you are talking to, producing a more natural-sounding voice that is easier to hear and understand.

- 1 Press **[MENU]** while talking.
- 2 **[↕]**: "Equalizer" → **[SELECT]**
- 3 **[↕]**: Select the desired setting.
- 4 Press **[OK]** to exit.

Note:

- The setting you made is kept for each line (landline and cellular lines).
- Depending on the condition and quality of your telephone line, this feature may emphasize existing line noise. If it becomes difficult to hear, select another setting.
- This feature is not available while using the speakerphone.
- When both the "Equalizer" setting and noise reduction are activated, **NR** is shown on the display.

Recording a telephone conversation (2-way recording)

This unit can record a telephone conversations during landline calls.

- 1 Press **[MENU]** during a landline call.
- 2 **[↕]**: "2 way recording" → **[SELECT]**
 - The total recordable time is displayed.
 - The unit announces to both parties that the recording will start.
 - The unit starts recording.
- 3 To stop recording, press **[MENU]** → **[↕]**: "Stop recording" → **[SELECT]**
 - You can continue the conversation with the outside caller.

Note:

- When recording is completed:
 - The total number of recordings will be added to the number of messages in the answering system.
 - **[▶■]** on the base unit flashes.
 - "New message" is displayed.
 - Audible message alert sounds on base unit (page 69).
- To listen to the recorded conversation, refer "Listening to messages", page 68.

Making/Answering Calls Using the Handset

- 2 way recording is not available during conference calls.
- The recording will end in the following situations:
 - When **[FLASH]** is pressed.
 - When the hold or intercom feature is used.
- When memory is/becomes full:
 - “**Memory full**” is shown on the display.
 - An error tone sounds.

Call share

You can join an existing outside call.

■ While another unit is on a cellular call:

- 1 To join the conversation, press **[CELL]**.
 - You can join the conversation in the following situations.
 - Only 1 cellular phone is paired.
 - A specific line is set to make cellular calls (page 21).
- 2 **[↕]**: Select the corresponding cellular phone. → **[SELECT]**

■ While another unit is on a landline call:

To join the conversation, press **[↩]**.

Note:

- A maximum of 3 parties (including 1 outside party) can join a conversation using 2 extensions. (**3-way conference**)
- To prevent other users from joining your conversations with outside callers, turn call sharing mode off (page 51).
- A 2nd party cannot join an outside call that is being recorded (page 24).

Transferring calls, conference calls

Outside calls can be transferred or a conference call with an outside party can be made:

- between handsets
 - between a handset and the base unit
- 1 During an outside call, press **[MENU]**.
 - 2 **[↕]**: “**Intercom**” → **[SELECT]**
 - 3 **[↕]**: Select the desired unit. → **[SELECT]**
 - If you select “**Voice paging**”, the call will be switched from the ear-receiver mode to the speakerphone mode.
 - 4 Wait for the paged party to answer.
 - If the paged party does not answer, press **[BACK]** to return to the outside call.

5 To complete the transfer:

Press **[OFF]**.

To establish a conference call:

[MENU] → **[↕]**: “**Conference**” → **[SELECT]**

- To leave the conference, press **[OFF]**. The other 2 parties can continue the conversation.
- To put the outside call on hold: **[MENU]** → **[↕]**: “**Hold**” → **[SELECT]**
To resume the conference: **[MENU]** → **[↕]**: “**Conference**” → **[SELECT]**
- To cancel the conference: **[MENU]** → **[↕]**: “**Stop conference**” → **[SELECT]**
You can continue the conversation with the outside caller.

Transferring a cellular call between the handset and a cellular phone

Transferring a cellular call from the handset to a cellular phone

- 1 Press **[MENU]** during a cellular call.
- 2 **[↕]**: “**Transfer to cell**” → **[SELECT]**
 - The cellular call is transferred to the cellular phone.

Note:

- Depending on your cellular phone type, you may need to set the cellular phone to be ready to talk before transferring. For example, if your cellular phone has a top cover, open it beforehand.

Transferring a cellular call from a cellular phone to the handset

During a conversation using a cellular phone, the call cannot be transferred to the handset by the cellular phone. Perform the following with the handset.

- 1 During a conversation using a cellular phone, press **[CELL]**.
 - The call is transferred to the handset in the following situations.
 - Only 1 cellular phone is paired.
 - A specific line is set to make cellular calls (page 21).
- 2 **[↕]**: Select the corresponding cellular phone. → **[SELECT]**
 - The call is transferred to the handset.

Making/Answering Calls Using the Handset

Answering a 2nd call

If you receive a call while talking on the phone, the interrupt tone sounds (page 49) and the 2nd caller's information is displayed if you subscribe to Caller ID service (page 58).

Answering a cellular call during a landline call

- 1 Press **[MENU]** during a landline call.
- 2 **[↕]**: "Hold" → **[SELECT]**
- 3 **To answer the 2nd call:**
Press **[CELL]** while the 2nd call is being received.
- 4 To hang up the 2nd call and return to the 1st call (landline call), press **[OFF]**, then press **[↶]**.

Answering a landline call during a cellular call

- 1 Press **[MENU]** during a cellular call.
 - 2 **[↕]**: "Hold" → **[SELECT]**
 - 3 **To answer the 2nd call:**
Press **[↶]** while the 2nd call is being received.
 - 4 To hang up the 2nd call and return to the 1st call (cellular call), press **[OFF]**, then press **[CELL]**.^{*1}
- *1 If you press **[CELL]** and the selection list is displayed, select the desired cellular line and press **[SELECT]**.

Making cellular calls

Important:

- The unit cannot be used to talk on 2 cellular lines at the same time.
- Only 1 Bluetooth device can be used with the unit at a time*1.
- Before making calls, confirm that the corresponding CELL indicator on the base unit lights up (page 16).

*1 You cannot use a Bluetooth headset to talk on a cellular line.

- 1 Dial the phone number.
 - To correct a digit, press **[CLEAR]**.
- 2 Press **[CELL 1]** or **[CELL 2]**.
- 3 Lift the corded handset.
- 4 When you finish talking, place the corded handset on the cradle.

Note:

- While on a call, you can switch from the base unit to the cordless handset as follows. The call sharing mode must be on (page 51).
 - ① **Handset:** **[CELL]***1 → **[↕]**: Select the desired cellular phone. → **[SELECT]**
 - *1 The call is taken when:
 - Only 1 cellular phone is paired.
 - A specific line is set to make cellular calls (page 21).
 - ② **Base unit:** Place the corded handset on the cradle. When the speakerphone is used, press **[📞]**.
- During a conversation with the corded handset, you can switch to the speakerphone by pressing **[📞]**, then place the corded handset on the cradle.

Adjusting the receiver or speaker volume

Press **[▲]** or **[▼]** repeatedly while talking.

Note:

- The receiver or speaker volume you set is kept for each line (landline and cellular lines).

Making a call using the redial list

The last 10 phone numbers dialed are stored in the redial list (48 digits max. each).

- 1 **[REDIAL]**
- 2 **[↕]**: Select the desired entry.

- 3 Press **[CELL 1]** or **[CELL 2]**, then lift the corded handset.

Erasing a number in the redial list

- 1 **[REDIAL]**
- 2 **[↕]**: Select the desired entry. → **[ERASE]**
- 3 **[↕]**: "Yes" → **[SELECT]** → **[EXIT]**

Making landline calls

- 1 Dial the phone number.
 - To correct a digit, press **[CLEAR]**.
- 2 Lift the corded handset.
 - To make the call using the speakerphone, press **[📞]**.
- 3 When you finish talking, place the corded handset on the cradle.

Note:

- You can also dial the phone number after lifting the corded handset.
- To switch to the speaker, press **[📞]**. To switch back to the receiver, lift the corded handset.
- While on a call, you can switch from the base unit to the cordless handset as follows. The call sharing mode must be on (page 51).
 - ① **Handset:** Press **[📞]**.
 - ② **Base unit:** Place the corded handset on the cradle. When the speakerphone is used, press **[📞]**.

Making a call using the redial list

The last 10 phone numbers dialed are stored in the redial list (48 digits max. each).

- 1 **[REDIAL]**
- 2 **[↕]**: Select the desired entry.
- 3 Lift the corded handset, or press **[📞]**.

Pause (for PBX/long distance service users)

A pause is sometimes required when making calls using a PBX or long distance service. When storing a calling card access number and/or PIN in the phonebook, a pause is also needed (page 42).

Example: If you need to dial the line access number "9" when making outside calls with a PBX:

- 1 **[9]** → **[PAUSE]**

Making/Answering Calls Using the Base Unit

- 2 Dial the phone number.
- 3 Lift the corded handset.

Note:

- A 3.5 second pause is inserted each time [PAUSE] is pressed.

Answering calls

When a landline call is being received, the SP-PHONE indicator flashes rapidly.

When a cellular call is being received, the CELL indicator and SP-PHONE indicator flash rapidly.

- 1 Lift the corded handset or press [📞] when the unit rings.
 - You can also answer the cellular call by pressing [CELL 1] or [CELL 2].
- 2 When you finish talking, place the corded handset on the cradle. When the speakerphone is used, press [📞].

Temporary ringer off: You can turn the ringer off temporarily by pressing [🔕].

Adjusting the base unit ringer volume

Press [▲] or [▼] repeatedly to select the desired volume while ringing.

- To turn the ringer off, press and hold [▼] until the unit beeps.

Note:

- You can adjust the ringer volume for cellular call and landline call by programming (page 47, 49).
- The ringer volume you set is kept for each line (landline and cellular lines).

Useful features during a call

Hold

- 1 Press [HOLD] during an outside call.
 - If you are using the corded handset, you can place it on the cradle.
- 2 **To release hold on the cellular line:** Press [CELL 1] or [CELL 2], then lift the corded handset.
 - A handset user can take the call: [CELL]*1 → [📞]: Select the corresponding cellular phone. → [SELECT]

*1 The call is taken in the following situations.

- Only 1 cellular phone is paired.
- A specific line is set to make cellular calls (page 21).

To release hold on the landline:

Lift the corded handset.

- A handset user can take the call by pressing [📞].

Note:

- While a landline call is on hold, the SP-PHONE indicator flashes.
- After holding for 10 minutes, the call is disconnected.

Mute

- 1 Press [MUTE] during a call.
 - When the speakerphone is used, the SP-PHONE indicator flashes.
- 2 To return to the call, press [MUTE].

Flash for landline calls

[FLASH] allows you to use the special features of your host PBX such as transferring an extension call, or accessing optional telephone services.

Note:

- To change the flash time, see page 51.

For call waiting or Call Waiting Caller ID service users

To use call waiting or Call Waiting Caller ID, you must first subscribe with your phone service provider.

This feature allows you to receive calls while you are already talking on the phone. If you receive a call while on the phone, you will hear a call waiting tone.

If you subscribe to both Caller ID and Call Waiting with Caller ID services, the 2nd caller's information is displayed on the unit that is in use after you hear the call waiting tone.

- 1 Press [CALL WAIT] to answer the 2nd call.
- 2 To switch between calls, press [CALL WAIT].

Note:

- Please contact your phone service provider for details and availability of this service in your area.

Making/Answering Calls Using the Base Unit

Temporary tone dialing for landline calls (for rotary/pulse service users)

Press **[X]** before entering access numbers which require tone dialing.

Recording a telephone conversation (2-way recording)

This unit can record a telephone conversations during landline calls.

- 1 Press **[RECORD]** during a landline call.
 - The total recordable time is displayed.
 - The unit announces to both parties that the recording will start.
 - The unit starts recording.
- 2 To stop recording, press **[STOP]**.
 - You can continue the conversation with the outside caller.

Note:

- When recording is completed:
 - The total number of recordings will be added to the number of messages in the answering system.
 - **[▶■]** on the base unit flashes.
 - “New message” is displayed.
 - Audible message alert sounds (page 69).
- To listen to the recorded conversation, refer “Listening to messages”, page 68.
- 2 way recording is not available during conference calls.
- The recording will end in the following situations:
 - When **[FLASH]** is pressed.
 - When the hold or intercom feature is used.
- When memory is/becomes full:
 - “Memory full” is shown on the display.
 - An error tone sounds.

Call share

You can join an existing outside call.

To select the line that is being used for the call:

- for a cellular line, press **[CELL 1]** or **[CELL 2]**, then lift the corded handset.
- for the landline, lift the corded handset.

Note:

- A maximum of 3 parties (including 1 outside party) can join a conversation using 2 extensions. **(3-way conference)**
- To prevent other users from joining your conversations with outside callers, turn call sharing mode off (page 51).
- A 2nd party cannot join an outside call that is being recorded (page 29).

Transferring calls, conference calls

Outside calls can be transferred or a conference call with an outside party can be made between a handset and the base unit.

- 1 During an outside call, press **[INTERCOM]**.
When 2 or more handsets are registered:
[▲▼]: Select the desired unit. → **[SELECT]**
 - To page all handsets, press **[0]** or wait for a few seconds.
- 2 Wait for the paged party to answer.
 - If paged party does not answer, press **[INTERCOM]** to return to the outside call.
- 3 **To complete the transfer:**
Place the corded handset on the cradle.
 - The outside call is being routed to the handset.**To establish a conference call:**
Press **[CONF]**.
 - To leave the conference, place the corded handset on the cradle. The other 2 parties can continue the conversation.
 - To put the outside call on hold, press **[HOLD]**. To resume the conference, press **[CONF]**.

Transferring a cellular call between the base unit and a cellular phone

Transferring a cellular call from the base unit to a cellular phone

- 1 Press **[MENU]** during a cellular call.
- 2 **[▲▼]:** “Transfer to cell” → **[SELECT]**
 - The cellular call is transferred to the cellular phone.
- 3 Place the corded handset on the cradle.

Note:

- You can also press and hold **[CELL 1]** or **[CELL 2]** to transfer a cellular call instead of steps 1 and 2.
- Depending on your cellular phone type, you may need to set the cellular phone to be ready to talk before transferring. For example, if your cellular phone has a top cover, open it beforehand.

Transferring a cellular call from a cellular phone to the base unit

During a conversation using a cellular phone, press **[CELL 1]** or **[CELL 2]**, then lift the corded handset.

- The cellular call is transferred to the base unit.

Making/Answering Calls Using the Base Unit

Answering a 2nd call

If you receive a call while talking on the phone, the interrupt tone sounds (page 49) and the 2nd caller's information is displayed if you subscribe to Caller ID service (page 58).

Answering a cellular call during a landline call

- 1** Press [**HOLD**] during a landline call.
- 2 To answer the 2nd call:**
Press [**CELL 1**] or [**CELL 2**].
- 3** To hang up the 2nd call and return to the 1st call (landline call), place the corded handset on the cradle, then lift it again.

Answering a landline call during a cellular call

- 1** Press [**HOLD**] during a cellular call.
- 2 To answer the 2nd call:**
Place the corded handset on the cradle, then lift it again.
- 3** To hang up the 2nd call and return to the 1st call (cellular call), place the corded handset on the cradle, then press [**CELL 1**] or [**CELL 2**] and lift the corded handset.

Answer by voice command

This feature allows you to answer incoming calls automatically with your voice. When your voice is detected, answered calls will automatically be directed to the speakerphone mode. The default setting is "Off".

Important:

- Before using this feature, we recommend that you test it and adjust the voice command sensitivity as needed.
- For best performance, answer the call within a range of 50 cm (20 inches) to 1 m (40 inches).
- Once this feature is turned on, the Talking Caller ID will be activated automatically. To turn off the Talking Caller ID feature, see page 49.
- Ambient noise (dog barking, TV sound, etc.) may cause the unit to answer an incoming call.
- When this feature is used, the unit disconnects the call automatically after 3 minutes. You may hear a warning tone and the unit may prompt you to press **[X]** to continue talking 1 minute before disconnecting.
- Once you press any key during a call, the call is continued.

Note:

- When a call is manually answered using a unit, voice detection will end, and the answer by voice command feature stops operating.
- This feature is not available while baby monitor is set to "On" (page 54).
- The configured settings are common for all lines (landline and cellular lines).

Turning answer by voice command on/off

Handset

- 1 Press and hold **[X]** for about 2 seconds.
- 2 **[↕]**: Select the desired setting. → **[SAVE]**
 - If you selected "Off", go to step 4 to exit.
- 3 **[YES]** → The unit will display and announce the voice command guidance.
 - We recommend answering calls as demonstrated.
 - There must be a 1 second pause between the two phrases.
- 4 **To stop:** Press **[STOP]**.
To playback: Press **[YES]**.
To exit: Press **[OFF]**.

Note:

- If you wish to turn on answer by voice command feature, select "Tone 1" to "Tone 5" as your ringer tone (page 47, 49). If another ringer tone is selected, the unit will automatically use the default ringer tones (Landline: "Tone 1", CELL 1: "Tone 2", CELL 2: "Tone 4").

Answer by voice command sensitivity

You can adjust the sensitivity of the answer by voice command. Increase or decrease the sensitivity to adjust the sound level needed to trigger the answer by voice command feature.

Handset

- 1 **[MENU]** **#** **1** **0** **7**
- 2 **[↕]**: Select the desired setting. → **[SAVE]**
→ **[OFF]**

Answering calls

Handset / Base unit

- 1 When the unit rings, speak clearly as demonstrated by the voice guidance. Refer to step 3, "Turning answer by voice command on/off", page 31.
- 2 When you finish talking, press **[OFF]** on the handset or **[M]** on the base unit.

Note for base unit:

- In step 1, you need to answer a call while the base unit is not ringing or not announcing caller information.

Intercom

Intercom

Intercom calls can be made:

- between handsets
- between a handset and the base unit

Note:

- When paging unit(s), the paged unit(s) beeps for 1 minute.
- If you receive an outside call while talking on the intercom, the interrupt tone sounds (page 49).
 - **Handset:** To finish intercom, press **[OFF]**. To answer the call, press **[↶]**.
 - **Base unit:** To finish intercom, place the corded handset on the cradle. If the speakerphone is used, press **[📞]**. To answer the call, lift the corded handset. If the speakerphone is used, press **[📞]**.
- To change the handset ringer volume and ringer tone for intercom, see page 49.

Making an intercom call

Handset

- 1 **[MENU]** → **[↕]**: “Intercom” → **[SELECT]**
- 2 **[↕]**: Select the desired unit or “Voice paging”. → **[SELECT]**
 - If you select “Voice paging”, speak into the microphone after the beep. Your voice will be heard using the speakers of the base unit and all handsets, until a paged party answers your page or until you press **[OFF]**. After the other party answers, the speakerphone mode is turned on.
- 3 When you finish talking, press **[OFF]**.

Note:

- You can also use the **[INTERCOM]** soft key, if displayed, to make intercom calls.
- You cannot use voice paging if other units are in use.

Base unit

- 1 Press **[INTERCOM]**.
When 2 or more handsets are registered:
[↕]: Select the desired unit. → **[SELECT]**
 - To page all handsets, press **[0]** or wait for a few seconds.
 - Lift the corded handset if needed.
- 2 When you finish talking, press **[📞]** or place the corded handset on the cradle.

Answering an intercom call

Handset

- 1 Press **[↶]** to answer the page.
- 2 When you finish talking, press **[OFF]**.

Base unit

- 1 Press **[📞]** or lift the corded handset to answer the page.
- 2 When you finish talking, press **[📞]** or place the corded handset on the cradle.

Turning auto intercom on/off

This feature allows the handset or base unit to answer intercom calls automatically when it is called. You do not need to press **[↶]**, lift the corded handset, or press **[📞]**. When this feature is set to “on”, the monitoring handset or base unit for the baby monitor feature (page 56) will also answer baby monitor calls automatically. The default setting is “off”.

Handset / Base unit

- 1 **[MENU]** **#** **2** **7** **3**
- 2 **[↕]**: Select the desired setting. → **[SAVE]**
- 3 Proceed with the operation for your unit.
Handset: **[OFF]**
Base unit: **[EXIT]**

Note:

- This feature is not available for all handsets paging and voice paging even if it is turned on.

Call block

You can press the **[CALL BLOCK]** button in the following situations to disconnect the current call and add a phone number to the call block list:

- when an incoming call is being received
- when an incoming call is being recorded by the answering system
- when talking on an outside call

Once a phone number has been added to the call block list, the unit will block calls from that phone number in the future.

Handset / Base unit

- 1 Press **[CALL BLOCK]** under the situations shown above.
- 2 Confirm the call block number and press **[YES]**.
 - The call block number is stored in the call block list, confirmation tone sounds*1 and “**Call blocked**” is displayed, and then the call is disconnected.

*1 Confirmation tones are used with permission of © 2018 Copyrights Vision Inc.

Note:

- If the call has no phone number, the call is blocked but it is not stored in the call block list.
- The call block feature is not available:
 - for intercom calls or calls received by call waiting.
 - when a landline call (or cellular call) is being received during a cellular call (or landline call).
- Blocked calls are logged in the caller list.

Storing unwanted callers

The unit can block calls by storing the desired items in the call block list beforehand (Caller ID subscribers only).

- “**Block a single number**”: The unit blocks calls from specific phone numbers stored in the call block list.
- “**Block range of numbers**”: The unit blocks calls that begin with a number stored in the call block list, such as a toll-free phone number prefix or certain area codes.
- “**Block unknown CID**”: The unit blocks calls that have no phone number.

Single phone numbers and ranges of numbers can be stored in the call block list up to 1,000 items in total.

Blocking unwanted callers:

When a call is received, the unit will not ring while caller information is being received.*1

If the caller’s phone number matches an entry in the call block list, the unit emits no sound to the caller, and disconnects the call.

*1 If you want the first ring to sound, select “**Yes**” in “Turning the first ring on/off” (page 34).

Storing a single phone number

Important:

- We recommend storing 10 digits (including the area code). If only 7 digits are stored, all numbers that have the same last 7 digits will be blocked.

Adding call blocked numbers from the caller list

Handset

■ When a cellular phone is paired:

- 1 **[▼]** CID
- 2 **[↕]**: Select the desired entry to be blocked.
 - To edit the number: **[SELECT]** → Press **[⊞]** (Edit) repeatedly until the phone number is shown in the 10-digit format. → **[SAVE]** → **[↕]**: “**Call block**” → **[SELECT]** → Go to step 4.
- 3 **[CALL BLOCK]**
- 4 **[↕]**: “**Yes**” → **[SELECT]**
- 5 Edit the phone number if necessary (24 digits max.). → **[SAVE]** → **[OFF]**

■ When a cellular phone is not paired:

- 1 **[▼]** CID
- 2 **[↕]**: Select the desired entry to be blocked.
 - To edit the number: **[MENU]** → **[↕]**: “**Edit**” → **[SELECT]** Press **[EDIT]** repeatedly until the phone number is shown in the 10-digit format. → **[SAVE]** → **[↕]**: “**Call block**” → **[SELECT]** → Go to step 4.
- 3 **[CALL BLOCK]**
- 4 **[↕]**: “**Yes**” → **[SELECT]**
- 5 Edit the phone number if necessary (24 digits max.). → **[SAVE]** → **[OFF]**

Call Block

Base unit

- 1 [CALL BLOCK]
- 2 [↕]: Select the entry to be blocked.
 - To edit the number: Press [EDIT] repeatedly until the phone number is shown in the 10-digit format.
- 3 [CALL BLOCK]
- 4 [↕]: "Yes" → [SELECT]
- 5 Edit the phone number if necessary (24 digits max.). → [SAVE] → [EXIT]

Adding call blocked numbers manually

Handset

- 1 [CALL BLOCK]
- 2 [↕]: "Block a single number" → [SELECT]
- 3 [MENU] → [↕]: "Add" → [SELECT]
- 4 Enter the phone number (24 digits max.). → [SAVE] → [OFF]

Base unit

- 1 [CALL BLOCK]
- 2 [↕]: "Block a single number" → [SELECT] → [ADD]
- 3 Enter the phone number (24 digits max.). → [SAVE] → [EXIT]

Storing a range of number

Handset

- 1 [CALL BLOCK]
- 2 [↕]: "Block range of numbers" → [SELECT]
- 3 [MENU] → [↕]: "Add" → [SELECT]
- 4 Enter the desired number (2-8 digits). → [SAVE] → [OFF]

Base unit

- 1 [CALL BLOCK]
- 2 [↕]: "Block range of numbers" → [SELECT] → [ADD]
- 3 Enter the desired number (2-8 digits). → [SAVE] → [EXIT]

Blocking incoming calls that have no phone number

You can block calls when no phone number is provided, such as private callers or out of area calls.

Handset / Base unit

- 1 [CALL BLOCK]
- 2 [↕]: "Block unknown CID" → [SELECT]
- 3 [↕]: Select the desired setting. → [SAVE]
- 4 Proceed with the operation for your unit.
Handset: [OFF]
Base unit: [EXIT]

Turning the first ring on/off

You can choose whether the first ring sounds when a call is received.

"Yes": The first ring for all calls will be heard, including calls from blocked phone numbers.
"No" (default): The first ring is muted for all calls. If this setting is selected, the unit will never ring for calls from blocked phone numbers.

Handset / Base unit

- 1 [CALL BLOCK]
- 2 [↕]: "One ring for blocked call" → [SELECT]
- 3 [↕]: Select the desired setting. → [SAVE]
- 4 Proceed with the operation for your unit.
Handset: [OFF]
Base unit: [EXIT]

Viewing/editing/unblocking call block numbers

Handset

- 1 **[CALL BLOCK]**
- 2 **[↕]**: “Block a single number” or “Block range of numbers” → **[SELECT]**
- 3 **[↕]**: Select the desired entry.
 - After viewing, press **[OFF]** to exit.
- 4 **To edit a number:**
[EDIT] → Edit the number. → **[SAVE]** → **[OFF]**
To unblock a number:
[UNBLOCK] → **[↕]**: “Yes” → **[SELECT]** → **[OFF]**

Base unit

- 1 **[CALL BLOCK]**
- 2 **[↕]**: “Block a single number” or “Block range of numbers” → **[SELECT]**
- 3 **[↕]**: Select the desired entry.
 - After viewing, press **[EXIT]** to exit.
- 4 **To edit a number:**
[EDIT] → Edit the number. → **[SAVE]** → **[EXIT]**
To unblock a number:
[UNBLOCK] → **[↕]**: “Yes” → **[SELECT]** → **[EXIT]**

Note:

- When editing, press the desired dial key to add digits and press **[CLEAR]** to erase digits.

Unblocking all call block numbers

Handset / Base unit

- 1 **[CALL BLOCK]**
- 2 **[↕]**: “Block a single number” or “Block range of numbers” → **[SELECT]**
- 3 Proceed with the operation for your unit.
Handset: **[MENU]** → **[↕]**: “Unblock all” → **[SELECT]**
Base unit: **[UNBLOCK]**
- 4 **[↕]**: “Yes” → **[SELECT]**
- 5 **[↕]**: “Yes” → **[SELECT]**
- 6 Proceed with the operation for your unit.
Handset: **[OFF]**
Base unit: **[EXIT]**

Displaying and clearing the blocked call count

Handset

- 1 **[CALL BLOCK]**
- 2 **[↕]**: “Blocked calls count” → **[SELECT]**
 - To exit, press **[OFF]**.
- 3 **[CLEAR]**
- 4 **[↕]**: “Yes” → **[SELECT]** → **[OFF]**

Enhanced Call Block

Automated call block

With automated call block, the unit screens incoming calls before ringing for allowed calls, or ends the calls without ringing for calls identified as robocalls, telemarketing calls, or other undesirable calls (Caller ID subscribers only).

The unit will play the greeting message for automated call block and prompt the caller to enter an access code in order for the unit to identify whether the call is automated.

You can set the unit to block or unblock mode. The default setting is "Unblock".

Note:

- The unit connects the call without prompting to enter the access code in the following situations:
 - the caller's phone number matches an entry in the phonebook (page 39).
 - the caller's name matches an entry in the allow name list (page 37).
 - the caller's phone number is memorized in the allowed number database (page 36).
- If you have your cell phone connected via Link to Cell, even if automated call block is set to "Block", incoming cellular calls will still be connected automatically without requiring the access code.
- If the number is stored in the call block list (page 33), the unit disconnects the call without playing the greeting message for automated call block.
- The automated call block feature is not available:
 - when a landline call is being received during a cellular call.
 - when battery saving mode is on (page 12).
- When the answering system answers a call from a caller who is not registered in the phonebook, allow name list, or allowed number database, the following operations are delayed:
 - answering a call
 - remote turn on
 - toll saver
- When the unit receives a call from a caller who is not registered in the phonebook, allow name list, or allow number database in the following situations, the unit shifts to standby mode:
 - when searching the phonebook, caller list, call block list, or allow name list
 - when programming (depending on settings)
 - when using the answering system
 - when paging all handsets or base unit

- Blocked calls are logged in the caller list. We recommend you to check the caller list periodically. If necessary, register the entry to the phonebook or allow name list to connect the call next time.

Allowed number database

Once the caller enters the access code, the caller's phone number is memorized in the allowed number database as an unblocked number. Callers from this database are allowed to connect without the access code from their next call. 100 entries can be stored to the database (22 digits max. each).

Note:

- When the database memory is full, the latest call received will replace the oldest number stored in the list.
- The numbers stored in the database will be erased when you change the access code (page 36).
- The numbers stored in the database cannot be displayed.

Setting the automated call block

Handset

- 1 [MENU]#787
- 2 [↕]: Select the desired setting. → [SAVE]
- 3 [↕]: "Yes" → [SELECT] → [OFF]

Note:

- We recommend you perform a test run of the automated call block procedure to ensure that the automated call block feature is set correctly.

Changing the access code

If the unit answers undesirable calls such as robocalls even though the automated call block function is on, change the access code (3 digits max.). The default setting is "1".

Handset

- 1 [MENU]#789
- 2 [CLEAR]
- 3 Enter the new access code. → [SAVE] → [OFF]

Displaying and clearing the blocked call count

The total number of blocked calls (up to 65,000) will be displayed.

Handset

- 1 **[MENU]** **#** **7** **9** **0**
 - To exit, press **[OFF]**.
- 2 **[CLEAR]**
- 3 **[↕]**: “Yes” → **[SELECT]** → **[OFF]**

Adding to the allow name list

You can allow specific callers to pass through by adding the caller's name to the allow name list. You can store up to 100 names (16 characters max.). If the name stored in the allow name list matches the incoming Caller ID, the unit rings. Callers listed in the allow name list are not required to enter the access code.

Adding allowed names from the caller list

Handset

- **When a cellular phone is paired:**
 - 1 **[v]** CID
 - 2 **[↕]**: Select the desired entry. → **[SELECT]**
 - 3 **[SAVE]**
 - 4 **[↕]**: “Allow name” → **[SELECT]** → **[OFF]**
- **When a cellular phone is not paired:**
 - 1 **[v]** CID
 - 2 **[↕]**: Select the desired entry. → **[MENU]**
 - 3 **[↕]**: “Save allow name” → **[SELECT]** → **[OFF]**

Viewing/erasing an entry

Handset

- 1 **[MENU]** **#** **7** **9** **4**
- 2 **[↕]**: Select the desired entry.
 - After viewing, press **[OFF]** to exit.
- 3 **[ERASE]** → **[↕]**: “Yes” → **[SELECT]** → **[OFF]**

Erasing all entries

Handset

- 1 **[MENU]** **#** **7** **9** **4**
- 2 **[ERASE]** → **[↕]**: “Yes” → **[SELECT]**
- 3 **[↕]**: “Yes” → **[SELECT]** → **[OFF]**

Greeting message for automated call block

Handset

When the unit answers a call, a greeting message is played to the caller.

You can use either:

- your own greeting message and pre-recorded greeting message
- pre-recorded greeting message

Recording a greeting message for automated call block

Using this feature, the unit can play your own greeting message and pre-recorded greeting message.

Example of your own greeting message:

“Hi, you have reached xxxxxx (Name).”

“Thank you for your calling, You have reached xxxxxx (Name).”

“Hi, you have reached the xxxxxx (Name) residence.”

- 1 **[MENU]** **#** **7** **9** **1**
- 2 **[↕]**: “Yes” → **[SELECT]**
- 3 After a beep sounds, hold the handset about 20 cm (8 inches) away and speak clearly into the microphone (2 minutes max.).
- 4 Press **[STOP]** to stop recording.
- 5 The unit will play the recorded greeting message for automated call block. → **[OFF]**

Resetting to the pre-recorded greeting message for automated call block

This procedure will erase your greeting message for automated call block and reset to the pre-recorded one.

- 1 **[MENU]** **#** **7** **9** **3**
- 2 **[YES]** → **[OFF]**

Enhanced Call Block

Playing back the greeting message for automated call block

- 1 [MENU] [#] [7] [9] [2]
- 2 To exit, press [OFF].

Telemarketing call block

In addition to Automated call block (page 36), you can use Telemarketing call block to further screen calls to stop telemarketer calls from getting through.

Using this feature, the unit will prompt callers to say their names, and after checking the names, you can decide whether to answer the calls or not.

Note:

- This feature is only available for landline calls.
- While screening calls, the call waiting feature is unavailable (page 24, 28).
- Telemarketing call block guidance and caller name announcement cannot be heard using a Bluetooth headset.

Operating telemarketing call block

Handset

- 1 During a landline call, lift the handset and then press [TELE.BLK.].
 - The unit prompts callers to say their names.
- 2 **To answer the call:**
Press [↶] or [📞].
To block the call:
Press [CALL BLOCK]*1 → [YES].
 - The unit announces that the call will be disconnected, and disconnects the call.
 - The caller will be registered to call block list.

*1 The user can still answer the call after pressing [CALL BLOCK]. To answer the call, press [↶] or [📞].

Base unit

- 1 Press [TELE.BLK.] during a landline call.
 - The unit prompts callers to say their names.
- 2 **To answer the call:**
Lift the corded handset or press [📞].
To block the call:
Press [CALL BLOCK]*1 → [YES].
 - The unit announces that the call will be disconnected, and disconnects the call.
 - The caller will be registered to call block list.

*1 The user can still answer the call after pressing [CALL BLOCK]. To answer the call, lift the corded handset or press [📞].

Note:

- If there is no response from the caller, and the user does not press any keys in step 2 within 10 seconds, the unit will announce that the call will be disconnected, and disconnects the call.

Note for handset:

- While on the charger, the [TELE.BLK.] key is not available. Lift the handset from the charger to use this feature.
- To use this feature, set the Auto talk feature to "Off".

Phonebook

You can add 3,000 names (16 characters max.) and phone numbers (24 digits max.) to the phonebook, and assign each phonebook entry to the desired group (page 40). The following groups are available:

- Group 1: “Home”^{*1} (default)
- Group 2: “Cell 1”^{*1}
- Group 3: “Cell 2”^{*1}
- Group 4-9: You can change the group name for each group.

^{*1} For groups 1-3, the group names cannot be changed.

Important:

- All entries can be shared by the base unit and any registered handset.
- You can copy phonebook entries from a Bluetooth cellular phone to the unit's phonebook (page 61).

Adding phonebook entries

Handset / Base unit

- 1 Proceed with the operation for your unit.
Handset: [◀] □□ → [MENU]
Base unit: [□□] → [MENU]
- 2 [↕]: “Add new entry” → [SELECT]
- 3 Enter the party's name. → [OK]
- 4 Enter the party's phone number. → [OK]
- 5 [↕]: Select the desired group. → [SELECT] 2 times
- 6 Proceed with the operation for your unit.
Handset: [OFF]
Base unit: [EXIT]

Note for handset and base unit:

- In step 3, you can switch the language for entering characters.
[#] → [↕]: Select the desired language. → [OK]

Note for base unit:

- You can also add entries as follows:
Press [□□]. → [ADD] → Go to step 3.

Entering characters

Press the dial key that corresponds to the desired character. Press repeatedly to scroll through the available characters.

The following operations are also available.

Key	Operation
[*]	Switch between the uppercase and lowercase (A ↔ a)
[◀] [▶]	Move the cursor
[CLEAR]	Erase the character or number <ul style="list-style-type: none"> ● To erase all, press and hold it.

- To enter another character that is located on the same dial key:
Handset: Press [▶] to move the cursor to the next space.
Base unit: Press [▶▶] to move the cursor to the next space.
- If you do not press any dial key within 2 seconds after entering a character, the character is fixed and the cursor moves to the next space.

Storing a redial list number to the phonebook

Phone numbers of up to 24 digits can be stored in the phonebook.

Handset

■ When a cellular phone is paired:

- 1 [▶] REDIAL
- 2 [↕]: Select the desired entry. → [MENU]
- 3 [↕]: “Save” → [SELECT]
- 4 To store the name, continue from step 3, “Editing entries”, page 41.

■ When a cellular phone is not paired:

- 1 [▶] REDIAL
- 2 [↕]: Select the desired entry. → [SAVE]
- 3 To store the name, continue from step 3, “Editing entries”, page 41.

Base unit

- 1 [REDIAL]
- 2 [↕]: Select the desired entry. → [SAVE]
- 3 To store the name, continue from step 3, “Editing entries”, page 41.

Phonebook

Note for handset and base unit:

- The name stored in the phonebook will be reflected in the redial list after you make a call using that phonebook entry.

Storing caller information to the phonebook

Handset

■ When a cellular phone is paired:

- 1 [v] CID
- 2 [↕]: Select the desired entry. → [SELECT]
 - To edit the number, press [Edit] repeatedly until the phone number is shown in the desired format.
- 3 [SAVE]
- 4 [↕]: "Phonebook" → [SELECT]
- 5 Continue from step 3, "Editing entries", page 41.

■ When a cellular phone is not paired:

- 1 [v] CID
- 2 [↕]: Select the desired entry. → [MENU]
 - To edit the number: [↕]: "Edit" → [SELECT]
Press [EDIT] repeatedly until the phone number is shown in the desired format.
→ [SAVE] → [↕]: "Phonebook" → [SELECT] → Go to step 4.
- 3 [↕]: "Save phonebook" → [SELECT]
- 4 Continue from step 3, "Editing entries", page 41.

Base unit

- 1 [CID]
- 2 [↕]: Select the desired entry.
 - To edit the number, press [EDIT] repeatedly until the phone number is shown in the desired format.
- 3 [SAVE]
- 4 [↕]: "Phonebook" → [SELECT]
- 5 Continue from step 3, "Editing entries", page 41.

Groups

Groups can help you find entries in the phonebook quickly and easily. You can change the group name for groups 4-9 ("Friends", "Family", etc.). By assigning different ringer tones for different groups

of callers, you can identify who is calling (ringer ID), if you have subscribed to Caller ID service.

Changing group names/setting ringer ID

Handset / Base unit

- 1 Proceed with the operation for your unit.
Handset: [←] □□ → [MENU]
Base unit: [□□] → [MENU]
- 2 [↕]: "Group" → [SELECT]
- 3 [↕]: Select the desired group. → [SELECT]
 - If you selected "Home", "Cell 1", or "Cell 2" on the handset, go to step 5.
- 4 To change group names
[↕]: "Group name" → [SELECT] → Edit the name (10 characters max.). → [SAVE]
- 5 To set group ringer tone (handset)
[↕]: Select the current setting of the group ringer tone. → [SELECT] → [↕]: Select the desired ringer tone. → [SAVE]
- 6 Proceed with the operation for your unit.
Handset: [OFF]
Base unit: [EXIT]

Finding and calling from a phonebook entry

Once you have found the desired entry using one of the following 4 methods, make a call with your unit.

■ Using a cellular line:

Handset

- 1 [CELL]
 - The unit starts dialing immediately in the following situations.
 - Only 1 cellular phone is paired.
 - A specific line is set to make cellular calls (page 21).
- 2 [↕]: Select the desired cellular phone. → [SELECT]

Base unit

Press [CELL 1] or [CELL 2]. → Lift the corded handset.

■ Using a landline:

Handset

[↶]

Base unit

Lift the corded handset.

Scrolling through all entries

Handset / Base unit

- 1 Proceed with the operation for your unit.

Handset: [◀] □□

Base unit: [□□]

- 2 [↕]: Select the desired entry.

Searching by first character

Handset / Base unit

- 1 Proceed with the operation for your unit.

Handset: [◀] □□

Base unit: [□□]

- 2 Press the dial key ([0] – [9] or [#]) which contains the character you are searching for.
- 3 [↕]: Scroll through the phonebook if necessary.

Searching by query

You can narrow down the search to enter the first characters of a name.

Handset / Base unit

- 1 Proceed with the operation for your unit.

Handset: [◀] □□ → [✕]

Base unit: [□□] → [✕]

- 2 To search for the name, enter the first characters (up to 4) in uppercase.
- 3 [OK]
- 4 [↕]: Scroll through the phonebook if necessary.

Note:

- In step 2, you can switch the language for entering characters.
[#] → [↕]: Select the desired language. → [OK]

Searching by group

Handset / Base unit

- 1 Proceed with the operation for your unit.

Handset: [◀] □□

Base unit: [□□]

- 2 [GROUP]

- 3 [↕]: Select the group you want to search. → [SELECT]

- If you select “All groups”, the unit ends the group search.

- 4 [↕]: Select the desired entry.

Editing entries

Handset

- 1 Find the desired entry (page 40).
- 2 [MENU] → [↕]: “Edit” → [SELECT]
- 3 Edit the name if necessary. → [OK]
- 4 Edit the phone number if necessary. → [OK]
- 5 [↕]: Select the desired group (page 40). → [SELECT] 2 times → [OFF]

Base unit

- 1 Find the desired entry (page 40).
- 2 [EDIT]
- 3 Edit the name if necessary. → [OK]
- 4 Edit the phone number if necessary. → [OK]
- 5 [↕]: Select the desired group (page 40). → [SELECT] 2 times → [EXIT]

Erasing entries

Erasing an entry

Handset

- 1 Find the desired entry (page 40).
- 2 [MENU] → [↕]: “Erase” → [SELECT]
- 3 [↕]: “Yes” → [SELECT] → [OFF]

Base unit

- 1 Find the desired entry (page 40).
- 2 [ERASE] → [↕]: “Yes” → [SELECT] → [EXIT]

Erasing all entries

Handset / Base unit

- 1 Proceed with the operation for your unit.
Handset: [◀] □□ → [MENU]
Base unit: [□□] → [MENU]
- 2 [↕]: “Erase all” → [SELECT]
- 3 [↕]: Select the desired group. → [SELECT]
- 4 [↕]: “Yes” → [SELECT]

Phonebook

- 5 [↕]: “Yes” → [SELECT]
- 6 Proceed with the operation for your unit.
Handset: [OFF]
Base unit: [EXIT]

Chain dial

This feature allows you to dial phone numbers in the phonebook while you are on a call. This feature can be used, for example, to dial a calling card access number or bank account PIN that you have stored in the phonebook, without having to dial manually.

Handset / Base unit

- 1 Proceed with the operation for your unit.
Handset: During an outside call, press [←] □□.
Base unit: During an outside call, press [□□].
- 2 [↕]: Select the desired entry.
- 3 Press [CALL] to dial the number.

Note:

- When storing a calling card access number and your PIN in the phonebook as one phonebook entry, press [▲] (Pause) on the handset or [PAUSE] on the base unit to add pauses after the number and PIN as necessary (page 23, 27).
- If you have rotary/pulse service, you need to press [✕] before pressing [←] □□ on the handset or [□□] on the base unit in step 1 to change the dialing mode temporarily to tone. When adding entries to the phonebook, we recommend adding [✕] to the beginning of phone numbers you wish to chain dial (page 39).

Speed dial

You can store phone numbers to the base unit and handset separately:

- Handset: up to 9 entries.
- Base unit: up to 9 entries.

Adding phone numbers to speed dial keys

Handset / Base unit

You can assign 1 phone number to each of the dial keys ([1] to [9]).

■ By entering phone numbers:

- 1 Press and hold the desired speed dial key ([1] to [9]).
- 2 Proceed with the operation for your unit.
Handset: [ADD] → [↕]: “Manual” → [SELECT]
Base unit: [EDIT]
- 3 Enter the party's name (16 characters max.). → [OK]
- 4 Enter the party's phone number (24 digits max.). → [OK] → [SELECT]
- 5 Proceed with the operation for your unit.
Handset: [OFF]
Base unit: [EXIT]

■ From the phonebook:

- 1 Press and hold the desired speed dial key ([1] to [9]).
- 2 Proceed with the operation for your unit.
Handset: [ADD] → [↕]: “Phonebook” → [SELECT]
Base unit: [□□]
- 3 [↕]: Select the desired entry. → [SAVE]
- 4 Proceed with the operation for your unit.
Handset: [OFF]
Base unit: [EXIT]

Note for handset and base unit:

- If you edit a phonebook entry which is assigned to a speed dial key, the edited entry does not transfer to the speed dial key.

Editing an entry

Handset / Base unit

- 1 Press and hold the desired speed dial key ([1] to [9]).
- 2 Proceed with the operation for your unit.
Handset: [MENU] → [↕]: “Edit” → [SELECT]
Base unit: [EDIT]
- 3 Edit the name if necessary. → [OK]
- 4 Edit the phone number if necessary. → [OK] → [SELECT]
- 5 Proceed with the operation for your unit.
Handset: [OFF]
Base unit: [EXIT]

Erasing an entry

Handset / Base unit

- 1 Press and hold the desired speed dial key ([1] to [9]).
- 2 Proceed with the operation for your unit.
Handset: [MENU] → [↕]: "Erase" → [SELECT]
Base unit: [ERASE]
- 3 [↕]: "Yes" → [SELECT]
- 4 Proceed with the operation for your unit.
Handset: [OFF]
Base unit: [EXIT]

Viewing an entry/Making a call

Handset

■ Using a cellular line:

- 1 Press and hold the desired speed dial key ([1] to [9]).
- 2 [CELL]
 - The unit starts dialing immediately in the following situations.
 - Only 1 cellular phone is paired.
 - A specific line is set to make cellular calls (page 21).
- 3 [↕]: Select the desired cellular phone. → [SELECT]

■ Using a landline:

- 1 Press and hold the desired speed dial key ([1] to [9]).
- 2 To make a call, press [↶].

Base unit

■ Using a cellular line:

- 1 Press and hold the desired speed dial key ([1] to [9]).
- 2 Press [CELL 1] or [CELL 2], then lift the corded handset.

■ Using a landline:

- 1 Press and hold the desired speed dial key ([1] to [9]).
- 2 Lift the corded handset.

One-touch dial buttons

You can store phone numbers or extension numbers to the base unit's one-touch dial buttons (1 or 2).

- phone numbers for outside calls
- extension numbers for handsets

Note:

- You can transfer a call to a handset. While you are on an outside call, press the one-touch dial button with an extension number stored. The line is put on hold and the base unit pages the handset. After the handset answers the page, place the corded handset on the cradle to complete the transfer.

Adding phone numbers for outside calls

Base unit

■ By entering phone numbers:

- 1 Press and hold the desired one-touch dial button (1 or 2). → [EDIT]
- 2 Enter the party's name (16 characters max.). → [OK]
- 3 Enter the party's phone number (24 digits max.). → [OK] → [SELECT] → [EXIT]

■ From the phonebook:

- 1 Press and hold the desired one-touch dial button (1 or 2).
- 2 [☐☐]
- 3 [↕]: Select the desired entry. → [SAVE] → [EXIT]

Note:

- If you edit a phonebook entry which is assigned to a one-touch dial button, the edited entry does not transfer to the one-touch dial button.

Adding extension numbers for handsets

Base unit

- 1 Press and hold the desired one-touch dial button (1 or 2). → [EDIT]
- 2 Press [INT].

Phonebook

- 3 **[↕]**: Select the desired unit. → **[SELECT]** 2 times → **[EXIT]**

Viewing/editing/erasing an entry

Base unit

- 1 Press and hold the desired one-touch dial button (1 or 2).
 - After viewing, press **[EXIT]** to exit.
- 2 **To edit an entry**
[EDIT] → Edit the name if necessary. → **[OK]** → Edit the phone number if necessary. → **[OK]** → **[SELECT]** → **[EXIT]**
To erase an entry
[ERASE] → **[↕]**: “Yes” → **[SELECT]** → **[EXIT]**

Making a call

Base unit

- **Using a cellular line:**
 - 1 Press **[CELL 1]** or **[CELL 2]**.
 - 2 Press the desired one-touch dial button (1 or 2), then lift the corded handset.
- **Using a landline:**
Press the desired one-touch dial button (1 or 2), then lift the corded handset.

Note:

- You can dial phone numbers in the one-touch dial button while you are on a call.

Menu list

To access the features, there are 2 methods.

Handset / Base unit





■ Scrolling through the display menus

- 1 [MENU]
- 2 Press [▼] or [▲] to select the desired main menu. → [SELECT]
- 3 Press [▼] or [▲] to select the desired item from the next sub-menus. → [SELECT]
- 4 Press [▼] or [▲] to select the desired setting. → [SAVE]

■ Using the direct command code



- 1 [MENU] → Enter the desired code.
Example: Press [MENU]#101.
- 2 Select the desired setting. → [SAVE]

Note:



- The unit column shows the unit(s) that can be used to program the item.
 - : Only the handset can program the item.
 - : Only the base unit can program the item.
 - : Both the handset and base unit can program the item.
- To exit the operation, press [OFF] on the handset or [EXIT] on the base unit.
- In the following table, < > indicates the default settings.
- In the following table,  indicates the reference page number.
- Display menu order and sub-menu may vary depending on your model.

Display menu tree and direct command code table

Main menu:  "Phonebook"

Operation	Code	Unit	
Viewing the phonebook entry.	#280	 	40





Main menu:  "Caller list"

Operation	Code	Unit	
Viewing the caller list.	#213	 	58





















Main menu:

Handset:  "Answering device"



Base unit:  "Answering device"

Sub-menu 1	Sub-menu 2	Settings	Code	Unit	
Play new message	–	–	#323		68
Play all message	–	–	#324		68
Erase all message*1	–	–	#325		69

Programming

Sub-menu 1	Sub-menu 2	Settings	Code	Unit	👉
Greeting	Record greeting* ¹	–	#302	 	67
	Check greeting	–	#303	 	68
	Pre-recorded* ¹ (Reset to pre-recorded greeting)	–	#304	 	67
New message alert* ¹	Outgoing call – On/Off	On <Off>	#338	 	69
	Outgoing call – Notification to	–			
	Outgoing call – Remote code	Activate <Inactivate>			
	Base unit beep	On <Off>	#339	 	69
Settings	Ring count* ¹	Toll saver 2-7 rings <4 rings>	#211	 	72
	Recording time* ¹	<3 min> 1 min Greeting only* ²	#305	 	73
	Remote code* ¹	<111>	#306	 	71
	Screen call	<On> Off	#310	 	72
Answer on* ¹	–	–	#327		67
Answer off* ¹	–	–	#328		67

Main menu:  “Voicemail access”³

















Operation	Code	Unit	👉
Listening to voicemail messages.	#330	 	75

Main menu:  “Intercom”

Operation	Code	Unit	👉
Paging the desired unit.	#274		32

Programming

Main menu:  "Bluetooth"

Sub-menu 1	Sub-menu 2	Settings	Code	Unit		
Link to cell – 1:Add new device ^{*4} (for CELL 1) – 2:Add new device ^{*4} (for CELL 2)	Connect ^{*1} / Disconnect ^{*1}	–	#6251 ^{*5}		20	
			#6252 ^{*6}			
	Ringer volume	Off-6 <6>		#6281 ^{*5}		23, 28
				#6282 ^{*6}		
	Ringer tone ^{*7}	<Tone 2> ^{*5} <Tone 4> ^{*6}		#6291 ^{*5}		–
				#6292 ^{*6}		
	Select unit to ring ^{*1}	Handset 1-6 <All>		#6271 ^{*5}		19
				#6272 ^{*6}		
	Ring as cell (limited) ^{*1}	<On (with Talking CID)> On (without Talking CID) Off		#6141 ^{*5}		19
				#6142 ^{*6}		
	Alert settings ^{*1} – Alert On/Off	<On> Off		#6101 ^{*5}		63
				#6102 ^{*6}		
	Alert settings ^{*1} – Voice alert	<On> Off		#6031 ^{*5}		63
				#6032 ^{*6}		
Alert settings ^{*1,*8} – Alert tone	<Tone 1> ^{*5} <Tone 2> ^{*6}		#6041 ^{*5}		63	
			#6042 ^{*6}			
Pair	–		#6241 ^{*5}		18	
			#6242 ^{*6}			
Unpair	–		#6111 ^{*5}		18	
			#6112 ^{*6}			
Phonebook transfer	–	–	#618		61	
Headset	Add new device ^{*4}	–	#621		64	
	Connect ^{*1} / Disconnect ^{*1}	–	#622		65	
	Pair	–	#621		64	
	Unpair	–	#612		65	

Programming

Sub-menu 1	Sub-menu 2	Settings	Code	Unit	
Settings	Auto connect* ¹	Off <1 min> 3 min 5 min 10 min	#632		19
	Cell area code* ¹	–	#633		21
	Cell line only mode* ¹	On <Off>	#157		20
	Cell line select (Handset)	<Manual> Cellphone 1* ⁴ Cellphone 2* ⁴	#634		21
	Cell line select (Base unit)	<Cellphone 1>* ⁴ Cellphone 2* ⁴	#634		
	Set PIN* ¹	<0000>	#619		21
	International code* ¹	–	#117		61
	Country code* ¹	–	#118		
	Trunk prefix* ¹	–	#119		

Main menu: “Set date & time”























Sub-menu 1	Sub-menu 2	Settings	Code	Unit	
Date and time* ¹	–	–	#101		16
Memo alarm	Alarm1-3	<Off> Once Daily Weekly	#720		53
Time adjustment* ^{1, 9}	–	<Caller ID auto> Manual	#226		–

Main menu: “Speed dial”



































Operation	Code	Unit	
Viewing the speed dial entry.	#261		42

Programming

















Main menu:  "Settings"

Sub-menu 1	Sub-menu 2	Settings	Code	Unit	
Ring adjustments	Ringer volume (Incoming) ^{*3}	Off-6 <6>	#160		–
	Ringer volume ^{*3}	Off-6 <6>	#160		–
	Intercom ringer volume	1–6 <6>	#175		–
	Ringer tone (Incoming) ^{*3, *7, *10}	<Tone 1>	#161		–
	Intercom ringer tone ^{*7, *10}	<Tone 3>	#163		–
	Interrupt tone ^{*11}	<On> Off	#201	 	26, 30
	Silent mode – On/Off	On <Off>	#238	 	54
	Silent mode – Start/End	<11:00 PM/06:00 AM>	#237	 	54
	Silent mode – Select group	Home Cell 1 Cell 2 Group 4-9	#241	 	54
Set date & time	Date and time ^{*1}	–	#101	 	16
	Memo alarm – Alarm1-3	<Off> Once Daily Weekly	#720		53
	Time adjustment ^{*1, *9}	<Caller ID auto> Manual	#226	 	–
Talking caller ID	–	Handset: <On> Off Base unit: On <Off>	#162	 	58
Low battery alert	–	Off <Every hour> Every 3 hours Every 6 hours	#176		17

Programming

Sub-menu 1	Sub-menu 2	Settings	Code	Unit		
Key detector setting^{*12} – 1: Add new device (for Detector1) ^{*13} – 2: Add new device (for Detector2) – 3: Add new device (for Detector3) – 4: Add new device (for Detector4)	Change name ^{*1}	Detector1	#6561		–	
		Detector2 ^{*14}	#6562 ^{*14}			
		Detector3 ^{*14}	#6563 ^{*14}			
		Detector4 ^{*14}	#6564 ^{*14}			
	Registration	–	#6571	#6571		–
			#6572 ^{*14}	#6572 ^{*14}		
			#6573 ^{*14}	#6573 ^{*14}		
			#6574 ^{*14}	#6574 ^{*14}		
	Deregistration	–	#6581	#6581		–
			#6582 ^{*14}	#6582 ^{*14}		
			#6583 ^{*14}	#6583 ^{*14}		
			#6584 ^{*14}	#6584 ^{*14}		
Automated call block ^{*1}	Block/Unblock	Block <Unblock>	#787		36	
	Allow name list	–	#794		37	
	Access code	<1>	#789		36	
	Automated call greeting	Record greeting	Record greeting	#791		37
		Check greeting	Check greeting	#792		38
		Pre-recorded	Pre-recorded	#793		37
	Blocked calls count	–	#790		37	
Call block ^{*1}	Block a single number	–	#217	 	33	
	Block range of numbers	–		 	34	
	Block unknown CID (CID: Caller ID)	Block <Unblock>	#240	 	34	
	One ring for blocked call	Yes <No>	#173	 	34	
	Blocked calls count	–	#177		35	
One-touch dial	–	–	#247		43	
Speed dial	–	–	#261	 	42	
Record greeting ^{*1}	–	–	#302	 	67	

Programming

Sub-menu 1	Sub-menu 2	Settings	Code	Unit	
Voicemail ^{*3}	Save VM access# ^{*1, *15} (VM: Voicemail) Save voicemail access# ^{*1, *16}	-	#331		74
	VM tone detect ^{*1}	<On> Off	#332		74
LCD contrast (Display contrast)	-	Handset: Level 1-4 <2> Base unit: Level 1-6 <3>	#145		-
Handset name	-	-	#104		56
Display name	-	On <Off>	#105		56
Answer by voice command ^{*1}	On/Off	On <Off>	#106		31
	Sensitivity level	Low <Normal> High	#107		31
Auto intercom	-	On <Off>	#273		32
Key tone	-	<On> Off	#165		-
Caller ID edit (Caller ID number auto edit)	-	<On> Off	#214		59
Auto talk ^{*17}	-	On <Off>	#200		23
Set tel line ^{*1, *3}	Set dial mode	<Tone> Pulse	#120		17
	Set flash time ^{*18}	80 ms 90 ms 100 ms 110 ms 160 ms 200 ms 250 ms 300 ms 400 ms 600 ms <700 ms> 900 ms	#121		23, 28
	Set line mode ^{*19}	A 	#122		-
Call sharing ^{*1}	-	<On> Off	#194		25, 29

For assistance, please visit <http://shop.panasonic.com/support>

51

Programming

Sub-menu 1	Sub-menu 2	Settings	Code	Unit	
Registration	Register handset	–	#130		56
	Deregistration*2	–	#131		57
Deregistration*2	–	–	#131		57
Battery saving mode	–	On <Off>	#150		12
Change language	Display	<English> Español	#110		16
	Announcement*1	<English> Español	#112		16

Main menu: “Customer support”

Operation	Code	Unit	
Displaying customer support Web address.	#680		–

Main menu: “Baby monitor”

Sub-menu 1	Sub-menu 2	Settings	Code	Unit	
On/Off	–	On <Off>	#268		54
Sensitivity level	–	Low <Middle> High	#269		55

Main menu: “Key detector”*12

Sub-menu 1	Sub-menu 2	Settings	Code	Unit	
Search	–	–	#655		–
Battery check	–	–			

*1 If you program these settings using one of the units, you do not need to program the same item using another unit.

*2 This menu is not displayed when scrolling through the display menus. It is only available in direct command code.

*3 When the cellular line only mode is turned on, these menus are not displayed (page 20).

*4 After the Bluetooth device is paired, the device name is displayed.

*5 For CELL 1

*6 For CELL 2

*7 The preset melodies in this product (“Melody 1” - “Melody 10”) are used with permission of © 2009 - 2012 Copyrights Vision Inc.

*8 The preset melodies in this product (“Tone 1” and “Tone 2”) are used with permission of © 2013 Copyrights Vision Inc.

*9 This feature allows the unit to automatically adjust the date and time each time caller information including date and time is received.

To turn this feature on, select “Caller ID auto”. To turn this feature off, select “Manual”. (Caller ID subscribers only)

To use this feature, set the date and time first (page 16).

*10 If you subscribe to a distinctive ring service (such as IDENTA-RING), select a tone (tone 1 to 5). If you select a melody, you cannot distinguish lines by their ringers.

- *11 This tone lets you know when you receive an outside call while you are on another line or an intercom call. If you select "On", the tone sounds 2 times.
- *12 This setting is available when you have the key detector (KX-TGA20). Read the installation manual for more information on the key detector.
- *13 For models with supplied key detectors, the display shows "1:Detector1".
- *14 If you register 2 or more key detectors.
- *15 Handset
- *16 Base unit
- *17 If you subscribe to a Caller ID service and want to view the caller's information after lifting up the handset to answer a call, turn off this feature.
- *18 The flash time depends on your telephone exchange or host PBX. Contact your PBX supplier if necessary. The setting should stay at "700 ms" unless pressing [FLASH] fails to pick up the waiting call.
- *19 Generally, the line mode setting should not be changed. This setting automatically maintains receiver volume at the proper level depending on the current telephone line condition. Set the line mode to "A" if telephone line condition is not good.

Alarm

An alarm sounds at the set time for 1 minute and is repeated 5 times at 5 minute intervals (snooze function). A text memo can also be displayed for the alarm. A total of 3 separate alarm times can be programmed for each handset. You can set one of 3 different alarm options (once, daily, or weekly) for each alarm time.

Important:

- Make sure the unit's date and time setting is correct (page 16).

Handset

- 1 [MENU][#][7][2][0]
- 2 [↕]: Select the desired alarm. → [SELECT]
- 3 [↕]: Select the desired alarm option. → [SELECT]

"Off"	Turns alarm off. Go to step 10.
"Once"	An alarm sounds once at the set time.
"Daily"	An alarm sounds daily at the set time. Go to step 5.
"Weekly"	Alarm sounds weekly at the set time(s).

- 4 Proceed with the operation according to your selection in step 3.

■ Once:

Enter the desired month and date. → [OK]

■ Weekly:

[↕]: Select the desired day of the week and press [SELECT]. → [OK]

- 5 Set the desired time.
- 6 [X]: Select "AM" or "PM". → [OK]
- 7 Enter a text memo (10 characters max.). → [OK]
- 8 [↕]: Select the desired alarm tone. → [SELECT]
 - We recommend selecting a different ringer tone from the one used for outside calls.
- 9 [↕]: Select the desired snooze setting. → [SAVE]
- 10 [SELECT] → [OFF]

Note:

- Press [STOP] to stop the alarm completely.
- When the handset is in use, the alarm will not sound until the handset is in standby mode.
- Press any dial key or [SNOOZE] to stop the sound but keep the snooze function activated.
- If you want to make an outside call when the snooze function is activated, please stop the snooze function before making the call.

Silent mode

Silent mode allows you to select a period of time during which the handset and/or base unit will not ring for outside calls. This feature is useful for time periods when you do not want to be disturbed, for example, while sleeping. Silent mode can be set for each unit.

Programming

Using the phonebook's group feature (page 40), you can also select groups of callers whose calls override silent mode and ring the unit (Caller ID subscribers only).

Important:

- Make sure the unit's date and time setting is correct (page 16).
- If you have set the alarm, the alarm sounds even if the silent mode is turned on.

Turning silent mode on/off

Handset

- 1 **[MENU]** **[#]** **[2]** **[3]** **[8]**
- 2 **[↕]**: Select the desired setting. → **[SAVE]**
 - If you select "OFF", press **[OFF]** to exit.
- 3 Enter the desired hour and minute you wish to start this feature.
- 4 **[X]**: Select "AM" or "PM". → **[OK]**
- 5 Enter the desired hour and minute you wish to end this feature.
- 6 **[X]**: Select "AM" or "PM".
- 7 **[SAVE]** → **[OFF]**

Base unit

- 1 **[MENU]** **[#]** **[2]** **[3]** **[8]**
- 2 **[↕]**: Select the desired setting. → **[SAVE]**
 - If you select "OFF", press **[EXIT]** to exit.
- 3 Enter the desired hour and minute you wish to start this feature.
- 4 **[AM/PM]**: Select "AM" or "PM". → **[OK]**
- 5 Enter the desired hour and minute you wish to end this feature.
- 6 **[AM/PM]**: Select "AM" or "PM".
- 7 **[SAVE]** → **[EXIT]**

Changing the start and end time

Handset / Base unit

- 1 **[MENU]** **[#]** **[2]** **[3]** **[7]**
- 2 Continue from step 3 for handset or step 3 for base unit, "Turning silent mode on/off", page 54.

Selecting groups to bypass silent mode

Handset / Base unit

- 1 **[MENU]** **[#]** **[2]** **[4]** **[1]**

- 2 **[↕]**: Select the desired groups. → **[SELECT]**
 - "✓" is displayed next to the selected group numbers.
 - To cancel the selected group:
[↕]: Select the group. → Press **[SELECT]** again. "✓" disappears.
- 3 **[SAVE]**
- 4 Proceed with the operation for your unit.
Handset: [OFF]
Base unit: [EXIT]

Baby monitor

This feature allows you to listen in on a room where another handset is located, allowing you to easily monitor from different areas of the house or even while away from home. The monitored handset (placed in a baby's room, for example) will automatically call the monitoring handset, base unit, or the phone number stored when it detects sound.

Important:

- Before using this feature, we recommend that you test it and adjust the baby monitor sensitivity as needed, especially if you plan to monitor from outside.
- This feature should not be used as a substitute for a medical or caregiver's supervision. It is the caregiver's responsibility to stay close enough to handle any eventuality.

Note:

- If the unit is connected to a PBX system, you cannot set the baby monitor.
- During the monitoring mode, battery consumption is faster than usual. We recommend leaving the monitored handset on charger.
- The monitored handset never rings while it is being monitored. If the base unit is placed near the monitored handset, we recommend turning off the base unit ringer volume (page 47, 49)

Setting the baby monitor

Perform the setting operation with the handset to be monitored (for example, the handset placed in a baby's room).

To monitor with a unit

The internal baby monitor feature is available:

- between handsets
- between a handset and the base unit

Handset

- 1 **[MENU]**[#][2][6][8]
- 2 **[↕]**: “On” → **[SELECT]**
- 3 **[↕]**: Select the desired unit’s number to monitor with. → **[SAVE]**
 - “Baby monitor” will be displayed.
 - The registered unit’s name/number is displayed.

Note:

- When this feature is on, another handset or the base unit can hear the monitored handset by making an intercom call.

To monitor from outside

If you enable this feature, the unit will call a pre-programmed phone number when the handset detects sound. After you answer the call, you can listen in on the room where the handset is located. This feature is only available for landline.

Handset

■ **From the phonebook:**

- 1 **[MENU]**[#][2][6][8]
- 2 **[↕]**: “On” → **[SELECT]**
- 3 **[↕]**: Select “Outgoing call” to monitor from outside. → **[ADD]**
- 4 **[↕]**: “Phonebook” → **[SELECT]**
- 5 **[↕]**: Select the phonebook entry. → **[SAVE]**
 - “Baby monitor” will be displayed.

Note:

- If you edit a phonebook entry which is assigned for monitoring, the edited entry does not transfer to the monitor.

■ **By entering phone numbers:**

- 1 **[MENU]**[#][2][6][8]
- 2 **[↕]**: “On” → **[SELECT]**
- 3 **[↕]**: Select “Outgoing call” to monitor from outside. → **[ADD]**
- 4 **[↕]**: “Manual” → **[SELECT]**
- 5 Enter the desired name. → **[OK]**
- 6 Enter the desired number. → **[OK]** → **[SELECT]**
 - “Baby monitor” will be displayed.

Note:

- The registered name/number is displayed.

Turning off the baby monitor

The monitored handset cannot be used while baby monitor is set to “On”.

Handset

- 1 Press **[MENU]** on the handset being monitored.
- 2 **[↕]**: “On/Off” → **[SELECT]**
- 3 **[↕]**: “Off” → **[SELECT]** → **[OFF]**

Editing an outside monitoring number

Handset

- 1 Press **[MENU]** on the handset being monitored.
- 2 **[↕]**: “On/Off” → **[SELECT]**
- 3 **[↕]**: “On” → **[SELECT]**
- 4 **[↕]**: Select the outside line. → **[MENU]**
- 5 **[↕]**: “Edit” → **[SELECT]**
- 6 Edit the name if necessary. → **[OK]**
- 7 Edit the phone number if necessary. → **[OK]** → **[SELECT]**

Erasing an outside monitoring number

Handset

- 1 Press **[MENU]** on the handset being monitored.
- 2 **[↕]**: “On/Off” → **[SELECT]**
- 3 **[↕]**: “On” → **[SELECT]**
- 4 **[↕]**: Select the outside line. → **[MENU]**
- 5 **[↕]**: “Erase” → **[SELECT]**
- 6 **[↕]**: “Yes” → **[SELECT]** → **[OFF]**

Baby monitor sensitivity

You can adjust the sensitivity of the baby monitor. Increase or decrease the sensitivity to adjust the sound level needed to trigger the baby monitor feature.

- This feature cannot be set during a monitoring call.

Handset

- 1 Press **[MENU]** on the handset being monitored.

Programming

- 2 [↕]: "Sensitivity level" → [SELECT]
- 3 [↕]: Select the desired setting. → [SAVE] → [OFF]

Answering the baby monitor

Handset / Base unit

■ When monitoring with a unit:

Handset: Press [↶] to answer a call.

Base unit: Press [📞] to answer a call.

If you want to respond from the monitoring unit, press [MUTE].

- The monitoring unit will answer calls automatically when the auto intercom feature is set to "on" (page 32).

Note:

- If you receive an outside call when communicating with the monitored handset, the interrupt tone sounds.
 - To answer the call with the handset, press [OFF], then press [↶].
 - To answer the call with the base unit, press [📞] 3 times.*1

*1 If [MUTE] is pressed, press [📞] 2 times.

■ When monitoring from outside:

Answer the call.

If you want to respond from your monitoring phone, press [#]1 using tone dialing.

You can turn off the baby monitor feature by pressing [#]0.

Note:

- The unit disconnects the call automatically after 2 minutes.

Other programming

Changing the handset name

The default handset name is "Handset 1" to "Handset 6". You can customize the name of each handset ("Bob", "Kitchen", etc.). This is useful when you make intercom calls between handsets. To display the handset name in standby mode, turn on the handset name display feature (page 56).

Handset

- 1 [MENU]#104
- 2 Enter the desired name (10 characters max.). → [SAVE] → [OFF]

Displaying the handset name

You can select whether or not the handset name is displayed in standby mode. The default setting is "off".

Handset

- 1 [MENU]#105
- 2 [↕]: Select the desired setting. → [SAVE] → [OFF]

Registering a unit

Operating additional units

Additional handsets

Up to 6 handsets can be registered to the base unit.

Important:

- See page 4 for information on the available model.

Registering a handset to the base unit

The supplied handset and base unit are pre-registered. If for some reason the handset is not registered to the base unit, re-register the handset.

- 1 **Handset:**
[MENU]#130
- 2 **Base unit:**
Press and hold [LOCATOR] for about 5 seconds.
 - If all registered handsets start ringing, press [LOCATOR] again to stop, then repeat this step.
- 3 **Handset:**
Press [OK], then wait until a long beep sounds.

Deregistering a handset

A handset can cancel its own registration to the base unit, or other handsets registered to the same base unit. This allows the handset to end its wireless connection with the system.

Handset / Base unit

- 1** **[MENU][#][1][3][1]**
 - All handsets registered to the base unit are displayed.
- 2** **[↕]**: Select the handset you want to cancel.
→ **[SELECT]**
- 3** **[↕]**: “Yes” → **[SELECT]**
- 4** Proceed with the operation for your unit.
Handset: [OFF]
Base unit: [EXIT]

Caller ID Service

Using Caller ID service

Important:

- This unit is Caller ID compatible. To use Caller ID features, you must subscribe to a Caller ID service. Contact your phone service provider for details.

Caller ID features

Handset / Base unit

When an outside call is being received, the caller information is displayed.

Caller information for the last 50 callers is logged in the caller list from the most recent call to the oldest.

- If the unit cannot receive caller information, the following is displayed:
 - “**Out of area**”: The caller dials from an area which does not provide a Caller ID service.
 - “**Private caller**”: The caller requests not to send caller information.
 - “**Long distance**”: The caller makes a long distance call.
- If the unit is connected to a PBX system, caller information may not be properly received. Contact your PBX supplier.

Missed calls

Handset / Base unit

If a call is not answered, the unit treats it as a missed call. The display shows “**Missed call**”.

Note:

- Even when there are unviewed missed calls, “**Missed call**” disappears from the standby display if the following operation is performed by one of the units:
 - A handset is replaced on the charger.
 - Pressing **[OFF]** on a handset.
 - Pressing **[EXIT]** on the base unit.

Phonebook name display

When caller information is received and it matches a phone number stored in the phonebook, the stored name in the phonebook is displayed and logged in the caller list.

Talking Caller ID

Handset / Base unit

This feature lets you know who is calling without looking at the display.

To use this feature, you must:

- subscribe to a Caller ID service of your phone service provider.
- turn this feature on (page 49).

When caller information is received, the handsets and/or base unit announce the caller's name or phone number received from your phone service provider following every ring.

- Name pronunciation may vary. This feature may not pronounce all names correctly.
- Caller ID service has a limit of how many characters can be displayed. If the caller's name is too long, the unit may not be able to display or announce the entire name.

Phonebook name announcement

When caller information is received and it matches a phone number stored in the phonebook, the stored name in the phonebook is announced.

Caller list

Important:

- Make sure the unit's date and time setting is correct (page 16).

Viewing the caller list and calling back

■ Using a cellular line

Handset

- 1 **[▼]** CID
- 2 Press **[▼]** to search from the most recent call, or **[▲]** to search from the oldest call.
- 3 To call back, press **[SELECT]**.
To exit, press **[OFF]**.
- 4 **[CELL]**
 - The unit starts dialing immediately in the following situations.
 - Only 1 cellular phone is paired.
 - A specific line is set to make cellular calls (page 21).
- 5 **[↕]**: Select the desired cellular phone. → **[SELECT]**

Base unit

- 1 [CID]
- 2 Press [▼] to search from the most recent call, or [▲] to search from the oldest call.
- 3 To call back, press [CELL 1] or [CELL 2], then lift the corded handset.
To exit, press [EXIT].

■ Using a landline

Handset / Base unit

- 1 Proceed with the operation for your unit.
Handset: [▼] CID
Base unit: [CID]
- 2 Press [▼] to search from the most recent call, or [▲] to search from the oldest call.
- 3 Proceed with the operation for your unit.
Handset:
 - To call back, press [↶].
 - To exit, press [OFF].**Base unit:**
 - To call back, lift the corded handset.
 - To exit, press [EXIT].

Note for handset and base unit:

- If the entry has already been viewed or answered, “✓” is displayed.
 - [C1] or [C2] indicates the caller information was received from the cellular line.
 - “\” or “?” indicates the caller information for blocked calls.

Editing a caller’s phone number

You can edit a phone number in the caller list by removing its area code and/or the long distance code “1”.

Handset

■ When a cellular phone is paired:

- 1 [▼] CID
- 2 [↕]: Select the desired entry. → [SELECT]
- 3 Press [X] (Edit) repeatedly until the phone number is shown in the desired format.
- 4 **Using a cellular line:**
To make a cellular call, continue from step 4, “Viewing the caller list and calling back”, page 58.
Using a landline:
[↶]

■ When a cellular phone is not paired:

- 1 [▼] CID
- 2 [↕]: Select the desired entry. → [MENU]
- 3 [↕]: “Edit” → [SELECT]
- 4 Press [EDIT] repeatedly until the phone number is shown in the desired format.
- 5 [↶]

Base unit

- 1 [CID]
- 2 [↕]: Select the desired entry.
- 3 Press [EDIT] repeatedly until the phone number is shown in the desired format.
- 4 **Using a cellular line:**
Press [CELL 1] or [CELL 2], then lift the corded handset.
Using a landline:
Lift the corded handset.

Caller ID number auto edit feature

Handset / Base unit

Once you call back an edited number, the unit which was used to call back remembers the area code and format of the edited number. The next time someone calls from the same area code, caller information is customized by the unit as follows:

- When the call is being received, the Caller ID number is displayed in the same format as the edited number.
- After the call has ended, the caller’s phone number is displayed in the same format as the edited number, when reviewed from the caller list.

For example, you can use this feature to set the unit to ignore the area code of callers in your area, so that you can call these local numbers using caller information without dialing the area code. To activate this feature, you must edit an entry in the caller list, then call that number. After that, phone numbers from that caller’s area code are edited automatically.

This feature can be set for each unit (page 51). The default setting is “On”.

Note:

- Phone numbers from the 4 most recently edited area codes are automatically edited.

Caller ID Service

Erasing selected caller information

Handset / Base unit

- 1 Proceed with the operation for your unit.
Handset: [▼] CID
Base unit: [CID]
- 2 [↕]: Select the desired entry.
- 3 [ERASE] → [↕]: “Yes” → [SELECT]
- 4 Proceed with the operation for your unit.
Handset: [OFF]
Base unit: [EXIT]

Erasing all caller information

Handset / Base unit

- 1 Proceed with the operation for your unit.
Handset: [▼] CID
Base unit: [CID]
- 2 [ERASE] → [↕]: “Yes” → [SELECT]
- 3 Proceed with the operation for your unit.
Handset: [OFF]
Base unit: [EXIT]

Copying phonebook from a cellular phone (phonebook transfer)

You can copy phonebook entries from the paired cellular phones or other cellular phones (not paired) to the unit's phonebook. A cellular phone must be compatible with Bluetooth wireless technology.

Important:

- Your cellular phone must support Phone Book Access Profile (PBAP) or Object Push Profile (OPP) specification.
- If a copied entry has 2 or more phone numbers, each phone number (6 max.) is stored as a separate entry with the same name.
- If a phonebook entry includes additional data such as a picture, that entry may fail to copy to the base unit.
- If your cellular phone includes international call entries, set the conversion codes before copying (page 61).

Handset / Base unit

- 1 **[MENU]** **#** **6** **1** **8**
- 2 **To copy from paired cellular phones:**
[↕]: Select the desired cellular phone. → **[SELECT]**
 - Copied items are stored to the group ("Cell 1" or "Cell 2") which the cellular phone is paired to.**To copy from other cellular phones (not paired):**
[↕]: "Other cell" → **[SELECT]** → **[↕]**: Select the group you want to copy to. → **[SELECT]**
- 3 **When "Use the cell to transfer phone book" is displayed:**
 Go to step 4.
When "Select mode" menu is displayed:
[↕]: Select "Auto" or "Manual". → **[SELECT]**
 "Auto": Download all entries from the cellular phone automatically. Go to step 5.
 "Manual": Copy entries you selected.
 - "Select mode" menu is displayed only when the cellular phone supports Phone Book Access Profile (PBAP) for Bluetooth connection.

- Some cellular phones may require you to perform an operation on the cellular phone even if you select "Auto".

4 Cellular phone:

Follow the instructions of your cellular phone to copy phonebook entries.

- For other cellular phones (not paired), you need to search for and select the base unit. The Bluetooth PIN (default: "0000") may be required. If your cellular phone shows PassKey confirmation on its display, follow the directions to proceed.
- The entries being copied are displayed on the unit.

5 Wait until "Completed" is displayed.

- You can continue copying other entries if necessary.

6 Proceed with the operation for your unit.

Handset: [OFF]
Base unit: [EXIT]

Note:

- Some copied entries may have characters which are not available. These characters can be displayed but cannot be entered when editing an entry.
- The unit does not support some characters. If a copied entry includes those characters, they are replaced with other available characters or "*".
- If you receive a call while copying phonebook entries, the copying procedure stops. Try again after finishing the call.

Setting conversion codes

You must first set the following 3 dialing codes in the base unit which you want to copy to before transferring the phonebook from your cellular phone (4 digits max. each).

- "International code": An international prefix used when you make an international call.
- "Country code": Your country code for international calls.
- "Trunk prefix": A trunk prefix; the initial digit(s) to be dialed in a domestic call, prior to the area code.

Handset / Base unit

- 1 **[MENU]**
- 2 To store "International code":
**1** **1** **7**
 To store "Country code": **#** **1** **1** **8**

Using Bluetooth® Devices

To store “**Trunk prefix**”: # [1] [1] [9]

- 3 Enter the desired number. → [SAVE]
- 4 Proceed with the operation for your unit.
Handset: [OFF]
Base unit: [EXIT]

Note:

- After you copy the entries, confirm that the numbers were transferred correctly.

Link to Cell app

For Android™ users

The free Link to Cell app helps you integrate your Android phone with your DECT phone for convenient use.

Important:

- Your cellular phone must support Serial Port Profile (SPP) specification.

■ Application (App) Alerts On/Off

This feature alerts your DECT phone when your paired Android phone receives the following alert information:

- [Google Calendar]™
- [Gmail]™
- [Text messages]
- [Facebook]
- [Twitter]
- [Instagram]
- [Low Battery] information

Please check the latest information for details on functions that can be alerted at the web page below.

<https://panasonic.net/cns/pcc/support/tel/appalerts/>

You can turn each type of alert on or off using the Link to Cell app. If you turn the alerting app on, your DECT phone alerts you with the corresponding information.

■ Phone Settings

Using your paired Android phone, you can program your Phone Settings for the following features:

- [Time adjustment]*1
- [Cell line only mode] (page 20)
- [International code], [Country code], and [Trunk prefix] (page 61)

*1 When your paired Android phone is within the base unit's range, the date and time

information is updated on the handset and base unit's display, if time adjustment feature is activated on your Android phone.

Installing the Link to Cell app

Download links are also available at the web page below.



<https://panasonic.net/cns/pcc/support/tel/appalerts/>

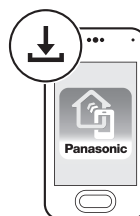

Starting the app for the first time

- 1 Make sure that your Android device's Bluetooth feature is turned on and that your Android device is paired to the base unit.
- 2 Start the Link to Cell app by tapping its icon.
- 3 Follow the on-screen instructions.

Important:

- For further information, refer to the instructions on web page listed above.
- To use this feature, the following settings are required.
 - **Android phone:** Bluetooth must be turned on.
 - **Android phone:** [Application Alerts manager] must be turned on.
 - **Handset or base unit:** “Alert On/Off” must be turned on (page 63).
- If this feature does not work, turn on your device's Bluetooth feature, unplug the base unit's AC adaptor, and then reconnect it.
- If this feature still does not work properly after performing the above operation, re-install the Link to Cell app.

Text message (SMS) alert

For iPhone® users

This feature alerts you on your DECT phone when your paired cellular phone receives SMS messages. The Link to Cell app is not required for iPhone users.

Important:

- Your cellular phone must support Message Access Profile (MAP) specification.
- For further information, refer to the instructions on web page listed below:
www.panasonic.net/pcc/support/tel/sms/
- To use this feature, the following settings are required.
 - **iPhone:** Bluetooth must be turned on.
 - **Handset or base unit:** “Alert On/Off” must be turned on (page 63).
- If this feature does not work, turn on your device’s Bluetooth feature, unplug the base unit’s AC adaptor, and then reconnect it.

Alert settings for your DECT phone

If your cellular phone is paired to the base unit and receives notifications, the handset and/or base unit can alert you:

- by briefly displaying a message
- by announcement
- by sounding alert tones

Important:

- For Android users: Use the Link to Cell app to enable the desired alerts (page 62).

Turning alert on/off

Once this feature is turned on, it will alert you on the handset and base unit when your cellular phone receives notifications.

- “On” (default): The handset and/or base unit alert you.
- “Off”: The handset and/or base unit do not alert you.

Handset / Base unit

- 1 For CELL 1: **[MENU]** **#6101**
For CELL 2: **[MENU]** **#6102**

- 2 **[↕]**: Select the desired setting. → **[SAVE]**
- 3 Proceed with the operation for your unit.
Handset: [OFF]
Base unit: [EXIT]

Setting the voice alert

You can turn on/off the voice alert.

- “On” (default): The handset and/or base unit notify you by voice announcement.
- “Off”: Voice announcement is not available as alert.

Handset / Base unit

- 1 For CELL 1: **[MENU]** **#6031**
For CELL 2: **[MENU]** **#6032**
- 2 **[↕]**: Select the desired setting. → **[SAVE]**
- 3 Proceed with the operation for your unit.
Handset: [OFF]
Base unit: [EXIT]

Selecting the alert tone

Handset

- 1 For CELL 1: **[MENU]** **#6041**
For CELL 2: **[MENU]** **#6042**
- 2 **[↕]**: Select the desired setting. → **[SAVE]**
→ **[OFF]**

Remote voice assist

For iPhone® and Android™ smartphone users

You can use the handset or base unit to operate the voice recognition feature of the paired cellular phone (Siri®, Google Now™, or S Voice). For example, you can speak into the handset or base unit and command your cellular phone to make a call.

Compatible voice recognition features

- Google Now, S Voice (Android 4.0 or later)
- Siri (iOS 8.0 or later)

Important:

- Your cellular phone must support the Hands Free Profile (HFP) specification.
- In order to use this feature, your cellular phone’s voice recognition feature must be ready to use.
 - iPhone: Make sure Siri is turned on.

Using Bluetooth® Devices

- Android: In order to use Google Now, make sure your cellular phone is registered to your Google account.
- If you have multiple voice recognition features available for your cellular phone, you may need to set the desired voice recognition feature as the default.
- For Android users: Depending on your cellular phone, you may need to set Google Now or S voice as your cellular phone's default voice recognition feature. For more information, refer to the operating instructions of your cellular phone.

Activating remote voice assist

Handset

- 1 Press [📞]
 - Go to step 3 in the following situations.
 - Only 1 cellular phone is paired.
 - A specific line is set to make cellular calls (page 21).
- 2 [↕]: Select the desired cellular phone. → [SELECT]
- 3 Wait until “voice assist” is displayed.
 - A confirmation tone sounds.
 - Speakerphone is turned on automatically.
 - To switch to the receiver, press [📞].
- 4 Speak your commands to your handset.
 - When you have finished using remote voice assist, press [OFF].

Base unit

- 1 Press [CELL 1] or [CELL 2]
 - Skip this step in the following situations.
 - Only 1 cellular phone is paired.
 - A specific line is set to make cellular calls (page 21).
- 2 Press [📞]
- 3 Wait until “voice assist” is displayed.
 - A confirmation tone sounds.
- 4 Speak your commands to your base unit.
 - When you have finished using remote voice assist, press [📞] or [📞].

Note:

- While using this feature, you cannot use another unit to make a cellular call using the same cellular line.

- If you receive a call on the landline or on another cellular line while using this feature, the interrupt tone sounds.
- If you receive a call on the same cellular line while using this feature, voice recognition ends and the unit receives the incoming call.
- If your cellular phone is connected to the base unit, you may not be able to use your cellular phone's microphone to operate its voice recognition feature. In this case, disconnect your cellular phone from the base unit.
- The compatible voice commands depends on the cellular phone voice recognition feature.

Using a Bluetooth headset (optional)

By pairing a Bluetooth headset to the base unit, you can enjoy hands-free conversations when talking on landline calls.

Important:

- Your Bluetooth headset must support the HeadSet Profile (HSP) specification.
- Only 1 Bluetooth headset can be paired to the base unit.
- Only 1 Bluetooth device can be used with the unit at a time*1.
- For best performance, we recommend using your Bluetooth headset within 1 m (3.3 feet) of the base unit. The base unit can communicate with Bluetooth headsets within an approximately 10 m (33 feet).

*1 You cannot use a Bluetooth headset to talk on a cellular line.

Pairing a Bluetooth headset to the base unit

Important:

- Make sure that the Bluetooth headset is not connected to any other Bluetooth device.

Handset / Base unit

- 1 **Bluetooth headset:**
Set your headset to pairing mode.
 - Refer to your headset's operating instructions.
- 2 [MENU]# [6] [2] [1]

- 3 If your headset PIN is “0000”, go to step 4. If your headset PIN is not “0000”, press **[CLEAR]**, then enter your headset’s PIN.
 - Typically, default PIN is “0000”. Refer to your headset’s operating instructions.
- 4 Press **[OK]**, then wait until a long beep sounds.
- 5 Proceed with the operation for your unit.

Handset: [OFF]
Base unit: [EXIT]

 - When **[QC]** is displayed on the base unit, the headset is available for use.

Connecting/disconnecting a Bluetooth headset

If you cannot connect the headset and base unit using the headset, you can connect using the unit. To use your headset with another Bluetooth device such as a cellular phone, you may need to disconnect it from the base unit.

Important:

- Make sure that the headset is turned on.

Handset / Base unit

- 1 To connect/disconnect:
[MENU][#][6][2][2]
 - A long beep sounds.
- 2 Proceed with the operation for your unit.

Handset: [OFF]
Base unit: [EXIT]

Unpairing a Bluetooth headset

You can cancel a pairing of the headset that is stored to the base unit.

Handset / Base unit

- 1 **[MENU][#][6][1][2]**
- 2 **[↕]: “Yes” → [SELECT]**
 - When the headset is unpaired, the **[QC]** disappears from the base unit display.
- 3 Proceed with the operation for your unit.

Handset: [OFF]
Base unit: [EXIT]

Operating a Bluetooth headset using a landline

Important:

- Refer to your headset’s operating instructions for details.

Making landline calls with your headset

Base unit

- 1 Press your headset’s button referring to your headset’s operating instructions.
- 2 Dial the phone number using the base unit after hearing the dial tone on your headset.
- 3 When you finish talking, press your headset’s button referring to your headset’s operating instructions.

Answering landline calls with your headset

To answer a landline call, press your headset’s button.

When you finish talking, press your headset’s button.

Note:

- If you cannot hang up the call using your headset, press **[⏏]** on the base unit 2 times.

Call sharing between your headset and the handset

Important:

- To activate this feature, you should set call sharing mode to on beforehand (page 51).

■ While the handset is on a landline call:

To join the conversation with your headset, press your headset’s button.

■ While your headset is on a landline call:

To join the conversation with the handset, press **[↶]**.

Switching between the base unit and your headset

You can switch between the base unit and your headset:

- during a landline call with the base unit.
- during an intercom call between the base unit and headset.
- while listening to messages recorded on the base unit answering system.

■ To switch to your headset:

Press **[↶]** on the base unit.

■ To switch to the base unit:

Lift the corded handset to talk with the corded handset.

or

Press **[⏏]** to talk with the speakerphone.

Using Bluetooth® Devices

Adjusting your headset receiver volume

Base unit

Press **[▲]** or **[▼]** repeatedly while using your headset.

Note:

- Depending on your headset, the receiver volume may not be adjustable.

Answering system for landline

The answering system can answer and record calls for you when you are unavailable to answer the phone.

The unit can be set to play a greeting message but not to record caller messages by selecting “**Greeting only**” as the recording time setting (page 73).

You can also record phone conversations (page 24, 29).

Important:

- Make sure the unit’s date and time setting is correct (page 16).

Memory capacity (including your greeting message)

The total recording capacity is about 18 minutes. A maximum of 64 messages can be recorded.

Note:

- When message memory becomes full:
 - “**Messages full**” is shown on the handset and base unit display.
 - The ANSWER ON/OFF indicator on the base unit flashes rapidly if the answering system is turned on.
 - If you use the pre-recorded greeting message, the unit automatically switches to another pre-recorded greeting message asking callers to call again later.
 - If you recorded your own greeting message, the same message is still announced to callers even though their messages are not recorded.

Turning the answering system on/off

Base unit

Press [**ANSWER ON/OFF**] to turn on/off the answering system.

Handset

- 1 To turn on:
[**MENU**]#**[3][2][7]**

- To turn off:
[**MENU**]#**[3][2][8]**
- 2 [**OFF**]

Note for base unit and handset:

- When the answering system is turned on, the ANSWER ON/OFF indicator on the base unit lights up.

Greeting message

When the unit answers a call, a greeting message is played to callers.

You can use either:

- your own greeting message
- a pre-recorded greeting message

Recording your greeting message

Handset / Base unit

- 1 [**MENU**]#**[3][0][2]**
- 2 [**↕**]: “**Yes**” → [**SELECT**]
- 3 After a beep sounds, speak clearly about 20 cm (8 inches) away from the microphone (2 minutes max.).
- 4 Press [**STOP**] to stop recording.
- 5 Proceed with the operation for your unit.
Handset: [**OFF**]
Base unit: [**EXIT**]

Using a pre-recorded greeting message

The unit provides 2 pre-recorded greeting messages:

- If you reset to pre-recorded greeting or do not record your own greeting message, the unit plays a pre-recorded greeting asking callers to leave a message.
- If the message recording time (page 73) is set to “**Greeting only**”, callers’ messages are not recorded and the unit plays a different pre-recorded greeting message asking callers to call again.

Resetting to a pre-recorded greeting message

Use this procedure to erase your greeting message and use a pre-recorded one.

Answering System for Landline

Handset / Base unit

- 1 [MENU]#304
- 2 [YES]
- 3 Proceed with the operation for your unit.
Handset: [OFF]
Base unit: [EXIT]

Playing back the greeting message

Handset / Base unit

- 1 [MENU]#303
- 2 Proceed with the operation for your unit.
Handset: To exit, press [OFF].
Base unit: To exit, press [EXIT].

Listening to messages

Important:

- When using the base unit or handset to listen to messages, the noise reduction feature (page 24) is activated automatically in spite of the setting ([NR] is not displayed).

Using the base unit

When new messages have been recorded:

- [▶■] on the base unit flashes.
- “New message” is displayed.

Press [▶■] (PLAY).

- During playback, [▶■] on the base unit lights.
- If new messages have been recorded, the base unit plays back new messages.
- If there are no new messages, the base unit plays back all messages.

Operating the answering system during playback

Key	Operation
[▲] or [▼]	Adjust the speaker volume
[I◀◀]	Repeat message*1
[▶▶]	Skip message
[PAUSE]	Pause message To resume playback, press [▶■].
[▶■] (STOP)	Stop playback
[ERASE]	Erase currently playing message

*1 If pressed within the first 5 seconds of a message, the previous message is played.

Calling back (Caller ID subscribers only)

■ Using a landline:

During playback, lift the corded handset.

- To edit the number before calling back, press [EDIT] repeatedly until the phone number is shown in the desired format (page 59).

■ Using a cellular line:

During playback, press [CELL 1] or [CELL 2], then lift the corded handset.

- To edit the number before calling back, press [EDIT] repeatedly until the phone number is shown in the desired format (page 59).

Erasing all messages

Press [ERASE] 2 times while the unit is not in use.

Using the handset

When new messages have been recorded, “New message” is displayed.

1 To listen to new messages:

[MENU]#323

To listen to all messages:

[MENU]#324

2 When finished, press [OFF].

Note:

- To switch to the receiver, press [↶].
- You can also use the [PLAY] soft key, if displayed, to play new messages.

Operating the answering system

[MENU] → [↕]: “Answering device” → [SELECT]

Key	Operation
[▲] or [▼]	Adjust the receiver/speaker volume (during playback)
[1] or [◀]	Repeat message (during playback)*1
[2] or [▶]	Skip message (during playback)
[3]	Enter the “Settings” menu
[4]	Play new messages
[5]	Play all messages
[6]	Play greeting message

Answering System for Landline

Key	Operation
[7][6]	Record greeting message
[8]	Turn answering system on
[PAUSE]	Pause message*2
[9] or [STOP]	Stop recording Stop playback
[0]	Turn answering system off
[*][4]*3	Erase currently playing message
[*][5]	Erase all messages
[*][6]	Reset to a pre-recorded greeting message

- *1 If pressed within the first 5 seconds of a message, the previous message is played.
- *2 To resume playback:
[↕]: "Playback" → [SELECT]
- *3 You can also erase as follows:
[PAUSE] → [↕]: "Erase" → [SELECT]
→ [↕]: "Yes" → [SELECT]

Calling back (Caller ID subscribers only)

■ Using a landline:

- 1 Press [PAUSE] during playback.
- 2 [↕]: "Call back" → [SELECT]

■ Using a cellular line:

- 1 Press [PAUSE] during playback.
- 2 [↕]: "Call back (Cell)" → [SELECT]
 - The unit starts dialing immediately in the following situations.
 - Only 1 cellular phone is paired.
 - A specific line is set to make cellular calls (page 21).
- 3 [↕]: Select the desired cellular phone. → [SELECT]

Editing the number before calling back

■ Using a landline:

- 1 Press [PAUSE] during playback.
- 2 [↕]: "Edit & Call" → [SELECT]
- 3 Press [EDIT] repeatedly until the phone number is shown in the desired format (page 59).
- 4 [↶]

■ Using a cellular line:

- 1 Press [PAUSE] during playback.

- 2 [↕]: "Edit & Call" → [SELECT]
- 3 Press [EDIT] repeatedly until the phone number is shown in the desired format (page 59).
- 4 [CELL]
 - The unit starts dialing immediately in the following situations.
 - Only 1 cellular phone is paired.
 - A specific line is set to make cellular calls (page 21).
- 5 [↕]: Select the desired cellular phone. → [SELECT]

Erasing all messages

- 1 [MENU][#][3][2][5]
- 2 [↕]: "Yes" → [SELECT] → [OFF]

Advanced new message alerting features

Audible message alert

This feature allows the base unit to beep to inform you of a new message arrival when new messages are recorded. The base unit beeps 2 times every minute until you listen to the messages, if the "Base unit beep" setting is turned on. The default setting is "OFF".

Handset / Base unit

- 1 [MENU][#][3][3][9]
- 2 [↕]: Select the desired setting. → [SAVE]
- 3 Proceed with the operation for your unit.
Handset: [OFF]
Base unit: [EXIT]

New message alert by a call

This feature allows you to receive a notification by phone when new messages are recorded. The base unit calls a phone number you specify. You can then operate the answering system remotely to listen to the new message.

To use this feature, you must:

- store a phone number to which the unit makes the call to.
- turn on the new message alert setting.

Answering System for Landline

After you answer the new message alert call, you can listen to messages from that call (page 71). This feature is only available for landline.

Important:

- A new message alert is stopped 1 minute after the unit starts to call. The unit will not retry the call even if the call is not answered.

Storing a phone number to which the unit makes an alert call

Handset

■ From the phonebook:

- 1 [MENU]#338
- 2 [↕]: "Notification to" → [SELECT] → [ADD]
- 3 [↕]: "Phonebook" → [SELECT]
- 4 [↕]: Select the desired phonebook entry. → [SAVE] → [OFF]

■ By entering a phone number:

- 1 [MENU]#338
- 2 [↕]: "Notification to" → [SELECT] → [ADD]
- 3 [↕]: "Manual" → [SELECT]
- 4 Enter the desired name (16 characters max.). → [OK]
- 5 Enter the desired number (24 digits max.). → [OK] → [SELECT] → [OFF]

Base unit

■ From the phonebook:

- 1 [MENU]#338
- 2 [↕]: "Notification to" → [SELECT] → [□□]
- 3 [↕]: Select the desired phonebook entry. → [SAVE] → [EXIT]

■ By entering a phone number:

- 1 [MENU]#338
- 2 [↕]: "Notification to" → [SELECT] → [EDIT]
- 3 Enter the desired name (16 characters max.). → [OK]
- 4 Enter the desired number (24 digits max.). → [OK] → [SELECT] → [EXIT]

Turning on/off the new message alert setting

Handset / Base unit

- 1 [MENU]#338
- 2 [↕]: "On/Off" → [SELECT]
- 3 [↕]: Select the desired setting. → [SAVE]
- 4 Proceed with the operation for your unit.
Handset: [OFF]
Base unit: [EXIT]

Editing the set phone number

Handset

- 1 [MENU]#338
- 2 [↕]: "Notification to" → [SELECT]
- 3 [MENU] → [↕]: "Edit" → [SELECT]
- 4 Edit the name if necessary (16 characters max.). → [OK]
- 5 Edit the phone number if necessary (24 digits max.). → [OK] → [SELECT] → [OFF]

Base unit

- 1 [MENU]#338
- 2 [↕]: "Notification to" → [SELECT] → [EDIT]
- 3 Edit the name if necessary (16 characters max.). → [OK]
- 4 Edit the phone number if necessary (24 digits max.). → [OK] → [SELECT] → [EXIT]

Erasing the set phone number

Handset

- 1 [MENU]#338
- 2 [↕]: "Notification to" → [SELECT]
- 3 [MENU] → [↕]: "Erase" → [SELECT]
- 4 [↕]: "Yes" → [SELECT] → [OFF]
 - The new message alert setting is turned off.

Base unit

- 1 [MENU]#338
- 2 [↕]: "Notification to" → [SELECT] → [ERASE]
- 3 [↕]: "Yes" → [SELECT] → [EXIT]
 - The new message alert setting is turned off.

Activating/inactivating the remote access code to play messages

If you activate this feature, you must enter the remote access code (page 71) to play the new message from the new message alert call. This is so that unauthorized parties cannot listen to your messages. The default setting is “Inactivate”.

- “Inactivate”: You can listen to the message by pressing **[4]** to play new messages (without entering the remote access code).
- “Activate”: You must enter your remote access code and then press **[4]** to play new message.

Handset / Base unit

- 1 **[MENU]****[#]****[3]****[3]****[8]**
- 2 **[↕]**: “Remote code” → **[SELECT]**
- 3 **[↕]**: Select the desired setting. → **[SAVE]**
- 4 Proceed with the operation for your unit.
Handset: **[OFF]**
Base unit: **[EXIT]**

Listening to messages

After you answer the new message alert, you can listen to the messages as follows.

■ When the remote access code is set to “Inactivate”:

Press **[4]** to play the new message during the announcement.

■ When the remote access code is set to “Activate”:

- 1 Enter the remote access code (page 71) during the announcement.
- 2 Press **[4]** to play the new message.

Note:

- Within 10 seconds after listening to new messages, you can press **[#]****[9]** during the call to turn off the new message alert by a call feature.
- Even if the unit makes a new message alert call, the handset redial list does not show the record. However, on the base unit redial list it is shown as “Message alert”.

Remote operation

Using a touch-tone phone, you can call your phone number from outside and access the unit to listen to messages or change answering system settings. The unit’s voice guidance prompts you to press certain dial keys to perform different operations.

Remote access code

A 3-digit remote access code must be entered when operating the answering system remotely. This code prevents unauthorized parties from listening to your messages remotely. The default setting is “111”.

Important:

- To prevent unauthorized access to this product, we recommend that you regularly change the remote code.

Handset / Base unit

- 1 **[MENU]****[#]****[3]****[0]****[6]**
- 2 Enter the desired 3-digit remote access code.
- 3 **[SAVE]**
- 4 Proceed with the operation for your unit.
Handset: **[OFF]**
Base unit: **[EXIT]**

Deactivating remote operation

Press **[X]** in step 2 on “Remote access code”, page 71.

- The entered remote access code is deleted.

Using the answering system remotely

- 1 Dial your landline phone number from a touch-tone phone.
- 2 After the greeting message starts, enter your remote access code.
- 3 Follow the voice guidance prompts as necessary or control the unit using remote commands (page 72).
- 4 When finished, hang up.

Answering System for Landline

Voice guidance

■ When the English voice guidance is selected

During remote operation, the unit's voice guidance starts and prompts you to press **[1]** to perform a specific operation, or press **[2]** to listen to more available operations.

■ When the Spanish voice guidance is selected

To start the voice guidance, press **[9]**. The voice guidance announces the available remote commands (page 72).

Note:

- If you do not press any dial keys within 10 seconds after a voice guidance prompt, the unit disconnects your call.

Remote commands

You can press dial keys to access certain answering system functions without waiting for the voice guidance to prompt you.

Key	Operation
[1]	Repeat message (during playback)*1
[2]	Skip message (during playback)
[4]	Play new messages
[5]	Play all messages
[9]	Stop playback*2 Start voice guidance*3
[0]	Turn answering system off
[X] [4]	Erase currently playing message
[X] [5]	Erase all messages
[X] [#]	End remote operation (or hang up)

*1 If pressed within the first 5 seconds of a message, the previous message is played.

*2 For English voice guidance only

*3 For Spanish voice guidance only

Turning on the answering system remotely

- 1 Dial your phone number from a touch-tone phone.
- 2 Let the phone ring 15 times.
 - A long beep is heard.

- 3 Enter your remote access code within 10 seconds after the long beep.

- The greeting message is played back.
- You can either hang up, or enter your remote access code again and begin remote operation (page 71).

Answering system settings

Call screening

Handset / Base unit

While a caller is leaving a message, you can listen to the call through the unit's speaker.

To adjust the speaker volume, press **[▲]** or **[▼]** repeatedly.

You can answer the call by:

- lifting the corded handset from the base unit, or
- pressing **[hook]** on the handset.

Call screening can be set for each unit. The default setting is "on".

- 1 **[MENU]#[3]10**
- 2 **[↕]**: Select the desired setting. → **[SAVE]**
- 3 Proceed with the operation for your unit.
Handset: [OFF]
Base unit: [EXIT]

Number of rings before the unit answers a call

You can change the number of times the phone rings "Ring count" before the unit answers calls. You can select 2 to 7 rings, or "To11 saver".

The default setting is "4 rings".

"To11 saver": The unit's answering system answers at the end of the 2nd ring when new messages have been recorded, or at the end of the 5th ring when there are no new messages. If you call your phone from outside to listen to new messages (page 71), you know that there are no new messages when the phone rings for the 3rd time. You can then hang up without being charged for the call.

Handset / Base unit

- 1 **[MENU]#[2]11**
- 2 **[↕]**: Select the desired setting. → **[SAVE]**

- 3 Proceed with the operation for your unit.

Handset: [OFF]

Base unit: [EXIT]

Caller's recording time

You can change the maximum message recording time allowed for each caller. The default setting is "3 min".

Handset / Base unit

- 1 [MENU] [#] [3] [0] [5]
- 2 [↕]: Select the desired setting. → [SAVE]
- 3 Proceed with the operation for your unit.
Handset: [OFF]
Base unit: [EXIT]

Selecting "Greeting only"

You can select "Greeting only" which sets the unit to announce a greeting message to callers but not record messages.

Select "Greeting only" in step 2 on "Caller's recording time", page 73.

Note:

- When you select "Greeting only":
 - If you do not record your own message, the unit will play the pre-recorded greeting-only message asking callers to call again later.
 - If you use your own message, record the greeting-only message asking callers to call again later (page 67).

Listening to voicemail messages

When new messages have been recorded, "Voicemail msg. via phone co." is displayed if message indication service is available.

Handset / Base unit

- 1 **[MENU]#330**
 - The speakerphone turns on.
 - Lift the corded handset if needed.
- 2 Follow the pre-recorded instructions.
- 3 When finished, hang up.

Note:

- You can also use the **[ACCESS]** soft key, if displayed, to play new voicemail messages.
- If the handset and base unit still indicate there are new messages even after you have listened to all new messages, turn it off by pressing and holding **[#]** until the handset or base unit beeps.

Wall mounting

The base unit can be mounted on a wall by changing the wall mounting adaptor's position.

Note:

- Make sure that the wall and the fixing method are strong enough to support the weight of the unit.

Base unit

- 1 To remove the wall mounting adaptor, push down the release levers (1). Remove the adaptor (2).

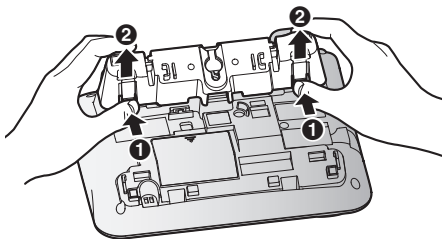

- 2
 - 1 Turn the adaptor so that the words "UP WALL" are facing up.
 - 2 Tuck the telephone line cord inside the wall mounting adaptor.
 - 3 Connect the AC adaptor cord and telephone line cord.

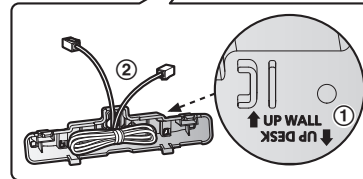
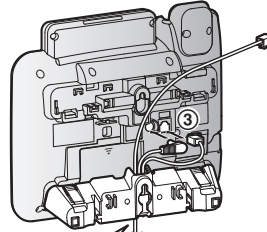

- 3 Insert the lower tabs of the adaptor into the unit's bottom slots (1), then insert by pushing down the levers of the adaptor into the upper slots (2).
 - The words "UP WALL" should be facing up.

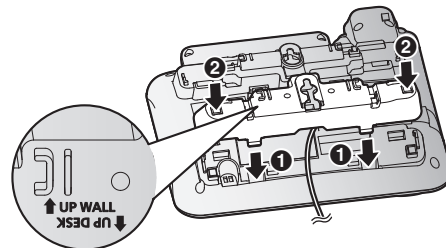

Useful Information

- 4 Mount the unit on a wall then slide down to secure in place.
- This product is compliant with the following wall phone plate sizes (2 types).
 - A** 83 mm (3 1/4 inches)
 - B** 102 mm (4 inches)
- Fit the slots of the unit onto the corresponding wall phone plate tabs for **(C)** and **(D)** respectively.

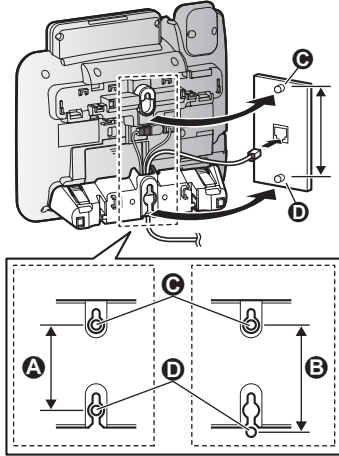

Charger

- Drive the screws **(A)** (not supplied) into the wall.
- B** 27.2 mm (1 1/16 inches)

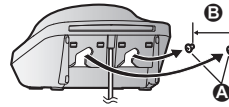

Error messages

Display message	Cause/solution
Ask phone company for VM access #	<ul style="list-style-type: none"> You have not stored the voicemail access number. Store the number (page 74).
Main unit no power or No link. Re-connect base AC adaptor.	<ul style="list-style-type: none"> Confirm the base unit's AC adaptor is connected to the unit and the power outlet correctly. The handset has lost communication with the base unit. Move closer to the base unit and try again. Unplug the base unit's AC adaptor to reset the unit. Reconnect the adaptor and try again. The handset's registration may have been canceled. Re-register the handset (page 56).

Useful Information

Display message	Cause/solution
Busy	<ul style="list-style-type: none"> • No cellular phone is paired to the base unit. Pair a cellular phone (page 18). • The called unit is in use. • Other units are in use and the system is busy. Try again later. • The handset you are using is too far from the base unit. Move closer and try again. • The automated call block function is in operation. Try again later. • One of the units is screening for telemarketing calls. Try again later. • One of the units is recording a conversation with an outside caller. Try again later. • Only 1 Bluetooth device can be used with the unit at a time. Try again later. • The voice recognition feature could not be activated. Try again later.
Check tel line	<ul style="list-style-type: none"> • The supplied telephone line cord has not been connected yet or not connected properly. Check the connections (page 10). • If you do not connect the telephone line cord and use only cellular lines, set the cellular line only mode (page 20).
Checking	<ul style="list-style-type: none"> • The automated call block function is in operation. Try again later.
Error!!	<ul style="list-style-type: none"> • Recording was too short. Try again. • Someone is using a cellular line or headset. Try again later. • The phonebook copy is incomplete (page 61). The cellular phone is disconnected from the base unit. Make sure that other Bluetooth devices are not connected to the cellular phone, and try again.
Memory full	<ul style="list-style-type: none"> • The recording memory is full. Erase unwanted recordings (page 68, 69).
Failed	<ul style="list-style-type: none"> • Although the unit tried to connect to the cellular phone or headset, the connection has been failed. <ul style="list-style-type: none"> – Someone is using a cellular line or headset. Try again later. – Make sure that the cellular phone or headset is not connected to other Bluetooth devices.
Invalid	<ul style="list-style-type: none"> • There is no handset registered to the base unit matching the handset number you entered. • The handset is not registered to the base unit. Register the handset (page 56).
Requires subscription to Caller ID.	<ul style="list-style-type: none"> • You must subscribe to a Caller ID service. Once you receive caller information after subscribing to a Caller ID service, this message will not be displayed.
Use rechargeable battery.	<ul style="list-style-type: none"> • A wrong type of battery such as alkaline or manganese was inserted. Use only the rechargeable Ni-MH batteries noted on page 4, 7.

Troubleshooting

If you still have difficulties after following the instructions in this section, disconnect the base unit's AC adaptor, then reconnect the base unit's AC adaptor. Remove the batteries from the handset, and then insert them into the handset again.

If the base unit batteries for power backup are installed, remove the batteries from the base unit, and then insert them into the base unit again.

For assistance, please visit <http://shop.panasonic.com/support>

77

Useful Information

General use

Problem	Cause/solution
The handset does not turn on even after installing charged batteries.	<ul style="list-style-type: none">● Place the handset on the charger to turn on the handset.
The unit does not work.	<ul style="list-style-type: none">● Make sure the batteries are installed correctly (page 10).● Fully charge the batteries (page 11).● Check the connections (page 10).● Unplug the base unit's AC adaptor to reset the unit. Reconnect the adaptor and try again.● The handset has not been registered to the base unit. Register the handset (page 56).
I cannot pair a cellular phone to the base unit.	<ul style="list-style-type: none">● Depending on the compatibility of the cellular phone, you may not be able to pair it to the base unit. Confirm that your cellular phone supports the hands-free profile (HFP) specification.● Confirm that the Bluetooth feature of your cellular phone is turned on. You may need to turn this feature on depending on your cellular phone.● The Bluetooth technology on your cellular phone may not be functioning normally. Turn off and on your cellular phone.● If your cellular phone is already connected to another Bluetooth device such as a Bluetooth headset, turn it off or disconnect it from your cellular phone.● Some cellular phones may require you to enter the Bluetooth PIN to pairing. Confirm that you entered the correct PIN.
I cannot connect a cellular phone to the base unit.	<ul style="list-style-type: none">● Confirm that your cellular phone is turned on.● Confirm that your cellular phone is within base unit range (page 15).● Your cellular phone's Bluetooth feature is turned off. Turn it on.● Depending on the state of the wireless environment, such as the presence of any electrical interference, there may be a delay even if the auto connection feature is turned on. You can connect to the base unit manually (page 20).● The cellular phone has not been paired to the base unit. Pair the cellular phone (page 18).● If your cellular phone is already connected to another Bluetooth device such as a Bluetooth headset or other Panasonic DECT phone, disconnect the device, then perform the connecting procedure to the base unit.● If your cellular phone is already registered on another Panasonic DECT phone, this function will not work properly. We strongly recommend that you remove the registration of this phone on both your cellular phone and on the other Panasonic DECT phone.
I cannot hear a dial tone.	<ul style="list-style-type: none">● The base unit's AC adaptor or telephone line cord is not connected. Check the connections.● Disconnect the base unit from the telephone line and connect the line to a known working telephone. If the working telephone operates properly, contact our service personnel to have the unit repaired. If the working telephone does not operate properly, contact your phone service provider.



Useful Information

Problem	Cause/solution
The base unit beeps.	<ul style="list-style-type: none"> New messages have been recorded. Listen to the new messages (page 68).
Error sound is heard when I press some keys on base unit.	<ul style="list-style-type: none"> Automated call block is being screened. Try again later.
The unit does not emit the specified number of rings.	<ul style="list-style-type: none"> The number of rings decreases by 1 from the specified number of rings in below situations: <ul style="list-style-type: none"> the first ring is turned off (“No”) (page 34). automated call block is set to “Block” (page 36). answer by voice command is set to “On” (page 31).
The unit does not work during a power failure.	<ul style="list-style-type: none"> You can insert 2 AAA (R03) batteries (not supplied) into the base unit that will power the unit temporarily in the event of a power failure (page 11). The base unit display is blank if the saving mode is “On” (page 12).

Menu list

Problem	Cause/solution
The display is in a language I cannot read.	<ul style="list-style-type: none"> Change the display language (page 16).
I cannot register a handset to a base unit.	<ul style="list-style-type: none"> The maximum number of handsets (6) is already registered to the base unit. Cancel unused handset registrations from the base unit (page 57).

Battery recharge

Problem	Cause/solution
The handset beeps and/or  flashes.	<ul style="list-style-type: none"> Battery charge is low. Fully charge the batteries (page 11).
I fully charged the batteries, but <ul style="list-style-type: none">  still flashes,  is displayed, or the operating time seems to be shorter. 	<ul style="list-style-type: none"> Clean the battery ends (\oplus, \ominus) and the charge contacts with a dry cloth and charge again. It is time to replace the batteries (page 10).

Making/answering calls, intercom

Problem	Cause/solution
 is displayed.	<ul style="list-style-type: none"> The handset is too far from the base unit. Move closer. The base unit's AC adaptor is not properly connected. Reconnect AC adaptor to the base unit. The handset is not registered to the base unit. Register it (page 56).

Useful Information

Problem	Cause/solution
Noise is heard, sound cuts in and out.	<ul style="list-style-type: none"> You are using the handset or base unit in an area with high electrical interference. Re-position the base unit and use the handset away from sources of interference. Move closer to the base unit. If you use a DSL/ADSL service, we recommend connecting a DSL/ADSL filter between the base unit and the telephone line jack. Contact your DSL/ADSL provider for details.
The handset or base unit does not ring.	<ul style="list-style-type: none"> The ringer volume for landline is turned off. Adjust the ringer volume (page 23, 28, 49). The ringer volume for cellular line is turned off. Adjust the ringer volume (page 23, 28, 47). The unit which is not selected to ring for cellular calls does not ring. To change the selection, see page 19. Silent mode is turned on. Turn it off (page 54). The ringer volume is turned off by pressing and holding [0] (⓪) on the handset. Press and hold [0] (⓪) again to turn it on (page 23).
I cannot make local calls with the handset or base unit using a cellular line.	<ul style="list-style-type: none"> You need to add your area code when making cellular calls. Store your area code in order to automatically add it to the beginning of the 7-digit phone number when making cellular calls (page 21).
I cannot make or answer cellular calls with the handset or base unit.	<ul style="list-style-type: none"> Depending on the cellular phone's compatibility (page 5), you may not be able to make or answer cellular calls even if the cellular phone is connected to the base unit. Make sure that the CELL indicator lights up and the cellular phone is connected to the base unit (page 20). Only 1 Bluetooth device can be used with the unit at a time. The cellular phone is being used separately from your system.
I can make and answer cellular calls but cannot hear a sound.	<ul style="list-style-type: none"> The Bluetooth technology on your cellular phone may not be functioning normally. Turn off and on your cellular phone. Disconnect and reconnect the base unit AC adaptor and try again.
I cannot switch cellular calls from the unit to the cellular phone.	<ul style="list-style-type: none"> Your cellular phone may not support this feature. Refer to the operating instructions of your cellular phone.
I cannot make a call using a landline.	<ul style="list-style-type: none"> The dialing mode may be set incorrectly. Change the setting (page 17).
I cannot use a cellular line.	<ul style="list-style-type: none"> The unit cannot be used to talk on 2 cellular lines at the same time. Try again later.
The handset or base unit does not ring using the cellular phone's ringer tone even when the ring as cell mode is turned on.	<ul style="list-style-type: none"> If answer by voice command is turned on, the units use the preset ringer tones (CELL 1: Tone 2, CELL 2: Tone 4) when receiving calls. To change the setting, see page 31.
I cannot answer an incoming call using voice commands.	<ul style="list-style-type: none"> The answer by voice command feature is turned off. To turn it on, see page 31. Baby monitor is set to "on". Turn off the baby monitor feature (page 55).

Useful Information

Problem	Cause/solution
The unit answers an incoming call on its own.	<ul style="list-style-type: none"> • This situation might happen due to a false detection of ambient noise (dog barking, TV sound, etc.). Move the unit further away from the noise sources. • If you are using other telephone that has Talking Caller ID feature turned on, it may also trigger false detection. Turn the Talking Caller ID feature off on the other telephone. • To minimize false detection, decrease the sensitivity level of the answer by voice command (page 31, 51).
I cannot make long distance calls.	<ul style="list-style-type: none"> • Make sure that you have long distance service.
I cannot use voice paging.	<ul style="list-style-type: none"> • You cannot use voice paging if other units are in use.

Call block

Problem	Cause/solution
The dedicated key for Telemarketing call block is not displayed.	<ul style="list-style-type: none"> • While on the charger, the [TELE.BLK.] key is not available. Lift the handset from the charger. • If the Auto talk feature is set to on, the call is answered automatically when the handset is lifted from the charger during an incoming call. Turn off the auto talk feature (page 51).

Caller ID/Talking Caller ID

Problem	Cause/solution
Caller information is not displayed.	<ul style="list-style-type: none"> • You must subscribe to Caller ID service. Contact your phone service provider for details. • If your unit is connected to any additional telephone equipment such as a Caller ID box or cordless telephone line jack, plug the unit directly into the wall jack. • If you use a DSL/ADSL service, we recommend connecting a DSL/ADSL filter between the base unit and the telephone line jack. Contact your DSL/ADSL provider for details. • The name display service for landline calls may not be available in some areas. Contact your phone service provider for details. • Other telephone equipment may be interfering with this unit. Disconnect the other equipment and try again.
Caller information is displayed or announced late.	<ul style="list-style-type: none"> • Depending on your phone service provider, the unit may display or announce the caller's information at the 2nd ring or later. • Move closer to the base unit.

Useful Information

Problem	Cause/solution
Caller information is not announced.	<ul style="list-style-type: none"> • The ringer volume for landline is turned off. Adjust the ringer volume (page 23, 28, 49). • The ringer volume for cellular line is turned off. Adjust the ringer volume (page 23, 28, 47). • The unit which is not selected to ring for cellular calls does not announce caller information. To change the selection, see page 19. • The Talking Caller ID feature is turned off. Turn it on (page 49). • The ring as cell mode is set to "On (without Talking CID)". To change the mode, see page 19. • The number of rings for the answering system is set to "2 rings" or "Toll saver". Select a different setting (page 72). • Your unit does not announce caller information while the other devices such as headset or handsets are engaged in a call.
The caller list/incoming phone numbers are not edited automatically.	<ul style="list-style-type: none"> • The Caller ID number auto edit feature is turned off. Turn it on and try again (page 51). • You need to call back the edited number to activate Caller ID number auto edit.
I cannot dial the phone number edited in the caller list.	<ul style="list-style-type: none"> • The phone number you dialed might have been edited incorrectly (for example, the long distance "1" or the area code is missing). Edit the phone number with another pattern (page 59).
Time on the unit has shifted.	<ul style="list-style-type: none"> • Incorrect time information from incoming Caller ID changes the time. Set the time adjustment to "Manual1" (off) (page 49).
The 2nd caller's information is not displayed during an outside call.	<ul style="list-style-type: none"> • In order to use Caller ID, call waiting, or Call Waiting Caller ID (CWID), you must first contact your phone service provider and subscribe to the desired service. After subscribing, you may need to contact your phone service provider again to activate this specific service, even if you already subscribed to both Caller ID and Call Waiting with Caller ID services (CWID).

Using Bluetooth devices

Problem	Cause/solution
I cannot copy phonebook entries from a cellular phone.	<ul style="list-style-type: none"> • Confirm that the cellular phone supports Bluetooth wireless technology. • Confirm that the cellular phone supports the Phone Book Access Profile (PBAP) or Object Push Profile (OPP) specification. • If the cellular phone is already connected to another Bluetooth device such as a Bluetooth headset, turn the device off or disconnect it from the cellular phone. • Someone is using a cellular line or headset. Try again later. • Turn the cellular phone off, then turn it on and try again. • If an entry is already stored in the unit's phonebook, the entry cannot be copied even by selecting another group. • iPhone does not support individual phonebook copy.

Useful Information

Problem	Cause/solution
I cannot have a conversation using the headset. or I cannot connect my headset to the base unit.	<ul style="list-style-type: none"> ● Confirm that the Bluetooth wireless headset supports the HeadSet Profile (HSP) specification. ● Your Bluetooth headset is not paired. Pair it (page 64). ● Turn your headset off, then turn it on and try again. ● If your headset is already connected to another Bluetooth device such as your cellular phone, disconnect the headset from your cellular phone, then perform the connecting procedure from the base unit. ● Only 1 Bluetooth device can be used with the unit at a time.
Noise is heard during a call on the headset.	<ul style="list-style-type: none"> ● A Bluetooth headset can communicate with the base unit within a range of approximately 10 m (33 feet). The connection may be subject to interference from obstructions such as walls or electronic devices. Move closer to the base unit.
Some headset enhanced features are not available.	<ul style="list-style-type: none"> ● The base unit does not support enhanced features such as Last number redial or Call reject.
An error tone is heard when I try to program the Bluetooth feature.	<ul style="list-style-type: none"> ● The Bluetooth feature cannot be accessed immediately after connecting the AC adaptor to the base unit. Wait a few seconds and try again. ● The headset has not connected to the base unit yet, even though you performed the connecting procedure setting. Wait a few seconds and try again.
App alert is not displayed or announced. or Text message alert is not displayed or announced.	<ul style="list-style-type: none"> ● Confirm that the cellular phone supports the Message Access Profile (MAP) specification to use text message alert feature. ● Confirm that the cellular phone supports the Serial Port Profile (SPP) specification to use App alert feature. ● Confirm that the [Application Alerts manager] setting of your Android phone is turned on. ● “Alert On/Off” is set to “off”. Set it to “On” (page 63). ● “Voice alert” is set to “off”. Set it to “On” (page 63). ● The Bluetooth device’s Bluetooth notifications setting is turned off. ● The handset selected to display and/or announce alerts is in use. ● The Bluetooth device or its corresponding cellular line is in use. ● Your cellular phone’s Bluetooth feature is turned off. Turn it on. ● The unit which is not selected to ring for cellular calls does not ring. To change the selection, see page 19.
Your cellular phone’s voice recognition feature does not start after pressing [].	<ul style="list-style-type: none"> ● This feature may not be available when your cellular phone is in use. Try again later. ● If you cannot use this feature while your cellular phone is locked, unlock your phone and try again. ● For some cellular phones, you may be able to set your phone to allow its voice recognition feature to be used even when the phone is locked. For more information, refer to the operating instructions of your cellular phone. ● You may not be able to use this feature if other features or applications on your cellular phone are using Bluetooth features. Turn off these features or exit these applications, and then try again.

Useful Information

Problem	Cause/solution
The desired app does not start when you try to start the app using remote voice assist.	<ul style="list-style-type: none"> In order to use this feature, your cellular phone's voice recognition feature must be ready to use. <ul style="list-style-type: none"> iPhone: Make sure Siri is turned on. Android: In order to use Google Now, make sure your cellular phone is registered to your Google account. If you have multiple voice recognition features installed in your cellular phone, you may need to set the desired voice recognition feature as the default. If you cannot set the default, delete the other voice recognition features.

Answering system

Problem	Cause/solution
The unit does not record new messages.	<ul style="list-style-type: none"> The answering system is turned off. Turn it on (page 67). The answering system does not answer or record calls from cellular lines. The message memory is full. Erase unnecessary messages (page 68, 69). The recording time is set to "Greeting only". Change the setting (page 73). Your phone service provider's voicemail service may be answering your calls before the unit's answering system can answer your calls. Change the unit's number of rings setting (page 72) to a lower value, or contact your phone service provider. The answering system will not answer incoming calls while the other devices such as headset or handsets are engaged in a call.
I cannot operate the answering system remotely.	<ul style="list-style-type: none"> The remote access code is not set. Set the remote access code (page 71). You are entering the wrong remote access code. If you have forgotten your remote access code, enter the remote access code setting to check your current code (page 71). The answering system is turned off. Turn it on (page 72). You cannot operate the answering system when calling a cellular phone paired to the base unit.

Bluetooth PIN

Problem	Cause/solution
I cannot remember the PIN.	<ul style="list-style-type: none"> Change the PIN using the following method. <p>Handset/Base unit:</p> <ol style="list-style-type: none"> [MENU]#[6][1][9] [*][7][0][0][0] Enter the new 4-digit PIN. → [OK] Enter the new 4-digit PIN again. → [SAVE] → [OFF]/[EXIT]

Voicemail

Problem	Cause/solution
<p>“Voicemail msg. via phone co.” is shown on the display. How do I remove this message from the display?</p>	<ul style="list-style-type: none"> This notification is displayed when your phone service provider’s voicemail service (not the unit’s answering system) has recorded a message for you. Typically you can remove this notification from the display by listening to the message. To listen to the message, dial the voicemail number provided by your phone service provider (for most cases, this will be your own phone number), and follow the voice instructions. Depending on your phone service provider, you may need to remove all messages from your voice mailbox to remove the notification. You can also remove this notification by pressing and holding # until the unit beeps.

Liquid damage

Problem	Cause/solution
<p>Liquid or other form of moisture has entered the handset/base unit.</p>	<ul style="list-style-type: none"> Disconnect the AC adaptor and telephone line cord from the base unit. Remove the batteries from the handset and leave to dry for at least 3 days. After the handset/base unit are completely dry, reconnect the AC adaptor and telephone line cord. Insert the batteries and charge fully before use. If the unit does not work properly, contact an authorized service center.

Caution:

- To avoid permanent damage, do not use a microwave oven to speed up the drying process.

FCC and other information

This equipment complies with Part 68 of the FCC rules and the requirements adopted by the ACTA. On the bottom of this equipment is a label that contains, among other information, a product identifier in the format US:ACJ-----.

If requested, this number must be provided to the telephone company.

- Registration No.....(found on the bottom of the unit)
- Ringer Equivalence No. (REN).....0.1A

A plug and jack used to connect this equipment to the premises wiring and telephone network must comply with the applicable FCC Part 68 rules and requirements adopted by the ACTA. A compliant telephone cord and modular plug is provided with the product. It is designed to be connected to a compatible modular jack that is also compliant.

The REN is used to determine the number of devices that may be connected to a telephone line. Excessive RENs on a telephone line may

result in the devices not ringing in response to an incoming call. In most but not all areas, the sum of RENs should not exceed five (5.0). To be certain of the number of devices that may be connected to a line, as determined by the total RENs, contact the local telephone company. For products approved after July 23, 2001, the REN for the product is part of the product identifier that has the format US:AAAEQ##TXXXX. The digits represented by ## are the REN without a decimal point (e.g., 03 is a REN of 0.3).

If this equipment causes harm to the telephone network, the telephone company will notify you in advance that temporary discontinuance of service may be required. But if advance notice isn’t practical, the telephone company will notify the customer as soon as possible. Also, you will be advised of your right to file a complaint with the FCC if you believe it is necessary.

The telephone company may make changes in its facilities, equipment, operations or procedures that could affect the operation of the equipment. If this happens the telephone company will provide

Useful Information

advance notice in order for you to make necessary modifications to maintain uninterrupted service.

If trouble is experienced with this equipment, for repair or warranty information, please contact a Factory Service Center or other Authorized Servicer. If the equipment is causing harm to the telephone network, the telephone company may request that you disconnect the equipment until the problem is resolved.

Connection to party line service is subject to state tariffs. Contact the state public utility commission, public service commission or corporation commission for information.

If your home has specially wired alarm equipment connected to the telephone line, ensure the installation of this equipment does not disable your alarm equipment. If you have questions about what will disable alarm equipment, consult your telephone company or a qualified installer.

This equipment is hearing aid compatible as defined by the FCC in 47 CFR Section 68.316.

When you hold the phone to your ear, noise might be heard in your Hearing Aid. Some Hearing Aids are not adequately shielded from external RF (radio frequency) energy. If noise occurs, use an optional headset accessory or the speakerphone option (if applicable) when using this phone. Consult with your audiologist or Hearing Aid manufacturer about the availability of Hearing Aids which provide adequate shielding to RF energy commonly emitted by digital devices.

WHEN PROGRAMMING EMERGENCY NUMBERS AND/OR MAKING TEST CALLS TO EMERGENCY NUMBERS:

1. Remain on the line and briefly explain to the dispatcher the reason for the call.
2. Perform such activities in the off-peak hours, such as early morning or late evenings.

This device complies with Part 15 of the FCC Rules. Operation is subject to the following two conditions:

(1) This device may not cause harmful interference, and (2) this device must accept any interference received, including interference that may cause undesired operation. Privacy of communications may not be ensured when using this phone.

CAUTION:

Any changes or modifications not expressly approved by the party responsible for compliance could void the user's authority to operate this device.

NOTE:

This equipment has been tested and found to comply with the limits for a Class B digital device, pursuant to Part 15 of the FCC Rules. These limits are designed to provide reasonable protection against harmful interference in a residential installation. This equipment generates, uses, and can radiate radio frequency energy and, if not installed and used in accordance with the instructions, may cause harmful interference to radio communications. However, there is no guarantee that interference will not occur in a particular installation. If this equipment does cause harmful interference to radio or television reception, which can be determined by turning the equipment off and on, the user is encouraged to try to correct the interference by one or more of the following measures:

- Reorient or relocate the receiving antenna.
- Increase the separation between the equipment and receiver.
- Connect the equipment into an outlet on a circuit different from that to which the receiver is connected.
- Consult the dealer or an experienced radio/TV technician for help.

Some cordless telephones operate at frequencies that may cause interference to nearby TVs and VCRs. To minimize or prevent such interference, the base of the cordless telephone should not be placed near or on top of a TV or VCR. If interference is experienced, move the cordless telephone further away from the TV or VCR. This will often reduce or eliminate interference.

FCC RF Exposure Warning:

- This product complies with FCC radiation exposure limits set forth for an uncontrolled environment.
- To comply with FCC RF exposure requirements, the base unit must be installed and operated 20 cm (8 inches) or more between the product and all person's body.
- This product may not be collocated or operated in conjunction with any other antenna or transmitter.

- The handset may be carried and operated with only the specific provided belt-clip. Other non-tested belt-clips or similar body-worn accessories may not comply and must be avoided.

Notice:

- FCC ID can be found inside the battery compartment or on the bottom of the units.

Compliance with TIA-1083 standard:

Telephone handsets identified with this logo have reduced noise and interference when used with T-Coil equipped hearing aids and cochlear implants.

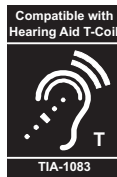

Charge only mode

The charge only mode is the dedicated mode to charge the backup batteries of the base unit. Do not use this mode if it is unnecessary because all functions except the base unit's battery charge is disabled with this feature on. Leave all the registered handsets on the chargers during use of the charge only mode.

■ **To activate the charge only mode:**

- 1 Disconnect the telephone line cord, the AC adaptor plug, and remove the batteries from the base unit with the corded handset placed on the cradle.
- 2 Press and hold **[3]**, **[MUTE]**, and **[HOLD]** at the same time, then insert the AC adaptor plug to the base unit.
Keep on pressing these keys until:
 - a beep tone sounds, and
 - the ANSWER ON/OFF indicator and SP-PHONE indicator flash once.
- 3 Release these keys.
 - LCD turns off.
- 4 Insert batteries.
 - The batteries are started to be charged.

Note:

- If the LCD is still on when you release the keys, the base unit is not in the charging only mode. Repeat from step 1. The charge only mode is

anceled when the corded handset comes off during or after setting up.

■ **To deactivate the charge only mode:**

- Lift the corded handset from the base unit and replace it.
- Press any key.
- 24 hours passed after activating the charge only mode.

Guía Rápida Española

Conexiones

Unidad base

- ① Conecte el adaptador de corriente alterna a la unidad presionándolo firmemente.
- ② Conecte el cable de la línea telefónica a la unidad hasta que escuche un clic.
- ③ Enganche el cable del adaptador de corriente alterna y el cable de la línea telefónica para fijarlos.
- ④ Conecte el adaptador de corriente alterna a la toma de corriente.
- ⑤ Conecte el cable de la línea telefónica a la toma de una sola línea telefónica (RJ11C) hasta que escuche un clic.
- ⑥ Requiere un filtro DSL/ADSL (no incluido) si dispone de este tipo de servicio.
- ⑦ Conecte el cable del auricular alámbrico a este y a la unidad base hasta que escuche un clic.

Nota:

- Use solo el adaptador de corriente alterna Panasonic PNLV226 que se suministra.

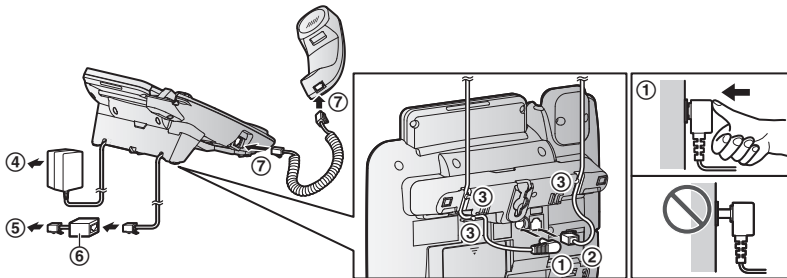

Cargador

- ① Conecte el adaptador de corriente alterna a la toma de corriente.

