

Test Report

Product	DECT Base Station with Bluetooth		
Name and address of the applicant	Panasonic Corporation of North America Two Riverfront Plaza, 9 th Floor Newark, 07102-5490, NJ, USA		
Name and address of the manufacturer	Panasonic Corporation 1-62, 4-chome, Minoshima, Hakata-ku Fukuoka, 812-8531, Japan		
Model	KX-TGE660 / KX-TGE680AC		
Rating	120V 60Hz (Input: 120V ~60Hz 0.1A; Output: 5.5V 0.5A, 2.75W)		
Trademark	Panasonic		
Serial number	4332900012		
Additional information	DECT 6.0, Bluetooth 4.2, GFSK only		
Tested according to	FCC Part 15, subpart B Other Class B Digital Device Industry Canada ICES-003, Issue 7 Information Technology Equipment (ITE)		
Order number	433290		
Tested in period	2021-03-24 to 2021-04-15		
Issue date	2021-05-05		
Name and address of the testing laboratory	 Instituttveien 6 Kjeller, Norway www.nemko.com	CAB Number: FCC: NO0001 ISED: NO0470 TEL: +47 22 96 03 30 FAX: +47 22 96 05 50	 
An accredited technical test executed under the Norwegian accreditation scheme			
 Prepared by [Frode Sveinsen]		 Approved by [G.Suhanthakumar]	
<p>This report shall not be reproduced except in full without the written approval of Nemko. Opinions and interpretations expressed within this report are not part of the current accreditation. This report was originally distributed electronically with digital signatures. For more information contact Nemko.</p>			

CONTENTS

1	INFORMATION	3
1.1	Tested Item	3
1.2	Test Environment	4
1.3	Test Engineer(s)	4
1.4	Test Equipment	4
1.5	Test Configurations	4
1.6	Other Comments	4
2	TEST REPORT SUMMARY	5
2.1	General	5
2.2	Test Summary	6
3	TEST RESULTS	7
3.1	Power Line Conducted Emissions	7
3.2	Spurious Emissions (Radiated)	9
4	MEASUREMENT UNCERTAINTY	11
5	TEST SETUPS	12
5.1	Radiated Emissions Test	12
5.2	Power Line Conducted Emissions Test	12
6	TEST EQUIPMENT USED	13

1 INFORMATION

1.1 Tested Item

Name	Panasonic
Model name	KX-TGE660 (US Model) KX-TGE680AC (Canadian Model)
FCC ID	ACJ96NKX-TGE660A
FCC / ISED Class	B – Residential Use
Serial number	4332900012
Hardware identity and/or version	PNLB2728
Software identity and/or version	SW400
AC Adaptor(s)	AC Adaptor PNLV226 (Input: 120V ~60Hz 0.1A, Output: 5.5V _{DC} 0.5A, 2.75W)
Interfaces	PSTN

Description of Tested Device(s)

The tested equipment is a DECT Base Station with Bluetooth transceiver.

1.2 Test Environment

Temperature:	20 – 25 °C
Relative humidity:	30 – 50 %
Normal test voltage:	120 V 60 Hz

The values are the limit registered during the test period.

1.3 Test Engineer(s)

Frode Sveinsen

1.4 Test Equipment

See list of test equipment in clause 6.

1.5 Test Configurations

Test Configuration	The test was performed with the EUT connected to a 120 V 60 Hz power source
Connections	The PSTN line was terminated in 50 Ohm during all tests.

1.6 Other Comments

All tests were performed with all ports populated and operating.

2 TEST REPORT SUMMARY

2.1 General

All measurements are traceable to national standards.

All tests were performed in accordance with ANSI C63.4-2014 where applicable. Radiated emissions are made in a 10m semi-anechoic chamber. A description of the test facility is on file with FCC and Industry Canada.



THIS TEST REPORT APPLIES ONLY TO THE ITEM(S) AND CONFIGURATIONS TESTED.

Deviations from, additions to, or exclusions from the test specifications are described in "Summary of Test Data".

Nemko Group authorizes the above named entity to reproduce this report provided it is reproduced in its entirety and for use by the entity's employees only. Any reproduction of parts of this report requires approval in writing from Nemko Group.

Any use that a third party makes of this report, or any reliance on or decisions to be made based on it, are the responsibility of such third parties. Nemko Group accepts no responsibility for damages suffered by any third party caused by decisions made or actions based on this report.

2.2 Test Summary

Name of test	FCC CFR 47, Paragraph #	ISED RSS-GEN, Issue 5, Paragraph #	ISED ICES-003, Issue 7, Paragraph #	Verdict
Power Line Conducted Emission	15.107(a) 15.207(a)	7.2	3.2.1	Complies
Spurious Emissions (Radiated)	15.109	7.3	3.2.2	Complies

3 TEST RESULTS

3.1 Power Line Conducted Emissions

FCC Part 15.107 (a)

ISED RSS-Gen Issue 5, Clause 7.2

ISED ICES-003 Issue 7, Clause 3.2.1

Measurement procedure: ANSI C63.4-2014 using 50 μ H/50 ohms LISN.

Test Results: Complies

Measurement Data: See attached plots
 Tested with AC Adaptor PNLV226

Highest measured value (L1 and N):

Handset Charging, 120V 60Hz:

Frequency (MHz)	QuasiPeak (dB μ V)	Average (dB μ V)	Limit (dB μ V)	Margin (dB)	Meas. Time (ms)	Bandwidth (kHz)	Line	Filter
0.166	---	26.31	55.16	28.85	1000	9	N	OFF
0.166	33.43	---	65.16	31.72	1000	9	L1	OFF
0.312	---	24.29	49.92	25.63	1000	9	N	OFF
0.312	36.48	---	59.92	23.44	1000	9	N	OFF
2.944	28.98	---	56.00	27.02	1000	9	N	OFF

Active Call, 120V 60Hz:

Frequency (MHz)	QuasiPeak (dB μ V)	Average (dB μ V)	Limit (dB μ V)	Margin (dB)	Meas. Time (ms)	Bandwidth (kHz)	Line	Filter
0.166	---	25.03	55.16	30.13	1000	9	N	OFF
0.170	30.04	---	64.96	34.92	1000	9	N	OFF
0.320	36.96	---	59.71	22.74	1000	9	N	OFF
0.324	---	22.44	49.60	27.17	1000	9	N	OFF
3.264	25.58	---	56.00	30.42	1000	9	N	OFF
4.196	24.50	---	56.00	31.50	1000	9	N	OFF

Full Spectrum

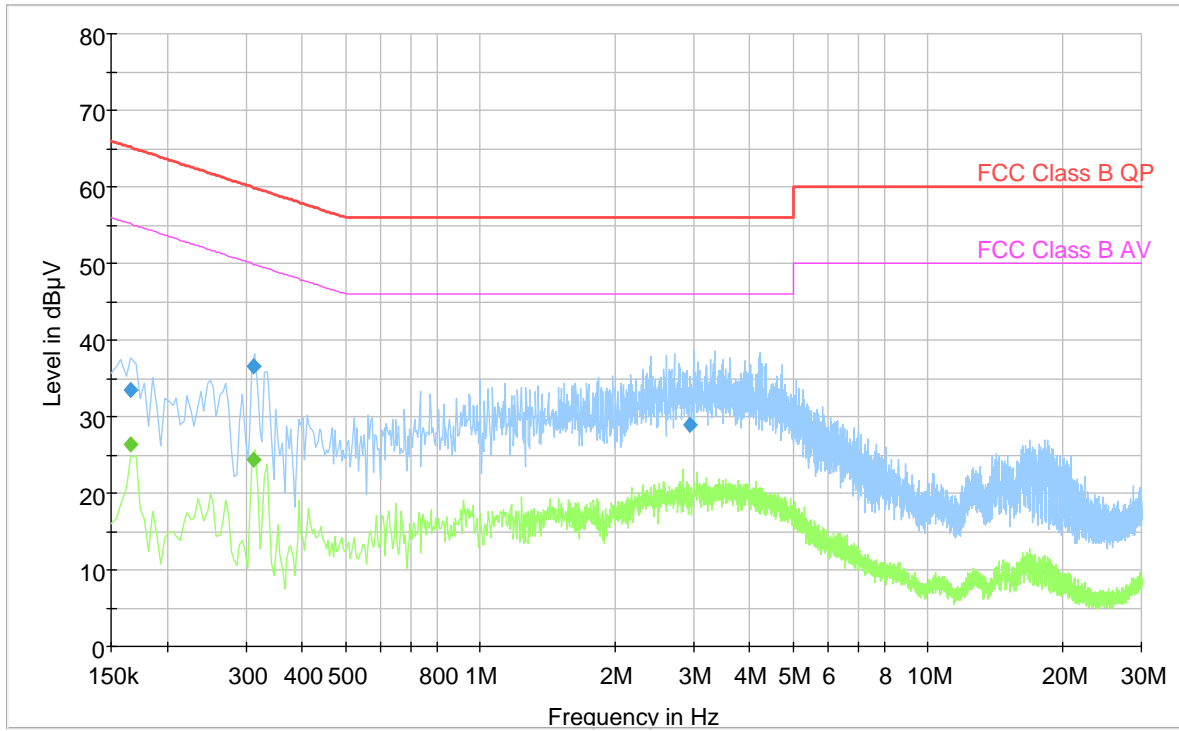

Handset Charging, 120V 60Hz

Full Spectrum

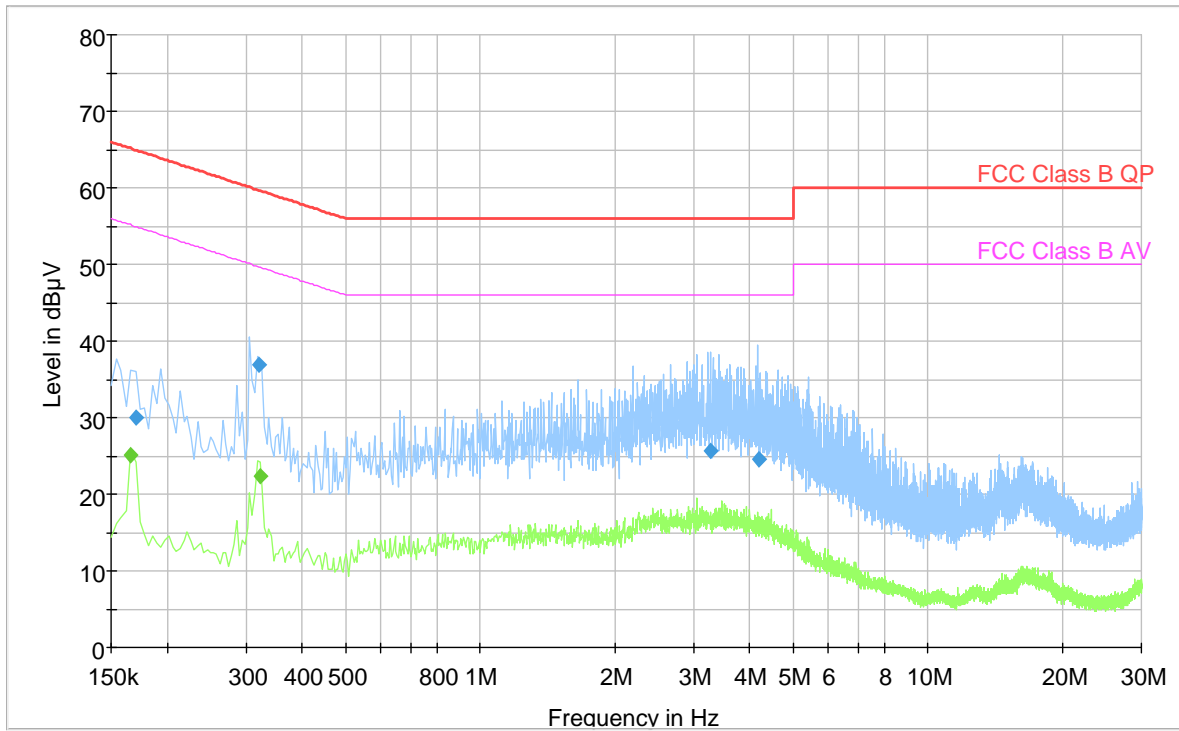

Active Call, 120V 60Hz

3.2 Spurious Emissions (Radiated)

FCC Part 15.109

ISED RSS-Gen Issue 5, Clause 7.3

ISED ICES-003 Issue 7, Clause 3.2.2

Test Results: Complies

Radiated Emissions 30 - 1000 MHz

Measuring distance: 3m

The EUT were rotated 360 degrees and the antenna height varied between 1m and 4m.

Measured Frequency (MHz)	Carrier Frequency (MHz)	Detector	Measured Emission (dBµV/m)	Limit (dBµV/m)	Margin (dB)
30 – 88	Hopping	Peak	< 30	40.0	> 10
88 – 216	Hopping	Peak	< 30	43.5	> 13.5
216 – 960	Hopping	Peak	< 30	46.0	> 46
960 – 1000	Hopping	Peak	< 30	54.0	> 24
60.8	Hopping	QP	25.4	40.0	14.6

See attached plots.

Requirements/Limit

FCC	Part 15.109	
ISED	ICES-003 Issue 7, Clause 3.2.2	
Frequency	Radiated emission limit @3 meters	
30 – 88 MHz	100 µV/m	40.0 dBµV/m
88 – 216 MHz	150 µV/m	43.5 dBµV/m
216 – 960 MHz	200 µV/m	46.0 dBµV/m
960 – 1000 MHz	500 µV/m	54.0 dBµV/m
	Limits above are with QuasiPeak Detector	

¹ The limit above 1000 MHz is specified for Average Detector, when the measurement is performed with a Peak Detector a Duty-Cycle Correction Factor has to be calculated to find the corresponding Average Detector value.

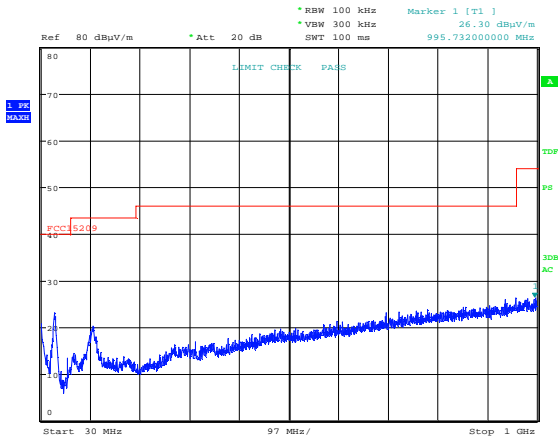

Date: 26.MAR.2021 15:30:36

Radiated Emissions 30 - 1000 MHz, Standby, HP

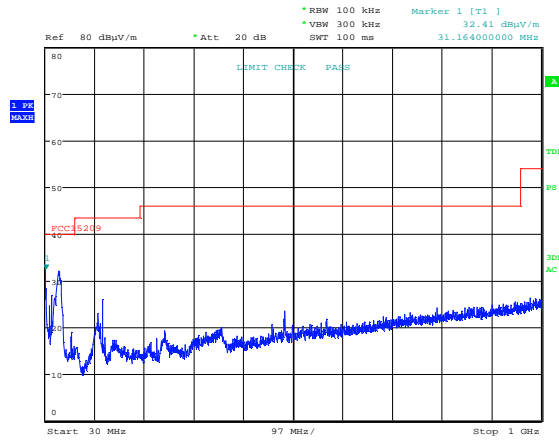

Date: 26.MAR.2021 15:28:22

Radiated Emissions 30 - 1000 MHz, Standby, VP

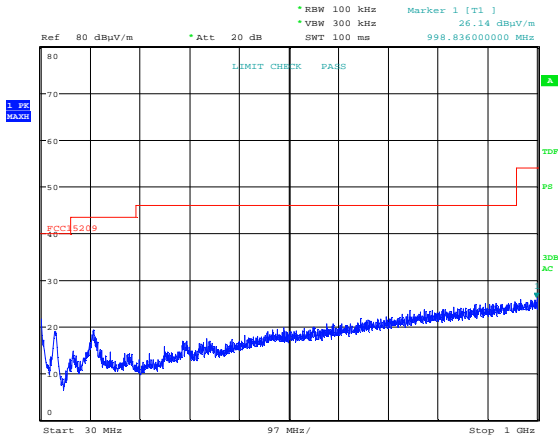

Date: 26.MAR.2021 15:41:05

Radiated Emissions 30 - 1000 MHz, Active Call, HP

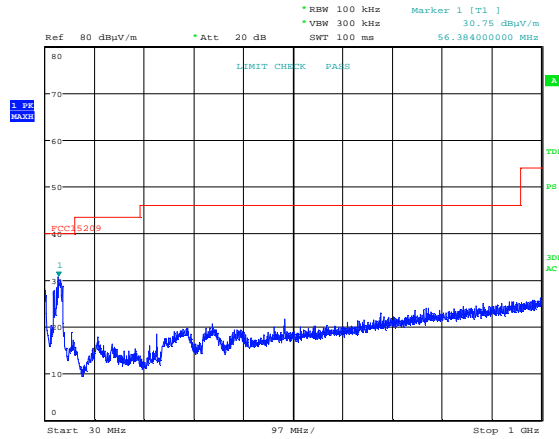

Date: 26.MAR.2021 15:35:04

Radiated Emissions 30 - 1000 MHz, Active Call, VP

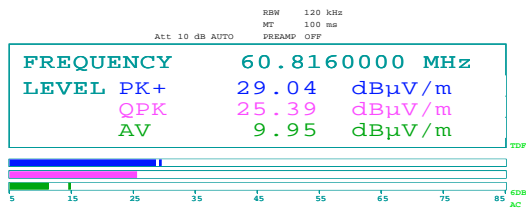

Date: 26.MAR.2021 15:59:42

Radiated Emissions 60.8 MHz, Active Call, VP

4 Measurement Uncertainty

Measurement Uncertainty Values		
Test Item		Uncertainty
Spurious Emissions, Radiated	< 1 GHz	±2.5 dB
	> 1 GHz	±2.2 dB
Power Line Conducted Emissions		+2.9 / -4.1 dB
Temperature Uncertainty		±1 °C

All uncertainty values are expanded standard uncertainty to give a confidence level of 95%, based on coverage factor k=2

5 Test Setups

5.1 Radiated Emissions Test

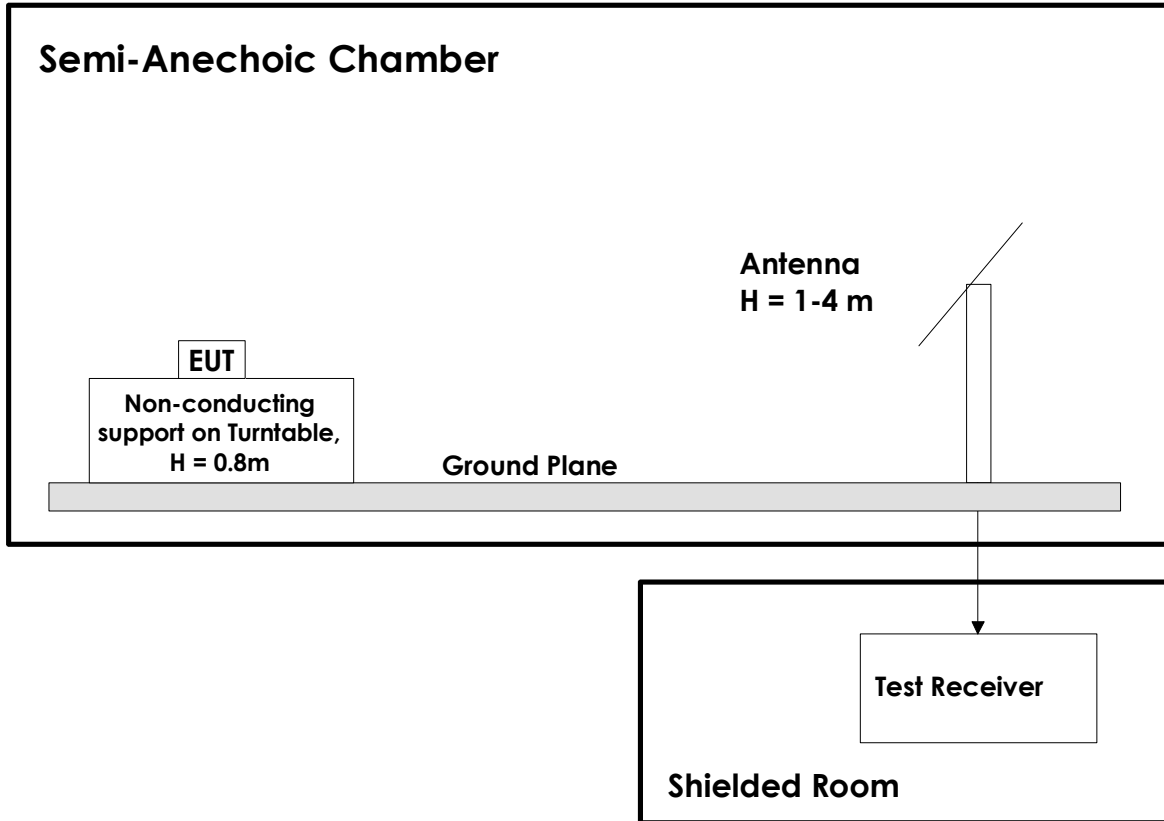

Test Set-Up 1

This test setup is used for all radiated emissions tests. Measuring distance is 3m.

A pre-amplifier is used for all measurements and a Low-Pass or Band-Reject filter is used for all frequencies between 30 MHz and 1 GHz.

5.2 Power Line Conducted Emissions Test

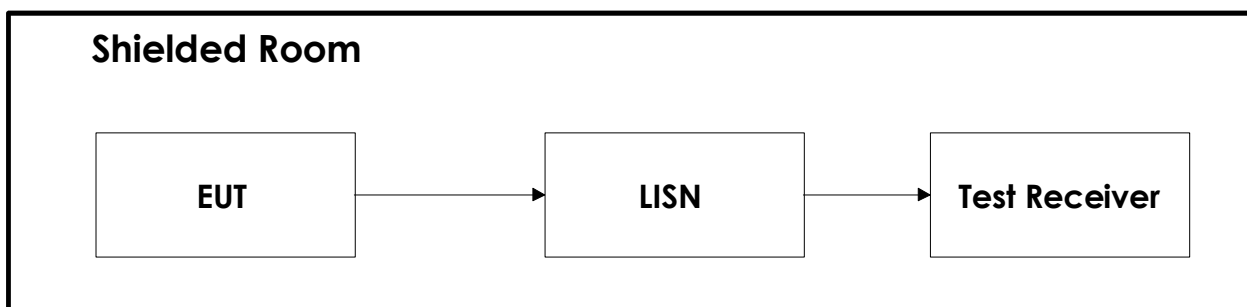

Test Set-Up 2

6 Test Equipment Used

To facilitate inclusion on each page of the test equipment used for related tests, each item of test equipment and ancillaries are identified (numbered) by the Testhouse.

No.	Model number	Description	Manufacturer	Ref. no.	Cal. date	Cal. Due
1	ESU40	Measuring Receiver	Rohde & Schwarz	LR 1639	2020-01 2021-02	2020-01 2022-02
2	NO324415	Band Reject Filter	Microwave Circuits	LR 1760	2020-08	2021-08
3	JB3	BiLog Antenna	Sunol	N-4525	2020-03	2023-03
4	317	Preamplifier	Sonoma Inst.	LR 1687	2020-08	2021-08
5	6812B	AC Power Source	Agilent	LR 1515	2020-04	2022-04
6	ESCI3	Measuring Receiver	Rohde & Schwarz	N-4259	2019.10	2021.10
7	ENV216	Two Line V-Network	Rohde & Schwarz	LR 1665	2019-11	2021-11
8	ST18/SMA/N/36	RF Cable	Suhner	LR 1627	COU	

COU = Calibrate on Use

The software listed below has been used for one or more tests.

No.	Manufacturer	Name	Version	Comment
1	Rohde & Schwarz	EMC32	10.50.10	Power Line Conducted test software
2	Nemko AS	RSPlot	1.0.8.0	Screenshots from R&S Spectrum Analyzers

Revision history

Revision	Date	Comment	Sign
00	2021-04-22	First Edition	FS
01	2021-05-05	Removed AC adaptor model suffix	FS