

Test Report

Product	DECT Base Station with Bluetooth		
Name and address of the applicant	Panasonic Corporation of North America Two Riverfront Plaza, 9 th Floor Newark, 07102-5490, NJ, USA		
Name and address of the manufacturer	Panasonic Corporation 1-62, 4-chome, Minoshima, Hakata-ku Fukuoka, 812-8531, Japan		
Model	KX-TGD860 KX-TGD870C		
Rating	120V 60Hz (Input: 120V ~60Hz 0.1A; Output: 5.5V 0.5A, 2.75W)		
Trademark	Panasonic		
Serial number	4081780002		
Additional information	DECT 6.0, Bluetooth Basic Rate		
Tested according to	FCC Part 15, subpart B Other Class B Digital Device Industry Canada ICES-003, Issue 7 Information Technology Equipment (ITE)		
Order number	408178		
Tested in period	2020-10-28 to 2020-10-29		
Issue date	2020-11-26		
Name and address of the testing laboratory	 Instituttveien 6 Kjeller, Norway www.nemko.com	CAB Number: FCC: NO0001 ISED: NO0470 TEL: +47 22 96 03 30 FAX: +47 22 96 05 50	  NORWEGIAN ACCREDITATION TEST 033
An accredited technical test executed under the Norwegian accreditation scheme			
 Prepared by [Frode Sveinsen]		 Approved by [G.Suhanthakumar]	
This report shall not be reproduced except in full without the written approval of Nemko. Opinions and interpretations expressed within this report are not part of the current accreditation. This report was originally distributed electronically with digital signatures. For more information contact Nemko.			

CONTENTS

1	INFORMATION	3
1.1	Tested Item	3
1.2	Test Environment	4
1.3	Test Engineer(s)	4
1.4	Test Equipment	4
1.5	Test Configurations	4
1.6	Other Comments	4
2	TEST REPORT SUMMARY	5
2.1	General	5
2.2	Test Summary	6
3	TEST RESULTS.....	7
3.1	Power Line Conducted Emissions	7
3.2	Spurious Emissions (Radiated).....	9
4	MEASUREMENT UNCERTAINTY	11
5	TEST SETUPS	12
5.1	Radiated Emissions Test	12
5.2	Power Line Conducted Emissions Test.....	12
6	TEST EQUIPMENT USED	13

1 INFORMATION

1.1 Tested Item

Name	Panasonic
Model name	KX-TGD860 (US Model) KX-TGD870C (Canadian Model)
FCC ID	ACJ96NKX-TGD860
FCC / ISED Class	B – Residential Use
Serial number	4081780002
Hardware identity and/or version	PNLB2909
Software identity and/or version	SW200
AC Adaptor(s)	AC Adaptor PNLV226(UC) / PNLV226(ZZ) / PNLV226(ZC) (Input: 120V ~60Hz 0.1A, Output: 5.5V _{DC} 0.5A, 2.75W)
Interfaces	PSTN

Description of Tested Device(s)

The tested equipment is a DECT Base Station with Bluetooth transceiver.

The AC adaptor PNLV226(ZC) is new.

1.2 Test Environment

Temperature:	20 – 25 °C
Relative humidity:	30 – 50 %
Normal test voltage:	120 V 60 Hz

The values are the limit registered during the test period.

1.3 Test Engineer(s)

Frode Sveinsen

1.4 Test Equipment

See list of test equipment in clause 6.

1.5 Test Configurations

Test Configuration	The test was performed with the EUT connected to a 120 V 60 Hz power source
AC adaptors	All tests were performed with 3 different AC adaptors were tested. All adaptors have the same rating and model number, but have different suffix to indicate different manufacturers.
Connections	The PSTN line was terminated in 50 Ohm during all tests.

1.6 Other Comments

All tests were performed with all ports populated and operating.

2 TEST REPORT SUMMARY

2.1 General

All measurements are traceable to national standards.

All tests were performed in accordance with ANSI C63.4-2014 where applicable. Radiated emissions are made in a 10m semi-anechoic chamber. A description of the test facility is on file with FCC and Industry Canada.



THIS TEST REPORT APPLIES ONLY TO THE ITEM(S) AND CONFIGURATIONS TESTED.

Deviations from, additions to, or exclusions from the test specifications are described in "Summary of Test Data".

Nemko Group authorizes the above named entity to reproduce this report provided it is reproduced in its entirety and for use by the entity's employees only. Any reproduction of parts of this report requires approval in writing from Nemko Group.

Any use that a third party makes of this report, or any reliance on or decisions to be made based on it, are the responsibility of such third parties. Nemko Group accepts no responsibility for damages suffered by any third party caused by decisions made or actions based on this report.

2.2 Test Summary

Name of test	FCC CFR 47, Paragraph #	ISED RSS-GEN, Issue 5, Paragraph #	ISED ICES-003, Issue 7, Paragraph #	Verdict
Power Line Conducted Emission	15.107(a) 15.207(a)	7.2	3.2.1	Complies
Spurious Emissions (Radiated)	15.109	7.3	3.2.2	Complies

3 TEST RESULTS

3.1 Power Line Conducted Emissions

FCC Part 15.107 (a)

ISED RSS-Gen Issue 5, Clause 7.2

ISED ICES-003 Issue 7, Clause 3.2.1

Measurement procedure: ANSI C63.4-2014 using 50 μ H/50 ohms LISN.

Test Results: Complies

Measurement Data: See attached plots.

Highest measured value (L1 and N):

PNLV226 (UC) 120V 60Hz:

Frequency (MHz)	QuasiPeak (dB μ V)	Average (dB μ V)	Limit (dB μ V)	Margin (dB)	Meas. Time (ms)	Bandwidth (kHz)	Line	Filter
0.352	36.93	---	58.92	21.99	1000	9	L1	OFF
3.528	42.09	---	56.00	13.91	1000	9	N	OFF
3.720	39.92	---	56.00	16.08	1000	9	L1	OFF
3.832	40.70	---	56.00	15.30	1000	9	L1	OFF
4.176	40.31	---	56.00	15.69	1000	9	L1	OFF
4.288	42.32	---	56.00	13.68	1000	9	N	OFF
4.480	39.80	---	56.00	16.20	1000	9	L1	OFF

PNLV226 (ZZ) 120V 60Hz:

Frequency (MHz)	QuasiPeak (dB μ V)	Average (dB μ V)	Limit (dB μ V)	Margin (dB)	Meas. Time (ms)	Bandwidth (kHz)	Line	Filter
4.452	38.70	---	56.00	17.30	1000	9	N	OFF
4.644	38.30	---	56.00	17.70	1000	9	N	OFF

PNLV226 (ZC) 120V 60Hz:

Frequency (MHz)	QuasiPeak (dB μ V)	Average (dB μ V)	Limit (dB μ V)	Margin (dB)	Meas. Time (ms)	Bandwidth (kHz)	Line	Filter
0.288	33.42	---	60.58	27.16	1000	9	N	OFF
0.300	---	34.06	50.24	16.19	1000	9	L1	OFF
1.912	41.40	---	56.00	14.60	1000	9	L1	OFF
1.916	41.60	---	56.00	14.40	1000	9	L1	OFF
1.936	41.30	---	56.00	14.70	1000	9	L1	OFF
1.944	41.47	---	56.00	14.53	1000	9	L1	OFF
1.960	41.53	---	56.00	14.47	1000	9	L1	OFF
2.108	42.52	---	56.00	13.48	1000	9	L1	OFF
2.392	40.03	---	56.00	15.97	1000	9	L1	OFF

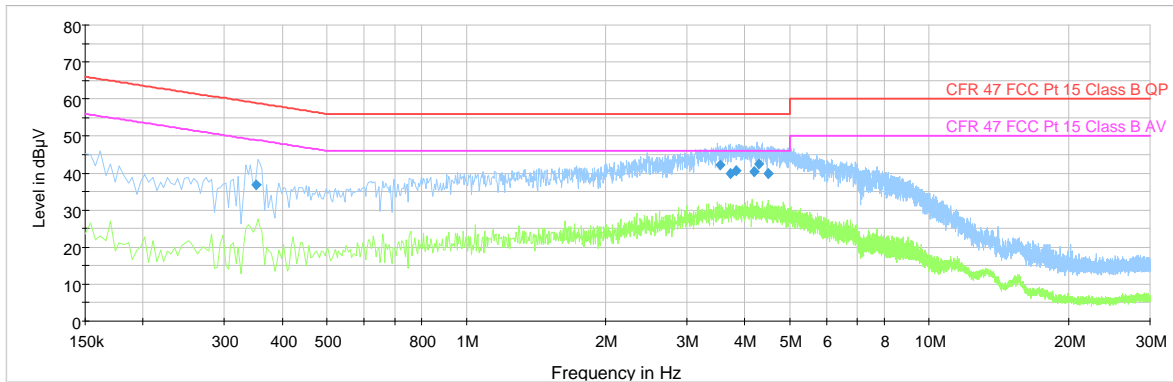

PNLV226 (UC) 120V 60Hz

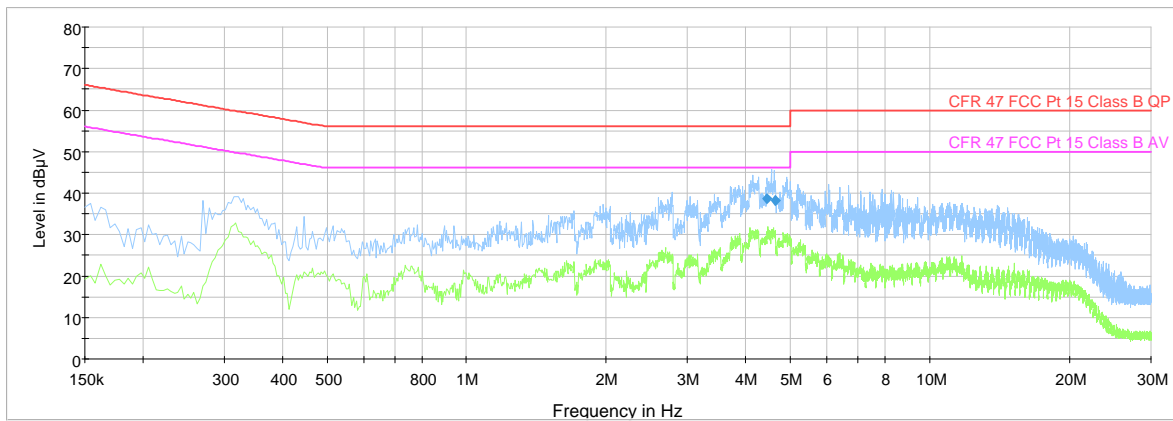

PNLV226 (ZZ) 120V 60Hz

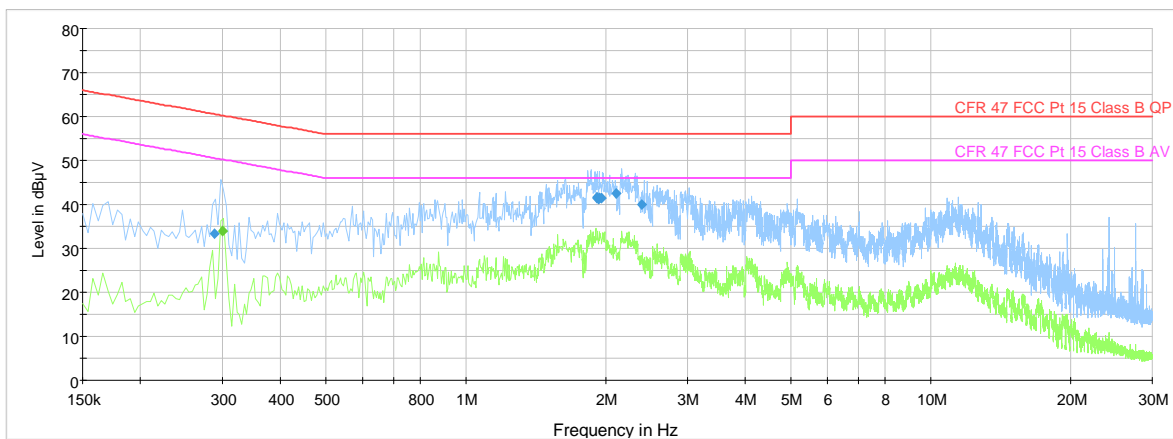

PNLV226 (ZC) 120V 60Hz

3.2 Spurious Emissions (Radiated)

FCC Part 15.109

ISED RSS-Gen Issue 5, Clause 7.3

ISED ICES-003 Issue 7, Clause 3.2.2

Test Results:

Radiated Emissions 30 - 1000 MHz.

Detector: Quasi-Peak

Measuring distance 3 m

The EUT were rotated 360 degrees and the antenna height varied between 1 and 4 m on all found frequencies.

Frequency MHz	AC Adaptor	Field strength @3m QP Det., dB μ V/m	Limit dB μ V/m	Margin dB
52.5	PNLV226 (UC)	27.6	40	12.4
165.9	PNLV226 (UC)	24.9	43.5	18.5
42.6	PNLV226 (ZZ)	23.8	40	16.2
165.9	PNLV226 (ZZ)	24.5	43.5	19.0
All Freq.	PNLV226 (ZC)	< 30	40/43.5/46/54	>10
All Freq	All	< 30	40/43.5/46/54	>10

Requirements/Limit

FCC	Part 15.209 @ frequencies defined in §15.205	
ISED	RSS-GEN Issue 4, Clause 8.9 @ frequencies defined in clause 8.10	
	Radiated emission limit @3 meters	
Frequency (MHz)	Quasi Peak (μV/m)	Quasi Peak (dBμV/m)
30 – 88	100	40.0
88 – 216	150	43.5
216 – 960	200	46.0
Above 960	500	54.0

¹ The limit above 1000 MHz is specified for Average Detector, when the measurement is performed with a Peak Detector a Duty-Cycle Correction Factor has to be calculated to find the corresponding Average Detector value.

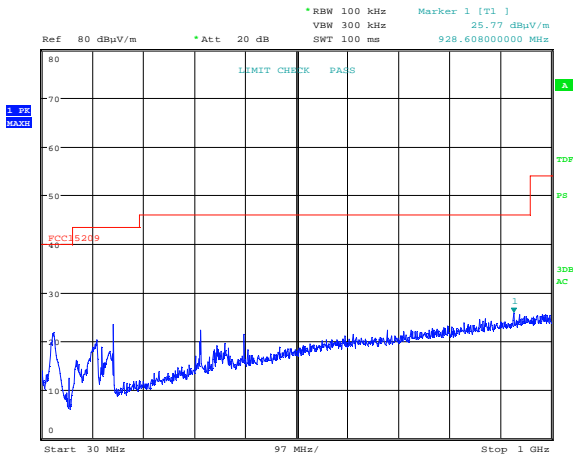

Date: 29.OCT.2020 15:24:47

PNLV226 UC 120V 60 Hz, Horizontal Polarization

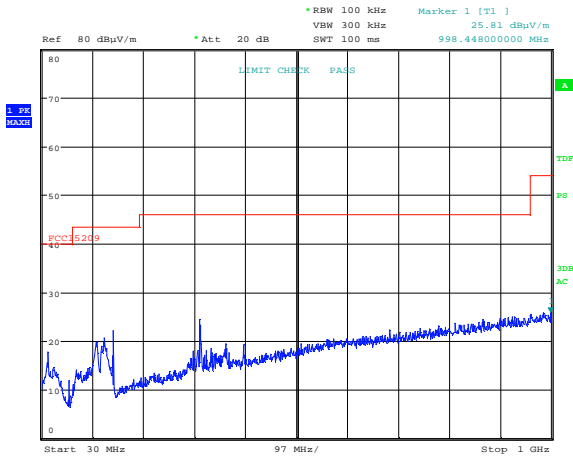

Date: 29.OCT.2020 14:26:42

PNLV226 ZZ 120V 60 Hz, Horizontal Polarization

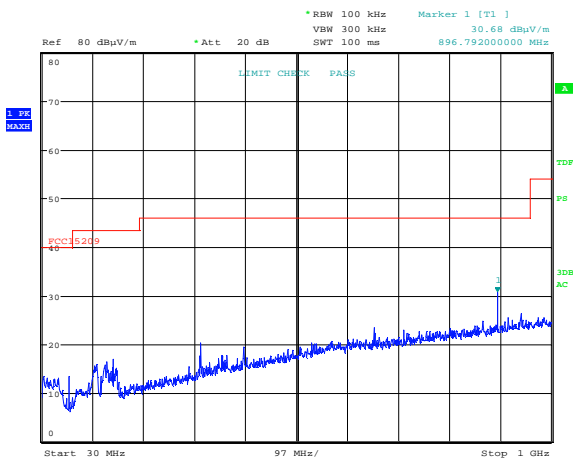

Date: 29.OCT.2020 14:06:21

PNLV226 ZC 120V 60 Hz, Horizontal Polarization

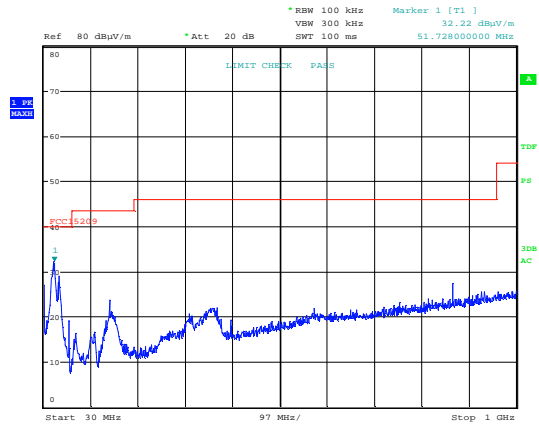

Date: 29.OCT.2020 15:31:05

Vertical Polarization

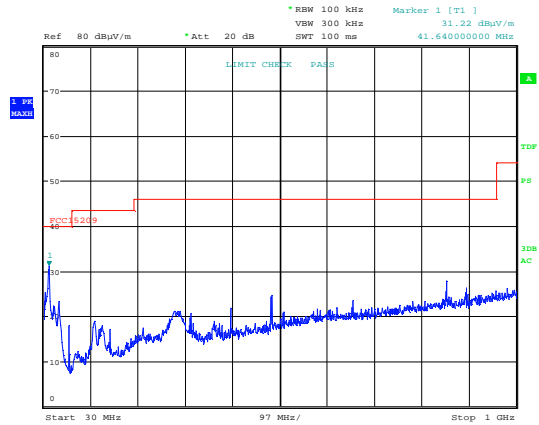

Date: 29.OCT.2020 14:32:05

Vertical Polarization

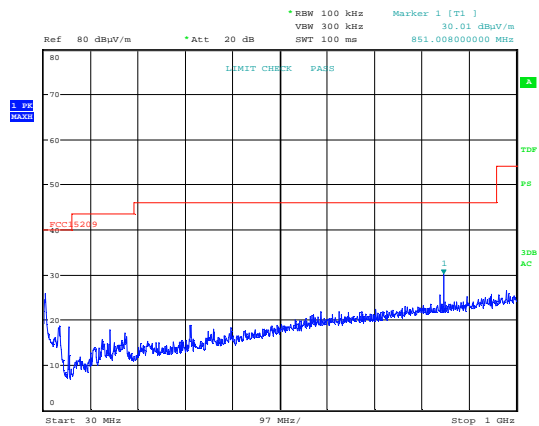

Date: 29.OCT.2020 14:16:22

Vertical Polarization

4 Measurement Uncertainty

Measurement Uncertainty Values		
Test Item		Uncertainty
Spurious Emissions, Radiated	< 1 GHz	±2.5 dB
	> 1 GHz	±2.2 dB
Power Line Conducted Emissions		+2.9 / -4.1 dB
Temperature Uncertainty		±1 °C

All uncertainty values are expanded standard uncertainty to give a confidence level of 95%, based on coverage factor $k=2$

5 Test Setups

5.1 Radiated Emissions Test

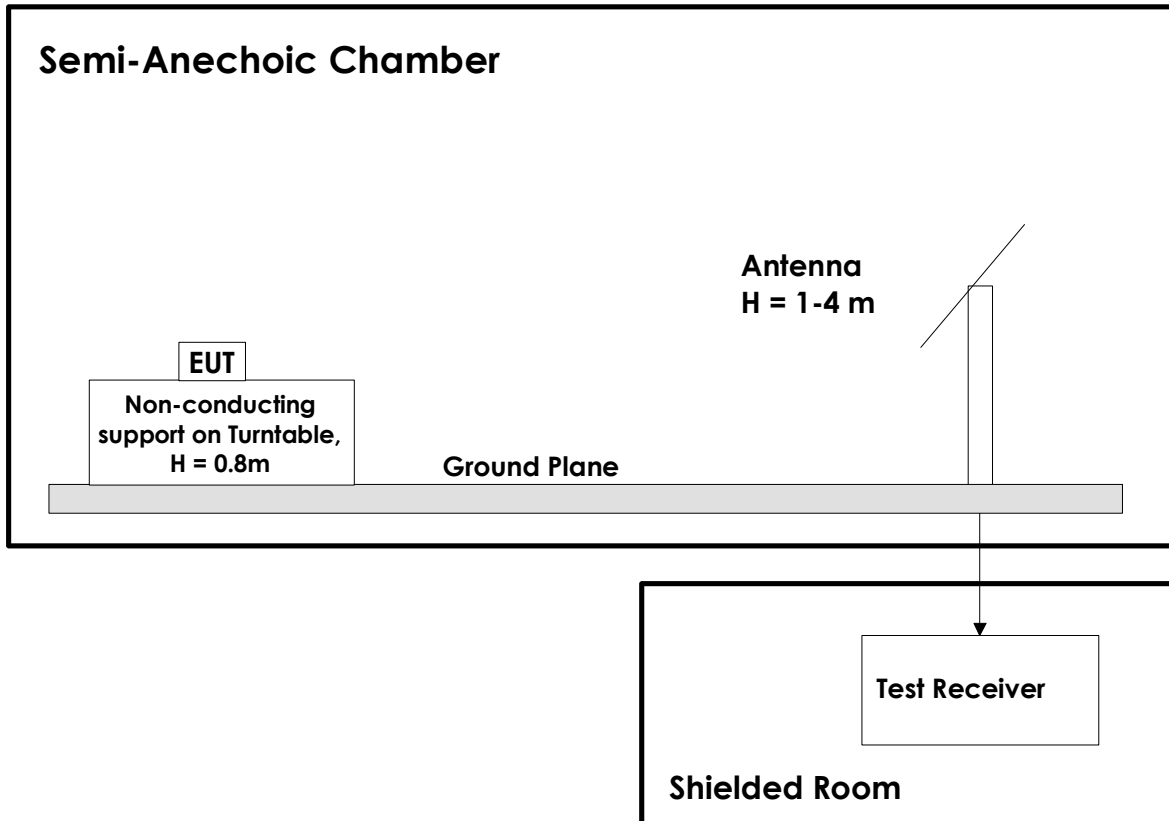

Test Set-Up 1

This test setup is used for all radiated emissions tests. For frequencies below 30 MHz the measuring distance is 10m, for all other frequencies it is 3m or 1m. Emissions above 1 GHz are measured with a Spectrum Analyzer and Horn Antenna. For measurements above 18 GHz the test receiver is moved inside the anechoic chamber and located next to the antenna to minimize the cable loss. All measurements at 1GHz and above were performed with turntable height 1.5m and with the ground plane covered by absorbers. A pre-amplifier is used for all measurements above 30 MHz.

5.2 Power Line Conducted Emissions Test

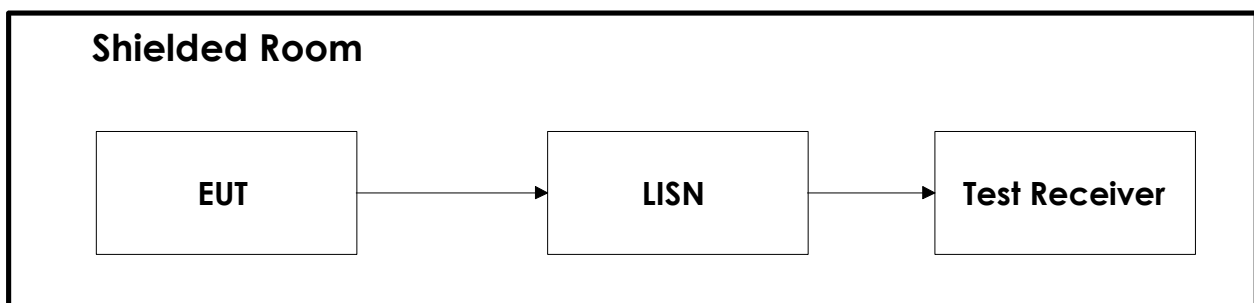

Test Set-Up 2

6 Test Equipment Used

To facilitate inclusion on each page of the test equipment used for related tests, each item of test equipment and ancillaries are identified (numbered) by the Testhouse.

No.	Model number	Description	Manufacturer	Ref. no.	Cal. date	Cal. Due
1	ESU40	Measuring Receiver	Rohde & Schwarz	LR 1639	2020-01	2021-01
2	VULB 9163	BiLog Antenna	Schwarzbech	LR 1616	2020-01	2023-01
3	317	Preamplifier	Sonoma Inst.	LR 1687	2020-08	2021-08
4	WLK5-1100-1485-7000-40SS	Low Pass Filter	Wainwright Inst.	LR 1761	2020-08	2021-08
5	6812B	AC Power Source	Agilent	LR 1515	2020-04	2021-04
6	ESCI3	Measuring Receiver	Rohde & Schwarz	N-4259	2019.10	2021.10
7	ENV216	Two Line V-Network	Rohde & Schwarz	LR 1665	2019-11	2021-11
8	ST18/SMA/N/36	RF Cable	Suhner	LR 1627	COU	

The software listed below has been used for one or more tests in this report.

No.	Manufacturer	Name	Version	Comment
1	Rohde & Schwarz	EMC32	10.50.10	Power Line Conducted test software
2	Rohde & Schwarz	EMC32	10.50.10	Radiated Emission test software
3	Nemko AS	RSPlot	1.0.8.0	Screenshots from R&S Spectrum Analyzers

Revision history

Revision	Date	Comment	Sign
00	2020-11-16	First Edition	FS
01	2020-11-26	Removed references to KX-TGD560A	FS