



**Test report no. : 190512-5**

**Item tested : KX-TG7741**

**Type of equipment : UPCS Base Station**

**FCC ID : ACJ96NKX-TG7741**

**Client : Panasonic System Networks Co., Ltd.**

**FCC Part 15, subpart D**

Isochronous UPCS Device  
1920 - 1930 MHz

**Industry Canada RSS-213, Issue 2**

2 GHz Licence-exempt Personal  
Communications Service Devices  
(LE-PCS)

**22 November 2011**

**Authorized by : .....**

G. Suhanthakumar  
Technical Vericator

## CONTENTS

<b>1</b>	<b>GENERAL INFORMATION .....</b>	<b>3</b>
1.1	Testhouse Info .....	3
1.2	Client Information .....	3
1.3	Responsible Manufacturer (if other than client) .....	3
<b>2</b>	<b>TEST INFORMATION .....</b>	<b>4</b>
2.1	Tested Item .....	4
2.2	Description of Tested Device .....	4
2.3	Exposure Evaluation .....	4
2.4	Test Environment .....	5
2.5	Test Period .....	5
2.6	Test Engineer(s) .....	5
2.7	Test Equipment .....	5
2.8	Other Comments .....	5
<b>3</b>	<b>TEST REPORT SUMMARY .....</b>	<b>6</b>
3.1	General .....	6
3.2	Test Summary .....	7
<b>4</b>	<b>TEST RESULTS .....</b>	<b>8</b>
4.1	Power Line Conducted Emissions .....	8
4.2	Coordination with fixed microwave .....	12
4.3	Digital Modulation Techniques .....	12
4.4	Labeling Requirements .....	12
4.5	Antenna Requirement .....	13
4.6	Channel Frequencies .....	13
4.7	Peak Power Output .....	14
4.8	Spurious Emissions (Radiated) .....	17
<b>5</b>	<b>TEST SETUPS .....</b>	<b>21</b>
5.1	Radiated Emissions Test, Semi-Anechoic Chamber .....	21
5.2	Power Line Conducted Emissions Test .....	21
5.3	Radiated Emissions Test, Fully Anechoic Chamber .....	22
<b>6</b>	<b>TEST EQUIPMENT USED .....</b>	<b>23</b>

## 1 GENERAL INFORMATION

### 1.1 Testhouse Info

Name : Nemko AS  
Address : Nemko Kjeller  
Instituttveien 6  
N-2007 Kjeller, NORWAY  
Telephone : +47 64 84 57 00  
Fax : +47 64 84 57 05  
E-mail: comlab@nemko.com  
FCC test firm registration # : 994405  
IC OATS registration # : 2040D-1  
Total Number of Pages: 23

### 1.2 Client Information

Name : Panasonic System Networks Co., Ltd.  
Address : 1-62, 4-Chome, Minoshima, Hakata-ku, Fukuoka 812-8531 Japan  
Telephone : +81-92-477-1405  
Fax : +81-92-477-1487

**Contact:**

Name : Mr. Junji Sumi  
Telephone : +81 92 477 1405  
E-mail : sumi.junji@jp.panasonic.com

### 1.3 Responsible Manufacturer (if other than client)

Name : /  
Address : /

## 2 Test Information

### 2.1 Tested Item

Name :	Panasonic
Model name :	KX-TG7741
FCC ID :	ACJ96NKX-TG7741
Industry Canada ID :	216A-KXTG7741
Serial number :	/
Hardware identity and/or version:	/
Software identity and/or version :	/
Tested to IC Radio Standard (RSS) :	RSS-213 Issue 2, RSS-GEN Issue 3
Test Site IC Reg. Number :	IC 2040D-1
Frequency Range :	1921.536 – 1928.448 MHz
Number of Channels :	5 RF Channels, 5x12 = 60 TDMA Duplex Channels
Type of Modulation :	Digital (Gaussian Frequency Shift Keying)
Peak Output Power :	91 mW (Conducted)
Antenna Connector :	None (Integral antennas)
Number of Antennas :	2
Antenna Diversity Supported :	Yes
Power Supply :	AC Adaptors: PNLV226(FW) and PNLV226(UC)

### 2.2 Description of Tested Device

The tested equipment is a DECT base which complies with the FCC requirements to an Isochronous UPCS device after FCC Part 15D. The EUT is an responding device as described in ANSI C63.17 and is designed to operate together with a DECT portable part (i.e. a handset), which is then the initiating device.

### 2.3 Exposure Evaluation

The EUT is designed to be fixed to a wall etc. and the user manual contains text that it shall be mounted with a separation distance of at least 20cm from any persons. For the purposes of exposure evaluation this EUT is a mobile or fixed device. MPE Calculation at 20cm satisfying FCC requirements is submitted as a separate document.

The EUT is exempted from RF Exposure Evaluation to Industry Canada SAR requirements since the output power is below the limit in RSS-102 Issue 4, clause 2.5.2 for General Public Use.

## 2.4 Test Environment

Temperature:	21 – 23 °C
Relative humidity:	15 – 35 %
Normal test voltage:	120 V AC

The values are the limit registered during the test period.

## 2.5 Test Period

Item received date:	2011-11-03
Test period :	from 2011-11-07 to 2011-11-15

## 2.6 Test Engineer(s)

Frode Sveinsen / Thomas Dangle

## 2.7 Test Equipment

See list of test equipment in clause 6.

## 2.8 Other Comments

This test report covers only radiated tests. All other tests are covered by Nemko test report no. 161417-4.

The UPCS Base Station covered by this report is identical to the previously certified model KX-TG7641 (FCC ID: ACJ96NKX-TG7641) except for the antennas and certain changes to the PCB other than the RF part.

### 3 TEST REPORT SUMMARY

#### 3.1 General

Manufacturer: Panasonic  
Model No.: KX-TG7741  
Serial No.: /

All measurements are traceable to national standards.

The tests were conducted on a sample of the equipment for the purpose of demonstrating compliance with FCC CFR47 Part 15D for Isochronous UPCS Devices and Industry Canada RSS-213 Issue 2 / RSS-GEN Issue 3.

All tests were conducted in accordance with ANSI C63.4-2009 and ANSI C63.17-2006. Antenna Gain tests were made in a 3m fully-anechoic chamber.

A description of the test facility is on file with the FCC and Industry Canada.

- |   |   |
|---|---|
| <input checked="" type="checkbox"/> New Submission  | <input checked="" type="checkbox"/> Production Unit |
| <input type="checkbox"/> Class II Permissive Change | <input type="checkbox"/> Pre-production Unit        |
| <b>PUB</b> Equipment Code                           | <input type="checkbox"/> Family Listing             |

**THIS TEST REPORT APPLIES ONLY TO THE ITEM(S) AND CONFIGURATIONS TESTED.**

**Deviations from, additions to, or exclusions from the test specifications are described in "Summary of Test Data".**



**TEST REPORT NO: 190512-5**

TESTED BY : Frode Sveinsen  
Frode Sveinsen, Chief Engineer

DATE: 15 November 2011

Nemko Group authorizes the above named company to reproduce this report provided it is reproduced in its entirety and for use by the company's employees only. Any reproduction of parts of this report requires approval in writing from Nemko Group.

Any use which a third party makes of this report, or any reliance on or decisions to be made based on it, are the responsibility of such third parties. Nemko Group accepts no responsibility for damages suffered by any third party as a result of decisions made or actions based on this report.

### 3.2 Test Summary

Name of test	FCC CFR 47 Paragraph #	IC RSS-213 Paragraph #	Verdict
Coordination with fixed microwave	15.307(b)	N/A	Complies
Digital Modulation Techniques	15.319(b)	6.1	Complies
Labeling requirements	15.19(a)(3)	RSS-GEN 5.2	Complies
Antenna Requirement	15.317, 15.203	4.1(e)	Complies
Power Line Conducted Emission	15.107(a) 15.207(a)	6.3 RSS-GEN 7.2.2	Complies
Peak transmit Power	15.319(c)(e), 15.31(e)	6.5	Complies
Spurious Emissions (Radiated)	15.319(g) 15.109(a) 15.209(a)	4.3.3 RSS-GEN 7.2.3	Complies

## 4 TEST RESULTS

### 4.1 Power Line Conducted Emissions

Para. No.: 15.207 (a)

Test Performed By: Thomas Dangle	Date of Test: 11 Nov 2011
----------------------------------	---------------------------

Measurement procedure: ANSI C63.4-2009 using 50  $\mu$ H/50 ohms LISN.

Test Results: Complies

Measurement Data: See attached graph, (Peak detector).

Highest measured value (L1 and N):

AC Adaptor PNLV226(UC):

Hook-Off, Charging:

Frequency [MHz]	Level [dBuV]	Af [dB]	Limit [dBuV]	Margin [dB]	Det	Position	Verdict [Pass/Fail]
0.155000	24.90	10.10	55.70	30.80	AV	N	Pass
0.305000	31.20	10.10	50.10	18.90	AV	N	Pass
1.180000	17.10	10.20	46.00	28.90	AV	N	Pass
2.060000	20.10	10.30	46.00	25.90	AV	N	Pass
3.220000	23.60	10.30	46.00	22.40	AV	L1	Pass
3.910000	24.00	10.40	46.00	22.00	AV	L1	Pass

Hook-Off:

Frequency [MHz]	Level [dBuV]	Af [dB]	Limit [dBuV]	Margin [dB]	Det	Position	Verdict [Pass/Fail]
1.405000	17.70	10.20	46.00	28.30	AV	L1	Pass
3.455000	21.30	10.30	46.00	24.70	AV	L1	Pass
4.420000	20.50	10.40	46.00	25.50	AV	N	Pass

**AC Adaptor PNLV226(FW):**

Hook-On, Charging:

Frequency [MHz]	Level [dBuV]	Af [dB]	Limit [dBuV]	Margin [dB]	Det	Position	Verdict [Pass/Fail]
0.710000	20.70	10.20	46.00	25.30	AV	N	Pass
1.215000	21.20	10.20	46.00	24.80	AV	L1	Pass
1.765000	19.50	10.20	46.00	26.50	AV	N	Pass
2.750000	22.50	10.30	46.00	23.50	AV	L1	Pass
3.655000	23.80	10.30	46.00	22.20	AV	N	Pass

Hook-Off:

Frequency [MHz]	Level [dBuV]	Af [dB]	Limit [dBuV]	Margin [dB]	Det	Position	Verdict [Pass/Fail]
0.695000	15.00	10.20	46.00	31.00	AV	N	Pass
1.000000	16.00	10.20	46.00	30.00	AV	L1	Pass
1.300000	16.70	10.20	46.00	29.30	AV	N	Pass
3.105000	20.50	10.30	46.00	25.50	AV	N	Pass
3.995000	21.70	10.40	46.00	24.30	AV	N	Pass

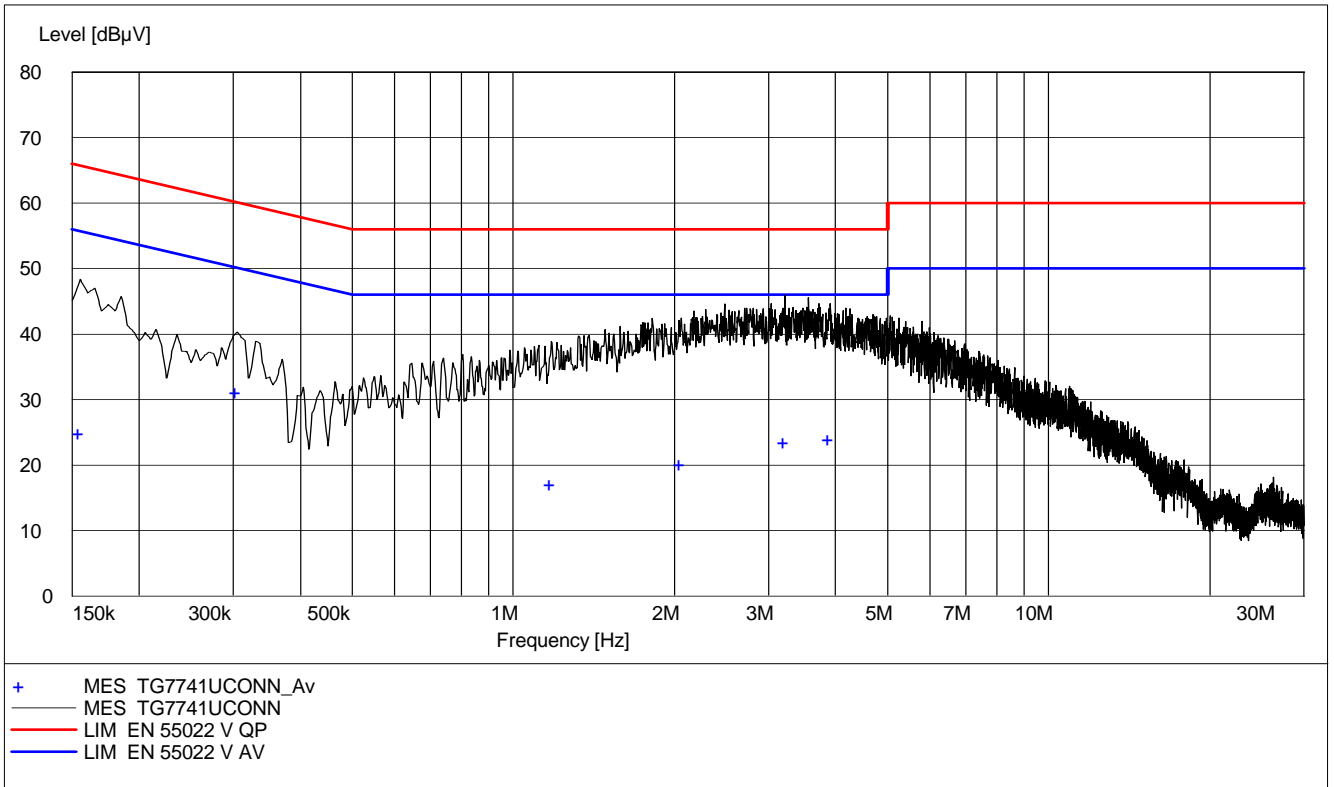

**Phase L1 and N, Hook On, Charge Mode, AC Adaptor PNLV226(UC)**

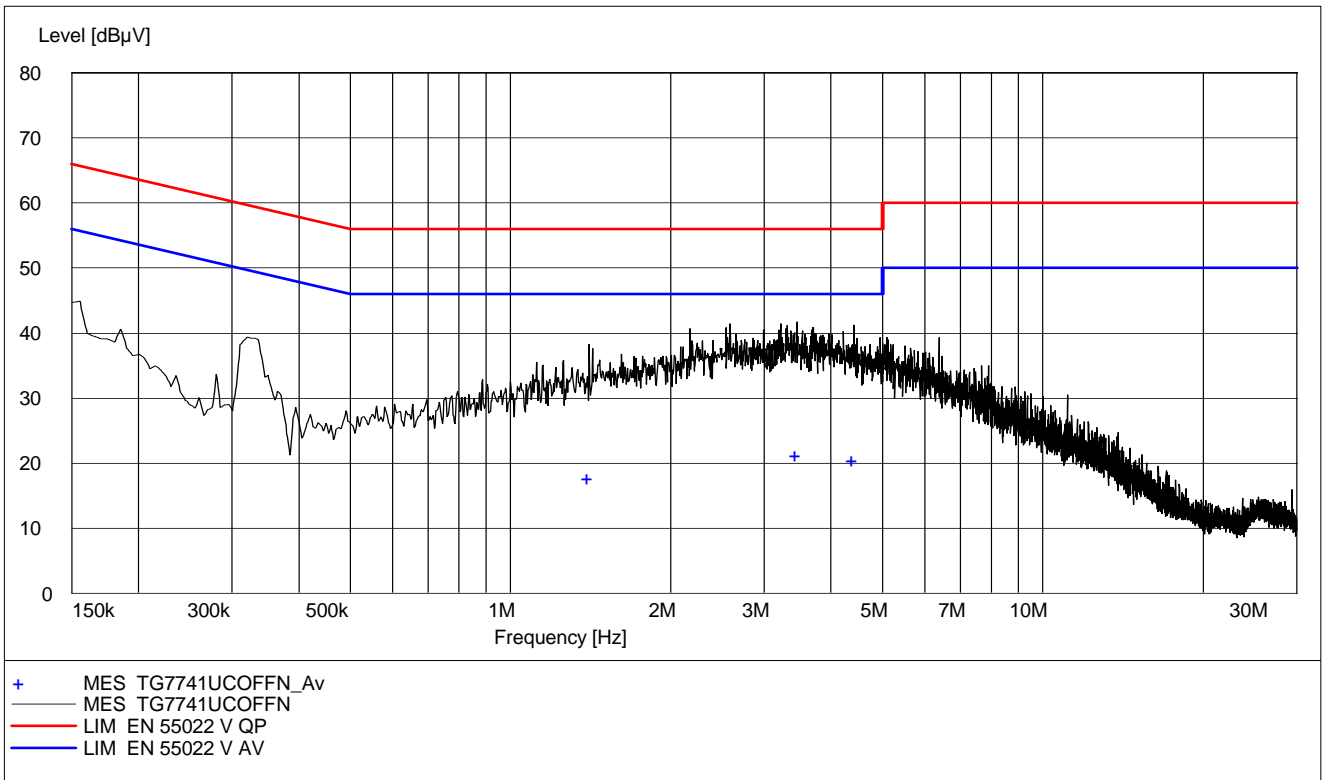

**Phase L1 and N, Hook Off, AC Adaptor PNLV226(UC)**

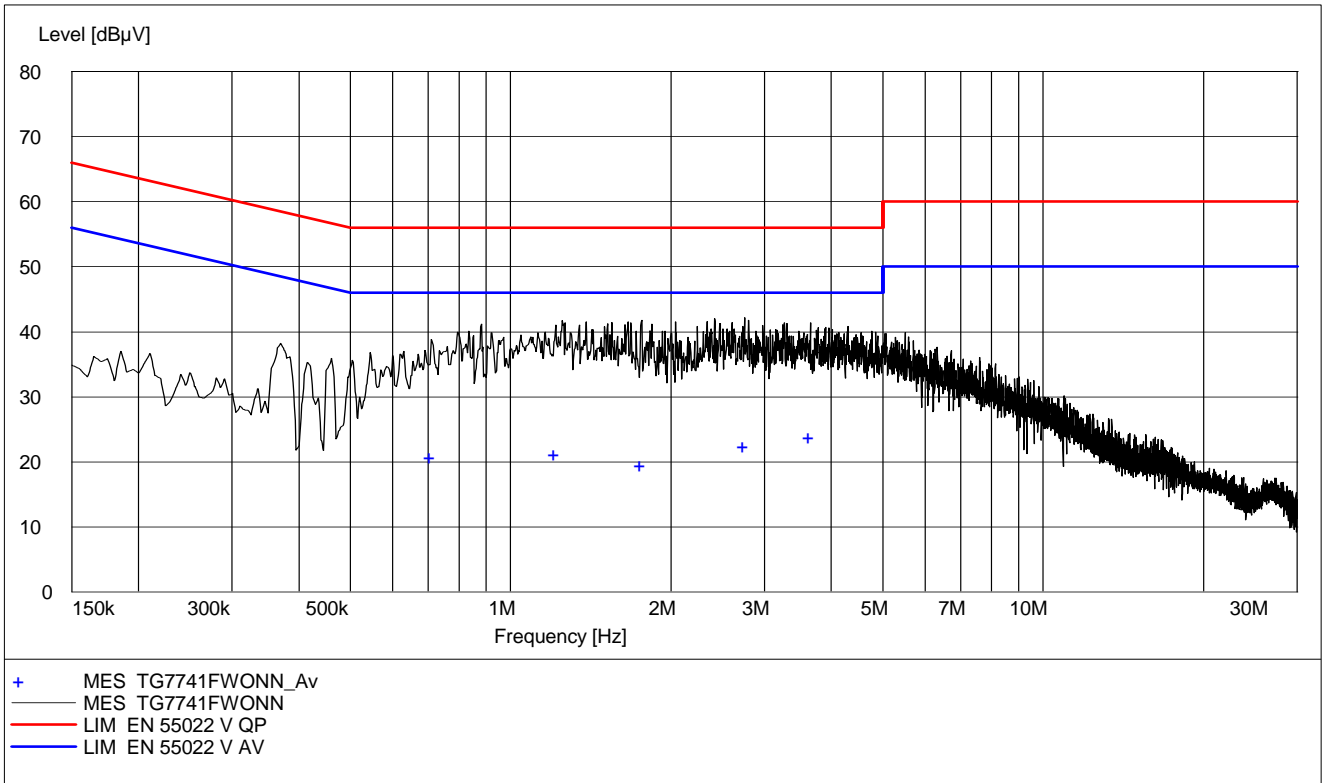

**Phase L1 and N, Hook On, Charge Mode, AC Adaptor PNLV226(FW)**

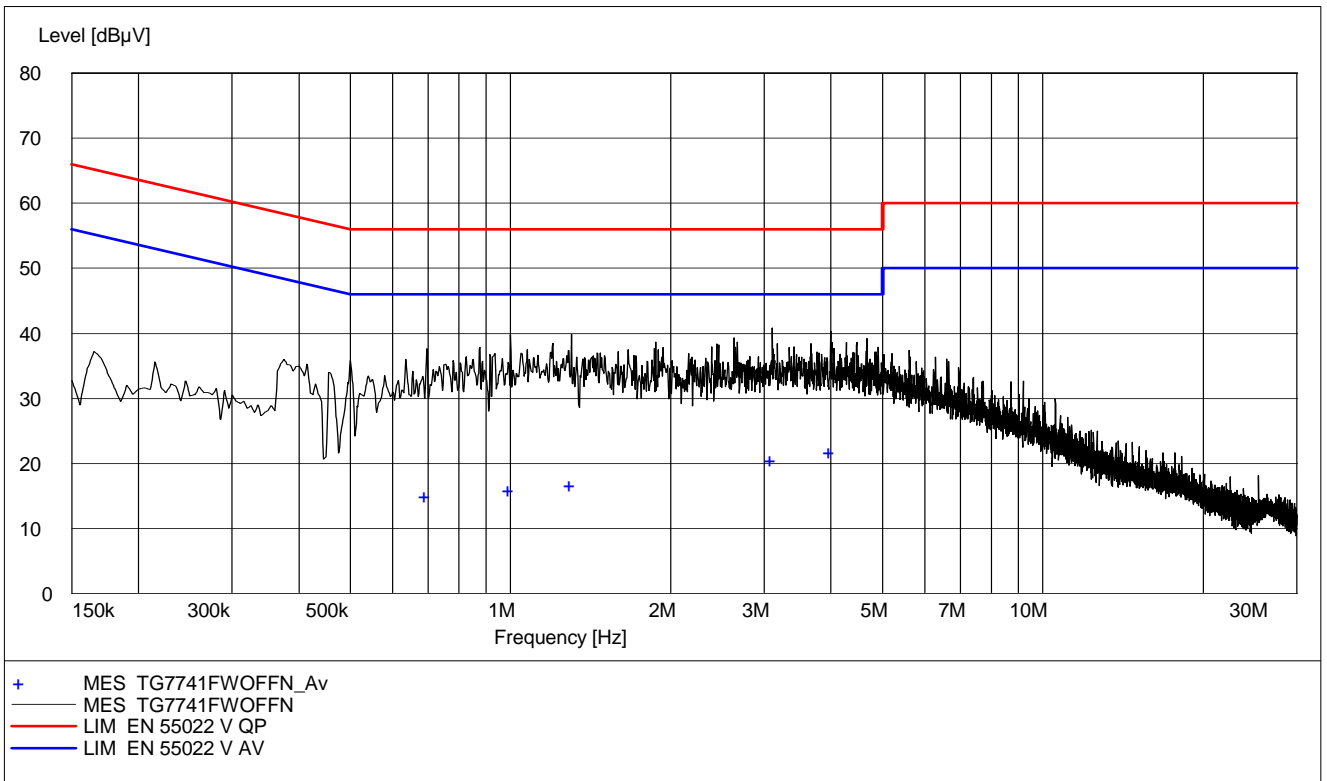

**Phase L1 and N, Hook Off, AC Adaptor PNLV226(FW)**

## 4.2 Coordination with fixed microwave

The affidavit from UTAM, Inc. is included in the documentation supplied by the applicant:

Yes

No

### Requirement, FCC 15.307 (b):

Each application for certification of equipment operating under the provisions of this Subpart must be accompanied by an affidavit from UTAM, Inc. certifying that the applicant is a participating member of UTAM, Inc. In the event a grantee fails to fulfill the obligations attendant to participation in UTAM, Inc., the Commission may invoke administrative sanctions as necessary to preclude continued marketing and installation of devices covered by the grant of certification, including but not limited to revoking certification.

## 4.3 Digital Modulation Techniques

The EUT used Multi Carrier / Time Division Multiple Access / Time Division Duplex and Digital GFSK modulation.

For further details see the operational description provided by the applicant.

### Requirement, FCC 15.319(b):

All transmissions must use only digital modulation techniques.

## 4.4 Labeling Requirements

See separate documents showing the label design and the placement of the label on the EUT.

### Requirements FCC 15.19

The FCC Identifier shall be displayed on the label, and the device(s) shall bear the following statement in a conspicuous location on the device or in the user manual if the device is too small:

*This device complies with Part 15 of the FCC Rules. Operation is subject to the following two conditions: (1) this device may not cause harmful interference, and (2) this device must accept any interference received, including interference that may cause undesired operation.*

The label itself shall be of a permanent type, not a paper label, and shall last the lifetime of the equipment.

#### 4.5 Antenna Requirement

Does the EUT have detachable antenna(s)?  Yes  No

If detachable, is the antenna connector(s) non-standard?  Yes  No

The tested equipment has only integral antennas. The conducted tests were performed on a sample with a temporary antenna connector.

**Requirement: FCC 15.203, 15.204, 15.317.**

#### 4.6 Channel Frequencies

UPCS CHANNEL	FREQUENCY (MHz)
Upper Band Edge	1930.000
0 (Highest)	1928.448
1	1926.720
2	1924.992
3	1923.264
4 (Lowest)	1921.536
Lower Band Edge	1920.000

**Requirement: FCC 15.303 (d), (g)**

Within 1920 -1930 MHz band for isochronous devices.

## 4.7 Peak Power Output

**Test Method:**

ANSI C63.17, clause 6.1.2.

**Test Results: Complies**

**Measurement Data:**

**Maximum Output Power**

Channel No.	Frequency (MHz)	Maximum Conducted Output Power (dBm)	Maximum Radiated Output Power (dBm)	Maximum Antenna Gain (dBi)
4	1921.536	19.6	19.9	+0.3
2	1924.992	19.6	20.1	+0.5
0	1928.448	19.5	19.8	+0.3

**Substitution:**

Frequency MHz	Measured value dBm	Subst. Gen. (incl. corr.) dBm	Attenuator and Cable dB	Gain Subst. Antenna dB	Result dBm
1921.536	18.9	25.6	-14.0	8.3	19.9
1924.992	19.1	25.8	-14.0	8.3	20.1
1928.448	18.8	25.5	-14.0	8.3	19.8

**Result = Subst.Gen. + Attenuator + Cable + Antenna Gain**

Conducted values are from Nemko report no. 161417-4.

For this test it was also checked that input voltage variation of 85 and 115% of nominal value did not have any effect on the measured output power, neither radiated nor conducted.

**Limit:**

Conducted:  $100 \mu\text{W} \times \text{SQRT}(B)$  where  $B$  is the measured Emission Bandwidth in Hz

FCC 15.319(c)(e): 20.7 dBm (117 mW)

RSS-213, Issue 2: 20.5 dBm (111 mW)

The antenna gain is below 3 dBi, no reduction in transmit power is necessary.

**Requirements, FCC 15.319(c)(e), RSS-213, Issue 2**

Peak transmit power shall not exceed 100 microwatts multiplied by the square root of the emission bandwidth in Hertz.

The peak transmit power shall be reduced by the amount in decibels that the maximum directional gain of the antenna exceeds 3 dBi.

**Radiated Peak Output Power**

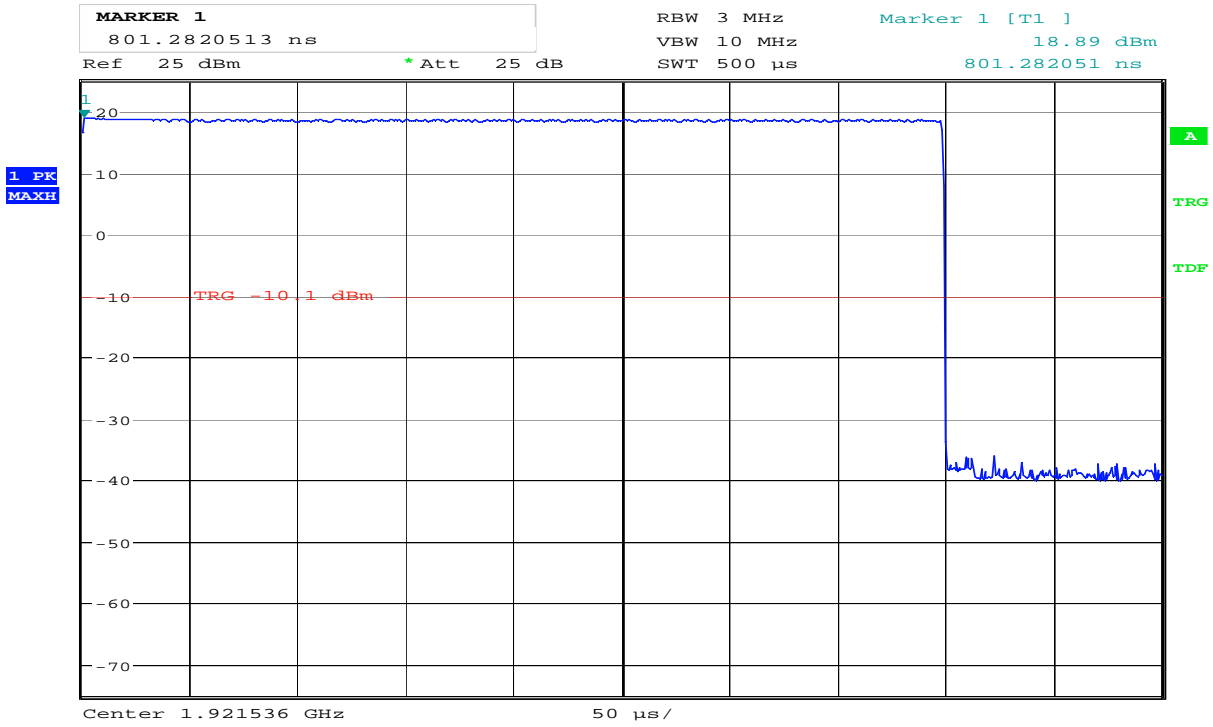

Date: 10.NOV.2011 16:36:34

**Lower Channel (Max: Ant 2, HP)**

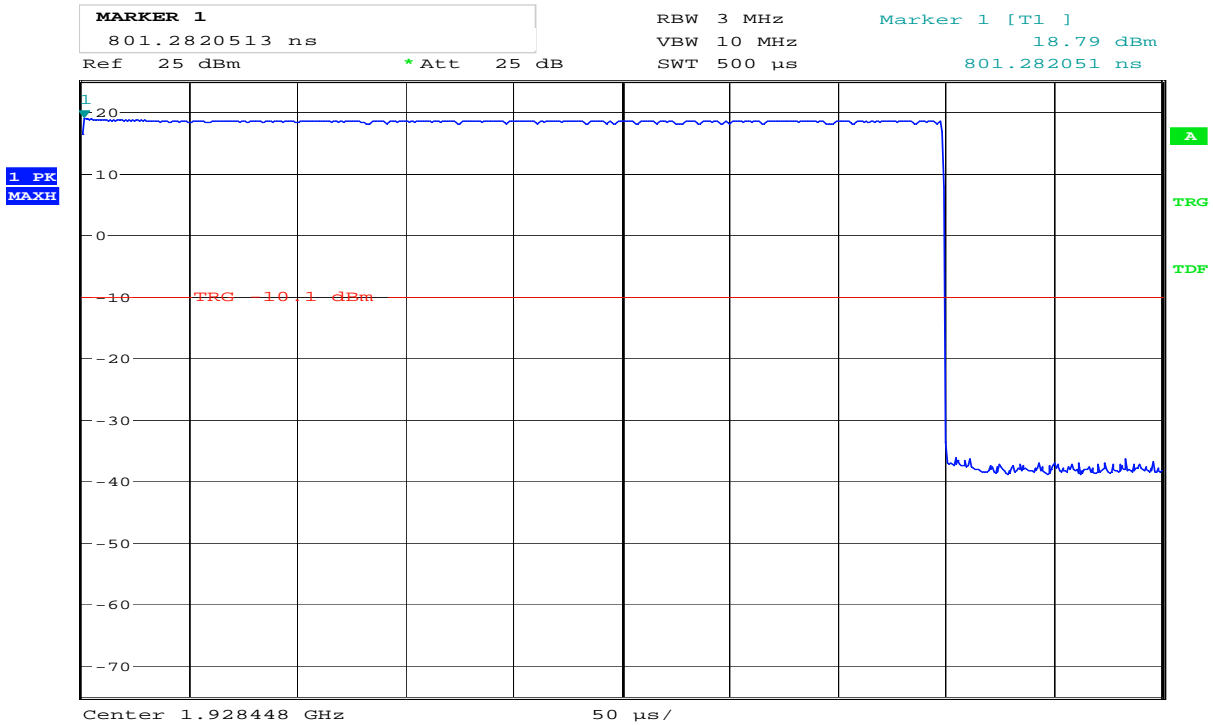

Date: 10.NOV.2011 16:33:35

**Upper Channel (Max: Ant 2, HP)**

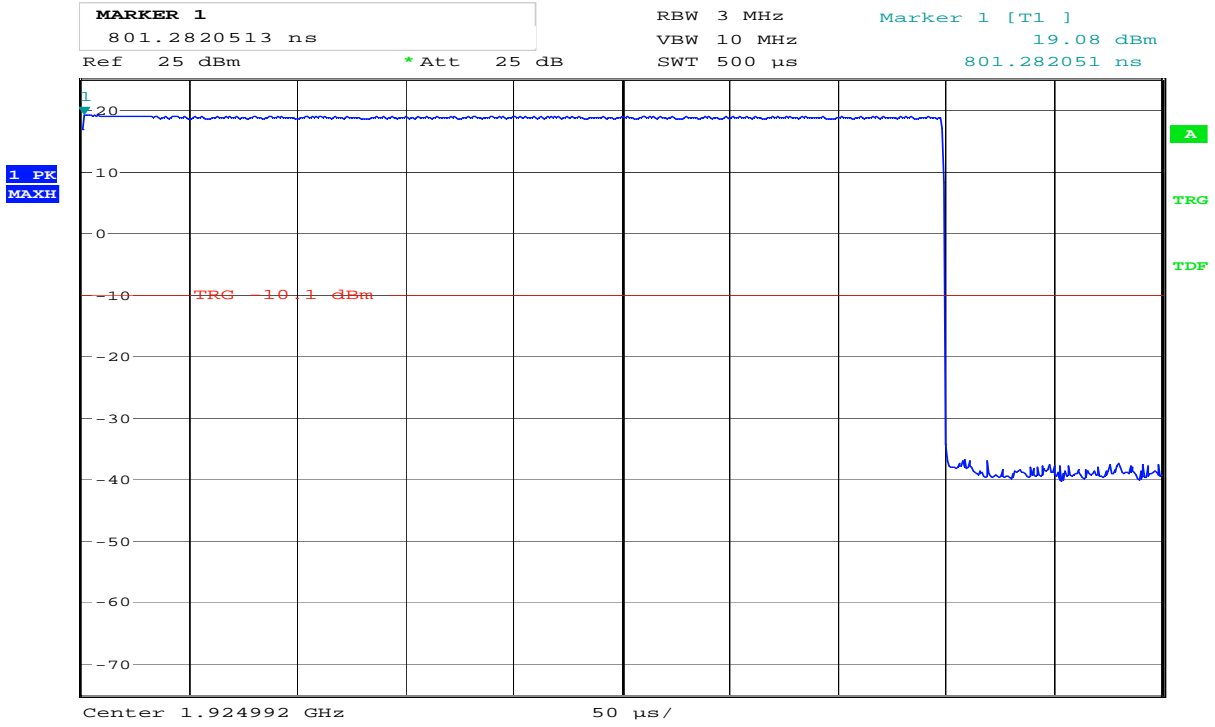

Date: 10.NOV.2011 16:29:46

**Middle Channel (Max: Ant 2, HP)**

## 4.8 Spurious Emissions (Radiated)

### Measurement Procedure:

FCC 15.209

### Test Results:

#### Radiated Emissions 10 kHz - 30 MHz.

Detector: Quasi Peak

Measuring distance: 10m

No Emissions found. See plots.

#### Radiated Emissions 30 - 1000 MHz.

Detector: Quasi Peak

Measuring distance: 3m

#### Quasi Peak Det., AC Adaptor PNLV226(FW), On-Hook, Charging:

Frequency (MHz)	QuasiPeak (dB $\mu$ V/m)	Meas. Time (ms)	Bandwidth (kHz)	Height (cm)	Polarization	Azimuth (deg)	Corr. (dB)	Margin (dB)	Limit (dB $\mu$ V/m)	Comment
47.374041	23.3	1000.0	120.000	100.0	V	253.0	-9.3	16.7	40.0	
50.253869	27.9	1000.0	120.000	100.0	V	274.0	-9.5	12.1	40.0	
56.165250	18.0	1000.0	120.000	100.0	V	205.0	-9.7	22.0	40.0	
82.901405	23.4	1000.0	120.000	164.0	V	160.0	-12.8	16.6	40.0	
165.877926	22.6	1000.0	120.000	100.0	V	69.0	-12.9	20.9	43.5	
210.132781	15.5	1000.0	120.000	164.0	H	319.0	-10.5	28.0	43.5	
222.165466	21.4	1000.0	120.000	155.0	H	18.0	-10.1	24.6	46.0	

#### Quasi Peak Det., AC Adaptor PNLV226(FW), Off-Hook:

Frequency (MHz)	QuasiPeak (dB $\mu$ V/m)	Meas. Time (ms)	Bandwidth (kHz)	Height (cm)	Polarization	Azimuth (deg)	Corr. (dB)	Margin (dB)	Limit (dB $\mu$ V/m)	Comment
47.380375	22.1	1000.0	120.000	100.0	V	0.0	-9.3	17.9	40.0	
50.339074	29.3	1000.0	120.000	100.0	V	10.0	-9.5	10.7	40.0	
56.192385	22.1	1000.0	120.000	100.0	V	298.0	-9.7	17.9	40.0	

#### Quasi Peak Det., AC Adaptor PNLV226(UC), On-Hook, Charging:

Frequency (MHz)	QuasiPeak (dB $\mu$ V/m)	Meas. Time (ms)	Bandwidth (kHz)	Height (cm)	Polarization	Azimuth (deg)	Corr. (dB)	Margin (dB)	Limit (dB $\mu$ V/m)	Comment
47.359292	26.5	1000.0	120.000	100.0	V	193.0	-9.3	13.5	40.0	
50.329342	27.0	1000.0	120.000	100.0	V	276.0	-9.5	13.0	40.0	
204.347285	17.4	1000.0	120.000	144.0	H	6.0	-10.7	26.1	43.5	
216.087182	17.7	1000.0	120.000	130.0	H	206.0	-10.3	28.3	46.0	
245.988494	19.7	1000.0	120.000	138.0	H	289.0	-9.2	26.3	46.0	

#### Quasi Peak Det., AC Adaptor PNLV226(UC), Off-Hook:

Frequency (MHz)	QuasiPeak (dB $\mu$ V/m)	Meas. Time (ms)	Bandwidth (kHz)	Height (cm)	Polarization	Azimuth (deg)	Corr. (dB)	Margin (dB)	Limit (dB $\mu$ V/m)	Comment
47.176168	23.1	1000.0	120.000	100.0	V	251.0	-9.3	16.9	40.0	
50.208182	29.9	1000.0	120.000	100.0	V	182.0	-9.5	10.1	40.0	
165.891640	23.7	1000.0	120.000	100.0	V	276.0	-12.9	19.8	43.5	

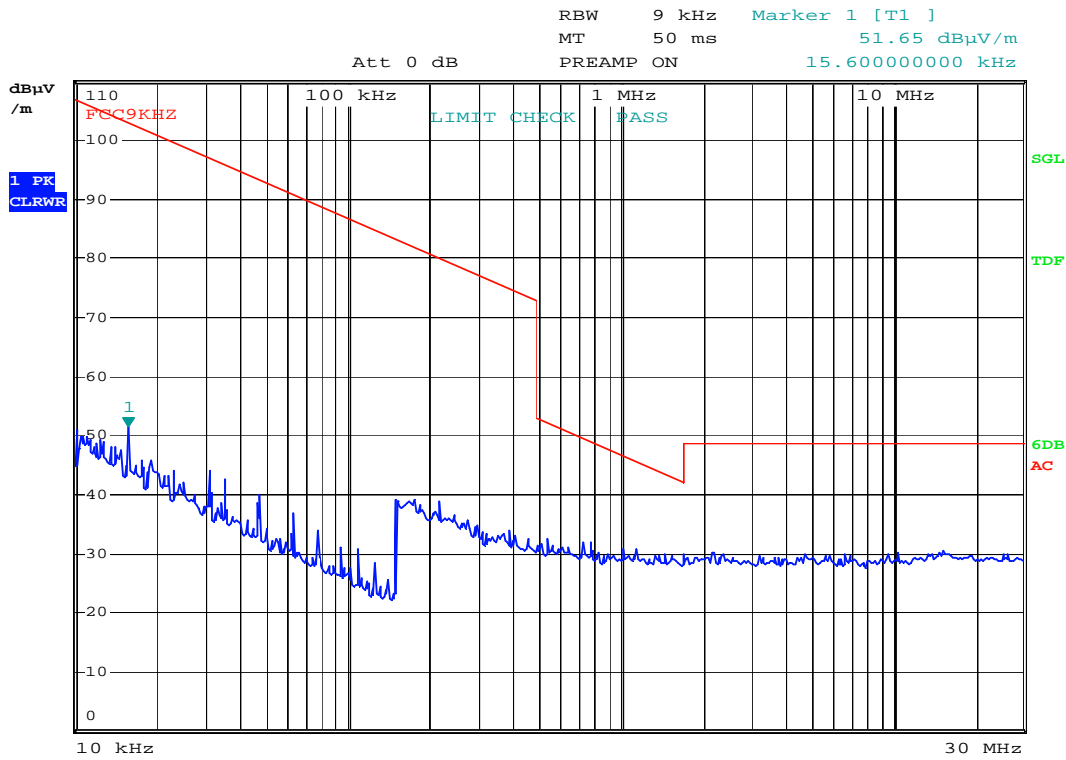

**Spurious Emissions 10 kHz – 30 MHz, Adaptor PNLV226(FW)**

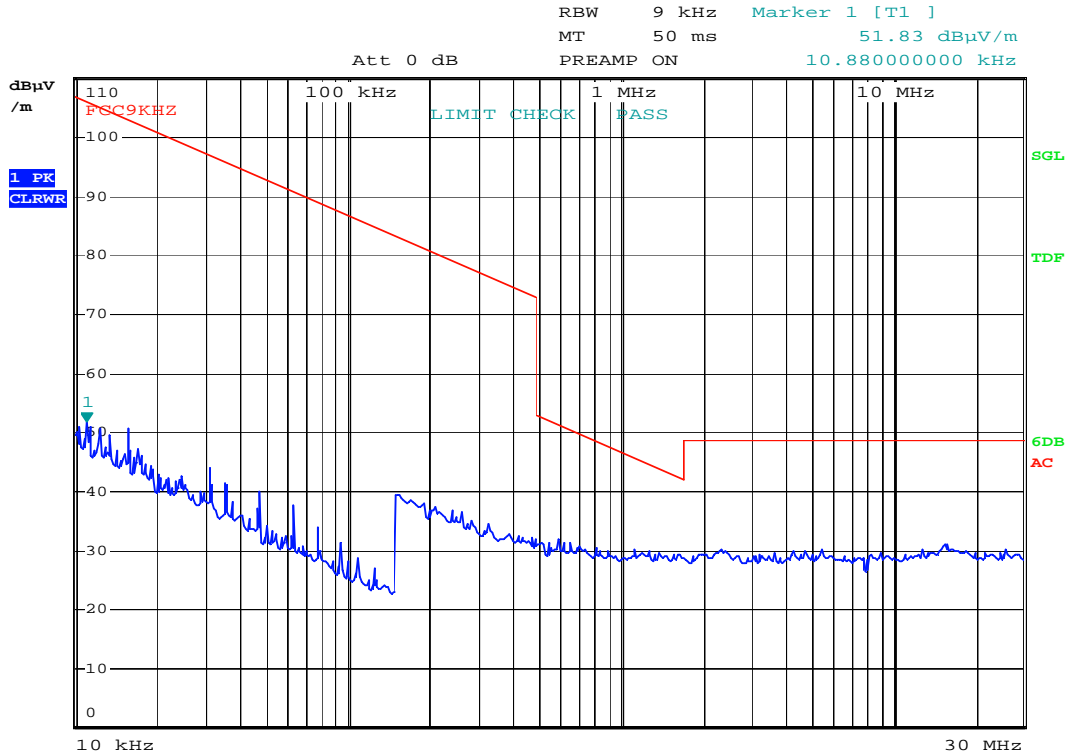

**Spurious Emissions 10 kHz – 30 MHz, Adaptor PNLV226(UC)**

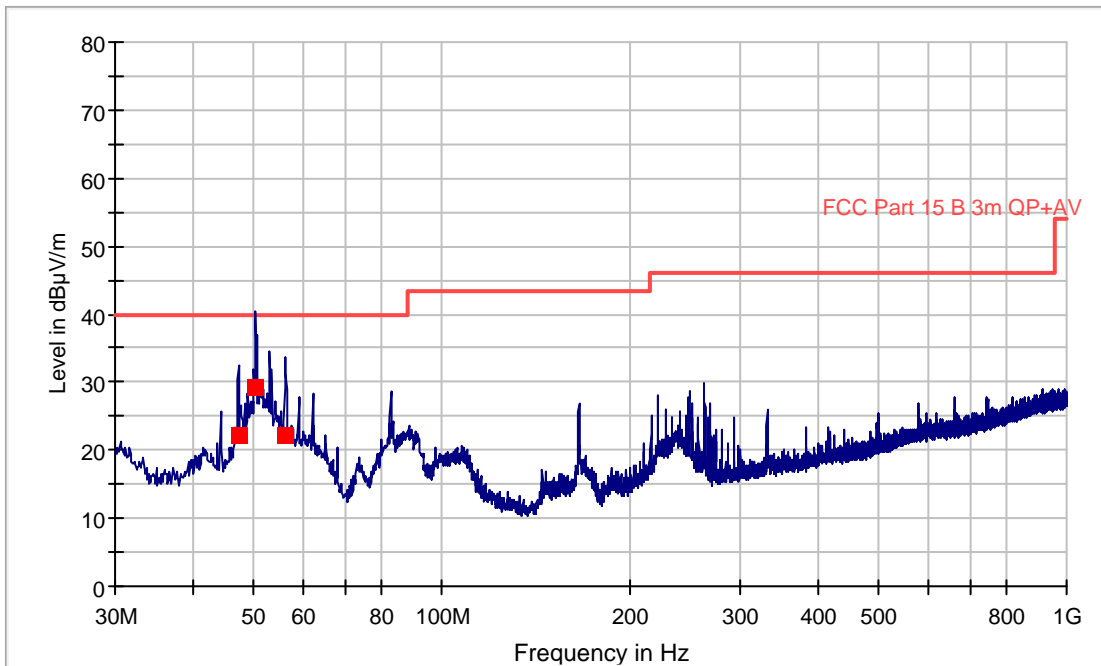

**Spurious Emissions 30 – 1000 MHz, Off-Hook, Adaptor PNLV226(FW)**

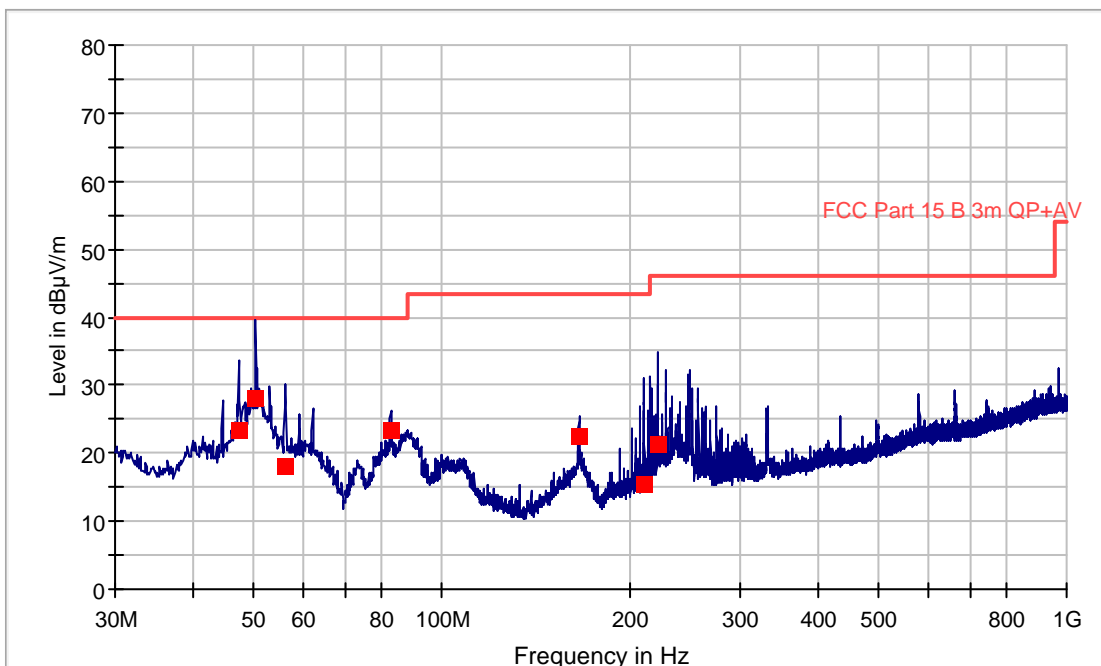

**Spurious Emissions 30 – 1000 MHz, On-Hook, Charging, HP Adaptor PNLV226(FW)**

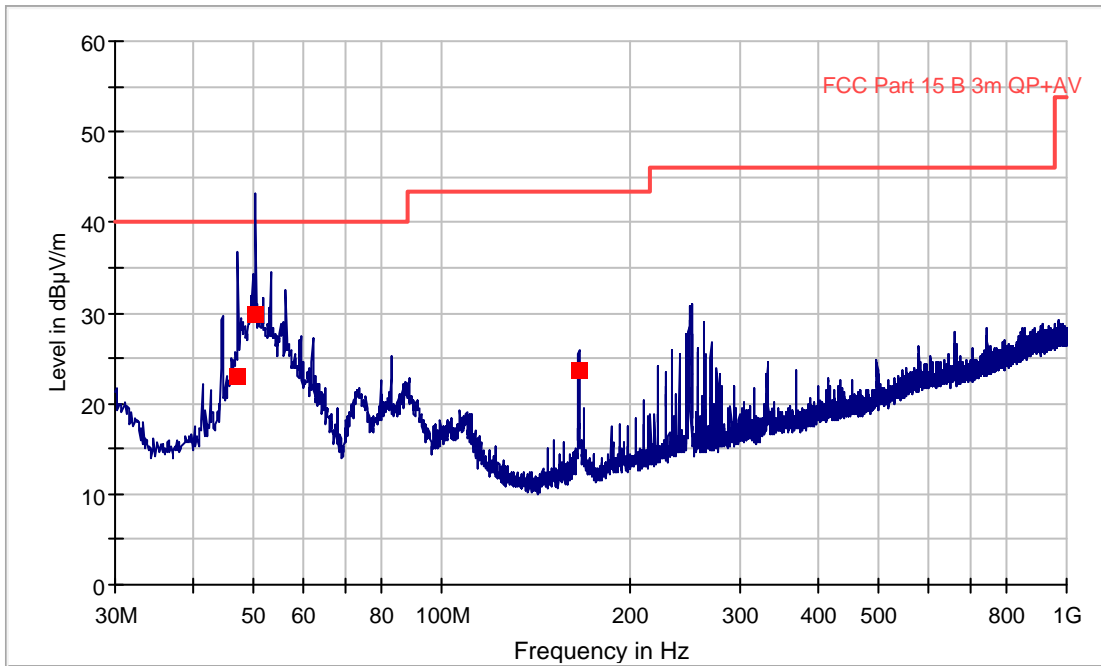

**Spurious Emissions 30 - 1000 MHz, Off-Hook, Adaptor PNLV226(UC)**

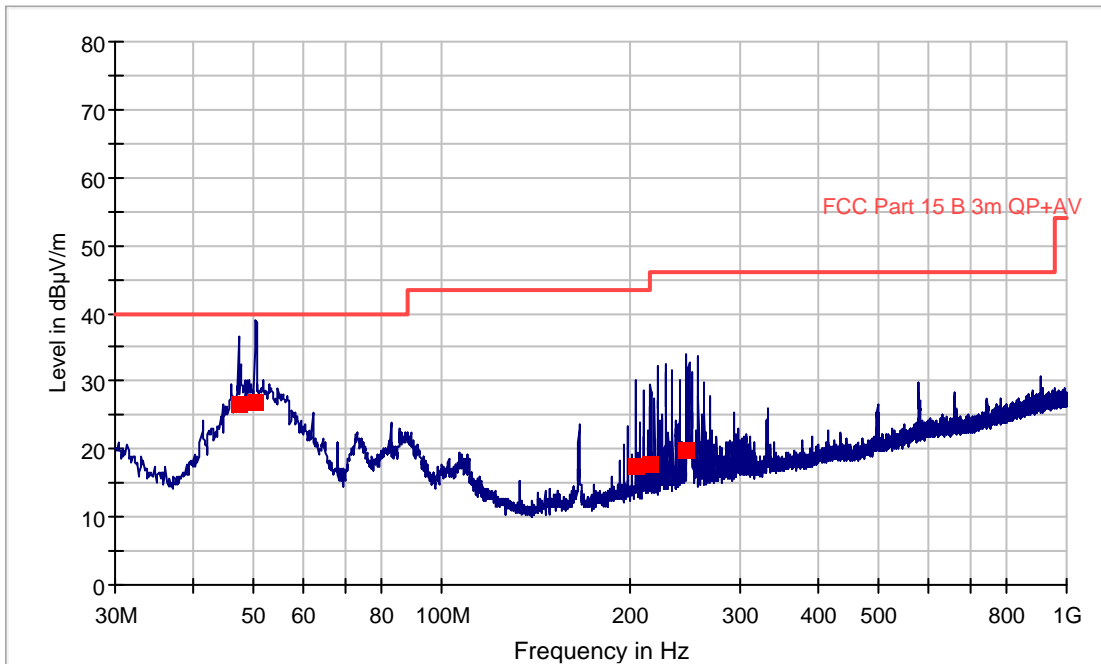

**Spurious Emissions 30 - 1000 MHz, On-Hook, Charging, Adaptor PNLV226(UC)**

## 5 Test Setups

### 5.1 Radiated Emissions Test, Semi-Anechoic Chamber

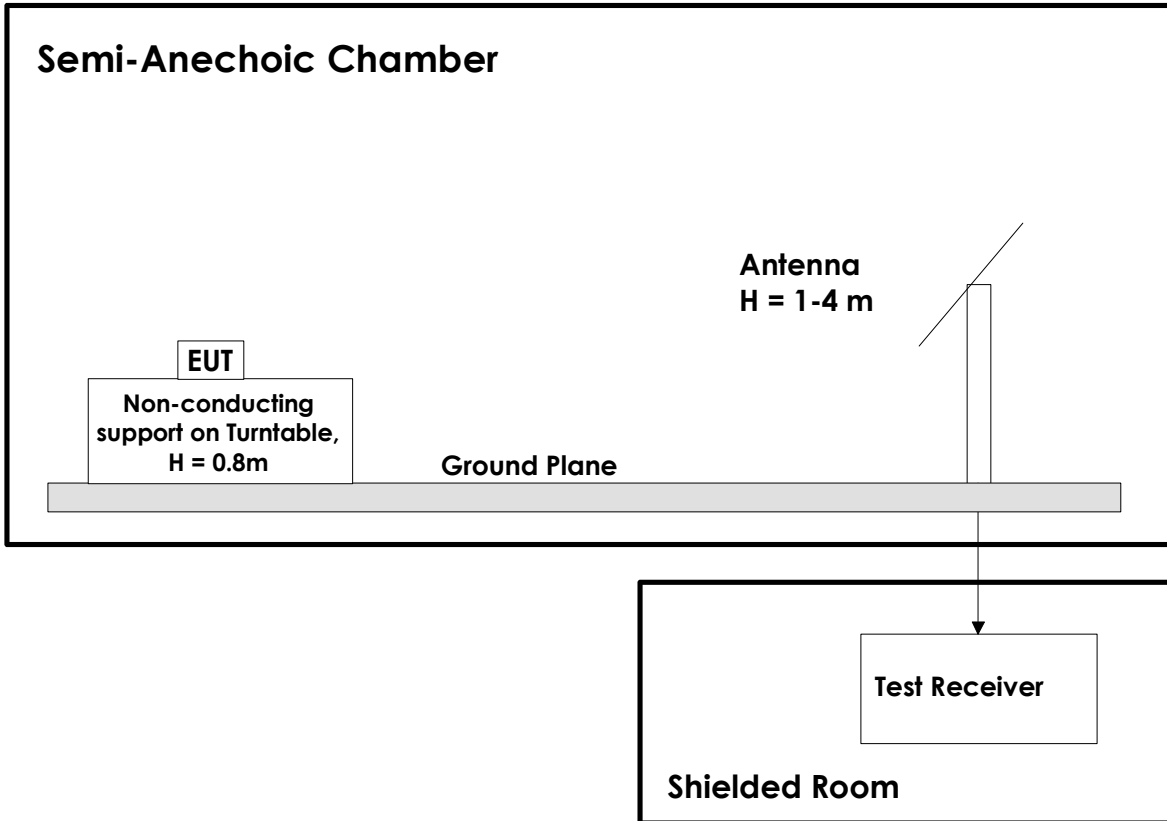

Test equipment: 6, 10, 13, 15, 16

#### Test Set-Up 1

This test setup is used for all radiated emissions tests. For frequencies below 30 MHz the measuring distance is 10 m, for all other frequencies it is 3m or 1m. Emissions above 1 GHz were measured with a Spectrum Analyzer and Horn Antenna and with the preamplifier after the antenna. For measurements above 18 GHz the test receiver is moved inside the anechoic chamber and located next to the antenna to minimize the cable loss.

### 5.2 Power Line Conducted Emissions Test

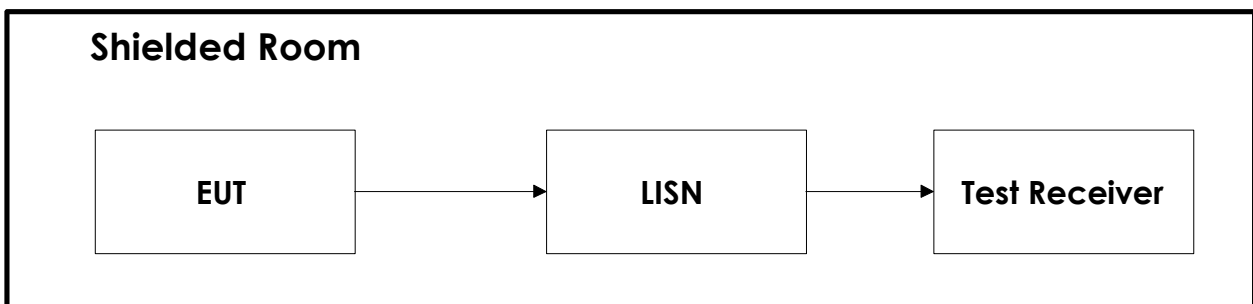

Test equipment: 2, 4, 5, 9, 17

#### Test Set-Up 2

### 5.3 Radiated Emissions Test, Fully Anechoic Chamber

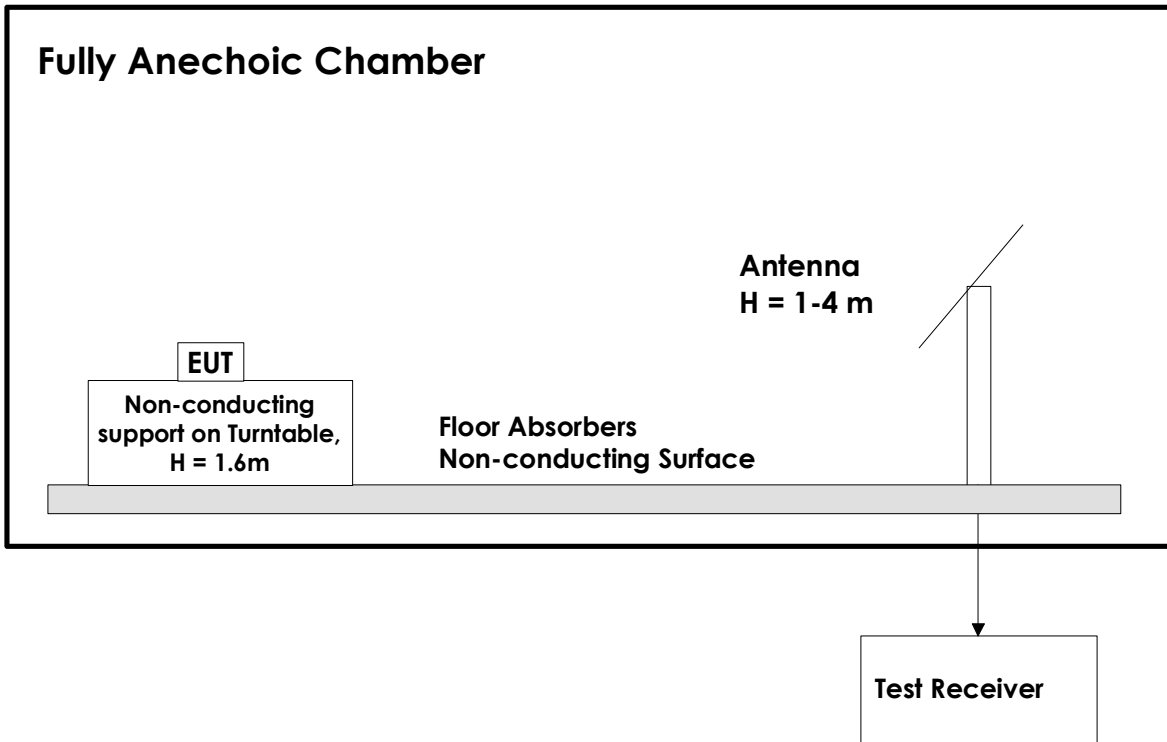

Test equipment: 1, 3, 6, 7, 8, 11, 12, 14

#### Test Set-Up 3

This test setup is used for measuring radiated output power. The measurements are performed in a 3m Fully Anechoic Chamber with a Spectrum Analyzer and Horn Antenna, a preamplifier may be used after the antenna. The measuring distance is 3m.

## 6 Test Equipment Used

To facilitate inclusion on each page of the test equipment used for related tests, each item of test equipment and ancillaries are identified (numbered) by the Testhouse.

No.	Model number	Description	Manufacturer	Ref. no.	Cal. date	Cal. Due
1	FSU26	Spectrum Analyzer	Rohde & Schwarz	LR 1504	2011.11.03	2013.11.03
2	ESHS10	Measuring Receiver	Rohde & Schwarz	N-3528	2011-06	2012-06
3	6810.17B	Attenuator	Suhner	LR1212	2010.09.15	2012.09.15
4	ESH3-Z5	Two Line V-Network	Rohde & Schwarz	LR 1076	2011.11.03	2013.11.03
5	80S	Signal Generator	Powertron	LT 502	Cal b4 use	
6	6812B	AC Power Source	Agilent	LR 1515	2011.04.13	2012.04.13
7	JS4	Pre-Amplifier	Miteq	LR 1552	2011.09.28	2012.09.28
8	U2000A	USB Power Sensor	Agilent	LR 1523	2011.03.26	2012.03.26
9	ESH3-Z2	Pulse Limiter	Rohde & Schwarz	N-3932	2010.11.04	2012.11.04
10	ESCI	Measuring Receiver	Rohde & Schwarz	N-4259	2010.11.03	2012.11.03
11	3115	Horn Antenna	EMCO	LR 1226	N/A	
12	3115	Horn Antenna	EMCO	LR 1330	2010.08.05	2013.08.05
13	VLUB	BiLog Antenna	Schwarzbeck	LR 1616	2011.08.29	2014.08.29
14	Model 7200	Signal generator	Gigatronics	LR 1188	2010.11.02	2012.11.02
15	LNA6900	Pre-amplifier	Teseq	LR 1593	2010-11	2011-11
16	HFHZ2-Z2	Loop Antenna	Rohde & Schwarz	LR 285	2010.10.08	2013.10.08
17	Model 87 V	Multimeter	Fluke	LR1600	2010.12.15	2012.12.15