



Test report no. : 190511-6

Item tested : KX-TG4741

Type of equipment : UPCS Base Station

FCC ID : ACJ96NKX-TG4741

Client : Panasonic System Networks Co., Ltd.

FCC Part 15, subpart D

Isosynchronous UPCS Device
1920 - 1930 MHz

Industry Canada RSS-213, Issue 2

2 GHz Licence-exempt Personal
Communications Service Devices
(LE-PCS)

22 November 2011

Authorized by :

G. Suhanthakumar
Technical Vericator

CONTENTS

1	GENERAL INFORMATION	3
1.1	Testhouse Info	3
1.2	Client Information	3
1.3	Responsible Manufacturer (if other than client)	3
2	TEST INFORMATION	4
2.1	Tested Item	4
2.2	Description of Tested Device	4
2.3	Exposure Evaluation	4
2.4	Test Environment	5
2.5	Test Period	5
2.6	Test Engineer(s)	5
2.7	Test Equipment	5
2.8	Other Comments	5
3	TEST REPORT SUMMARY	6
3.1	General	6
3.2	Test Summary	7
4	TEST RESULTS	8
4.1	Power Line Conducted Emissions	8
4.2	Coordination with fixed microwave	12
4.3	Digital Modulation Techniques	12
4.4	Labeling Requirements	12
4.5	Antenna Requirement	13
4.6	Channel Frequencies	13
4.7	Peak Power Output	14
4.8	Spurious Emissions (Radiated)	17
5	TEST SETUPS	21
5.1	Radiated Emissions Test, Semi-Anechoic Chamber	21
5.2	Power Line Conducted Emissions Test	21
5.3	Radiated Emissions Test, Fully Anechoic Chamber	22
6	TEST EQUIPMENT USED	23

1 GENERAL INFORMATION

1.1 Testhouse Info

Name : Nemko AS
Address : Nemko Kjeller
Instituttveien 6
N-2007 Kjeller, NORWAY
Telephone : +47 64 84 57 00
Fax : +47 64 84 57 05
E-mail: comlab@nemko.com
FCC test firm registration # : 994405
IC OATS registration # : 2040D-1
Total Number of Pages: 23

1.2 Client Information

Name : Panasonic System Networks Co., Ltd.
Address : 1-62, 4-Chome, Minoshima, Hakata-ku, Fukuoka 812-8531 Japan
Telephone : +81-92-477-1405
Fax : +81-92-477-1487

Contact:

Name : Mr. Junji Sumi
Telephone : +81 92 477 1405
E-mail : sumi.junji@jp.panasonic.com

1.3 Responsible Manufacturer (if other than client)

Same as client.

2 Test Information

2.1 Tested Item

Name :	Panasonic
Model name :	KX-TG4741
FCC ID :	ACJ96NKX-TG4741
Industry Canada ID :	216A-KXTG4741
Serial number :	/
Hardware identity and/or version:	/
Software identity and/or version :	/
Tested to IC Radio Standard (RSS) :	RSS-213 Issue 2, RSS-GEN Issue 3
Test Site IC Reg. Number :	IC 2040D-1
Frequency Range :	1921.536 – 1928.448 MHz
Number of Channels :	5 RF Channels, 5x12 = 60 TDMA Duplex Channels
Type of Modulation :	Digital (Gaussian Frequency Shift Keying)
Peak Output Power :	98 mW (Conducted)
Antenna Connector :	None (Integral antennas)
Number of Antennas :	2
Antenna Diversity Supported :	Yes
Power Supply :	AC Adaptors: PNLV226(FW) or PNLV226(UC)

2.2 Description of Tested Device

The tested equipment is a DECT base which complies with the FCC requirements to an Isochronous UPCS device after FCC Part 15D. The EUT is an responding device as described in ANSI C63.17 and is designed to operate together with a DECT portable part (i.e. a handset), which is then the initiating device.

2.3 Exposure Evaluation

The EUT is designed to be fixed to a wall etc. and the user manual contains text that it shall be mounted with a separation distance of at least 20cm from any persons. For the purposes of exposure evaluation this EUT is a mobile or fixed device. MPE Calculation at 20cm satisfying FCC requirements is submitted as a separate document.

The EUT is exempted from RF Exposure Evaluation to Industry Canada SAR requirements since the output power is below the limit in RSS-102 Issue 4, clause 2.5.2 for General Public Use.

2.4 Test Environment

Temperature:	19.9 – 21.6 °C
Relative humidity:	40 – 44 %
Normal test voltage:	120 V AC

The values are the limit registered during the test period.

2.5 Test Period

Item received date:	2011-11-03
Test period :	from 2011-11-07 to 2011-11-15

2.6 Test Engineer(s)

Frode Sveinsen / Thomas Dangle

2.7 Test Equipment

See list of test equipment in clause 6.

2.8 Other Comments

This test report covers only radiated tests. All other tests are covered by Nemko test report no. 137945-3.

The UPCS Base Station covered by this report is identical to the previously certified model KX-TG6531 (FCC ID: ACJ96NKX-TG6531) except for the antennas and certain changes to the PCB other than the RF part.

This new model also includes two new AC adaptors, Power-Line conducted emissions has therefore also been re-tested.

3 TEST REPORT SUMMARY

3.1 General

Manufacturer: Panasonic
Model No.: KX-TG4741
Serial No.: /

All measurements are traceable to national standards.

The tests were conducted on a sample of the equipment for the purpose of demonstrating compliance with FCC CFR47 Part 15D for Isochronous UPCS Devices and Industry Canada RSS-213 Issue 2 / RSS-GEN Issue 3.

All tests were conducted in accordance with ANSI C63.4-2009 and ANSI C63.17-2006. Antenna Gain tests were made in a 3m fully-anechoic chamber.

A description of the test facility is on file with the FCC and Industry Canada.

- | | |
|---|---|
| <input checked="" type="checkbox"/> New Submission | <input checked="" type="checkbox"/> Production Unit |
| <input type="checkbox"/> Class II Permissive Change | <input type="checkbox"/> Pre-production Unit |
| PUB Equipment Code | <input type="checkbox"/> Family Listing |

THIS TEST REPORT APPLIES ONLY TO THE ITEM(S) AND CONFIGURATIONS TESTED.

Deviations from, additions to, or exclusions from the test specifications are described in "Summary of Test Data".



TEST REPORT NO: 190511-6

TESTED BY : 
Frode Sveinsen, Chief Engineer

DATE: 14 November 2011

Nemko Group authorizes the above named company to reproduce this report provided it is reproduced in its entirety and for use by the company's employees only. Any reproduction of parts of this report requires approval in writing from Nemko Group.

Any use which a third party makes of this report, or any reliance on or decisions to be made based on it, are the responsibility of such third parties. Nemko Group accepts no responsibility for damages suffered by any third party as a result of decisions made or actions based on this report.

3.2 Test Summary

Name of test	FCC CFR 47 Paragraph #	IC RSS-213 Paragraph #	Verdict
Coordination with fixed microwave	15.307(b)	N/A	Complies
Digital Modulation Techniques	15.319(b)	6.1	Complies
Labeling requirements	15.19(a)(3)	RSS-GEN 5.2	Complies
Antenna Requirement	15.317, 15.203	4.1(e)	Complies
Power Line Conducted Emission	15.107(a) 15.207(a)	6.3 RSS-GEN 7.2.2	Complies
Peak transmit Power	15.319(c)(e), 15.31(e)	6.5	Complies
Spurious Emissions (Radiated)	15.319(g) 15.109(a) 15.209(a)	4.3.3 RSS-GEN 7.2.3	Complies

4 TEST RESULTS

4.1 Power Line Conducted Emissions

Para. No.: 15.207 (a)

Test Performed By: Thomas Dangle	Date of Test: 15 Nov 2011
----------------------------------	---------------------------

Measurement procedure: ANSI C63.4-2009 using 50 μ H/50 ohms LISN.

Test Results: Complies

Measurement Data: See attached graph, (Peak detector).

Highest measured value (L1 and N):

AC Adaptor PNLV226(UC):

Hook-On, Charging:

Frequency [MHz]	Level [dBuV]	Af [dB]	Limit [dBuV]	Margin [dB]	Det	Position	Verdict [Pass/Fail]
0.150000	24.10	10.10	56.00	31.90	AV	L1	Pass
0.350000	29.50	10.20	49.00	19.50	AV	L1	Pass
0.705000	19.00	10.20	46.00	27.00	AV	L1	Pass
1.120000	18.40	10.20	46.00	27.60	AV	N	Pass
1.960000	21.20	10.20	46.00	24.80	AV	L1	Pass
2.480000	23.30	10.30	46.00	22.70	AV	L1	Pass
4.065000	23.70	10.40	46.00	22.30	AV	L1	Pass
6.460000	18.60	10.50	50.00	31.40	AV	L1	Pass

Hook-Off:

Frequency [MHz]	Level [dBuV]	Af [dB]	Limit [dBuV]	Margin [dB]	Det	Position	Verdict [Pass/Fail]
0.355000	30.90	10.20	48.80	17.90	AV	N	Pass
1.240000	16.50	10.20	46.00	29.50	AV	N	Pass
1.775000	17.80	10.20	46.00	28.20	AV	N	Pass
2.915000	20.70	10.30	46.00	25.30	AV	L1	Pass
3.620000	21.30	10.30	46.00	24.70	AV	N	Pass

AC Adaptor PNLV226(FW):

Hook-On, Charging:

Frequency [MHz]	Level [dBuV]	Af [dB]	Limit [dBuV]	Margin [dB]	Det	Position	Verdict [Pass/Fail]
1.070000	38.40	10.20	56.00	17.60	QP	N	Pass
1.390000	39.20	10.20	56.00	16.80	QP	L1	Pass
0.375000	28.30	10.20	48.40	20.10	AV	N	Pass
0.720000	19.40	10.20	46.00	26.60	AV	L1	Pass
1.070000	24.30	10.20	46.00	21.70	AV	N	Pass
1.390000	25.90	10.20	46.00	20.10	AV	L1	Pass
2.380000	25.50	10.30	46.00	20.50	AV	L1	Pass
3.760000	25.50	10.30	46.00	20.50	AV	L1	Pass

Hook-Off:

Frequency [MHz]	Level [dBuV]	Af [dB]	Limit [dBuV]	Margin [dB]	Det	Position	Verdict [Pass/Fail]
0.385000	16.70	10.20	48.20	31.50	AV	L1	Pass
0.715000	18.30	10.20	46.00	27.70	AV	L1	Pass
1.160000	20.60	10.20	46.00	25.40	AV	N	Pass
1.615000	21.20	10.30	46.00	24.80	AV	N	Pass
2.145000	21.60	10.30	46.00	24.40	AV	L1	Pass
4.545000	21.90	10.40	46.00	24.10	AV	N	Pass

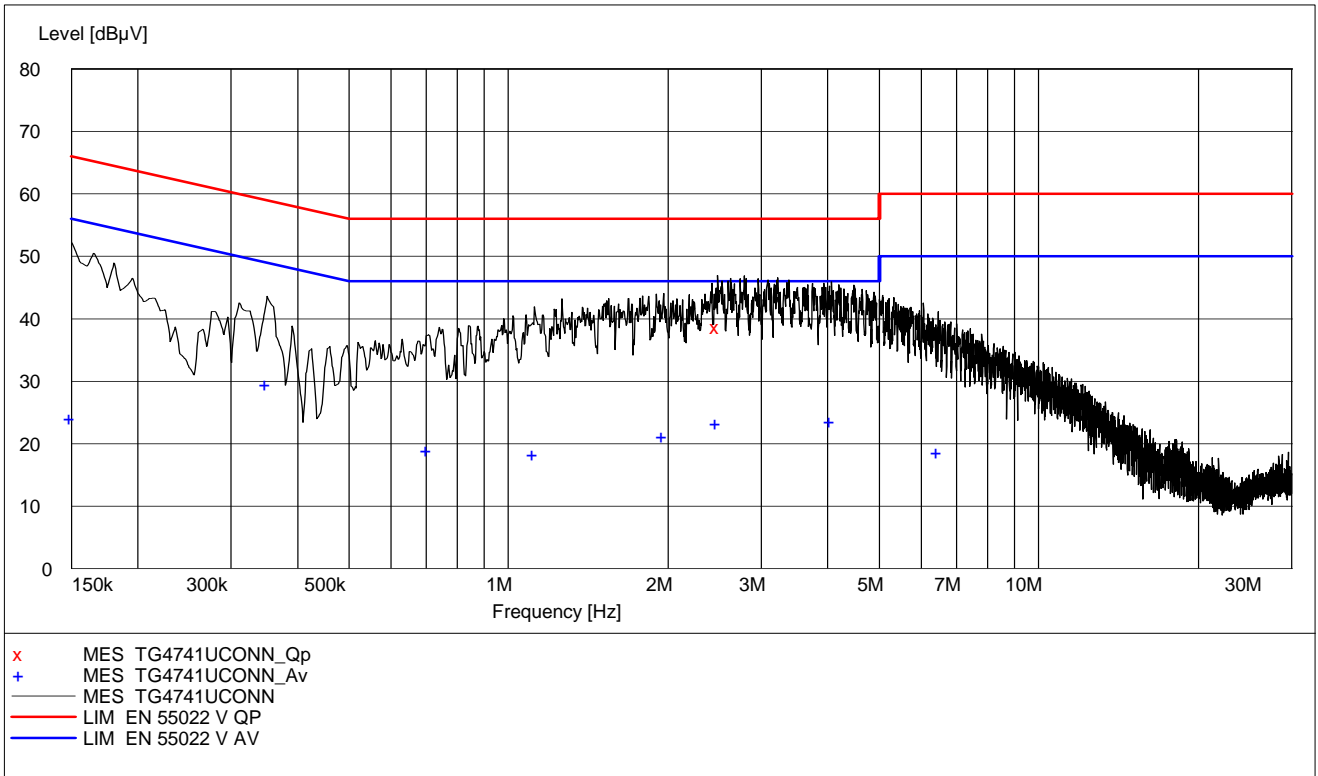

Phase L1 and N, Hook On, Charge Mode, AC Adaptor PNLV226(UC)

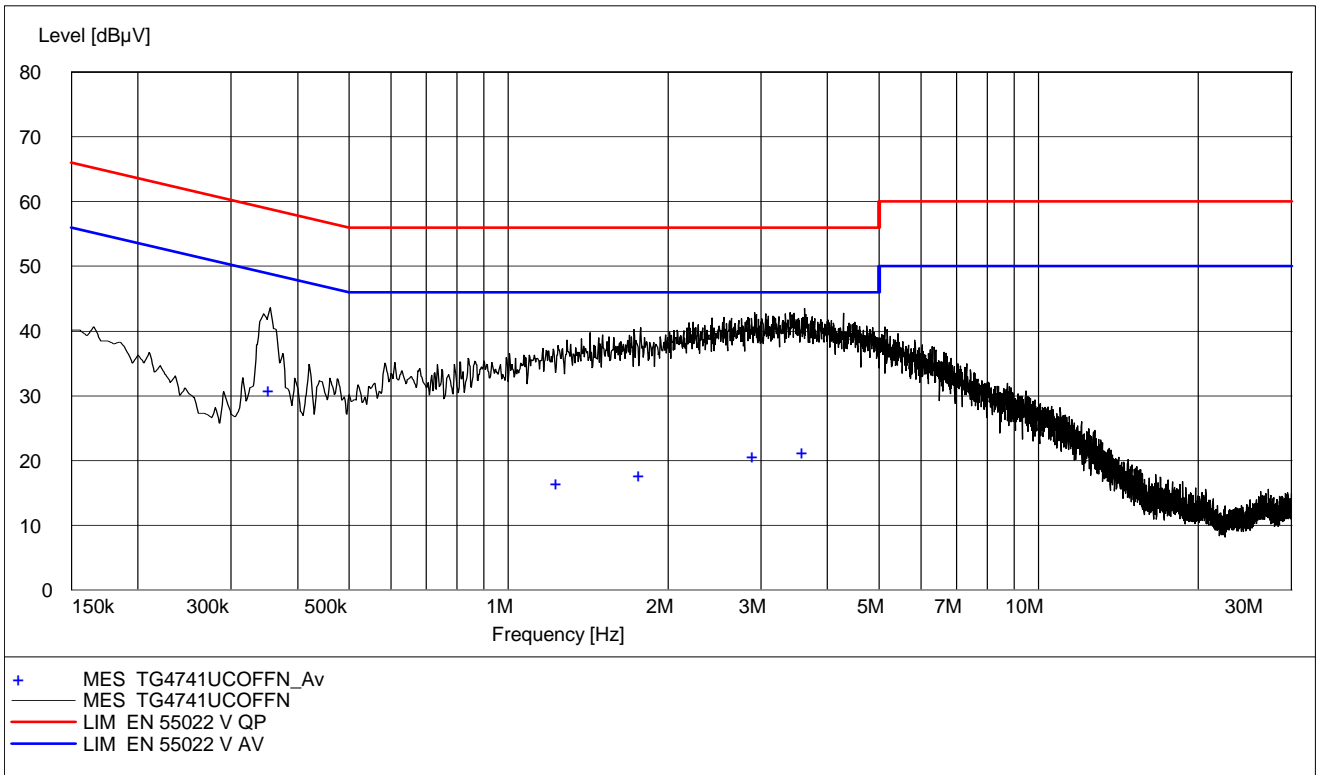

Phase L1 and N, Hook Off, AC Adaptor PNLV226(UC)

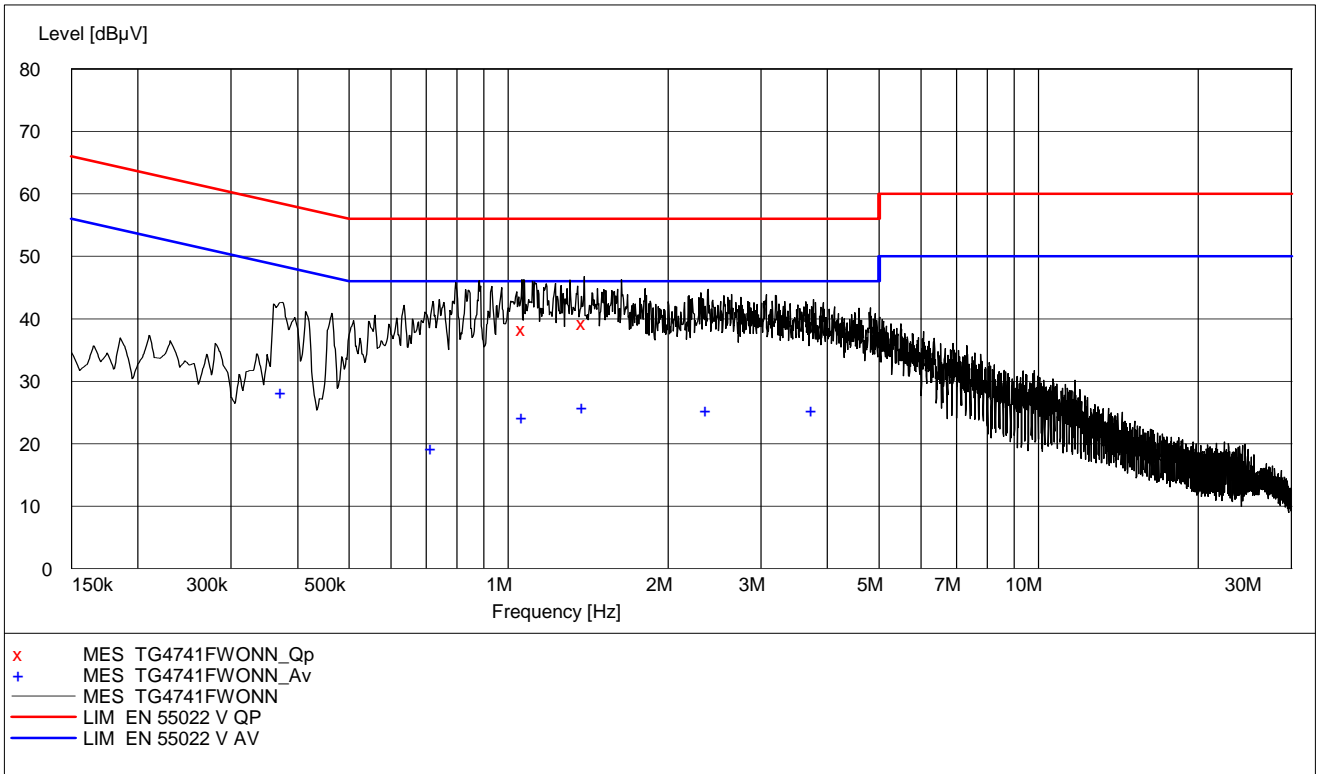

Phase L1 and N, Hook On, Charge Mode, AC Adaptor PNLV226(FW)

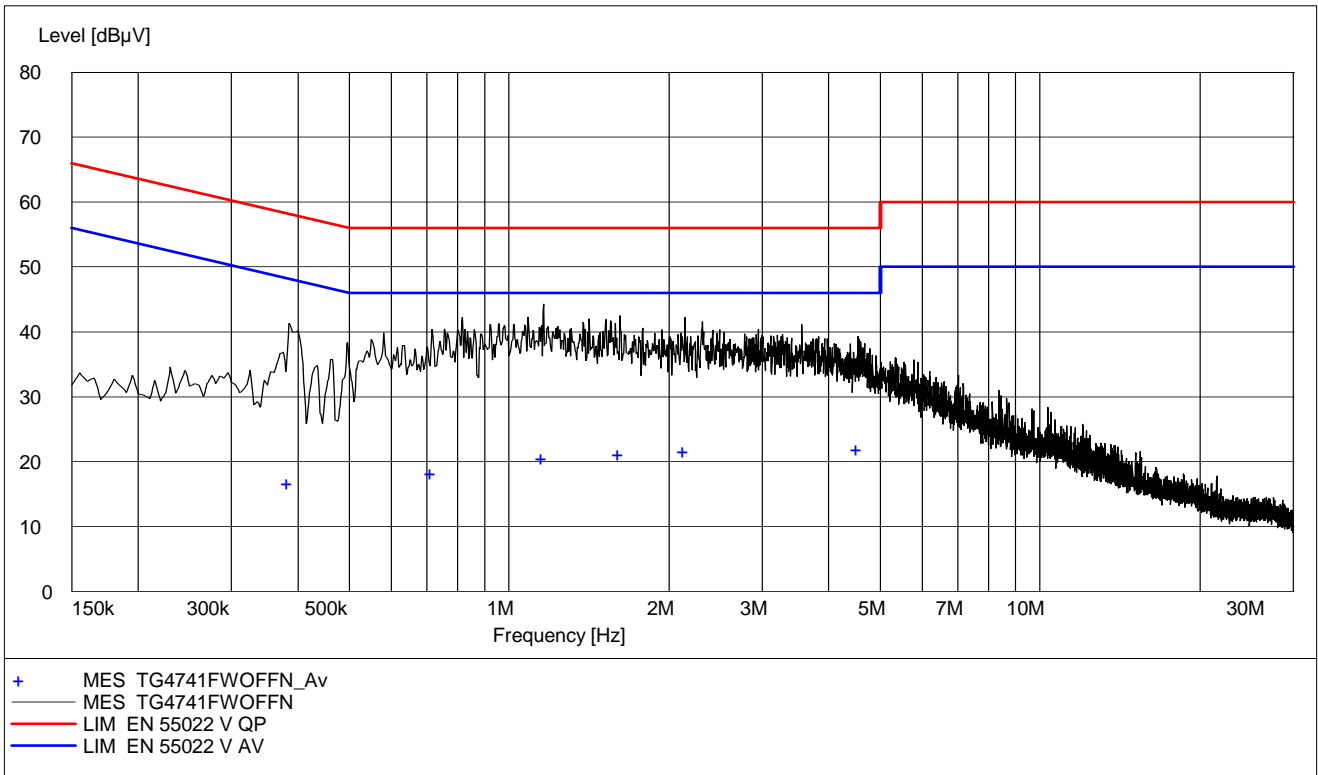

Phase L1 and N, Hook Off, AC Adaptor PNLV226(FW)

4.2 Coordination with fixed microwave

The affidavit from UTAM, Inc. is included in the documentation supplied by the applicant:

Yes

No

Requirement, FCC 15.307 (b):

Each application for certification of equipment operating under the provisions of this Subpart must be accompanied by an affidavit from UTAM, Inc. certifying that the applicant is a participating member of UTAM, Inc. In the event a grantee fails to fulfill the obligations attendant to participation in UTAM, Inc., the Commission may invoke administrative sanctions as necessary to preclude continued marketing and installation of devices covered by the grant of certification, including but not limited to revoking certification.

4.3 Digital Modulation Techniques

The tested equipment is based on DECT technology described in the ETSI standard EN 300175, the only difference is that the channel allocation is modified to operate in the 1920-1930 MHz band.

The EUT used Multi Carrier / Time Division Multiple Access / Time Division Duplex and Digital GFSK modulation.

For further details see the operational description provided by the applicant.

Requirement, FCC 15.319(b):

All transmissions must use only digital modulation techniques.

4.4 Labeling Requirements

See separate documents showing the label design and the placement of the label on the EUT.

Requirements FCC 15.19

The FCC Identifier shall be displayed on the label, and the device(s) shall bear the following statement in a conspicuous location on the device or in the user manual if the device is too small:

This device complies with Part 15 of the FCC Rules. Operation is subject to the following two conditions: (1) this device may not cause harmful interference, and (2) this device must accept any interference received, including interference that may cause undesired operation.

The label itself shall be of a permanent type, not a paper label, and shall last the lifetime of the equipment.

4.5 Antenna Requirement

Does the EUT have detachable antenna(s)? Yes No

If detachable, is the antenna connector(s) non-standard? Yes No

The tested equipment has only integral antennas. The conducted tests were performed on a sample with a temporary antenna connector.

Requirement: FCC 15.203, 15.204, 15.317.

4.6 Channel Frequencies

UPCS CHANNEL	FREQUENCY (MHz)
Upper Band Edge	1930.000
0 (Highest)	1928.448
1	1926.720
2	1924.992
3	1923.264
4 (Lowest)	1921.536
Lower Band Edge	1920.000

Requirement: FCC 15.303 (d), (g)

Within 1920 -1930 MHz band for isochronous devices.

4.7 Peak Power Output

Test Method:

ANSI C63.17, clause 6.1.2.

Test Results: Complies

Measurement Data:

Maximum Output Power

Channel No.	Frequency (MHz)	Maximum Conducted Output Power (dBm)	Maximum Radiated Output Power (dBm)	Maximum Antenna Gain (dBi)
4	1921.536	19.9	19.4	-0.5
2	1924.992	19.9	19.3	-0.6
0	1928.448	19.9	19.5	-0.4

Substitution:

Frequency MHz	Measured value dBm	Subst. Gen. (incl. corr.) dBm	Attenuator and Cable dB	Gain Subst. Antenna dB	Result dBm
1921.536	18.4	25.1	-14.0	8.3	19.4
1924.992	18.3	25.0	-14.0	8.3	19.3
1928.448	18.5	25.2	-14.0	8.3	19.5

Result = Subst.Gen. + Attenuator + Cable + Antenna Gain

Conducted values are from Nemko report no. 137945-3.

For this test it was also checked that input voltage variation of 85 and 115% of nominal value did not have any effect on the measured output power, neither radiated nor conducted.

Limit:

Conducted: $100 \mu\text{W} \times \text{SQRT}(B)$ where B is the measured Emission Bandwidth in Hz

FCC 15.319(c)(e): 21.85 dBm (153 mW)

RSS-213, Issue 2: 20.55 dBm (114 mW)

The antenna gain is below 3 dBi, no reduction in transmit power is necessary.

Requirements, FCC 15.319(c)(e), RSS-213, Issue 2

Peak transmit power shall not exceed 100 microwatts multiplied by the square root of the emission bandwidth in Hertz.

The peak transmit power shall be reduced by the amount in decibels that the maximum directional gain of the antenna exceeds 3 dBi.

Radiated Peak Output Power

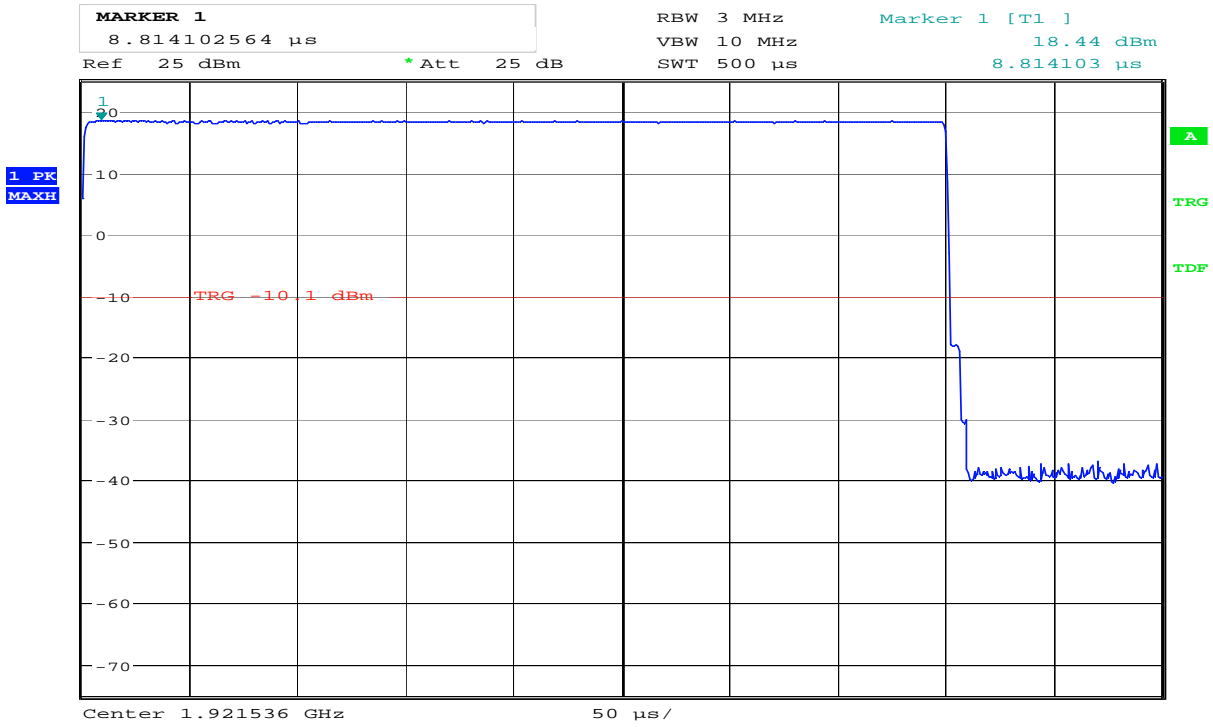

Date: 10.NOV.2011 15:23:41

Lower Channel (Max: Ant 2, HP)

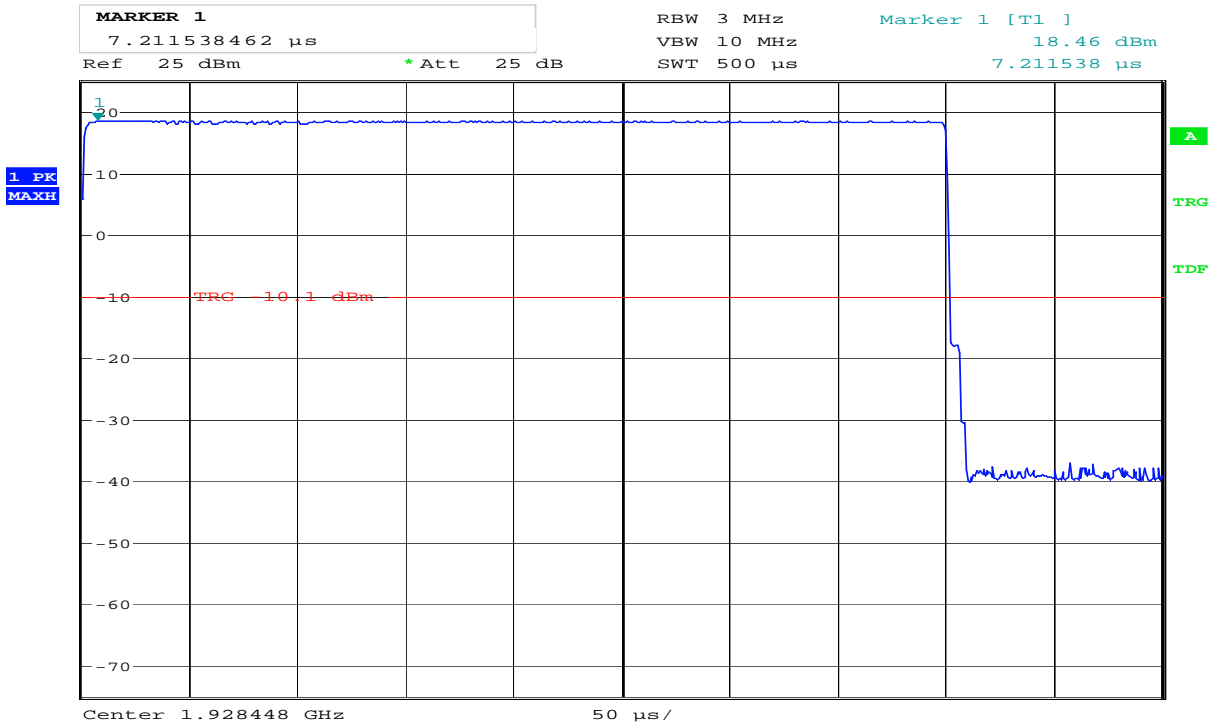

Date: 10.NOV.2011 15:21:27

Upper Channel (Max: Ant 2, HP)

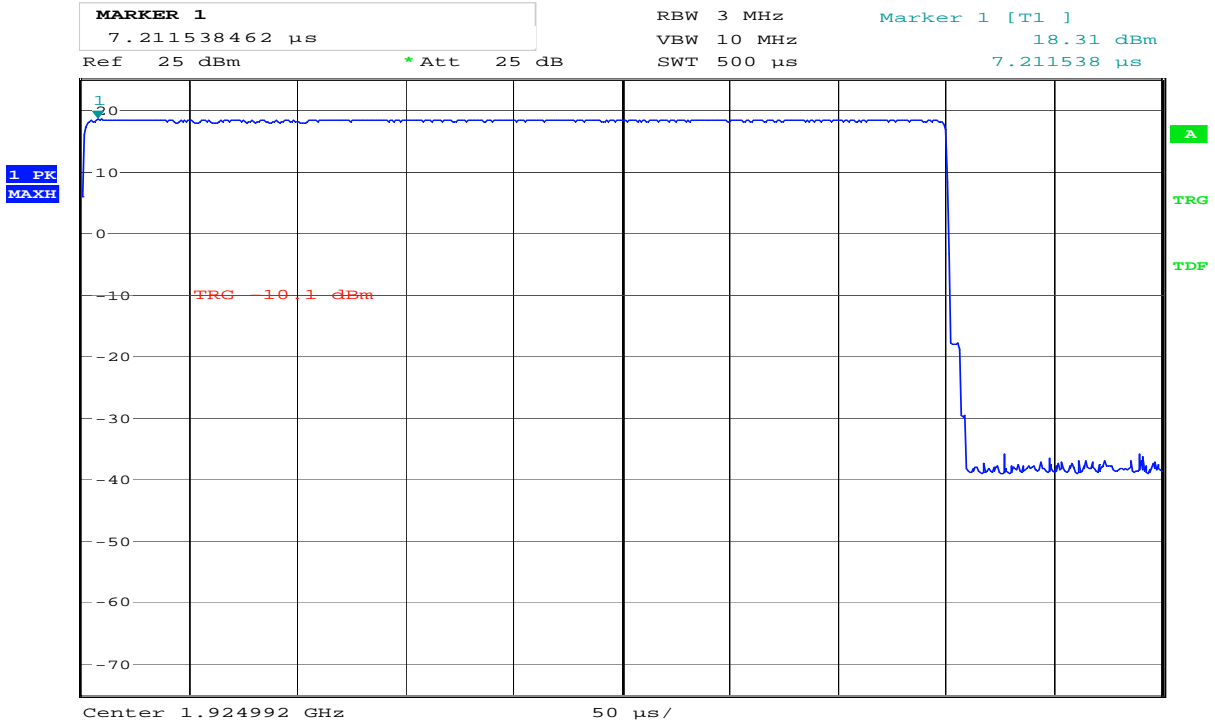

Date: 10.NOV.2011 15:18:54

Middle Channel (Max: Ant 2, HP)

4.8 Spurious Emissions (Radiated)

Measurement Procedure:

FCC 15.209

Test Results:

Radiated Emissions 10kHz - 30 MHz.

Detector: Quasi Peak

Measuring distance: 10m.

No emissions found, see plots.

Radiated Emissions 30 - 1000 MHz.

Detector: Quasi Peak

Measuring distance: 3m

Quasi Peak Det., AC Adaptor PNLV226(FW), Off-Hook:

Frequency (MHz)	QuasiPeak (dBµV/m)	Meas. Time (ms)	Bandwidth (kHz)	Height (cm)	Polarization	Azimuth (deg)	Corr. (dB)	Margin (dB)	Limit (dBµV/m)	Comment
41.859910	19.8	1000.0	120.000	100.0	V	117.0	-9.2	20.2	40.0	
46.001872	21.6	1000.0	120.000	100.0	V	206.0	-9.2	18.4	40.0	
62.000471	18.6	1000.0	120.000	100.0	V	201.0	-10.7	21.4	40.0	
86.001041	15.6	1000.0	120.000	158.0	V	243.0	-11.7	24.4	40.0	
905.293164	20.5	1000.0	120.000	176.0	V	93.0	2.7	25.5	46.0	

Quasi Peak Det., AC Adaptor PNLV226(FW), On-Hook, Charging:

Frequency (MHz)	QuasiPeak (dBµV/m)	Meas. Time (ms)	Bandwidth (kHz)	Height (cm)	Polarization	Azimuth (deg)	Corr. (dB)	Margin (dB)	Limit (dBµV/m)	Comment
42.012818	22.4	1000.0	120.000	100.0	V	278.0	-9.2	17.6	40.0	

Quasi Peak Det., AC Adaptor PNLV226(UC), Off-Hook:

Frequency (MHz)	QuasiPeak (dBµV/m)	Meas. Time (ms)	Bandwidth (kHz)	Height (cm)	Polarization	Azimuth (deg)	Corr. (dB)	Margin (dB)	Limit (dBµV/m)	Comment
37.881430	12.4	1000.0	120.000	100.0	V	71.0	-9.7	27.6	40.0	
41.991836	21.9	1000.0	120.000	100.0	V	90.0	-9.2	18.1	40.0	
65.992744	20.2	1000.0	120.000	100.0	V	294.0	-12.2	19.8	40.0	

Quasi Peak Det., AC Adaptor PNLV226(UC), On-Hook, Charging:

Frequency (MHz)	QuasiPeak (dBµV/m)	Meas. Time (ms)	Bandwidth (kHz)	Height (cm)	Polarization	Azimuth (deg)	Corr. (dB)	Margin (dB)	Limit (dBµV/m)	Comment
42.009352	22.4	1000.0	120.000	100.0	V	20.0	-9.2	17.6	40.0	

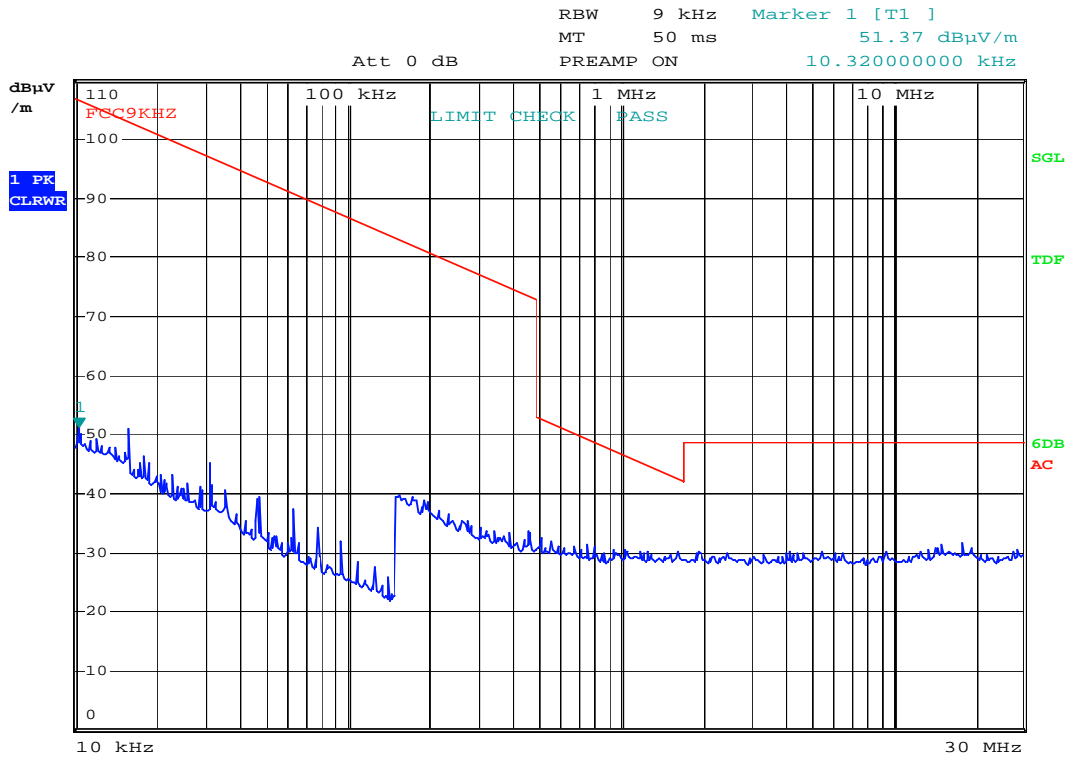

Spurious Emissions 10 kHz – 30 MHz, Adaptor PNLV226(FW)

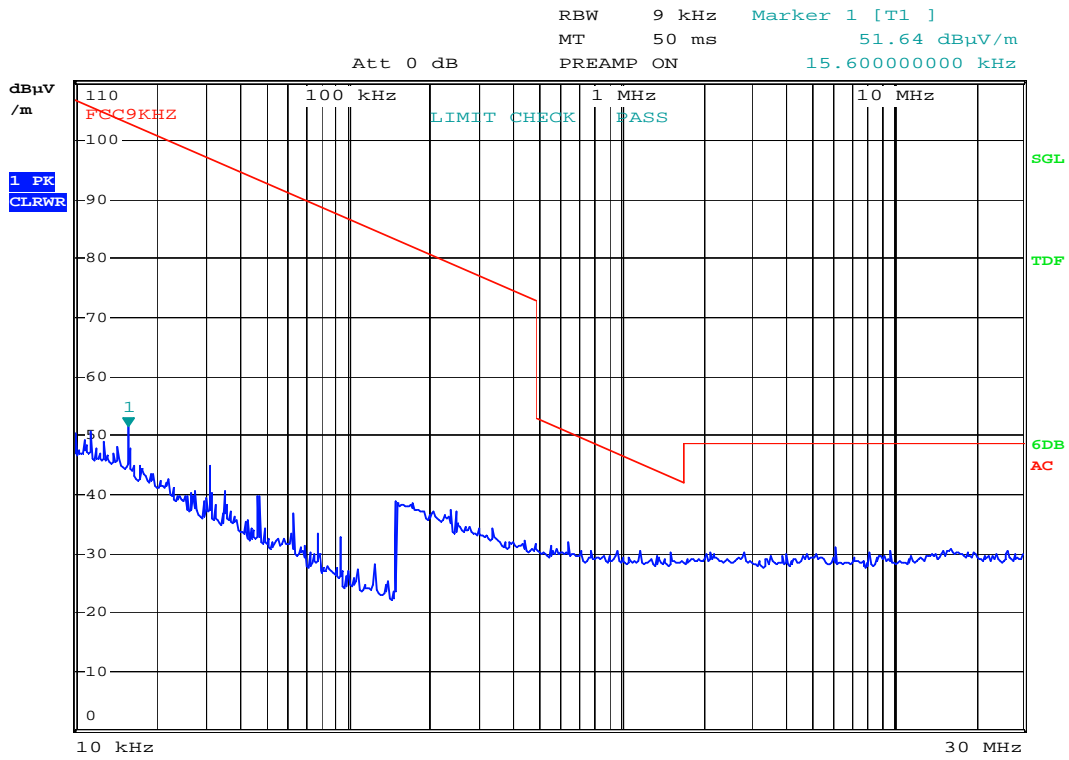

Spurious Emissions 10 kHz – 30 MHz, Adaptor PNLV226(UC)

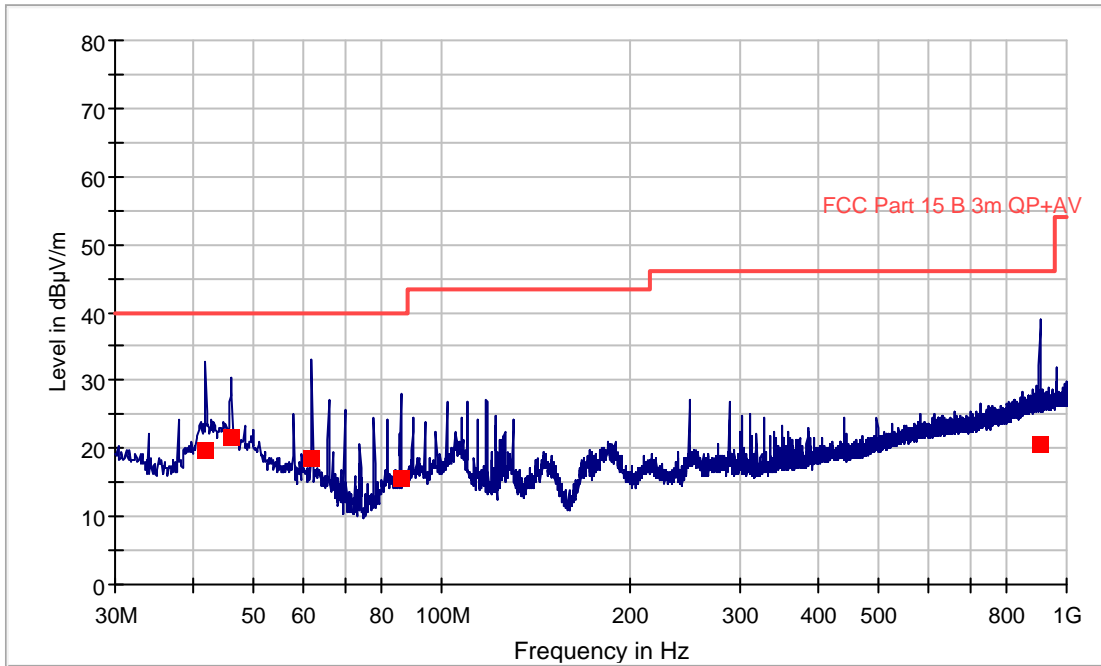

Spurious Emissions 30 – 1000 MHz, Off-Hook, Adaptor PNLV226(FW)

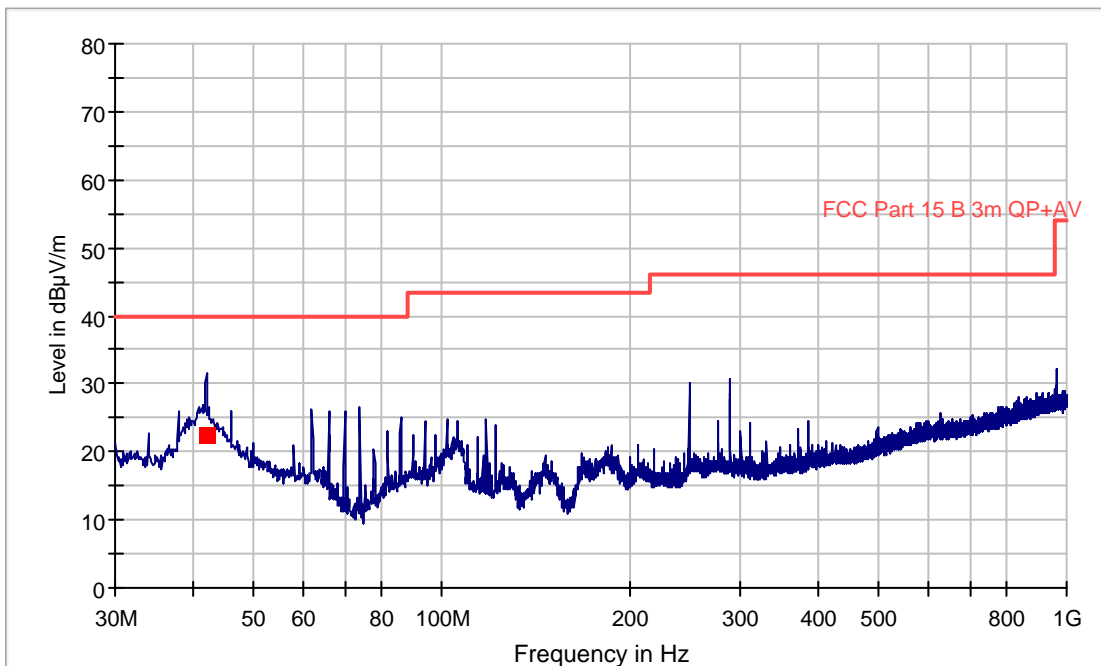

Spurious Emissions 30 – 1000 MHz, On-Hook, Charging, HP Adaptor PNLV226(FW)

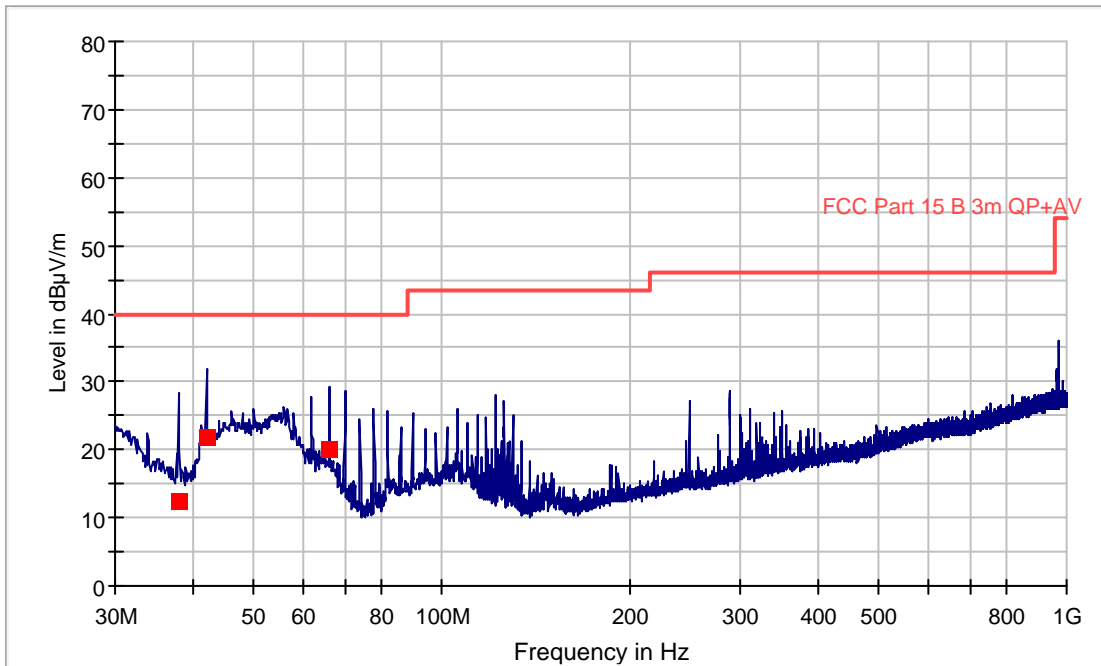

Spurious Emissions 30 - 1000 MHz, Off-Hook, Adaptor PNLV226(UC)

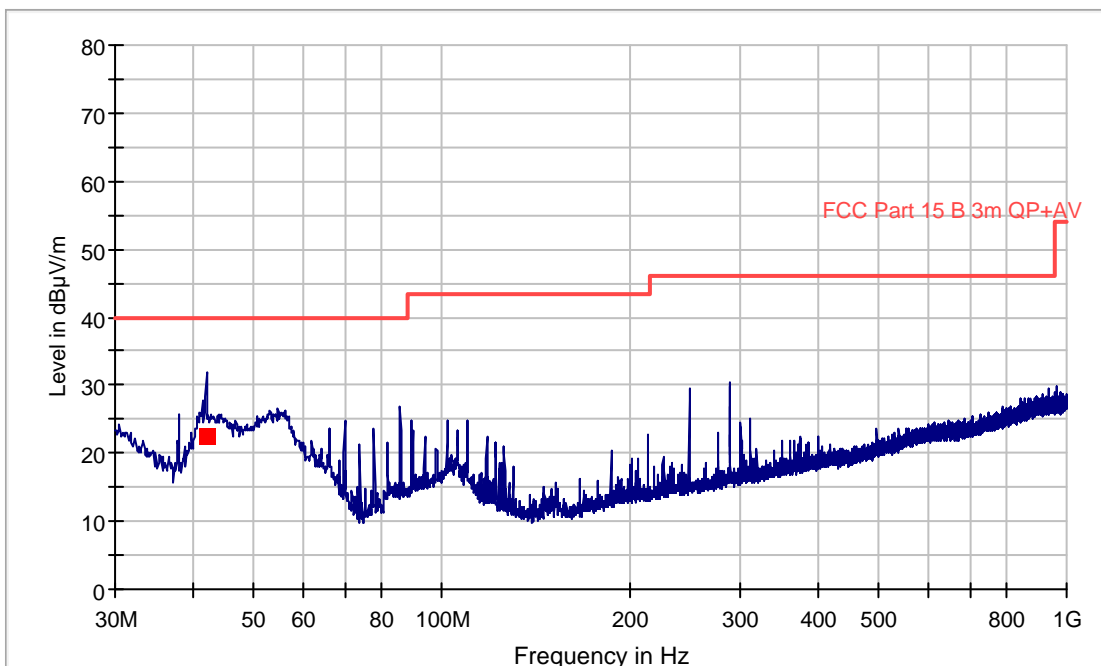

Spurious Emissions 30 - 1000 MHz, On-Hook, Charging, Adaptor PNLV226(UC)

5 Test Setups

5.1 Radiated Emissions Test, Semi-Anechoic Chamber

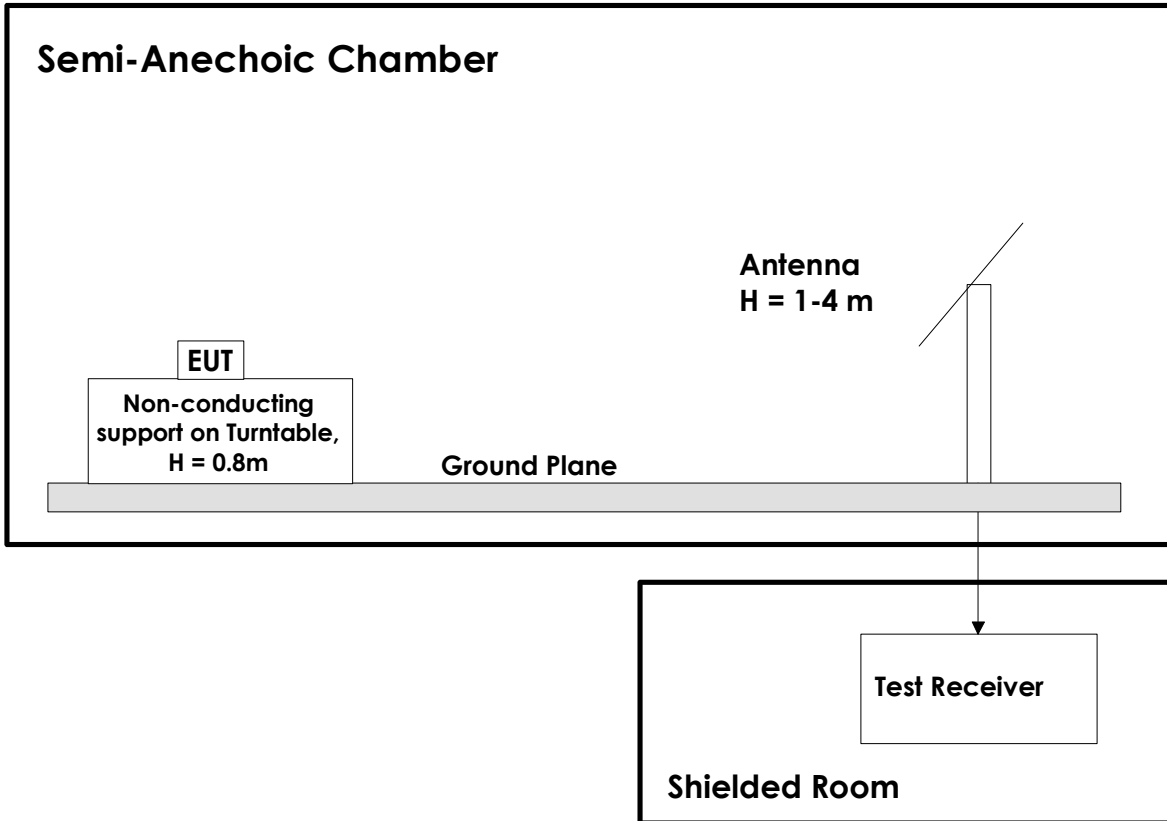

Test equipment: 6, 10, 13, 15, 16

Test Set-Up 1

This test setup is used for all radiated emissions tests. For frequencies below 30 MHz the measuring distance is 10 m, for all other frequencies it is 3m or 1m. Emissions above 1 GHz were measured with a Spectrum Analyzer and Horn Antenna and with the preamplifier after the antenna. For measurements above 18 GHz the test receiver is moved inside the anechoic chamber and located next to the antenna to minimize the cable loss.

5.2 Power Line Conducted Emissions Test

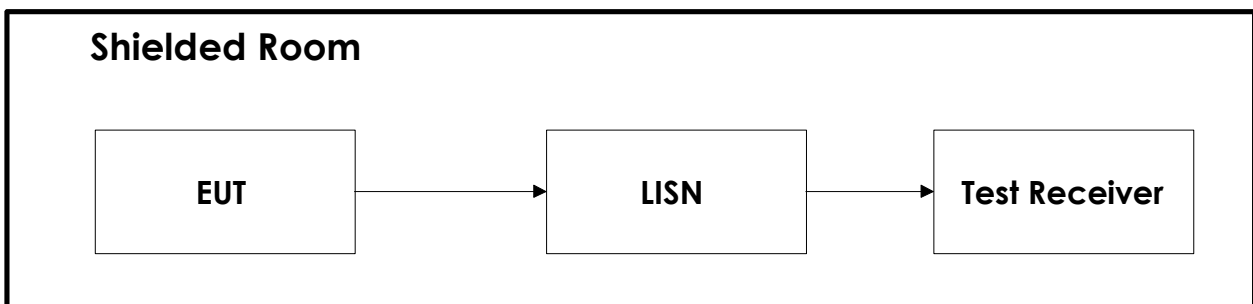

Test equipment: 2, 4, 5, 9, 17

Test Set-Up 2

5.3 Radiated Emissions Test, Fully Anechoic Chamber

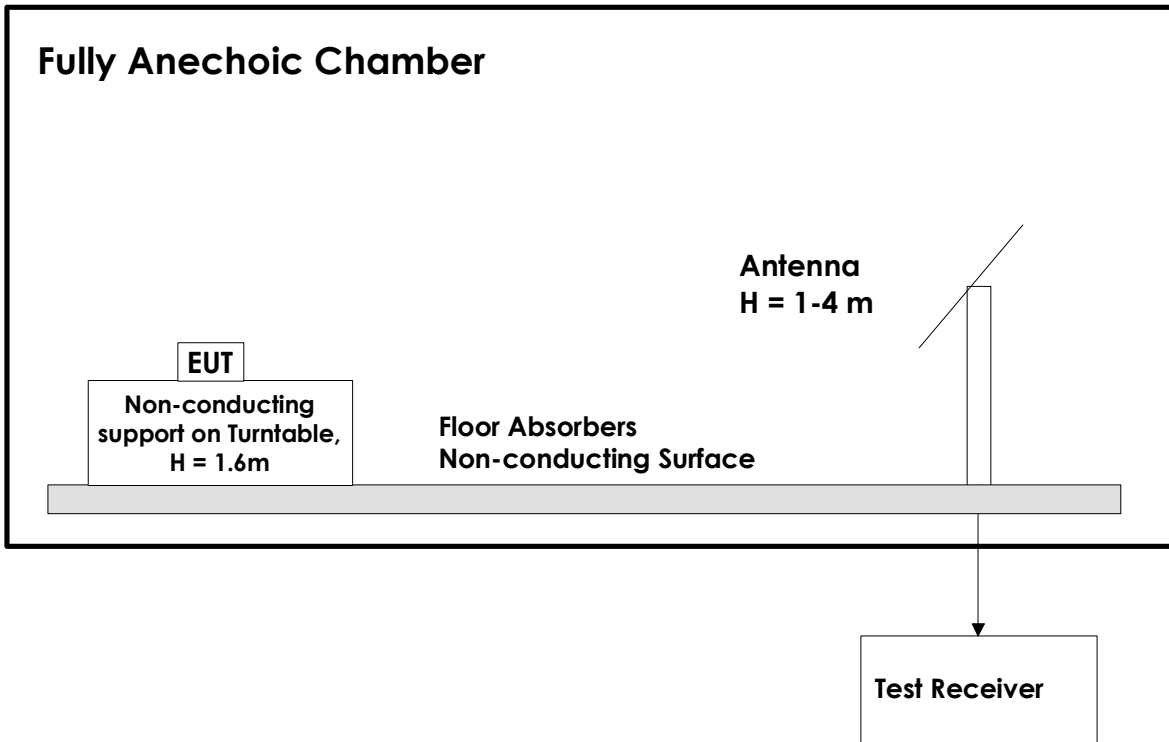

Test equipment: 1, 3, 6, 7, 8, 11, 12, 14

Test Set-Up 3

This test setup is used for measuring radiated output power. The measurements are performed in a 3m Fully Anechoic Chamber with a Spectrum Analyzer and Horn Antenna, a preamplifier may be used after the antenna. The measuring distance is 3m.

6 Test Equipment Used

To facilitate inclusion on each page of the test equipment used for related tests, each item of test equipment and ancillaries are identified (numbered) by the Testhouse.

No.	Model number	Description	Manufacturer	Ref. no.	Cal. date	Cal. Due
1	FSU26	Spectrum Analyzer	Rohde & Schwarz	LR 1504	2011.11.03	2013.11.03
2	ESHS10	Measuring Receiver	Rohde & Schwarz	N-3528	2011-06	2012-06
3	6810.17B	Attenuator	Suhner	LR1212	2010.09.15	2012.09.15
4	ESH3-Z5	Two Line V-Network	Rohde & Schwarz	LR 1076	2011.11.03	2013.11.03
5	80S	Signal Generator	Powertron	LT 502	Cal b4 use	
6	6812B	AC Power Source	Agilent	LR 1515	2011.04.13	2012.04.13
7	JS4	Pre-Amplifier	Miteq	LR 1552	2011.09.28	2012.09.28
8	U2000A	USB Power Sensor	Agilent	LR 1523	2011.03.26	2012.03.26
9	ESH3-Z2	Pulse Limiter	Rohde & Schwarz	N-3932	2010.11.04	2012.11.04
10	ESCI	Measuring Receiver	Rohde & Schwarz	N-4259	2010.11.03	2012.11.03
11	3115	Horn Antenna	EMCO	LR 1226	N/A	
12	3115	Horn Antenna	EMCO	LR 1330	2010.08.05	2013.08.05
13	VLUB	BiLog Antenna	Schwarzbeck	LR 1616	2011.08.29	2014.08.29
14	Model 7200	Signal generator	Gigatronics	LR 1188	2010.11.02	2012.11.02
15	LNA6900	Pre-amplifier	Teseq	LR 1593	2010-11	2011-11
16	HFHZ2-Z2	Loop Antenna	Rohde & Schwarz	LR 285	2010.10.08	2013.10.08
17	Model 87 V	Multimeter	Fluke	LR1600	2010.12.15	2012.12.15