



PCTEST Engineering Laboratory, Inc.

6660-B Dobbin Road • Columbia, MD 21045 • U.S.A.

TEL (410) 290-6652 • FAX (410) 290-6654

<http://www.pctestlab.com>

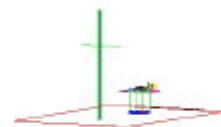

CERTIFICATE OF COMPLIANCE

Matsushita Electric Industrial Co., Ltd.
1006 Oaza Kadoma
Kadoma, Osaka 571 Japan
Attention: Rich Mullen (PSCD, MECA)
K. Nawata (KMECL)

Dates of Tests: April 19-23, 1999
Test Report S/N: 15.990413275.ACJ
Test Site: PCTEST Lab, Columbia, MD

FCC ID

ACJ96NKX-TG2550R

APPLICANT

Matsushita Electric Industrial Co., Ltd.

FCC Rule Part(s): 15.247 Subpart C; ANSI C-63.4 (1992)
Classification: Spread Spectrum Transceiver (DSS)
Method/System: Direct Sequence System (DSS)
Equipment Type: Spread Spectrum Cordless Telephone - Handset
Tx Frequency Range: 904.56 – 925.04 MHz
Rx Frequency Range: 2406.16 – 2477.84 MHz
Max. RF Output Power: 100.7 mW
Trade Name/Model: *Panasonic KX-TG2550B*

This equipment has been shown to be capable of compliance with the applicable technical standards as indicated in the measurement report and was tested in accordance with the measurement procedures specified in ANSI C-63-4.

I attest to the accuracy of data. All measurements reported herein were performed by me or were made under my supervision and are correct to the best of my knowledge and belief. I assume full responsibility for the completeness of these measurements and vouch for the qualifications of all persons taking them.

PCTEST certifies that no party to this application has been denied the FCC benefits pursuant to Section 5301 of the Anti-Drug Abuse Act of 1988, 21 U.S.C. 853(a)

Randy Ortanez
President & Chief Engineer



9 9 0 4 1 3 2 7 5 . A C J

NVLAQ[®]
LAB CODE 100431-0

TABLE OF CONTENTS

SCOPE	1
INTRODUCTION (SITE DESCRIPTION)	2
PRODUCT INFORMATION	3
DESCRIPTION OF TESTS	
A. CONDUCTED EMISSIONS	4
B. RADIATED EMISSIONS	5
C. RESTRICTED BANDS	6
D. ANTENNA REQUIREMENT	7
E. DIRECT SEQUENCE BANDWIDTH	8
F. MAXIMUM PEAK POWER OUTPUT	9
G. POWER DENSITY	10
RADIATED MEASUREMENTS (FUNDAMENTAL & HARMONICS)	11-13
FREQUENCY MEASUREMENTS (SPURIOUS)	14
PROCESSING GAIN	15-16
LIST OF TEST EQUIPMENT	17
RECOMMENDATION/CONCLUSION	18
APPENDIX A - PLOTS OF EMISSION	19
APPENDIX B - PHOTOGRAPHS OF TEST SET-UP	20
APPENDIX C - EUT PHOTOGRAPHS	21

MEASUREMENT REPORT

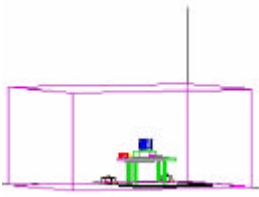

Scope - Measurement and determination of electromagnetic emissions (EME) of radio frequency devices including intentional and/or unintentional radiators for compliance with the technical rules and regulations of the Federal Communications Commission.



§2983(a) General Information

Applicant Name:	Matsushita Electric Industrial Co., Ltd.
Address:	1006 Oaza Kadoma Kadoma, Osaka 571 JAPAN
Attention:	Rich Mullen (PSCD, MECA) K. Nawata (KMEC)

- FCC ID: **ACJ96NKX-TG2550R**
- Equipment Class: Spread Spectrum Transceiver (DSS)
- Equipment Type: Spread Spectrum Cordless Telephone - Handset
- Tx Frequency Range: 904.56 – 925.04 MHz
- Rx Frequency Range: 2406.16 – 2477.84 MHz
- Method/System: Direct Sequence System (DSS)
- Trade Name/Model: **Panasonic KX-TG2550B**
- Max. RF Output Power: 100.7 mW
- Power Supply: 3.6VDC 1150mAh (Ni-MH Battery Pack Model: KX-TCA14)
- Rule Part(s): § 15.247 Subpart C
- Dates of Tests: April 19-23, 1999
- Place of Tests: PCTEST Lab, Columbia, MD U.S.A.
- Test Report S/N: 15.990413275.ACJ

NOTE: The receiver portion was tested, and complied with Part 15B under the verification procedure. The Base Unit is submitted simultaneously with this application under FCC ID: ACJ96NKX-TG2550.



INTRODUCTION

The measurement procedure described in American National Standard for Methods of Measurement of Radio-Noise Emissions from Low-Voltage Electrical and Electronic Equipment in the Range of 9kHz to 40GHz (ANSI C63.4-1992) and FCC Public Notice dated July 12, 1995 entitled "Guidance on Measurement for Direct Sequence Spread Spectrum Systems" were used in the measurement of **PANASONIC Spread Spectrum Cordless Telephone Handset FCC ID: ACJ96NKX-TG2550R**.

These measurement tests were conducted at **PCTEST Engineering Laboratory, Inc.** facility in New Concept Business Park, Guilford Industrial Park, Columbia, Maryland. The site address is 6660-B Dobbin Road, Columbia, MD 21045. The test site is one of the highest points in the Columbia area with an elevation of 390 feet above mean sea level. The site coordinates are 39° 11'15" N latitude and 76° 49'38" W longitude. The facility is 1.5 miles North of the FCC laboratory, and the ambient signal and ambient signal strength are approximately equal to those of the FCC laboratory. There are no FM or TV transmitters within 15 miles of the site. The detailed description of the measurement facility was found to be in compliance with the requirements of § 2.948 according to ANSI C63.4 on October 19, 1992.

PCTEST Location

The map at right shows the location of the PCTEST Lab, its proximity to the FCC Lab, the Columbia vicinity area, the Baltimore-Washington International (BWI) airport, and the city of Baltimore, and the Washington, D.C. area. (see Figure1).

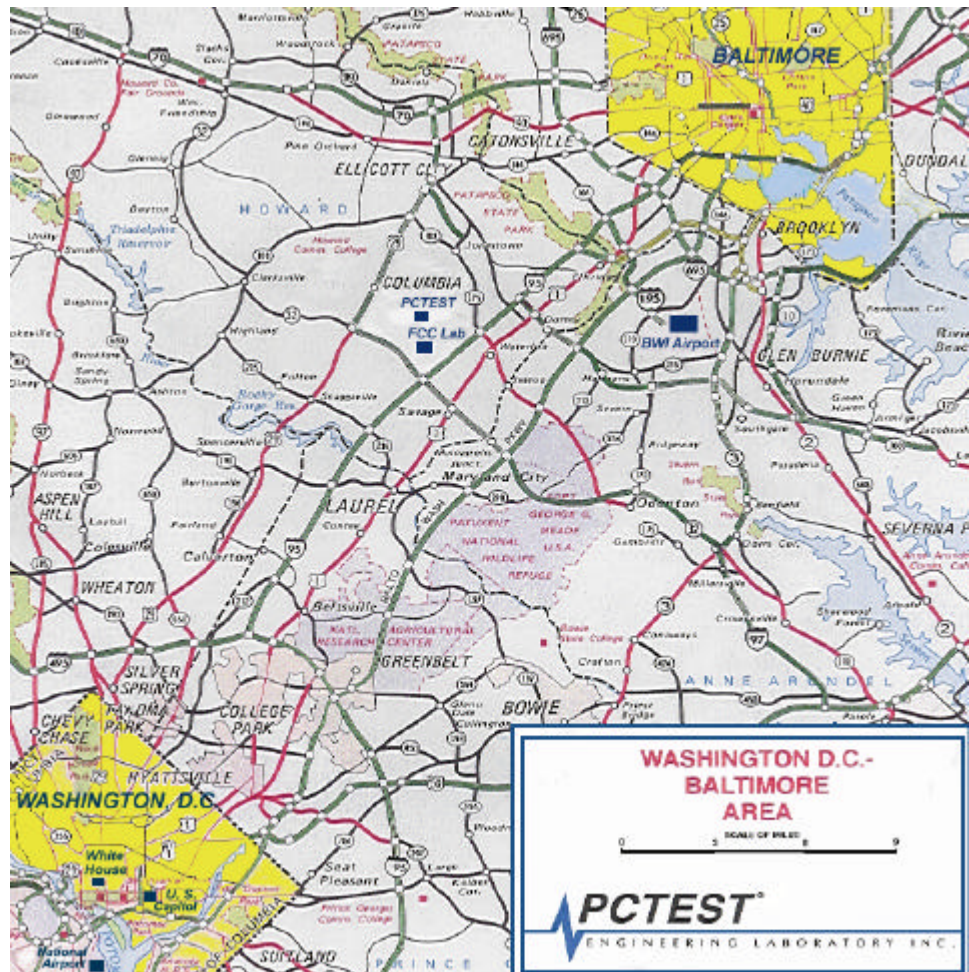

Figure 1. Map of the Greater Baltimore and Metropolitan Washington, D.C. area.

PRODUCT INFORMATION

Equipment Description:

The Equipment under test (EUT) is the **PANASONIC Spread Spectrum Cordless Telephone Handset FCC ID: ACJ96NKX-TG2550R**.

Tx Frequency Range:	904.56 – 925.04 MHz
Rx Frequency Range:	2406.16 – 2477.84 MHz
Channels:	25
Channel Separation:	0.8192 MHz
Spread Spectrum Method:	Direct Sequence
Modulation:	QPSK
Max RF Output Power:	100.7 mW
Antenna:	Omni-directional
Digital Security Codes:	1,000,000
Power Consumption:	3.6VDC 1150mAh (Ni-MH Battery Pack Model: KX-TCA14)

EMI suppression device(s) added and/or modified during testing: None

CH	Rx Freq. (MHz)	Tx Freq. (MHz)	CH	Rx Freq. (MHz)	Tx Freq. (MHz)	CH	Rx Freq. (MHz)	Tx Freq. (MHz)
1	2406.16	904.56	10	2424.80	910.04	19	2459.92	919.92
2	2406.40	904.68	11	2441.52	914.56	20	2460.16	920.04
3	2406.64	904.80	12	2441.76	914.68	21	2476.88	924.56
4	2406.88	904.92	13	2442.00	914.80	22	2477.12	924.68
5	2407.12	905.04	14	2442.24	914.92	23	2477.36	924.80
6	2423.84	909.56	15	2442.48	915.04	24	2477.60	924.92
7	2424.08	909.68	16	2459.20	919.56	25	2477.84	925.04
8	2424.32	909.80	17	2459.44	919.68			
9	2424.56	909.92	18	2459.68	919.80			

DESCRIPTION OF TESTS

Conducted Emissions

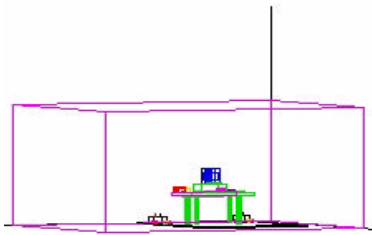

Figure 4. Shielded Enclosure
Line-Conducted Test Facility

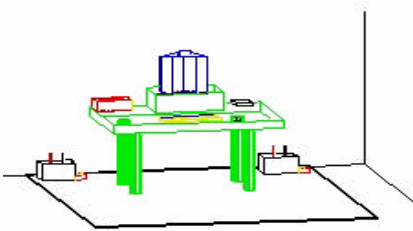

Figure 2. Line Conducted
Emission Test Set-Up

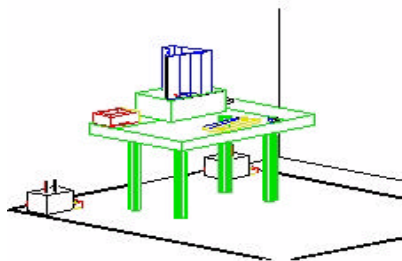

Figure 3. Wooden Table &
Bonded LISNs

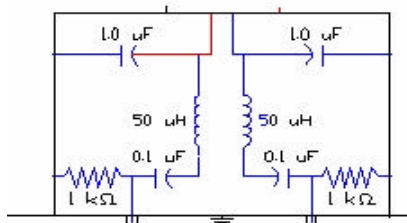

Figure 5. LISN Schematic
Diagram

The line-conducted facility is located inside a 16'x20'x10' shielded enclosure. It is manufactured by Ray Proof Series 81 (see Figure 2). The shielding effectiveness of the shielded room is in accordance with MIL-Std-285 or NSA 65-6. A 1m. x 1.5m. wooden table 80cm. high is placed 40cm. away from the vertical wall and 1.5m away from the side wall of the shielded room (see Figure 3). Solar Electronics and EMCO Model 3725/2 (10kHz-30MHz) $50\Omega/50\mu\text{H}$ Line-Impedance Stabilization Networks (LISNs) are bonded to the shielded room (see Figure 4). The EUT is powered from the Solar LISN and the support equipment is powered from the EMCO LISN. Power to the LISNs are filtered by a high-current high-insertion loss Ray Proof power line filters (100dB 14kHz-10GHz). The purpose of the filter is to attenuate ambient signal interference and this filter is also bonded to the shielded enclosure. All electrical cables are shielded by braided tinned copper zipper tubing with inner diameter of 1/2". If the EUT is a DC-powered device, power will be derived from the source power supply it normally will be powered from and this supply lines will be connected to the Solar LISN. LISN schematic diagram is shown in Figure 5. All interconnecting cables more than 1 meter were shortened by non-inductive bundling (serpentine fashion) to a 1-meter length. Sufficient time for the EUT, support equipment, and test equipment was allowed in order for them to warm up to their normal operating condition. The RF output of the LISN was connected to the spectrum analyzer to determine the frequency producing the maximum EME from the EUT. The spectrum was scanned from 450kHz to 30MHz with 20 msec. sweep time. The frequency producing the maximum level was reexamined using EMI/ Field Intensity Meter and Quasi-Peak adapter. The detector function was set to CISPR quasi-peak mode. The bandwidth of the receiver was set to 10 kHz. The EUT, support equipment, and interconnecting cables were arranged and manipulated to maximize each EME emission. Each emission was maximized by: switching power lines; varying the mode of operation or resolution; clock or data exchange speed; scrolling H pattern to the EUT and/or support equipment, and powering the monitor from the floor mounted outlet box and the computer aux AC outlet, if applicable; whichever determined the worst-case emission. Photographs of the worst-case emission can be seen in the "Test Setup Photographs" attachment. Each EME reported was calibrated using the HP8640B signal generator.

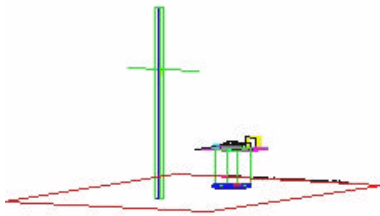

Figure 6. 3-Meter Test Site

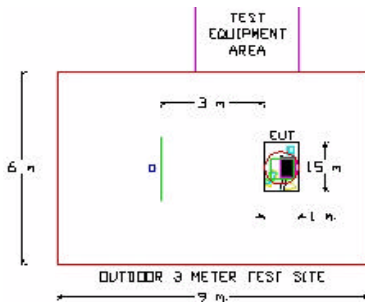

Figure 7. Dimensions of Outdoor Test Site

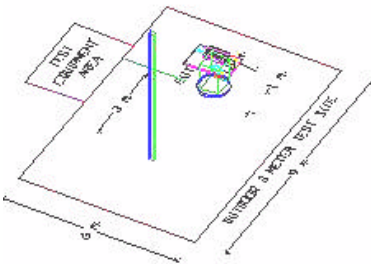

Figure 8. Turntable and System Setup

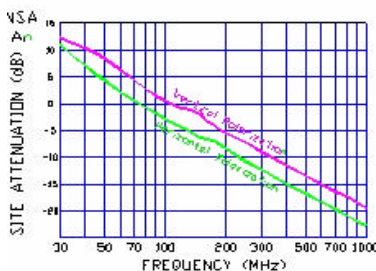

Figure 9. Normalized Site Attenuation Curves (H&V)

DESCRIPTION OF TESTS (CONTINUED)

Radiated Emissions

Preliminary measurements were made indoors at 1 meter using broadband antennas, broadband amplifier, and spectrum analyzer to determine the frequency producing the maximum EME. Appropriate precaution was taken to ensure that all EME from the EUT were maximized and investigated. The system configuration, clock speed, mode of operation or video resolution, turntable azimuth with respect to the antenna were noted for each frequency found. The spectrum was scanned from 30 to 200 MHz using biconical antenna and from 200 to 1000 MHz using log-spiral antenna. Above 1 GHz, linearly polarized double ridge horn antennas were used.

Final measurements were made outdoors at 3-meter test range using Roberts™ Dipole antennas or horn antenna (see Figure 6). The test equipment was placed on a wooden and plastic bench situated on a 1.5 x 2 meter area adjacent to the measurement area (see Figure 7). Sufficient time for the EUT, support equipment, and test equipment was allowed in order for them to warm up to their normal operating condition. Each frequency found during pre-scan measurements was re-examined and investigated using EMI/Field Intensity Meter and Quasi-Peak Adapter. The detector function was set to CISPR quasi-peak mode and the bandwidth of the receiver was set to 100kHz or 1 MHz depending on the frequency or type of signal.

The half-wave dipole antenna was tuned to the frequency found during preliminary radiated measurements. The EUT, support equipment and interconnecting cables were re-configured to the set-up producing the maximum emission for the frequency and were placed on top of a 0.8-meter high non-metallic 1 x 1.5 meter table (see Figure 8). The EUT, support equipment, and interconnecting cables were re-arranged and manipulated to maximize each EME emission. The turntable containing the system was rotated; the antenna height was varied 1 to 4 meters and stopped at the azimuth or height producing the maximum emission. Each emission was maximized by: varying the mode of operation or resolution; clock or data exchange speed; scrolling H pattern to the EUT and/or support equipment, and powering the monitor from the floor mounted outlet box and the computer aux AC outlet, if applicable; and changing the polarity of the antenna, whichever determined the worst-case emission. Photographs of the worst-case emission can be seen in "Test Setup Photographs" Attachment. Each EME reported was calibrated using the HP8640B signal generator. The Theoretical Normalized Site Attenuation Curves for both horizontal and vertical polarization are shown in Figure 9.

§ 15.205 RESTRICTED BANDS

Special attention is made for the EUT's harmonic and spurious radiated emission in the restricted bands of operation. The EUT was tested from 9kHz and up to the tenth harmonic of the fundamental frequency of the transmitter using CISPR quasi peak detector below 1GHz. Above 1 GHz, average measurements was used using RBW 1 MHz – VBW 10Hz and linearly polarized horn antennas. In addition, peak measurements were taken to ensure that the peak levels are not more than 20dB above the average limit. All out of band emissions, other than those created by the spreading sequency, data sequence, and the carrier modulation must not exceed the limits show in Table 2 per 15.209.

Frequency (MHz)	F/S (UV/m)	Meas. Dist. (Meters)
0.009-0.490	2400/F (kHz)	300
0.490-1.705	24000/F (kHz)	30
1.705-30.00	30	30
30.0-88.0	100	3
88.0-216.0	150	3
216.0-960.0	200	3
Above 960	500	3

Tab. 2. Radiated Emission Limits Per 15.209

Test Equipment

HP 8566B	Spectrum Analyzer 100Hz-22GHz
HP83017A	Microwave Amplifier 40dB Gain (0.5 – 26.5 GHz)
HP 3784A	Digital Transmission Analyzer
EMCO 3115	Horn Antenna (1 – 18GHz)
HP 8495A	20dB Attenuator (DC-40GHz) 0-70dB
HP 8493B	10dB Attenuator
MicroCoax Cables	Low Loss Microwave Cables (1-26.5 GHz)
CDI Dipoles	Dipole Antennas (30 – 1000 MHz)

§ 15.203 ANTENNA REQUIREMENT

An intentional radiator antenna shall be designed to ensure that no antenna other than that furnished by the applicant can be used with the device. The use of a permanently attached antenna or of an antenna that uses a unique coupling to the intentional radiator shall be considered sufficient to comply with this requirement.

Handset

The **Panasonic TX-TG2550B** Handset complies with the requirement of §15.203. The antenna is a **permanently attached Antenna**.

CONCLUSION

There are no provisions for connection to an external antenna. The Handset meets the Antenna Requirements of §15.203.

§15.247(A)(2) – DIRECT SEQUENCE BANDWIDTH

Res. Bandwidth = 100 kHz (5dB/div)
Vid. BW = 100 kHz
Span = 10 MHz
Ref. Level - 36 dBm
Sweep 20ms
Attenuator 6 dB ext. pad
6dB Bandwidth –Mkr Delta (6dB down from peak)
(see attached spectrum plots)

FREQ (MHz)	Channel	6dB Bandwidth (MHz)
904.52	1	1.45
914.56	11	1.45
925.04	25	1.45

Table 3. 6dB Bandwidth measurements

Minimum Standard – 6dB bandwidth for direct sequence systems must be at least 500Hz (0.5 MHz).

REMARKS:

PASS

§15.247(B) MAXIMUM PEAK OUTPUT POWER

Res. Bandwidth = 3 MHz (5dB/div)
 Vid. BW = 3 MHz
 Span = 10 MHz
 Ref. Level - 20.0 dBm
 Sweep 20ms
 Attenuator 6 dB ext. pad

FREQ (MHz)	Channel	Power Output (dBm)	Power Output (mW)
904.52	1	20.0	100.7
914.56	11	19.1	81.4
925.04	25	18.4	68.4

Table 4. Output Power Measurements

Minimum Standard – The maximum peak output power of the transmitter shall not exceed 1 watt.

The EUT is placed 3m. away from the receiving antenna and the EIRP is calculated using the formula:

$$\text{EIRP (dBm)} = 10 \text{ Log } 10 \left(\left(\frac{r(\text{mV/m})}{1 \times 10^6} \right)^2 / 30.0 / 1 \times 10^{-3} \right)$$

$$\text{EIRP (dBm)} = 10 \text{ Log } 10 \left[\left(3 \times \text{FS} / 1 \times 10^6 \right)^2 / (30.0) \times 1000 \right]$$

$$\text{EIRP (dBm)} = \left\{ \left(3 \times \text{FS} / 1 \times 10^6 \right)^2 / 30.0 \right\}$$

REMARKS:

PASS

§15.247(D) POWER DENSITY

Res. Bandwidth = 3 kHz (5dB/div)
Vid. BW = 3 kHz
Span = 300 kHz (3.0 MHz)
Ref. Level -36dBm
Sweep 1000 sec.

FREQ (MHz)	Channel	Power Density (dBm)
904.52	1	- 5.42
914.56	11	- 5.62
925.04	25	- 6.03

Table 5. Output Power Density Data.

Minimum Standard – The transmitted power density averaged over any 1 second interval shall not be greater than 8dBm in any 3kHz bandwidth within these bands.

The EUT is placed 3m. away from the receiving antenna and the EIRP is calculated using the formula:

$$\text{EIRP (dBm)} = 10 \text{ Log } 10 \left(\left(\frac{r(\text{mV/m})}{1 \times 10^6} \right)^2 / 30.0 / 1 \times 10^{-3} \right)$$

$$\text{EIRP (dBm)} = 10 \text{ Log } 10 \left[\left(\frac{3 \times \text{FS}}{1 \times 10^6} \right)^2 / (30.0) \times 1000 \right]$$

$$\text{EIRP (dBm)} = \left\{ \left(\frac{3 \times \text{FS}}{1 \times 10^6} \right)^2 / 30.0 \right\}$$

REMARKS:

PASS

RADIATED MEASUREMENTS (FUNDAMENTAL & HARMONICS)

Operating Frequency: 904.56 MHz
 Distance of Measurements: 3 meters
 Channel: 1

FREQ. (MHz)	Level* (dBm)	AFCL** (dB)	POL (H/V)	DET QP/AVG	F/S (μ V/m)	F/S (dB μ V/m)	Margin*** (dB)
904.56	- 24.4	32.7	V	Peak	579428.7	115.0	- 10.0
1809.12	- 67.5	30.9	V	Peak	3311.31	70.4	- 24.6
2713.63*	- 113.2	34.2	V	Peak	25.11	28.0	- 26.0
3618.24*	- 114.0	37.0	V	Peak	31.60	30.0	- 24.0
4522.8*	- 125.0	38.9	V	Peak	11.09	20.9	- 33.1
5427.36*	< -120	39.0					

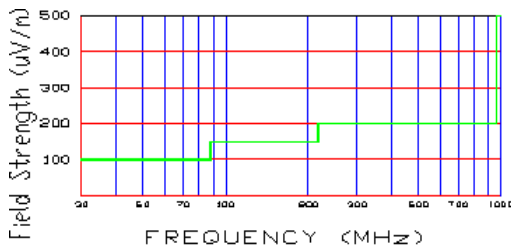

Figure 10. Restricted band harmonics and spurious limits.

NOTES:

1. All harmonics in the restricted bands specified in §15.205 are below the limit shown in table 2. (note: * Restricted Band)
2. All harmonics/spurs are at least 20 dB below the highest emission in the authorized band using RBW = 100kHz
3. Average Measurements > 1GHz using RBW = 1 MHz VBW = 10 Hz
4. The peak emissions above 1 GHz are not more than 20 dB above the average limit.
5. The antenna is manipulated through typical positions, polarity and length during the tests.
6. The EUT is supplied with nominal AC voltage or/and a new/fully recharged battery.
7. The spectrum is measured from 9kHz to the 10th harmonic and the worst-case emissions are reported.
8. < - 120 are below the analyzer floor level.
9. ** Note: Unit is dBC.
10. Above 1 GHz, limit is 500 uV/m (54dBu/m)

Operating Frequency: 914.56 MHz
 Distance of Measurements: 3 meters
 Channel: 11

FREQ. (MHz)	Level* (dBm)	AFCL** (dB)	POL (H/V)	DET QP/AVG	F/S (μ V/m)	F/S (dB μ V/m)	Margin*** (dB)
914.56	- 25.4	32.8	V	Peak	527229.9	114.4	- 10.8
1829.12	- 67.0	31.0	V	Peak	3548.1	71.0	- 23.4
2743.68*	- 113.0	34.3	V	Peak	26.0	28.3	- 25.7
3658.24*	- 113.8	37.1	V	Peak	32.8	30.3	- 23.7
4572.80*	- 125.0	39.0	V	Peak	11.2	21.0	- 33.0
5487.36	< - 120						

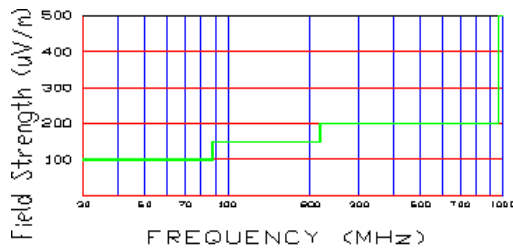

Figure 10. Restricted band harmonics and spurious limits.

NOTES:

1. All harmonics in the restricted bands specified in §15.205 are below the limit shown in table 2. (note: * Restricted Band)
2. All harmonics/spurs are at least 20 dB below the highest emission in the authorized band using RBW = 100kHz
3. Average Measurements > 1GHz using RBW = 1 MHz VBW = 10 Hz
4. The peak emissions above 1 GHz are not more than 20 dB above the average limit.
5. The antenna is manipulated through typical positions, polarity and length during the tests.
6. The EUT is supplied with nominal AC voltage or/and a new/fully recharged battery.
7. The spectrum is measured from 9kHz to the 10th harmonic and the worst-case emissions are reported.
8. < - 120 are below the analyzer floor level.
9. ** Note: Unit is dBC.
10. Above 1 GHz, limit is 500 uV/m (54dBu/m)

Operating Frequency: 925.04 MHz
 Distance of Measurements: 3 meters
 Channel: 25

FREQ. (MHz)	Level* (dBm)	AFCL** (dB)	POL (H/V)	DET QP/AVG	F/S (μ V/m)	F/S (dB μ V/m)	Margin*** (dB)
924.02	- 26.3	32.9	V	Peak	477529.3	113.6	- 11.7
1850.08	- 68.0	31.1	V	Peak	3198.90	70.1	- 23.5
2774.10*	- 114.0	34.3	V	Peak	23.17	27.3	- 26.7
3698.12*	- 115.0	37.2	V	Peak	28.80	29.2	- 24.8
4622.14*	- 126.0	39.1	V	Peak	10.11	20.0	- 34.0
5546.16	< - 120						

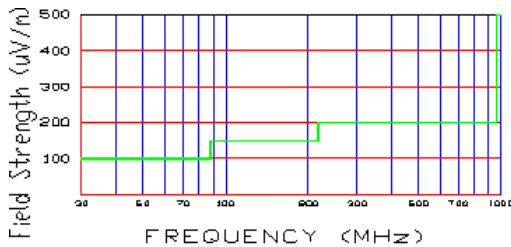

Figure 10. Restricted band harmonics and spurious limits.

NOTES:

1. All harmonics in the restricted bands specified in §15.205 are below the limit shown in table 2. (note: * Restricted Band)
2. All harmonics/spurs are at least 20 dB below the highest emission in the authorized band using RBW = 100kHz
3. Average Measurements > 1GHz using RBW = 1 MHz VBW = 10 Hz
4. The peak emissions above 1 GHz are not more than 20 dB above the average limit.
5. The antenna is manipulated through typical positions, polarity and length during the tests.
6. The EUT is supplied with nominal AC voltage or/and a new/fully recharged battery.
7. The spectrum is measured from 9kHz to the 10th harmonic and the worst-case emissions are reported.
8. < - 120 are below the analyzer floor level.
9. ** Note: Unit is dBC.
10. Above 1 GHz, limit is 500 uV/m (54dBu/m)

RADIATED MEASUREMENTS (SPURIOUS)

Operating Frequency: 904.56 – 925.04 MHz

Distance of Measurements: 3 meters

Channel: 1, 11, 25

FREQ. (MHz)	Level* (dBm)	AFCL** (dB)	POL (H/V)	F/S (μ V/m)	DET QP/AVG	Margin*** (dB)
41.0	- 80.0	1.4	H	26.3	QP	- 11.6
51.2	- 80.5	3.3	H	31.0	QP	- 10.0
81.9	- 82.0	7.7	V	43.2	QP	- 7.3
122.9	- 83.0	11.7	H	61.0	QP	- 7.8
163.8	- 86.2	14.5	V	58.4	QP	- 8.2
998.2	- 98.5	34.0	V	133.0	QP	- 3.5

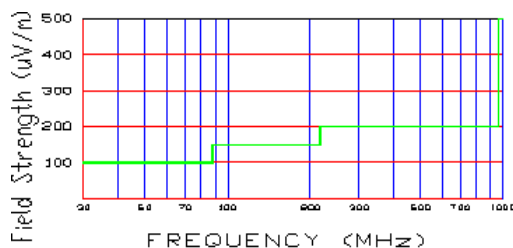

Figure 10. Restricted band harmonics and spurious limits.

NOTES:

1. All emissions were investigated and the worst case emissions are reported.

2. For hand-held devices, the EUT is rotated through three orthogonal axis to determine which configuration produces the maximum emissions.

3. The EUT is supplied with the nominal AC voltage or/and a new/fully recharged battery.

4. The EUT was tested up to the 10th harmonic (9.3 GHz) and no significant emission was found.

5. Above 1 GHz limit is 500 μ V/m (54dBu/m)

§15.247(E) PROCESSING GAIN (FROM PANASONIC)

KX-TG2550B Processing Gain Test Results

Kyushu Matsushita Electric Co.,Ltd

Personal Telecom Division Engineering Department
 H.Hamada

Δf (kHz)	Portable Unit	Base Unit
	D/U Ratio(dB)	D/U Ratio(dB)
1200	24.17	27.10
1150	20.01	26.00
1100	19.19	24.40
1050	17.14	23.40
1000	15.87	20.60
950	14.11	19.00
900	13.91	17.90
850	13.83	15.90
800	12.74	14.00
750	11.00	13.50
700	10.55	12.90
650	10.35	12.20
600	10.16	11.90
550	10.45	11.80
500	10.45	11.80
450	9.86	11.90
400	9.87	10.00
350	9.08	12.40
300	10.16	10.56
250	10.00	11.06
200	9.86	9.66
150	10.00	9.55
100	9.77	9.50
50	9.77	9.00
0	8.63	9.20
-50	10.25	8.50
-100	9.86	10.00
-150	9.86	8.30
-200	9.86	9.70
-250	10.35	11.90
-300	9.86	10.50
-350	9.86	11.40
-400	10.06	11.50
-450	9.86	11.50
-500	10.00	12.50
-550	10.35	11.40
-600	10.35	12.10
-650	11.00	12.10
-700	12.68	12.70
-750	13.33	13.00
-800	14.21	14.20
-850	15.20	15.50
-900	16.16	16.10
-950	16.50	18.70
-1000	17.08	19.90
-1050	18.30	21.80
-1100	20.36	24.60
-1150	21.94	26.90
-1200	25.74	31.00

D/U Ratio = (Desire Signal) / (Undesired Signal) Ratio

 worst 20% points
 These points are excluded.

OMj Jamming Margin

Mj(J/S ratio)	
Portable	9.86dB
Base	10.50dB

*Mj level is worst value after exclude worst 20% points.

OProcess Gain

$$G_p = (S/N)_o + M_j + L_{sys}$$

(S/N)_o = 3.0dB

L_{sys} = 2.0dB

M_j: compare above table.

Gp (Process Gain)

Portable	14.9dB	(=9.9+3+2)
Base	15.5dB	(=10.5+3+2)

OMeasurement Equipment

Signal Generator

- ① HEWLETT PACKERD ESG-D3000A
- ② HEWLETT PACKERD ESG-D3000A

Audio Analyzer

HEWLETT PACKERD 8903B
 (Option:CCITT Filter)

Four port junction Pad

Anritsu MA1612A

50 ohm terminator

HWELETT PACKERD 908A

§15.247(E) PROCESSING GAIN (CONTINUED)

- ① Desired Signal Signal Generator 1
 Undesired Signal Signal Generator 2

Initially Signal generator 2 should be switched off.
 The Signal generator 1 should be at the standard conditions.
 Then the SINAD ratio is had result as X dB.

- ② The signal generator 2 is switched on.
 RF output level of signal generator 2 is increased to 12dB.
 In This time,
 SG1 output level is (-80dBm)+(4 port junction pad loss), and
 SG2 output level is Y dBm.

- ③ Jamming Margin = $(Y \text{ dBm}) - [(-80 \text{ dBm}) + (4 \text{ port junction pad loss})]$
 Setting level on SG1

Regarding processing gain, this device uses analog modulation for baseband signal and does not convert voice signal to digital signal. The analog voice signal is modulated to a FM signal and processed to produce a spread spectrum signal. Since the processed signal is analog and not digital, this unit does not have BER. Instead, it uses SINAD, which means a distortion of analog signal. Since C/N of the 2nd IF signal, which is input to FM de-modulator at SINAD = 12 dB is 3 dB, this device uses $(S/N)_0 = 3 \text{ dB}$.

KX-TG2550 Process gain

$$G_p = (C/N)_0 + M_j + L_{\text{sys}}$$

G_p = KX-TG210 Process Gain

$(S/N)_0$ = S/N ratio for keeping 12dB SINAD

The Base band signals of this model are analog.

$(S/N)_0$ is 3dB on this system.

M_j = J/S ratio (CW Jamming margin method)

L_{sys} = system loss ($\leq 2.0 \text{ dB}$)

Method of measurement CW Jamming margin

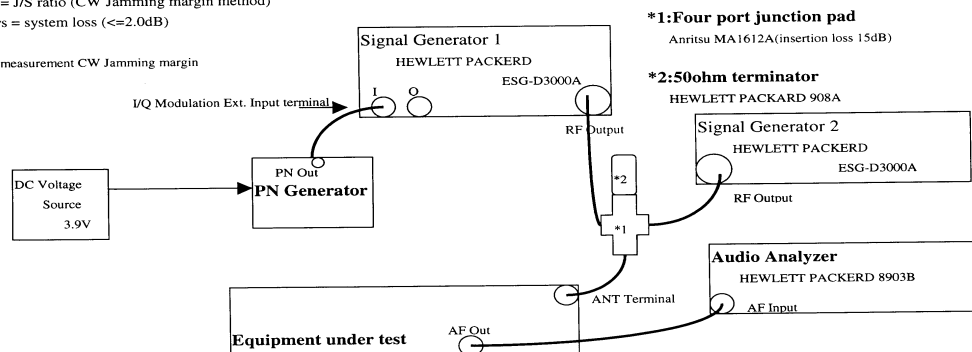

TEST EQUIPMENT

Type	Model	Cal. Due Date	S/N
Microwave Spectrum Analyzer	HP 8566B (100Hz-22GHz)	08/15/99	3638A08713
Microwave Spectrum Analyzer	HP 8566B (100Hz-22GHz)	04/17/00	2542A11898
Spectrum Analyzer/Tracking Gen.	HP 8591A (100Hz-1.8GHz)	08/10/99	3144A02458
Signal Generator*	HP 8640B (500Hz-1GHz)	08/09/99	2232A19558
Signal Generator*	HP 8640B (500Hz-1GHz)	08/09/99	1851A09816
Signal Generator*	Rohde & Schwarz (0.1-1000MHz)	09/11/99	894215/012
Ailtech/Eaton Receiver	NM 37/57A-SL (30-1000MHz)	04/12/00	0792-03271
Ailtech/Eaton Receiver	NM 37/57A (30-1000MHz)	03/11/00	0805-03334
Ailtech/Eaton Receiver	NM17/27A (0.1-32MHz)	09/17/99	0608-03241
Quasi-Peak Adapter	HP 85650A	08/15/99	2043A00301
Ailtech/Eaton Adapter	CCA-7 CISPR/ANSI QP Adapter	03/11/00	0194-04082
RG58 Coax Test Cable	No. 167		n/a
Harmonic/Flicker Test System	HP 6841A (IEC 555-2/3)		3531A00115
Broadband Amplifier (2)	HP 8447D		1145A00470, 1937A03348
Broadband Amplifier	HP 8447F		2443A03784
Transient Limiter	HP 11947A (9kHz-200MHz)		2820A00300
Horn Antenna	EMCO Model 3115 (1-18GHz)		9704-5182
Horn Antenna	EMCO Model 3115 (1-18GHz)		9205-3874
Horn Antenna	EMCO Model 3116 (18-40GHz)		9203-2178
Biconical Antenna (4)	Eaton 94455/Eaton 94455-1/Singer 94455-1/Compliance Design 1295, 1332, 0355		
Log-Spiral Antenna (3)	Ailtech/Eaton 93490-1		0608, 1103, 1104
Roberts Dipoles	Compliance Design (1 set)		
Ailtech Dipoles	DM-105A (1 set)		33448-111
EMCO LISN	3816/2		1079
EMCO LISN	3816/2		1077
EMCO LISN	3725/2		2009
Microwave Preamplifier 40dB Gain	HP 83017A (0.5-26.5GHz)		3123A00181
Microwave Cables	MicroCoax (1.0-26.5GHz)		
Ailtech/Eaton Receiver	NM37/57A-SL		0792-03271
Spectrum Analyzer	HP 8594A		3051A00187
Spectrum Analyzer (2)	HP 8591A		3034A01395, 3108A02053
Modulation Analyzer	HP 8901A		2432A03467
NTSC Pattern Generator	Leader 408		0377433
Noise Figure Meter	HP 8970B		3106A02189
Noise Figure Meter	Ailtech 7510		TE31700
Noise Generator	Ailtech 7010		1473
Microwave Survey Meter	Holiday Model 1501 (2.450GHz)		80931
Digital Thermometer	Extech Instruments 421305		426966
Attenuator	HP 8495A (0-70dB) DC-4GHz		
Bi-Directional Coax Coupler	Narda 3020A (50-1000MHz)		
Shielded Screen Room	RF Lindgren Model 26-2/2-0		6710 (PCT270)
Shielded Semi-Anechoic Chamber	Ray Proof Model S81		R2437 (PCT278)
Environmental Chamber	Associated Systems Model 1025 (Temperature/Humidity)		PCT285

* Calibration traceable to the National Institute of Standards and Technology (NIST).

RECOMMENDATION / CONCLUSION

The data collected shows that the **Panasonic Spread Spectrum Cordless Telephone Handset FCC ID: ACJ96NKX-TG2550R** complies with Part 15C of the FCC Rules.

ATTACHMENT A – PLOTS OF EMISSION

ATTACHMENT B – TEST PHOTOGRAPHS

APPENDIX C – EUT PHOTOGRAPHS
