

ENGINEERING TEST REPORT



2.4GHz FHSS Cell Station
Model No.: KX-T0151, KX-TDA0151 AND KX-TDA0152

FCC ID: ACJ96NKX-TDA0152

Applicant:

Panasonic Corporation of North America
One Panasonic Way, Panazip 4B-8
Secaucus, NJ
USA 07094

In Accordance With

FEDERAL COMMUNICATIONS COMMISSION (FCC)
PART 15, SUBPART C, SECTION 15.247
Frequency Hopping Operating in the Frequency Band 2401.056-2479.680 MHz

UltraTech's File No.: PAN-078F15C247-B

This Test report is Issued under the Authority of
Tri M. Luu, Professional Engineer,
Vice President of Engineering
UltraTech Group of Labs



Date: May 24, 2007

Report Prepared by: JaeWook Choi

Tested by: Hung Trinh, RFI Technologist

Issued Date: May 24, 2007

Test Dates: March 29, April 03, April 10 ~ 12,
April 23 ~ 24, April 26, April 30, May 01, 2007

- *The results in this Test Report apply only to the sample(s) tested, and the sample tested is randomly selected.*
- *This report must not be used by the client to claim product endorsement by NVLAP or any agency of the US Government.*

UltraTech

3000 Bristol Circle, Oakville, Ontario, Canada, L6H 6G4
Tel.: (905) 829-1570 Fax.: (905) 829-8050
Website: www.ultratech-labs.com Email: vic@ultratech-labs.com, Email: tri.luu@sympatico.ca



TABLE OF CONTENTS

EXHIBIT 1. INTRODUCTION	1
1.1. SCOPE	1
1.2. RELATED SUBMITTAL(S)/GRANT(S)	1
1.3. NORMATIVE REFERENCES	1
EXHIBIT 2. PERFORMANCE ASSESSMENT	2
2.1. CLIENT INFORMATION	2
2.2. EQUIPMENT UNDER TEST (EUT) INFORMATION	2
2.3. EUT'S TECHNICAL SPECIFICATIONS	3
2.4. LIST OF EUT'S PORTS	3
2.5. ANCILLARY EQUIPMENT	3
2.6. TEST SETUP BLOCK DIAGRAM	3
EXHIBIT 3. EUT OPERATING CONDITIONS AND CONFIGURATIONS DURING TESTS	4
3.1. CLIMATE TEST CONDITIONS	4
3.2. OPERATIONAL TEST CONDITIONS & ARRANGEMENT FOR TESTS	4
EXHIBIT 4. SUMMARY OF TEST RESULTS	5
4.1. LOCATION OF TESTS	5
4.2. APPLICABILITY & SUMMARY OF EMC EMISSION TEST RESULTS	5
4.3. MODIFICATIONS INCORPORATED IN THE EUT FOR COMPLIANCE PURPOSES	5
EXHIBIT 5. MEASUREMENTS, EXAMINATIONS & TEST DATA FOR EMC EMISSIONS	6
5.1. TEST PROCEDURES	6
5.2. MEASUREMENT UNCERTAINTIES	6
5.3. MEASUREMENT EQUIPMENT USED	6
5.4. COMPLIANCE WITH FCC PART 15 – GENERAL TECHNICAL REQUIREMENTS	6
5.5. AC POWER LINE CONDUCTED EMISSIONS [§15.207(A)]	8
5.5.1. <i>Limit</i>	8
5.5.2. <i>Method of Measurements</i>	8
5.5.3. <i>Test Arrangement</i>	8
5.5.4. <i>Test Equipment List</i>	8
5.5.5. <i>Test Data</i>	9
5.6. 20 DB BANDWIDTH [§15.247(A)(1) & §15.247(A)(1)(III)]	11
5.6.1. <i>Limits</i>	11
5.6.2. <i>Method of Measurements</i>	11
5.6.3. <i>Test Arrangement</i>	11
5.6.4. <i>Test Equipment List</i>	11
5.6.5. <i>Test Data</i>	12
5.6.5.1. KX-T0151, KX-TDA0151	12
5.6.5.2. KX-TDA0152	26
5.7. PEAK OUTPUT POWER [§§ 15.247(B)(1)]	40
5.7.1. <i>Limits</i>	40
5.7.2. <i>Method of Measurements</i>	40
5.7.3. <i>Test Equipment List</i>	40
5.7.4. <i>Test Arrangement</i>	40
5.7.5. <i>Test Data</i>	40
5.7.5.1. KX-T0151, KX-TDA0151	40
5.7.5.2. KX-TDA0152	44
5.8. TRANSMITTER BAND-EDGE & SPURIO CONDUCTED EMISSIONS [§ 15.247(D)]	47

ULTRATECH GROUP OF LABS

3000 Bristol Circle, Oakville, Ontario, Canada L6H 6G4
Tel. #: 905-829-1570, Fax. #: 905-829-8050 Email: vic@ultratech-labs.com, Website: <http://www.ultratech-labs.com>

File #: PAN-078F15C247-B
May 24, 2007

5.8.1.	Limits	47
5.8.2.	Method of Measurements	48
5.8.3.	Test Arrangement	48
5.8.4.	Test Equipment List	48
5.8.5.	Test Data.....	49
5.8.5.1.	Band-Edge RF Conducted Emissions	49
5.8.5.1.1.	KX-T0151, KX-TDA0151	49
5.8.5.1.2.	KX-TDA0152	53
5.8.5.2.	Spurious RF Conducted Emissions.....	57
5.8.5.2.1.	KX-T0151, KX-TDA0151	57
5.8.5.2.2.	KX-TDA0152	69
5.9.	SPURIOUS RADIATED EMISSIONS @ 3 METERS [§ 15.247(D), §15.209 & §15.205].....	81
5.9.1.	Limits	81
5.9.2.	Method of Measurements	82
5.9.3.	Test Arrangement	82
5.9.4.	Test Equipment List	82
5.9.5.	Test Data.....	83
5.9.5.1.	Band-edge Radiated Emissions	83
5.9.5.1.1.	KX-T0151, KX-TDA0151	83
5.9.5.1.2.	KX-TDA0152	95
5.9.5.2.	Transmitter Radiated Spurious Emissions.....	107
5.9.5.2.1.	KX-T0151, KX-TDA0151	107
5.9.5.2.2.	KX-TDA0152	108
5.10.	RF EXPOSURE REQUIRMENTS [§§ 15.247(i), 1.1310 & 2.1091]	109
5.10.1.	Limit	109
5.10.2.	Method of Measurements.....	109
5.10.3.	Test Data	111
5.10.3.1.	KX-T0151, KX-TDA0151	111
5.10.3.2.	KX-TDA0152	112
EXHIBIT 6.	MEASUREMENT UNCERTAINTY	113
6.1.	LINE CONDUCTED EMISSION MEASUREMENT UNCERTAINTY	113
6.2.	RADIATED EMISSION MEASUREMENT UNCERTAINTY	114

EXHIBIT 1. INTRODUCTION

1.1. SCOPE

Reference:	Part 15, Subpart C, Section 15.247
Title:	Telecommunication - Code of Federal Regulations, CFR 47, Part 15
Purpose of Test:	To gain FCC Equipment Authorization for Frequency Hopping Operating in the Frequency Band 2401.056-2479.680 MHz.
Test Procedures:	Both conducted and radiated emissions measurements were conducted in accordance with American National Standards Institute ANSI C63.4 - American National Standard for Methods of Measurement of Radio-Noise Emissions from Low-Voltage Electrical and Electronic Equipment in the Range of 9 kHz to 40 GHz.
Environmental Classification:	Commercial

1.2. RELATED SUBMITTAL(S)/GRANT(S)

None.

1.3. NORMATIVE REFERENCES

Publication	Year	Title
FCC 47CFR Parts 0-19	2006	Code of Federal Regulations, Title 47 – Telecommunication
ANSI C63.4	2003	American National Standard for Methods of Measurement of Radio-Noise Emissions from Low-Voltage Electrical and Electronic Equipment in the Range of 9 kHz to 40 GHz
CISPR 22 +A1 EN 55022	2003-04-10 2004-10-14 2003	Limits and Methods of Measurements of Radio Disturbance Characteristics of Information Technology Equipment
CISPR 16-1-1	2003	Specification for radio disturbance and immunity measuring apparatus and methods. Part 1-1: Measuring Apparatus
CISPR 16-2-1	2003	Specification for radio disturbance and immunity measuring apparatus and methods. Part 2-1: Conducted disturbance measurement
CISPR 16-2-3	2003	Specification for radio disturbance and immunity measuring apparatus and methods. Part 2-3: Radiated disturbance measurement
FCC Public Notice DA 00-705	2000	Filing and Measurement Guidelines for Frequency Hopping Spread Spectrum Systems
KDB Publication No. 558074	2005	Guidance on Measurements for Digital Transmission Systems (47 CFR 15.247)

ULTRATECH GROUP OF LABS

3000 Bristol Circle, Oakville, Ontario, Canada L6H 6G4
 Tel. #: 905-829-1570, Fax. #: 905-829-8050 Email: vic@ultratech-labs.com, Website: <http://www.ultratech-labs.com>

File #: PAN-078F15C247-B
 May 24, 2007

All test results contained in this engineering test report are traceable to National Institute of Standards and Technology (NIST)

EXHIBIT 2. PERFORMANCE ASSESSMENT

2.1. CLIENT INFORMATION

APPLICANT:	
Name:	Panasonic Corporation of North America
Address:	One Panasonic Way, Panazip 4B-8 Secaucus, NJ USA 07094
Contact Person:	Mr. Richard Mullen Phone #: +1 201 348 7758 Email Address: mullenr@us.panasonic.com

MANUFACTURER:	
Name and Address #1:	Panasonic Communications Co., Ltd. Kumamoto Factory 1080, Takano, Nagomi-machi, Tamana-gun, Kumamoto, 865-0193, Japan
Name and Address #2:	SUGA ELECTRON (M) SDN.BHD. No.2&3, Jalan Teknologi 1, Kawasan Perindustrian Tangkak, 84900 Tangkak, Johor, Malaysia
Name and Address #3:	Panasonic Communications Vietnam Co., Ltd. Lot J1, Thang Long Industrial Park, Dong Anh district, Hanoi, Vietnam
Contact Person:	Mr. Edmond Leung c/o Panasonic Canada Phone #: 905-238-2225 Fax #: 905-238-2226 Email Address: eluong@ca.panasonic.com

2.2. EQUIPMENT UNDER TEST (EUT) INFORMATION

The following information (with the exception of the Date of Receipt) has been supplied by the applicant.

Brand Name:	Panasonic
Product Name:	2.4GHz FHSS Cell Station
Model Name or Number:	KX-T0151, KX-TDA0151 AND KX-TDA0152
Serial Number:	Preproduction
Type of Equipment:	FHSS
Input Power Supply Type:	40V DC (supplied by Panasonic PBX)
Primary User Functions of EUT:	Wireless network communication

ULTRATECH GROUP OF LABS

3000 Bristol Circle, Oakville, Ontario, Canada L6H 6G4
Tel. #: 905-829-1570, Fax. #: 905-829-8050 Email: vic@ultratech-labs.com, Website: <http://www.ultratech-labs.com>

File #: PAN-078F15C247-B
May 24, 2007

All test results contained in this engineering test report are traceable to National Institute of Standards and Technology (NIST)

2.3. EUT’S TECHNICAL SPECIFICATIONS

TRANSMITTER	
Equipment Type:	Base Station
Intended Operating Environment:	Commercial
Power Supply Requirement:	40V DC supplied by Panasonic PBX
RF Output Power Rating:	22.70 dBm peak
Operating Frequency Range:	2401.056-2479.680 MHz
RF Output Impedance:	50 Ω
Channel Spacing:	864 KHz
Duty Cycle:	7.8%
Modulation Type:	GFSK
Antenna Connector Type:	Integral
Antenna Description:	Manufacturer: Sansei Electric Co., Ltd. Type: ½ wave dipole antenna Part No.: ANTB18-022A0 Frequency Range: 2400 – 2500 MHz Gain: 1.14 – 2.14 dBi

2.4. LIST OF EUT’S PORTS

Port Number	EUT’s Port Description	Number of Identical Ports	Connector Type	Cable Type (Shielded/Non-shielded)
1	Telephone Plug	1	RJ14	Non-shielded

2.5. ANCILLARY EQUIPMENT

N/A

2.6. TEST SETUP BLOCK DIAGRAM

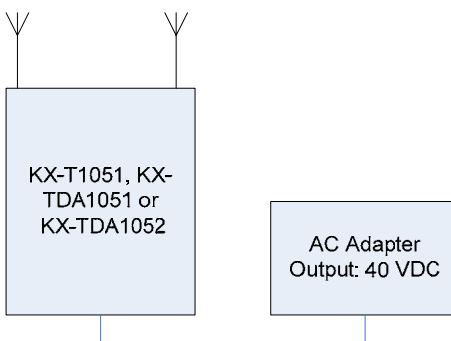

EXHIBIT 3. EUT OPERATING CONDITIONS AND CONFIGURATIONS DURING TESTS

3.1. CLIMATE TEST CONDITIONS

The climate conditions of the test environment are as follows:

Temperature:	21°C
Humidity:	51%
Pressure:	102 kPa
Power input source:	40V DC

3.2. OPERATIONAL TEST CONDITIONS & ARRANGEMENT FOR TESTS

Operating Modes:	<ul style="list-style-type: none"> ▪ Each of lowest, middle and highest channel frequencies transmits in Tx burst mode for emissions measurements. ▪ The EUT operates in frequency hopping mode and digital modulation mode.
Special Test Software:	Special software is provided by the applicant to select and operate the EUT at each channel frequency continuously and mode of operation such as frequency hopping and direct sequence or digital modulation for testing purpose.
Special Hardware Used:	Special serial cable is provided by the applicant to put the EUT into test mode.
Transmitter Test Antenna:	The EUT is tested with the antenna fitted in a manner typical of normal intended use as integral antenna equipment.

Transmitter Test Signals	
Frequency Band(s):	2401.056 – 2479.680 MHz
Frequency(ies) Tested: (Near lowest, near middle & near highest frequencies in the frequency range of operation.)	2401.056, 2440.800 & 2479.680 MHz.
RF Power Output:	22.70 dBm peak
Normal Test Modulation:	GFSK
Modulating Signal Source:	Internal

EXHIBIT 4. SUMMARY OF TEST RESULTS

4.1. LOCATION OF TESTS

All of the measurements described in this report were performed at Ultratech Group of Labs located in the city of Oakville, Province of Ontario, Canada.

Radiated Emissions were performed at the Ultratech's 3-10 TDK Semi-Anechoic Chamber situated in the Town of Oakville, province of Ontario. This test site been calibrated in accordance with ANSI C63.4, and found to be in compliance with the requirements of Sec. 2.948 of the FCC Rules. The descriptions and site measurement data of the Oakville 3-10 TDK Semi-Anechoic Chamber has been filed with FCC office (FCC File No.: 31040/SIT 1300B3) and Industry Canada office (Industry Canada File No.: IC2049-1). Last Date of Site Calibration: June 20, 2006

4.2. APPLICABILITY & SUMMARY OF EMC EMISSION TEST RESULTS

FCC Section(s)	Test Requirements	Compliance (Yes/No)
15.107(a) /15.207(a)	AC Power Conducted Emissions	Yes
15.109(a)	Class B Radiated Emissions	Yes <small>(Note 1)</small>
15.247(a)(1)	20dB Bandwidth	Yes
15.247(b)(1)	Peak Output Power	Yes
15.247(d), 15.209 & 15.205	Spurious Radiated Emissions	Yes
15.247(i), 1.1310 & 2.1091	RF Exposure	Yes

Notes:

(1) A separate engineering test report for compliance with FCC Part 15, Subpart B – Class B Unintentional Radiators will be provided upon request.

4.3. MODIFICATIONS INCORPORATED IN THE EUT FOR COMPLIANCE PURPOSES

None.

ULTRATECH GROUP OF LABS

3000 Bristol Circle, Oakville, Ontario, Canada L6H 6G4
Tel. #: 905-829-1570, Fax. #: 905-829-8050 Email: vic@ultratech-labs.com, Website: <http://www.ultratech-labs.com>

File #: PAN-078F15C247-B
May 24, 2007

All test results contained in this engineering test report are traceable to National Institute of Standards and Technology (NIST)

EXHIBIT 5. MEASUREMENTS, EXAMINATIONS & TEST DATA FOR EMC EMISSIONS

5.1. TEST PROCEDURES

This section contains test results only. Details of test methods and procedures can be found in ANSI C63.4; KDB Publication No. 558074: Guidance on Measurements for Digital Transmission Systems (47 CFR 15.247); FCC Public Notice DA 00-705: Filing and Measurement Guidelines for Frequency Hopping Spread Spectrum Systems.

5.2. MEASUREMENT UNCERTAINTIES

The measurement uncertainties stated were calculated in accordance with requirements of UKAS Document LAB 34 with a confidence level of 95%. Please refer to Exhibit 6 for Measurement Uncertainties.

5.3. MEASUREMENT EQUIPMENT USED

The measurement equipment used complied with the requirements of the Standards referenced in the Methods & Procedures ANSI C63.4 and CISPR 16-1.

5.4. COMPLIANCE WITH FCC PART 15 – GENERAL TECHNICAL REQUIREMENTS

FCC Section	FCC Rules	Manufacturer's Clarification
15.31	The hopping function must be disabled for tests, which should be performed with the EUT transmitting on the number of frequencies specified in this Section. The measurements made at the upper and lower ends of the band of operation should be made with the EUT tuned to the highest and lowest available channels.	Software was provided which allowed the hopping function to be disabled for testing and permitted the EUT to be tuned to the highest and lowest available channel.
15.203	Described how the EUT complies with the requirement that either its antenna is permanently attached, or that it employs a unique antenna connector, for every antenna proposed for use with the EUT. The exception is in those cases where EUT must be professionally installed. In order to demonstrate that professional installation is required, the following 3 points must be addressed: <ul style="list-style-type: none"> ➤ The application (or intended use) of the EUT ➤ The installation requirements of the EUT ➤ The method by which the EUT will be marketed 	The antennas are permanently attached.
15.204	Provided the information for every antenna proposed for use with the EUT: (a) type (e.g. Yagi, patch, grid, dish, etc...), (b) manufacturer and model number (c) gain with reference to an isotropic radiator	Type of antenna: Dipole Antenna (1/2 wave length) Manufacturer: Sansei Electric Co., LTD. Model: ANTB18-022A0 Frequency Range: 2400-2500 MHz Gain: Max. 2.14 dBi
15.247(a)	Description of how the EUT meets the definition	The EUT hops every 10 ms, according to a

ULTRATECH GROUP OF LABS

3000 Bristol Circle, Oakville, Ontario, Canada L6H 6G4
 Tel. #: 905-829-1570, Fax. #: 905-829-8050 Email: vic@ultratech-labs.com, Website: <http://www.ultratech-labs.com>

File #: PAN-078F15C247-B
 May 24, 2007

	of a frequency hopping spread spectrum, found in Section 2.1. Based on the technical description.	pseudo random sequence, a total of 75 channels.
15.247(a)	<u>Pseudo Frequency Hopping Sequence:</u> Describe how the hopping sequence is generated. Provide an example of the hopping sequence channels, in order to demonstrate that the sequence meets the requirements specified in the definition of a frequency hopping spread spectrum system, found in Section 2.1	There is a pseudo random table, using the channel designation from 1 to 75. The hopping sequences are generated by a pseudo random number generator.
15.247(a)	<u>Equal Hopping Frequency Use:</u> Describe how each individual EUT meets the requirement that each of its hopping channels is used equally on average (e.g. that each new transmission event begins on the next channel in the hopping sequence after final channel used in the previous transmission events).	When starting transmission, the EUT will select an initial frequency channel at random. From that point, the EUT follows the sequence set by the hopping table.
15.247(g)	Describe how the EUT complies with the requirement that it be designed to be capable of operating as a true frequency hopping system	This unit hops every 10 ms, which complies with the requirement of not more than 400 ms within a 30 second period at any frequency.
15.247(h)	Describe how the EUT complies with the requirement that it not have the ability to coordinated with other FHSS is an effort to avoid the simultaneous occupancy of individual hopping frequencies by multiple transmitters	The EUT doesn't coordinate frequency-hopping channels for the express purpose of avoiding the simultaneous occupancy of individual hopping frequencies by multiple transmitters.
Public Notice DA 00-705	<u>System Receiver Input Bandwidth:</u> Describe how the associated receiver(s) complies with the requirement that its input bandwidth (either RF or IF) matches the bandwidth of the transmitted signal.	The EUT uses low IF filters to ensure matching the receiver bandwidth to the transmitter bandwidth.
Public Notice DA 00-705	<u>System Receiver Hopping Capability:</u> Describe how the associated receiver(s) has the ability to shift frequencies in synchronization with the transmitted signals	The EUT uses super-heterodyne receiver. The receiver shifts frequencies in synchronization with the transmitted signals by a pseudo random table.

5.5. AC POWER LINE CONDUCTED EMISSIONS [§15.207(a)]

5.5.1. Limit

The equipment shall meet the limits of the following table:

Frequency of emission (MHz)	Class B Conducted Limits (dBµV)		Measuring Bandwidth
	Quasi-peak	Average	
0.15–0.5	66 to 56*	56 to 46*	RBW = 9 kHz VBW ≥ 9 kHz for QP VBW = 1 Hz for Average
0.5–5	56	46	
5–30	60	50	

*Decreases linearly with the logarithm of the frequency

5.5.2. Method of Measurements

Refer to Exhibit 8, Section 8.2 of this test report & ANSI C63.4

5.5.3. Test Arrangement

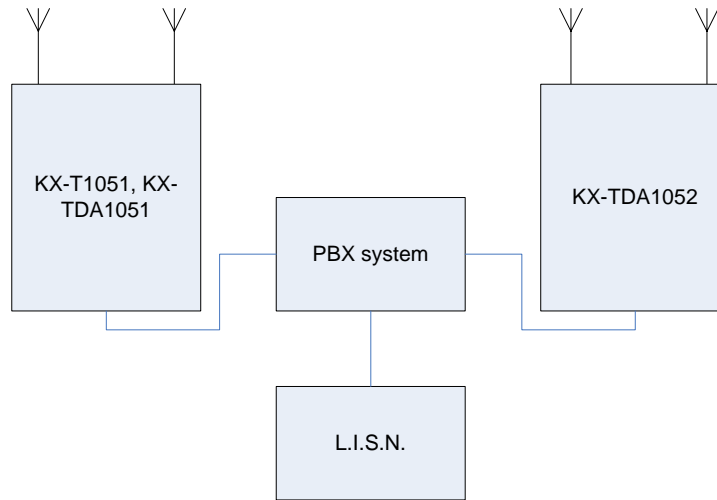

5.5.4. Test Equipment List

Test Instruments	Manufacturer	Model No.	Serial No.	Frequency Range
Spectrum Analyzer/ EMI Receiver	Hewlett Packard	HP 8593EM	3412A00103	9 kHz – 26.5 GHz
Transient Limiter	Hewlett Packard	11947A	310701998	9 kHz – 200 MHz 10 dB attenuation
L.I.S.N.	EMCO	3825/2	89071531	9 kHz – 200 MHz 50 Ohms / 50 µH
24'(L) x 16'(W) x 8'(H) RF Shielded Chamber	Braden Shielding

5.5.5. Test Data

Plot 5.5.5.1.
 AC Power Line Conducted Emissions
 Line Voltage: 120VAC 60Hz
 Line Tested: L1

Frequency hopping mode

hp

Signal	Freq (MHz)	PK Amp	QP Amp	AV Amp	AV Δ L2
1	0.157725	40.0	37.2	32.0	-23.6
2	3.397250	39.5	38.3	36.5	-9.4
3	12.800000	44.8	42.4	40.3	-9.6

ACTV DET: PEAK
 MEAS DET: PEAK QP AVG
 MKR 12.75 MHz
 41.71 dB μ V

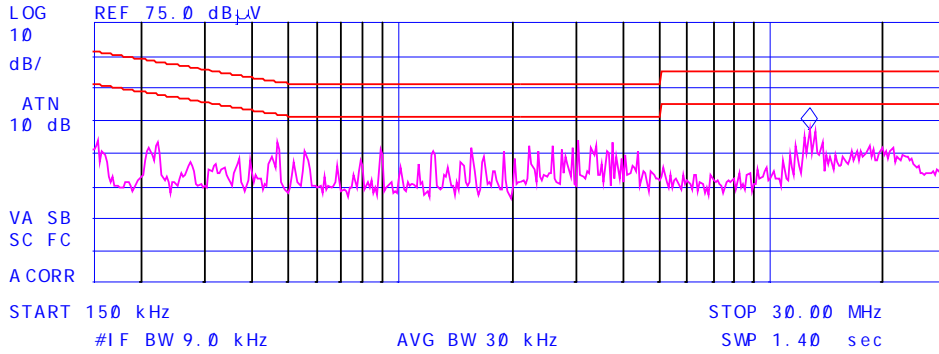

Plot 5.5.5.2.
 AC Power Line Conducted Emissions
 Line Voltage: 120VAC 60Hz
 Line Tested: L2

Frequency hopping mode

hp

Signal	Freq (MHz)	PK Amp	QP Amp	AV Amp	AV Δ L2
1	0.227950	48.6	47.7	47.5	-5.1
2	3.073125	38.8	38.1	34.8	-11.2
3	12.800500	43.8	41.5	40.0	-9.9

ACTV DET: PEAK
 MEAS DET: PEAK QP AVG
 MKR 230 kHz
 46.83 dB μ V

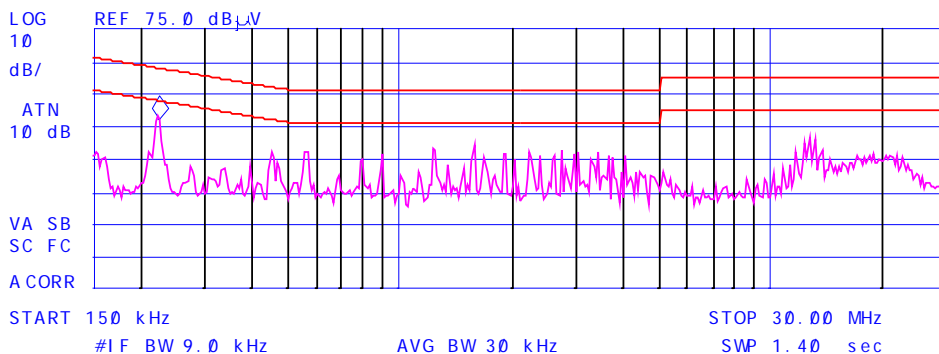

5.6. 20 dB Bandwidth [§15.247(a)(1) & §15.247(a)(1)(iii)]

5.6.1. Limits

FCC 15.247(a)(1): Frequency hopping systems shall have hopping channel carrier frequencies separated by a minimum of 25 kHz or the 20 dB bandwidth of the hopping channel, whichever is greater. Alternatively, frequency hopping systems operating in the 2400-2483.5 MHz band may have hopping channel carrier frequencies that are separated by 25 kHz or two-thirds of the 20 dB bandwidth of the hopping channel, whichever is greater, provided the systems operate with an output power no greater than 125 mW. The system shall hop to channel frequencies that are selected at the system hopping rate from a pseudorandomly ordered list of hopping frequencies. Each frequency must be used equally on the average by each transmitter. The system receivers shall have input bandwidths that match the hopping channel bandwidths of their corresponding transmitters and shall shift frequencies in synchronization with the transmitted signals.

FCC 15.247(a)(1)(iii): Frequency hopping systems in the 2400-2483.5 MHz band shall use at least 15 channels. The average time of occupancy on any channel shall not be greater than 0.4 seconds within a period of 0.4 seconds multiplied by the number of hopping channels employed. Frequency hopping systems may avoid or suppress transmissions on a particular hopping frequency provided that a minimum of 15 channels are used.

5.6.2. Method of Measurements

Refer to FCC Public Notice DA 00-705, KDB Publication No. 558074 and ANSI C63.4 for measurement methods.

5.6.3. Test Arrangement

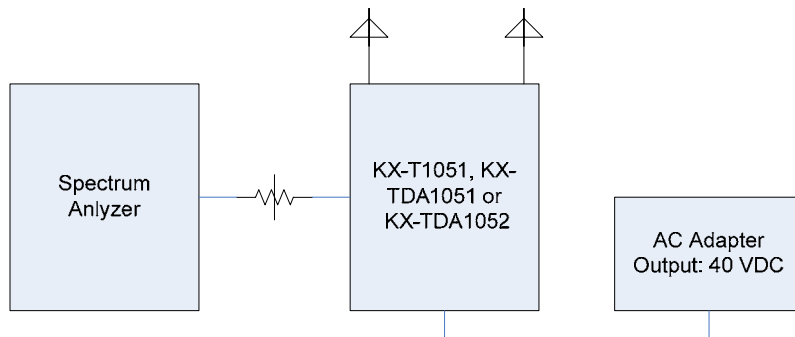

5.6.4. Test Equipment List

Test Instruments	Manufacturer	Model No.	Serial No.	Frequency Range
Spectrum Analyzer/ EMI Receiver	Rohde & Schwarz	FSEK20/B4/B21	834157/005	9 kHz – 40 GHz with external mixer
Attenuator	Weinchel Corp.	46-20-34	BM0653	DC -18GHz

5.6.5. Test Data

Note: Bandwidth measurements were done using the built-in auto function of the analyzer.

5.6.5.1. KX-T0151, KX-TDA0151

Frequency (MHz)	20 dB Bandwidth (kHz)
2401.056	622.24
2440.800	640.28
2479.680	649.29

See the following plots for detailed measurements.

Plot 5.6.5.1.1. 20 dB Bandwidth
 Test Frequency: 2401.056 MHz

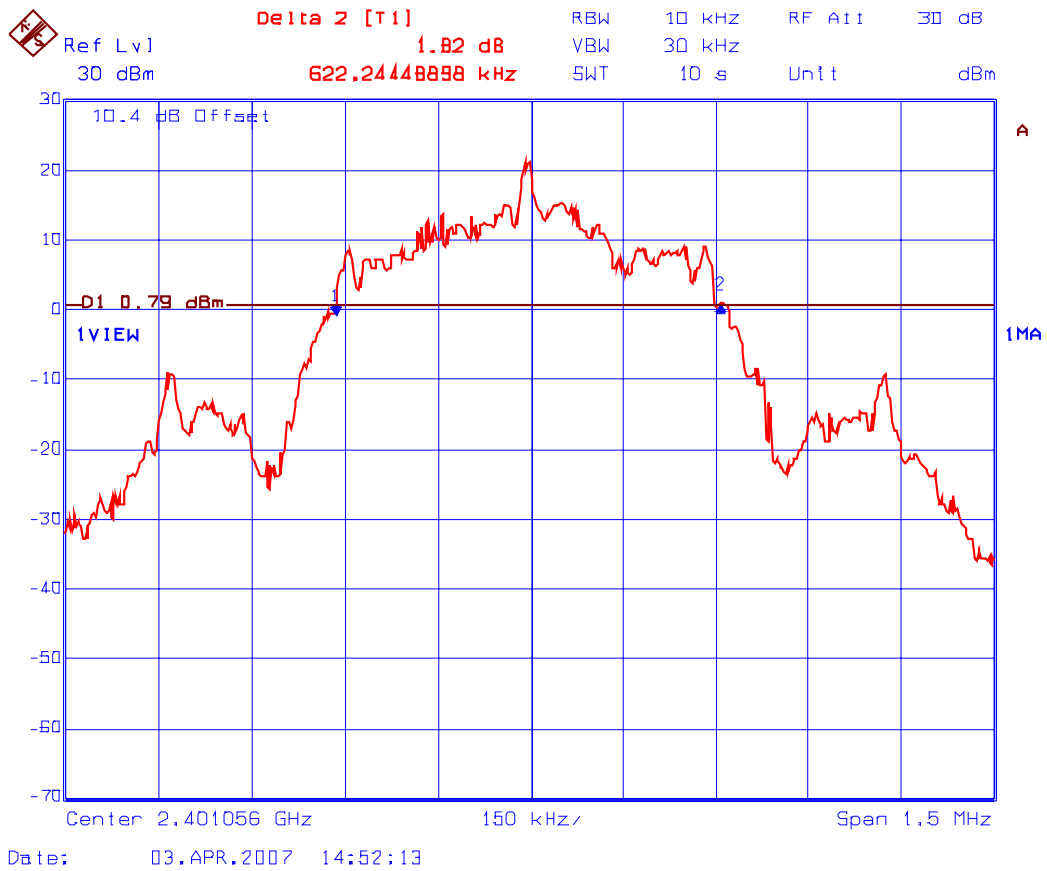

Plot 5.6.5.1.2. 20 dB Bandwidth
Test Frequency: 2440.800 MHz

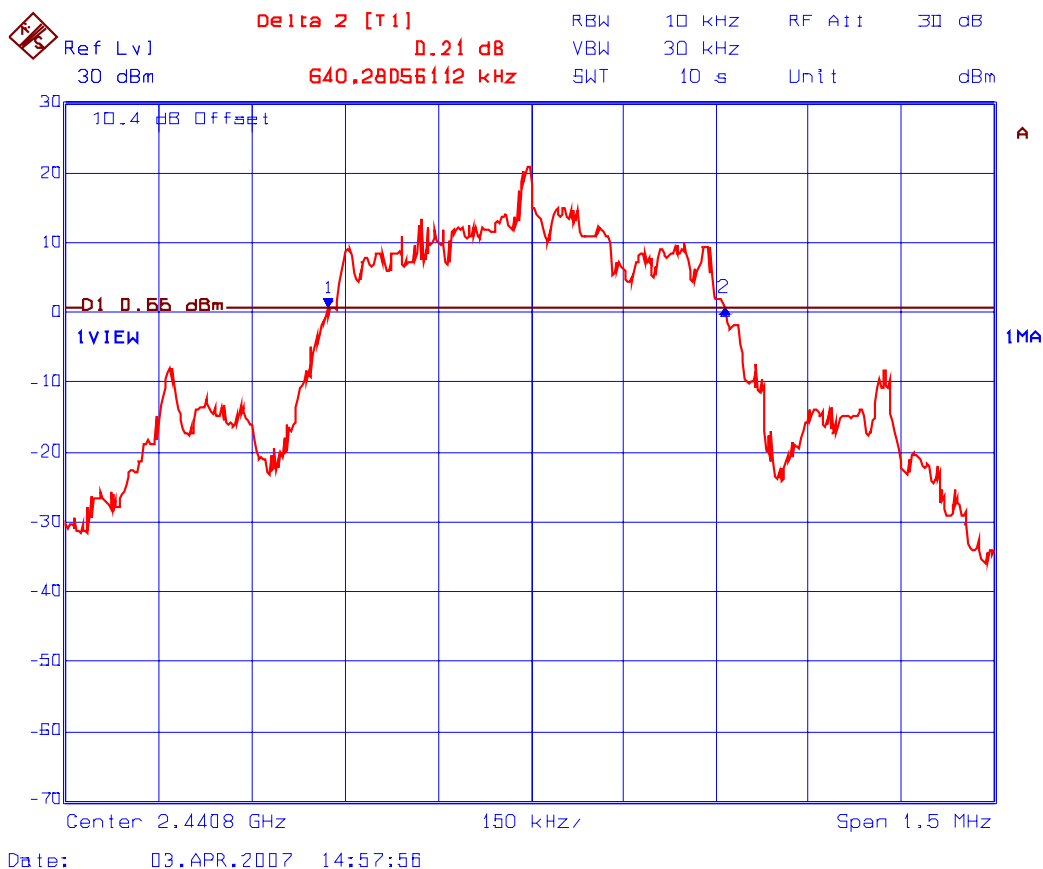

Plot 5.6.5.1.3. 20 dB Bandwidth
Test Frequency: 2479.680 MHz

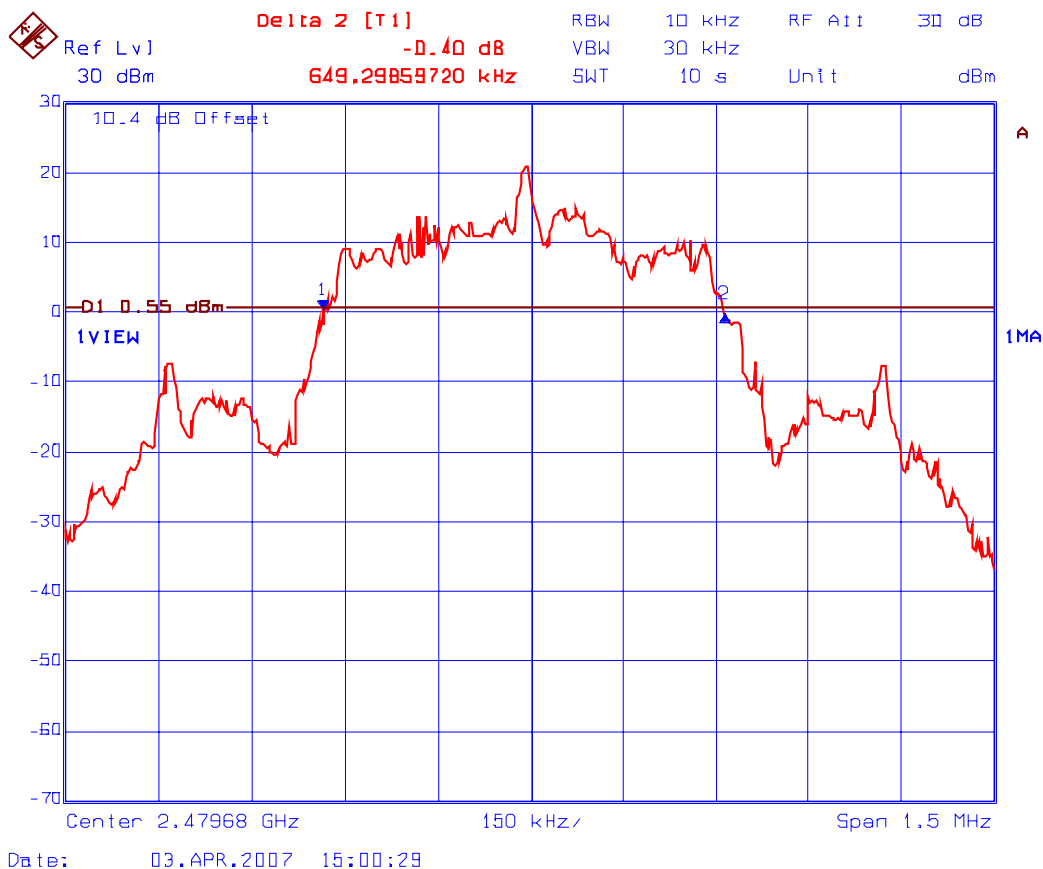

Plot 5.6.5.1.4. Carrier Frequency Separation

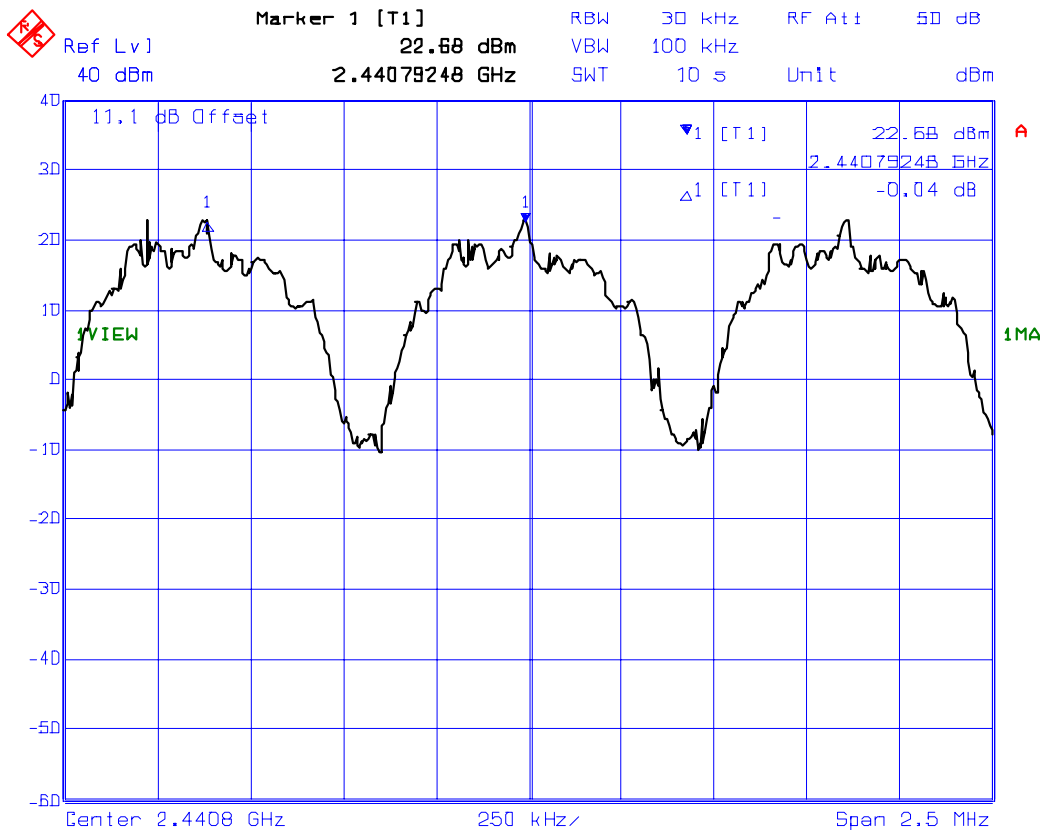

$$2/3 * 20\text{dB BW} = 2/3 * 649.29 \text{ KHz} = 432.86 \text{ KHz} < 861.723 \text{ KHz}$$

Plot 5.6.5.1.5. Number of hopping frequencies
2.395GHz ~ 2.425GHz

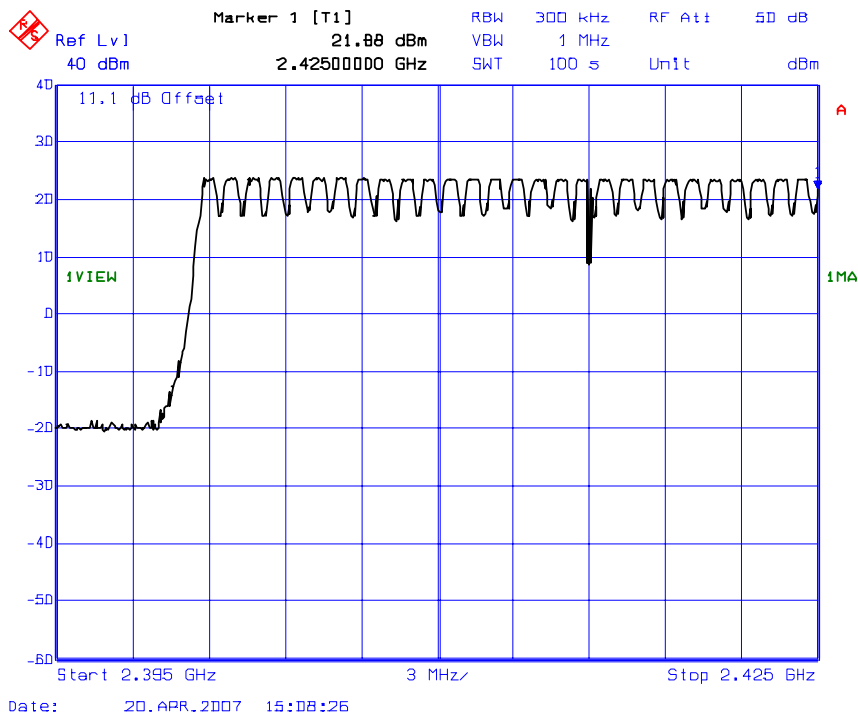

28 hopping frequencies

Plot 5.6.5.1.6. Number of hopping frequencies
2.425GHz ~ 2.45GHz

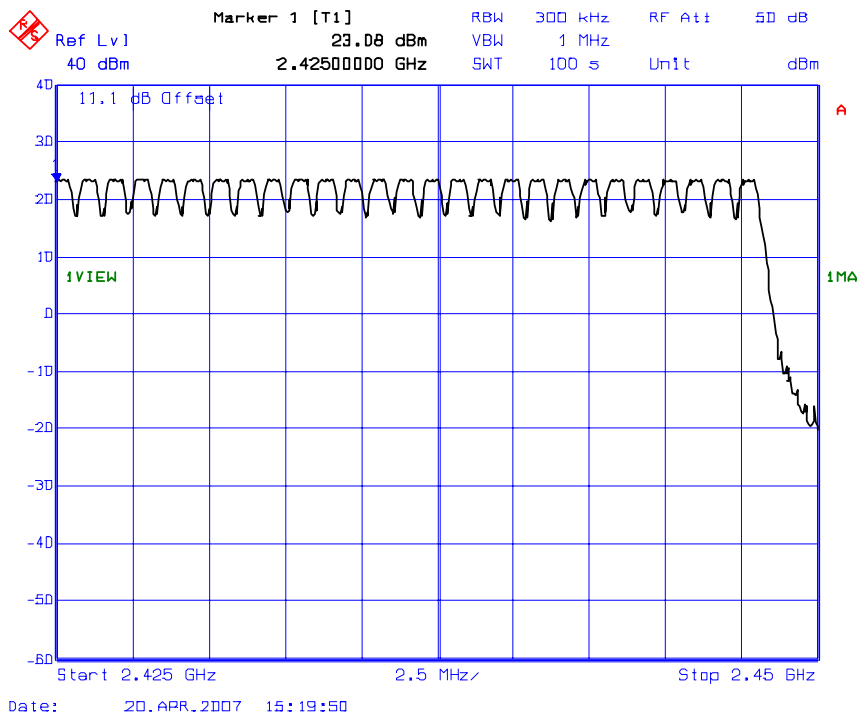

27 hopping frequencies

Plot 5.6.5.1.7. Number of hopping frequencies
2.45GHz ~ 2.485GHz

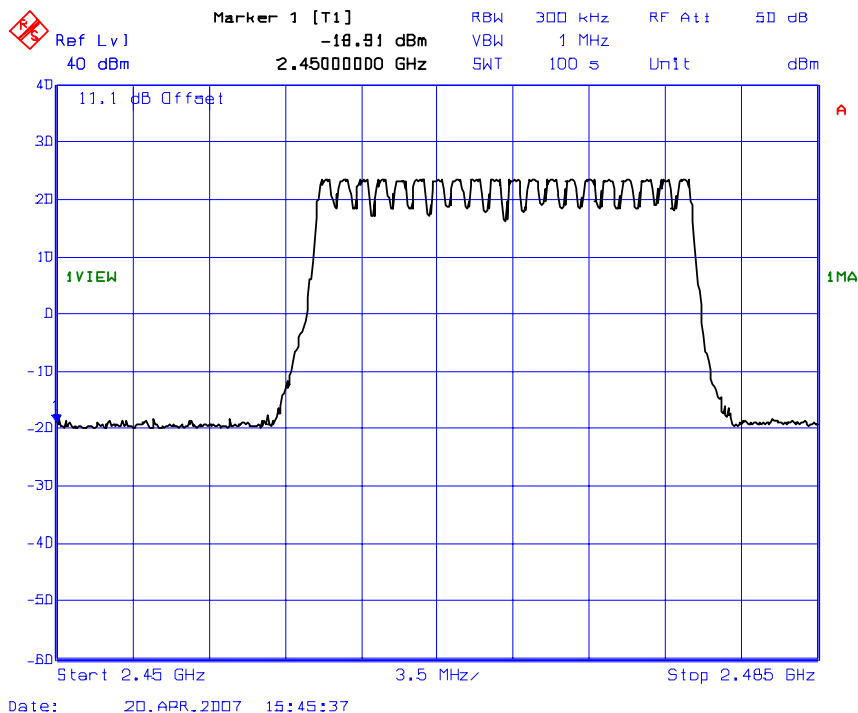

20 hopping frequencies

Plot 5.6.5.1.8. Number of hopping frequencies
2.395GHz ~ 2.485GHz

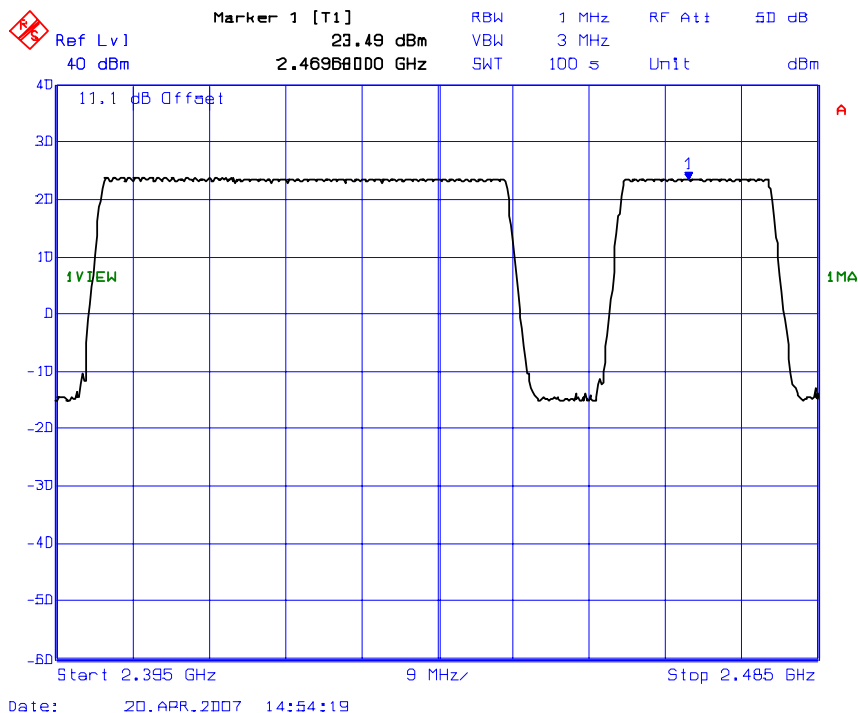

$$28 + 27 + 20 = 75 \text{ hopping frequencies}$$

Plot 5.6.5.1.9. Time of Occupancy
Test Frequency: 2401.056 MHz

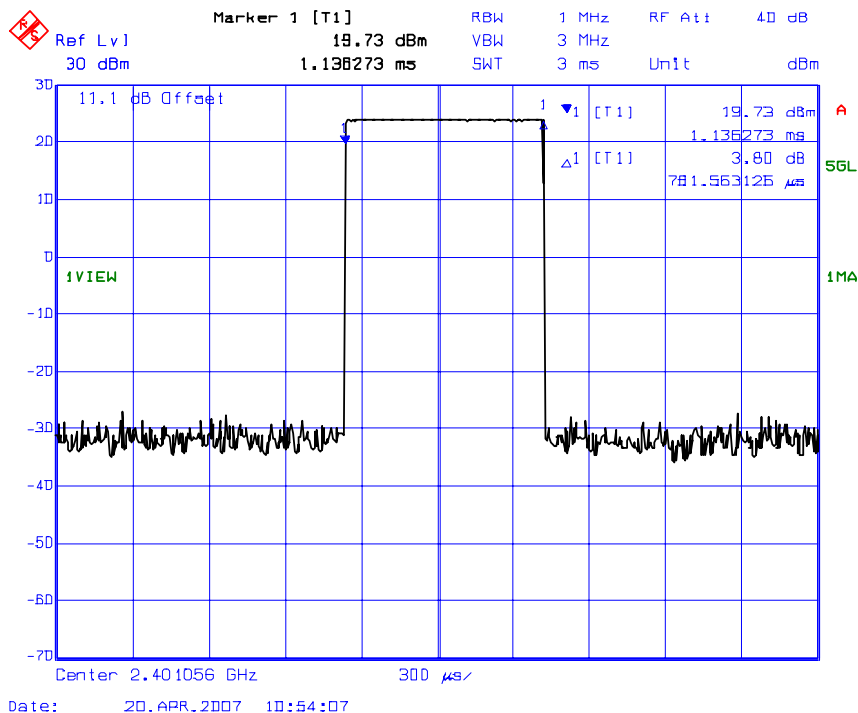

781.56 usec

Plot 5.6.5.1.10. Time of Occupancy
Test Frequency: 2401.056 MHz

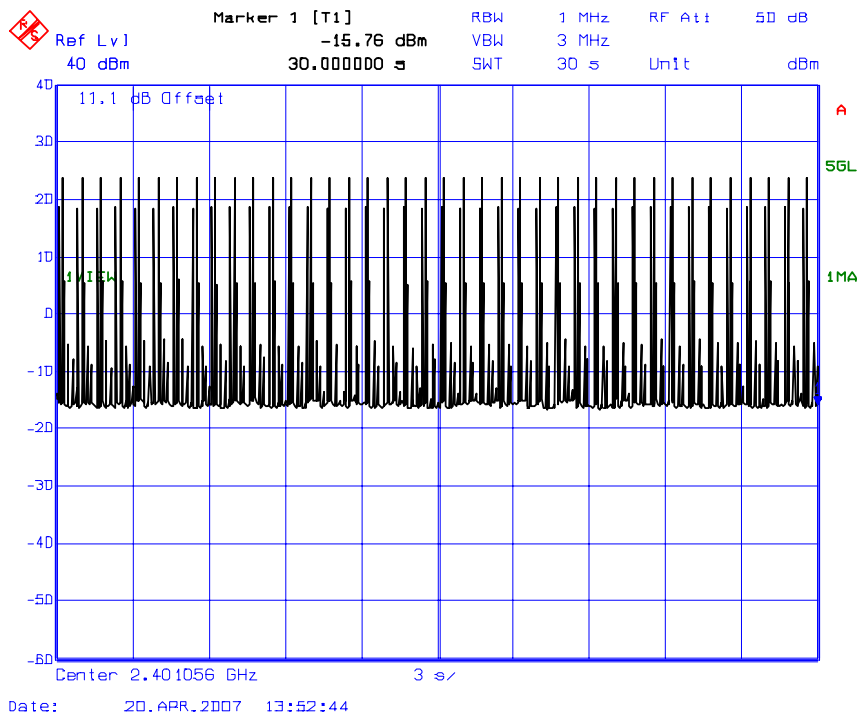

$781.56 \text{ usec} * 40 = 31.262 \text{ msec}$
 $75 \text{ frequencies channels} * 0.4 \text{ msec} = 3 \text{ sec}$
 $0.313 \text{ sec within the period of 3 sec} < 0.4 \text{ sec}$

Plot 5.6.5.1.11. Time of Occupancy
Test Frequency: 2440.800 MHz

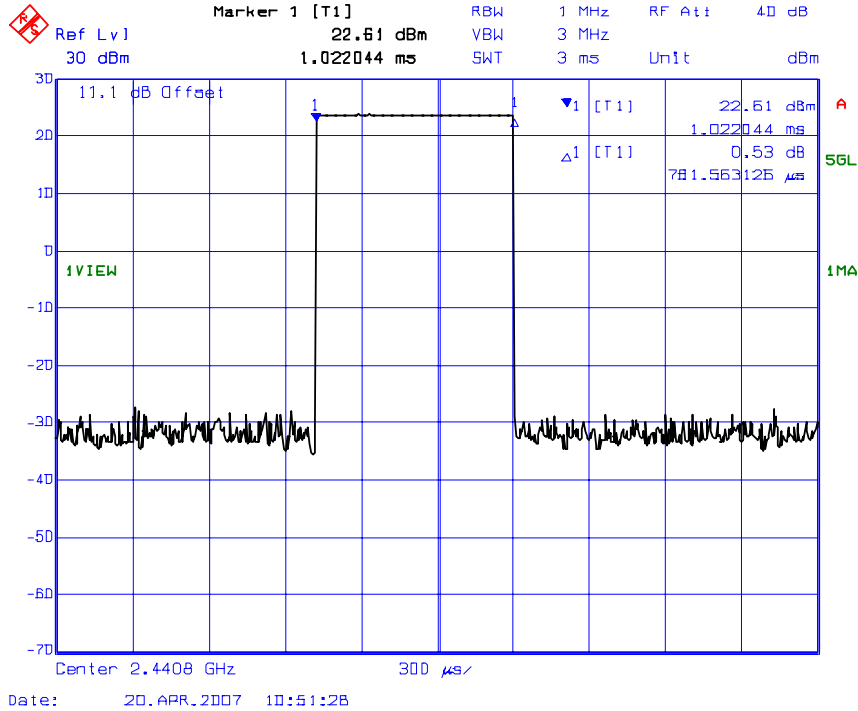

781.56 usec

Plot 5.6.5.1.12. Time of Occupancy
Test Frequency: 2440.800MHz

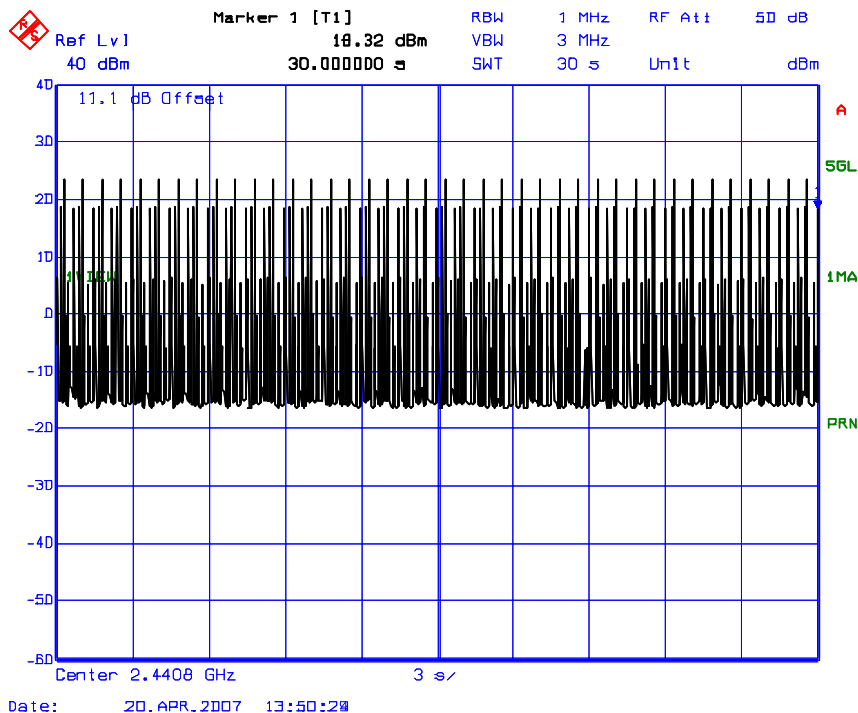

$781.56 \text{ usec} * 40 = 31.262 \text{ msec}$
 $75 \text{ frequencies channels} * 0.4 \text{ msec} = 3 \text{ sec}$
 $0.313 \text{ sec within the period of } 3 \text{ sec} < 0.4 \text{ sec}$

Plot 5.6.5.1.13. Time of Occupancy
Test Frequency: 2479.680 MHz

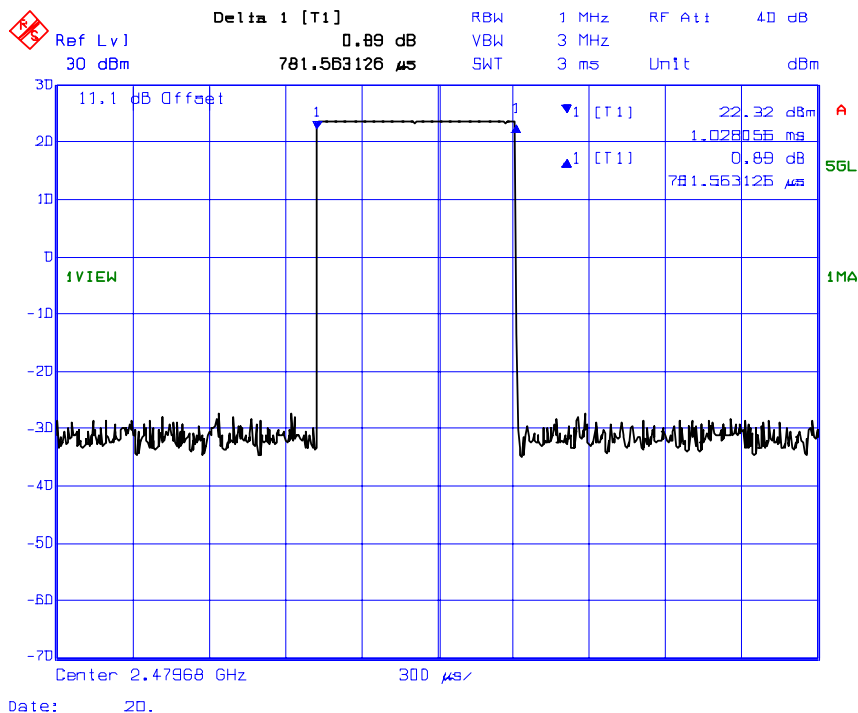

781.56 usec

Plot 5.6.5.1.14. Time of Occupancy
Test Frequency: 2479.680MHz

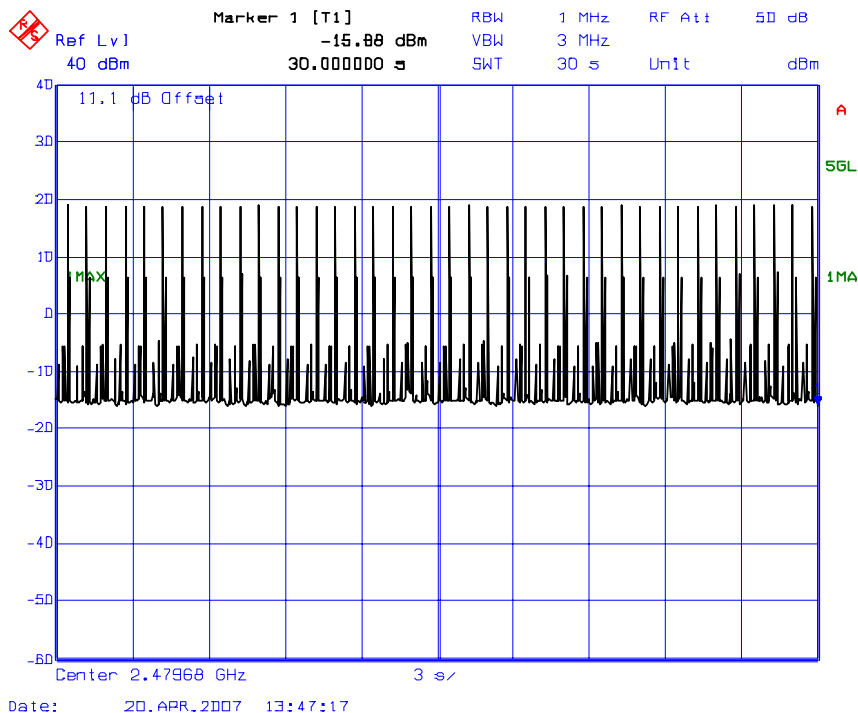

$781.56 \text{ usec} * 40 = 31.262 \text{ msec}$
 $75 \text{ frequencies channels} * 0.4 \text{ msec} = 3 \text{ sec}$
 $0.313 \text{ sec within the period of } 3 \text{ sec} < 0.4 \text{ sec}$

5.6.5.2. KX-TDA0152

Frequency (MHz)	20 dB Bandwidth (kHz)
2401.056	640.28
2440.800	634.27
2479.680	652.30

See the following plots for detailed measurements.

Plot 5.6.5.2.1. 20 dB Bandwidth
 Test Frequency: 2401.056 MHz

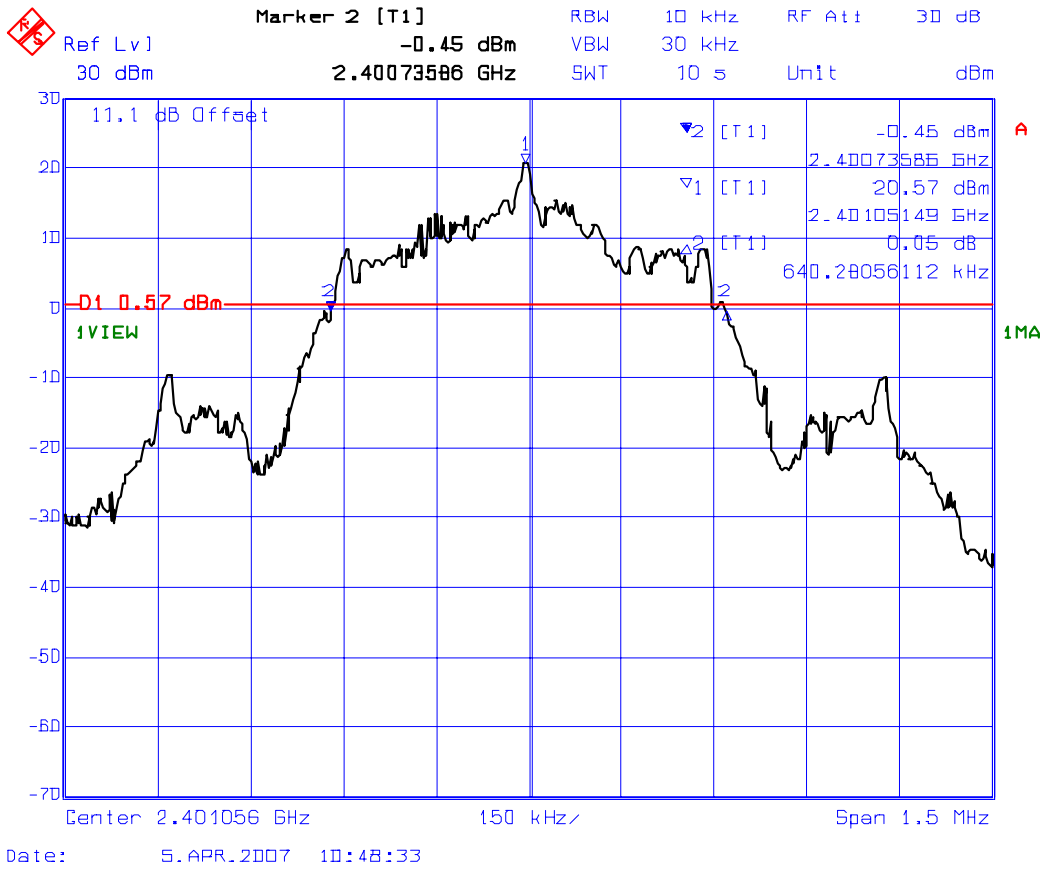

Plot 5.6.5.2.2. 20 dB Bandwidth
Test Frequency: 2440.800 MHz

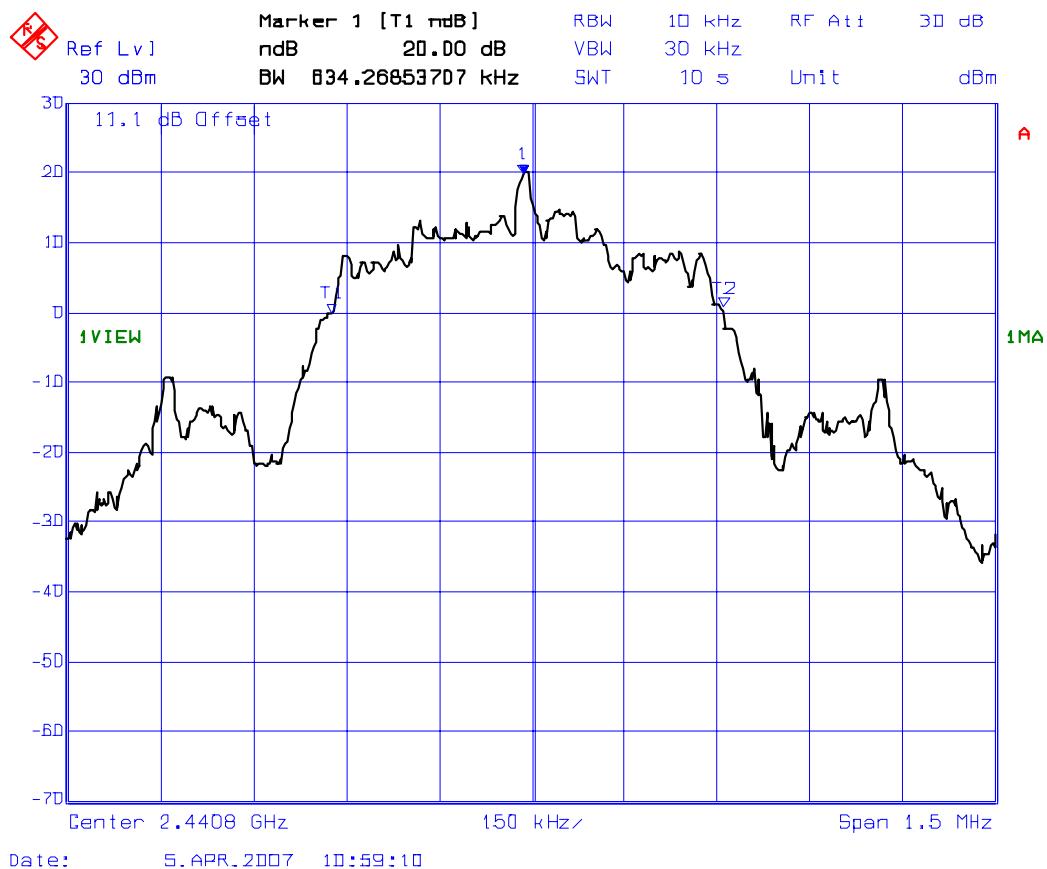

Plot 5.6.5.2.3. 20 dB Bandwidth
Test Frequency: 2479.680 MHz

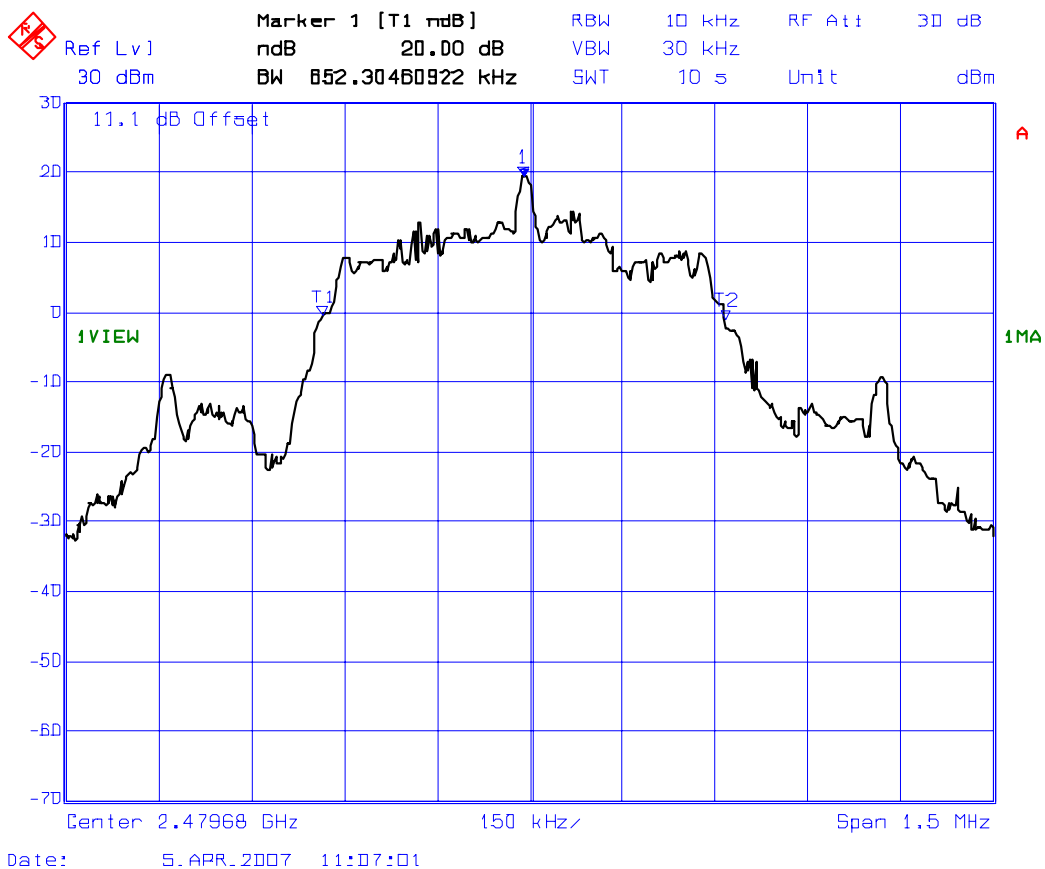

Plot 5.6.5.2.4. Carrier Frequency Separation

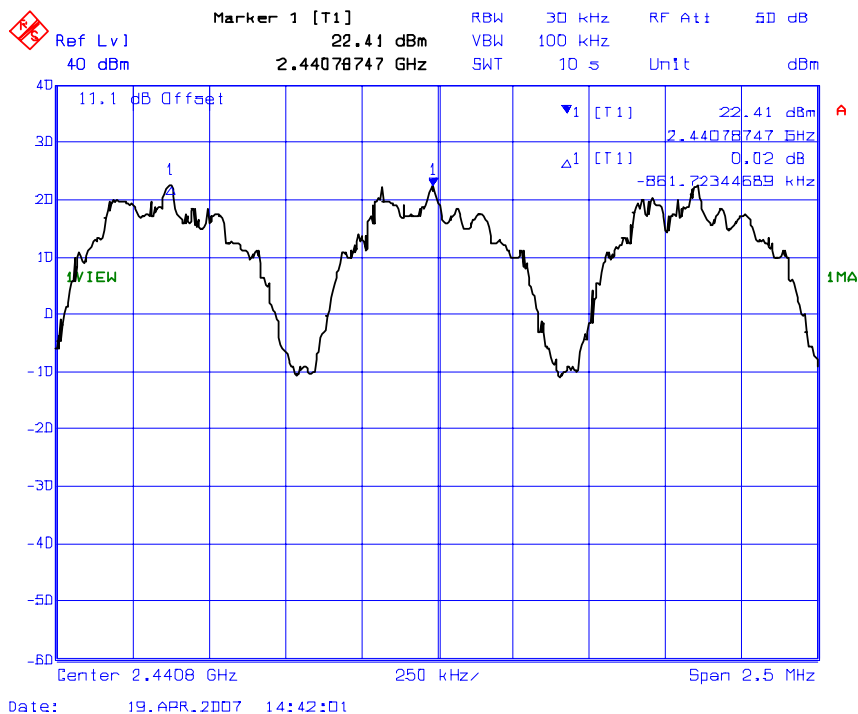

$$2/3 * 20\text{dB BW} = 2/3 * 652.30 \text{ KHz} = 434.87 \text{ KHz} < 861.723 \text{ KHz}$$

Plot 5.6.5.2.5. Number of hopping frequencies
2.395GHz ~ 2.425GHz

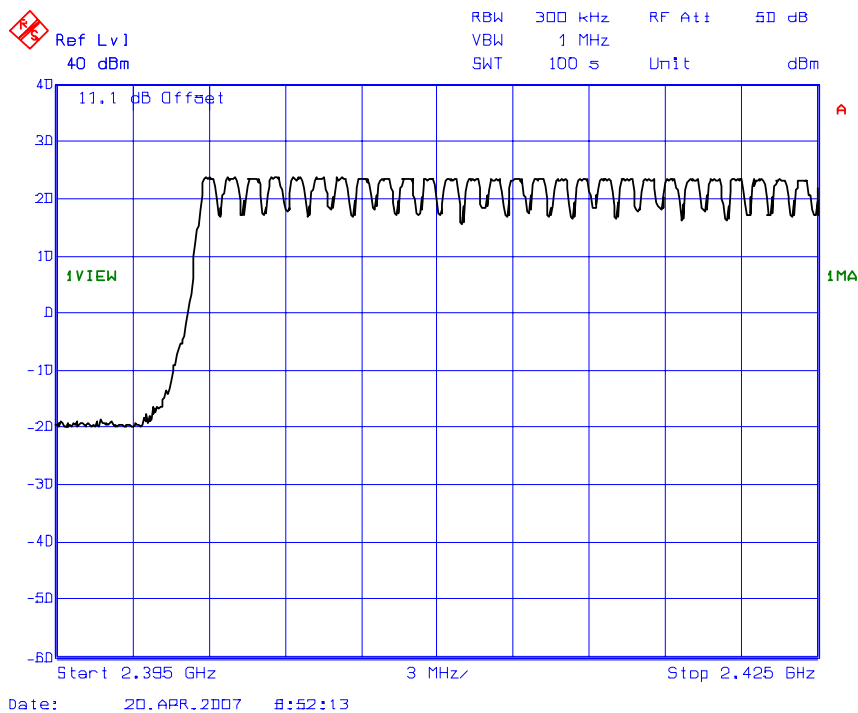

28 hopping frequencies

Plot 5.6.5.2.6. Number of hopping frequencies
2.425GHz ~ 2.45GHz

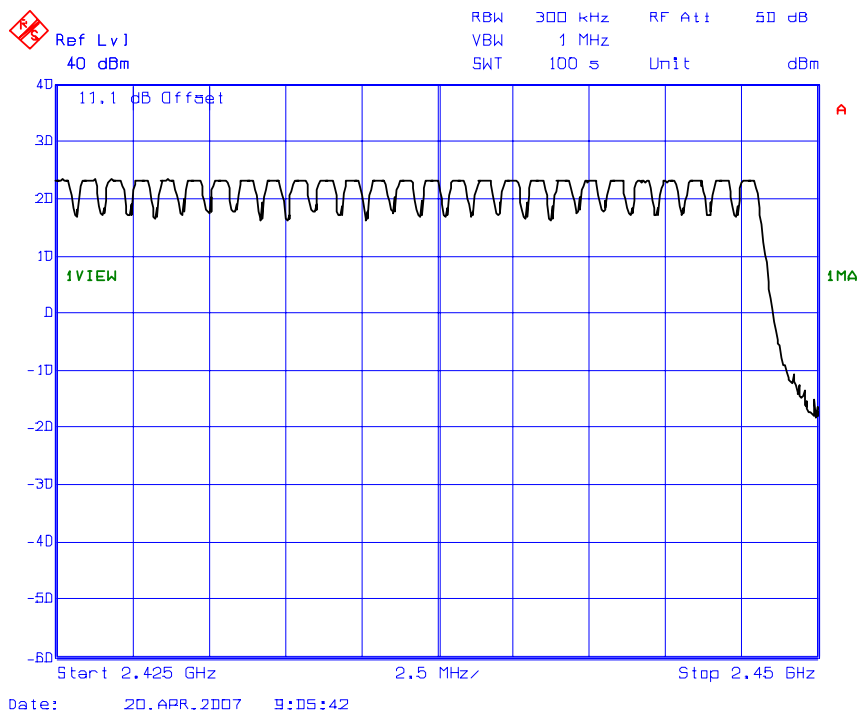

27 hopping frequencies

Plot 5.6.5.2.7. Number of hopping frequencies
2.45GHz ~ 2.485GHz

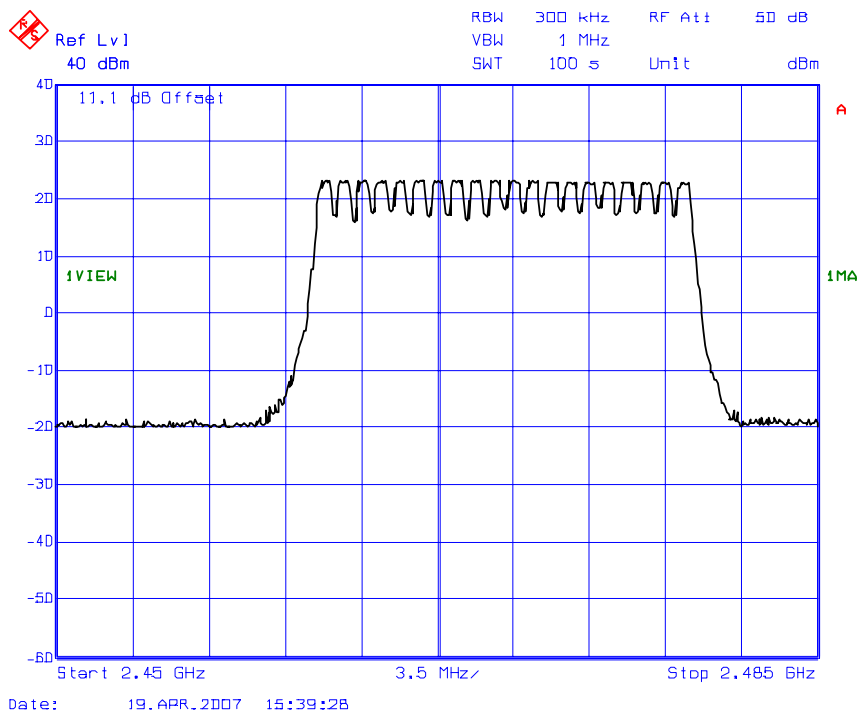

20 hopping frequencies

Plot 5.6.5.2.8. Number of hopping frequencies
2.395GHz ~ 2.485GHz

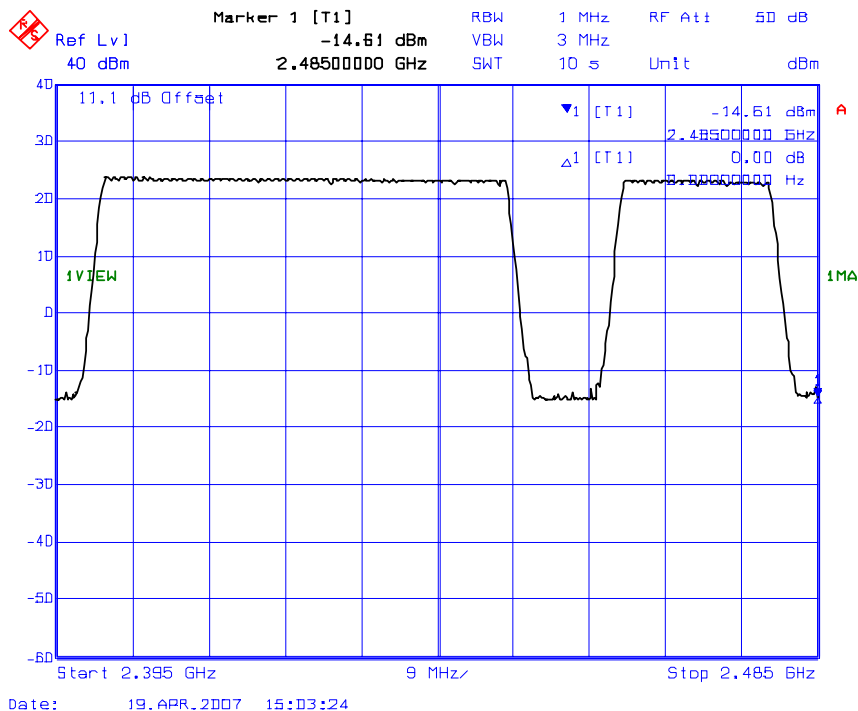

28 + 27 + 20 = 75 hopping frequencies

Plot 5.6.5.2.9. Time of Occupancy
Test Frequency: 2401.056 MHz

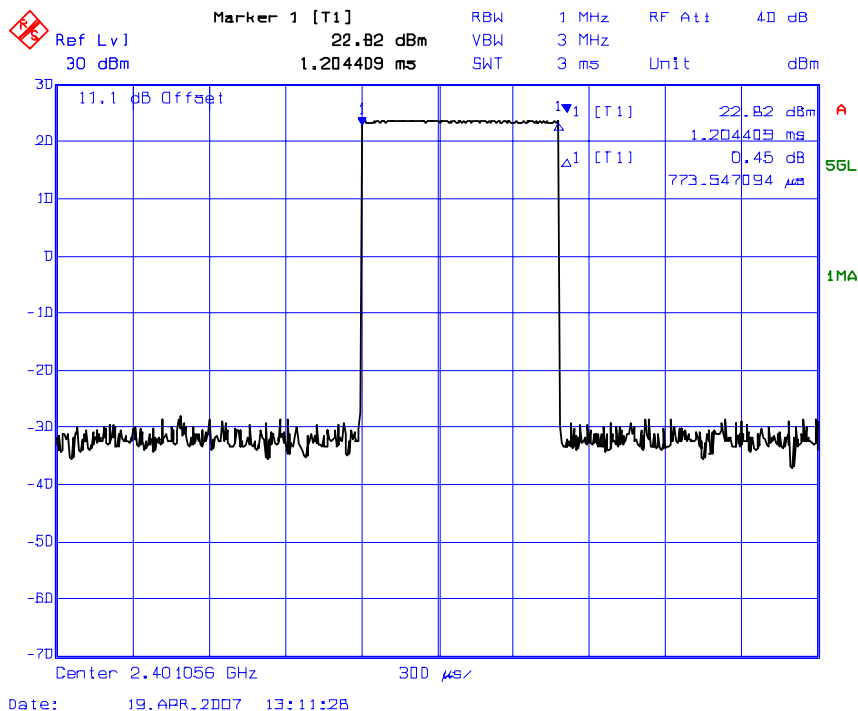

773.55 usec

Plot 5.6.5.2.10. Time of Occupancy
Test Frequency: 2401.056 MHz

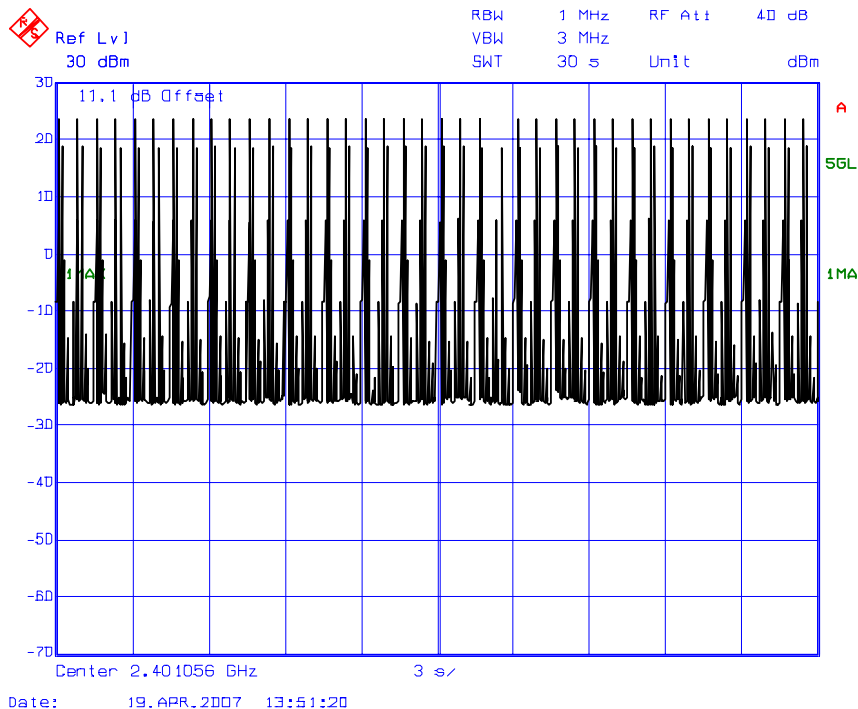

$773.55 \text{ usec} * 40 = 30.942 \text{ msec}$
 $75 \text{ frequencies channels} * 0.4 \text{ msec} = 3 \text{ sec}$
 $0.309 \text{ sec within the period of } 3 \text{ sec} < 0.4 \text{ sec}$

Plot 5.6.5.2.11. Time of Occupancy
 Test Frequency: 2440.800 MHz

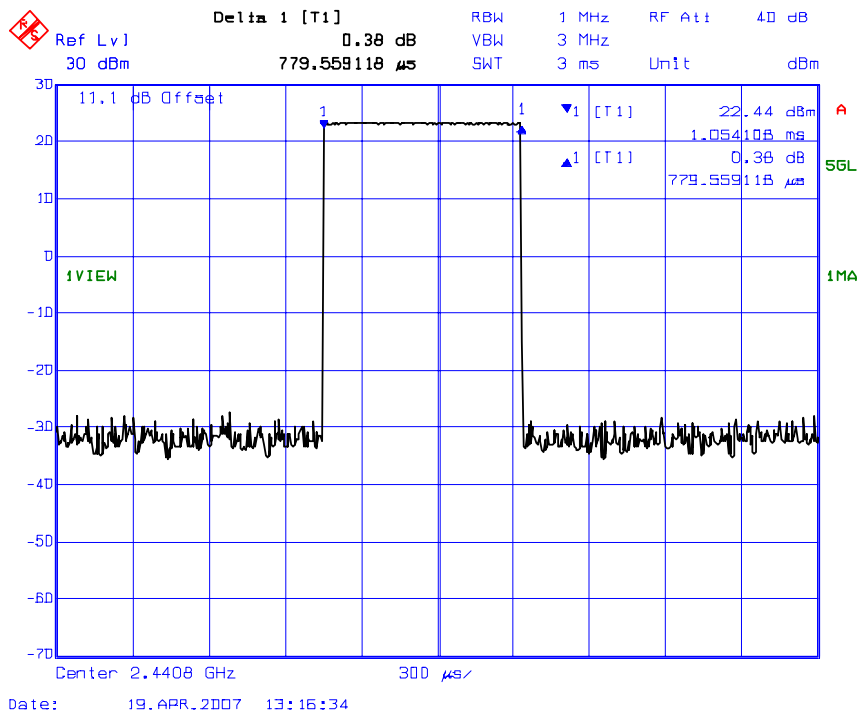

779.56 usec

Plot 5.6.5.2.12. Time of Occupancy
Test Frequency: 2440.800MHz

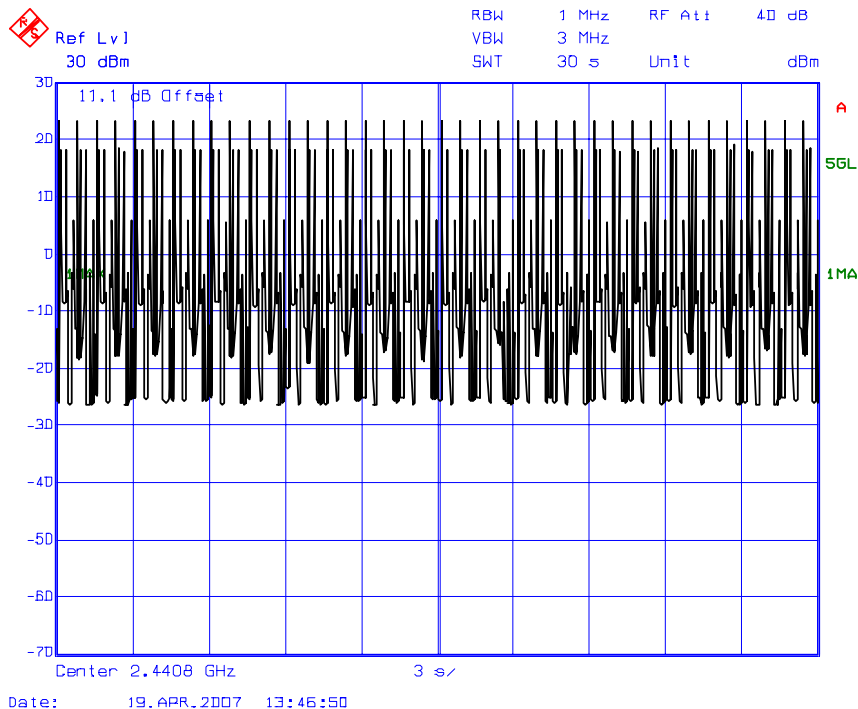

$779.56 \text{ usec} * 40 = 31.182 \text{ msec}$
 $75 \text{ frequencies channels} * 0.4 \text{ msec} = 3 \text{ sec}$
 $0.312 \text{ sec within the period of } 3 \text{ sec} < 0.4 \text{ sec}$

Plot 5.6.5.2.13. Time of Occupancy
Test Frequency: 2479.680 MHz

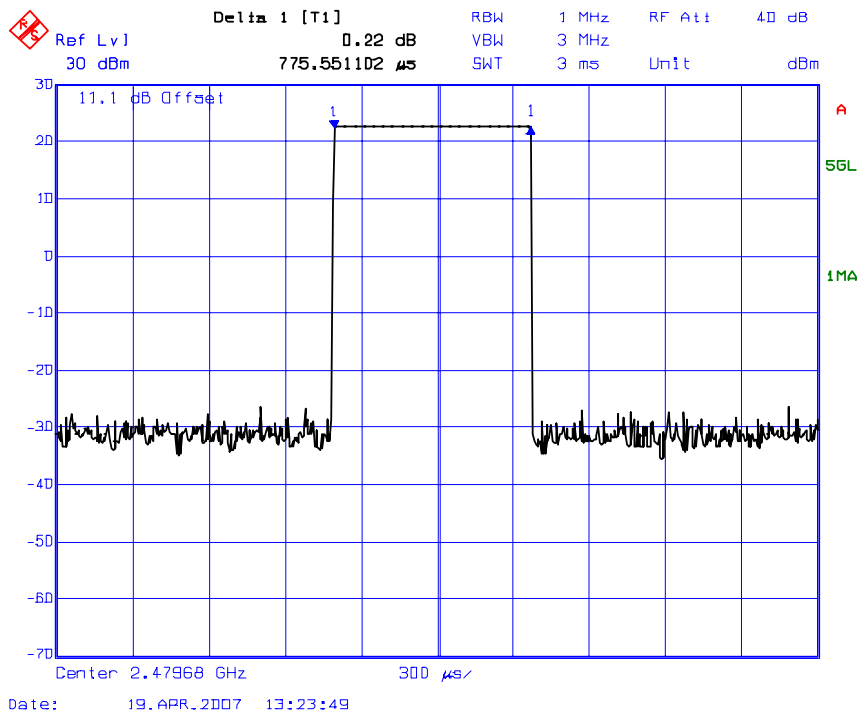

775.55 usec

Plot 5.6.5.2.14. Time of Occupancy
Test Frequency: 2479.680MHz

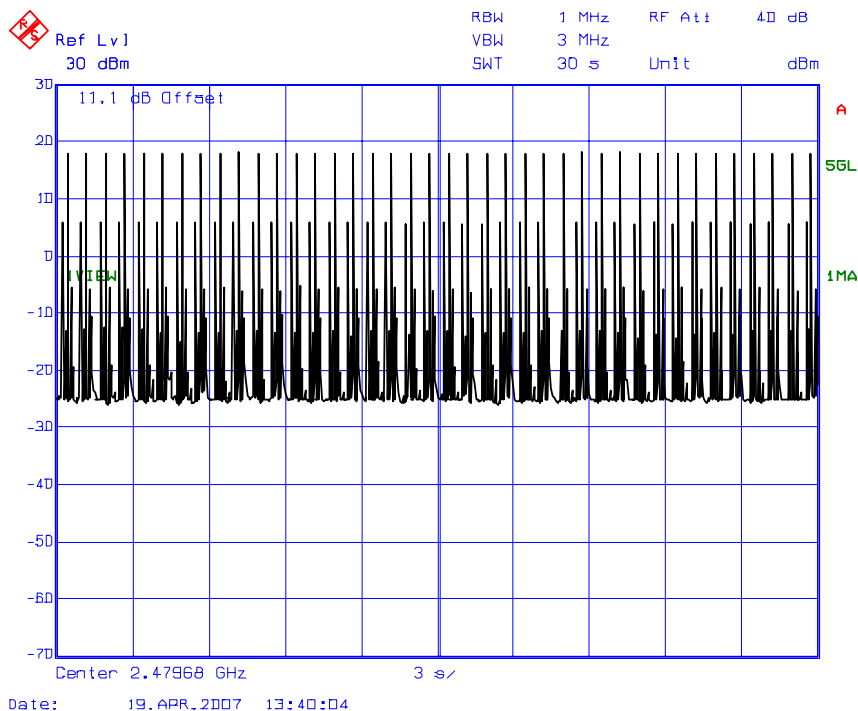

$775.55 \text{ usec} * 40 = 30.862 \text{ msec}$
 $75 \text{ frequencies channels} * 0.4 \text{ msec} = 3 \text{ sec}$
 $0.309 \text{ sec within the period of 3 sec} < 0.4 \text{ sec}$

5.7. PEAK OUTPUT POWER [§§ 15.247(b)(1)]

5.7.1. Limits

- **FCC 15.247(b)(1):** Maximum peak output power of the transmitter shall not exceed 1 Watt.

5.7.2. Method of Measurements

Refer to FCC Public Notice DA 00-705, KDB Publication No. 558074 and ANSI C63.4 for measurement methods.

5.7.3. Test Equipment List

Test Instruments	Manufacturer	Model No.	Serial No.	Frequency Range
Spectrum Analyzer/ EMI Receiver	Rohde & Schwarz	FSEK20/B4/B21	834157/005	9 kHz – 40 GHz with external mixer
Attenuator	Weinchel Corp.	46-20-34	BM0653	DC -18GHz

5.7.4. Test Arrangement

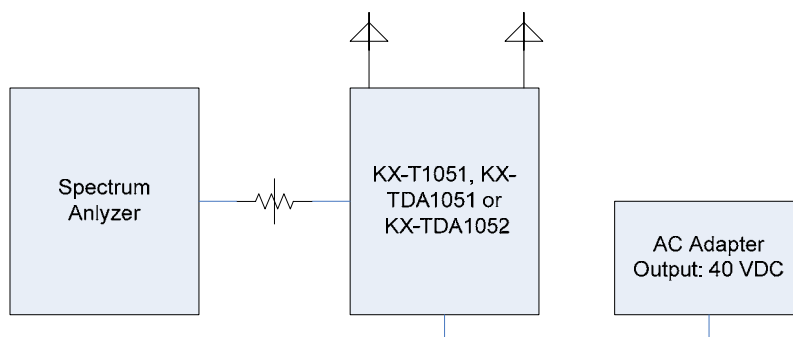

5.7.5. Test Data

5.7.5.1. KX-T0151, KX-TDA0151

Frequency (MHz)	Channel	Peak Power (dBm)	Limit (dBm)
2401.056	0	22.70	30
2440.800	46	22.57	30
2479.680	91	22.57	30

See the following plots for detailed measurements.

Plot 5.7.5.1.1. Peak Power Output
Test Frequency: 2401.056 MHz

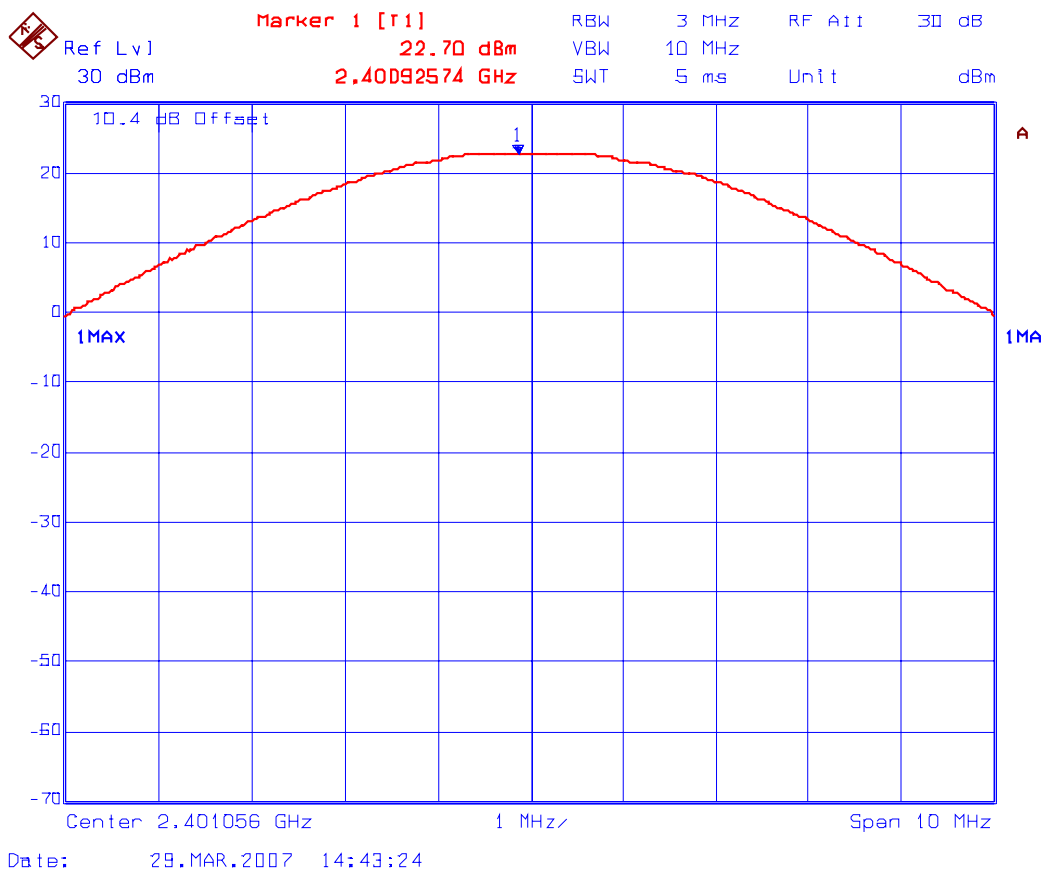

Plot 5.7.5.1.2. Peak Power Output
Test Frequency: 2440.800 MHz

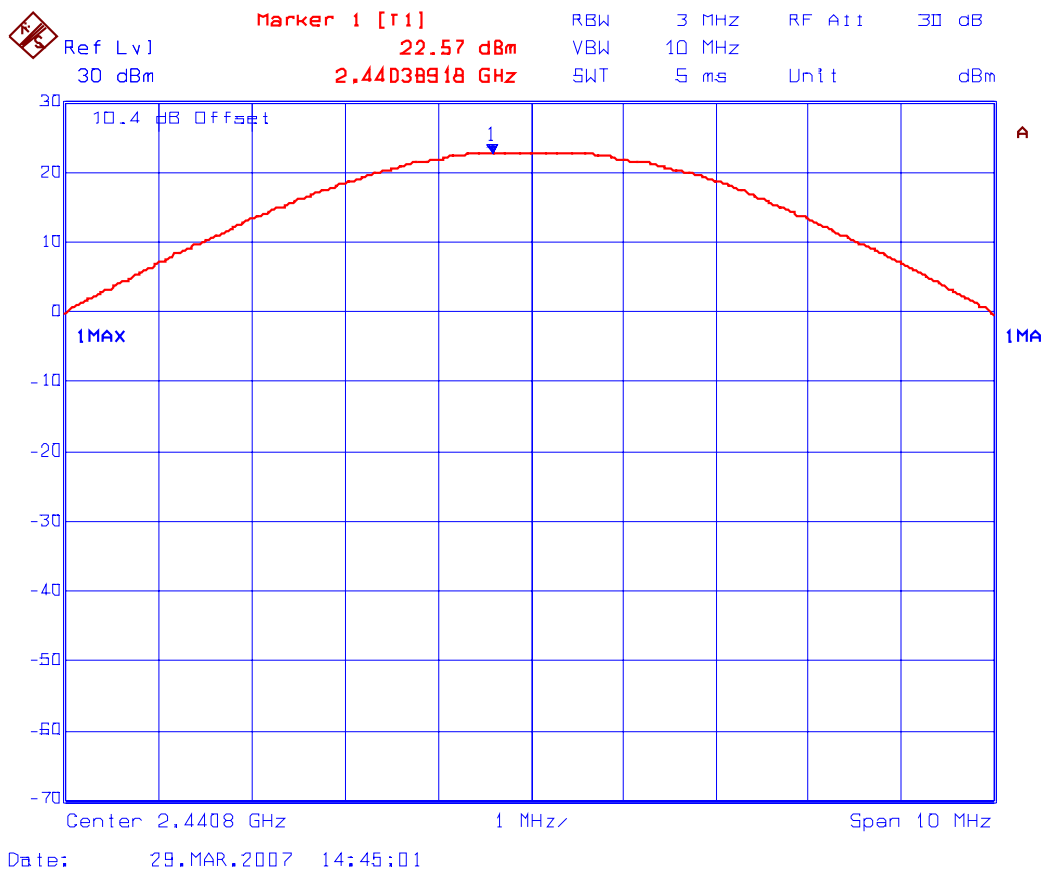

Plot 5.7.5.1.3. Peak Power Output
Test Frequency: 2479.680 MHz

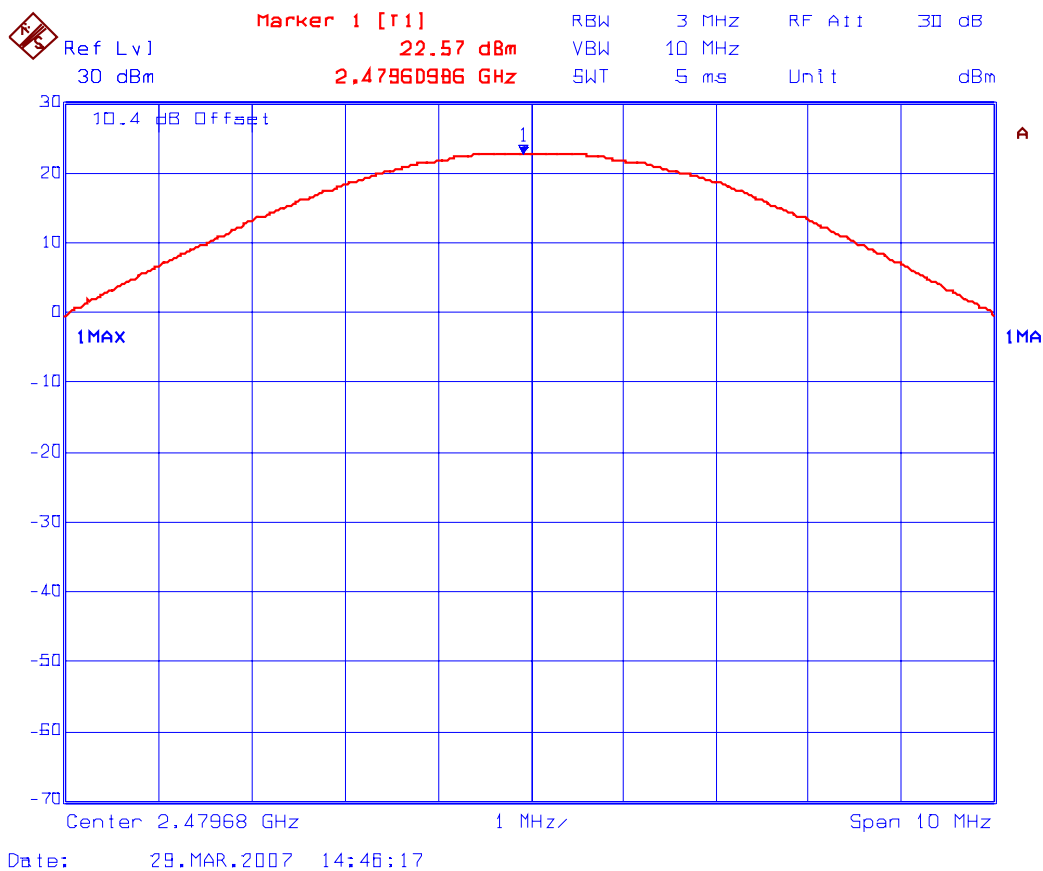

5.7.5.2. KX-TDA0152

Frequency (MHz)	Channel	Peak Power (dBm)	Limit (dBm)
2401.056	0	22.70	30
2440.800	46	22.13	30
2479.680	91	21.70	30

See the following plots for detailed measurements.

Plot 5.7.5.2.1. Peak Power Output
 Test Frequency: 2401.056 MHz

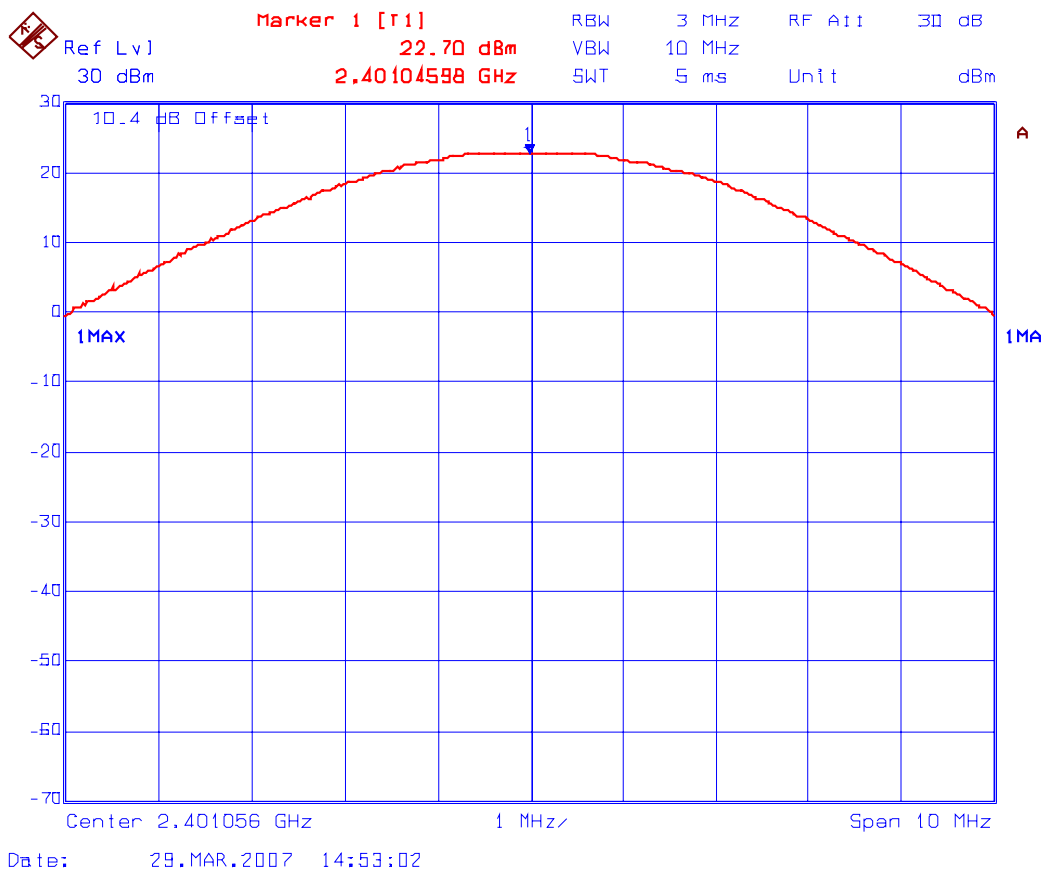

ULTRATECH GROUP OF LABS

3000 Bristol Circle, Oakville, Ontario, Canada L6H 6G4
 Tel. #: 905-829-1570, Fax. #: 905-829-8050 Email: vic@ultratech-labs.com, Website: <http://www.ultratech-labs.com>

File #: PAN-078F15C247-B
 May 24, 2007

All test results contained in this engineering test report are traceable to National Institute of Standards and Technology (NIST)

Plot 5.7.5.2.2. Peak Power Output
Test Frequency: 2440.800 MHz

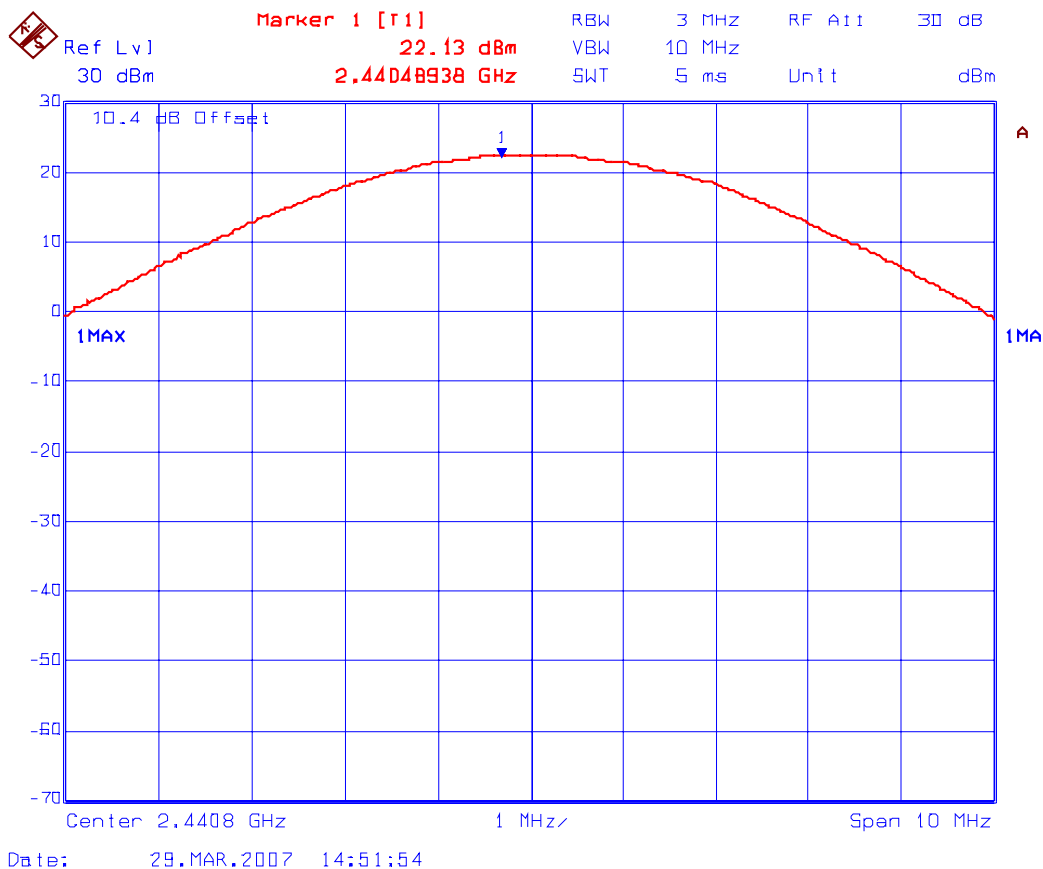

Plot 5.7.5.2.3. Peak Power Output
Test Frequency: 2479.680 MHz

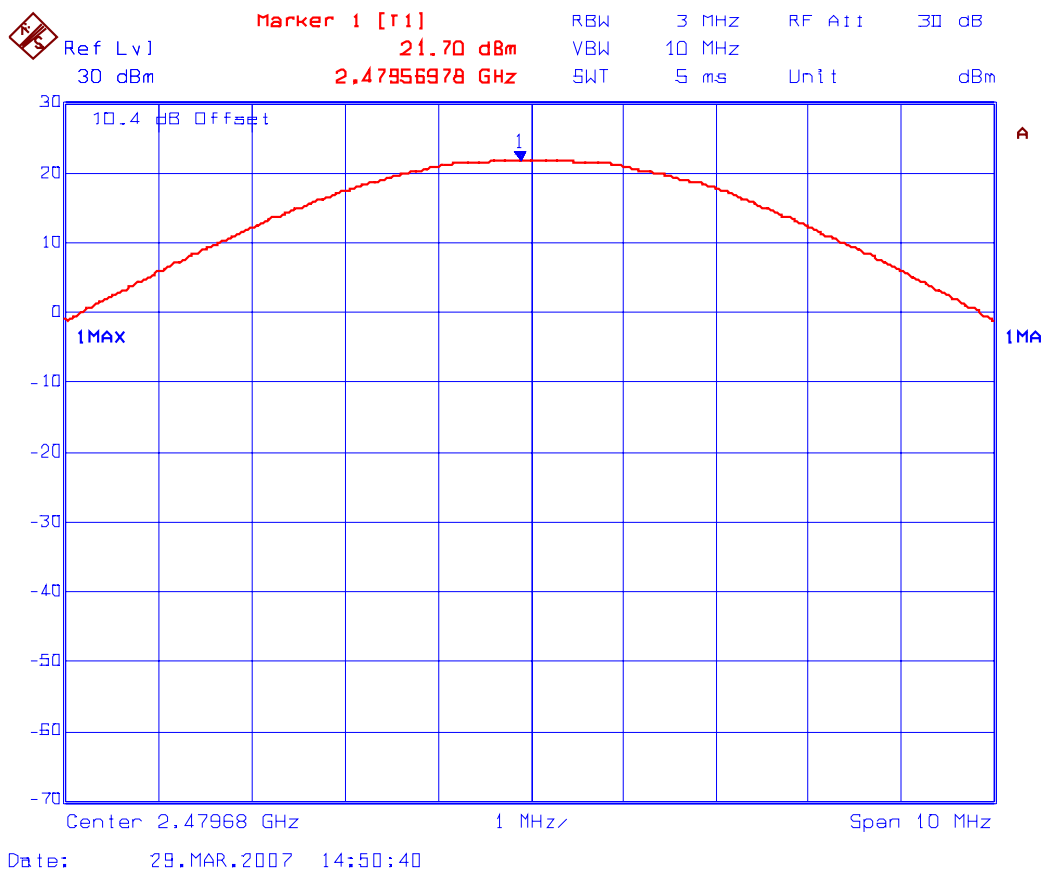

5.8. TRANSMITTER BAND-EDGE & SPURIO CONDUCTED EMISSIONS [§ 15.247(d)]

5.8.1. Limits

FCC 15.247 (d): In any 100 kHz bandwidth outside the frequency band in which the spread spectrum or digitally modulated intentional radiator is operating, the radio frequency power that is produced by the intentional radiator shall be at least 20 dB below that in the 100 kHz bandwidth within the band that contains the highest level of the desired power, based on either an RF conducted or a radiated measurement, provided the transmitter demonstrates compliance with the peak conducted power limits. If the transmitter complies with the conducted power limits based on the use of RMS averaging over a time interval, as permitted under paragraph (b)(3) of this section, the attenuation required under this paragraph shall be 30 dB instead of 20 dB. Attenuation below the general limits specified in Section 15.209(a) is not required. In addition, radiated emissions which fall in the restricted bands, as defined in Section 15.205(a), must also comply with the radiated emission limits specified in Section 15.209(a) (see Section 15.205(c)).

47 CFR 15.205(a) - Restricted Bands of Operation

MHz	MHz	MHz	GHz
0.090 - 0.110	16.42 - 16.423	399.9 - 410	4.5 - 5.15
¹ 0.495 - 0.505	16.69475 - 16.69525	608 - 614	5.35 - 5.46
2.1735 - 2.1905	16.80425 - 16.80475	960 - 1240	7.25 - 7.75
4.125 - 4.128	25.5 - 25.67	1300 - 1427	8.025 - 8.5
4.17725 - 4.17775	37.5 - 38.25	1435 - 1626.5	9.0 - 9.2
4.20725 - 4.20775	73 - 74.6	1645.5 - 1646.5	9.3 - 9.5
6.215 - 6.218	74.8 - 75.2	1660 - 1710	10.6 - 12.7
6.26775 - 6.26825	108 - 121.94	1718.8 - 1722.2	13.25 - 13.4
6.31175 - 6.31225	123 - 138	2200 - 2300	14.47 - 14.5
8.291 - 8.294	149.9 - 150.05	2310 - 2390	15.35 - 16.2
8.362 - 8.366	156.52475 - 156.52525	2483.5 - 2500	17.7 - 21.4
8.37625 - 8.38675	156.7 - 156.9	2690 - 2900	22.01 - 23.12
8.41425 - 8.41475	162.0125 - 167.17	3260 - 3267	23.6 - 24.0
12.29 - 12.293	167.72 - 173.2	3332 - 3339	31.2 - 31.8
12.51975 - 12.52025	240 - 285	3345.8 - 3358	36.43 - 36.5
12.57675 - 12.57725	322 - 335.4	3600 - 4400	(2)
13.36 - 13.41			

¹ Until February 1, 1999, this restricted band shall be 0.490-0.510 MHz.

² Above 38.6

47 CFR 15.209(a) - Radiated emission limits, general requirements

Frequency (MHz)	Field Strength (microvolts/meter)	Measurement Distance (meters)
0.009 - 0.490	2400/F(kHz)	300
0.490 - 1.705	24000/F(kHz)	30
1.705 - 30.0	30	30
30 - 88	100 **	3
88 - 216	150 **	3
216 - 960	200 **	3
Above 960	500	3

** Except as provided in paragraph (g), fundamental emissions from intentional radiators operating under this Section shall not be located in the frequency bands 54-72 MHz, 76-88 MHz, 174-216 MHz or 470-806 MHz. However, operation within these frequency bands is permitted under other sections of this Part, e.g., Sections 15.231 and 15.241.

5.8.2. Method of Measurements

Refer to Ultratech Test Procedures, Files # ULTR P002-2004 or ULTR P003-2004 and ANSI C63.4 for measurement methods

5.8.3. Test Arrangement

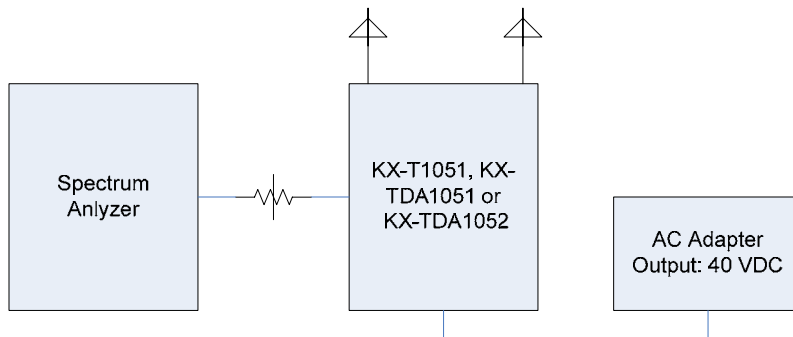

5.8.4. Test Equipment List

Test Instruments	Manufacturer	Model No.	Serial No.	Frequency Range
Spectrum Analyzer	Rhode & Schwarz	FSEK20/B4/B21	834157/005	9kHz - 40GHz
High Pass Filter	K & L	11SH10-15001T8000	2	1 - 18 GHz
Attenuator	Weinschel Corp.	46-20-34	BM0653	DC -18GHz

5.8.5. Test Data

5.8.5.1. Band-Edge RF Conducted Emissions

5.8.5.1.1. KX-T0151, KX-TDA0151

See the following test data plots for measurement results:

Plot 5.8.5.1.1.1.
Band-Edge RF Conducted Emissions
Low end of frequency band
Single frequency mode

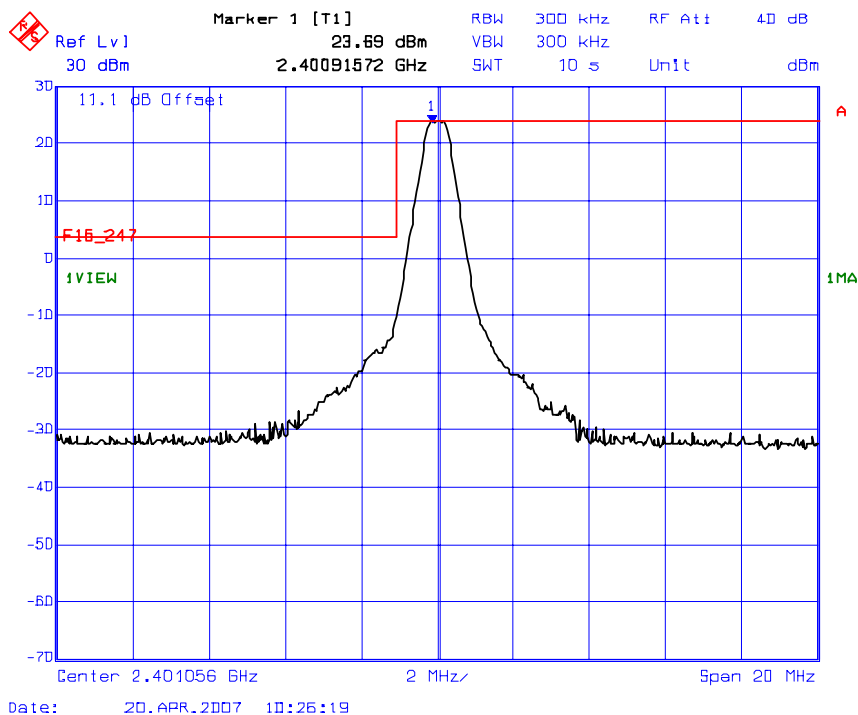

Plot 5.8.5.1.1.2.
Band-Edge RF Conducted Emissions
High end of frequency band
Single frequency mode

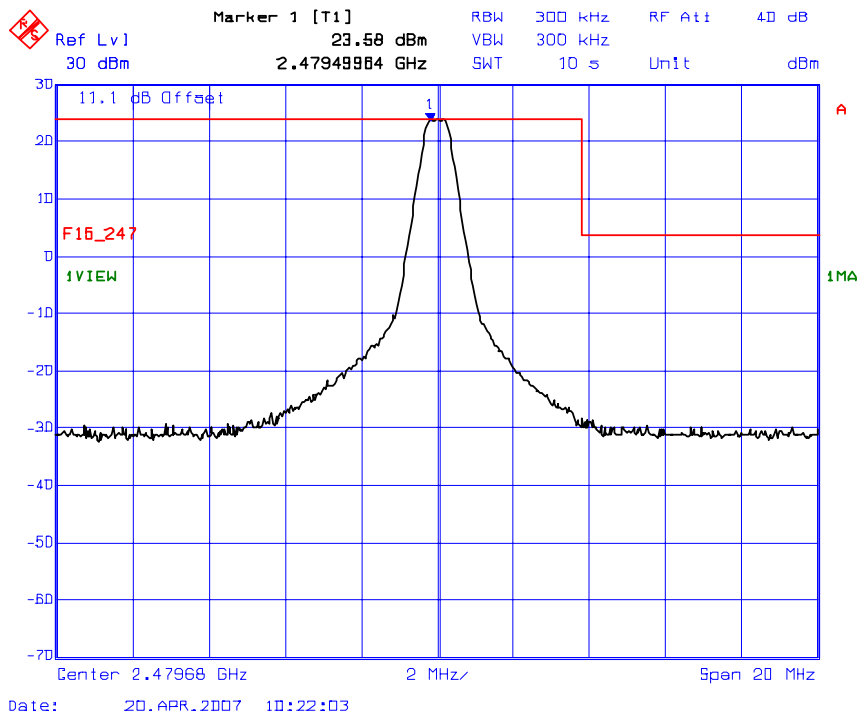

Plot 5.8.5.1.1.3.
Band-Edge RF Conducted Emissions
Low end of frequency band
Frequency hopping mode

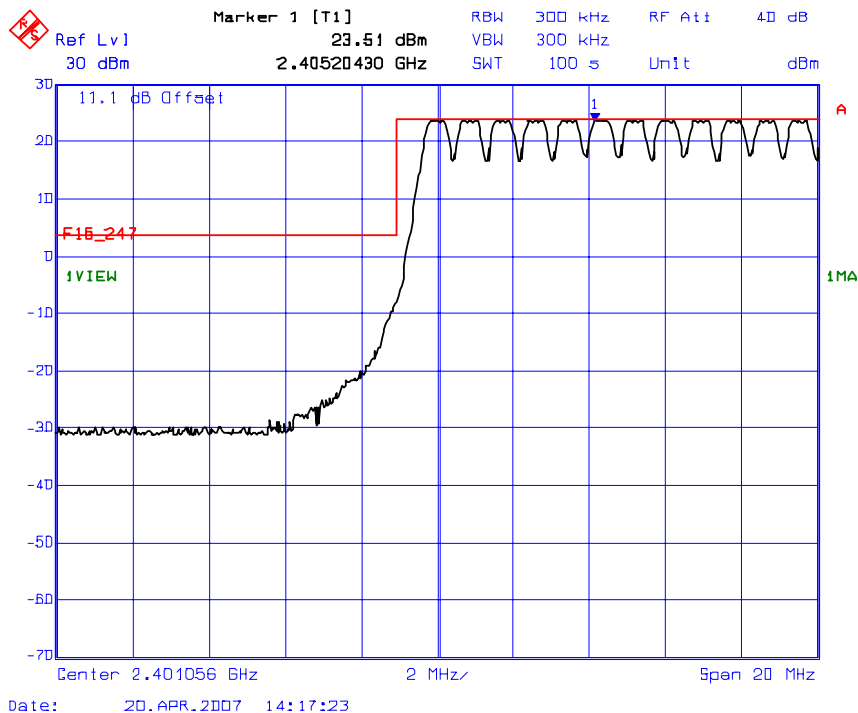

Plot 5.8.5.1.1.4.
Band-Edge RF Conducted Emissions
High end of frequency band
Frequency hopping mode

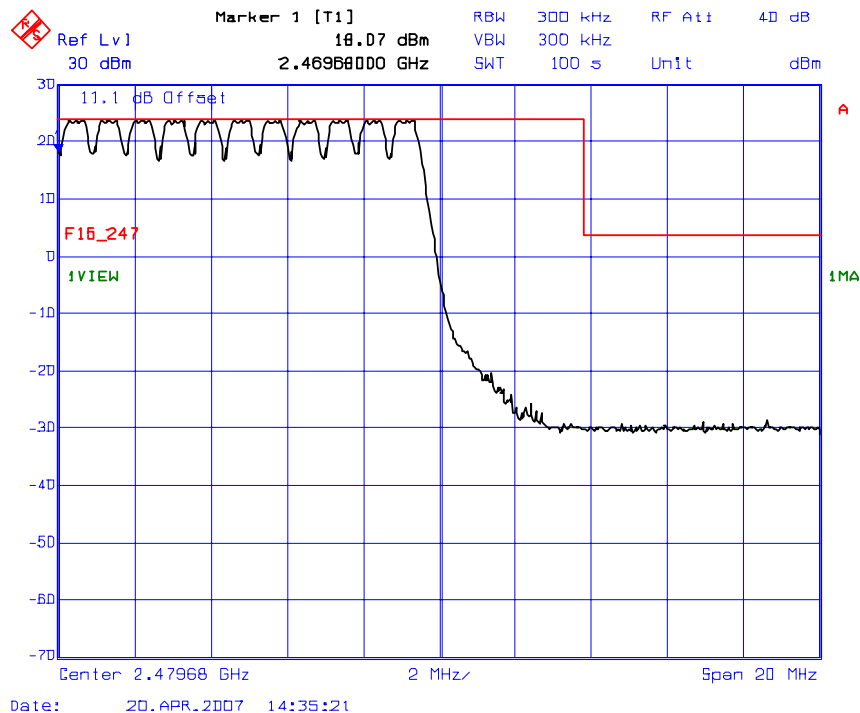

5.8.5.1.2. KX-TDA0152

See the following test data plots for measurement results:

Plot 5.8.5.1.2.1.
Band-Edge RF Conducted Emissions
Low end of frequency band
Single frequency mode

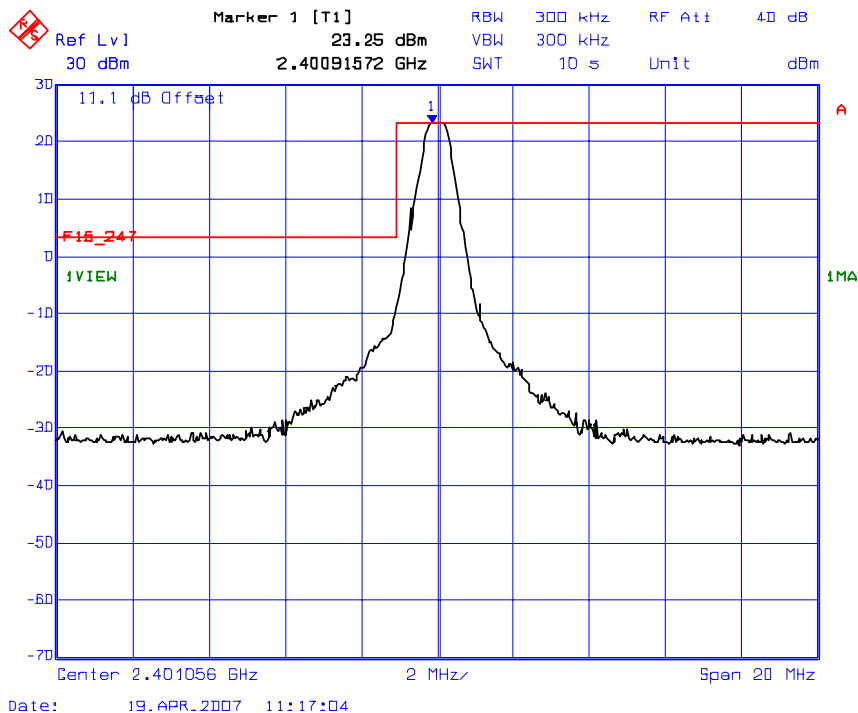

Plot 5.8.5.1.2.2.
Band-Edge RF Conducted Emissions
High end of frequency band
Single frequency mode

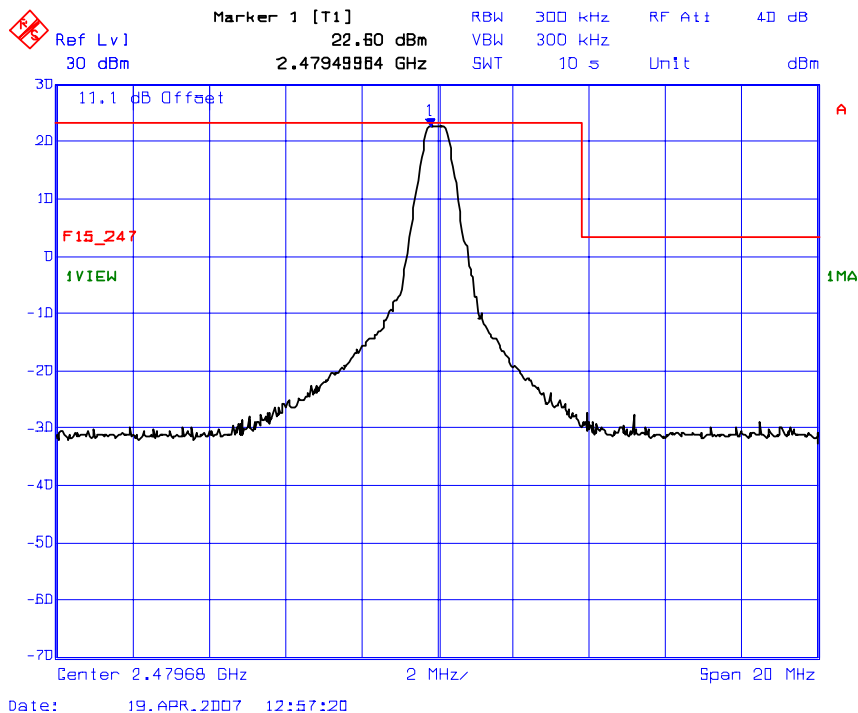

Plot 5.8.5.1.2.3.
Band-Edge RF Conducted Emissions
Low end of frequency band
Frequency hopping mode

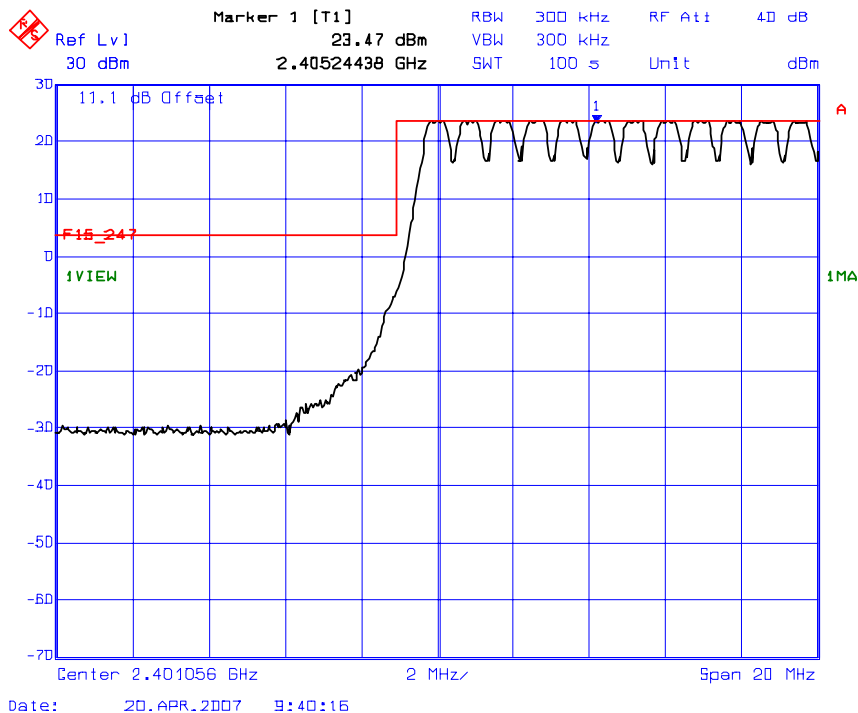

Plot 5.8.5.1.2.4.
Band-Edge RF Conducted Emissions
High end of frequency band
Frequency hopping mode

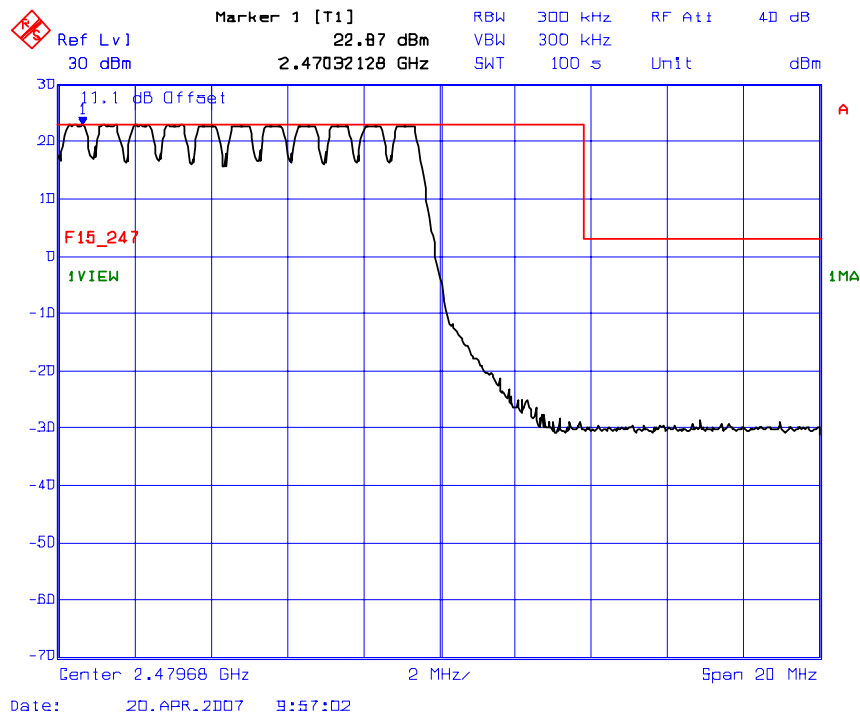

5.8.5.2. Spurious RF Conducted Emissions

5.8.5.2.1. KX-T0151, KX-TDA0151

The Emissions were scanned from 10 MHz to 25 GHz

Plot 5.8.5.2.1.1.
Spurious RF Conducted Emissions
Transmitter frequency: 2401.056 MHz at maximum power setting

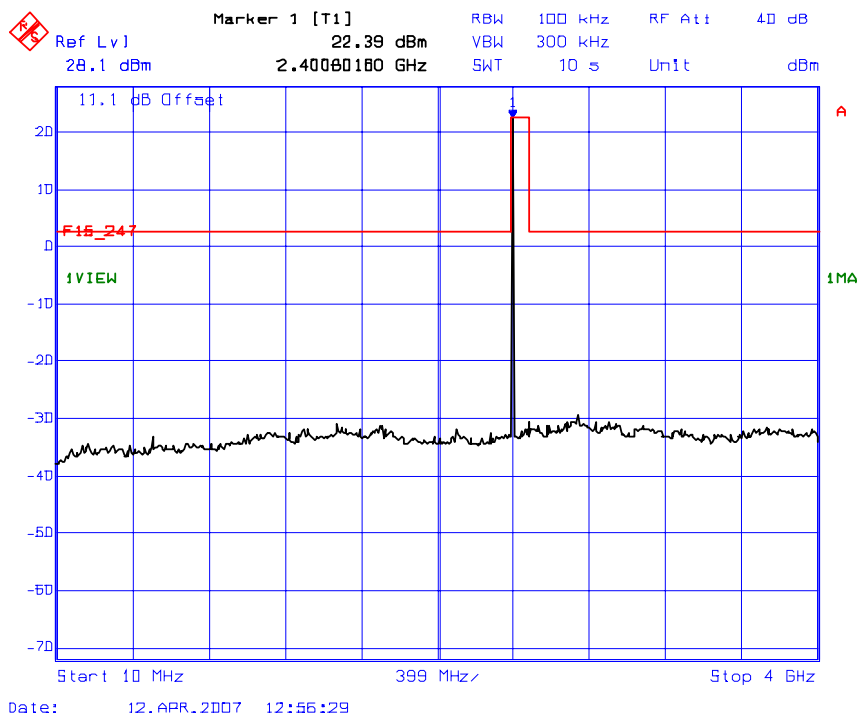

ULTRATECH GROUP OF LABS

3000 Bristol Circle, Oakville, Ontario, Canada L6H 6G4
Tel. #: 905-829-1570, Fax. #: 905-829-8050 Email: vic@ultratech-labs.com, Website: <http://www.ultratech-labs.com>

File #: PAN-078F15C247-B
May 24, 2007

All test results contained in this engineering test report are traceable to National Institute of Standards and Technology (NIST)

Plot 5.8.5.2.1.2.
Spurious RF Conducted Emissions
Transmitter frequency: 2401.056 MHz at maximum power setting

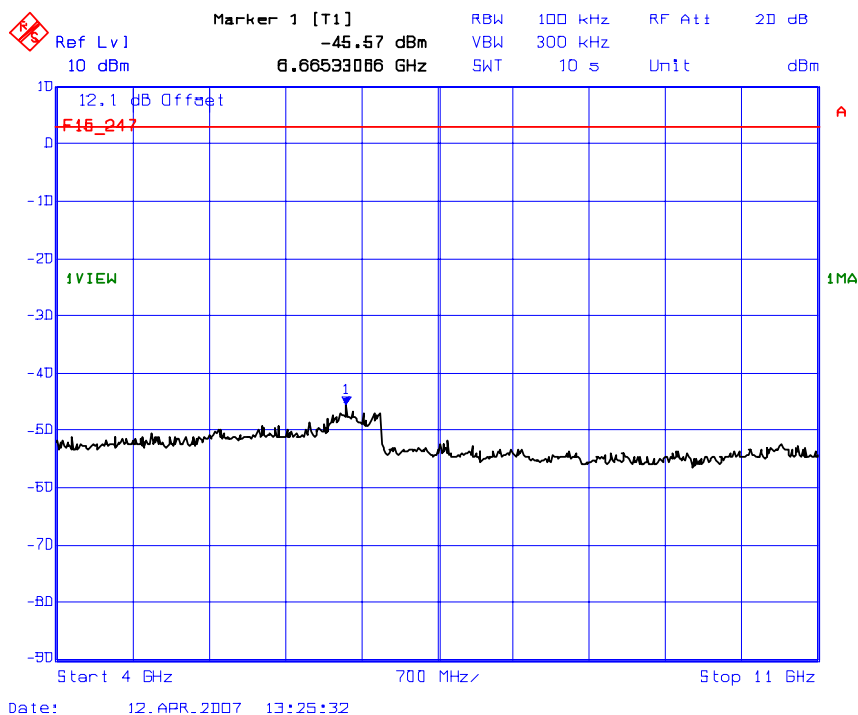

Plot 5.8.5.2.1.3.
Spurious RF Conducted Emissions
Transmitter frequency: 2401.056 MHz at maximum power setting

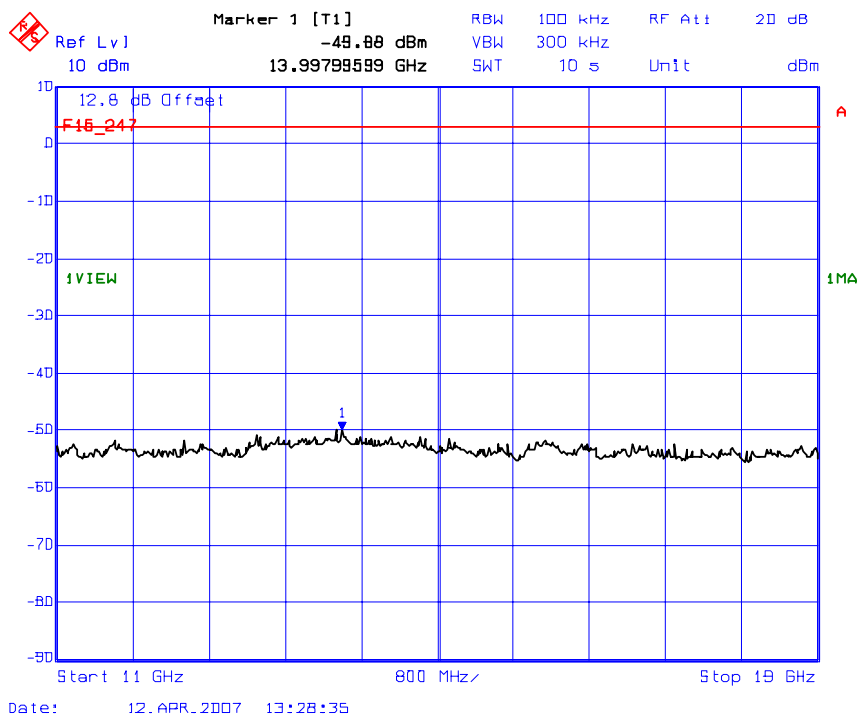

Plot 5.8.5.2.1.4.
Spurious RF Conducted Emissions
Transmitter frequency: 2401.056 MHz at maximum power setting

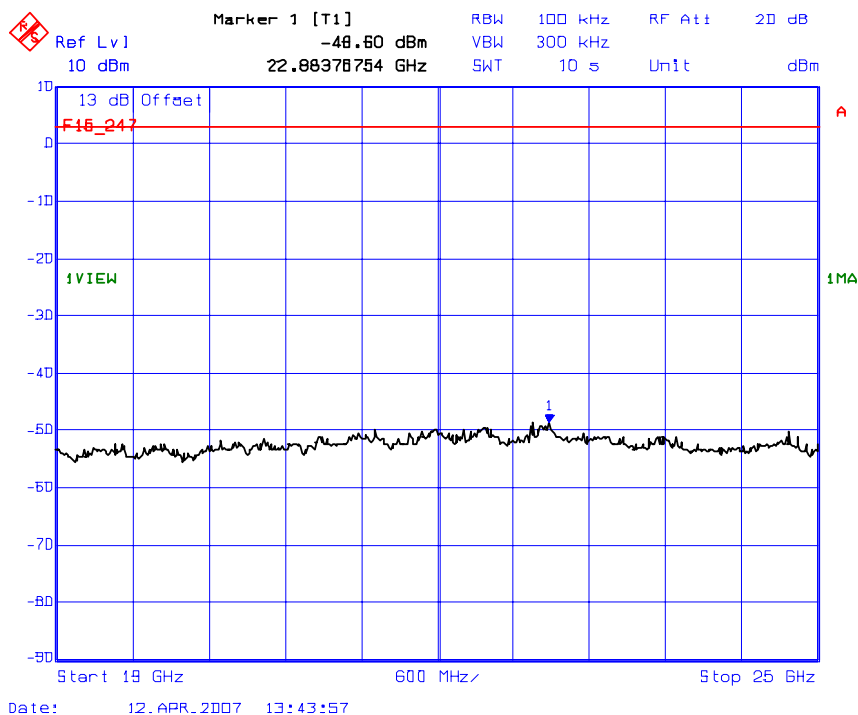

Plot 5.8.5.2.1.5.
Spurious RF Conducted Emissions
Transmitter frequency: 2440.800 MHz at maximum power setting

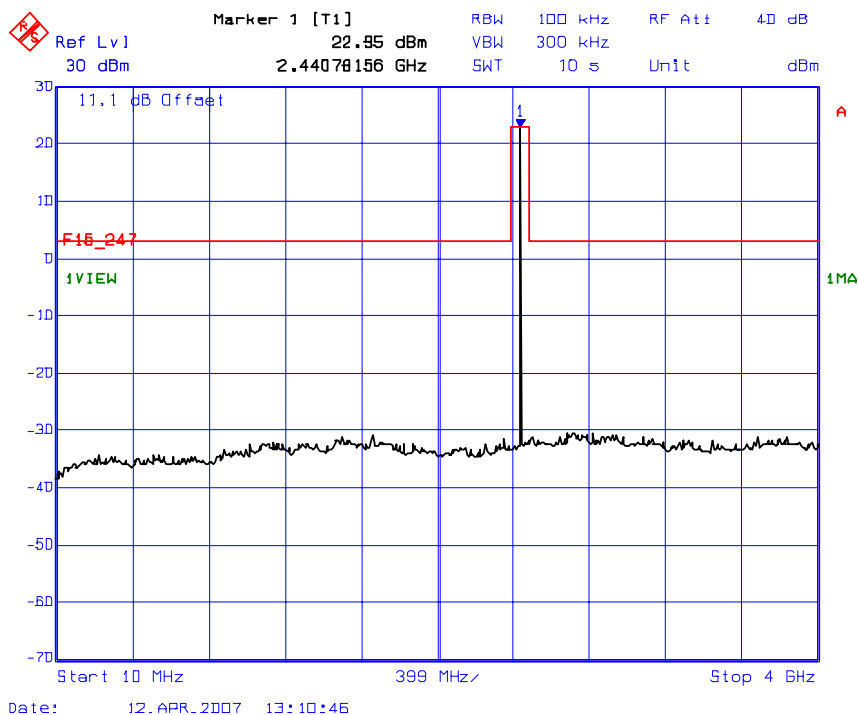

Plot 5.8.5.2.1.6.
Spurious RF Conducted Emissions
Transmitter frequency: 2440.800 MHz at maximum power setting

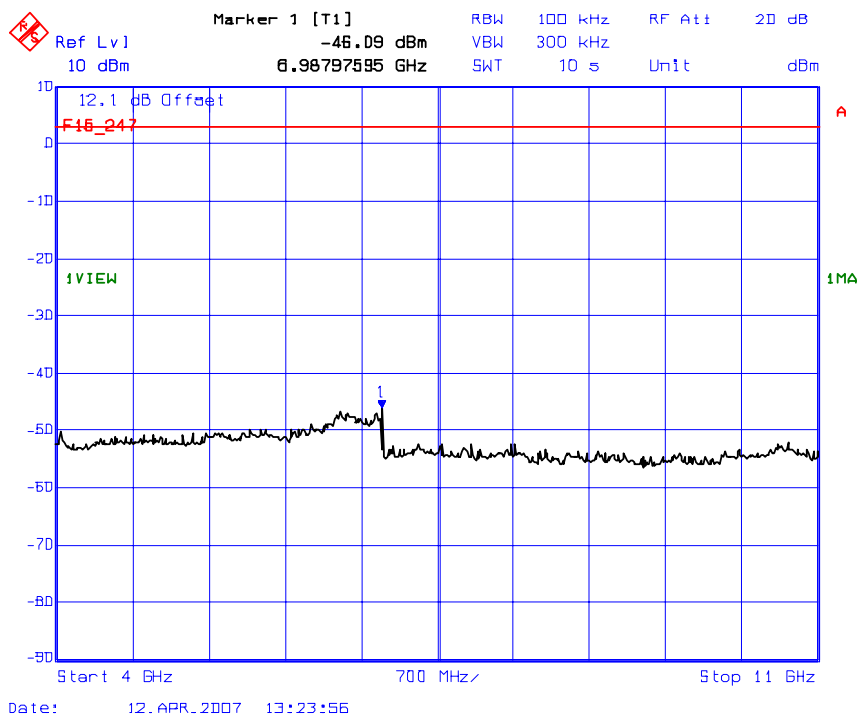

Plot 5.8.5.2.1.7.
Spurious RF Conducted Emissions
Transmitter frequency: 2440.800 MHz at maximum power setting

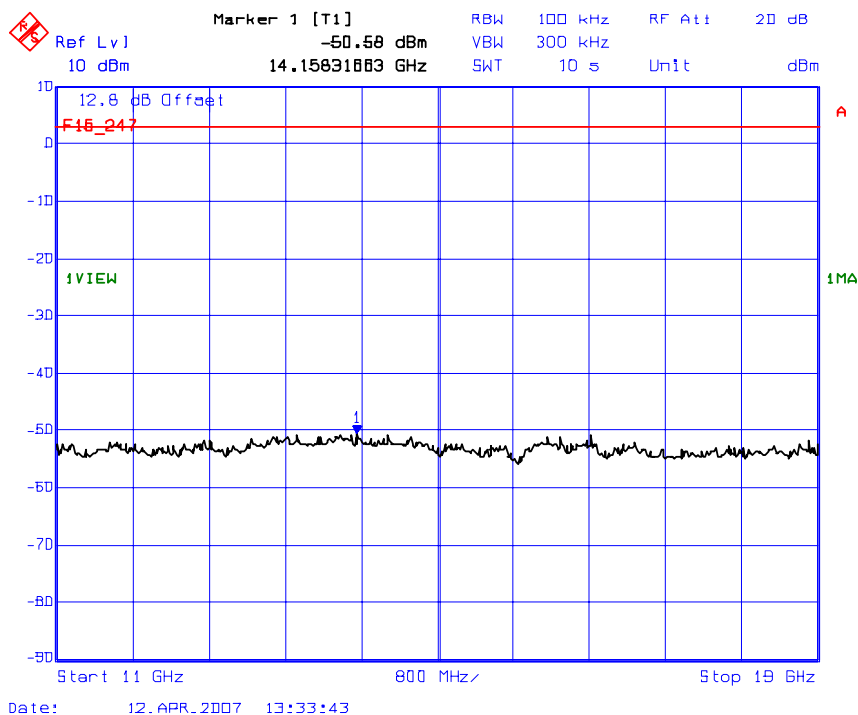

Plot 5.8.5.2.1.8.
Spurious RF Conducted Emissions
Transmitter frequency: 2440.800 MHz at maximum power setting

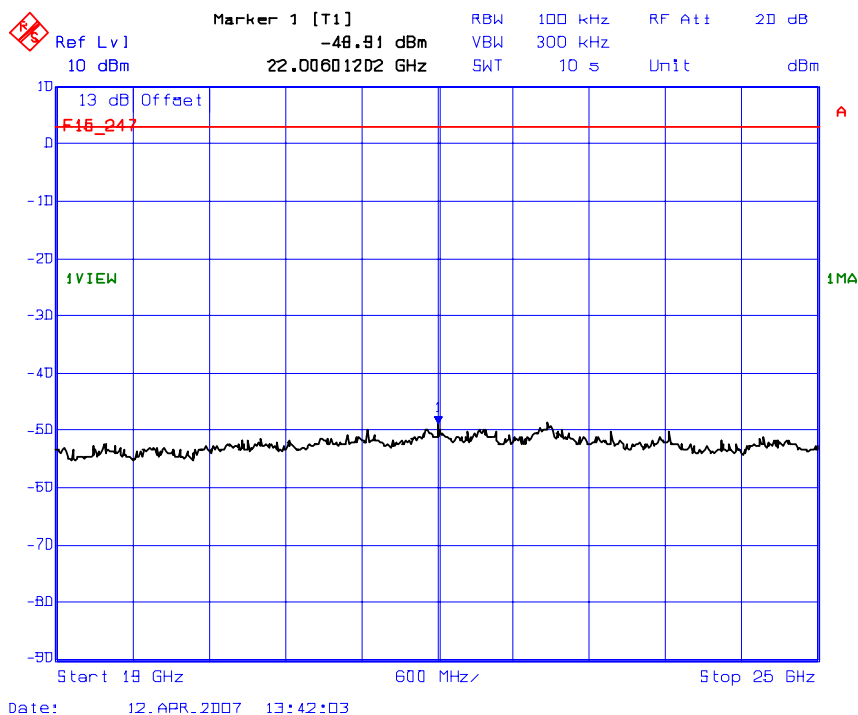

Plot 5.8.5.2.1.9.
Spurious RF Conducted Emissions
Transmitter frequency: 2479.680 MHz at maximum power setting

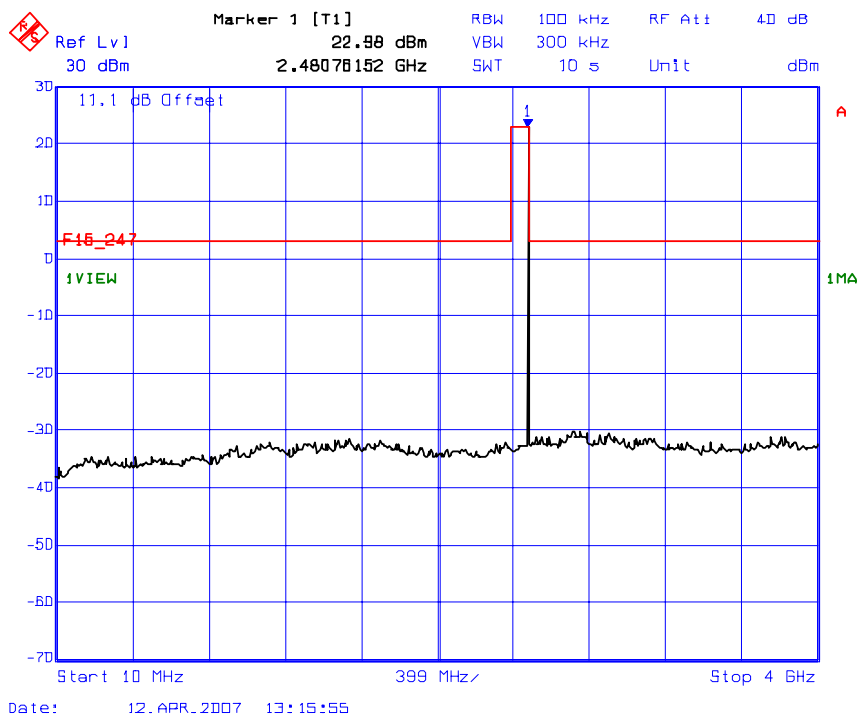

Plot 5.8.5.2.1.10.
Spurious RF Conducted Emissions
Transmitter frequency: 2479.680 MHz at maximum power setting

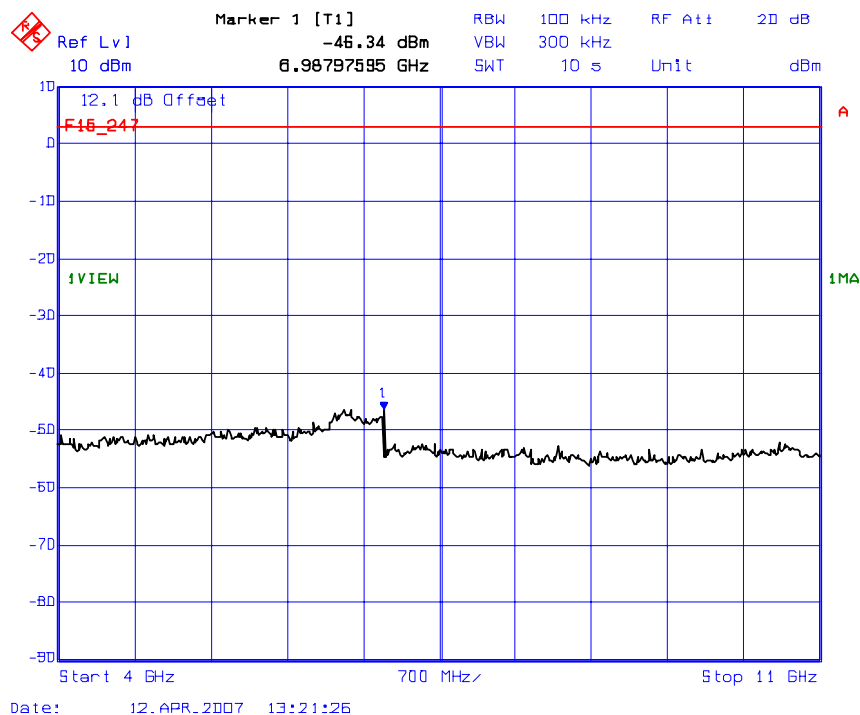

Plot 5.8.5.2.1.11.
Spurious RF Conducted Emissions
Transmitter frequency: 2479.680 MHz at maximum power setting

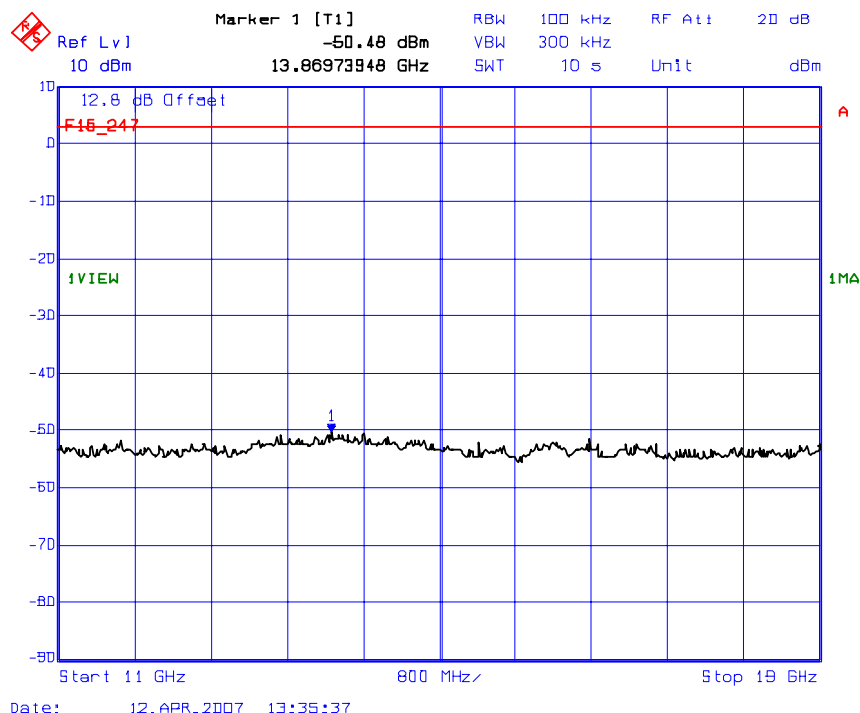

Plot 5.8.5.2.1.12.
Spurious RF Conducted Emissions
Transmitter frequency: 2479.680 MHz at maximum power setting

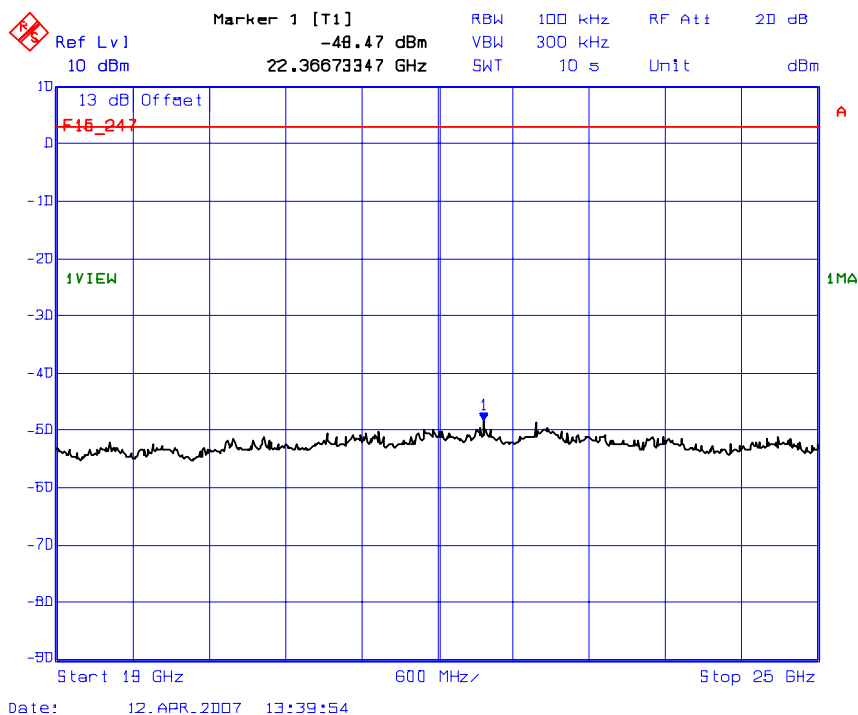

5.8.5.2.2. KX-TDA0152

The Emissions were scanned from 10 MHz to 25 GHz

Plot 5.8.5.2.2.1.
Spurious RF Conducted Emissions
Transmitter frequency: 2401.056 MHz at maximum power setting

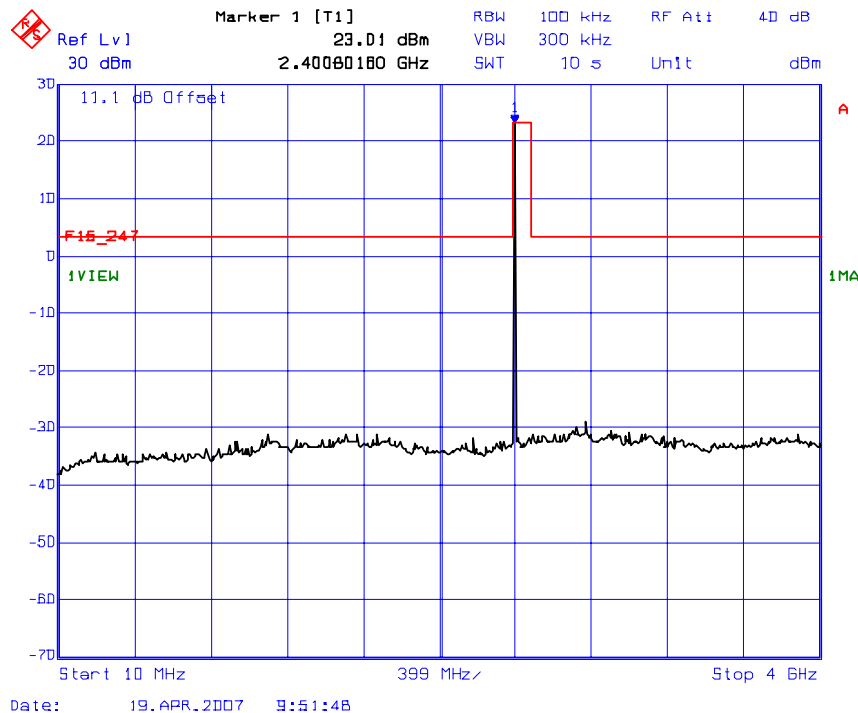

Plot 5.8.5.2.2.
Spurious RF Conducted Emissions
Transmitter frequency: 2401.056 MHz at maximum power setting

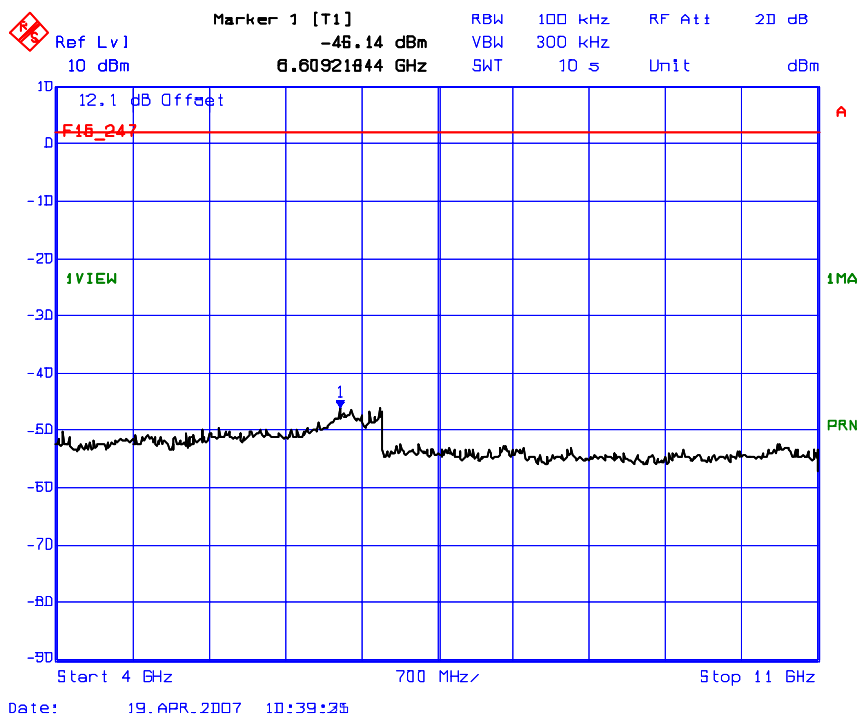

Plot 5.8.5.2.2.3.
Spurious RF Conducted Emissions
Transmitter frequency: 2401.056 MHz at maximum power setting

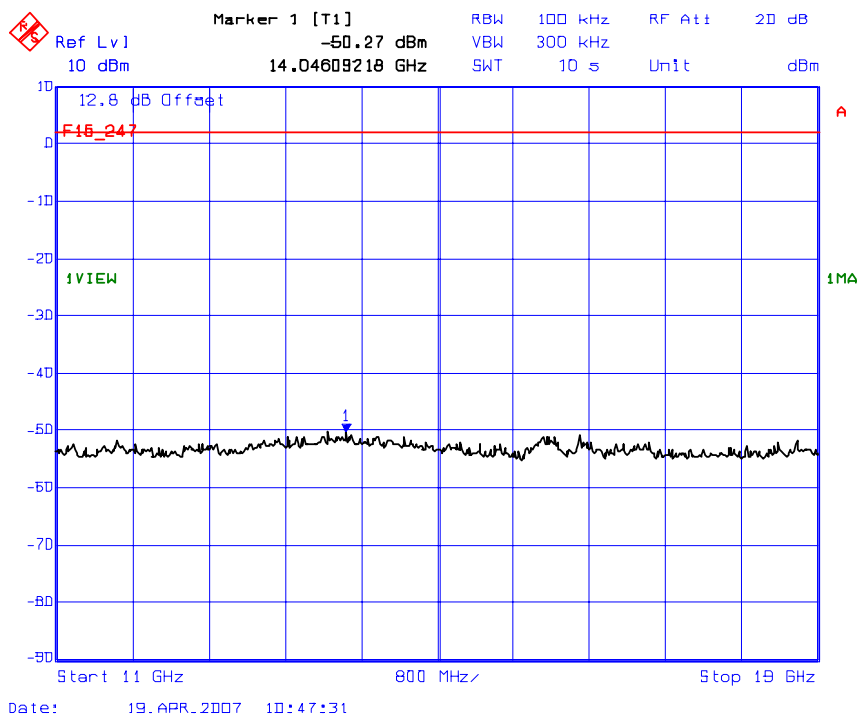

Plot 5.8.5.2.2.4.
Spurious RF Conducted Emissions
Transmitter frequency: 2401.056 MHz at maximum power setting

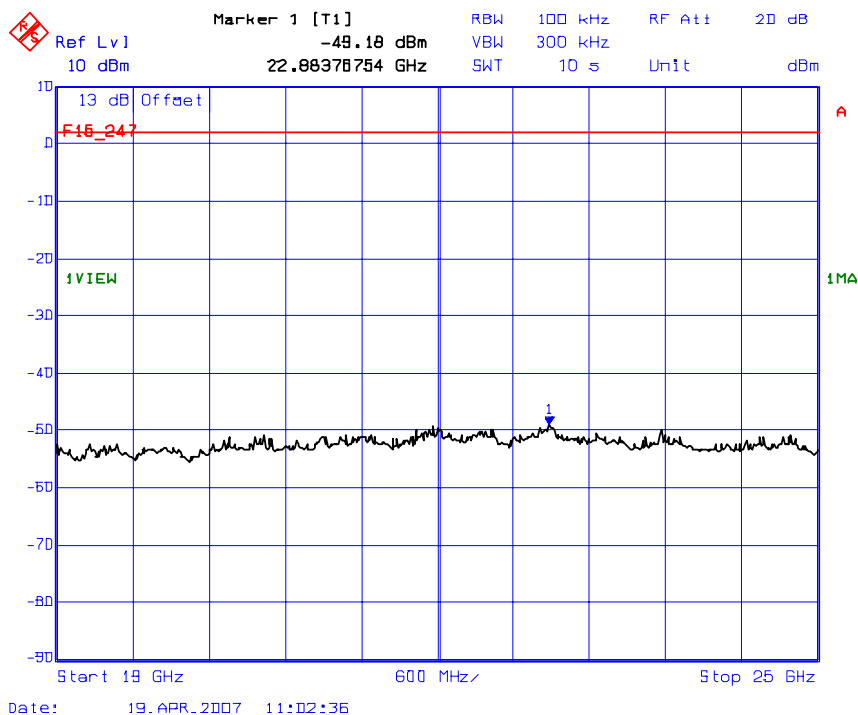

Plot 5.8.5.2.2.5.
Spurious RF Conducted Emissions
Transmitter frequency: 2440.800 MHz at maximum power setting

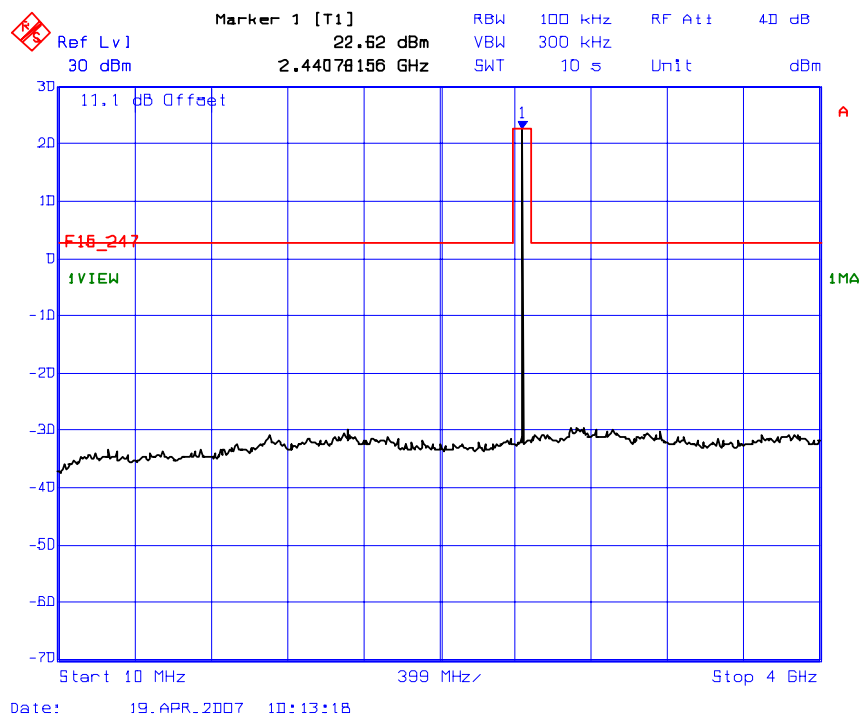

Plot 5.8.5.2.2.6.
Spurious RF Conducted Emissions
Transmitter frequency: 2440.800 MHz at maximum power setting

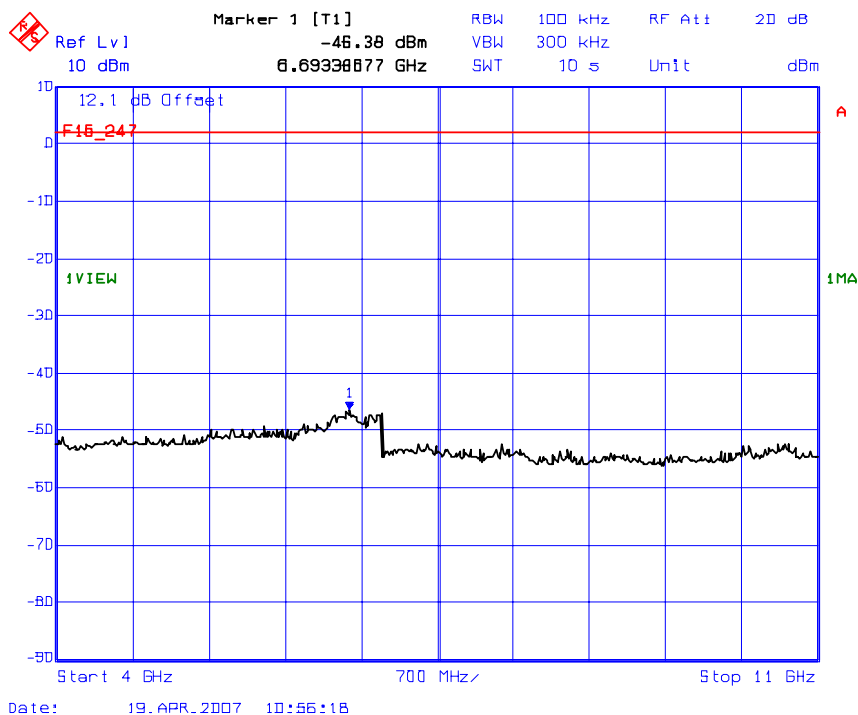

Plot 5.8.5.2.2.7.
Spurious RF Conducted Emissions
Transmitter frequency: 2440.800 MHz at maximum power setting

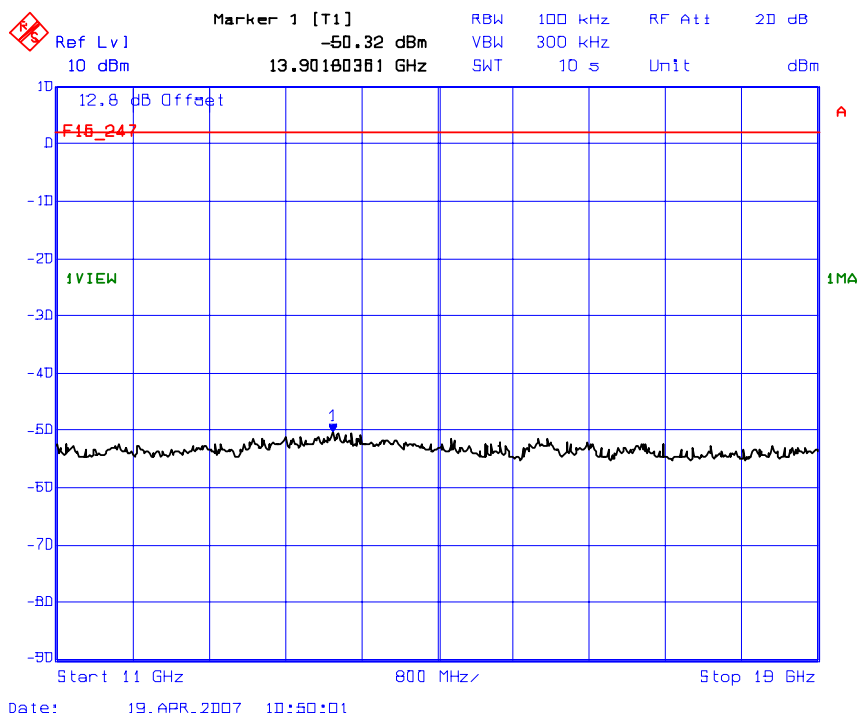

Plot 5.8.5.2.2.8.
Spurious RF Conducted Emissions
Transmitter frequency: 2440.800 MHz at maximum power setting

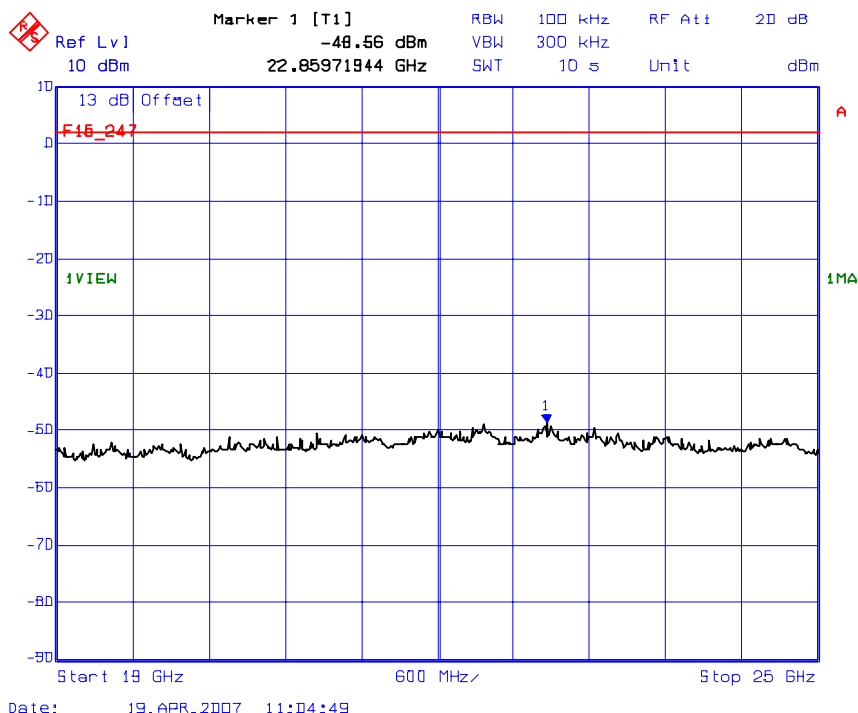

Plot 5.8.5.2.2.9.
Spurious RF Conducted Emissions
Transmitter frequency: 2479.680 MHz at maximum power setting

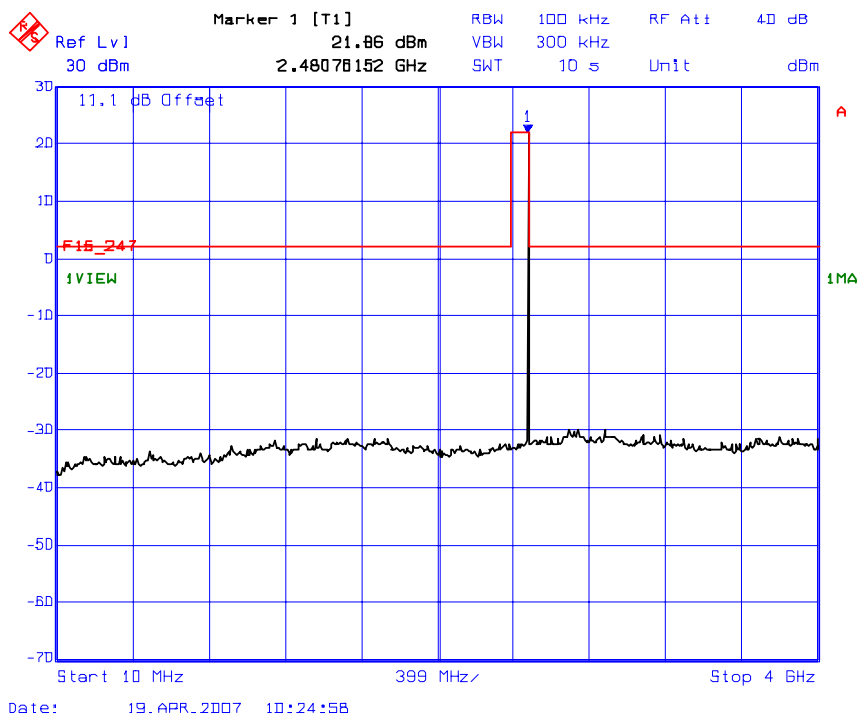

Plot 5.8.5.2.2.10.
Spurious RF Conducted Emissions
Transmitter frequency: 2479.680 MHz at maximum power setting

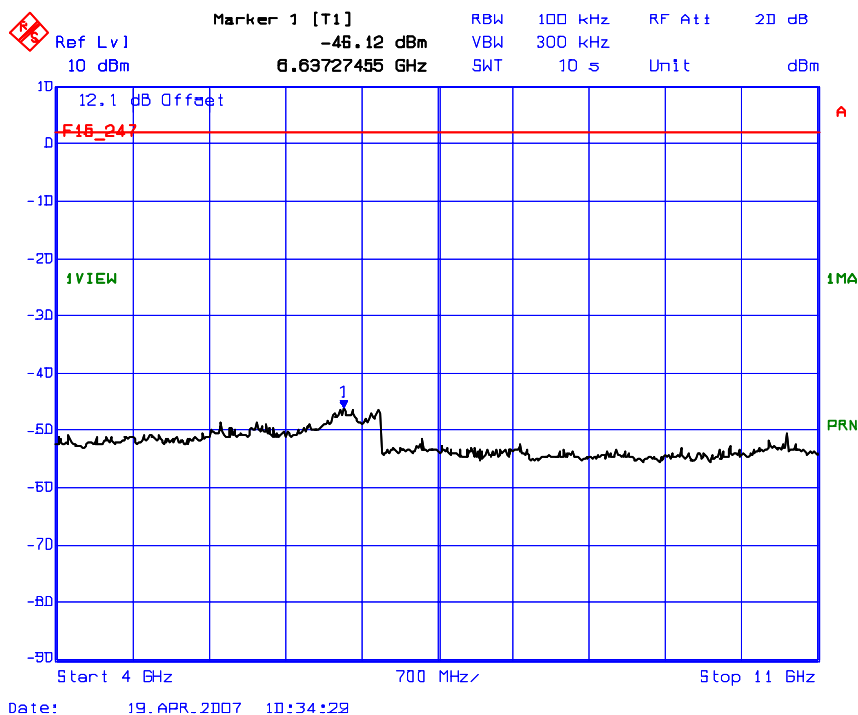

Plot 5.8.5.2.2.11.
Spurious RF Conducted Emissions
Transmitter frequency: 2479.680 MHz at maximum power setting

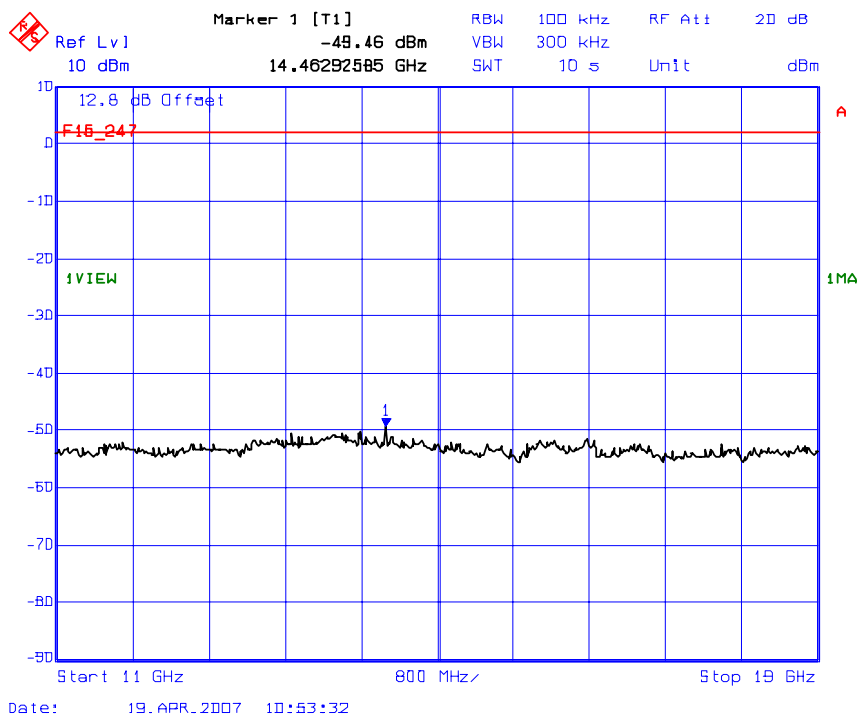

Plot 5.8.5.2.2.12.
Spurious RF Conducted Emissions
Transmitter frequency: 2479.680 MHz at maximum power setting

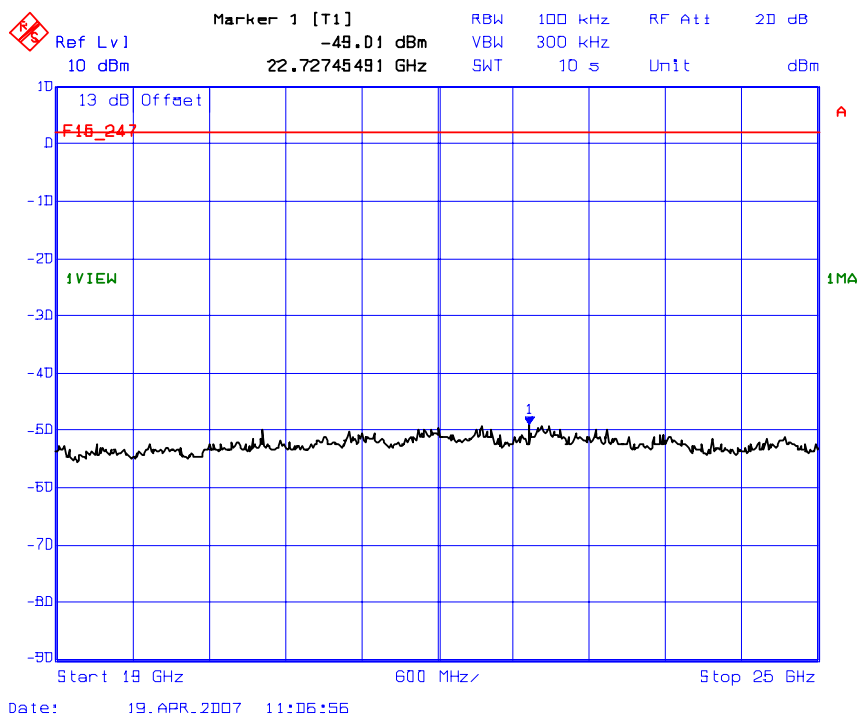

5.9. SPURIOUS RADIATED EMISSIONS @ 3 METERS [§ 15.247(d), §15.209 & §15.205]

5.9.1. Limits

FCC 15.247 (d): In any 100 kHz bandwidth outside the frequency band in which the spread spectrum or digitally modulated intentional radiator is operating, the radio frequency power that is produced by the intentional radiator shall be at least 20 dB below that in the 100 kHz bandwidth within the band that contains the highest level of the desired power, based on either an RF conducted or a radiated measurement, provided the transmitter demonstrates compliance with the peak conducted power limits. If the transmitter complies with the conducted power limits based on the use of RMS averaging over a time interval, as permitted under paragraph (b)(3) of this section, the attenuation required under this paragraph shall be 30 dB instead of 20 dB. Attenuation below the general limits specified in Section 15.209(a) is not required. In addition, radiated emissions which fall in the restricted bands, as defined in Section 15.205(a), must also comply with the radiated emission limits specified in Section 15.209(a) (see Section 15.205(c)).

47 CFR 15.205(a) - Restricted Bands of Operation

MHz	MHz	MHz	GHz
0.090 - 0.110	16.42 - 16.423	399.9 - 410	4.5 - 5.15
¹ 0.495 - 0.505	16.69475 - 16.69525	608 - 614	5.35 - 5.46
2.1735 - 2.1905	16.80425 - 16.80475	960 - 1240	7.25 - 7.75
4.125 - 4.128	25.5 - 25.67	1300 - 1427	8.025 - 8.5
4.17725 - 4.17775	37.5 - 38.25	1435 - 1626.5	9.0 - 9.2
4.20725 - 4.20775	73 - 74.6	1645.5 - 1646.5	9.3 - 9.5
6.215 - 6.218	74.8 - 75.2	1660 - 1710	10.6 - 12.7
6.26775 - 6.26825	108 - 121.94	1718.8 - 1722.2	13.25 - 13.4
6.31175 - 6.31225	123 - 138	2200 - 2300	14.47 - 14.5
8.291 - 8.294	149.9 - 150.05	2310 - 2390	15.35 - 16.2
8.362 - 8.366	156.52475 - 156.52525	2483.5 - 2500	17.7 - 21.4
8.37625 - 8.38675	156.7 - 156.9	2690 - 2900	22.01 - 23.12
8.41425 - 8.41475	162.0125 - 167.17	3260 - 3267	23.6 - 24.0
12.29 - 12.293	167.72 - 173.2	3332 - 3339	31.2 - 31.8
12.51975 - 12.52025	240 - 285	3345.8 - 3358	36.43 - 36.5
12.57675 - 12.57725	322 - 335.4	3600 - 4400	(2)
13.36 - 13.41			

¹ Until February 1, 1999, this restricted band shall be 0.490-0.510 MHz.

² Above 38.6

47 CFR 15.209(a) - Radiated emission limits, general requirements

Frequency (MHz)	Field Strength (microvolts/meter)	Measurement Distance (meters)
0.009 - 0.490	2400/F(kHz)	300
0.490 - 1.705	24000/F(kHz)	30
1.705 - 30.0	30	30
30 - 88	100 **	3
88 - 216	150 **	3
216 - 960	200 **	3
Above 960	500	3

** Except as provided in paragraph (g), fundamental emissions from intentional radiators operating under this Section shall not be located in the frequency bands 54-72 MHz, 76-88 MHz, 174-216 MHz or 470-806 MHz. However, operation within these frequency bands is permitted under other sections of this Part, e.g., Sections 15.231 and 15.241.

5.9.2. Method of Measurements

Refer to Ultratech Test Procedures, Files # ULTR P002-2004 or ULTR P003-2004 and ANSI C63.4 for measurement methods

5.9.3. Test Arrangement

Refer to Section 2.6 of this test report for test setup.

5.9.4. Test Equipment List

Test Instruments	Manufacturer	Model No.	Serial No.	Frequency Range
Spectrum Analyzer	Rohde & Schwarz	FSEK20/B4/B21	834157/005	9 kHz- 40 GHz
Microwave Amplifier	Hewlett Packard	HP 83017A		1 GHz to 26.5 GHz
Biconilog Antenna	EMCO	3143	1029	20 MHz to 2 GHz
Horn Antenna	EMCO	3155	9701-5061	1 GHz – 18 GHz
Horn Antenna	EMCO	3160-09	..	18 GHz – 26.5 GHz
Horn Antenna	EMCO	3160-10	..	26.5 GHz – 40 GHz
Mixer	Tektronix	118-0098-00	..	18 GHz – 26.5 GHz
Mixer	Tektronix	119-0098-00	..	26.5 GHz – 40 GHz

5.9.5. Test Data

5.9.5.1. Band-edge Radiated Emissions

5.9.5.1.1. KX-T0151, KX-TDA0151

Plot 5.9.5.1.1.1. Band-Edge Radiated Emissions @ 3 meters
Vertical Polarization, Low End of Frequency Band, Single Frequency Mode

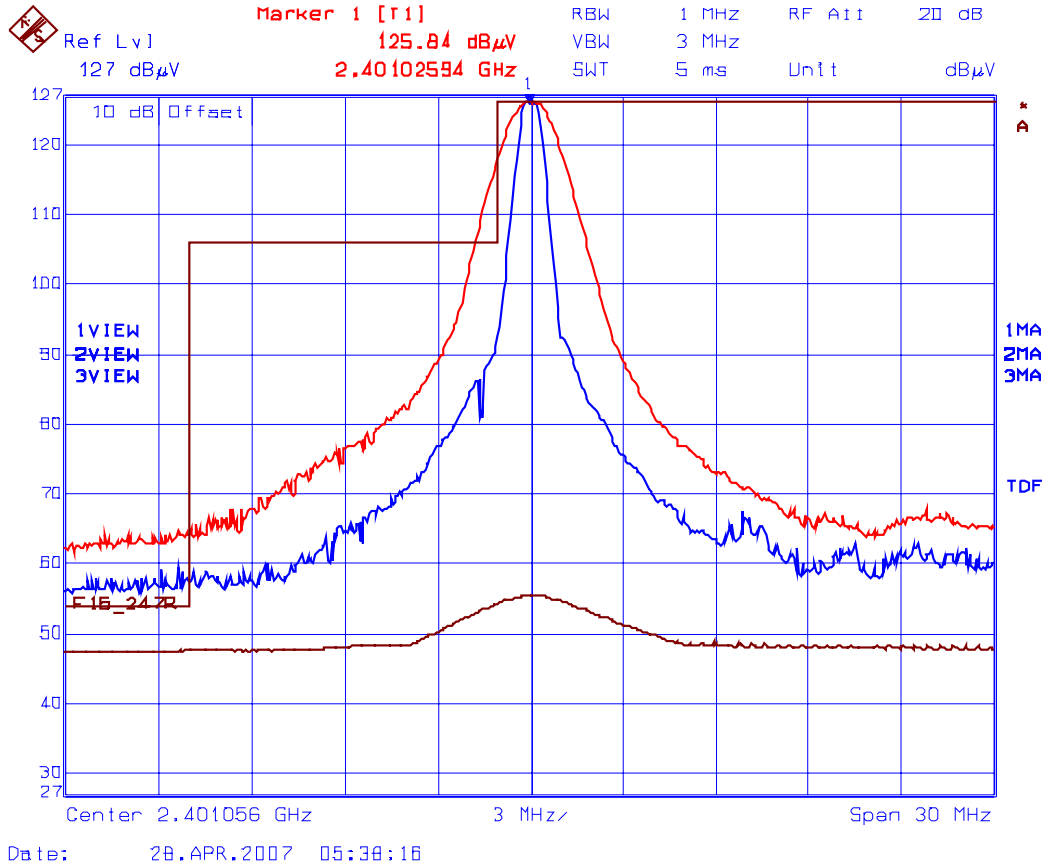

Trace 1: RBW= 1 MHz, VBW= 3 MHz
Trace 2: RBW= 300 kHz, VBW= 1 MHz
Trace 3: RBW= 1 MHz, VBW= 10 Hz

Plot 5.9.5.1.1.2. Band-Edge Radiated Emissions @ 3 meters
 Horizontal Polarization Low End of Frequency Band, Single Frequency Mode

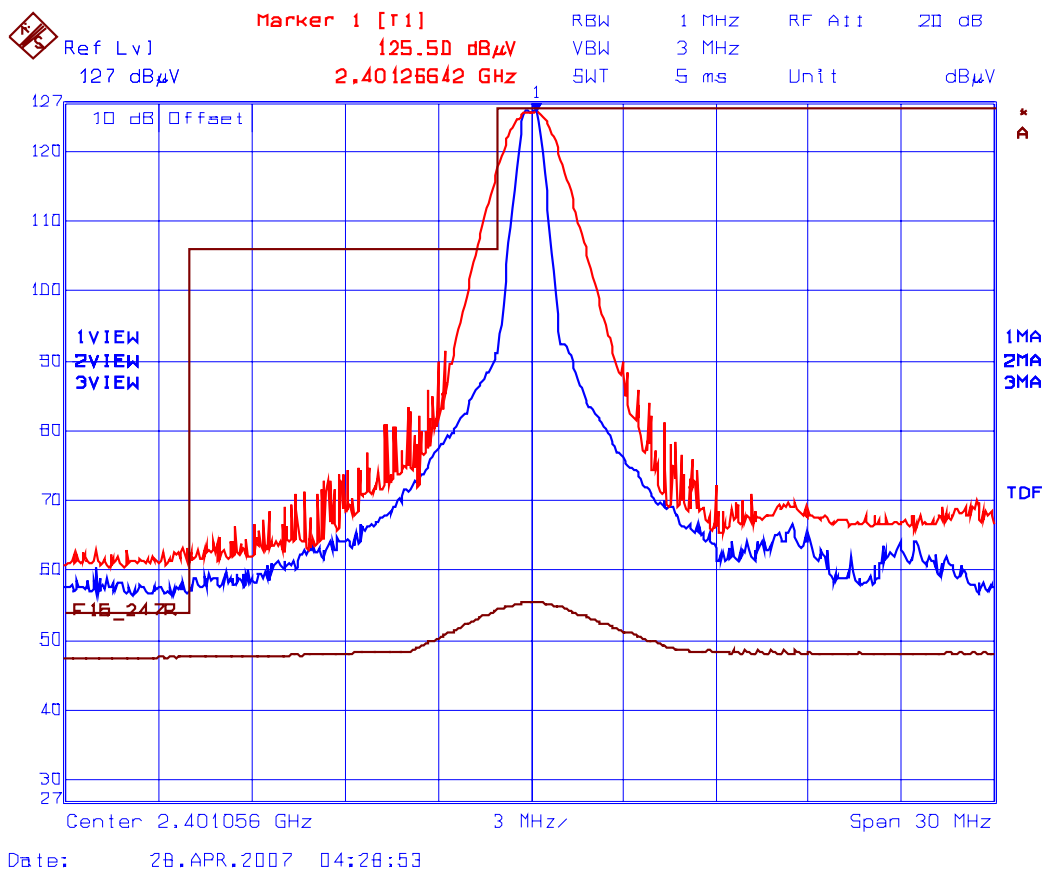

Trace 1: RBW= 1 MHz, VBW= 3 MHz
 Trace 2: RBW= 300 kHz, VBW= 1 MHz
 Trace 3: RBW= 1 MHz, VBW= 10 Hz

Plot 5.9.5.1.1.3. Band-Edge Radiated Emissions @ 3 meters
 Vertical Polarization Low End of Frequency Band, Pseudorandom Channel Hopping Mode

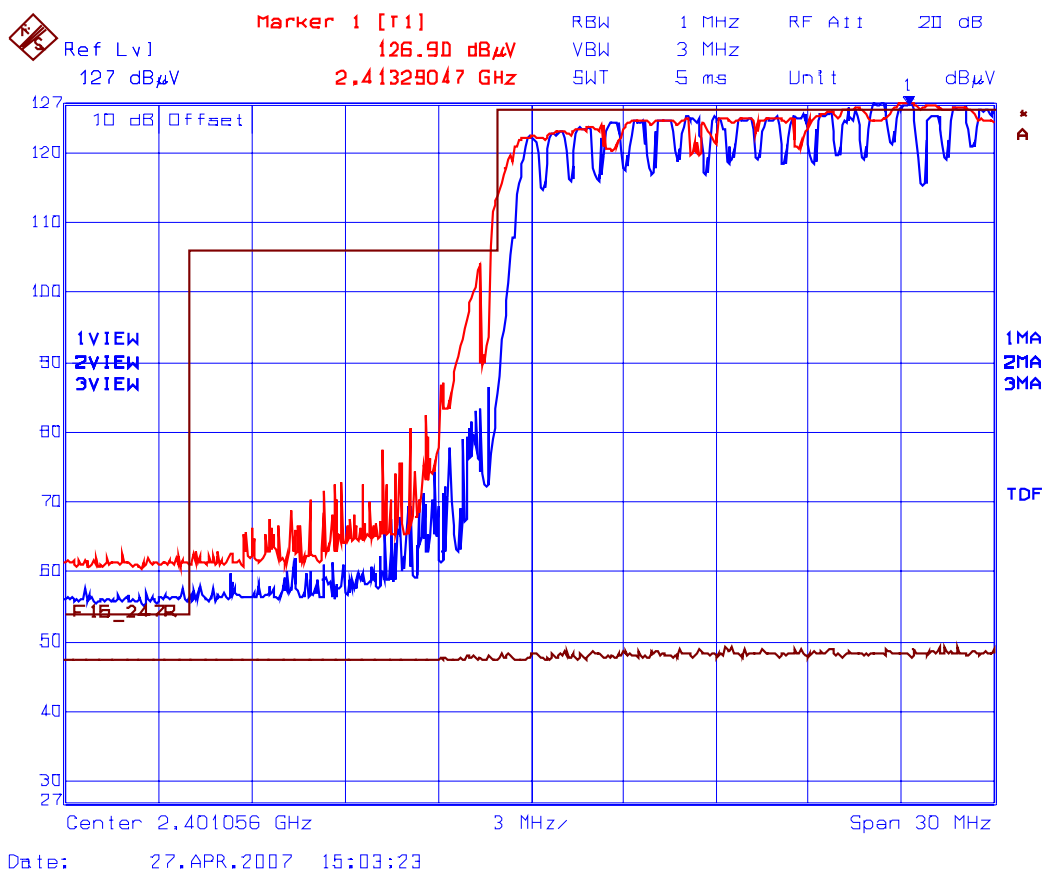

Trace 1: RBW= 1 MHz, VBW= 3 MHz
 Trace 2: RBW= 300 kHz, VBW= 1 MHz
 Trace 3: RBW= 1 MHz, VBW= 10 Hz

Plot 5.9.5.1.1.4. Band-Edge Radiated Emissions @ 3 meters
Horizontal Polarization, Low End of Frequency Band, Pseudorandom Channel Hopping Mode

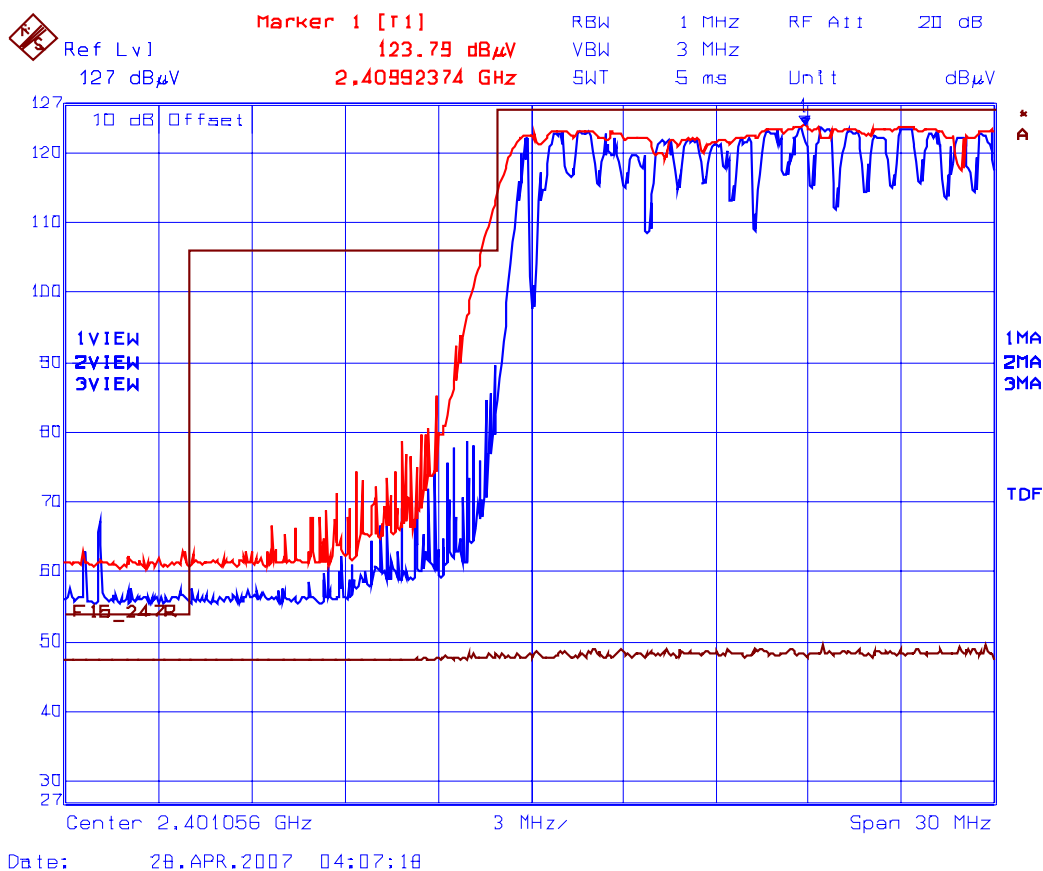

Trace 1: RBW= 1 MHz, VBW= 3 MHz
Trace 2: RBW= 300 kHz, VBW= 1 MHz
Trace 3: RBW= 1 MHz, VBW= 10 Hz

Plot 5.9.5.1.1.5. Band-Edge Radiated Emissions @ 3 meters
Vertical Polarization, Upper End of Frequency Band, Single Frequency Mode

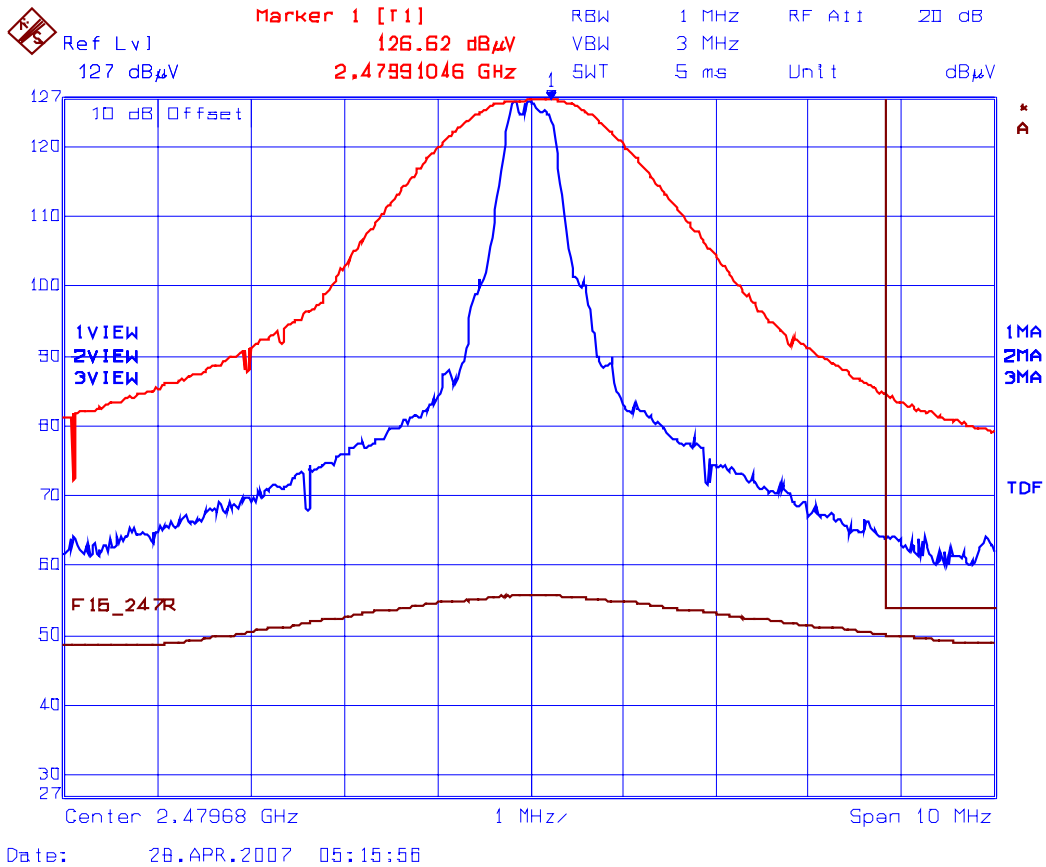

Trace 1: RBW= 1 MHz, VBW= 3 MHz
Trace 2: RBW= 300 kHz, VBW= 1 MHz
Trace 3: RBW= 1 MHz, VBW= 10 Hz

Plot 5.9.5.1.1.6. Band-Edge Radiated Emissions @ 3 meters
Vertical Polarization, Upper End of Frequency Band, Single Frequency Mode

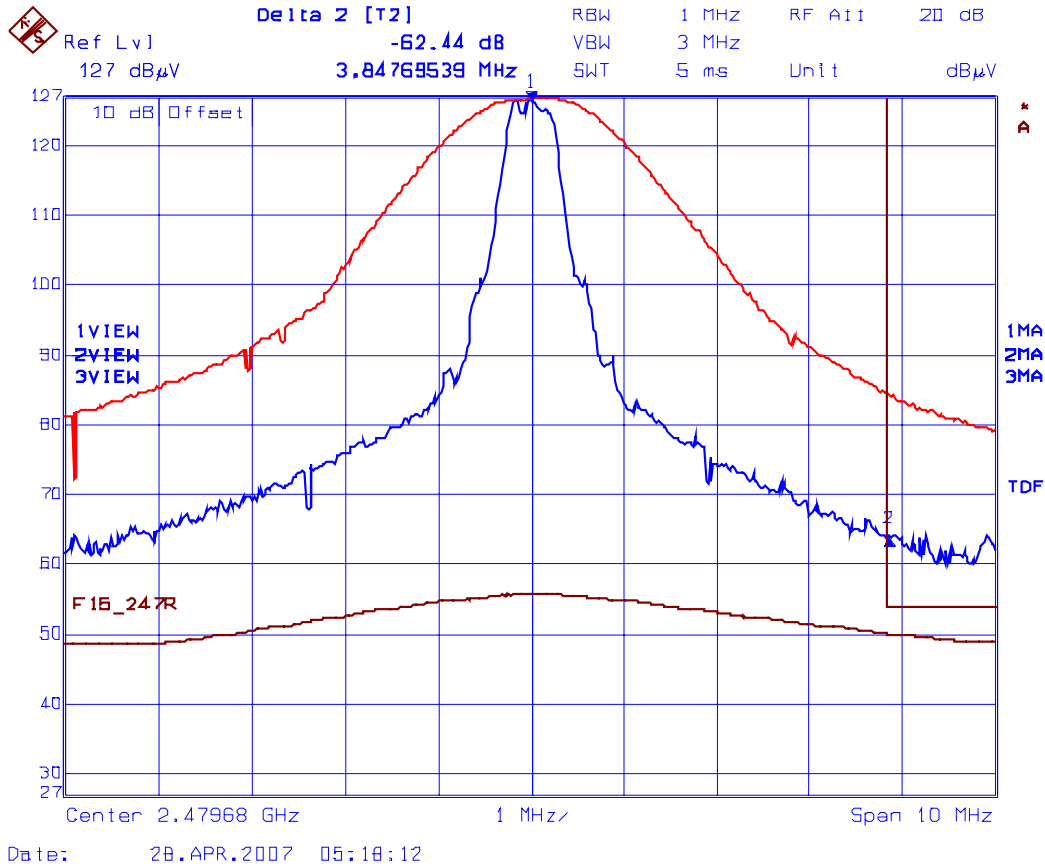

Trace 1: RBW= 1 MHz, VBW= 3 MHz
Trace 2: RBW= 300 kHz, VBW= 1 MHz (Peak to Band-Edge): 62.44 dB
Trace 3: RBW= 1 MHz, VBW= 10 Hz
Band-Edge Level at 2483.5 MHz: 126.62dBuV/m – 62.44 dB= 64.18dBuV/m

Plot 5.9.5.1.1.7. Band-Edge Radiated Emissions @ 3 meters
Horizontal Polarization, Upper End of Frequency Band, Single Frequency Mode

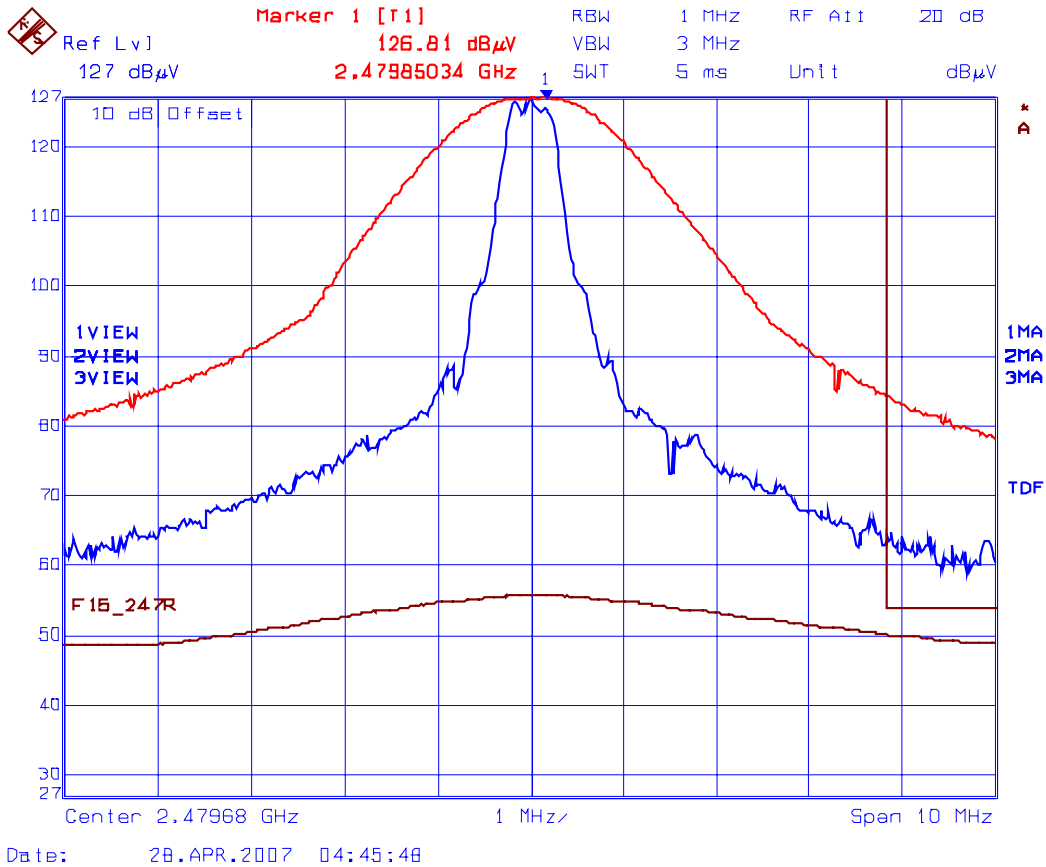

Trace 1: RBW= 1 MHz, VBW= 3 MHz
Trace 2: RBW= 300 kHz, VBW= 1 MHz
Trace 3: RBW= 1 MHz, VBW= 10 Hz

Plot 5.9.5.1.1.8. Band-Edge Radiated Emissions @ 3 meters
 Horizontal Polarization, Upper End of Frequency Band, Single Frequency Mode

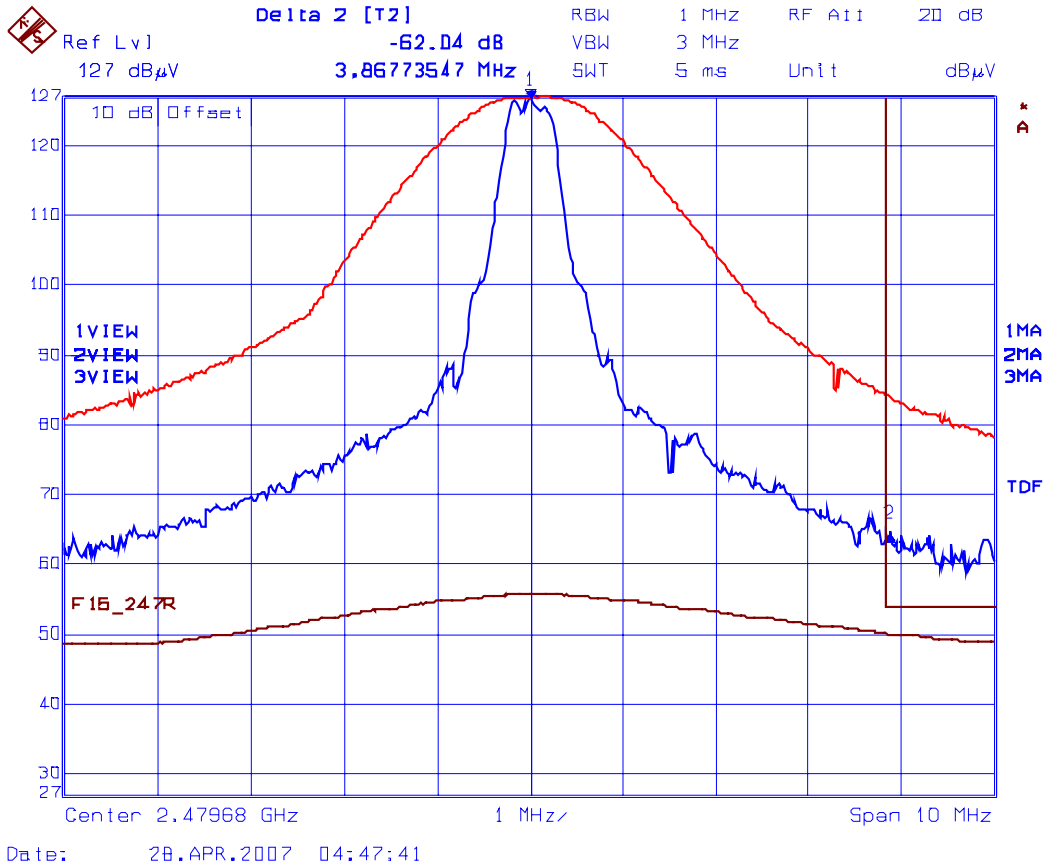

Trace 1: RBW= 1 MHz, VBW= 3 MHz
 Trace 2: RBW= 300 kHz, VBW= 1 MHz (Peak to Band-Edge): 62.04 dB
 Trace 3: RBW= 1 MHz, VBW= 10 Hz
 Band-Edge Level at 2483.5 MHz: 126.81dBuV/m – 62.04 dB= 64.77dBuV/m

Plot 5.9.5.1.1.9. Band-Edge Radiated Emissions @ 3 meters
Vertical Polarization, Upper End of Frequency Band, Pseudorandom Channel Hopping Mode

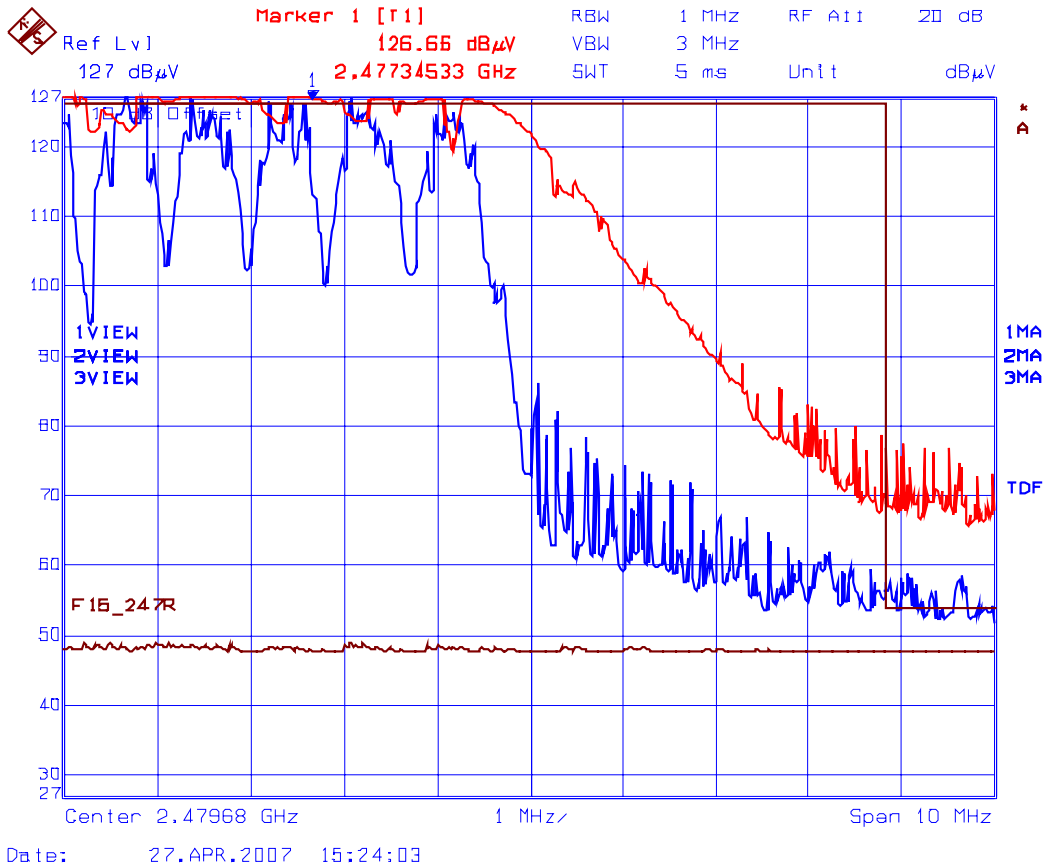

Trace 1: RBW= 1 MHz, VBW= 3 MHz
Trace 2: RBW= 300 kHz, VBW= 1 MHz
Trace 3: RBW= 1 MHz, VBW= 10 Hz

Plot 5.9.5.1.1.10. Band-Edge Radiated Emissions @ 3 meters
 Vertical Polarization, Upper End of Frequency Band, Pseudorandom Channel Hopping Mode

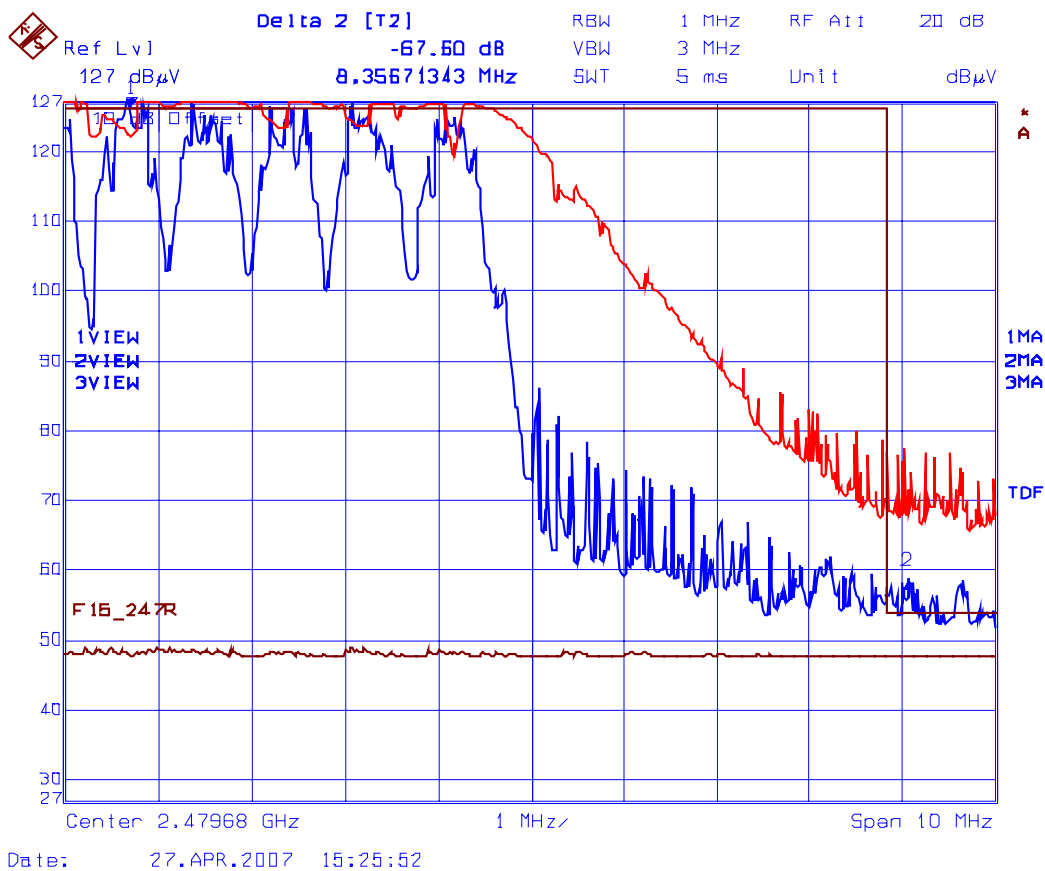

Trace 1: RBW= 1 MHz, VBW= 3 MHz
 Trace 2: RBW= 300 kHz, VBW= 1 MHz (Peak to Band-Edge): 67.60 dB
 Trace 3: RBW= 1 MHz, VBW= 10 Hz
 Band-Edge Level at 2483.5 MHz: 126.66dBuV/m – 67.60 dB= 59.06dBuV/m

Plot 5.9.5.1.1.11. Band-Edge Radiated Emissions @ 3 meters
 Horizontal Polarization, Upper End of Frequency Band, Pseudorandom Channel Hopping Mode

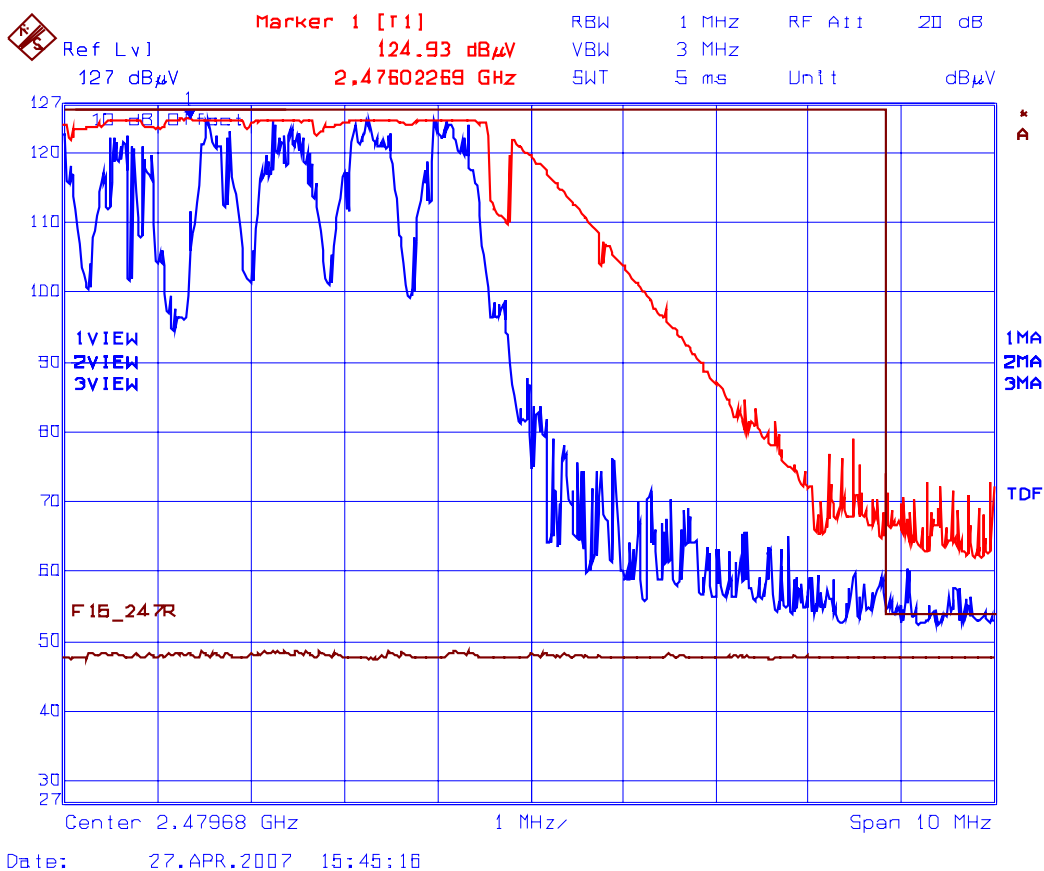

Trace 1: RBW= 1 MHz, VBW= 3 MHz
 Trace 2: RBW= 300 kHz, VBW= 1 MHz
 Trace 3: RBW= 1 MHz, VBW= 10 Hz

Plot 5.9.5.1.1.12. Band-Edge Radiated Emissions @ 3 meters
Horizontal Polarization, Upper End of Frequency Band, Pseudorandom Channel Hopping Mode

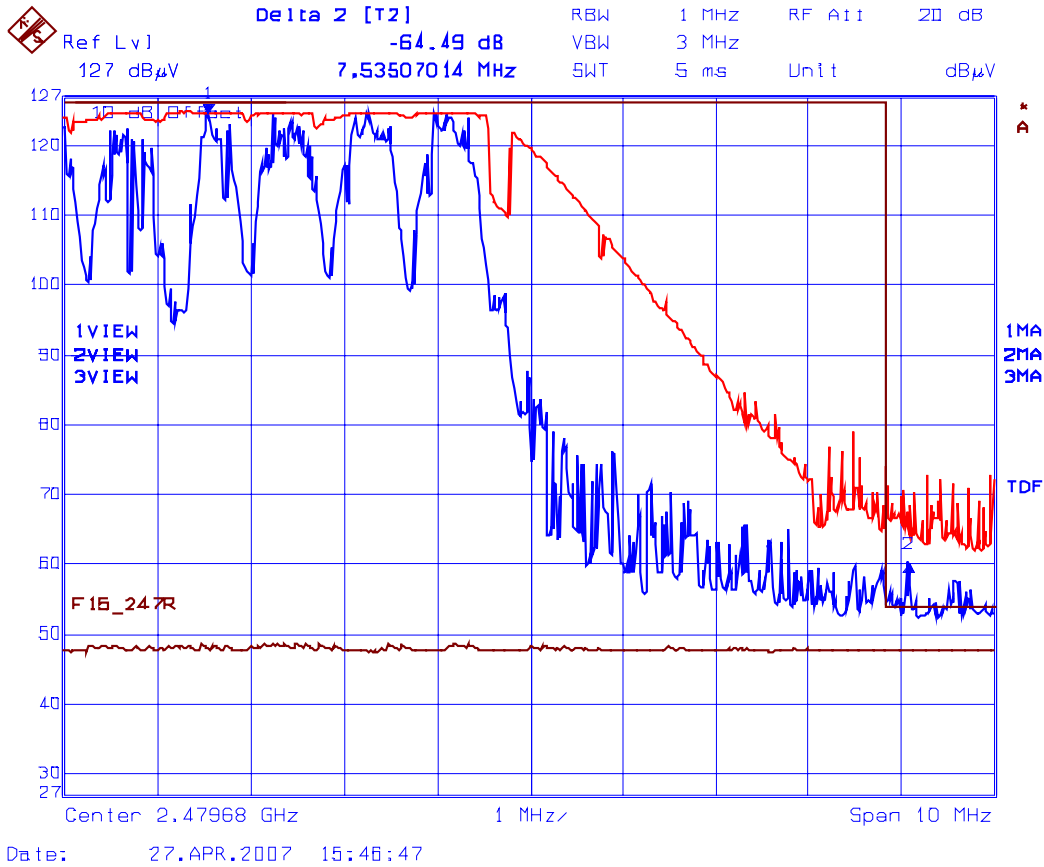

Trace 1: RBW= 1 MHz, VBW= 3 MHz
Trace 2: RBW= 300 kHz, VBW= 1 MHz (Peak to Band-Edge): 64.49 dB
Trace 3: RBW= 1 MHz, VBW= 10 Hz
Band-Edge Level at 2483.5 MHz: 124.93dBuV/m – 64.49 dB= 60.44dBuV/m

5.9.5.1.2. KX-TDA0152

Plot 5.9.5.1.2.1. Band-Edge Radiated Emissions @ 3 meters
Vertical Polarization, Low End of Frequency Band, Single Frequency Mode

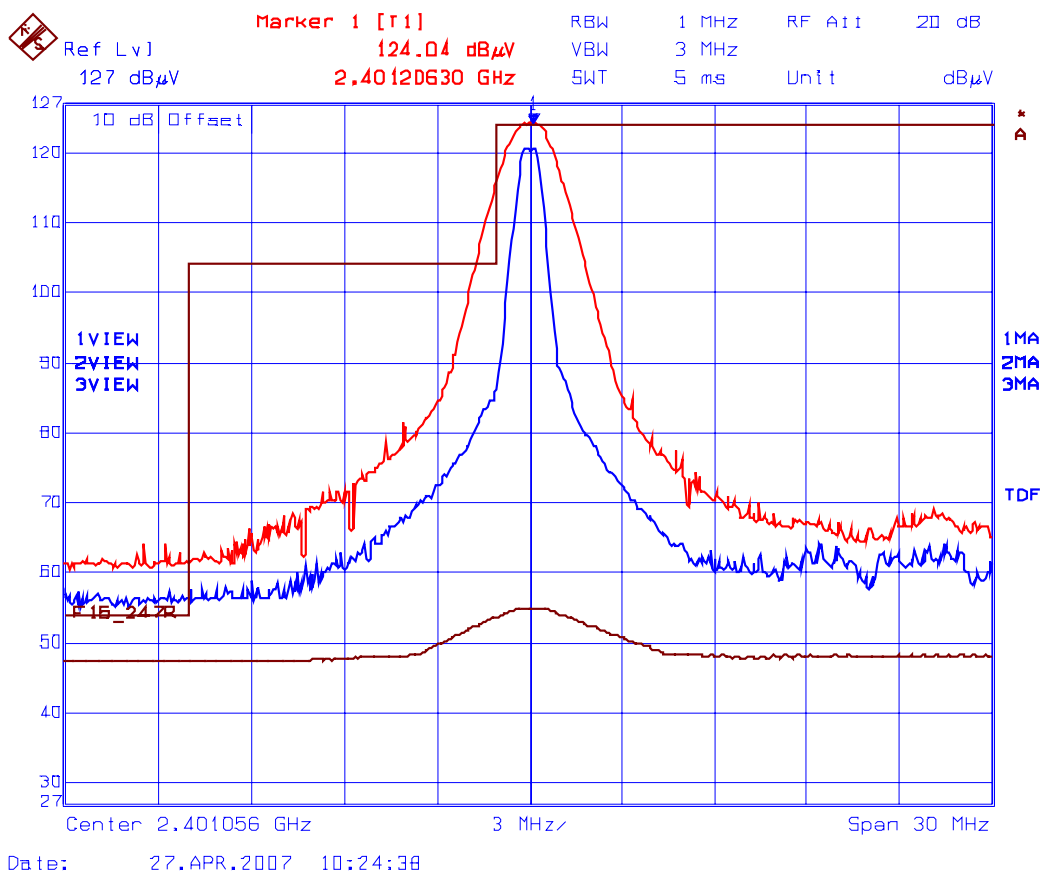

Trace 1: RBW= 1 MHz, VBW= 3 MHz
Trace 2: RBW= 300 kHz, VBW= 1 MHz
Trace 3: RBW= 1 MHz, VBW= 10 Hz

Plot 5.9.5.1.2.2. Band-Edge Radiated Emissions @ 3 meters
Horizontal Polarization Low End of Frequency Band, Single Frequency Mode

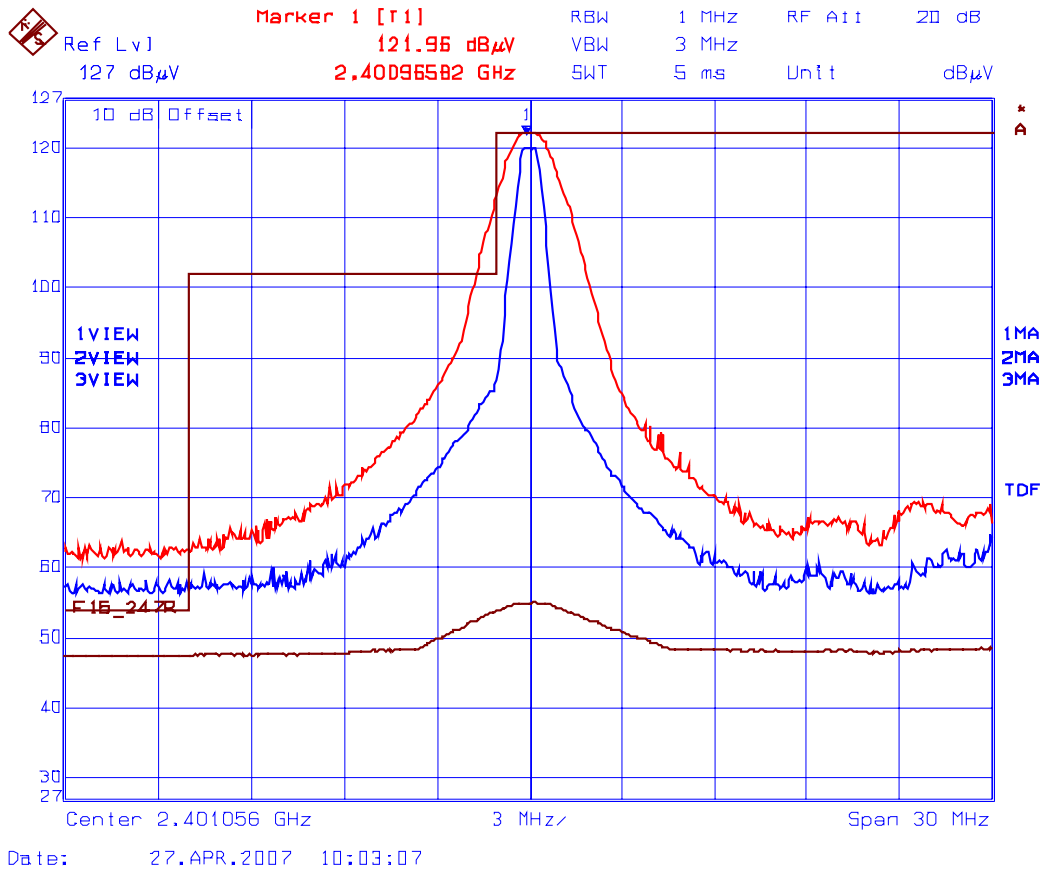

Trace 1: RBW= 1 MHz, VBW= 3 MHz
Trace 2: RBW= 300 kHz, VBW= 1 MHz
Trace 3: RBW= 1 MHz, VBW= 10 Hz

Plot 5.9.5.1.2.3. Band-Edge Radiated Emissions @ 3 meters
 Vertical Polarization Low End of Frequency Band, Pseudorandom Channel Hopping Mode

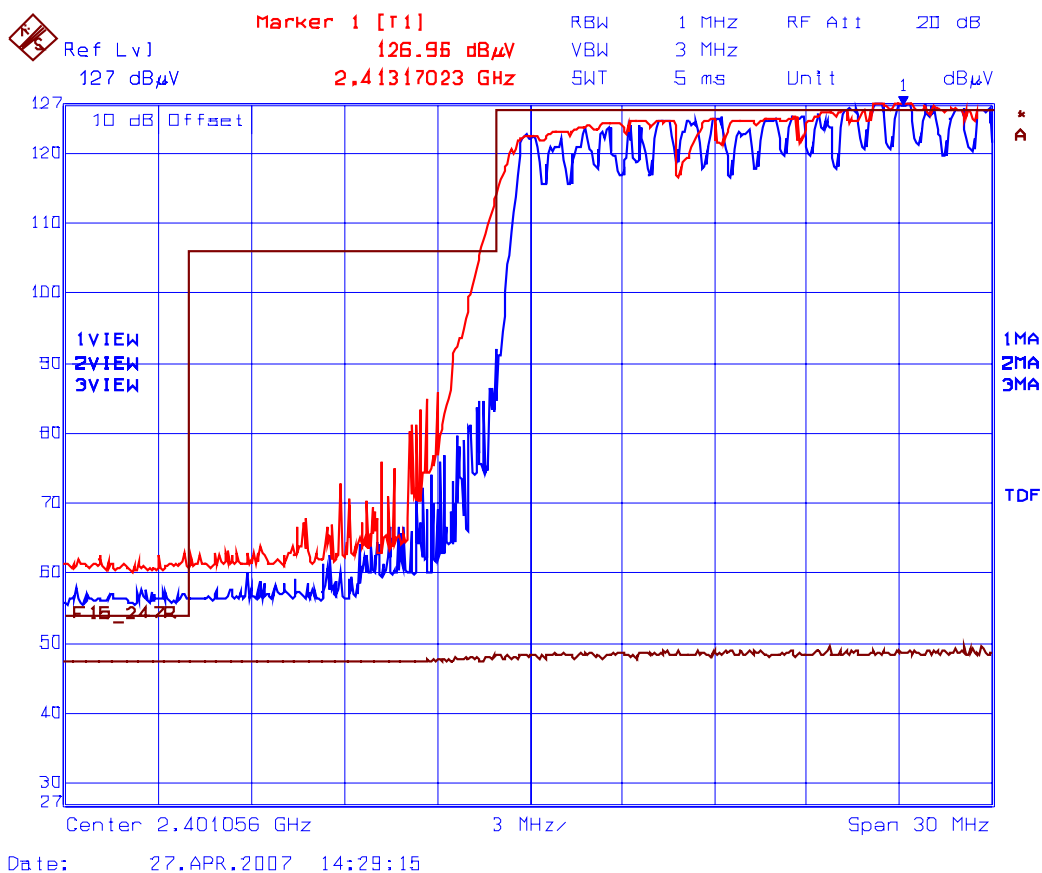

Trace 1: RBW= 1 MHz, VBW= 3 MHz
 Trace 2: RBW= 300 kHz, VBW= 1 MHz
 Trace 3: RBW= 1 MHz, VBW= 10 Hz

Plot 5.9.5.1.2.4. Band-Edge Radiated Emissions @ 3 meters
Horizontal Polarization, Low End of Frequency Band, Pseudorandom Channel Hopping Mode

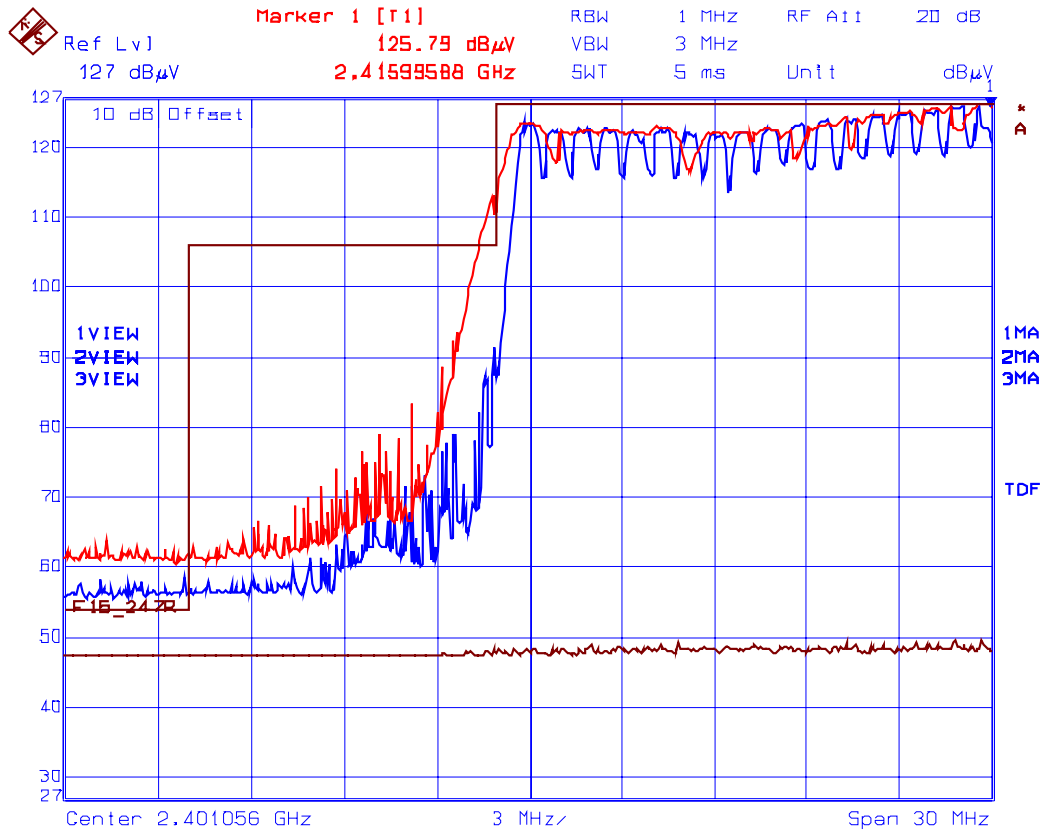

Date: 27.APR.2007 13:13:36

Trace 1: RBW= 1 MHz, VBW= 3 MHz
Trace 2: RBW= 300 kHz, VBW= 1 MHz
Trace 3: RBW= 1 MHz, VBW= 10 Hz

Plot 5.9.5.1.2.5. Band-Edge Radiated Emissions @ 3 meters
 Vertical Polarization, Upper End of Frequency Band, Single Frequency Mode

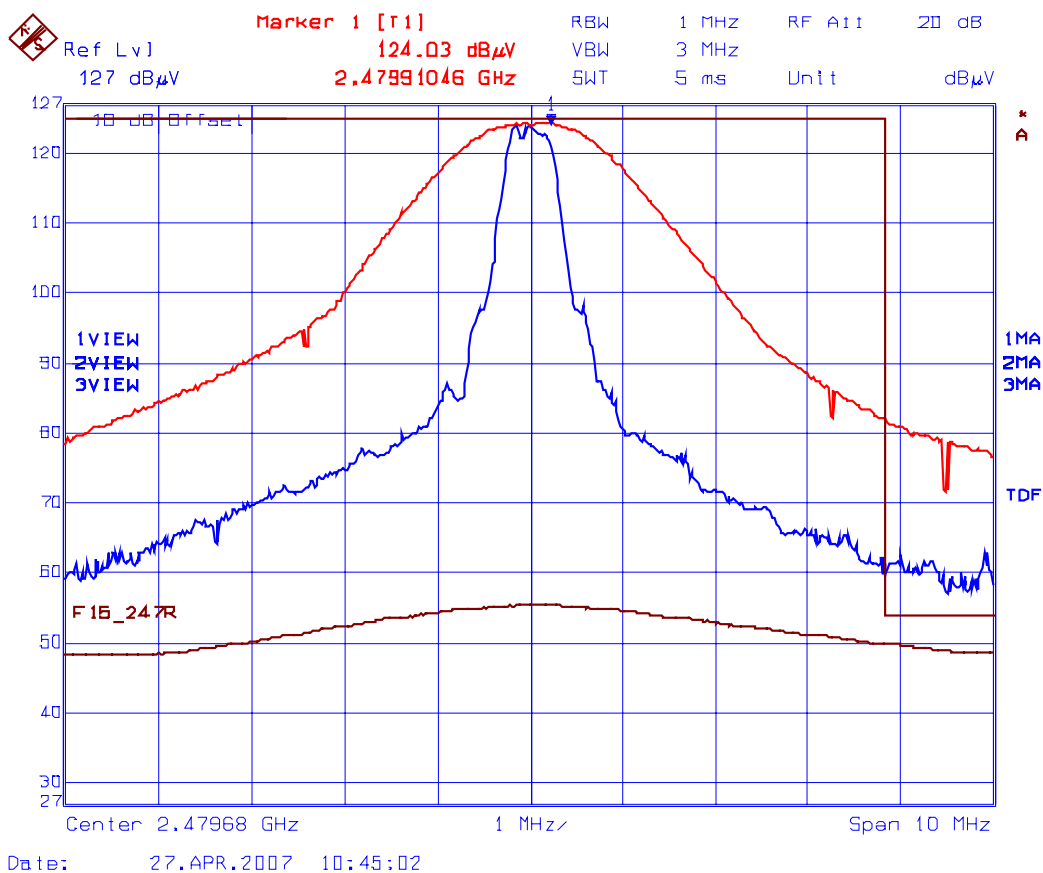

Trace 1: RBW= 1 MHz, VBW= 3 MHz
 Trace 2: RBW= 300 kHz, VBW= 1 MHz
 Trace 3: RBW= 1 MHz, VBW= 10 Hz

Plot 5.9.5.1.2.6. Band-Edge Radiated Emissions @ 3 meters
 Vertical Polarization, Upper End of Frequency Band, Single Frequency Mode

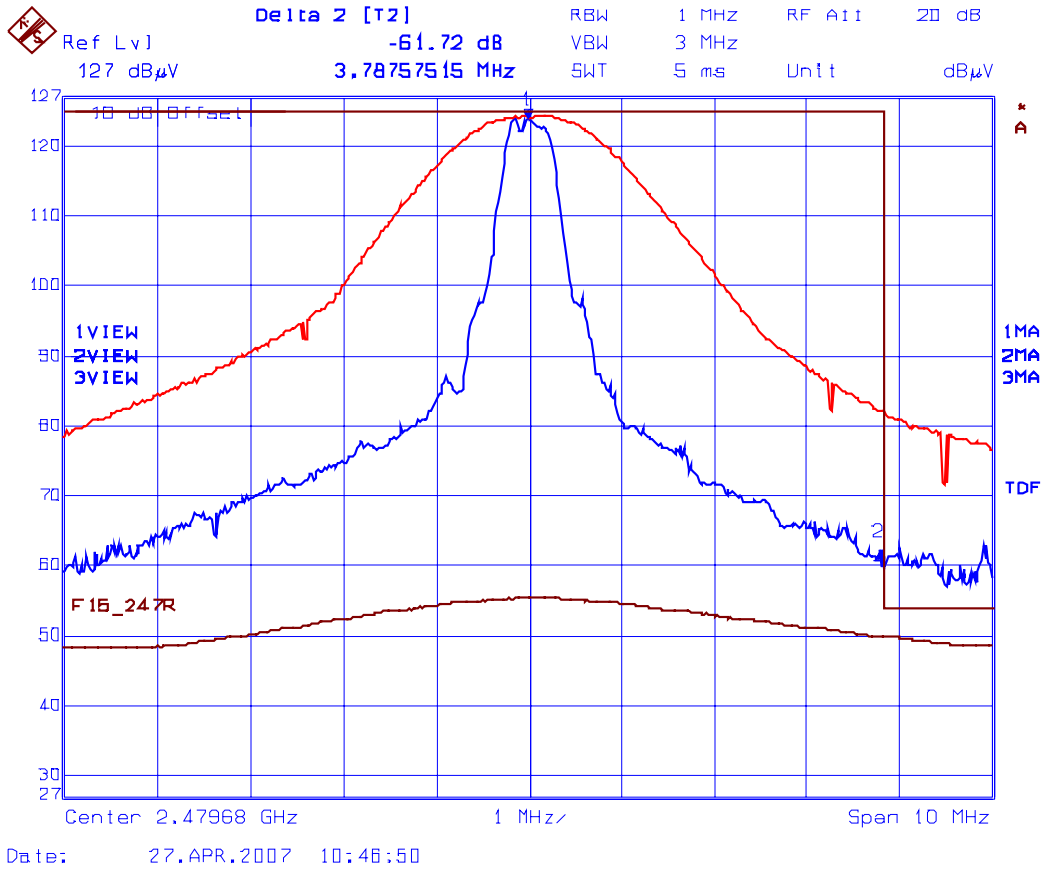

Trace 1: RBW= 1 MHz, VBW= 3 MHz
 Trace 2: RBW= 300 kHz, VBW= 1 MHz (Peak to Band-Edge): 61.72 dB
 Trace 3: RBW= 1 MHz, VBW= 10 Hz
 Band-Edge Level at 2483.5 MHz: 124.03dBuV/m – 61.72 dB= 62.31dBuV/m

Plot 5.9.5.1.2.7. Band-Edge Radiated Emissions @ 3 meters
Horizontal Polarization, Upper End of Frequency Band, Single Frequency Mode

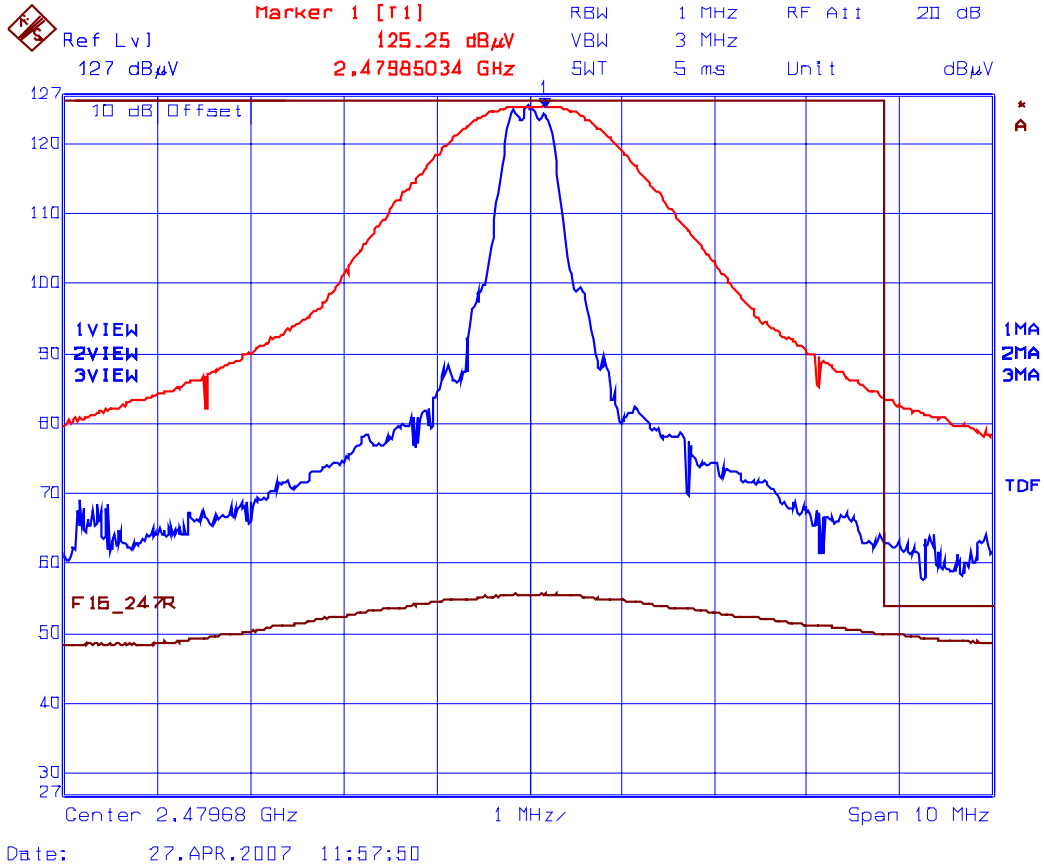

Trace 1: RBW= 1 MHz, VBW= 3 MHz
Trace 2: RBW= 300 kHz, VBW= 1 MHz
Trace 3: RBW= 1 MHz, VBW= 10 Hz

Plot 5.9.5.1.2.8. Band-Edge Radiated Emissions @ 3 meters
Horizontal Polarization, Upper End of Frequency Band, Single Frequency Mode

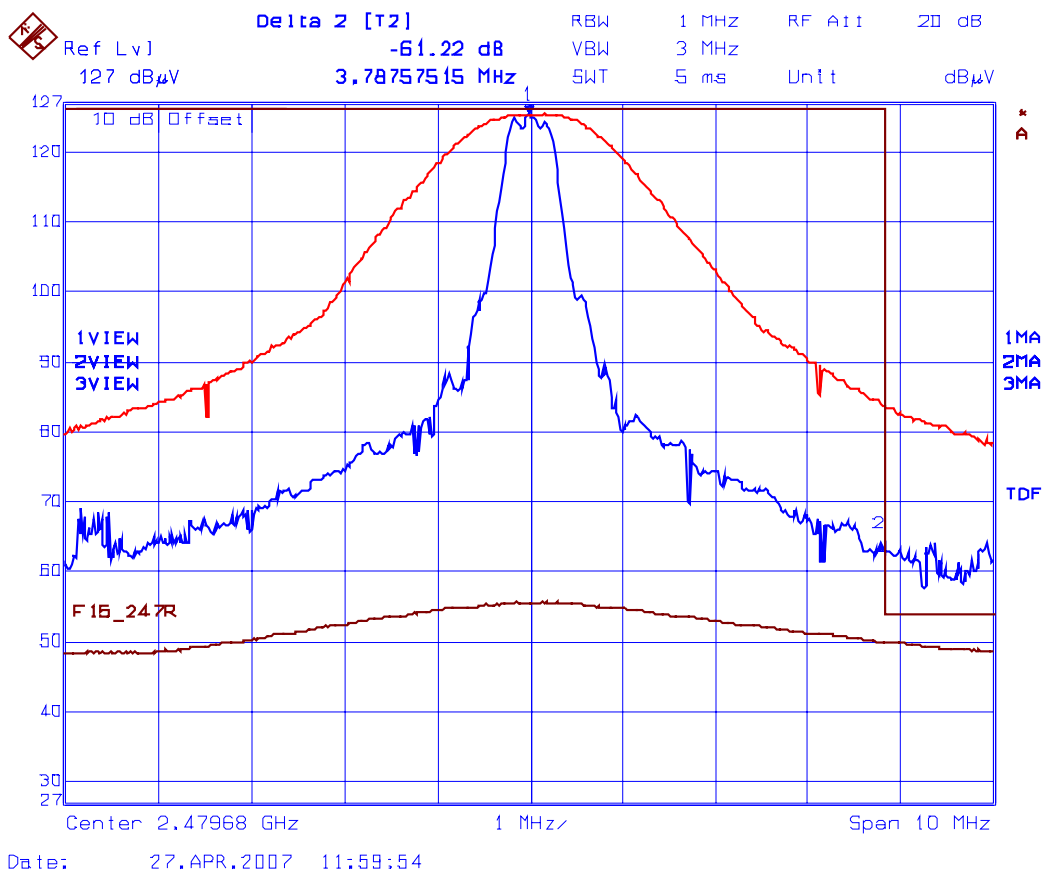

Trace 1: RBW= 1 MHz, VBW= 3 MHz
Trace 2: RBW= 300 kHz, VBW= 1 MHz (Peak to Band-Edge): 61.22 dB
Trace 3: RBW= 1 MHz, VBW= 10 Hz
Band-Edge Level at 2483.5 MHz: 125.25dBuV/m – 61.22 dB= 64.03dBuV/m

Plot 5.9.5.1.2.9. Band-Edge Radiated Emissions @ 3 meters
 Vertical Polarization, Upper End of Frequency Band, Pseudorandom Channel Hopping Mode

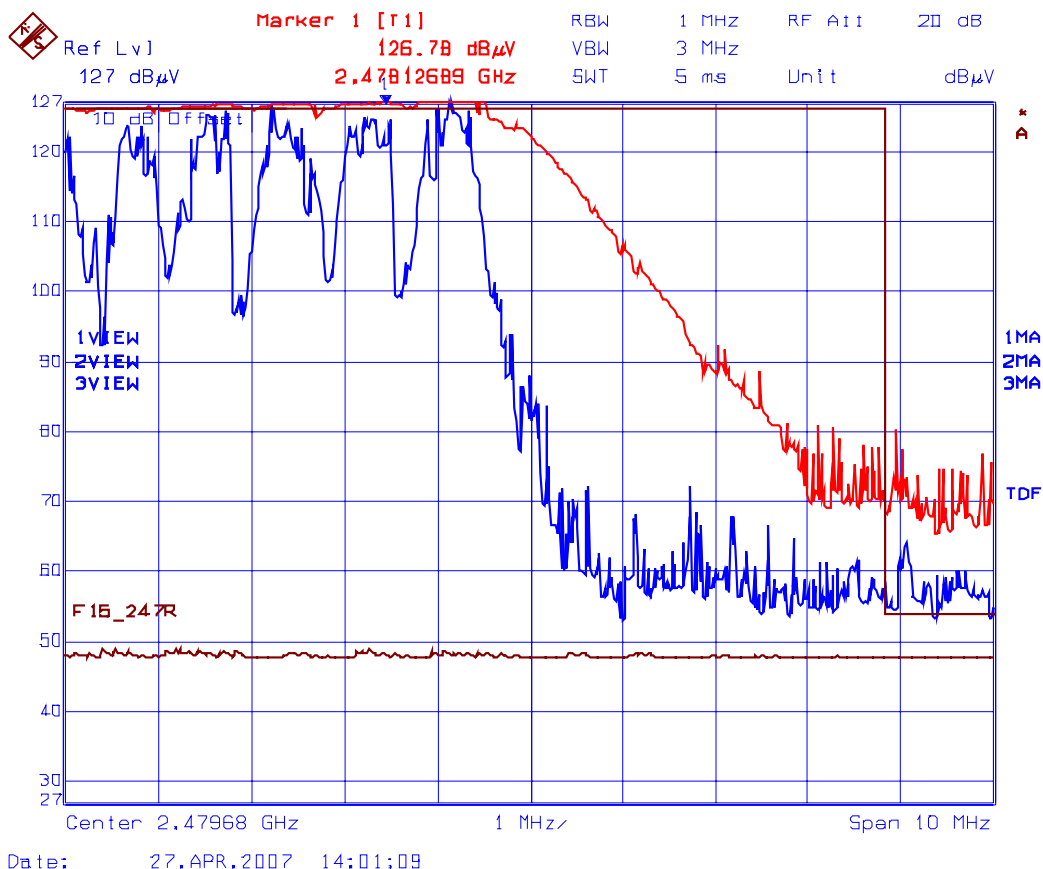

Trace 1: RBW= 1 MHz, VBW= 3 MHz
 Trace 2: RBW= 300 kHz, VBW= 1 MHz
 Trace 3: RBW= 1 MHz, VBW= 10 Hz

Plot 5.9.5.1.2.10. Band-Edge Radiated Emissions @ 3 meters
 Vertical Polarization, Upper End of Frequency Band, Pseudorandom Channel Hopping Mode

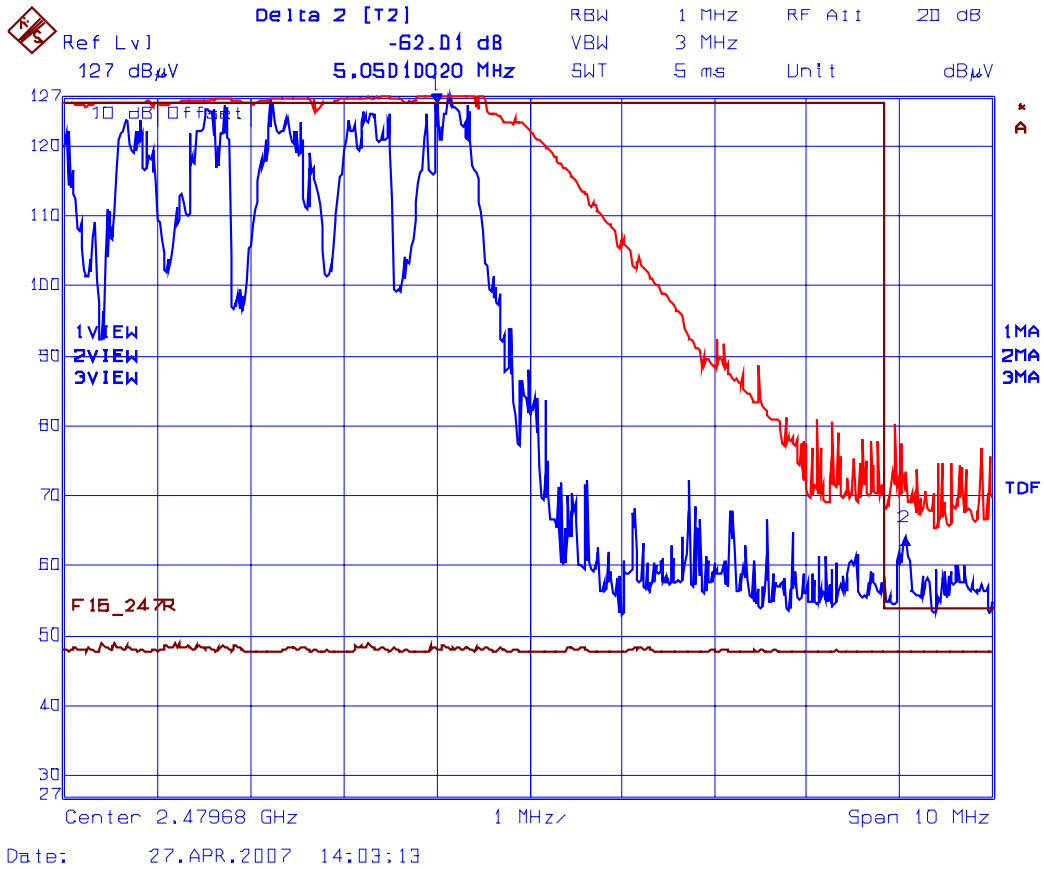

Trace 1: RBW= 1 MHz, VBW= 3 MHz
 Trace 2: RBW= 300 kHz, VBW= 1 MHz (Peak to Band-Edge): 62.01 dB
 Trace 3: RBW= 1 MHz, VBW= 10 Hz
 Band-Edge Level at 2483.5 MHz: 126.78dBuV/m – 62.01 dB= 64.77dBuV/m

Plot 5.9.5.1.2.11. Band-Edge Radiated Emissions @ 3 meters
 Horizontal Polarization, Upper End of Frequency Band, Pseudorandom Channel Hopping Mode

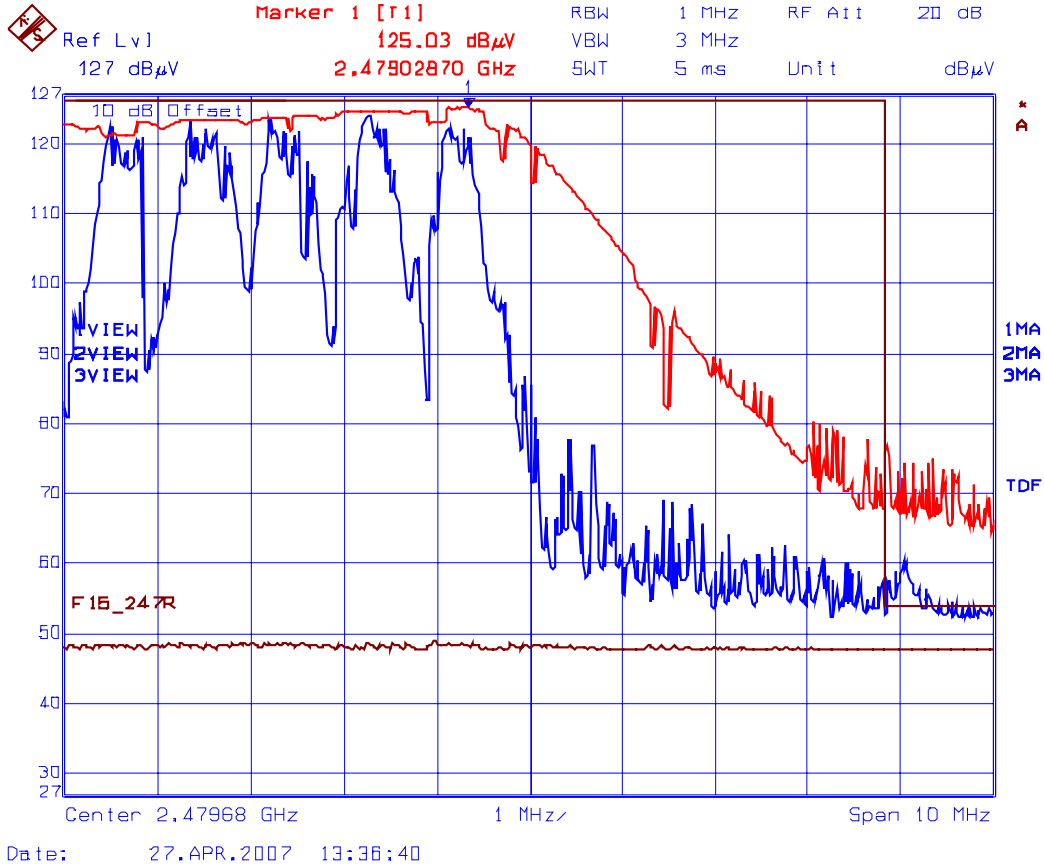

Trace 1: RBW= 1 MHz, VBW= 3 MHz
 Trace 2: RBW= 300 kHz, VBW= 1 MHz
 Trace 3: RBW= 1 MHz, VBW= 10 Hz

Plot 5.9.5.1.2.12. Band-Edge Radiated Emissions @ 3 meters
 Horizontal Polarization, Upper End of Frequency Band, Pseudorandom Channel Hopping Mode

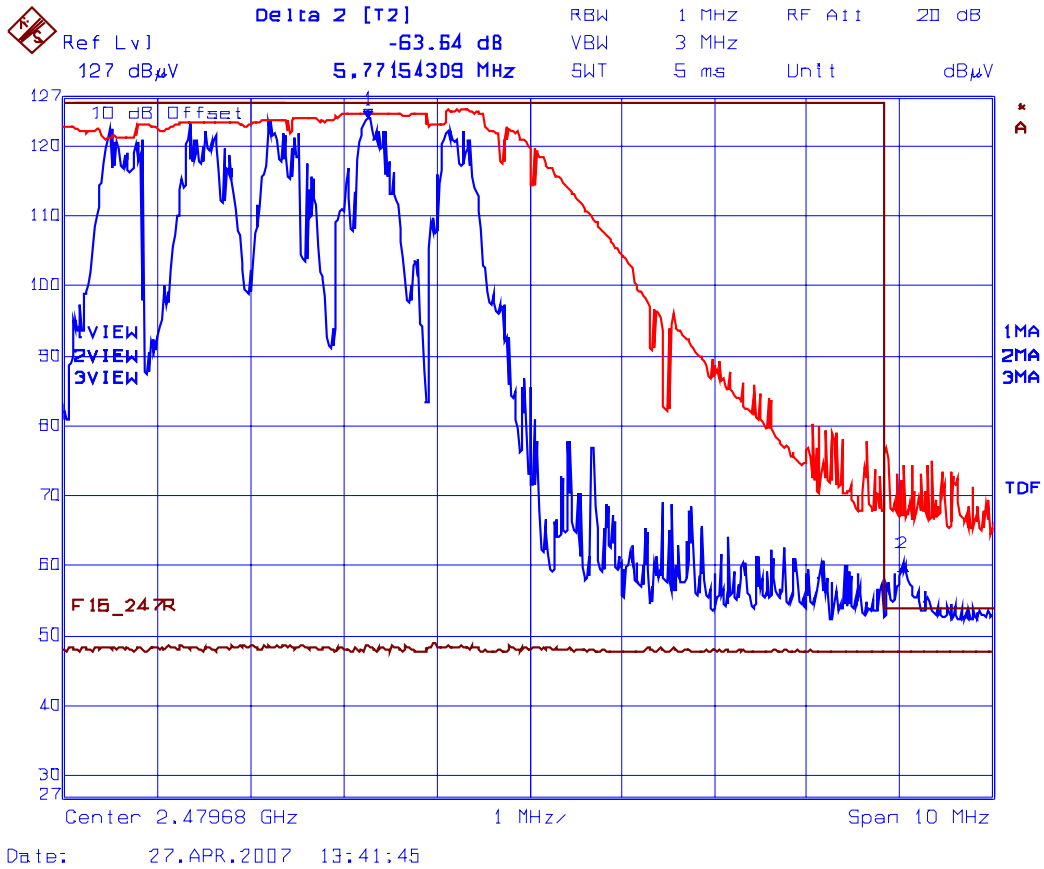

Trace 1: RBW= 1 MHz, VBW= 3 MHz
 Trace 2: RBW= 300 kHz, VBW= 1 MHz (Peak to Band-Edge): 63.64 dB
 Trace 3: RBW= 1 MHz, VBW= 10 Hz
 Band-Edge Level at 2483.5 MHz: 125.03dBuV/m – 63.64 dB= 61.39dBuV/m

5.9.5.2. Transmitter Radiated Spurious Emissions

5.9.5.2.1. KX-T0151, KX-TDA0151

The emissions were scanned from 30 MHz to 25 GHz; all signals within 20 dB below the permissible limit were recorded in the table below.

Frequency (MHz)	RF Peak Level (dBµV/m)	RF Avg Level (dBµV/m)	Antenna Plane (H/V)	Limit 15.209 (dBµV/m)	Limit 15.247 (dBµV/m)	Margin (dB)	Pass/Fail
Fundamental Frequency: 2401.056 MHz							
2401.056	126.90	-	V	-	-	-	-
2401.056	125.50	-	H	-	-	-	-
4802.112*	56.80	37.29	V	54.0	78.0	-16.71	Pass*
4802.112*	59.60	37.33	H	54.0	78.0	-16.67	Pass*
Fundamental Frequency: 2440.800 MHz							
2440.800	126.75	-	V	-	-	-	-
2440.800	126.34	-	H	-	-	-	-
4881.600*	55.93	37.73	V	54.0	78.0	-16.27	Pass*
4881.600*	56.25	37.71	H	54.0	78.0	-16.29	Pass*
Fundamental Frequency: 2479.680 MHz							
2479.680	126.66	-	V	-	-	-	-
2479.680	126.81	-	H	-	-	-	-
4959.360*	55.67	37.26	V	54.0	78.0	-16.74	Pass*
4959.360*	55.91	37.50	H	54.0	78.0	-16.50	Pass*

* Emission in restricted bands.

5.9.5.2.2. KX-TDA0152

The emissions were scanned from 30 MHz to 25 GHz; all signals within 20 dB below the permissible limit were recorded in the table below.

Frequency (MHz)	RF Peak Level (dBµV/m)	RF Avg Level (dBµV/m)	Antenna Plane (H/V)	Limit 15.209 (dBµV/m)	Limit 15.247 (dBµV/m)	Margin (dB)	Pass/Fail
Fundamental Frequency: 2401.056 MHz							
2401.056	126.96	-	V	-	-	-	-
2401.056	125.79	-	H	-	-	-	-
4802.112*	55.73	37.40	V	54.0	78.0	-16.60	Pass*
4802.112*	57.08	37.20	H	54.0	78.0	-16.80	Pass*
Fundamental Frequency: 2440.800 MHz							
2440.800	126.87	-	V	-	-	-	-
2440.800	125.49	-	H	-	-	-	-
4881.600*	58.18	38.01	V	54.0	78.0	-15.99	Pass*
4881.600*	57.15	37.38	H	54.0	78.0	-16.62	Pass*
Fundamental Frequency: 2479.680 MHz							
2479.680	126.78	-	V	-	-	-	-
2479.680	125.25	-	H	-	-	-	-
4959.360*	58.91	38.13	V	54.0	78.0	-15.87	Pass*
4959.360*	56.29	38.02	H	54.0	78.0	-15.98	Pass*

* Emission in restricted bands.

5.10. RF EXPOSURE REQUIRMENTS [§§ 15.247(i), 1.1310 & 2.1091]

5.10.1. Limit

- **§ 15.247(i):** Systems operating under provisions of this section shall be operated in a manner that ensures that the public is not exposed to radio frequency energy levels in excess of the Commission’s guidelines. See § 1.1307(b)(1).
- **§ 1.1310:-** The criteria listed in the following table shall be used to evaluate the environmental impact of human exposure to radio-frequency (RF) radiation as specified in 1.1307(b).

TABLE 1—LIMITS FOR MAXIMUM PERMISSIBLE EXPOSURE (MPE)

Frequency range (MHz)	Electric field strength (V/m)	Magnetic field strength (A/m)	Power density (mW/cm ²)	Averaging time (minutes)
(A) Limits for Occupational/Controlled Exposures				
0.3–3.0	614	1.63	*(100)	6
3.0–30	1842/f	4.89/f	*(900/f ²)	6
30–300	61.4	0.163	1.0	6
300–1500			f/300	6
1500–100,000			5	6
(B) Limits for General Population/Uncontrolled Exposure				
0.3–1.34	614	1.63	*(100)	30
1.34–30	824/f	2.19/f	*(180/f ²)	30
30–300	27.5	0.073	0.2	30
300–1500			f/1500	30
1500–100,000			1.0	30

f = frequency in MHz
 * = Plane-wave equivalent power density
 NOTE 1 TO TABLE 1: Occupational/controlled limits apply in situations in which persons are exposed as a consequence of their employment provided those persons are fully aware of the potential for exposure and can exercise control over their exposure. Limits for occupational/controlled exposure also apply in situations when an individual is transient through a location where occupational/controlled limits apply provided he or she is made aware of the potential for exposure.
 NOTE 2 TO TABLE 1: General population/uncontrolled exposures apply in situations in which the general public may be exposed, or in which persons that are exposed as a consequence of their employment may not be fully aware of the potential for exposure or can not exercise control over their exposure.

5.10.2. Method of Measurements

Refer to Sections 1.1310, 2.1091 and Public Notice DA 00-705 (March 30, 2000)

Spread spectrum transmitters operating under section 15.247 are categorically from routine environmental evaluation to demonstrating RF exposure compliance with respect to MPE and/or SAR limits. These devices are not exempted from compliance (As indicated in Section 15.247(b)(4), these transmitters are required to operate in a manner that ensures that exposure to public users and nearby persons) does not exceed the Commission’s RF exposure guidelines (see Section 1.1307 and 2.1093). Unless a device operates at substantially low power levels, with a low gain antenna(s), supporting information is generally needed to establish the various potential operating configurations and exposure conditions of a transmitter and its antenna(s) in order to determine compliance with the RF exposure guidelines.

In order to demonstrate compliance with MPE requirements (see Section 2.1091), the following information is typically needed:

- (1) Calculation that estimates the minimum separation distance (20 cm or more) between an antenna and persons required to satisfy power density limits defined for free space.
- (2) Antenna installation and device operating instructions for installers (professional/unskilled users), and the parties responsible for ensuring compliance with the RF exposure requirement
- (3) Any caution statements and/or warning labels that are necessary in order to comply with the exposure limits
- (4) Any other RF exposure related issues that may affect MPE compliance

Calculation Method of RF Safety Distance:

$$S = PG/4\pi r^2 = EIRP/4\pi r^2$$

Where: P: power input to the antenna in mW
EIRP: Equivalent (effective) isotropic radiated power
S: power density mW/cm²
G: numeric gain of antenna relative to isotropic radiator
r: distance to centre of radiation in cm

$$r = \sqrt{EIRP/4\pi S}$$

For portable transmitters (see Section 2.1093), or devices designed to operate next to a person's body, compliance is determined with respect to the SAR limit (define in the body tissues) for near-field exposure conditions. If the maximum average output power, operating condition configurations and exposure conditions are comparable to those of existing cellular and PCS phones, SAR evaluation may be required in order to determine if such a device complies with SAR limit. When SAR evaluation data is not available, and the additional supporting information cannot assure compliance, the Commission may request that an SAR evaluation be performed, as provided for in Section 1.1307(d)

5.10.3. Test Data

5.10.3.1. KX-T0151, KX-TDA0151

Evaluation of RF Exposure Compliance Requirements	
RF Exposure Requirements	Compliance with FCC Rules
Minimum calculated separation distance between antenna and persons required: *5 cm	Manufacturer' instruction for separation distance between antenna and persons required: 20 cm.
Antenna installation and device operating instructions for installers (professional/unskilled users), and the parties responsible for ensuring compliance with the RF exposure requirement	Antenna installation and device operating instructions shall be provided to installers to maintain and ensure compliance with RF exposure requirements.
Caution statements and/or warning labels that are necessary in order to comply with the exposure limits	Refer to User's Manual for RF Exposure Information.
Any other RF exposure related issues that may affect MPE compliance	None.

*The minimum separation distance between the antenna and bodies of users are calculated using the following formula:

$$\text{RF EXPOSURE DISTANCE LIMITS: } r = (PG/4\pi S)^{1/2} = (EIRP/4\pi S)^{1/2}$$

$$S = 1.0 \text{ mW/cm}^2$$

$$EIRP = 22.70 \text{ dBm} + 2.14 \text{ dBi} = 10^{24.84/10} \text{ mW max. (Worst Case)}$$

$$r = (EIRP/4\pi S)^{1/2} = (10^{24.84/10}/4\pi)^{1/2} = 5 \text{ cm}$$

5.10.3.2. KX-TDA0152

Evaluation of RF Exposure Compliance Requirements	
RF Exposure Requirements	Compliance with FCC Rules
Minimum calculated separation distance between antenna and persons required: *5 cm	Manufacturer' instruction for separation distance between antenna and persons required: 20 cm.
Antenna installation and device operating instructions for installers (professional/unskilled users), and the parties responsible for ensuring compliance with the RF exposure requirement	Antenna installation and device operating instructions shall be provided to installers to maintain and ensure compliance with RF exposure requirements.
Caution statements and/or warning labels that are necessary in order to comply with the exposure limits	Refer to User's Manual for RF Exposure Information.
Any other RF exposure related issues that may affect MPE compliance	None.

*The minimum separation distance between the antenna and bodies of users are calculated using the following formula:

RF EXPOSURE DISTANCE LIMITS: $r = (PG/4\pi S)^{1/2} = (EIRP/4\pi S)^{1/2}$

$S = 1 \text{ mW/cm}^2$

$EIRP = 22.70 \text{ dBm} + 2.14 \text{ dBi} = 10^{24.84/10} \text{ mW max. (Worst Case)}$

$r = (EIRP/4\pi S)^{1/2} = (10^{24.84/10}/4\pi)^{1/2} = 5 \text{ cm}$

EXHIBIT 6. MEASUREMENT UNCERTAINTY

The measurement uncertainties stated were calculated in accordance with the requirements of NIST Technical Note 1297 and NIS 81 (1994)

6.1. LINE CONDUCTED EMISSION MEASUREMENT UNCERTAINTY

CONTRIBUTION (Line Conducted)	PROBABILITY DISTRIBUTION	UNCERTAINTY (dB)	
		9-150 kHz	0.15-30 MHz
EMI Receiver specification	Rectangular	± 1.5	± 1.5
LISN coupling specification	Rectangular	± 1.5	± 1.5
Cable and Input Transient Limiter calibration	Normal (k=2)	± 0.3	± 0.5
Mismatch: Receiver VRC $\Gamma_1 = 0.03$ LISN VRC $\Gamma_R = 0.8(9 \text{ kHz}) 0.2 (30 \text{ MHz})$ Uncertainty limits $20\text{Log}(1+\Gamma_1\Gamma_R)$	U-Shaped	± 0.2	± 0.3
System repeatability	Std. deviation	± 0.2	± 0.05
Repeatability of EUT	--	--	--
Combined standard uncertainty	Normal	± 1.25	± 1.30
Expanded uncertainty U	Normal (k=2)	± 2.50	± 2.60

Sample Calculation for Measurement Accuracy in 450 kHz to 30 MHz Band:

$$u_c(y) = \sqrt{\sum_{i=1}^m u_i^2(y)} = \pm \sqrt{(1.5^2 + 1.5^2)/3 + (0.5/2)^2 + (0.05/2)^2 + 0.35^2} = \pm 1.30 \text{ dB}$$

$$U = 2u_c(y) = \pm 2.6 \text{ dB}$$

6.2. RADIATED EMISSION MEASUREMENT UNCERTAINTY

CONTRIBUTION (Radiated Emissions)	PROBABILITY DISTRIBUTION	UNCERTAINTY (+ dB)	
		3 m	10 m
Antenna Factor Calibration	Normal (k=2)	± 1.0	± 1.0
Cable Loss Calibration	Normal (k=2)	± 0.3	± 0.5
EMI Receiver specification	Rectangular	± 1.5	± 1.5
Antenna Directivity	Rectangular	+0.5	+0.5
Antenna factor variation with height	Rectangular	± 2.0	± 0.5
Antenna phase center variation	Rectangular	0.0	± 0.2
Antenna factor frequency interpolation	Rectangular	± 0.25	± 0.25
Measurement distance variation	Rectangular	± 0.6	± 0.4
Site imperfections	Rectangular	± 2.0	± 2.0
Mismatch: Receiver VRC $\Gamma_1 = 0.2$ Antenna VRC $\Gamma_R = 0.67(Bi) 0.3 (Lp)$ Uncertainty limits $20\text{Log}(1 \pm \Gamma_1 \Gamma_R)$	U-Shaped	+1.1 -1.25	± 0.5
System repeatability	Std. Deviation	± 0.5	± 0.5
Repeatability of EUT		-	-
Combined standard uncertainty	Normal	+2.19 / -2.21	+1.74 / -1.72
Expanded uncertainty U	Normal (k=2)	+4.38 / -4.42	+3.48 / -3.44

Calculation for maximum uncertainty when 3m biconical antenna including a factor of k = 2 is used:

$$U = 2u_c(y) = 2x(+2.19) = +4.38 \text{ dB} \quad \text{And} \quad U = 2u_c(y) = 2x(-2.21) = -4.42 \text{ dB}$$