



**Test report no. : 126976-2**

**Item tested : KX-NCP0158**

**Type of equipment : UPCS Base**

**FCC ID : ACJ96NKX-NCP0158**

**Client : Panasonic Communications Co., Ltd.**

**FCC Part 15, subpart D**

Isochronous UPCS Device  
1920 - 1930 MHz

**Industry Canada RSS-213, Issue 2**

2 GHz Licence-exempt Personal  
Communications Service Devices  
(LE-PCS)

**3 June 2009**

**Authorized by :** .....



Egil Hauger  
Technical Verificator



## CONTENTS

<b>1</b>	<b>GENERAL INFORMATION .....</b>	<b>3</b>
1.1	Testhouse Info .....	3
1.2	Client Information .....	3
1.3	Manufacturer (if other than client).....	3
<b>2</b>	<b>TEST INFORMATION .....</b>	<b>4</b>
2.1	Tested Item.....	4
2.2	Test Environment .....	5
2.3	Test Period .....	5
2.4	Test Engineer(s) .....	5
2.5	Test Equipment .....	5
2.6	Other Comments .....	5
<b>3</b>	<b>TEST REPORT SUMMARY .....</b>	<b>6</b>
3.1	General.....	6
3.2	Test Summary .....	7
<b>4</b>	<b>TEST RESULTS.....</b>	<b>8</b>
4.1	Coordination with fixed microwave .....	8
4.2	Digital Modulation Techniques .....	8
4.3	Labeling Requirements .....	8
4.4	Antenna Requirement.....	9
4.5	Channel Frequencies .....	9
4.6	Automatic Discontinuation of Transmission .....	10
4.7	Peak Power Output .....	11
4.8	Emission Bandwidth $B$ .....	16
4.9	Power Spectral Density .....	19
4.10	In-Band Unwanted Emissions, Conducted .....	22
4.11	Out-of-band Emissions, Conducted.....	24
4.12	Carrier Frequency Stability .....	28
4.13	Frame Repetition Stability .....	29
4.14	Frame Period and Jitter .....	29
4.15	Monitoring Threshold, Least Interfered Channel .....	31
4.16	Threshold Monitoring Bandwidth .....	33
4.17	Reaction Time and Monitoring Interval .....	34
4.18	Time and Spectrum Window Access Procedure .....	36
4.19	Acknowledgements and Transmission Duration .....	39
4.20	Dual Access Criteria Check.....	40
4.21	Alternative Monitoring Interval .....	41
4.22	Receiver Spurious Emissions.....	42
<b>5</b>	<b>TEST SETUPS .....</b>	<b>45</b>
5.1	Frequency Measurements .....	45
5.2	Timing Measurements .....	45
5.3	Conducted Emission Test.....	45
5.4	Antenna Gain Test.....	46
5.5	Power Line Conducted Emissions Test .....	46
5.6	Monitoring Tests .....	47
<b>6</b>	<b>TEST EQUIPMENT USED .....</b>	<b>48</b>

## 1 GENERAL INFORMATION

### 1.1 Testhouse Info

Name : Nemko AS  
Address : Nemko Comlab  
Gåsevikveien 8, Box 96  
N-2007 Kjeller, NORWAY  
Telephone : +47 64 84 57 00  
Fax : +47 64 84 57 05  
E-mail: comlab@nemko.com  
FCC test firm  
registration # : 994405  
IC OATS  
registration # : 2040D-1  
Total Number  
of Pages: 48

### 1.2 Client Information

Name : Panasonic Communications Co. Ltd.  
Address : 1-62, 4-chome, Minoshima, Hakata-ku, Fukuoka 812-8531, Japan  
Telephone : +81 92 477 1405

**Contact:**

Name : Mr. Junji Sumi  
Telephone : +81 92 477 1405  
E-mail : sumi.junji@jp.panasonic.com

### 1.3 Manufacturer (if other than client)

Name : /  
Address : /  
Telephone : /  
E-mail : /

## 2 Test Information

### 2.1 Tested Item

Name :	Panasonic
FCC ID :	ACJ96NKX-NCP0158
Model/version :	KX-NCP0158
Serial number :	Radiated Sample: 9AAVA000059 Conducted Sample: 9AAVA000058
Hardware identity and/or version:	/
Software identity and/or version :	/
Frequency Range :	1921.536 – 1928.448 MHz
Number of Channels :	5 RF Channels, 5x12 = 60 TDMA Duplex Channels
Type of Modulation :	GFSK
User Frequency Adjustment :	None
Rated Output Power :	48 mW Peak Power
Type of Power Supply :	AC Adaptor Model: PSLP1662
Antenna Connector :	None
Number of Antennas :	2
Antenna Diversity Supported :	Yes
Desktop Charger :	None

#### Description of Tested Device(s)

The tested equipment is a DECT base that complies with ETSI EN 300 175, except the frequencies have been reprogrammed, the output power reduced and the software updated to comply with the FCC requirements to an Isochronous UPCS device after FCC Part 15D.

The tested equipment is a responding device as described in ANSI C63.17 and is designed to operate together with a DECT portable part (i.e. a handset), which is then the initiating device.

#### Exposure Evaluation

The EUT is designed to be fixed to a wall etc. and the user manual contains text that it shall be mounted with a separation distance of at least 20cm from any persons. For the purposes of exposure evaluation this EUT is a mobile or fixed device. MPE calculation at 20cm satisfying FCC requirements is submitted as a separate document.

The EUT is exempted from RF Exposure Evaluation to Industry Canada SAR requirements since the output power is below the limit in RSS-102 Issue 2, clause 2.5.2 for General Public Use.

## 2.2 Test Environment

Temperature:	21 – 23 °C
Relative humidity:	28 – 40 %
Normal test voltage:	120 V AC

The values are the limit registered during the test period.

## 2.3 Test Period

Item received date:	2009-05-04
Test period :	from 2009-05-04 to 2009-05-13

## 2.4 Test Engineer(s)

Frode Sveinsen

## 2.5 Test Equipment

See list of test equipment in clause 6.

## 2.6 Other Comments

The Monitoring and Time and Spectrum Window Access tests were performed with Test Set-Up 6 (Ref. clause 5). A clock signal from the companion device was used to synchronize the Pulse Pattern Generator and the Spectrum Analyzer to the start of the DECT time window. The EUT was limited by administrative commands to operate on only two frequency carriers. For the tests where the EUT was required to operate on only one frequency carrier, one carrier was blocked by applying a CW interfering signal from RF Generator 3. The Pulse Pattern Generator was used to apply time synchronized interference to time windows where this was required.

Since the EUT was programmed to operate on only two RF carriers, it was only necessary with two RF generators for the monitoring tests, however a third generator was applied for the tests that required specific time slots to be blocked.

All tests except the Radiated Spurious Emissions, Radiated Power and the Power line conducted emissions tests were performed in conducted mode with a temporary antenna connector.

It was checked that 85% of the lowest and 115% of the operating voltage did not have any influence on the measurement results.

### 3 TEST REPORT SUMMARY

#### 3.1 General

Manufacturer: Panasonic  
Model No.: KX-NCP0158  
Serial No.: /

All measurements are traceable to national standards.

The tests were conducted on a sample of the equipment for the purpose of demonstrating compliance with FCC CFR47 Part 15D for Isochronous UPCS Devices and Industry Canada RSS-213 Issue 2.

The conducted test methods have been in accordance with ANSI C63.17-2006 where applicable.

Radiated tests were conducted in accordance with ANSI C63.4-2003. Radiated emissions are made in a 10m semi-anechoic chamber. A description of the test facility is on file with the FCC and Industry Canada.

- |   |   |
|---|---|
| <input checked="" type="checkbox"/> New Submission  | <input checked="" type="checkbox"/> Production Unit |
| <input type="checkbox"/> Class II Permissive Change | <input type="checkbox"/> Pre-production Unit        |
| <b>PUB</b> Equipment Code                           | <input type="checkbox"/> Family Listing             |

**THIS TEST REPORT APPLIES ONLY TO THE ITEM(S) AND CONFIGURATIONS TESTED.**

**Deviations from, additions to, or exclusions from the test specifications are described in "Summary of Test Data".**



**TEST REPORT NO: 126976-2**

TESTED BY : Frode Sveinsen  
Frode Sveinsen, Chief Engineer

DATE: 14 May 2009

Nemko Group authorizes the above named company to reproduce this report provided it is reproduced in its entirety and for use by the company's employees only. Any reproduction of parts of this report requires approval in writing from Nemko Group.

Any use which a third party makes of this report, or any reliance on or decisions to be made based on it, are the responsibility of such third parties. Nemko Group accepts no responsibility for damages suffered by any third party as a result of decisions made or actions based on this report.

### 3.2 Test Summary

Name of test	FCC CFR 47 Paragraph #	IC RSS-213 Paragraph #	Verdict
Coordination with fixed microwave	15.307(b)	N/A	Complies
Digital Modulation Techniques	15.319(b)	6.1	Complies
Labeling requirements	15.19(a)(3)	RSS-GEN 5.2	Complies
Antenna Requirement	15.317, 15.203	4.1(e)	Complies
Power-Line Conducted Emissions	15.107(a) 15.207(a)	6.3 RSS-GEN 7.2.2	Complies <sup>5</sup>
Emission Bandwidth	15.323(a)	6.4	Complies
In-band emissions	15.323(d)	6.7.2	Complies
Out-of-band emissions	15.323(d)	6.7.1	Complies
Peak transmit Power	15.319(c)(e), 15.31(e)	6.5	Complies
Power Spectral Density	15.319(d)	4.3.2.1	Complies
Automatic discontinuation of transmission	15.319(f)	4.3.4(a)	Complies
Carrier frequency stability	15.323(f)	6.2	Complies
Frame repetition stability	15.323(e)	4.3.4(c)	Complies
Frame period and jitter	15.323(e)	4.3.4(c)	Complies
Monitoring threshold, Least interfered channel	15.323(c)(2);(5); (9)	4.3.4(b)	Complies
Monitoring of intended transmit window and maximum reaction time	15.323(c)(1)	4.3.4	Complies
Threshold monitoring bandwidth	15.323(c)(7)	4.3.4	Complies
Reaction time and monitoring interval	15.323(c)(1);(5); (7)	4.3.4	Complies
Access criteria test interval	15.323(c)(4);(6)	4.3.4	Complies
Access Criteria functional test	15.323(c)(4);(6)	4.3.4	Complies
Acknowledgements	15.323(c)(4)	4.3.4	Complies
Transmission duration	15.323(c)(3)	4.3.4	N/A <sup>1</sup>
Dual access criteria	15.323(c)(10)	4.3.4	N/A <sup>1</sup>
Alterative monitoring interval	15.323(c)(10);(11)	4.3.4	N/A <sup>2</sup>
Spurious Emissions (Antenna Conducted)	15.323(d)	6.7.1	Complies <sup>3</sup>
Spurious Emissions (Radiated)	15.319(g) 15.109(a) 15.209(a)	4.3.3 RSS-GEN 7.2.3	N/A <sup>4</sup>
Receiver Spurious Emissions	N/A	6.8	Complies

<sup>1</sup> Only applies for EUT that can be initiating device  
<sup>2</sup> The client declares that the tested equipment does not implement this provision  
<sup>3</sup> The tested equipment has integrated antennas only  
<sup>4</sup> Not required if the Conducted Out-of-Band Emissions test is Passed  
<sup>5</sup> See Nemko Canada test report No. 126976-1TRFEMC

## 4 TEST RESULTS

### 4.1 Power-Line Conducted Emissions

This test has been performed by Nemko Canada. See Nemko Canada test report no. 126976-1TRFEMC for test results.

### 4.2 Coordination with fixed microwave

The affidavit from UTAM, Inc. is included in the documentation supplied by the applicant:

Yes

No

#### Requirement, FCC 15.307 (b):

Each application for certification of equipment operating under the provisions of this Subpart must be accompanied by an affidavit from UTAM, Inc. certifying that the applicant is a participating member of UTAM, Inc. In the event a grantee fails to fulfill the obligations attendant to participation in UTAM, Inc., the Commission may invoke administrative sanctions as necessary to preclude continued marketing and installation of devices covered by the grant of certification, including but not limited to revoking certification.

### 4.3 Digital Modulation Techniques

The tested equipment is based on DECT technology described in the ETSI standard EN 300175, the only difference is that the channel allocation is modified to operate in the 1920-1930 MHz band.

The EUT used Multi Carrier / Time Division Multiple Access / Time Division Duplex and Digital GFSK modulation.

For further details see the operational description provided by the applicant.

#### Requirement, FCC 15.319(b):

All transmissions must use only digital modulation techniques.

### 4.4 Labeling Requirements

See separate documents showing the label design and the placement of the label on the EUT.

#### Requirements FCC 15.19

The FCC Identifier shall be displayed on the label, and the device(s) shall bear the following statement in a conspicuous location on the device or in the user manual if the device is too small:

*This device complies with Part 15 of the FCC Rules. Operation is subject to the following two conditions: (1) this device may not cause harmful interference, and (2) this device must accept any interference received, including interference that may cause undesired operation.*

The label itself shall be of a permanent type, not a paper label, and shall last the lifetime of the equipment.

#### 4.5 Antenna Requirement

Does the EUT have detachable antenna(s)?  Yes  No

If detachable, is the antenna connector(s) non-standard?  Yes  No

The tested equipment has only integral antennas. The conducted tests were performed on a sample with a temporary antenna connector.

**Requirement: FCC 15.203, 15.204, 15.317.**

#### 4.6 Channel Frequencies

UPCS CHANNEL	FREQUENCY (MHz)
Upper Band Edge	1930.000
0 (Highest)	1928.448
1	1926.720
2	1924.992
3	1923.264
4 (Lowest)	1921.536
Lower Band Edge	1920.000

**Requirement: FCC 15.303 (d), (g)**

Within 1920 -1930 MHz band for isochronous devices.

#### 4.7 Automatic Discontinuation of Transmission

Does the EUT transmit Control and Signaling Information?	<input checked="" type="checkbox"/> YES	<input type="checkbox"/> NO
TYPE OF EUT :	<input type="checkbox"/> INITIATING DEVICE	<input checked="" type="checkbox"/> RESPONDING DEVICE

The following tests simulate the reaction of the EUT in case of either absence of information to transmit or operational failure after a connection with the companion device is established.

Number	Test	EUT Reaction	Verdict
1	Power removed from the EUT	A	Pass
2	EUT Switch Off	NA	Pass
3	Hook-On by companion device	B	Pass
4	Hook-On by EUT	NA	Pass
5	Power Removed from Companion Device	B	Pass
6	Companion Device Switch Off	B	Pass

- A - Connection breakdown, Cease of all transmissions
- B - Connection breakdown, EUT transmits control and signaling information
- C - Connection breakdown, Companion Device transmits control and signaling information
- NA - Not Applicable (the EUT does not have an On/Off switch and can not perform Hook-On)

#### Requirements, FCC 15.319(f)

The device shall automatically discontinue transmission in case of either absence of information to transmit or operational failure. These provisions are not intended to preclude transmission of control and signaling information or use of repetitive codes used by certain digital technologies to complete frame or burst intervals.

## 4.8 Peak Power Output

### Test Method:

ANSI C63.17, clause 6.1.2.

**Test Results: Complies**

### Measurement Data:

#### Maximum Conducted Output Power

Channel No.	Frequency (MHz)	Maximum Conducted Output Power (dBm)	Maximum Radiated Output Power (dBm)	Maximum Antenna Gain (dBi)
4	1921.536	16.8	19.0	2.2
2	1924.992	16.8	18.8	2.0
0	1928.448	16.6	18.4	1.8

The Radiated Output Power is measured as Output Power with correction factors stored in the Spectrum Analyzer. The correction factors are stored as Transducer Factors (TDF) and have been obtained through substitution and takes into account cable loss and antenna gain.

For this test it was also checked that input voltage variation of 85 and 115% of nominal value did not have any effect on the measured output power, neither radiated nor conducted.

### Limit:

Conducted:  $100 \mu\text{W} \times \text{SQRT}(B)$  where  $B$  is the measured Emission Bandwidth in Hz

FCC 15.319(c)(e): 20.85 dBm (121.6 mW)

RSS-213, Issue 2: 20.48 dBm (111.8 mW)

The antenna gain is below 3 dBi, no reduction in transmit power is necessary.

### Requirements, FCC 15.319(c)(e), RSS-213, Issue 2

Peak transmit power shall not exceed 100 microwatts multiplied by the square root of the emission bandwidth in Hertz.

The peak transmit power shall be reduced by the amount in decibels that the maximum directional gain of the antenna exceeds 3 dBi.

**Conducted Peak Output Power**

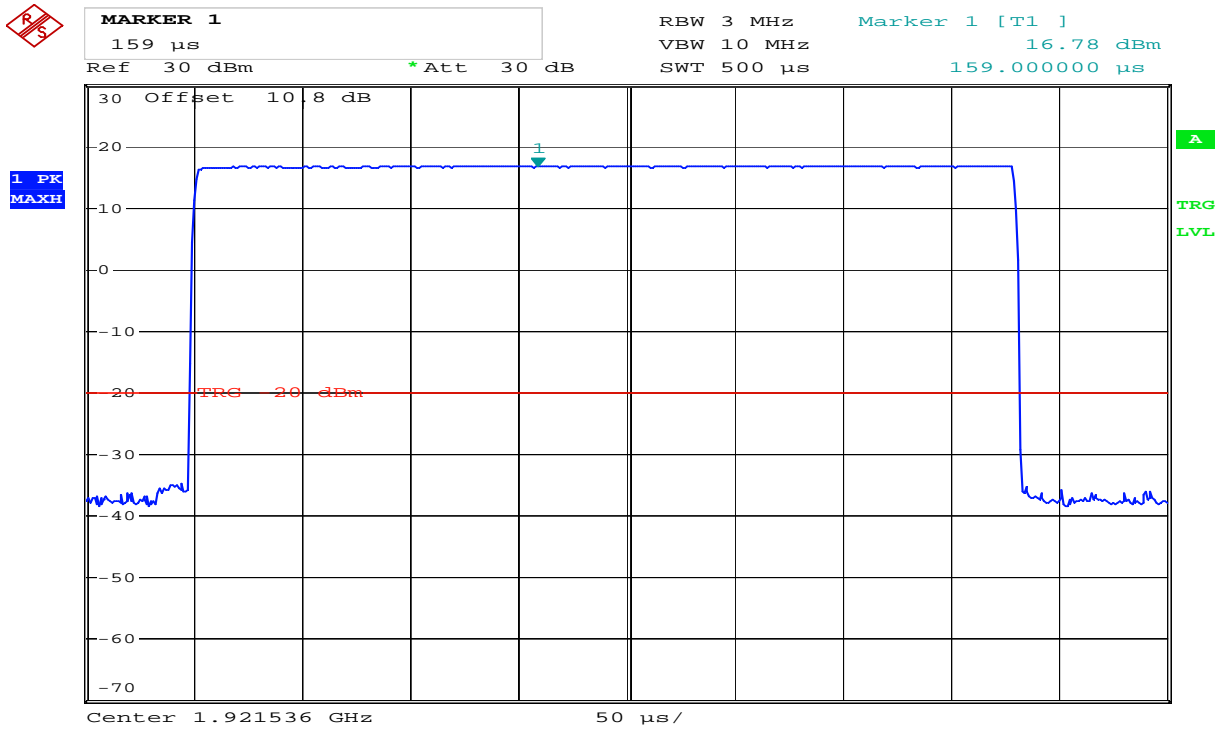

Date: 29.APR.2009 16:19:58

**Lower Channel**

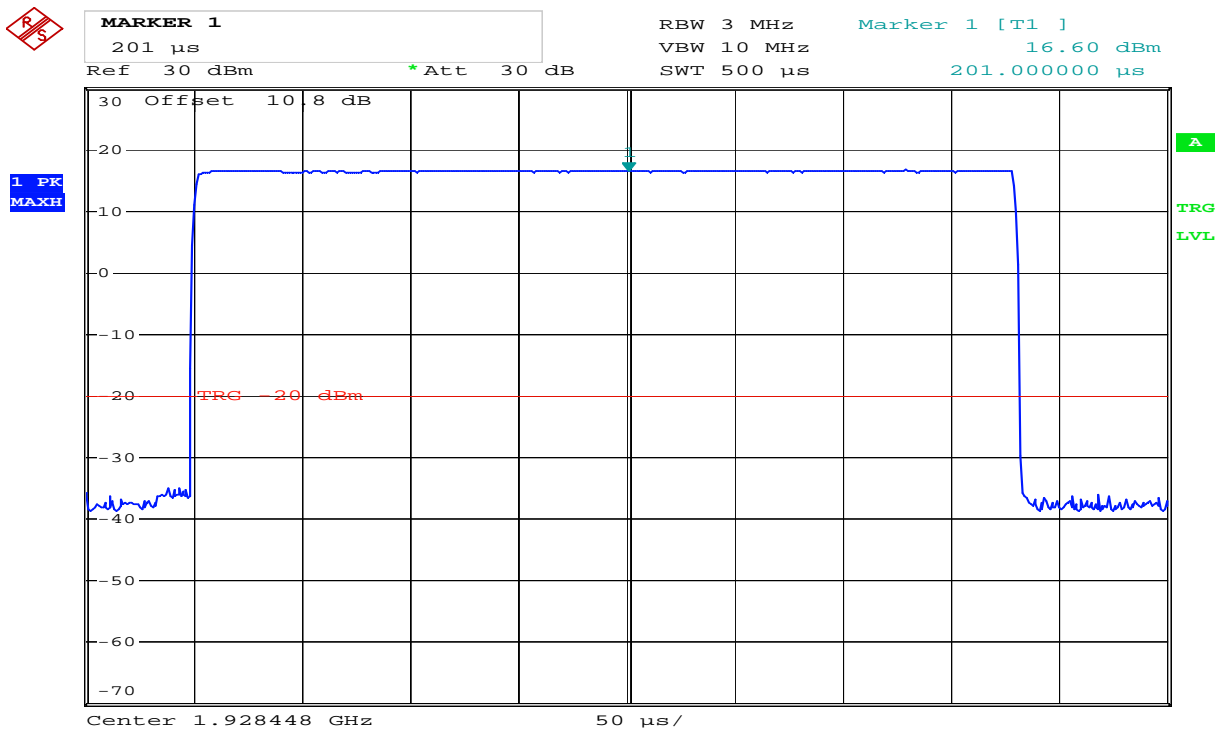

Date: 29.APR.2009 16:19:18

**Upper Channel**



**MARKER 1**  
 148  $\mu$ s  
 Ref 30 dBm \*Att 30 dB

RBW 3 MHz Marker 1 [T1 ]  
 VBW 10 MHz 16.75 dBm  
 SWT 500  $\mu$ s 148.000000  $\mu$ s

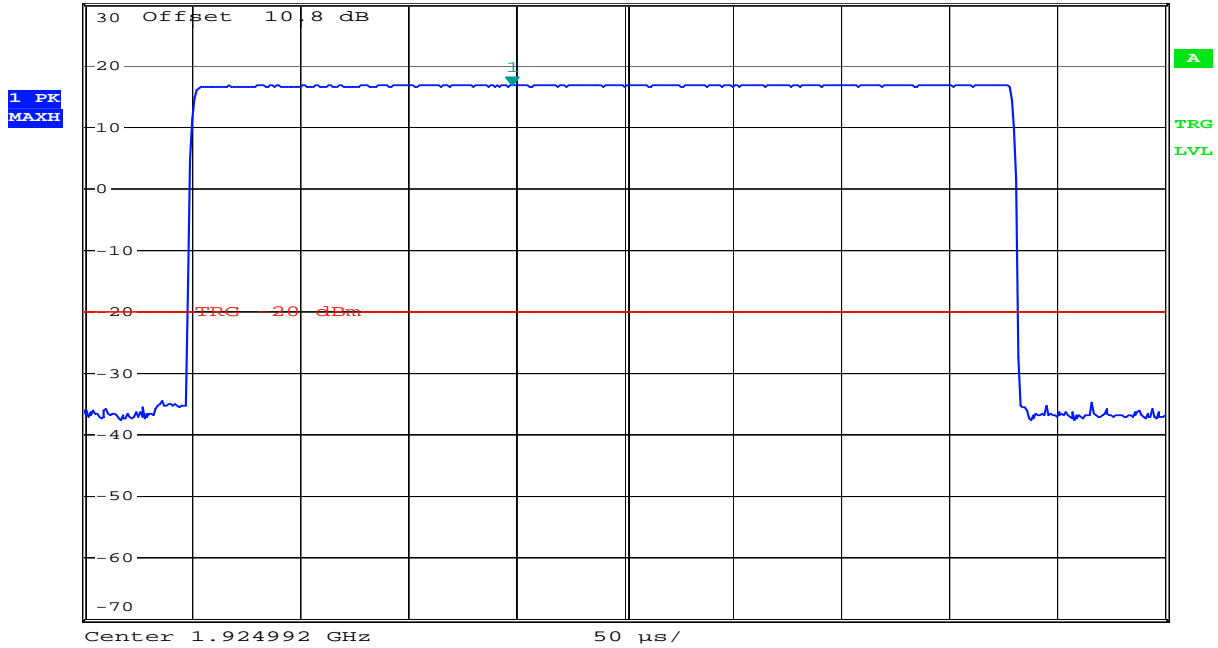

Date: 29.APR.2009 16:18:08

**Middle Channel**

**Radiated Peak Output Power**

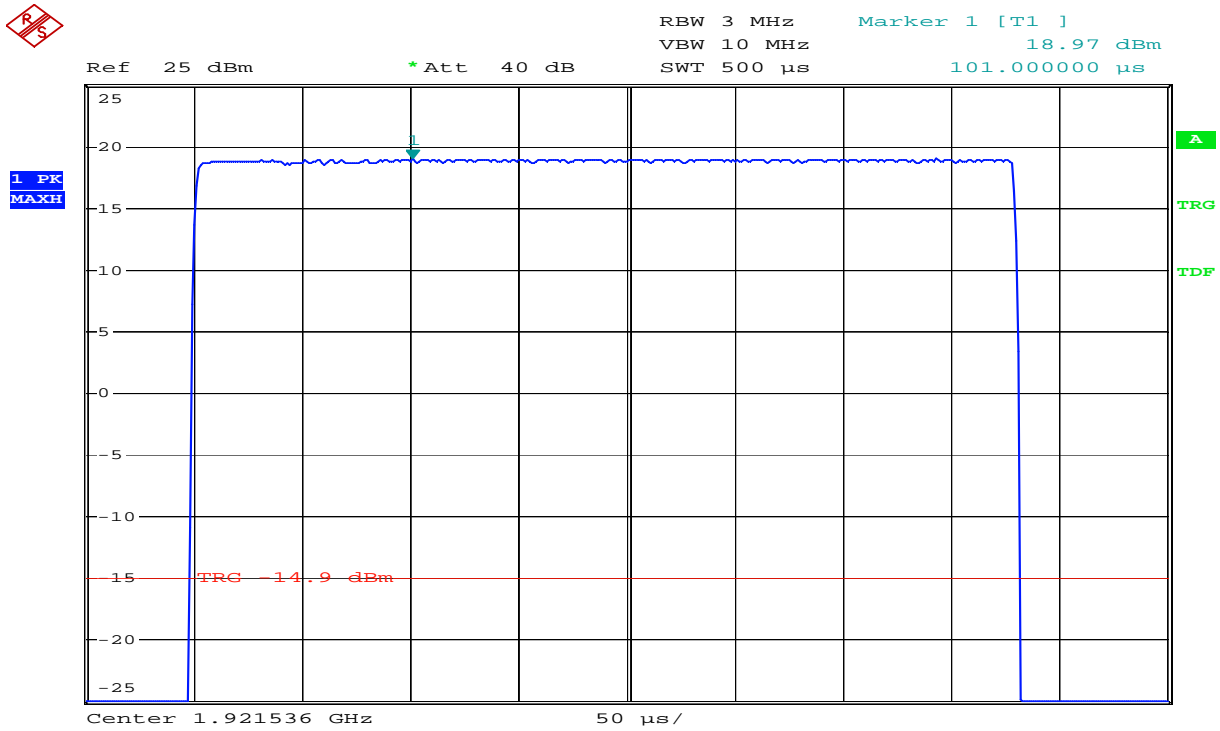

Date: 5.MAY.2009 15:37:22

**Lower Channel (Max: Ant 1, VP)**

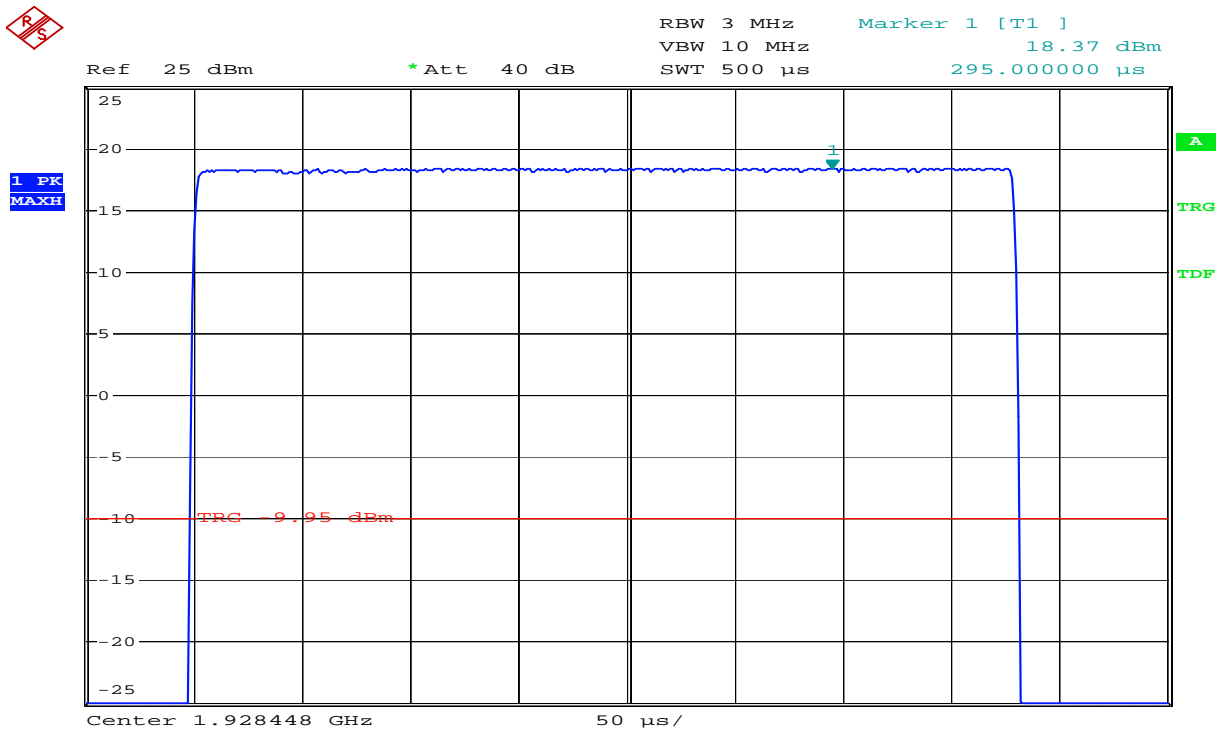

Date: 5.MAY.2009 15:05:59

**Upper Channel (Max: Ant 1, VP)**

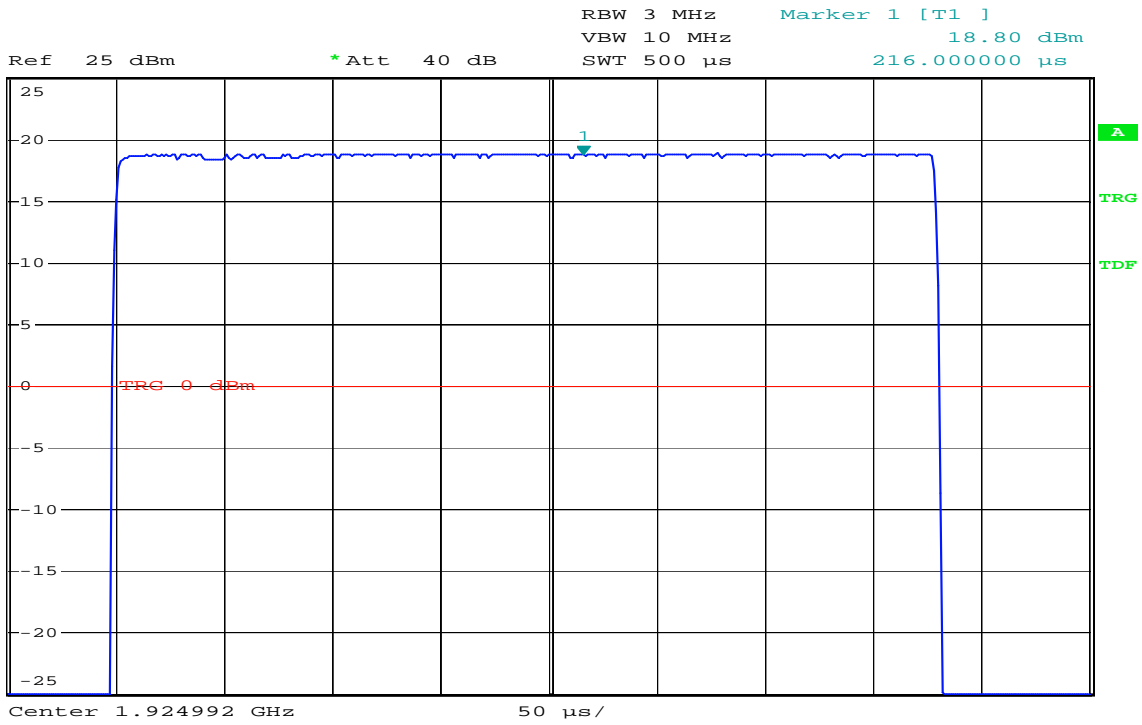

Date: 5.MAY.2009 14:34:33

**Middle Channel (Max: Ant 1, VP)**

## 4.9 Emission Bandwidth *B*

### Test Method:

ANSI C63.17, clause 6.1.3.

### Test Results: Complies

### Measurement Data:

Channel No.	Frequency (MHz)	26 dB Bandwidth <i>B</i> (kHz)
4	1921.536	1490.0
0	1928.448	1480.0

Channel No.	Frequency (MHz)	20 dB Bandwidth (kHz)
2	1924.992	1250.0

Channel No.	Frequency (MHz)	6 dB Bandwidth (kHz)
4	1921.536	NA
0	1928.448	NA

Channel No.	Frequency (MHz)	12 dB Bandwidth (kHz)
4	1921.536	NA
0	1928.448	NA

### Requirements, FCC 15.323(a)

The 26 dB Bandwidth *B* shall be larger than 50 kHz and less than 2.5 MHz.

### Requirements, RSS-213 Issue 2, clause 6.4

The 99% Bandwidth shall be larger than 50 kHz and less than 2.5 MHz.

No requirements for 6 and 12 dB Bandwidth, these values are only used for testing Monitoring Bandwidth if the Simple Compliance test fails (ANSI C63.17, clause 7.4).

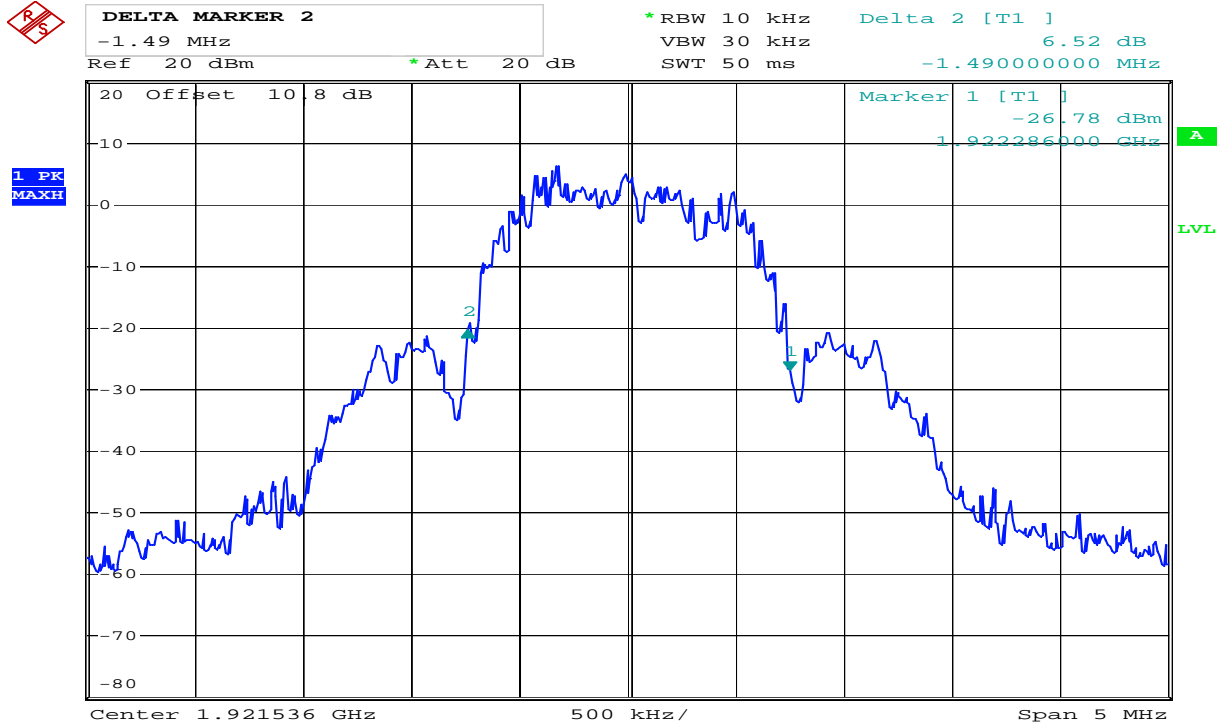

Date: 29.APR.2009 16:23:19

**Emission Bandwidth B, Lower Channel**

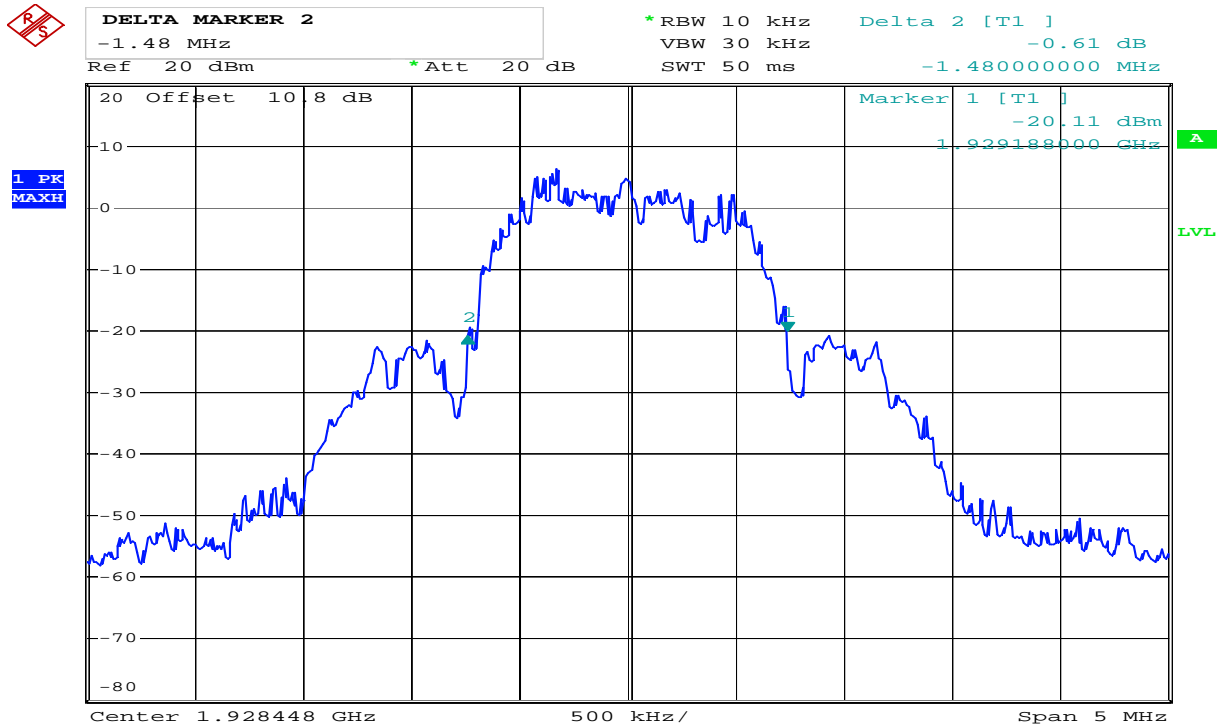

Date: 29.APR.2009 16:26:57

**Emission Bandwidth B, Upper Channel**



POWER BW (%)  
 99 %  
 Ref 20 dBm \*Att 20 dB

\*RBW 10 kHz Marker 1 [T1 ]  
 VBW 30 kHz 1.52 dBm  
 SWT 50 ms 1.924872000 GHz

1 PK  
 MAXH

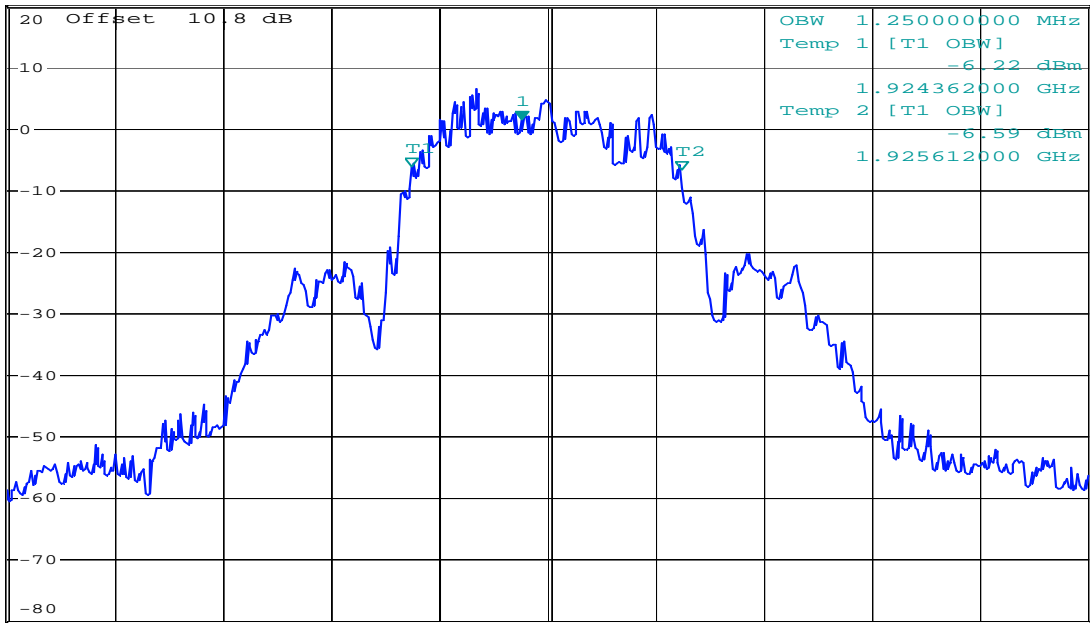

Date: 29.APR.2009 16:28:34

**99% Bandwidth, Middle Channel**

#### 4.10 Power Spectral Density

**Test Method:**

ANSI C63.17, clause 6.1.5.

**Test Results: Complies**

**Measurement Data:**

Channel No.	Frequency (MHz)	Power Spectral Density (dBm)
4	1921.536	0.1
0	1928.448	-0.1

Averaged over 1000 sweeps.

**Requirements, FCC 15.319(d)**

The Power Spectral Density shall be less than 3 mW (4.77 dBm) when averaged over at least 100 sweeps.

**Lower Channel:**

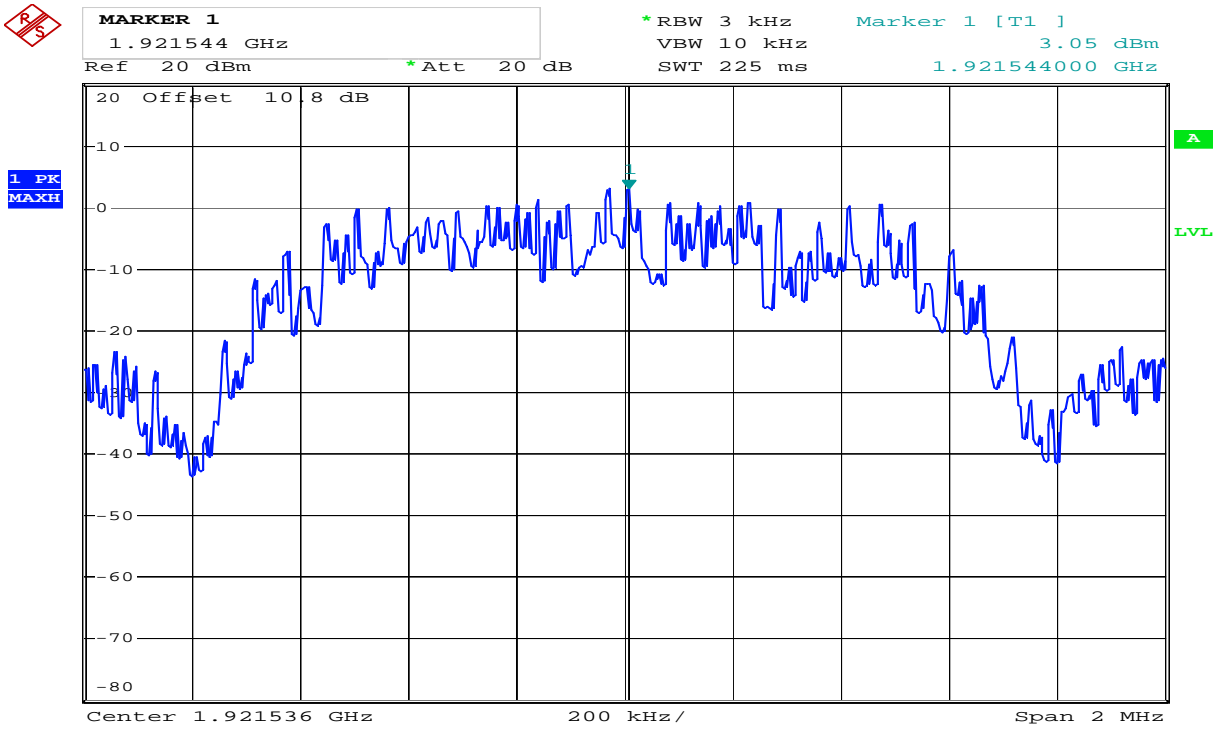

Date: 29.APR.2009 16:42:58

**Overview**

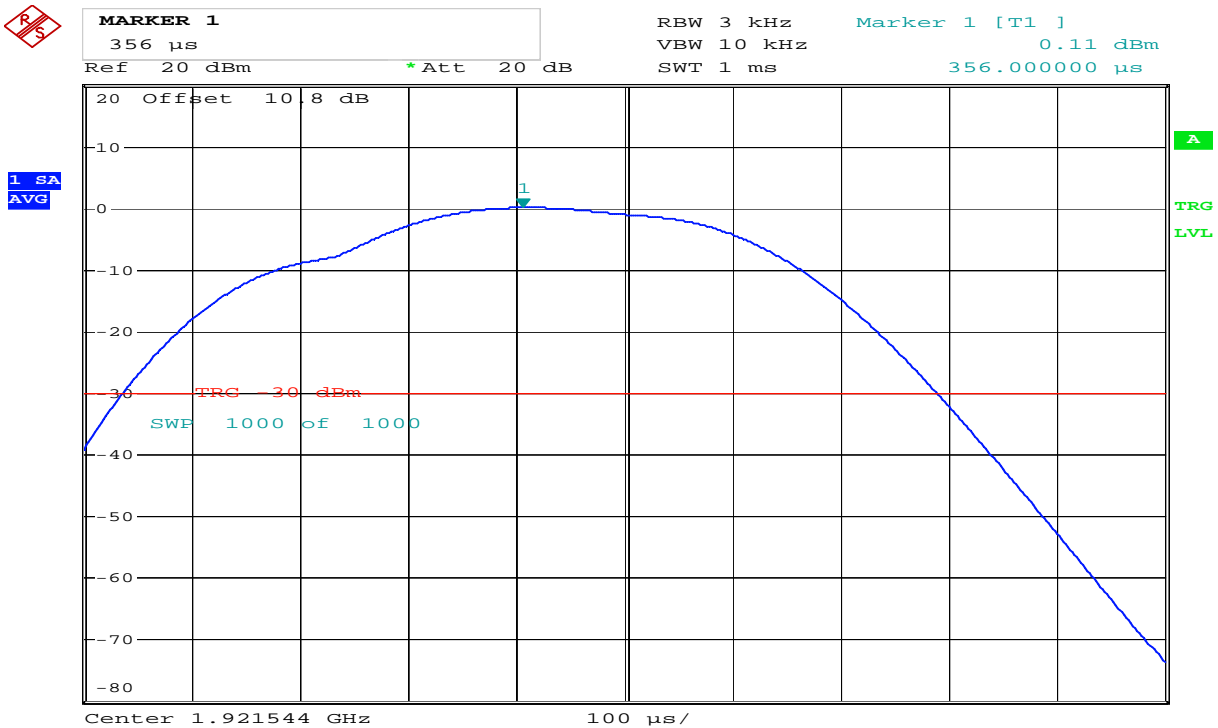

Date: 29.APR.2009 16:46:25

**Averaged, 1000 Sweeps**

**Upper Channel:**

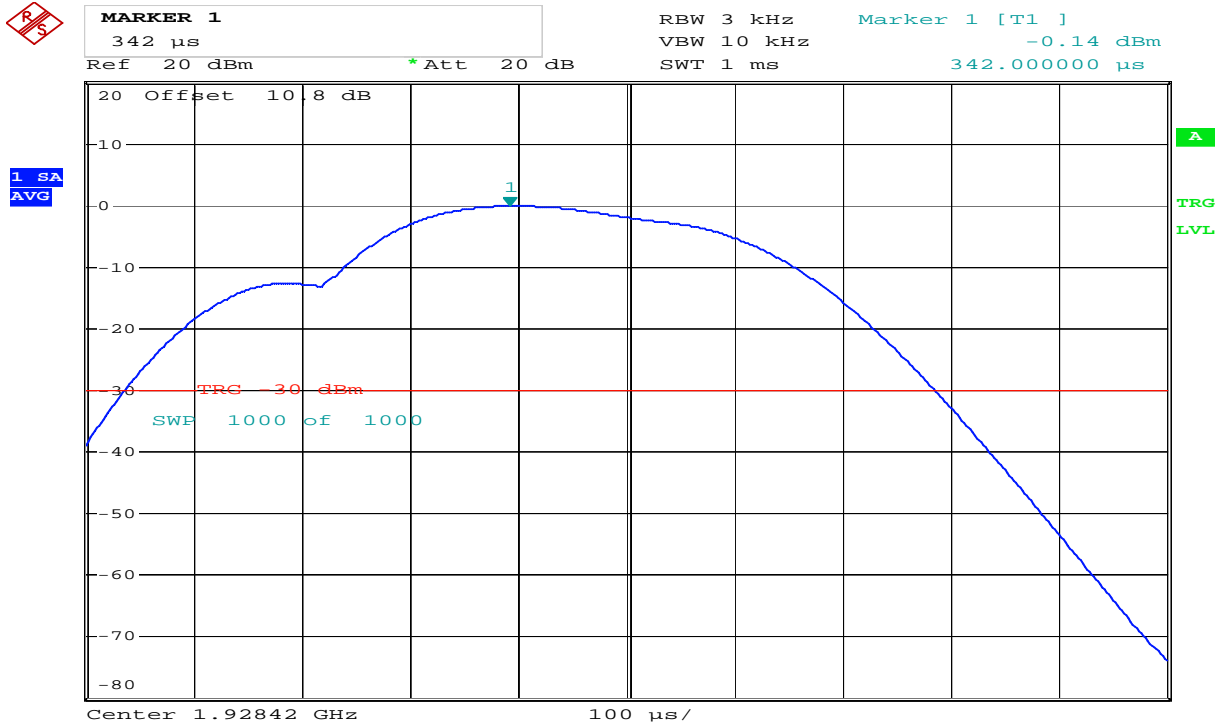

Date: 29.APR.2009 16:40:44

**Overview**

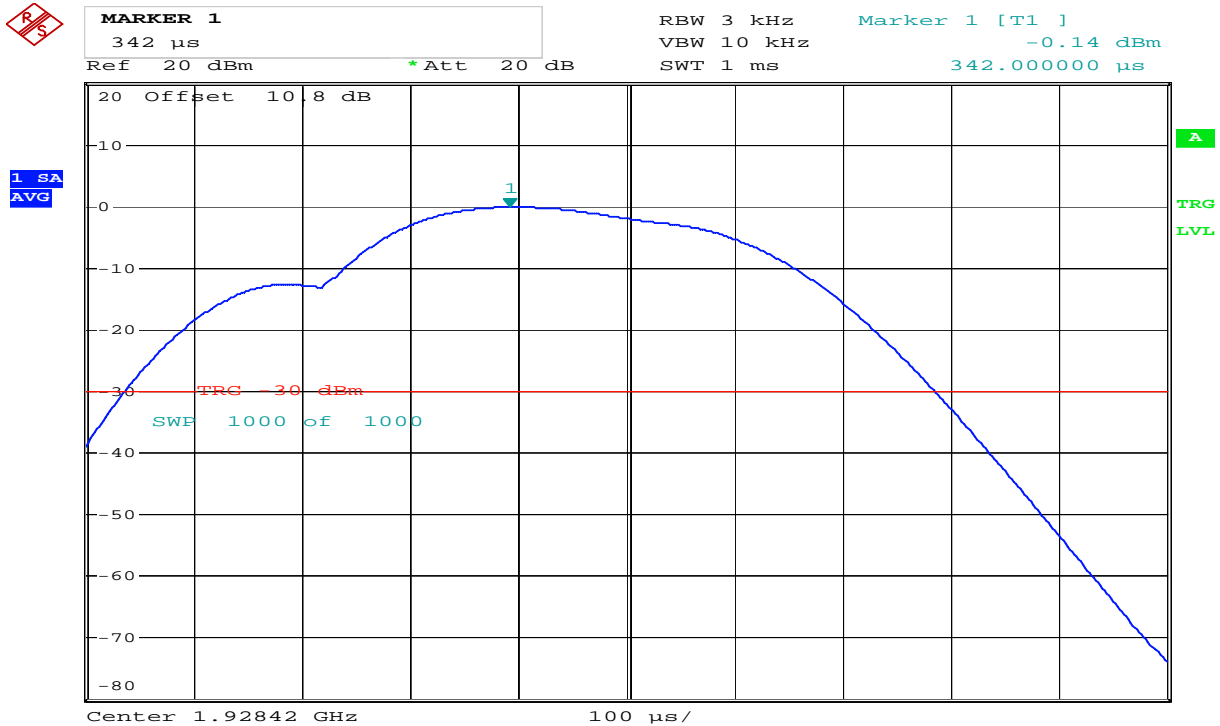

Date: 29.APR.2009 16:40:44

**Averaged, 1000 Sweeps**

### 4.11 In-Band Unwanted Emissions, Conducted

**Test Method:**

ANSI C63.17, clause 6.1.6.1.

**Test Results: Complies**

**Measurement Data:**

See plots.

**Requirements, FCC 15.323(d):**

- $B < f \leq 2B$ : less than or equal to 30 dB below max. permitted peak power level
- $2B < f \leq 3B$ : less than or equal to 50 dB below max. permitted peak power level
- $3B < f \leq$  UPCS Band Edge : less than or equal to 60 dB below max. permitted peak power level

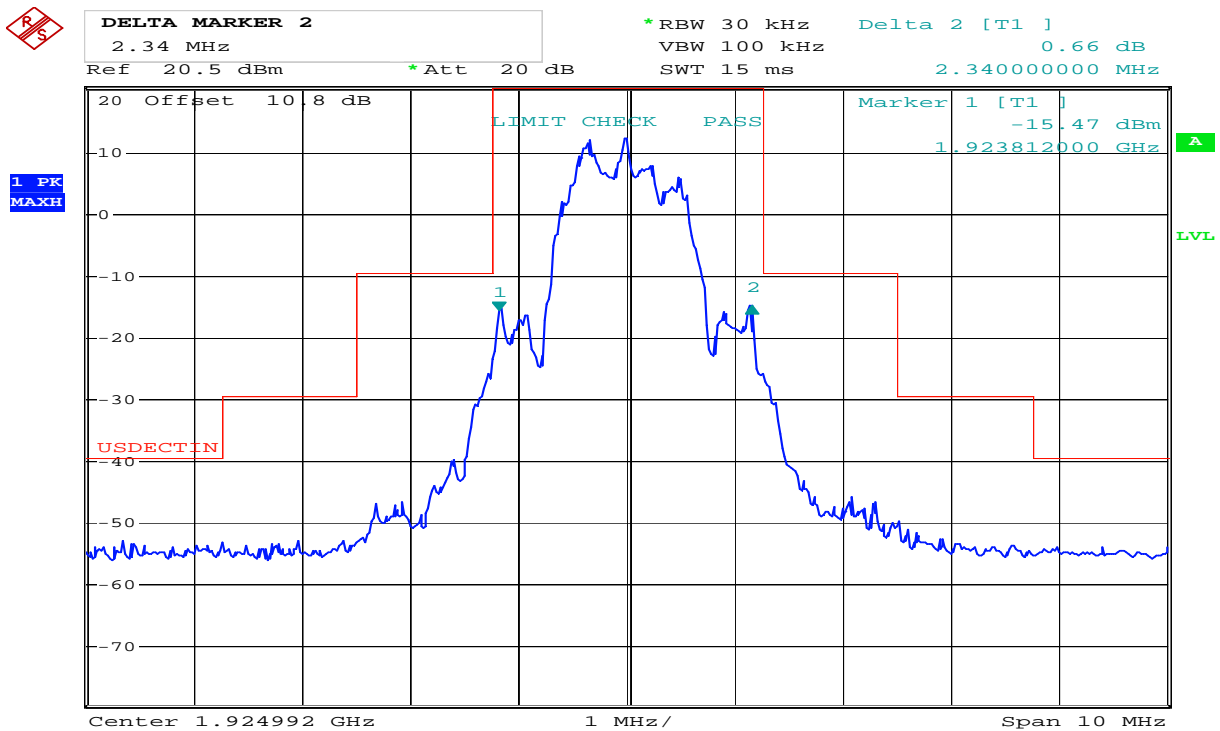

Date: 29.APR.2009 17:16:32

**Middle Channel**

**In-Band Unwanted Emissions, Conducted**

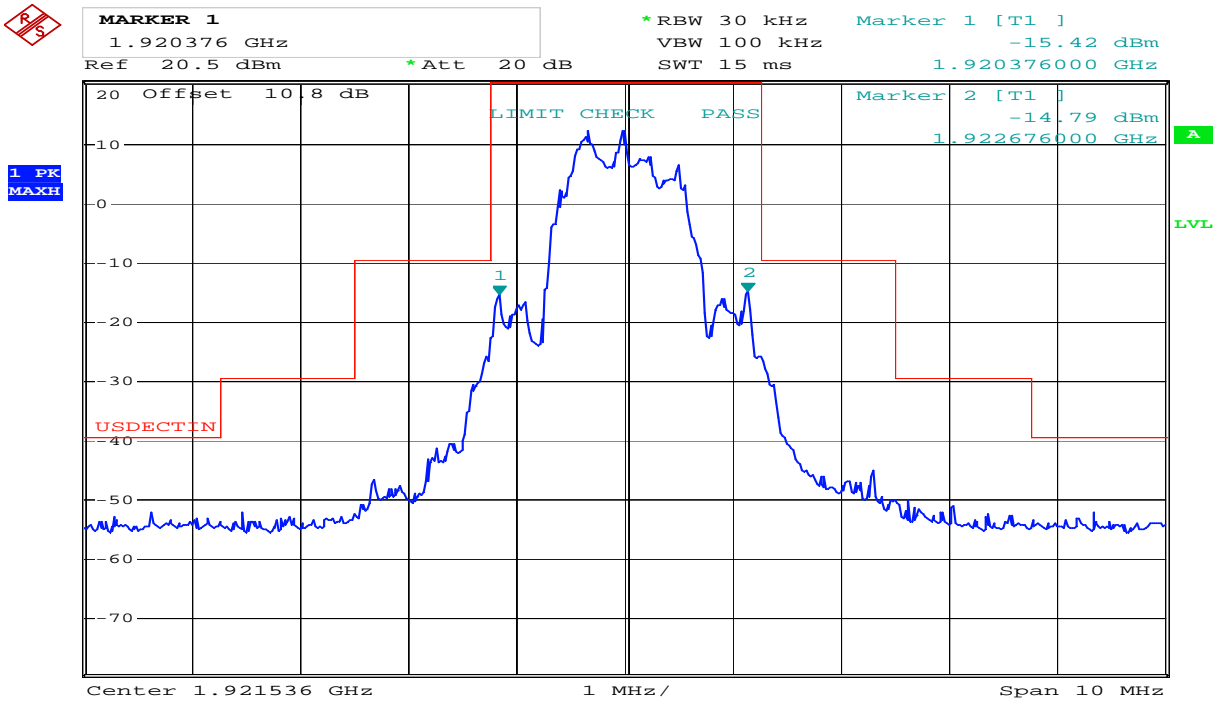

Date: 29.APR.2009 17:13:38

**Lower Channel**

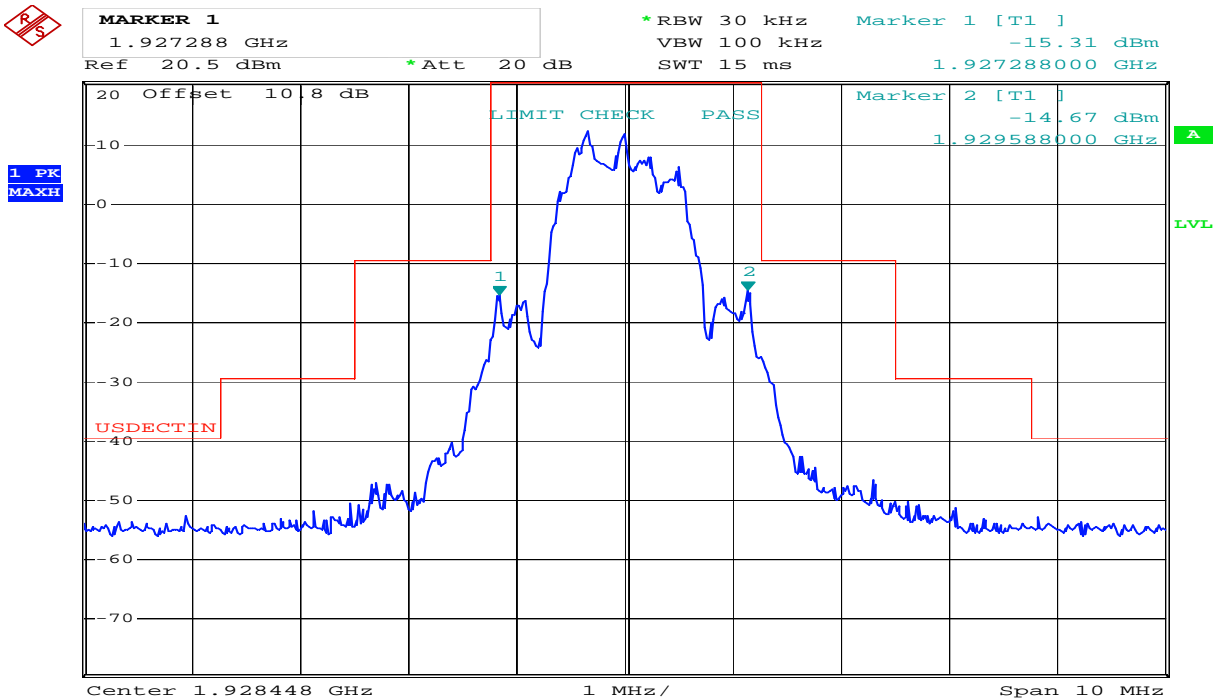

Date: 29.APR.2009 17:15:08

**Upper Channel**

## 4.12 Out-of-band Emissions, Conducted

### Test Method:

ANSI C63.17, clause 6.1.6.2.

### Test Results: Complies

### Measurement Data:

See plots.

### Requirements, FCC 15.323(d):

$f \leq 1.25\text{MHz}$  outside UPCS band :  $\leq -9.5\text{dBm}$   
 $1.25\text{MHz} \leq f \leq 2.5\text{MHz}$  outside UPCS band :  $\leq -29.5\text{ dBm}$   
 $f \geq 2.5\text{MHz}$  outside UPCS band :  $\leq -39.5\text{ dBm}$

### Lower Channel:

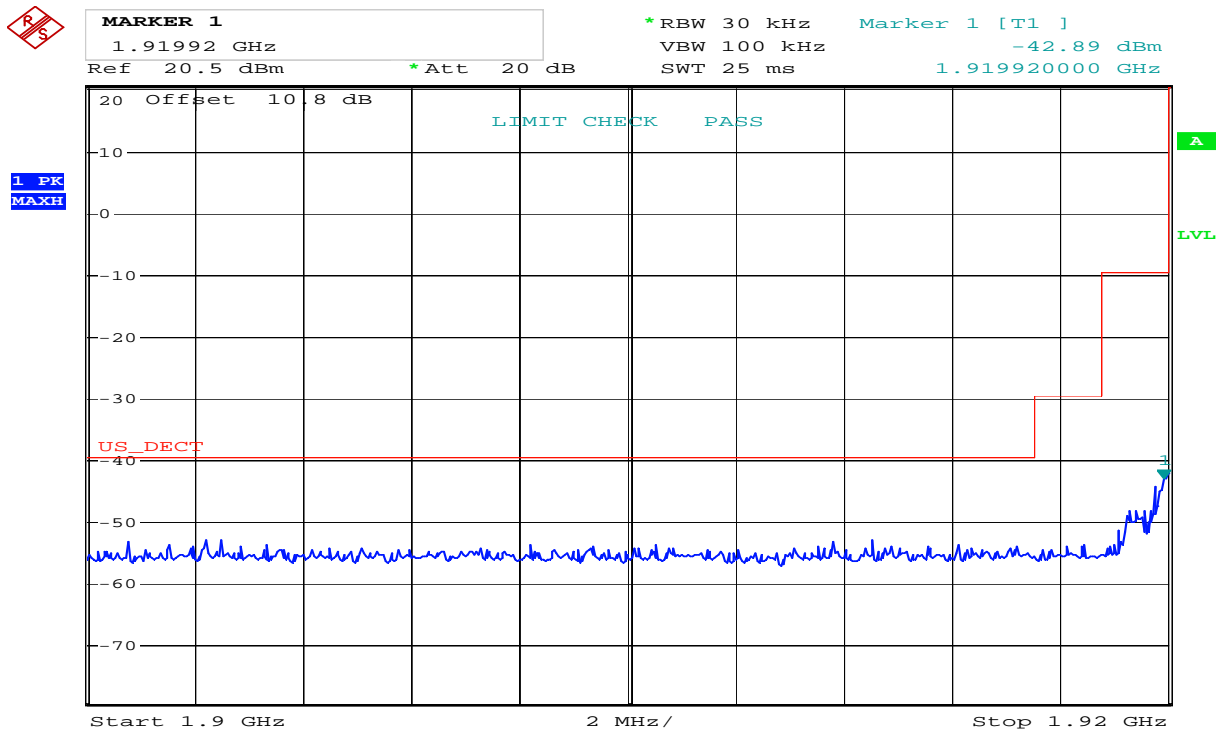

Date: 29.APR.2009 17:21:14

### Out-of-Band Emissions, Conducted

#### Lower Channel:

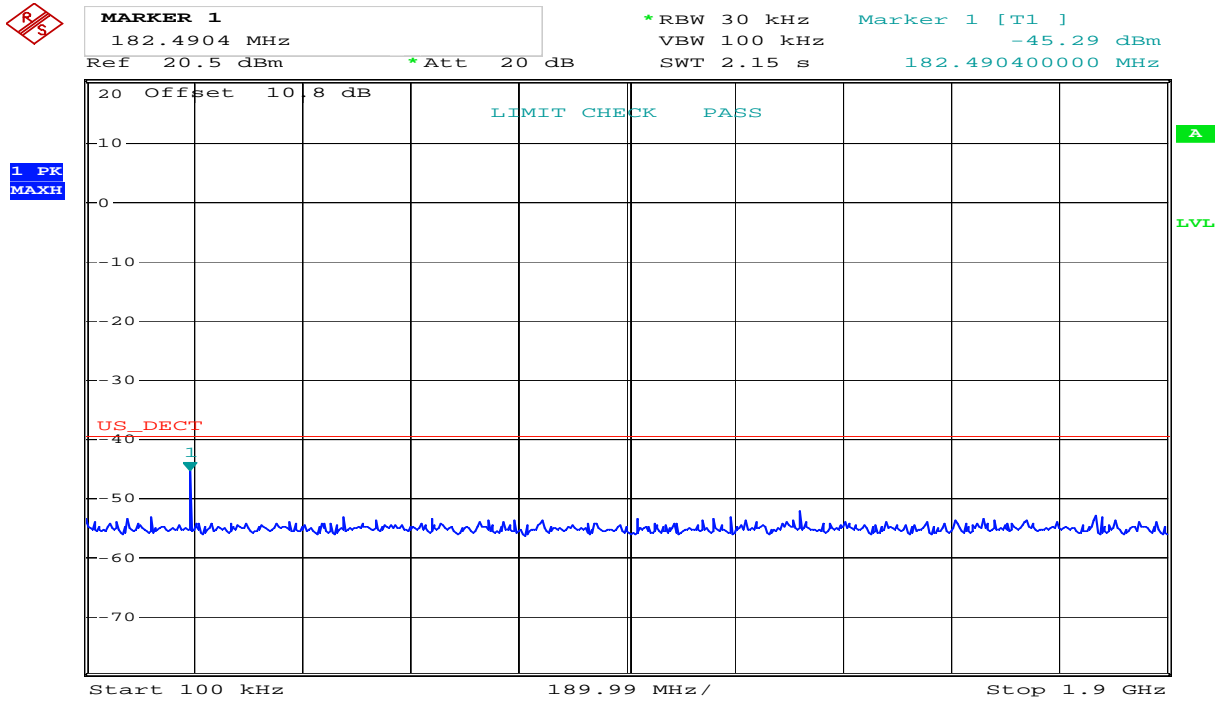

Date: 29.APR.2009 17:22:25

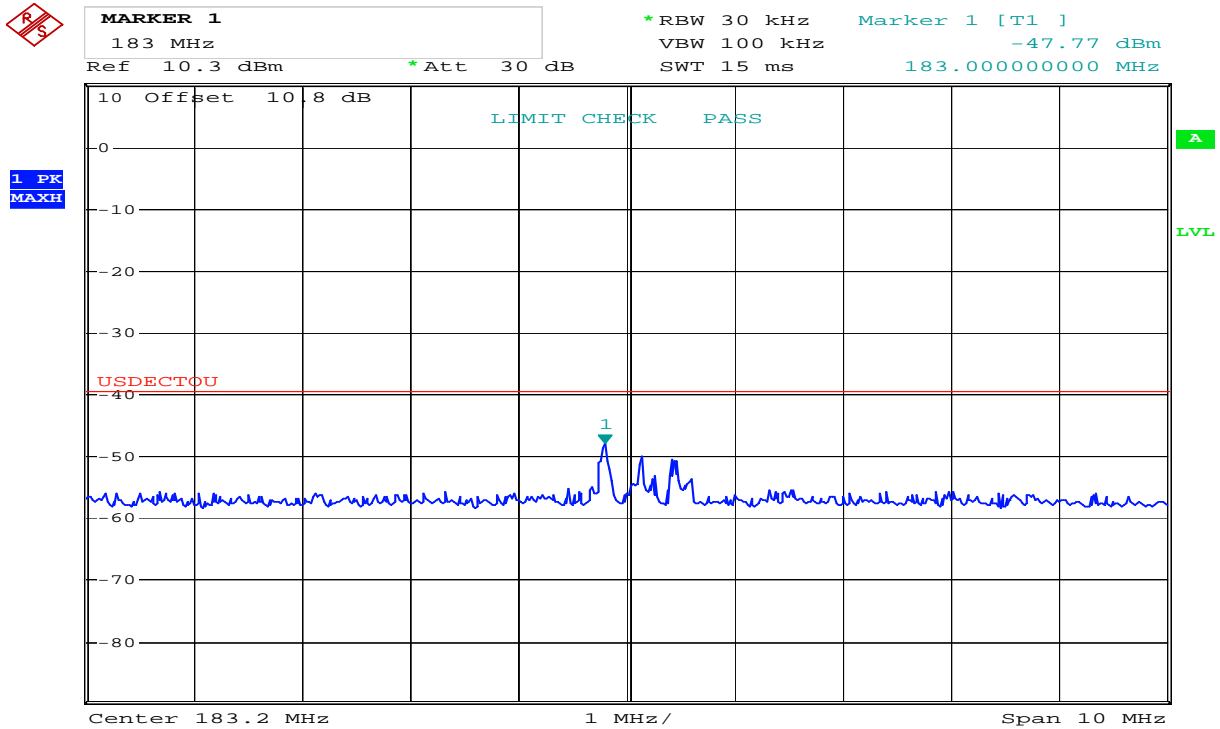

Date: 13.MAY.2009 12:03:08

### Out-of-Band Emissions, Conducted

#### Upper Channel:

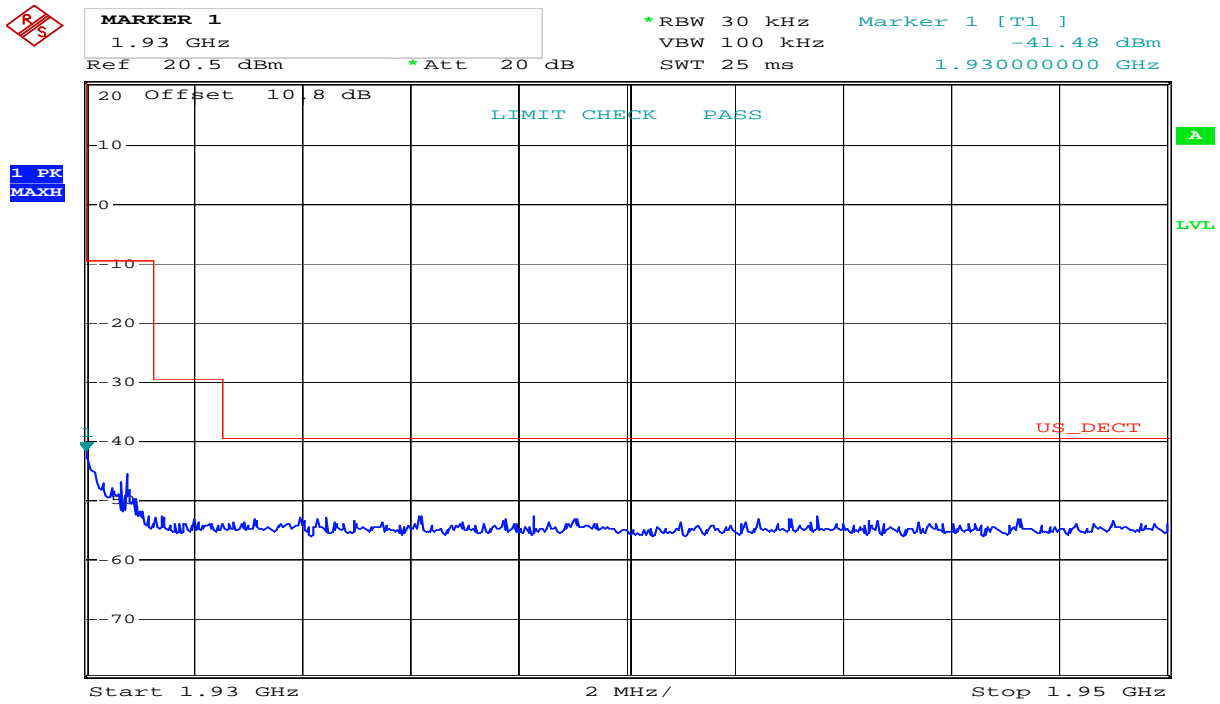

Date: 29.APR.2009 17:24:54

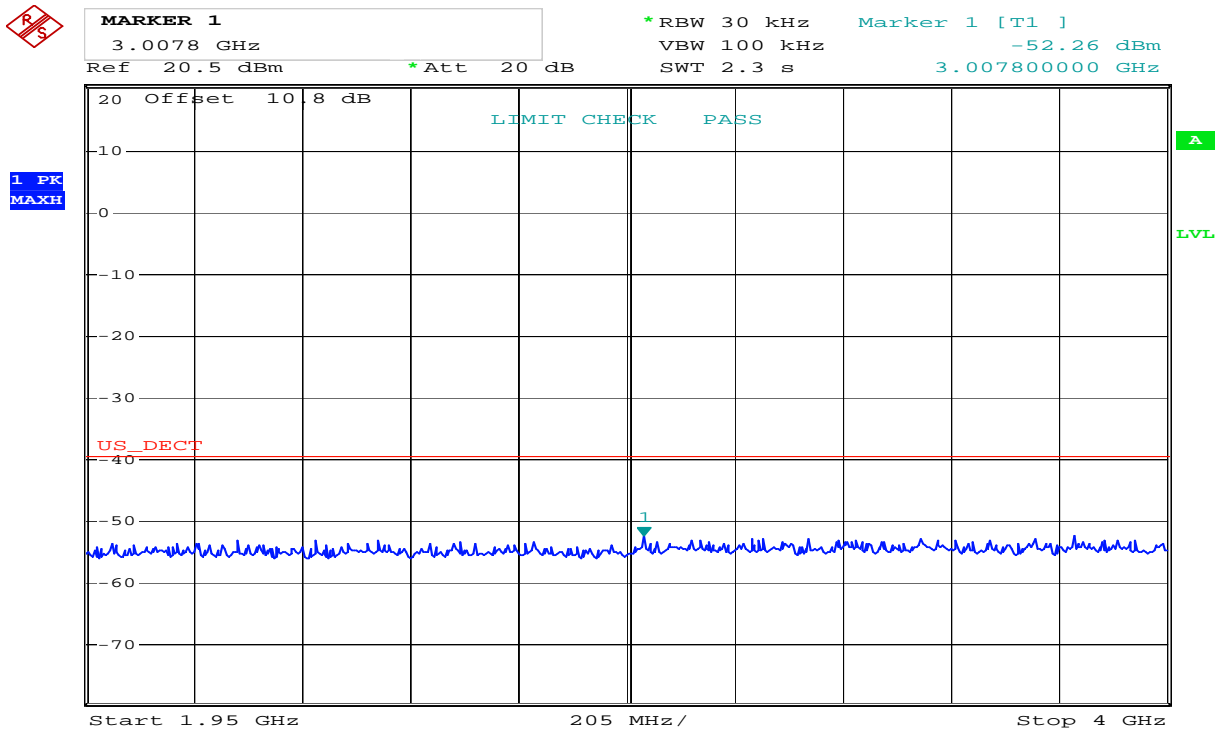

Date: 29.APR.2009 17:25:47

### Out-of-Band Emissions, Conducted

#### Upper Channel:

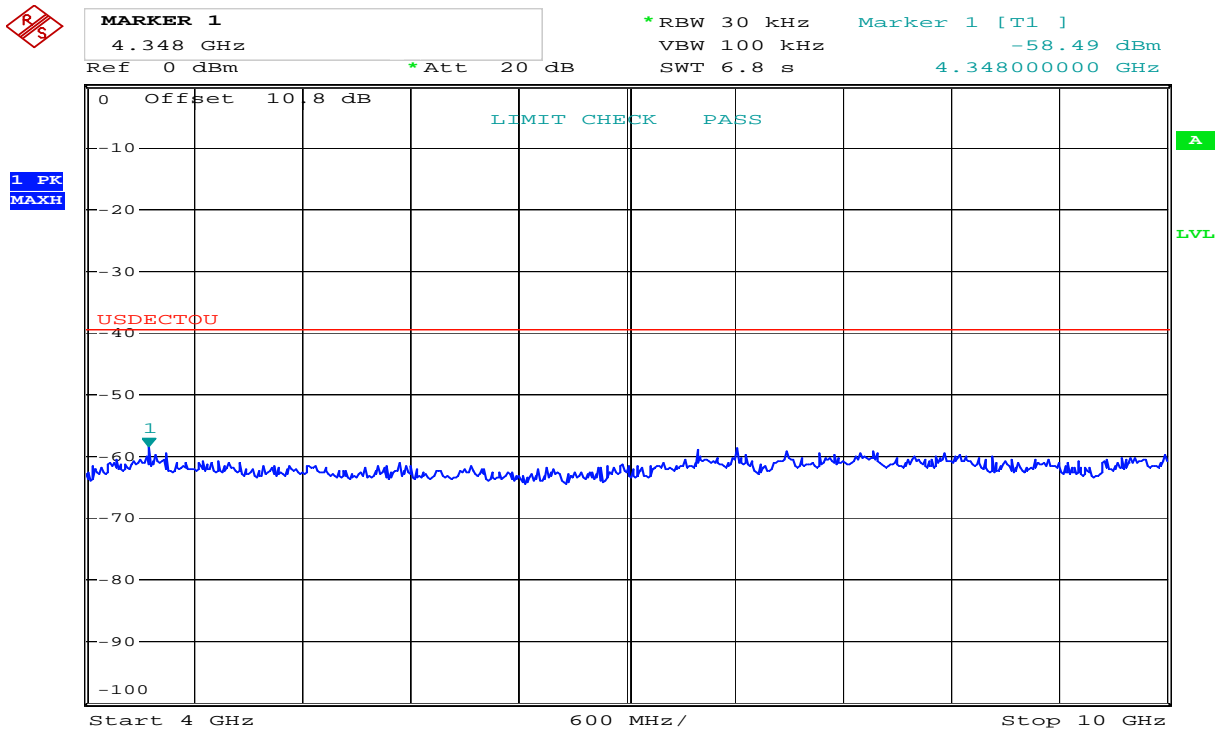

Date: 13.MAY.2009 12:09:38

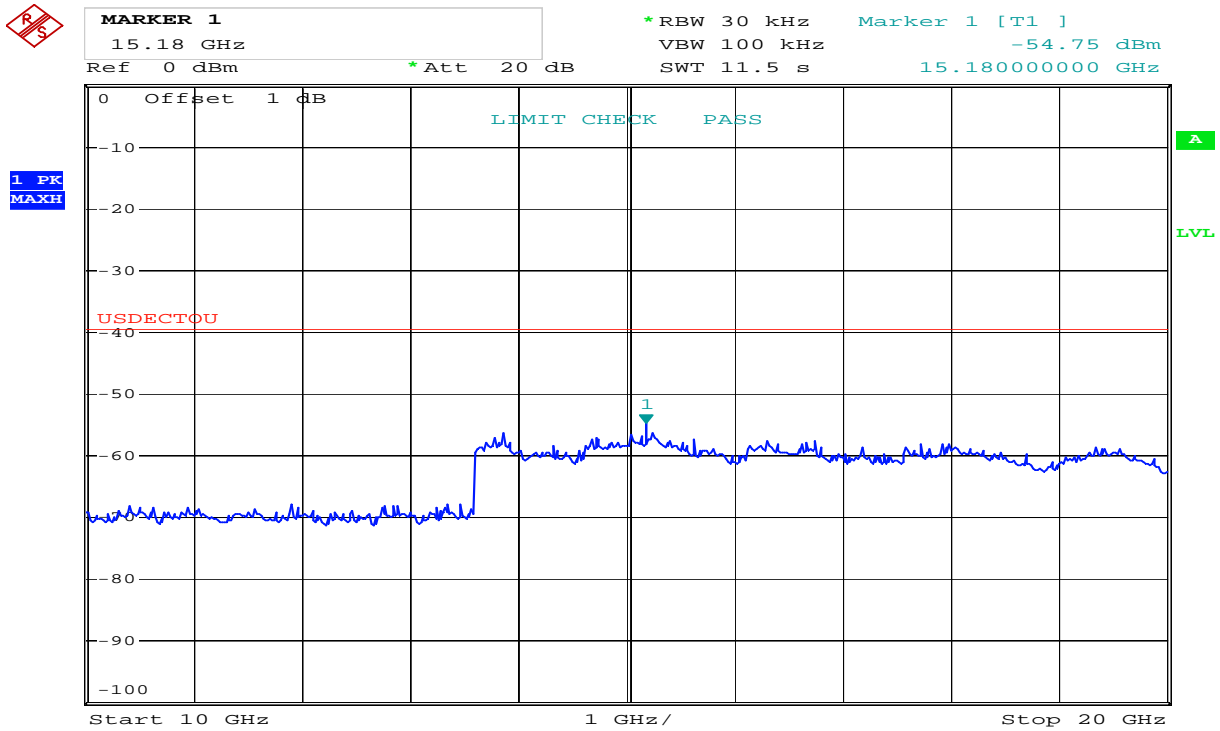

Date: 13.MAY.2009 12:07:03

### 4.13 Carrier Frequency Stability

**Test Method:**

ANSI C63.17, clause 6.2.1.

**Test Results: Complies**

**Measurement Data:**

The Frequency Stability is measured with the CMD60. The CMD60 was logged by a computer programmed to get new readings as fast as possible (about 3 readings per second) over the noted time period or number of readings. The peak-to-peak difference was recorded and the mean value and deviation in ppm was calculated.

The Carrier Frequency Stability over Power Supply Voltage and over Temperature is measured with a Frequency Domain Analyzer in histogram mode.

**Carrier Frequency Stability over Time at Nominal Temperature**

Average Mean Carrier Frequency (MHz)	Mean. Diff. (kHz)	Max. Diff. (kHz)	Max. Dev. (ppm)	Limit
1924.980411	-11.589	-15.25	-1.9	±10 ppm

Deviation ppm = ((Max.Diff. - Mean Diff) / Mean Carrier Freq.) x 10<sup>6</sup>

Deviation (ppm) is calculated from 3000 readings.

**Frequency Stability over Power Supply Voltage at Nominal Temperature**

Voltage	Measured Carrier Frequency (MHz)	Difference (kHz)	Deviation (ppm)	Limit
V <sub>nom</sub>	1924.968438	0	0	±10 ppm
85% of V <sub>nom</sub>	1924.967808	-0.6	-0.3	
115% of V <sub>nom</sub>	1924.967257	-1.2	-0.6	

Deviation ppm = ((Mean – Measured Frequency) / Mean) x 10<sup>6</sup>

**Frequency Stability over Temperature**

Temperature	Measured Carrier Frequency (MHz)	Difference (kHz)	Deviation (ppm)	Limit
T = +20 °C	1924.966998	0	0	±10 ppm
T = -20 °C	1924.983950	17.0	8.8	
T = +50 °C	1924.967142	0.1	0.1	

Deviation ppm = ((Mean – Measured Frequency) / Mean) x 10<sup>6</sup>

#### 4.14 Frame Repetition Stability

**Test Method:**

ANSI C63.17, clause 6.2.2.

**Test Results: Complies**

**Measurement Data:**

The envelope of the RF signal from the EUT is detected with a Crystal Detector and the mean and standard deviation of the frame repetition frequency is then gated over 100 frames and measured with a Frequency Domain Analyzer. The frame repetition stability is 3 times the standard deviation.

Carrier Frequency (MHz)	Mean (Hz)	Standard Deviation (Hz)	Frame Repetition Stability (ppm)
1924.992	99.9996	0.000003997	0.120

**Limit:**

<b>Frame Repetition Stability</b>	±10 ppm (TDMA)
-----------------------------------	----------------

Ref. FCC 15.323(e), ANSI C63.17, clause 6.2.2

#### 4.15 Frame Period and Jitter

**Test Method:**

ANSI C63.17, clause 6.2.3.

**Test Results: Complies**

**Measurement Data:**

Carrier Frequency (MHz)	Frame Period (ms)	Max Jitter (µs)	3xStandard Deviation of Jitter (µs)
1924.992	10.000	-0.0885	-0.052

Max Jitter = (1/ (Frame period + Pk-Pk/2)) - (1/Frame Period), when Pk-Pk and Frame Period are in Hz

3xSt.Dev.Jitter = 3x (1/(Frame Period + St.Dev) – 1/St.Dev) x 10<sup>6</sup>

**Limit:**

<b>Frame Period</b>	20 or 10 ms
<b>Max Jitter</b>	25 µs
<b>3 times St.Dev of Jitter</b>	12.5 µs

Ref. FCC 15.323(e), ANSI C63.17, clause 6.2.3

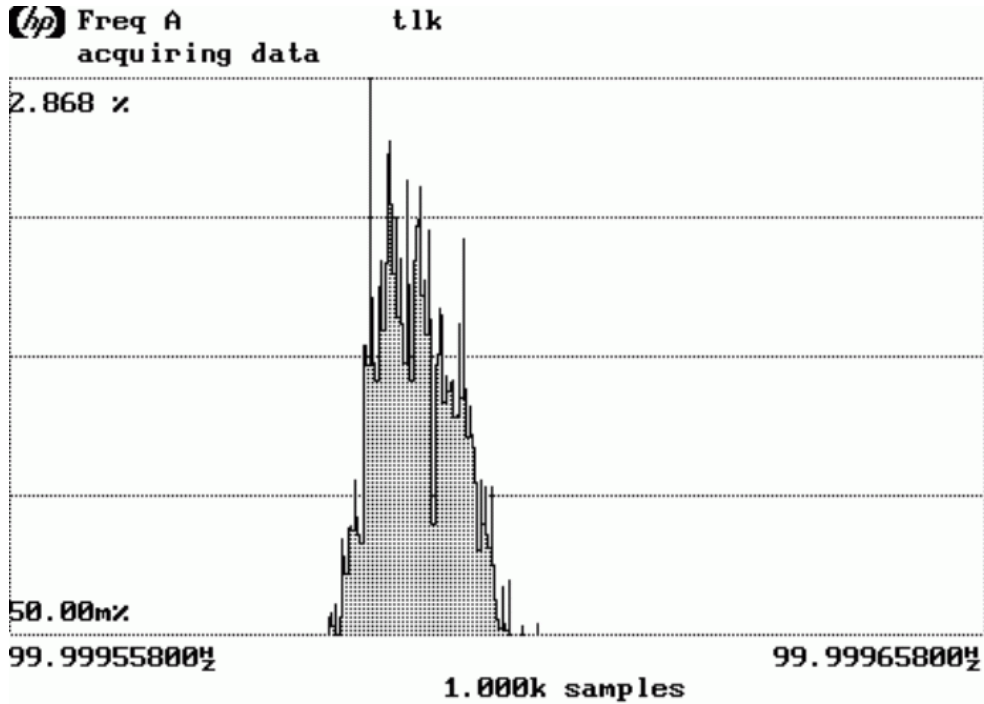

Mean 99.9995996599 Hz 1/Mean 10.000ms  
 Pk-Pk 21.38 μHz Std Dev 3.9974 μHz

Frame Repetition Stability, Gated over 100 Frames

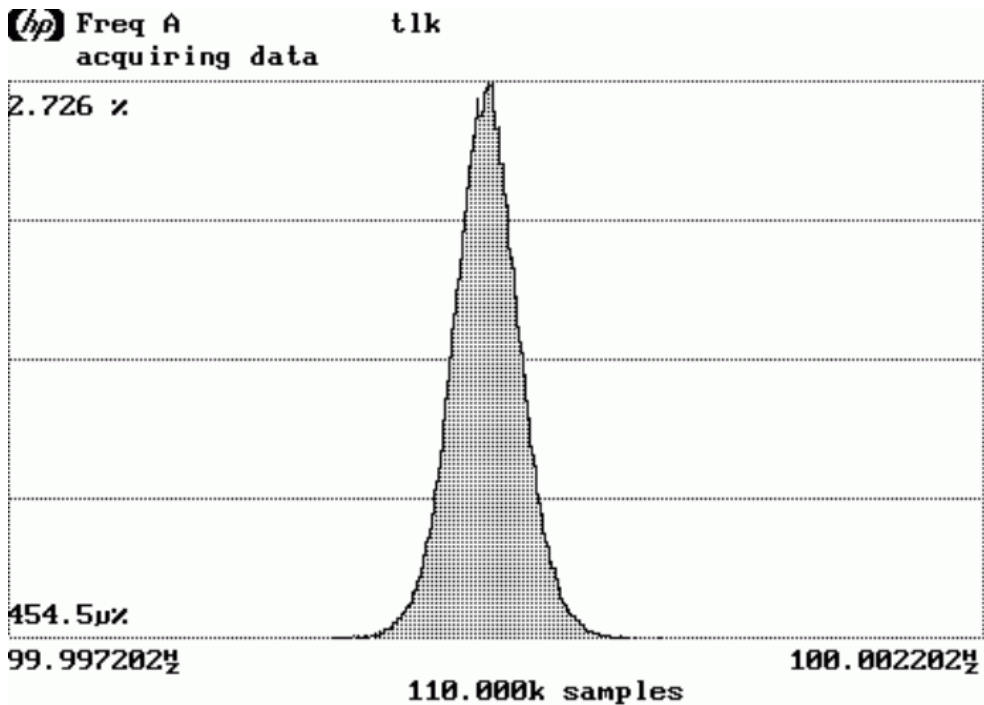

Mean 99.999654269 Hz 1/Mean 10.000ms  
 Pk-Pk 1.771m Hz Std Dev 173.300 μHz

Frame Period and Jitter

## 4.16 Monitoring Threshold, Least Interfered Channel

### Monitoring Threshold Limits:

Lower Threshold:

$$T_L = 15 \log B - 184 + 30 - P_{EUT} \quad (\text{dBm})$$

Upper Threshold:

$$T_U = 15 \log B - 184 + 50 - P_{EUT} \quad (\text{dBm})$$

$B$  is measured Emission Bandwidth in Hz  
 $P_{EUT}$  is measured Transmitter Power in dBm

Calculated values:

Lower Threshold	-78.2 dBm
Upper Threshold	-58.2 dBm

The Lower Threshold is applicable for systems which have defined less than 40 duplex system access channels. The Upper Threshold is applicable for systems with more than 40 duplex system access channels and that implements the Least Interfered Channel Procedure (LIC).

### Measurement Procedure:

The Upper or Lower Threshold is found by the procedure defined in ANSI C63.17 clause 7.3.1 or 7.3.2.

<b>Least Interfered Channel Procedure NOT used:</b>	
Lower Threshold	NA dBm
<b>Least Interfered Channel Procedure:</b>	
Upper Threshold	-60.7 dBm

### Least Interfered Channel (LIC) Procedure Test, FCC 15.323(b), (c)(2) and (c)(5)

ANSI C63.17 clause 7.3.3 ref.	Observation	Verdict
b) $f_1$ $T_L + 13$ dB, $f_2$ at $T_L + 6$ dB	Transmission always on $f_2$	<b>Pass</b>
c) $f_1$ $T_L + 6$ dB, $f_2$ at $T_L + 13$ dB	Transmission always on $f_1$	<b>Pass</b>
d) $f_1$ $T_L + 7$ dB, $f_2$ at $T_L$	Transmission always on $f_2$	<b>Pass</b>
e) $f_1$ $T_L$ , $f_2$ at $T_L + 7$ dB	Transmission always on $f_1$	<b>Pass</b>

**Selected Channel Confirmation, FCC 15.323(c)(1) and (5)**

ANSI C63.17 clause 7.3.4	Observation	Verdict
b) Shall <b>not</b> transmit on $f_1$	EUT transmits on $f_2$	<b>Pass</b>
d) Shall <b>not</b> transmit on $f_2$	EUT transmits on $f_1$	<b>Pass</b>

**Limits:**

Lower Threshold + 6 dB margin	-72.2 dBm
Upper Threshold + 6 dB margin	-52.2 dBm

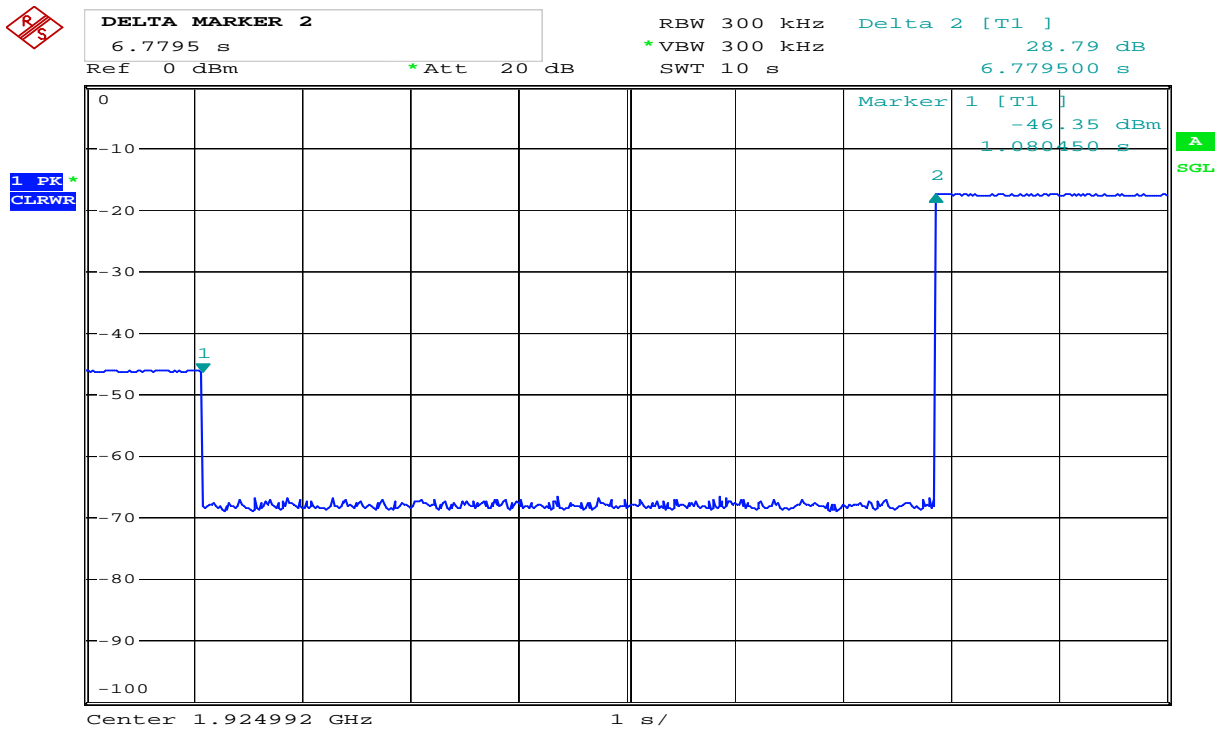

Date: 8.MAY.2009 14:48:40

**7.3.4 Selected Channel Confirmation, Connection 6.8s After Interferer Removed**

#### 4.17 Threshold Monitoring Bandwidth

This test is only required if a dedicated monitoring receiver is used. However, if the test is not carried out the manufacturer shall declare and provide proper evidence that the monitoring is made through the radio receiver used for communication.

##### Measurement Procedure:

Simple Compliance Test, ANSI C63.17, clause 7.4.1

More Detailed Test, ANSI C63.17, clause 7.4.2

The test is passed if **either** the Simple Compliance Test or the More Detailed test is passed.

During this test the spectrum analyzer is observed visually to see if the EUT transmits or not.

##### Test Results:

Test performed	Observation	Verdict
Simple Compliance test, at $\pm 30\%$ of $B$	No transmissions	Pass
More Detailed Test, at -6 dB points	N/A	N/A
More Detailed Test, at -12 dB points	N/A	N/A

The more detailed test must be pass at both the -6 and -12 dB points if the Simple Compliance test fails.

**Comment:** The Simple Compliance Test was performed with the level at  $T_U + U_M + 10$  dB to check that the EUT did not transmit at all.

The tested EUT uses the same receiver for monitoring and communication, this test is therefore not required. However the test has been performed nonetheless and the test is passed.

##### Limits, FCC 15.323(c)(7):

The monitoring system bandwidth must be equal to or greater than the emission bandwidth of the intended transmission.

## 4.18 Reaction Time and Monitoring Interval

### Measurement Procedure

ANSI C63.17, clause 7.5

### Test results:

By administrative commands and out-of-operating region interference, the EUT is restricted to operate on a single carrier frequency.

Time-synchronized pulsed interference was then applied on the carrier at pulsed levels  $T_U + U_M$  to check that the EUT does not transmit at all. The level was raised 6 dB for part d) with 35  $\mu$ s pulses.

The pulses are synchronized with the EUT timeslots and applied centered within all timeslots.

Pulse Width, ref. to ANSI C63.17 clause 7.5	Observation	Verdict
c) > largest of 50 $\mu$ s and $50 \cdot \text{SQRT}(1.25/B)$	No transmissions	Pass
d) > largest of 35 $\mu$ s and $35 \cdot \text{SQRT}(1.25/B)$ , and with interference level raised 6 dB	No transmissions	Pass

**Comment:** Since  $B$  is larger than 1.25 MHz the test was performed with pulse lengths of 50  $\mu$ s and 35  $\mu$ s.

### Limits, FCC 15.323(c)(1), (5) and (7)

The maximum reaction time must be less than  $50 \cdot \text{SQRT}(1.25/\text{emission bandwidth in MHz})$  microseconds for signals at the applicable threshold level but shall not be required to be less than 50 microseconds.

If a signal is detected that is 6 dB or more above the applicable threshold level, the maximum reaction time shall be  $35 \cdot \text{SQRT}(1.25/\text{emission bandwidth in MHz})$  microseconds but shall not be required to be less than 35 microseconds.

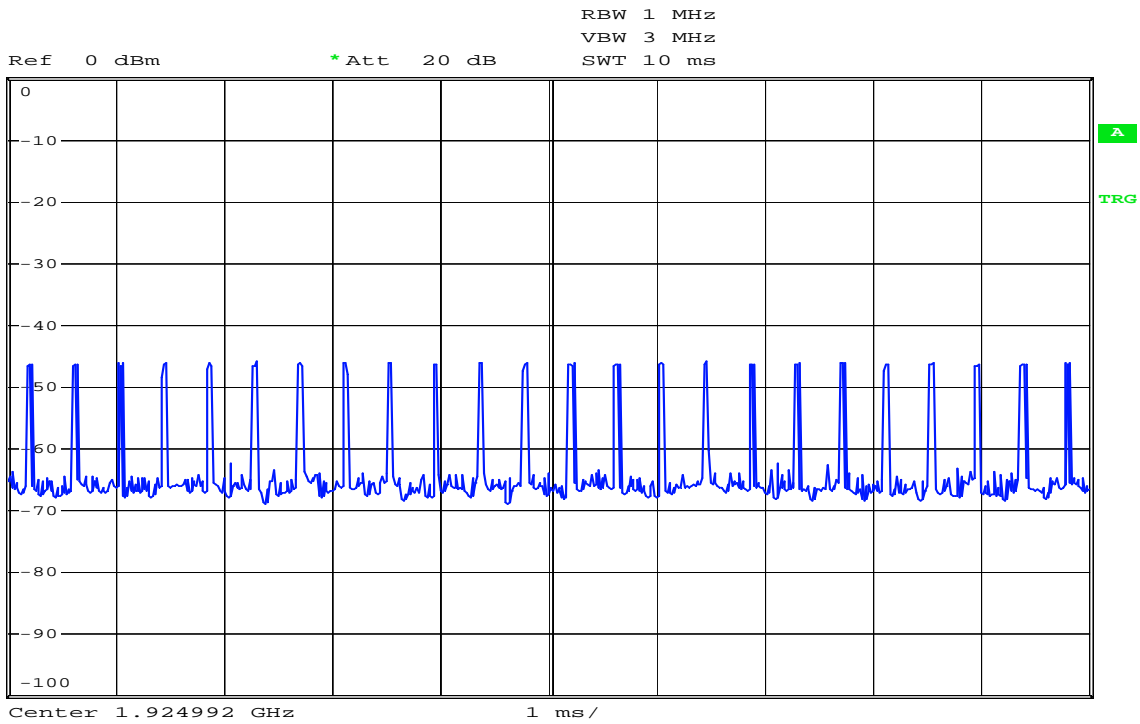

Date: 8.MAY.2009 15:08:22

**50 µs Pulses**

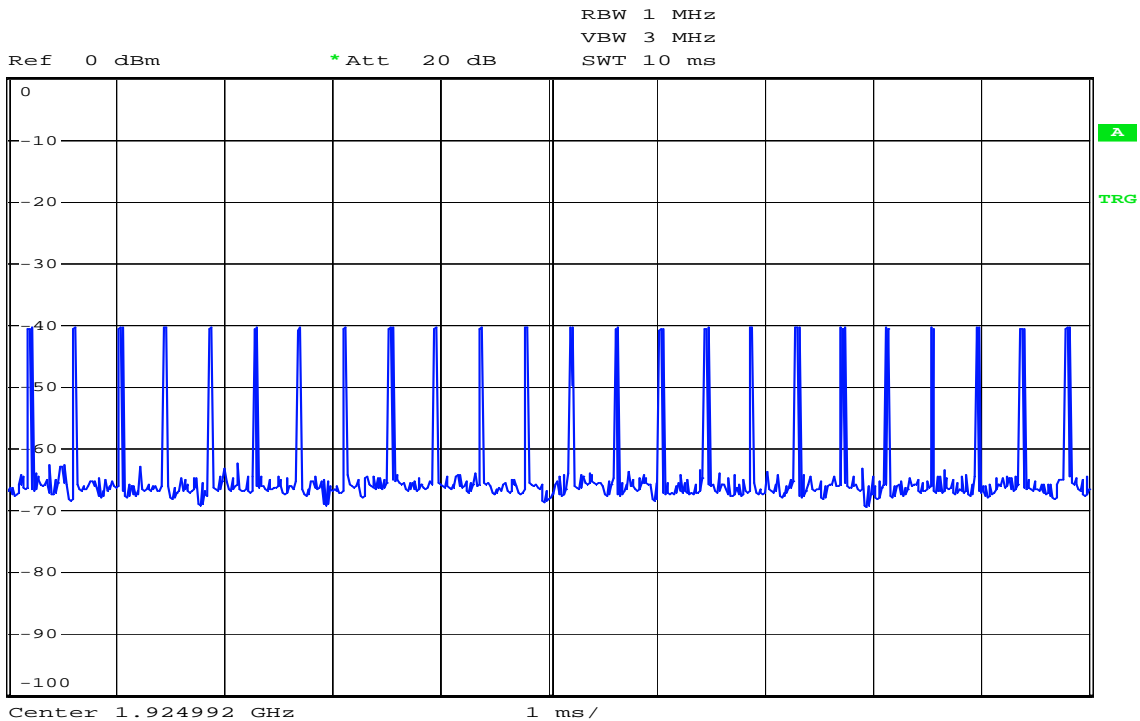

Date: 8.MAY.2009 15:09:31

**35 µs Pulses**

#### 4.19 Time and Spectrum Window Access Procedure

This requirement is only for EUTs which transmit unacknowledged control and signaling information.

**Measurement Procedure:**

Timing for EUTs using control and signaling channel type transmissions: ANSI C63.17, clause 8.1

**Test results:**

Access Criteria, ref. to ANSI C63.17 clause 8.1.1	Observation	Verdict
b) Check that the EUT transmits on the interference free time-slot	EUT transmits on the interference free time-slot	<b>Pass</b>
b) The EUT must terminate or pause in its repetitive transmission of the control and signalling channel on the open channel to repeat the access criteria not less frequently than every 30 s	Transmission paused every 1.9 s	<b>Pass</b>

If FCC 15.323(c)(6) option, **If Random Waiting Interval is NOT implemented**

Access Criteria, ref. to ANSI C63.17 clause 8.1.2	Observation	Verdict
b) Check that the EUT changes to an interference-free slot when interference is introduced on the time slot in use	EUT changes to the interference-free time-slot, and stays there	<b>Pass</b>

If FCC 15.323(c)(6) option, **Only if Random Waiting Interval is implemented**

Access Criteria, ref. to ANSI C63.17 clause 8.1.3	Observation	Verdict
b-d) Check that the EUT uses random waiting interval before continuing transmission on an interfered time slot	N/A	<b>N/A</b>

Comment: The tested EUT does not support the Random Waiting Interval option.

**Limits:**

**FCC 15.323(c)(4):**

Once access to specific combined time and spectrum windows is obtained an acknowledgement from a system participant must be received by the initiating transmitter within one second or transmission must cease. Periodic acknowledgements must be received at least every 30 seconds or transmission must cease. Channels used exclusively for control and signaling information may transmit continuously for 30 seconds without receiving an acknowledgement, at which time the access criteria must be repeated.

**FCC 15.323(c)(6):**

If the selected combined time and spectrum windows are unavailable, the device may either monitor and select different windows or seek to use the same windows after waiting an amount of time, randomly chosen from a uniform random distribution between 10 and 150 milliseconds, commencing when the channel becomes available

**Access Criteria Check**

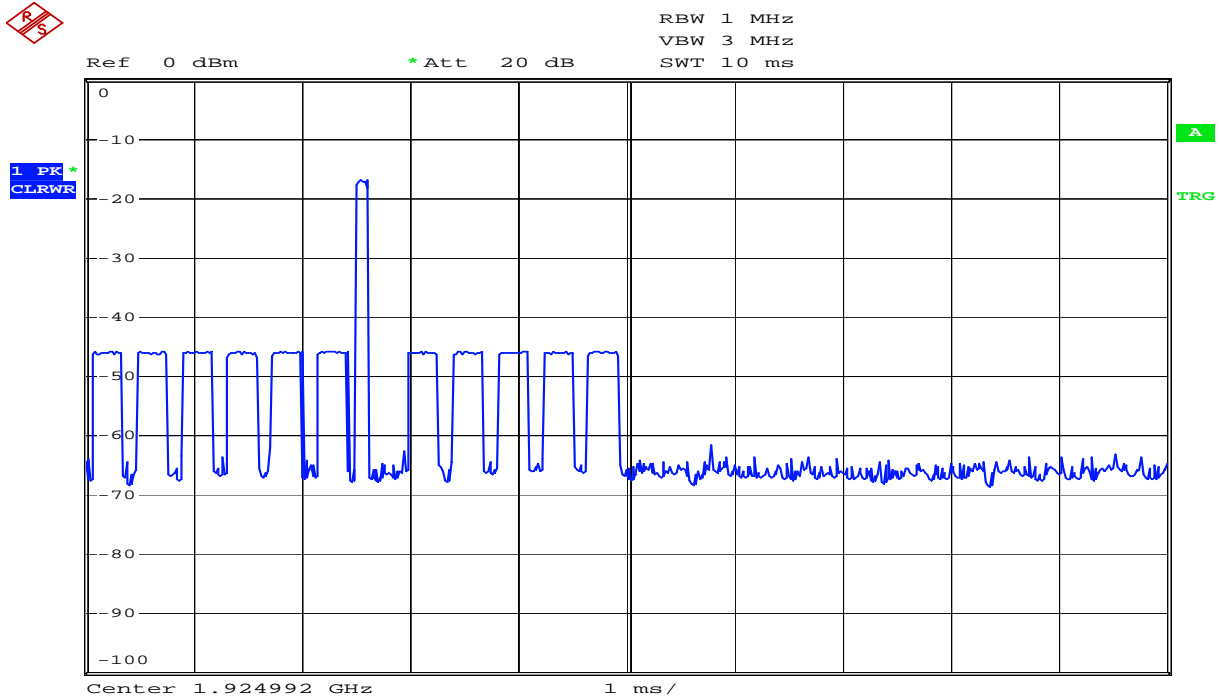

Date: 8.MAY.2009 15:11:42

**8.1.1a) EUT Transmits on Unblocked Slot**

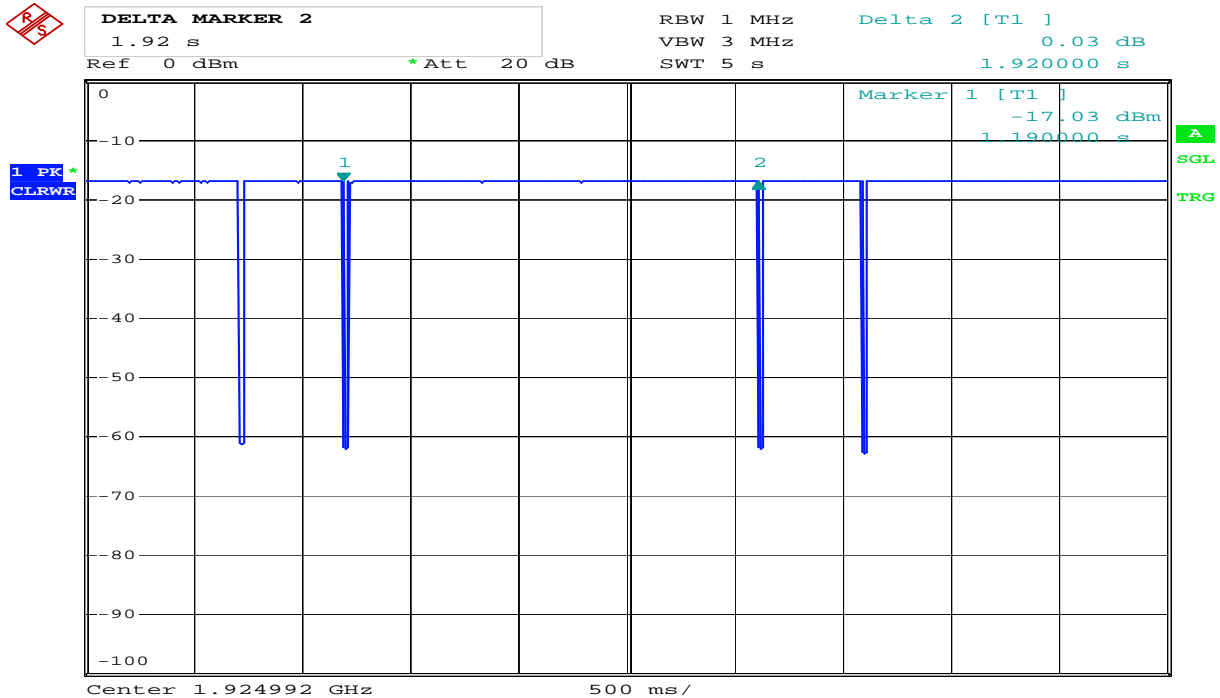

Date: 8.MAY.2009 15:14:45

**8.1.1b) Access Criteria check Interval**

### Access Criteria Check

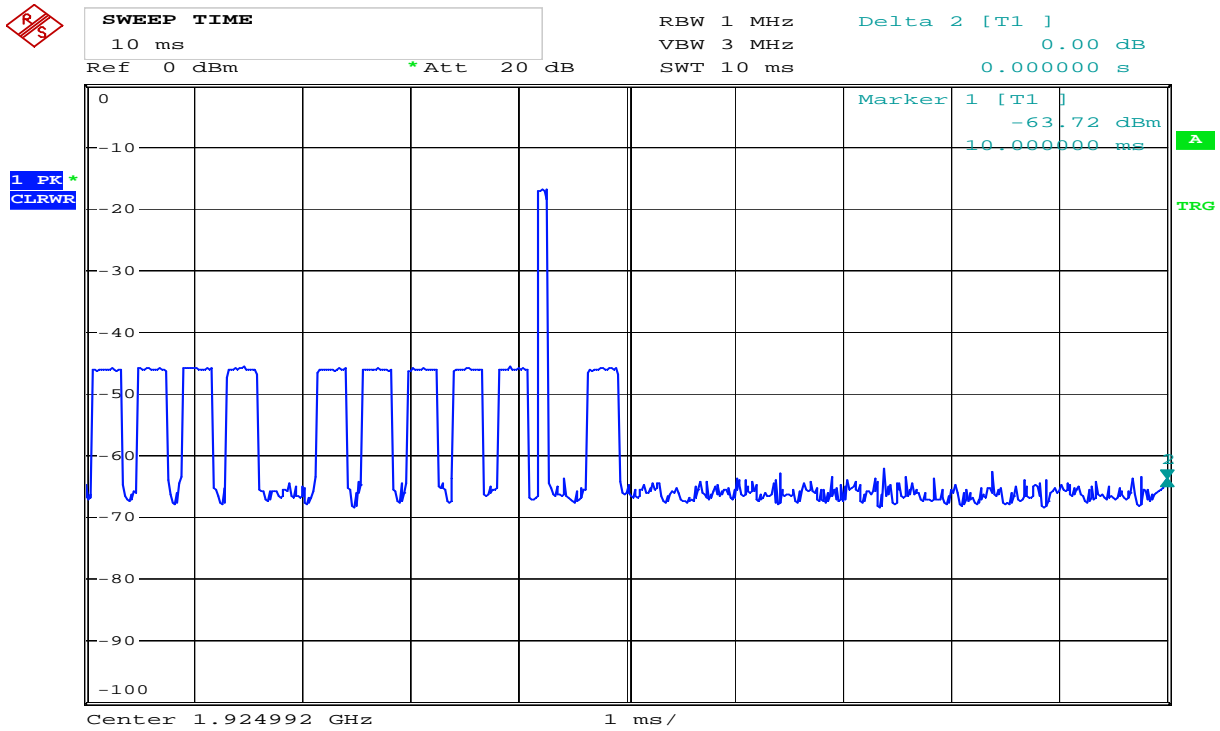

Date: 8.MAY.2009 15:16:27

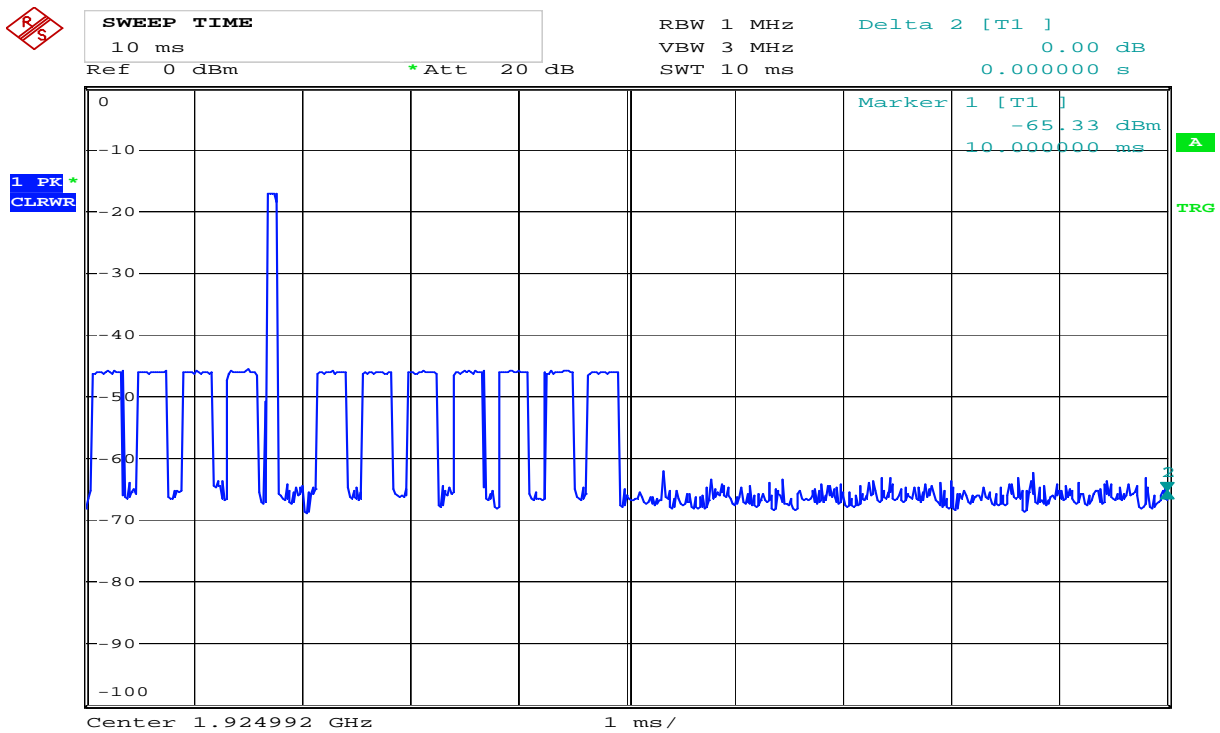

Date: 8.MAY.2009 15:17:12

### 8.1.2 Access Criteria funtional test, Before and After

## 4.20 Acknowledgements and Transmission Duration

### Measurement Procedure:

Acknowledgements: ANSI C63.17, clause 8.2.1

Transmission Duration: ANSI C63.17, clause 8.2.2

During the test **Initial transmission without acknowledgements** the signal from the EUT to the companion device is blocked by circulators in addition to the tunable attenuator.

The test **Transmission time after loss of acknowledgements** is performed by cutting-off the signal from the companion device by a RF switch and measuring the time until the EUT stops transmitting.

The **Transmission Duration** test is performed by monitoring the slot in use and measuring the time until the EUT changes to a different slot.

### Test Results:

#### Acknowledgements

Test ref. to ANSI C63.17 clause 8.2.1	Observation	Verdict
a) Initial transmission without acknowledgements	Only for initiating device	N/A
c) Transmission time after loss of acknowledgements	5 sec	Pass

#### Transmission Duration

Test ref. to ANSI C63.17 clause 8.2.2	Observation	Verdict
b) Transmission duration on same time and frequency window	Only for initiating device that controls which time slot is used	N/A

Comment: /

### Limits, FCC 15.323(c)(3) and (4)

Occupation of the same combined time and spectrum windows by a device or group of cooperating devices continuously over a period of time longer than 8 hours is not permitted without repeating the access criteria.

Once access to specific combined time and spectrum windows is obtained an acknowledgement from a system participant must be received by the initiating transmitter within one second or transmission must cease.

Periodic acknowledgements must be received at least every 30 seconds or transmission must cease. Channels used exclusively for control and signaling information may transmit continuously for 30 seconds without receiving an acknowledgement, at which time the access criteria must be repeated.

## 4.21 Dual Access Criteria Check

### Measurement Procedure:

EUTs that does not implement the Upper Threshold: ANSI C63.17, clause 8.3.1

EUTs that implement the Upper Threshold: ANSI C63.17, clause 8.3.2

This test is required for equipment that uses the access criteria in FCC 15.323(c)(10).

### Test Results:

#### EUTs that do NOT Implement the Upper Threshold:

Test ref. to ANSI C63.17 clause 8.3.1	Observation	Verdict
b) EUT is restricted to a single carrier $f_i$ for TDMA systems. The Test is Pass if EUT can transmit	N/A	N/A
c) d) No transmissions on interference-free <b>receive</b> time/spectrum window. All transmit slots blocked.	N/A	N/A
e) f) No transmission on interference-free <b>transmit</b> time/spectrum window. All receive slots blocked.	N/A	N/A

#### EUTs that Implements the Upper Threshold:

Test ref. to ANSI C63.17 clause 8.3.2	Observation	Verdict
b) EUT is restricted to a single carrier $f_i$ for TDMA systems. The Test is Pass if EUT can transmit	N/A	N/A
c) d) Transmission on interference-free <b>receive</b> time/spectrum window	N/A	N/A
e) f) Transmission on interference-free <b>transmit</b> time/spectrum window	N/A	N/A
g) Transmission not possible on any time/spectrum window	N/A	N/A

Comment: This test is only applicable for EUT that can be initiating device.

### Limits, FCC 15.323(c)(10)

An initiating device may attempt to establish a duplex connection by monitoring both its intended transmit and receive time and spectrum windows. If both the intended transmit and receive time and spectrum windows meet the access criteria, then the initiating device can initiate a transmission in the intended transmit time and spectrum window. If the power detected by the responding device can be decoded as a duplex connection signal from the initiating device, then the responding device may immediately begin transmitting on the receive time and spectrum window monitored by the initiating device.

#### 4.22 Alternative Monitoring Interval

Test procedure described in ANSI C63.17 clause 8.4.

This test is required if the EUT implements the provisions of FCC 15.323(c)(11).

**Test result:**

Not Tested. The tested EUT does not implement this provision. See manufacturers' declaration.

## 4.23 Receiver Spurious Emissions

### Measurement Procedure:

Industry Canada RSS-213 paragraph 6.8 and RSS-GEN paragraphs 4.8 and 6.

### Test results:

Frequency MHz	Carrier No.	Measured Value Conducted dBm	Conducted Limit dBm	Margin dB
30 - 1000	all	< -80	-57	>23
1.000 – 20.000	all	< -73	-53	>20

The Receiver Spurious Emissions are covered by paragraph 4.23 Spurious Emissions Radiated. No separate Spurious Emissions which could be related to the receiver were detected during the radiated test.

### Requirements, RSS-GEN Issue 2, clause 6

The measurement can be performed either radiated or conducted.

**When measured Conducted:** no spurious signals appearing at the antenna terminals shall exceed 2 nW per any 4 kHz spurious frequency in the band 30-1000 MHz, or 5 nW above 1 GHz.

**When measured Radiated:** See Table 1 in RSS-GEN Issue 2, clause 6.

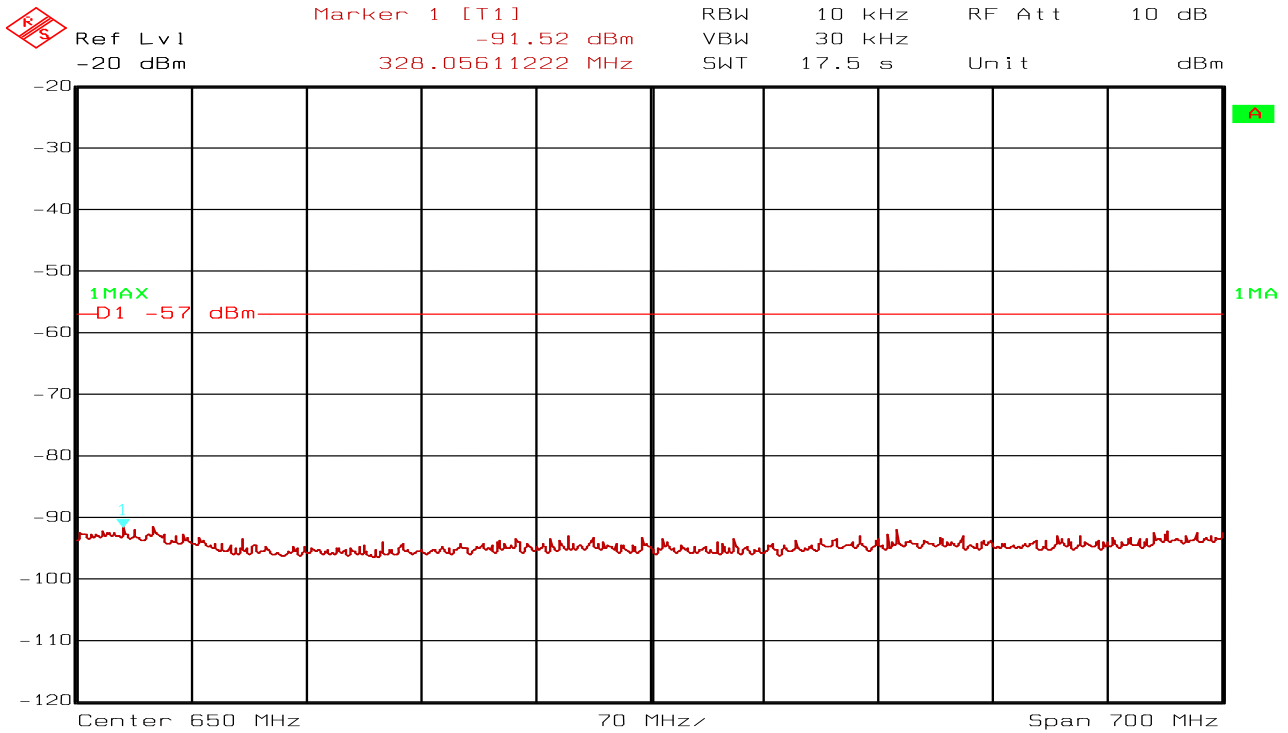

Date: 4.MAY.2009 10:04:10

**Receiver Emissions, Conducted, 30 – 1000 MHz**

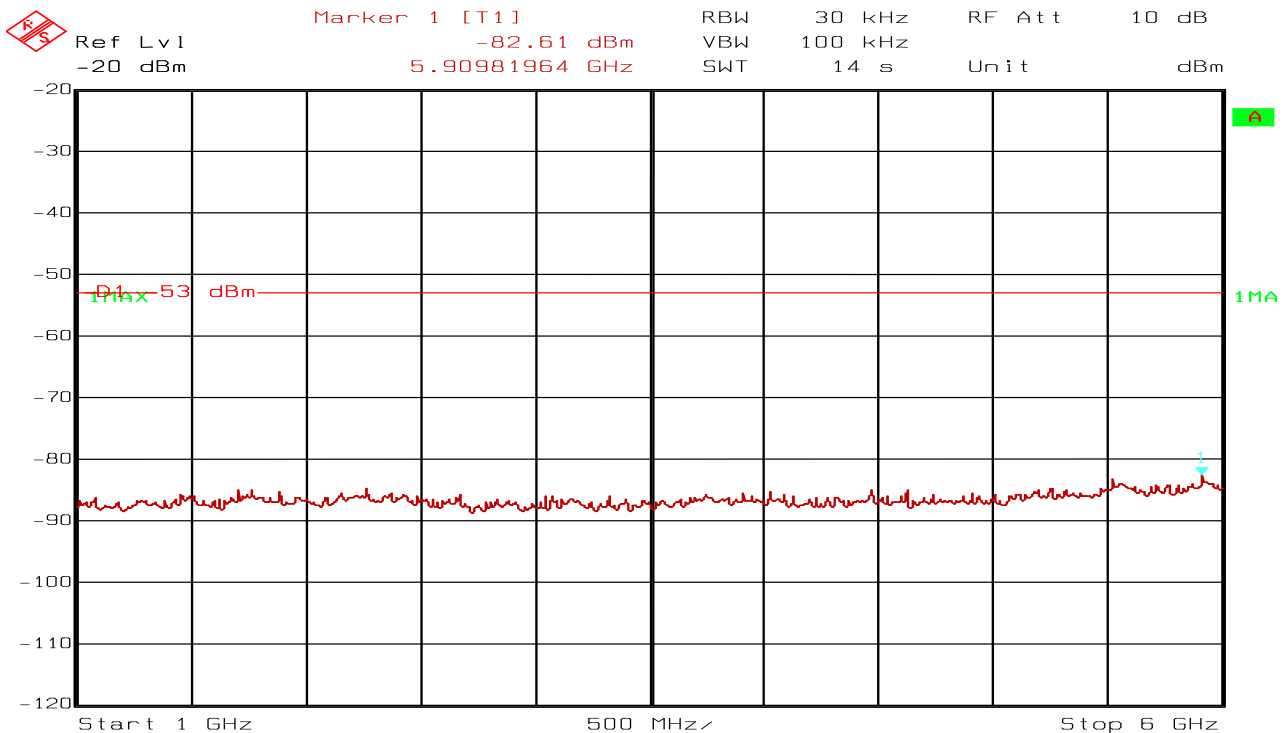

Date: 4.MAY.2009 10:08:45

**Receiver Emissions, Conducted, 1 - 6 GHz**



## 5 Test Setups

### 5.1 Frequency Measurements



Test equipment included: 5

#### Test Set-up 1

This setup is used for measuring Carrier frequency stability at normal and extreme temperatures.

### 5.2 Timing Measurements

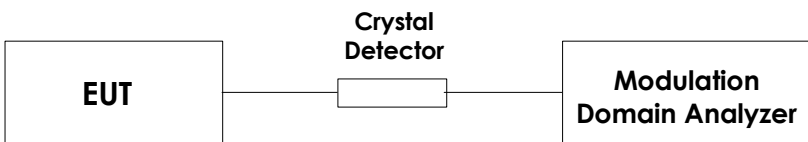

Test equipment included: 5, 7

#### Test Set-up 2

This setup is used for measuring Frame repetition stability, Frame period and Jitter.

### 5.3 Conducted Emission Test

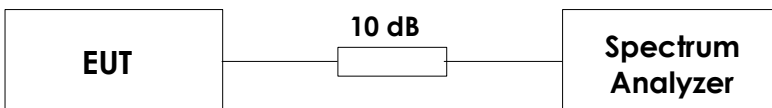

Test equipment included: 1, 13, 29

#### Test Set-up 3

This setup is used for all conducted emission tests.

### 5.4 Antenna Gain Test

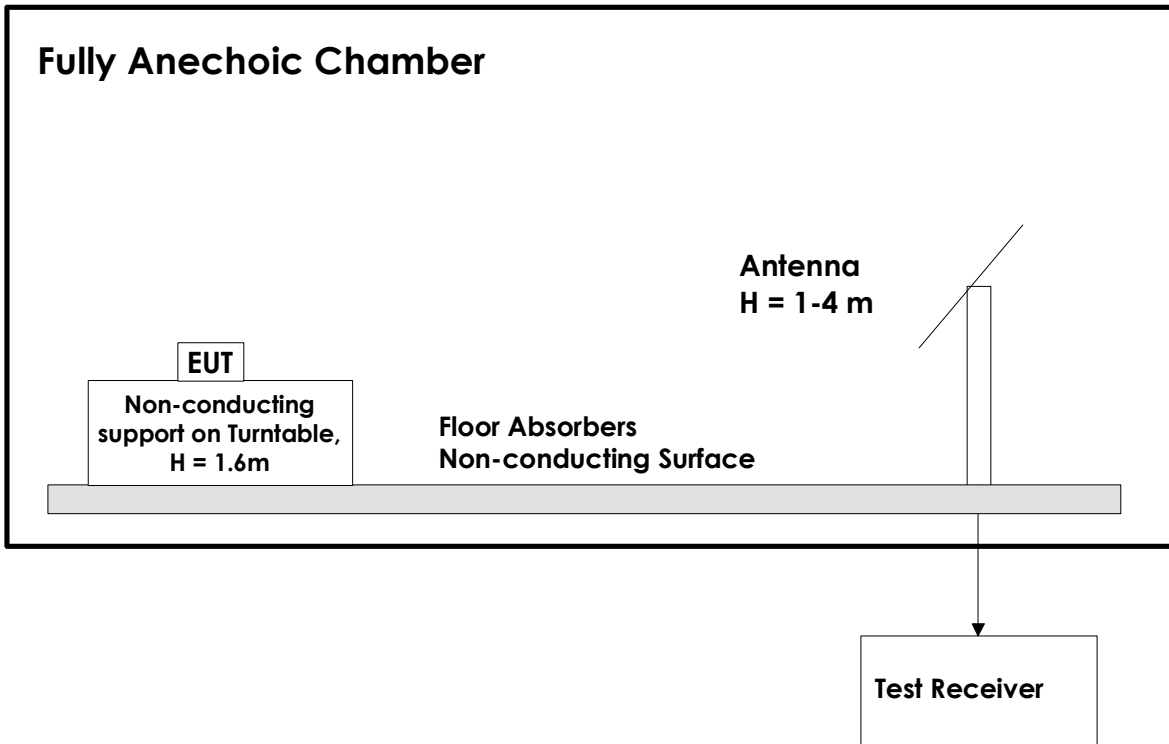

Test equipment: 1, 8, 9, 10, 11, 20, 21, 22, 23, 24, 25, 26, 31

#### Test Set-Up 4

This test setup is used for the radiated output power test. The measuring distance is 3 m. The measurement is performed with a Spectrum Analyzer and Horn Antenna and with a pre-amplifier after the antenna.

### 5.5 Power Line Conducted Emissions Test

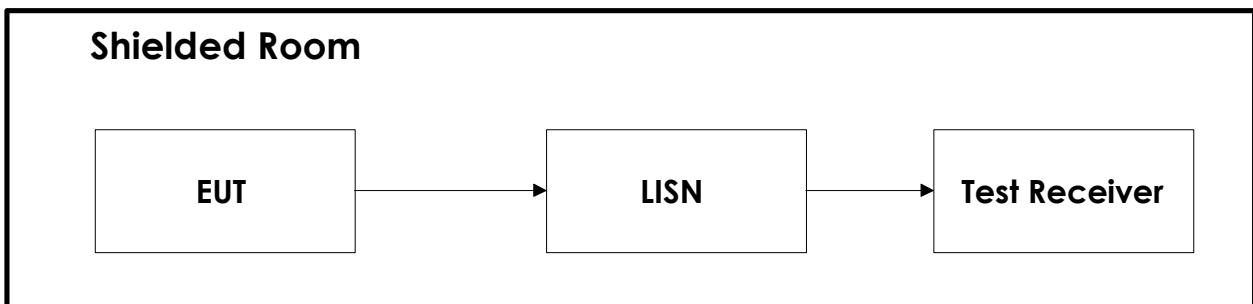

Test equipment: 12, 27, 28

#### Test Set-Up 5

## 5.6 Monitoring Tests

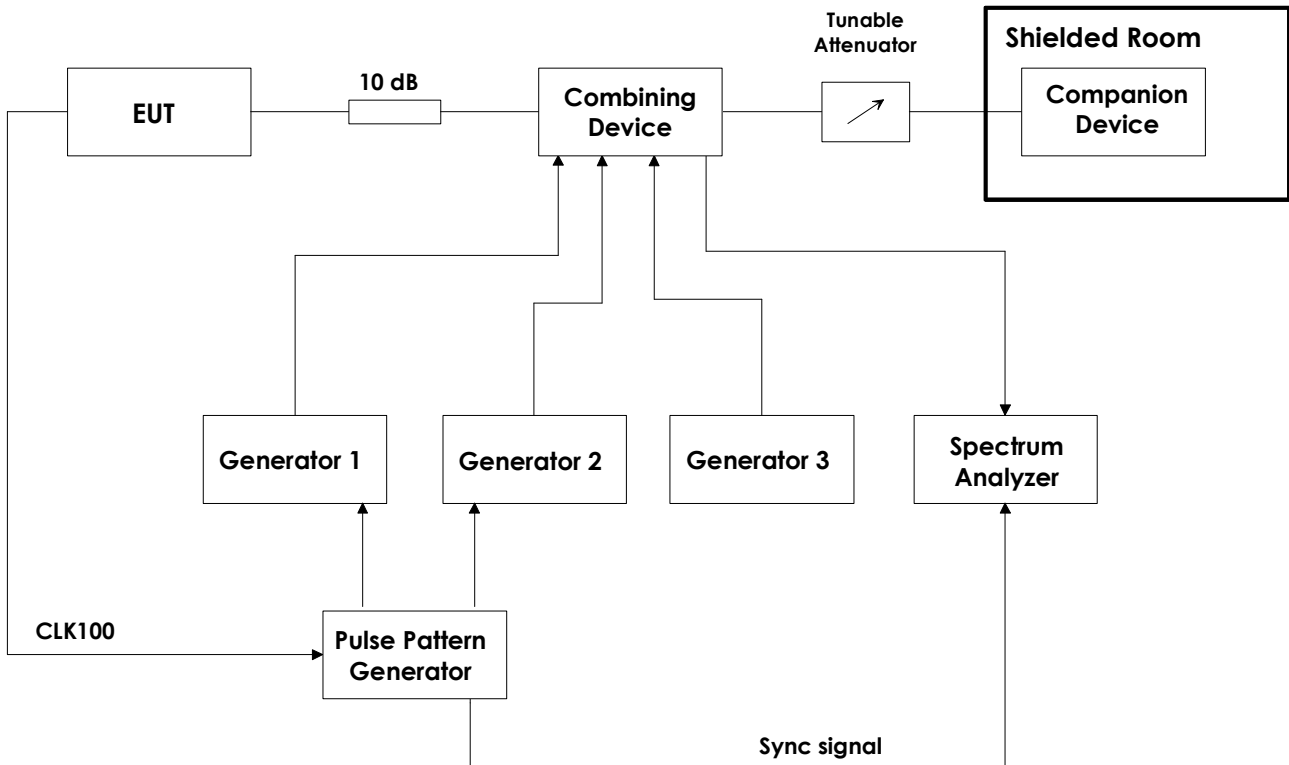

Test equipment: 1, 2, 4, 6, 13, 14, 15, 16, 17, 18, 19, 29

### Test Set-Up 6

This test setup is used for all Monitoring and Time and Spectrum Access Procedure tests. The path loss from the signal generators to the EUT is measured with a power meter before the testing is started.

The CLK100 is used to synchronize the Pulse-/ Pattern generator to the start of the DECT frame, this signal always comes from the base station. If the EUT is a DECT Portable Part (i.e. a handset) the CLK100 signal will come from the Companion Device.

The sync signal to the Spectrum Analyzer is the CLK100 signal that is regenerated in the Pulse-/ Pattern Generator, this is used to synchronize the Spectrum Analyzer to the DECT frame when in zero span. The Pulse-/ Pattern Generator is used for tests that require time synchronized pulses or blocking of specific time slots.

## 6 Test Equipment Used

To facilitate inclusion on each page of the test equipment used for related tests, each item of test equipment and ancillaries are identified (numbered) by the Testhouse.

No.	Instrument/ancillary	Type of instrument/ancillary	Manufacturer	Ref. no.
1	FSEK30	Spectrum Analyzer	Rohde & Schwarz	LR 1337
2	SME03	Signal generator	Rohde & Schwarz	LR 1238
3	SMIQ03	Signal generator	Rohde & Schwarz	LR 1516
4	SMP22	Signal generator	Rohde & Schwarz	LR 1287
5	53310A	Modulation Domain Analyzer	Hewlett Packard	LR 1483
6	81104A	Pulse-/ Pattern Generator	Agilent	LR 1502
7	8470B	Crystal Detector	Hewlett Packard	LR 1207
8	8449B	Preamplifier	Hewlett Packard	LR 1322
9	4HC3000/18000	High-pass filter	Trilithic	S.No.: 9849045
10	ESVS30	Measuring Receiver	Rohde & Schwarz	LR 1101
11	ESN	Measuring Receiver	Rohde & Schwarz	LR 1237
12	ESAI	Measuring Receiver	Rohde & Schwarz	LR 1090
13	6810.17B	Attenuator	Narda	LR1212
14	745-69	Step Attenuator	Narda	LR 1442
15	WE 1506A	Power Splitter	Weinchel	LR 244
16	WE 1506A	Power Splitter	Weinchel	LR 245
17	H-9	Hybrid	Anzac	LR 86
18	H-9	Hybrid	Anzac	LR 257
19	S212DS	RF Switch	Narda	LR 1244
20	3115	Horn Antenna	EMCO	LR 1226
21	PM7320-X	Horn Antenna	Sivers Lab	LR 102
22	DBF-520-20	Horn Antenna	Systron Donner	LR 100
23	638	Horn Antenna	Narda	LR 1480
24	HL223	Log-period Antenna	Rohde & Schwarz	LR 1261
25	HK116	Biconical Antenna	Rohde & Schwarz	LR 1260
26	HFH2-Z2	Loop Antenna	Rohde & Schwarz	LR 285
27	ESH3-Z5	Two Line V-Network	Rohde & Schwarz	LR 1076
28	80S	Signal Generator	Powertron	LT 502
29	FSP30	Spectrum Analyzer	Rohde & Schwarz	LR 1551
30	CMD60	DECT Tester	Rohde & Schwarz	LR 1335
31	6812B	AC Power Source	Agilent	LR 1515