



Test Report

Product	DECT Access Keypad	
Name and address of the applicant	Panasonic Corporation of North America	
Name and address of the manufacturer	Panasonic System Networks Co., Ltd. 1-62, 4-chome, Minoshima, Hakata-ku Fukuoka 812-8531, Japan	
Model	KX-HNK101	
Rating	5.5V DC (AC Adaptor Output, Input: 120V AC)	
	Panasonic	
Serial number	/	
Additional information	DECT 6.0	
Tested according to	FCC Part 15, subpart D Isochronous UPCS Device, 1920 – 1930 MHz Industry Canada RSS 213, Issue 2 2 GHz License-exempt Personal Communications Service Devices (LE-PCS)	
Order number	279025	
Tested in period	2015.02.26 to 2015.03.03	
Issue date	2015.03.03	
Name and address of the testing laboratory	 FCC No: 994405 IC OATS: 2040D-1 Instituttveien 6 Kjeller, Norway TEL: (+47) 22 96 03 30 FAX: (+47) 22 96 05 50	
		
	Prepared by [Frode Sveinsen]	Approved by [G. Suhanthakumar]
This report shall not be reproduced except in full without the written approval of Nemko. Opinions and interpretations expressed within this report are not part of the current accreditation. This report was originally distributed electronically with digital signatures. For more information contact Nemko.		

CONTENTS

1	INFORMATION	3
1.1	Tested Item.....	3
1.2	Description of Tested Device.....	3
1.3	Exposure Evaluation.....	3
1.4	Test Environment	4
1.5	Test Engineer(s).....	4
1.6	Test Equipment	4
1.7	Other Comments	4
2	TEST REPORT SUMMARY	5
2.1	General.....	5
2.2	Test Summary	6
3	TEST RESULTS.....	7
3.1	Power Line Conducted Emissions.....	7
3.2	Digital Modulation Techniques	10
3.3	Labeling Requirements	10
3.4	Channel Frequencies	10
3.5	Antenna Requirement.....	11
3.6	Automatic Discontinuation of Transmission	11
3.7	Peak Power Output	12
3.8	Emission Bandwidth <i>B</i>	15
3.9	Power Spectral Density	18
3.10	In-Band Unwanted Emissions, Conducted	21
3.11	Out-of-band Emissions, Conducted.....	23
3.12	Carrier Frequency Stability	29
3.13	Frame Repetition Stability	30
3.14	Frame Period and Jitter	30
3.15	Monitoring Threshold, Least Interfered Channel	32
3.16	Threshold Monitoring Bandwidth	34
3.17	Reaction Time and Monitoring Interval	35
3.18	Time and Spectrum Window Access Procedure	37
3.19	Acknowledgements and Transmission Duration	38
3.20	Dual Access Criteria Check.....	40
3.21	Alternative Monitoring Interval	43
4	MEASUREMENT UNCERTAINTY	44
5	TEST SETUPS	45
5.1	Frequency Measurements.....	45
5.2	Timing Measurements	45
5.3	Conducted Emission Test.....	45
5.4	Power Line Conducted Emissions Test.....	45
5.5	Monitoring Tests	46
6	TEST EQUIPMENT USED	47

1 INFORMATION

1.1 Tested Item

Name :	Panasonic
Model name :	KX-HNK101
FCC ID :	ACJ96NKX-HNK101
Industry Canada ID :	216A-KXH NK101
Serial number :	/
Hardware identity and/or version:	PNLB2495xx
Software identity and/or version :	SW100
Tested to IC Radio Standard (RSS) :	RSS-213 Issue 2, RSS-GEN Issue 4
Test Site IC Reg. Number :	IC 2040D-1
Frequency Range :	1921.536 – 1928.448 MHz
Number of Channels :	5 RF Channels, 5x12 = 60 TDMA Duplex Channels
Type of Modulation :	Digital (Gaussian Frequency Shift Keying)
Conducted Output Power :	62 mW (Peak)
Antenna Connector :	None (Internal Antenna)
Number of Antennas :	2
Antenna Diversity Supported :	Yes
Desktop Charger :	No
Power Supply :	AC Adaptor Model: PNLV226 (UC)
Interface :	None
Companion Device:	KX-HNB600 Base Station

1.2 Description of Tested Device

The EUT is a DECT Access Keypad and is an initiating device as described in ANSI C63.17 and is designed to operate together with a DECT Base Station, which is the responding device.

1.3 Exposure Evaluation

For the purposes of exposure evaluation this EUT is a fixed device and the user manual contains text that it shall be mounted with a separation distance of at least 20cm from any persons. MPE Calculation at 20cm satisfying FCC requirements is submitted as a separate document.

The EUT is exempted from RF Exposure Evaluation to Industry Canada requirements since the output power complies with the power levels of section 2.5.2 of RSS-102 Issue 4.

1.4 Test Environment

Temperature:	20.4 – 20.9 °C
Relative humidity:	40 – 43 %
Normal test voltage:	120 V AC (Mains)

The values are the limit registered during the test period. The EUT was powered from a regulated AC Power Source during all tests.

1.5 Test Engineer(s)

Frode Sveinsen

1.6 Test Equipment

See list of test equipment in clause 6.

1.7 Other Comments

The Monitoring and Time and Spectrum Window Access tests were performed with Test Set-Up 6 (Ref. clause 5). A clock signal from the companion device was used to synchronize the Pulse Pattern Generator and the Spectrum Analyzer to the start of the DECT time window. The EUT was limited by administrative commands to operate on only two frequency carriers. For the tests where the EUT was required to operate on only one frequency carrier, one carrier was blocked by applying a CW interfering signal from RF Generator 3. The Pulse Pattern Generator was used to apply time synchronized interference to time windows where this was required.

Since the EUT was programmed to operate on only two RF carriers, it was only necessary with two RF generators for the monitoring tests, however a third generator was applied for the tests that required specific time slots to be blocked.

This EUT supports Least Interfered Channel procedure (LIC), the Monitoring and Time and Spectrum Window Access tests were conducted as specified for EUTs that support LIC procedure.

All tests were performed in conducted mode with a temporary antenna connector.

2 TEST REPORT SUMMARY

2.1 General

All measurements are traceable to national standards.

The tests were conducted on a sample of the equipment for the purpose of demonstrating compliance with FCC CFR47 Part 15D for Isochronous UPCS Devices and Industry Canada RSS-213 Issue 2 / RSS-GEN Issue 4 / RSP-100 Issue 10.

All tests were conducted in accordance with ANSI C63.4-2009/2013 and ANSI C63.17-2013.

A description of the test facility is on file with the FCC and Industry Canada.

New Submission

Production Unit

Class II Permissive Change

Pre-production Unit

PUB Equipment Code

Family Listing



THIS TEST REPORT APPLIES ONLY TO THE ITEM(S) AND CONFIGURATIONS TESTED.

Deviations from, additions to, or exclusions from the test specifications are described in "Summary of Test Data".

Nemko Group authorizes the above named company to reproduce this report provided it is reproduced in its entirety and for use by the company's employees only. Any reproduction of parts of this report requires approval in writing from Nemko Group.

Any use which a third party makes of this report, or any reliance on or decisions to be made based on it, are the responsibility of such third parties. Nemko Group accepts no responsibility for damages suffered by any third party as a result of decisions made or actions based on this report.

2.2 Test Summary

Name of test	FCC CFR 47 Paragraph #	IC RSS-213 Paragraph #	Verdict
Power Line Conducted Emission	15.107(a) 15.207(a)	6.3 RSS-GEN 8.8	Complies
Digital Modulation Techniques	15.319(b)	6.1	Complies
Labeling requirements	15.19(a)(3)	3 RSP-100 3.1	Complies
Antenna Requirement	15.317, 15.203	RSS-GEN 8.3	Complies
Channel Frequencies	15.303	1	Complies
Automatic discontinuation of transmission	15.319(f)	4.3.4(a)	Complies
Emission Bandwidth	15.323(a)	6.4 RSS-GEN 6.6	Complies
In-band emissions	15.323(d)	6.7.2	Complies
Out-of-band emissions	15.323(d)	6.7.1	Complies
Output Power and Antenna Gain	15.319(c)(e), 15.31(e)	6.5 and 4.1(e) RSS-GEN 8.3	Complies
Power Spectral Density	15.319(d)	4.3.2.1	Complies
Carrier frequency stability	15.323(f)	6.2	Complies
Frame repetition stability	15.323(e)	4.3.4(c)	Complies
Frame period and jitter	15.323(e)	4.3.4(c)	Complies
Monitoring threshold, Least interfered channel	15.323(c)(2);(5); (9)	4.3.4(b)	Complies
Monitoring of intended transmit window and maximum reaction time	15.323(c)(1)	4.3.4(b)	Complies
Threshold monitoring bandwidth	15.323(c)(7)	4.3.4(b)	Complies
Reaction time and monitoring interval	15.323(c)(1);(5); (7)	4.3.4(b)	Complies
Access criteria test interval	15.323(c)(4);(6)	4.3.4(b)	N/A ¹
Access Criteria functional test	15.323(c)(4);(6)	4.3.4(b)	N/A ¹
Acknowledgements	15.323(c)(4)	4.3.4(b)	Complies
Transmission duration	15.323(c)(3)	4.3.4(b)	Complies
Dual access criteria	15.323(c)(10)	4.3.4(b)	Complies
Alternative monitoring interval	15.323(c)(10);(11)	4.3.4(b)	N/A ²
Spurious Emissions (Radiated)	15.319(g) 15.109(a) 15.209(a)	4.3.3 RSS-GEN 8.9	N/A ³

¹ Only applies for equipment that transmits unacknowledged control and signaling information

² The client declares that the tested equipment does not implement this provision

³ Not required if the Conducted Out-of-Band Emissions test is Passed

3 TEST RESULTS

3.1 Power Line Conducted Emissions

FCC Part 15.207(a)

RSS-213 Clause 6.3, RSS-GEN Clause 8.8

Test Performed By: Thomas Danglé	Date of Test: 3-Mar-2015
----------------------------------	--------------------------

Measurement procedure: ANSI C63.4-2009 using 50 µH/50 ohms LISN.

Test Results: Complies

Measurement Data: See attached graph, (Peak detector).

Highest measured value (L1 and N):

EUT Idle Mode, 120V 60Hz:

Frequency [MHz]	Level [dBuV]	Af [dB]	Limit [dBuV]	Margin [dB]	Det	Position	Verdict [Pass/Fail]
0.375000	34.40	10.40	58.40	24.00	QP	N	Pass
0.325000	18.50	10.50	49.60	31.10	AV	N	Pass
0.375000	25.30	10.40	48.40	23.10	AV	N	Pass
0.555000	14.70	10.20	46.00	31.30	AV	N	Pass
0.725000	15.40	10.20	46.00	30.60	AV	N	Pass
0.740000	15.30	10.20	46.00	30.70	AV	N	Pass
1.050000	15.80	10.40	46.00	30.20	AV	N	Pass
1.595000	15.50	10.40	46.00	30.50	AV	N	Pass
1.970000	15.90	10.40	46.00	30.10	AV	N	Pass
2.360000	15.60	10.40	46.00	30.40	AV	N	Pass
2.830000	15.10	10.40	46.00	30.90	AV	N	Pass
3.770000	12.40	10.40	46.00	33.60	AV	N	Pass

EUT Transmitting, 120V 60Hz:

Frequency [MHz]	Level [dBuV]	Af [dB]	Limit [dBuV]	Margin [dB]	Det	Position	Verdict [Pass/Fail]
0.375000	35.60	10.40	58.40	22.80	QP	N	Pass
0.330000	17.90	10.50	49.50	31.60	AV	N	Pass
0.375000	26.10	10.40	48.40	22.30	AV	N	Pass
0.450000	15.80	10.30	46.90	31.10	AV	N	Pass
0.590000	16.00	10.20	46.00	30.00	AV	N	Pass
0.865000	15.10	10.30	46.00	30.90	AV	N	Pass
1.180000	13.90	10.40	46.00	32.10	AV	N	Pass
1.510000	14.00	10.40	46.00	32.00	AV	N	Pass
1.765000	15.60	10.40	46.00	30.40	AV	N	Pass
2.630000	16.00	10.40	46.00	30.00	AV	N	Pass
3.570000	15.50	10.40	46.00	30.50	AV	N	Pass
3.610000	15.30	10.40	46.00	30.70	AV	N	Pass
4.850000	12.60	10.50	46.00	33.40	AV	N	Pass

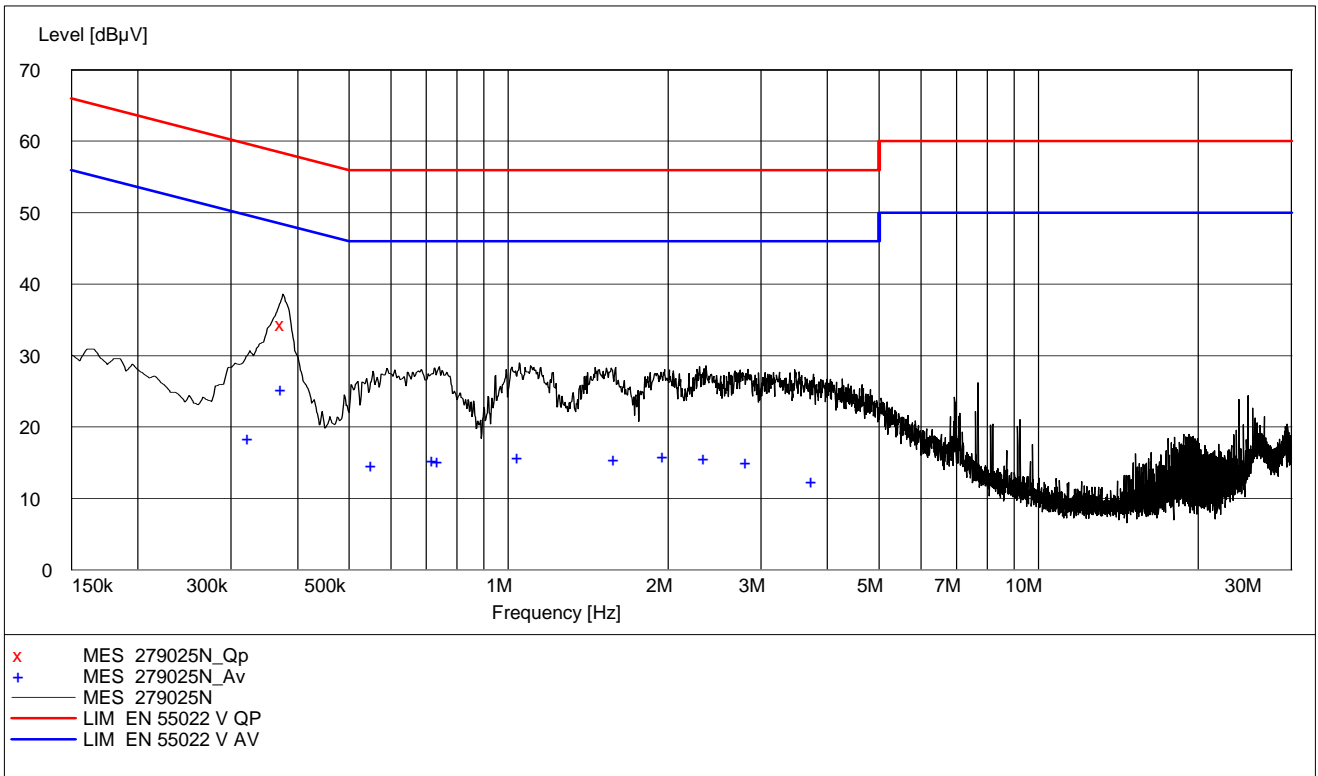

EUT Idle Mode, 120V 60Hz

FCC 15.207 with AC Adaptor PNLV226 (plot is maximum of Phase L1 and N)

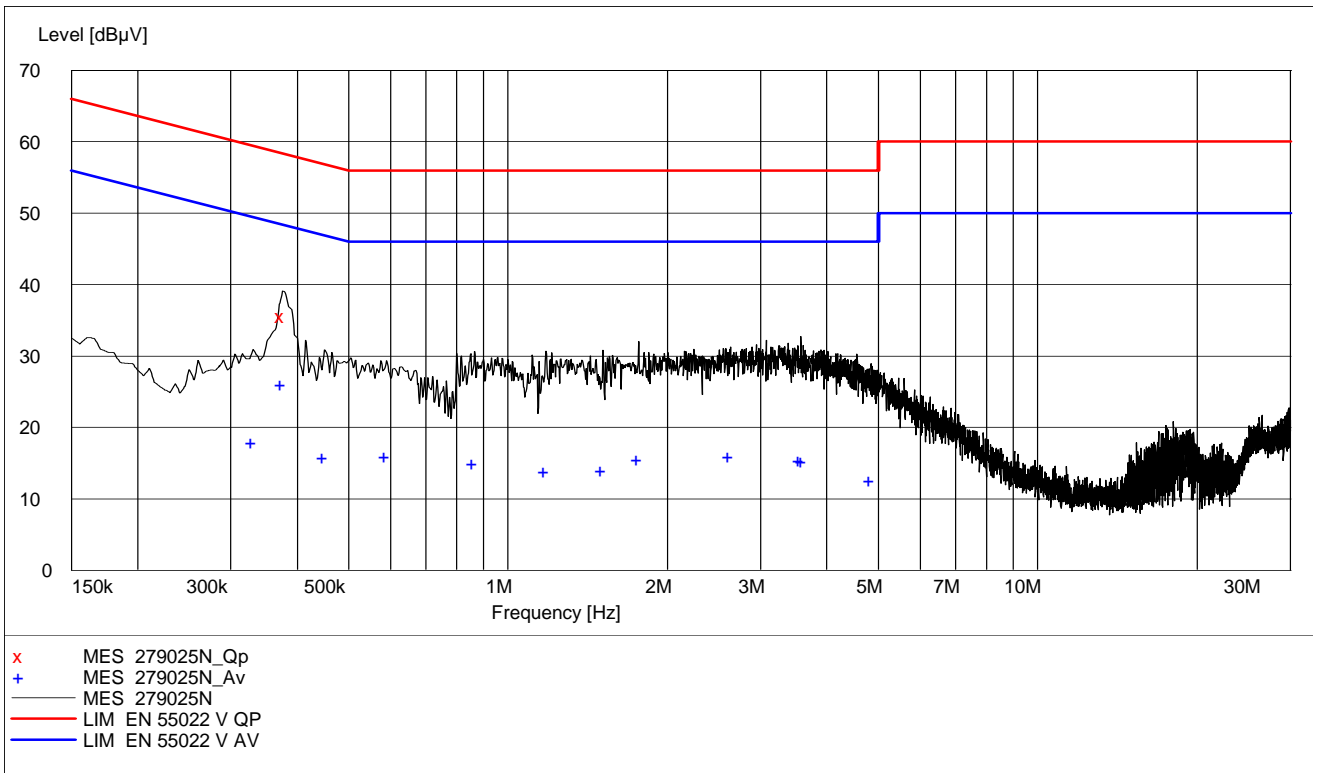

EUT Transmitting, 120V 60Hz

FCC 15.207 with AC Adaptor PNLV226 (plot is maximum of Phase L1 and N)

3.2 Digital Modulation Techniques

The EUT uses Multi Carrier / Time Division Multiple Access / Time Division Duplex and Digital GFSK modulation. For further details see the operational description provided by the applicant.

Requirement, FCC 15.319(b):

All transmissions must use only digital modulation techniques.

3.3 Labeling Requirements

See separate documents showing the label design and the placement of the label on the EUT.

Requirements FCC 15.19

The FCC Identifier shall be displayed on the label, and the device(s) shall bear the following statement in a conspicuous location on the device or in the user manual if the device is too small:

This device complies with Part 15 of the FCC Rules. Operation is subject to the following two conditions: (1) this device may not cause harmful interference, and (2) this device must accept any interference received, including interference that may cause undesired operation.

The label itself shall be of a permanent type, not a paper label, and shall last the lifetime of the equipment.

3.4 Channel Frequencies

UPCS CHANNEL	FREQUENCY (MHz)
Upper Band Edge	1930.000
0 (Highest)	1928.448
1	1926.720
2	1924.992
3	1923.264
4 (Lowest)	1921.536
Lower Band Edge	1920.000

Requirement: FCC 15.303

Within 1920 -1930 MHz band for isochronous devices.

3.5 Antenna Requirement

Does the EUT have detachable antenna(s)?	<input type="checkbox"/> YES	<input checked="" type="checkbox"/> NO
If detachable, is the antenna connector(s) non-standard?	<input type="checkbox"/> YES	<input type="checkbox"/> NO
The tested equipment has only integral antennas. The conducted tests were performed on a sample with a temporary antenna connector.		

Requirement: FCC 15.203, 15.204, 15.317.

3.6 Automatic Discontinuation of Transmission

Does the EUT transmit Control and Signaling Information?	<input type="checkbox"/> YES	<input checked="" type="checkbox"/> NO
TYPE OF EUT :	<input checked="" type="checkbox"/> INITIATING DEVICE	<input type="checkbox"/> RESPONDING DEVICE

The following tests simulate the reaction of the EUT in case of either absence of information to transmit or operational failure after a connection with the companion device is established.

Number	Test	EUT Reaction	Verdict
1	Power removed from EUT	C	Pass
2	Switch Off EUT	N/A	Pass
3	Hook-On by EUT	C	Pass
4	Power Removed from Companion Device	A	Pass
5	Switch Off Companion Device	N/A	Pass
6	Hook-On by Companion Device	N/A	Pass

- A - Connection breakdown, Cease of all transmissions
- B - Connection breakdown, EUT transmits control and signaling information
- C - Connection breakdown, Companion Device transmits control and signaling information
- N/A - Not Applicable (EUT does not have On/Off switch, Companion Device does not have On/Off switch and cannot perform Hook-On)

Requirements, FCC 15.319(f)

The device shall automatically discontinue transmission in case of either absence of information to transmit or operational failure. These provisions are not intended to preclude transmission of control and signaling information or use of repetitive codes used by certain digital technologies to complete frame or burst intervals.

3.7 Peak Power Output

Test Method:

ANSI C63.17, clause 6.1.2.

Test Results: Complies

Measurement Data:

Maximum Conducted Output Power

Channel No.	Frequency (MHz)	Maximum Conducted Output Power (dBm)	Maximum Antenna Gain (dBi)	Maximum Radiated Output Power (dBm)
4	1921.536	17.9	0.0*	17.9
2	1924.992	17.9	0.0*	17.9
0	1928.448	17.9	0.0*	17.9

*Antenna Gain is value declared by manufacturer

For this test it was also checked that input voltage variation of 85 and 115% of nominal value did not have any effect on the measured output power.

Limit:

Conducted: $100 \mu\text{W} \times \text{SQRT}(B)$ where B is the measured Emission Bandwidth in Hz

FCC 15.319(c)(e): 20.68 dBm (117 mW)

RSS-213, Issue 2: 20.44 dBm (111 mW)

The antenna gain is below 3 dBi, no reduction in transmit power is necessary.

Requirements, FCC 15.319(c)(e); RSS-213, Issue 2; RSS-GEN, Issue 4

Peak transmit power shall not exceed 100 microwatts multiplied by the square root of the emission bandwidth in Hertz.

The peak transmit power shall be reduced by the amount in decibels that the maximum directional gain of the antenna exceeds 3 dBi.

Conducted Peak Output Power

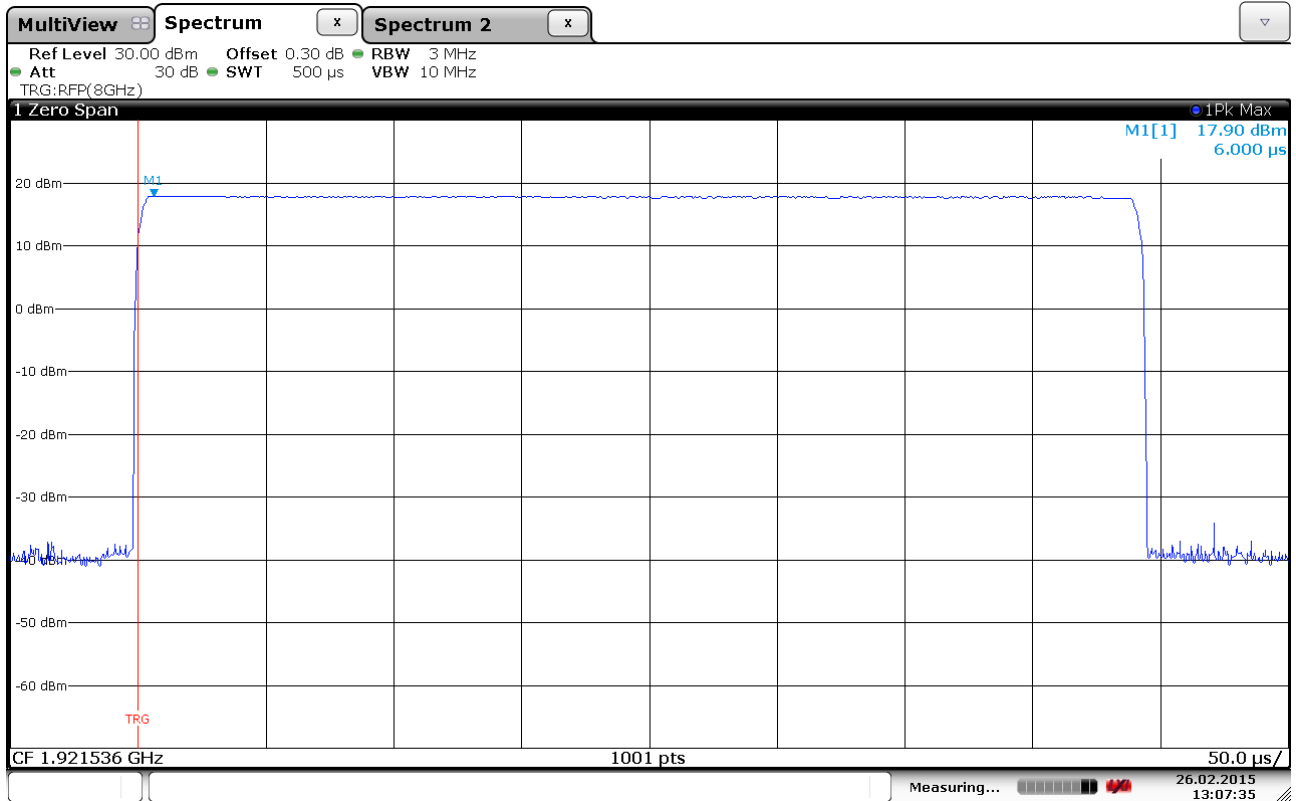

Lower Channel

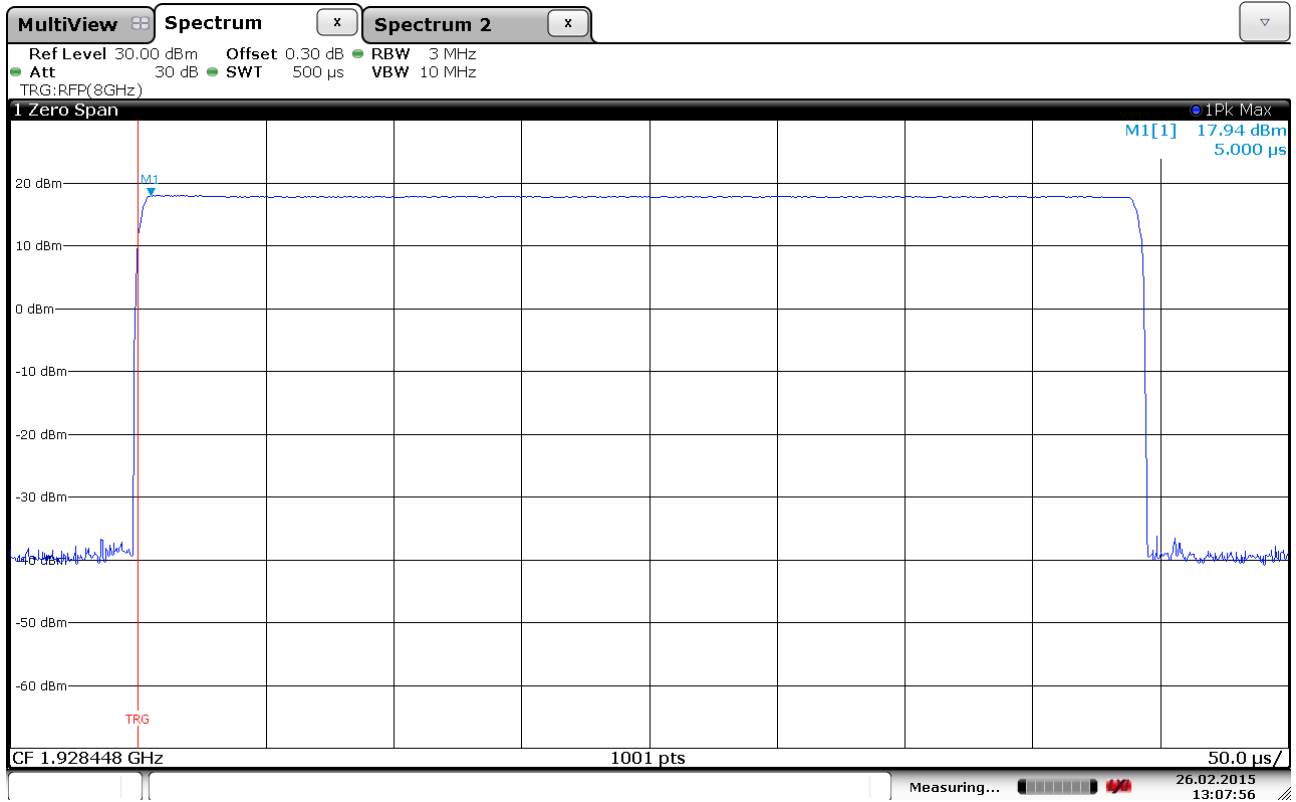

Upper Channel

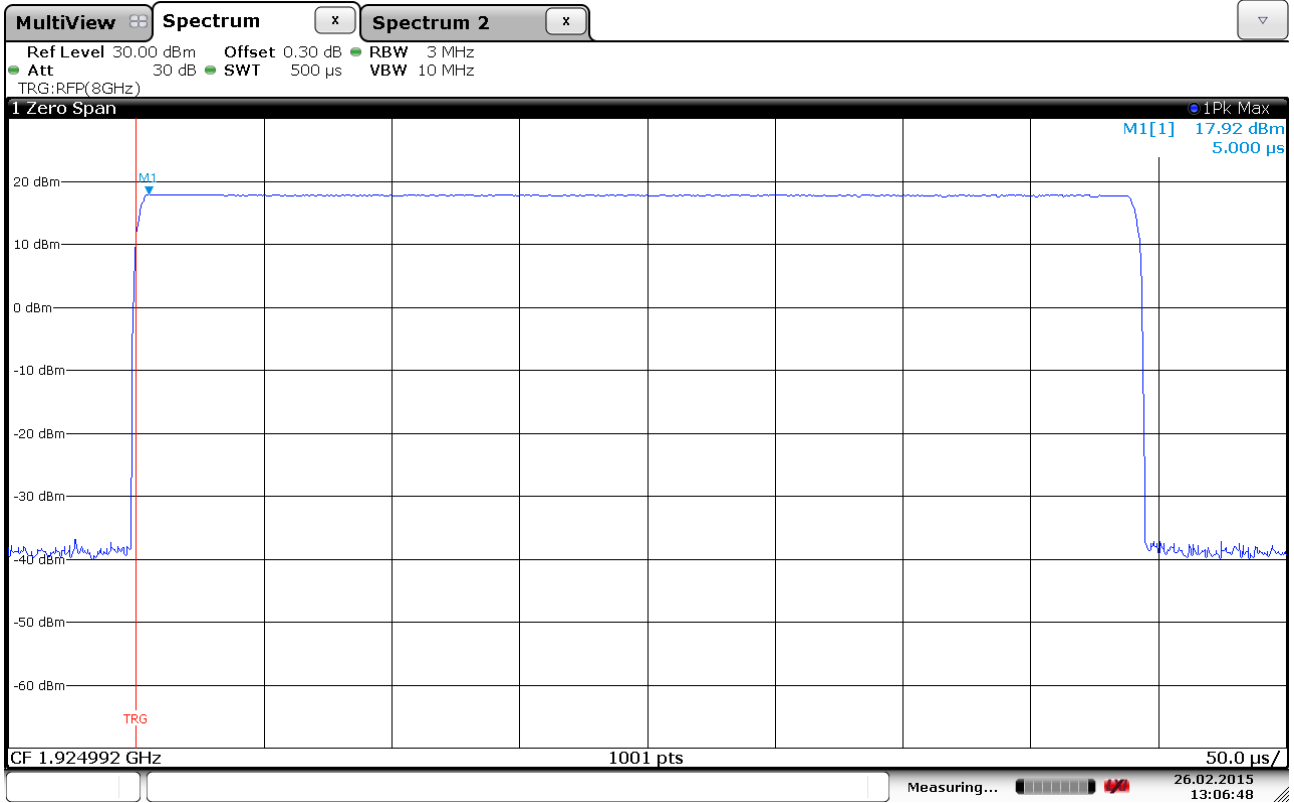

Middle Channel

3.8 Emission Bandwidth *B*

Test Method:

ANSI C63.17, clause 6.1.3.

Test Results: Complies

Measurement Data:

Channel No.	Frequency (MHz)	26 dB Bandwidth <i>B</i> (kHz)
4	1921.536	1370
0	1928.448	1410

Channel No.	Frequency (MHz)	99% Bandwidth (kHz)
2	1924.992	1226

Channel No.	Frequency (MHz)	6 dB Bandwidth (kHz)
4	1921.536	N/A
0	1928.448	N/A

Channel No.	Frequency (MHz)	12 dB Bandwidth (kHz)
4	1921.536	N/A
0	1928.448	N/A

Requirements, FCC 15.323(a)

The 26 dB Bandwidth *B* shall be larger than 50 kHz and less than 2.5 MHz.

Requirements, RSS-213 Issue 2, clause 6.4

The 99% Bandwidth shall be larger than 50 kHz and less than 2.5 MHz.

No requirements for 6 and 12 dB Bandwidth, these values are only used for testing Monitoring Bandwidth if the Simple Compliance test fails (ANSI C63.17, clause 7.4).

99% BW is measured according to RSS-GEN Issue 4, clause 6.6.

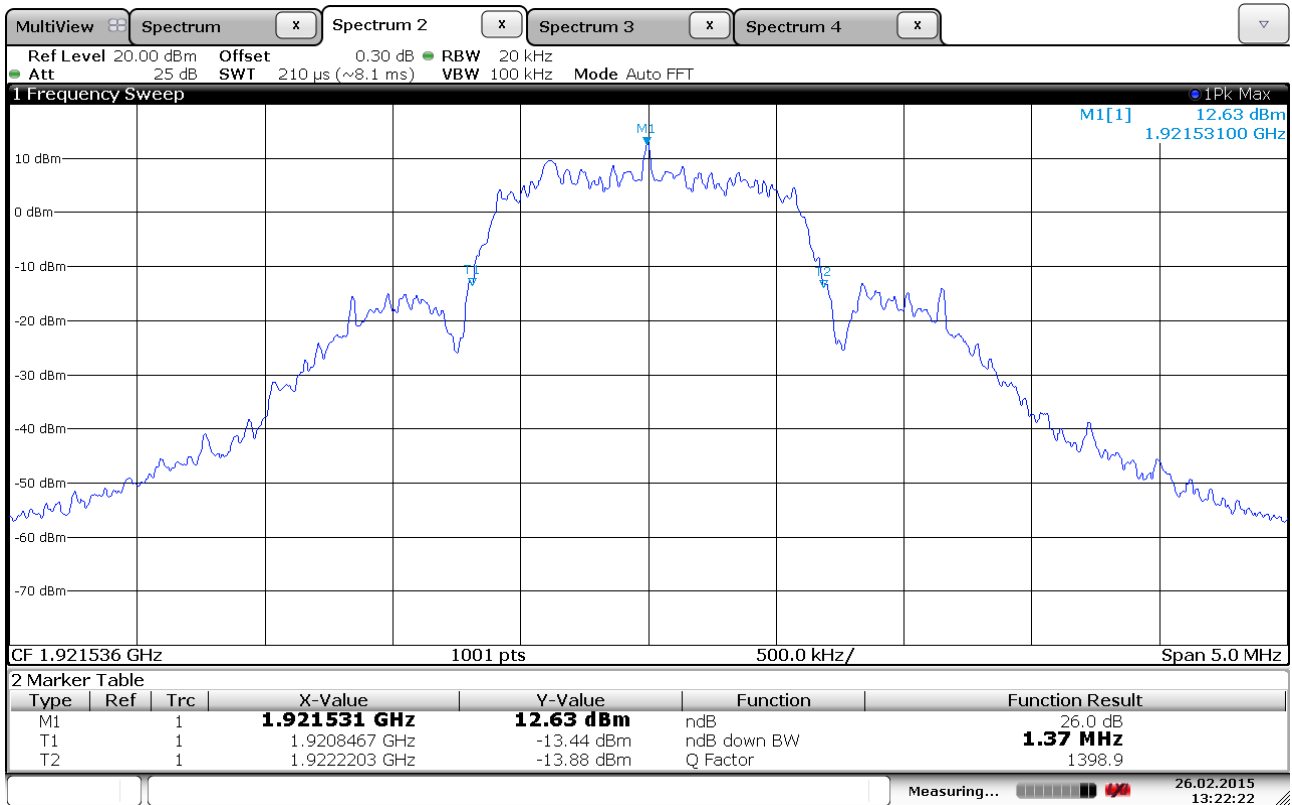

Emission Bandwidth B, Lower Channel

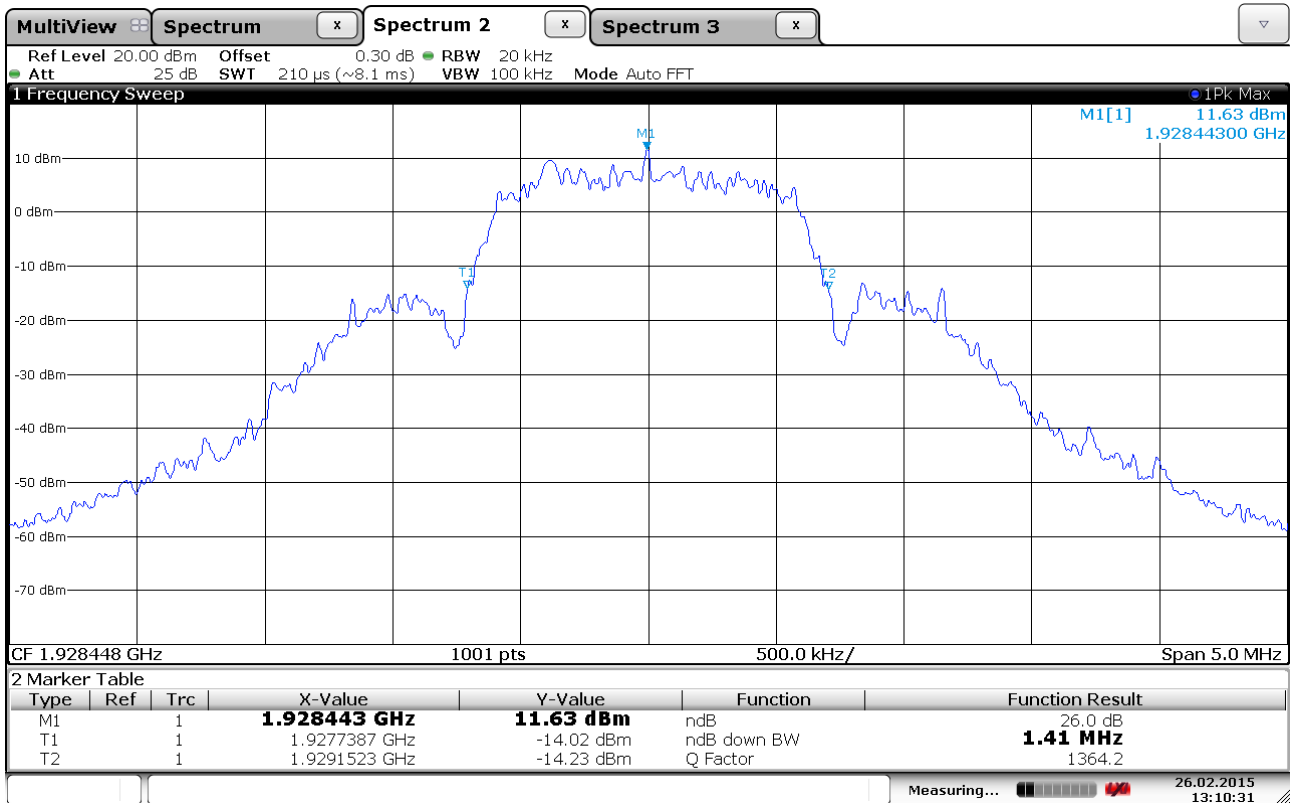

Emission Bandwidth B, Upper Channel

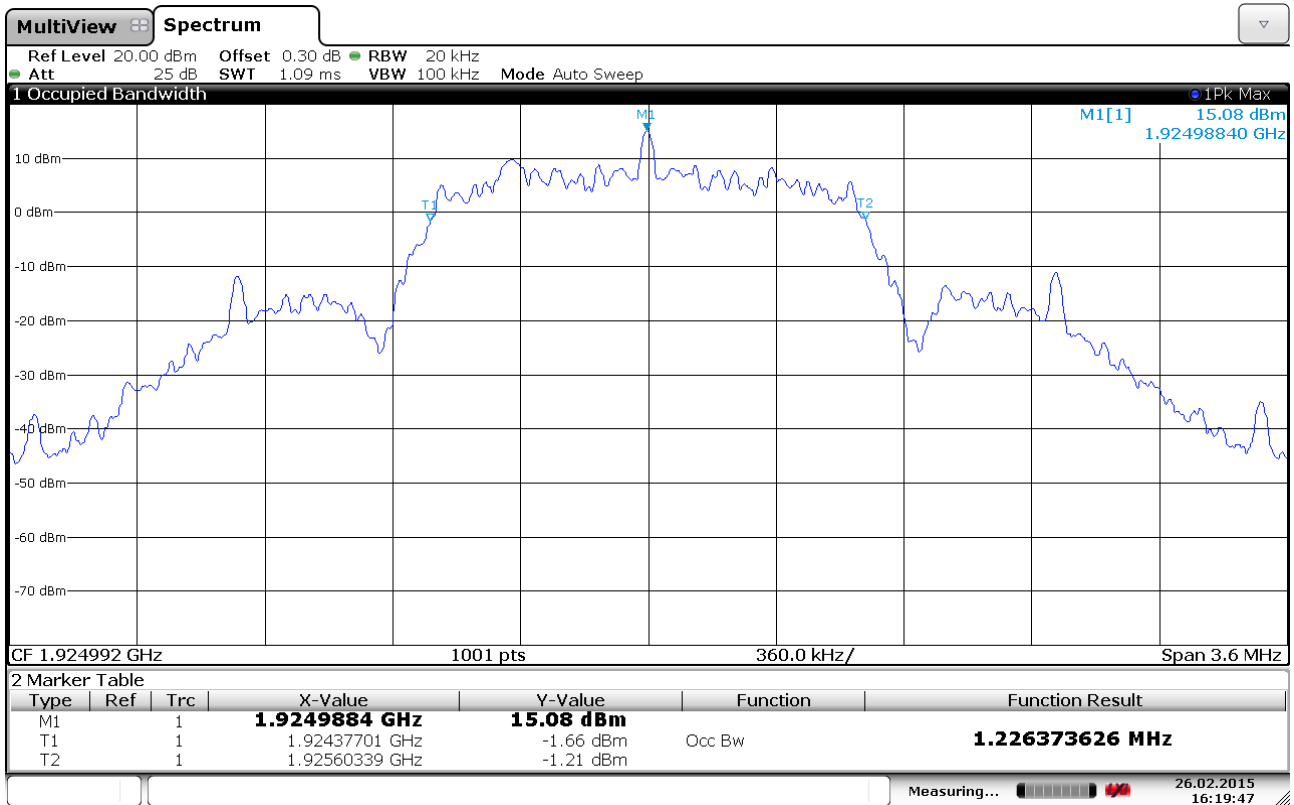

99% Bandwidth, Middle Channel

3.9 Power Spectral Density

Test Method:

ANSI C63.17, clause 6.1.5.

Test Results: Complies

Measurement Data:

Channel No.	Frequency (MHz)	Power Spectral Density (dBm)
4	1921.536	
0	1928.448	

Averaged over 1000 sweeps.

Requirements, FCC 15.319(d)

The Power Spectral Density shall be less than 3 mW (4.77 dBm) when averaged over at least 100 sweeps.

Power Spectral Density

Lower Channel:

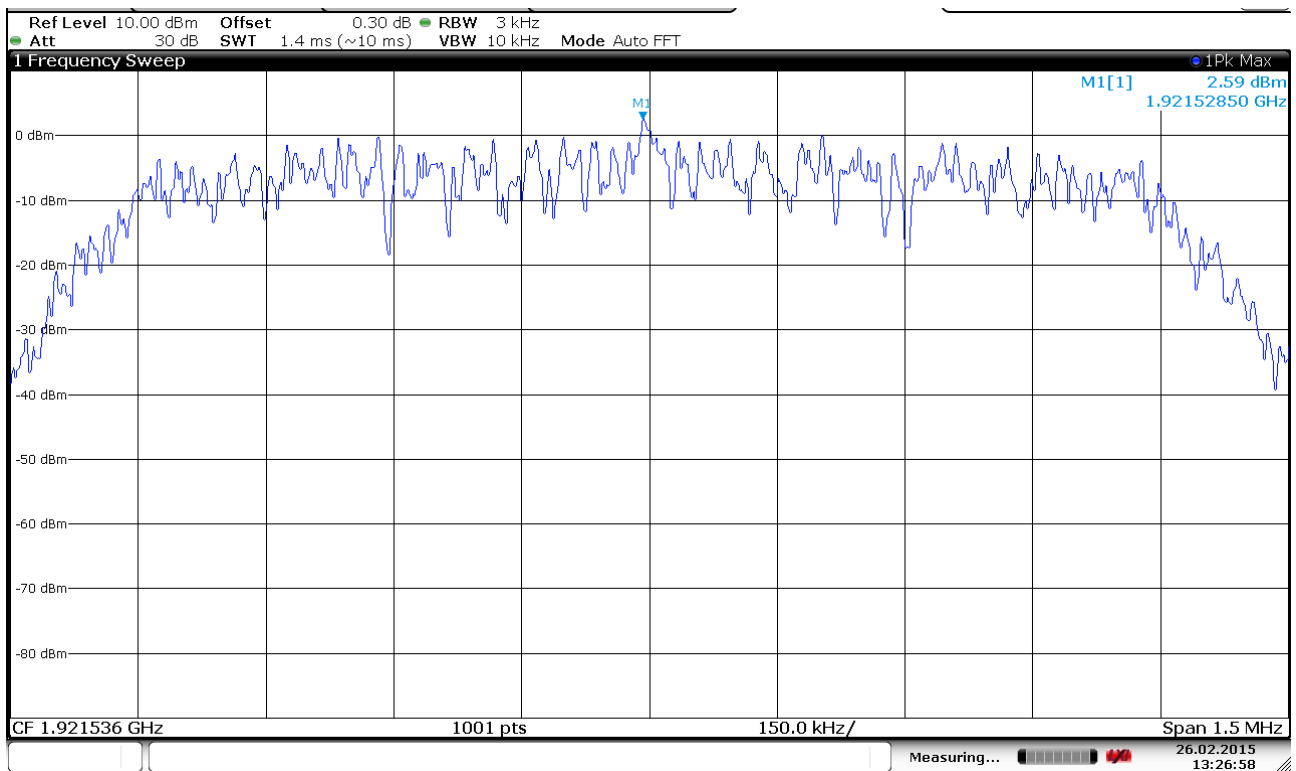

Overview

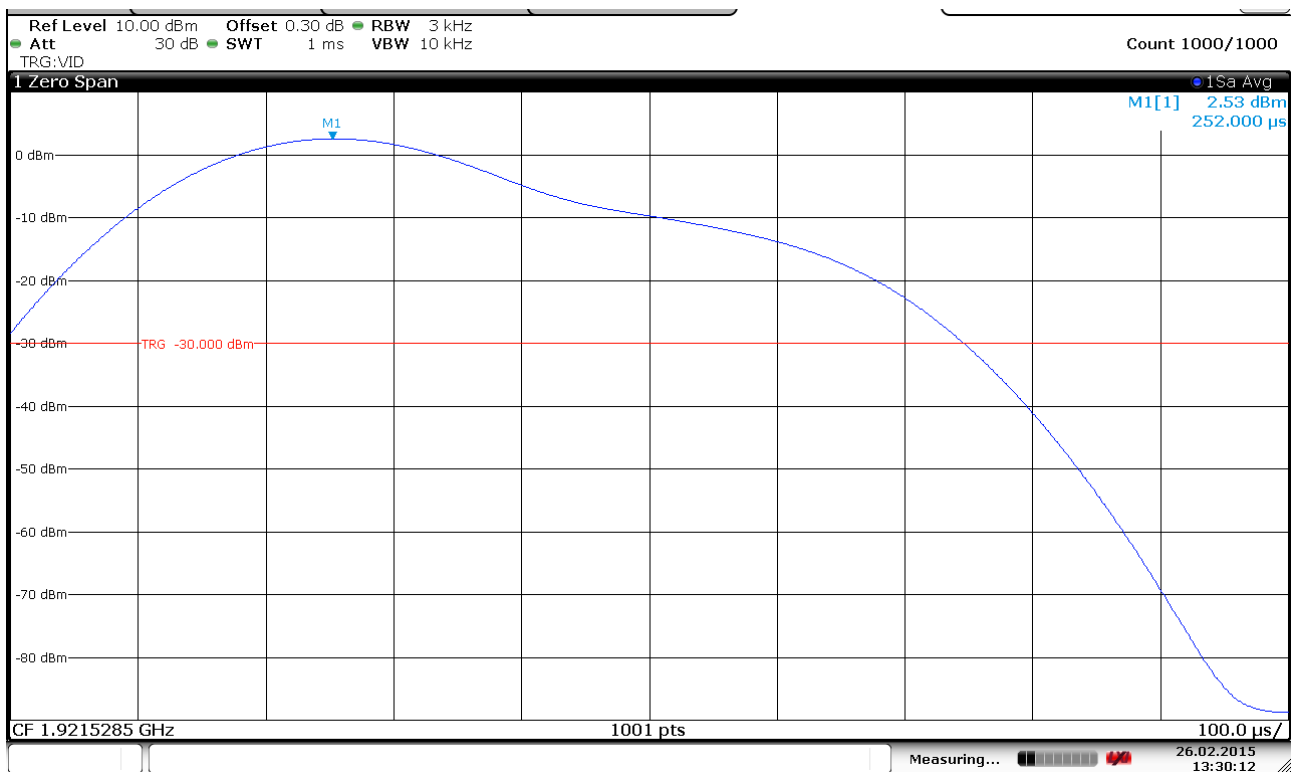

Averaged, 1000 Sweeps

Upper Channel:

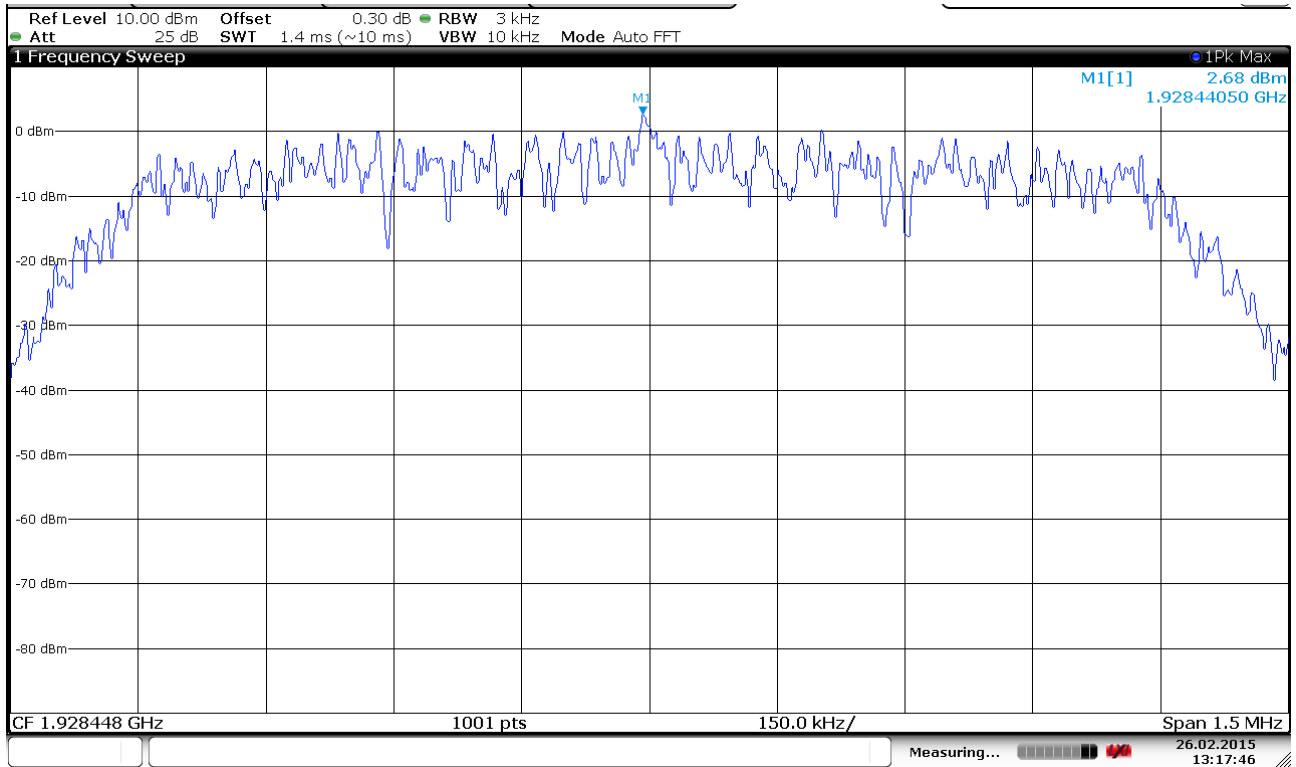

Overview

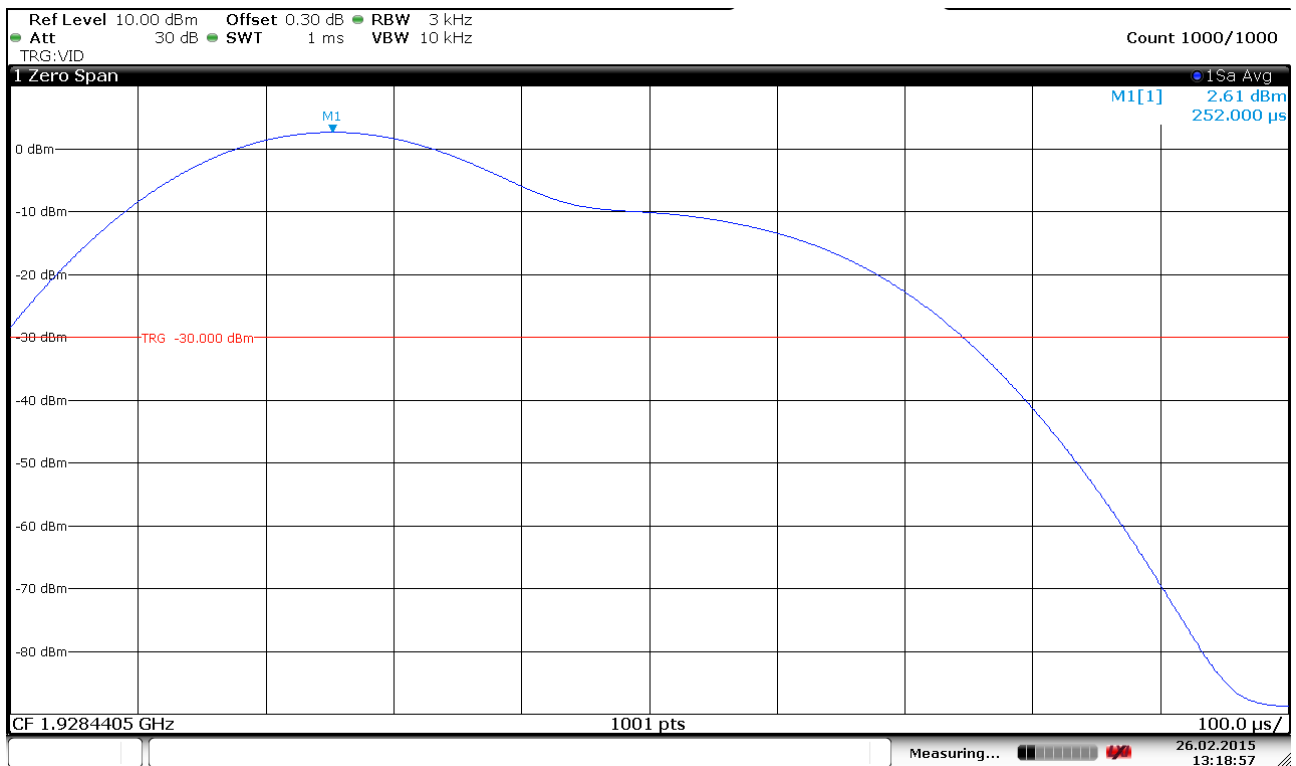

Averaged, 1000 Sweeps

3.10 In-Band Unwanted Emissions, Conducted

Test Method:

ANSI C63.17, clause 6.1.6.1.

Test Results: Complies

Measurement Data:

See plots.

Requirements, FCC 15.323(d):

- $B < f \leq 2B$: at least 30 dB below max. permitted peak power
- $2B < f \leq 3B$: at least 50 dB below max. permitted peak power
- $3B < f \leq$ UPCS Band Edge : at least 60 dB below max. permitted peak power

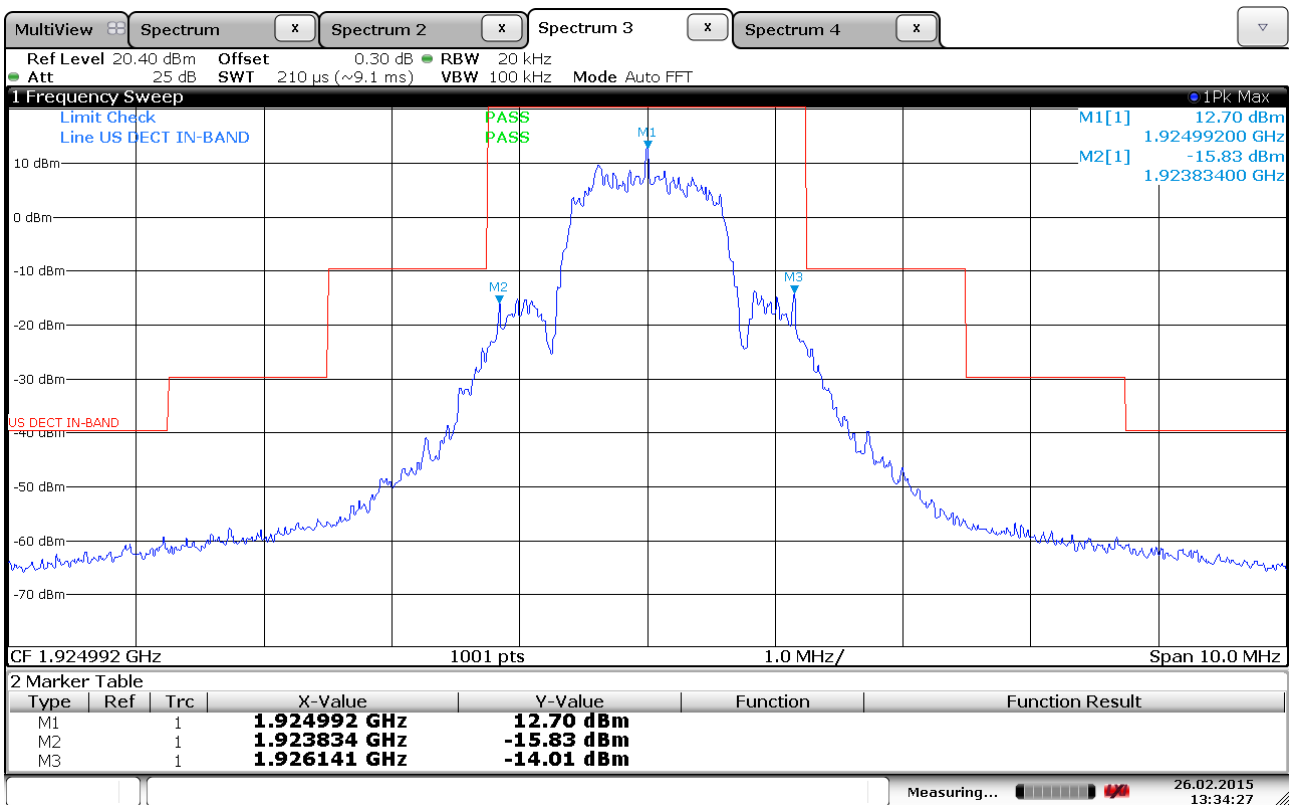

Middle Channel

In-Band Unwanted Emissions, Conducted

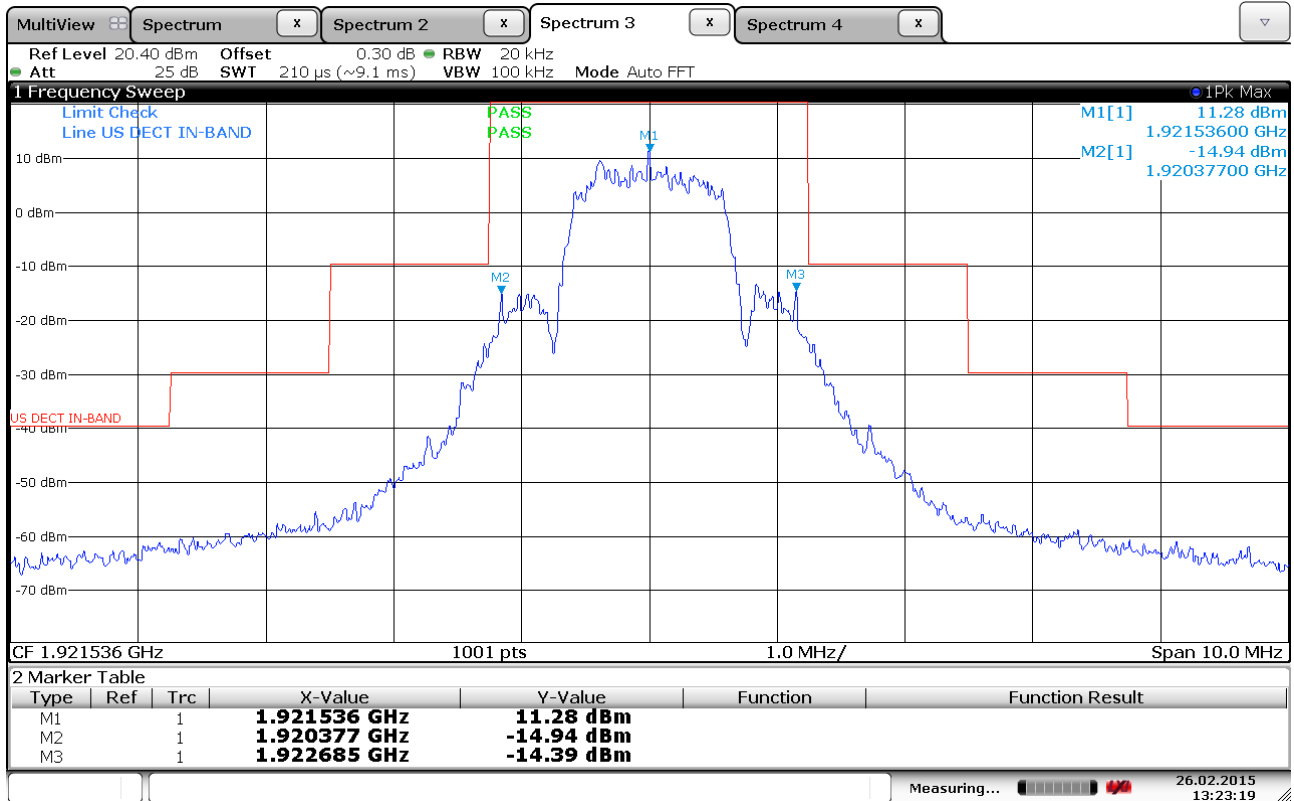

Lower Channel

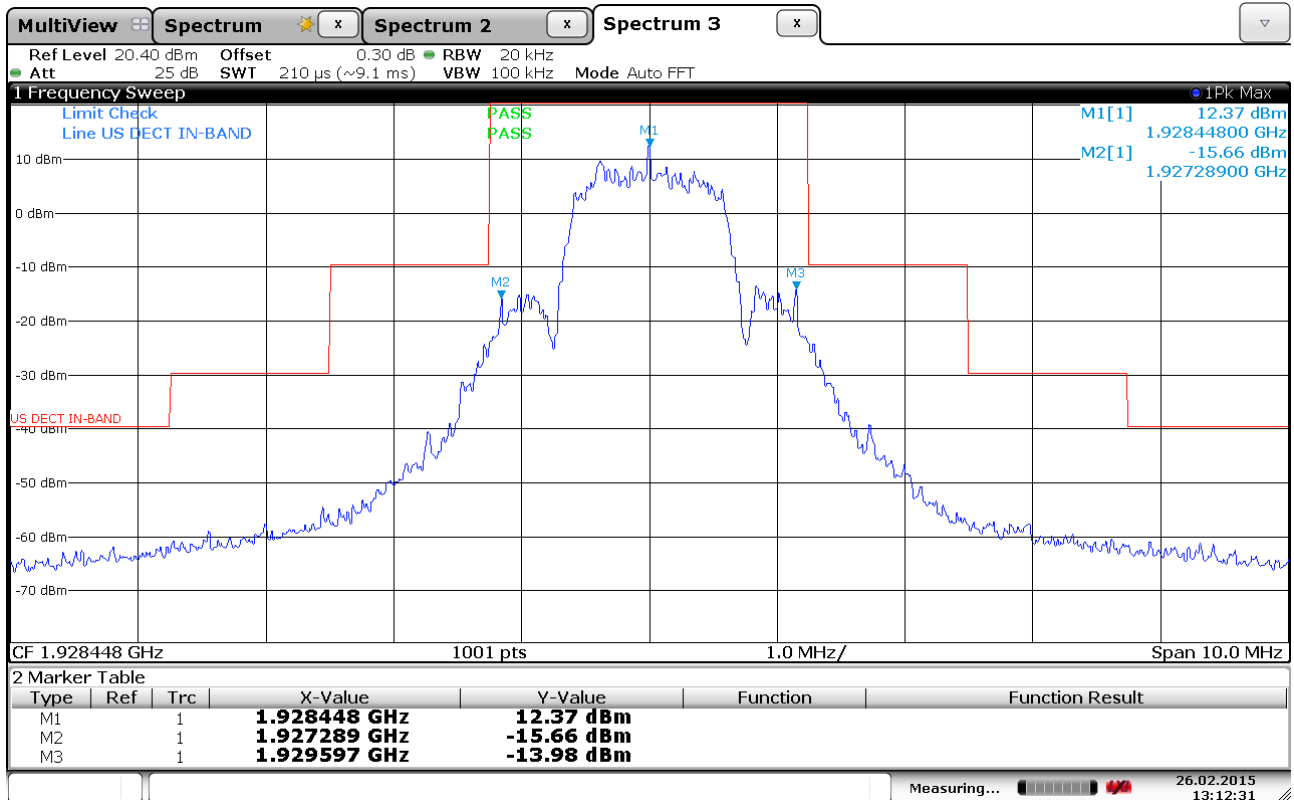

Upper Channel

3.11 Out-of-band Emissions, Conducted

Test Method:

ANSI C63.17, clause 6.1.6.2.

Test Results: Complies

Measurement Data:

See plots.

Requirements, FCC 15.323(d):

- $f \leq 1.25\text{MHz}$ outside UPCS band : $\leq -9.5\text{dBm}$
- $1.25\text{MHz} \leq f \leq 2.5\text{MHz}$ outside UPCS band : $\leq -29.5\text{ dBm}$
- $f \geq 2.5\text{MHz}$ outside UPCS band : $\leq -39.5\text{ dBm}$

Out-of-Band Emissions, Conducted

Lower Channel:

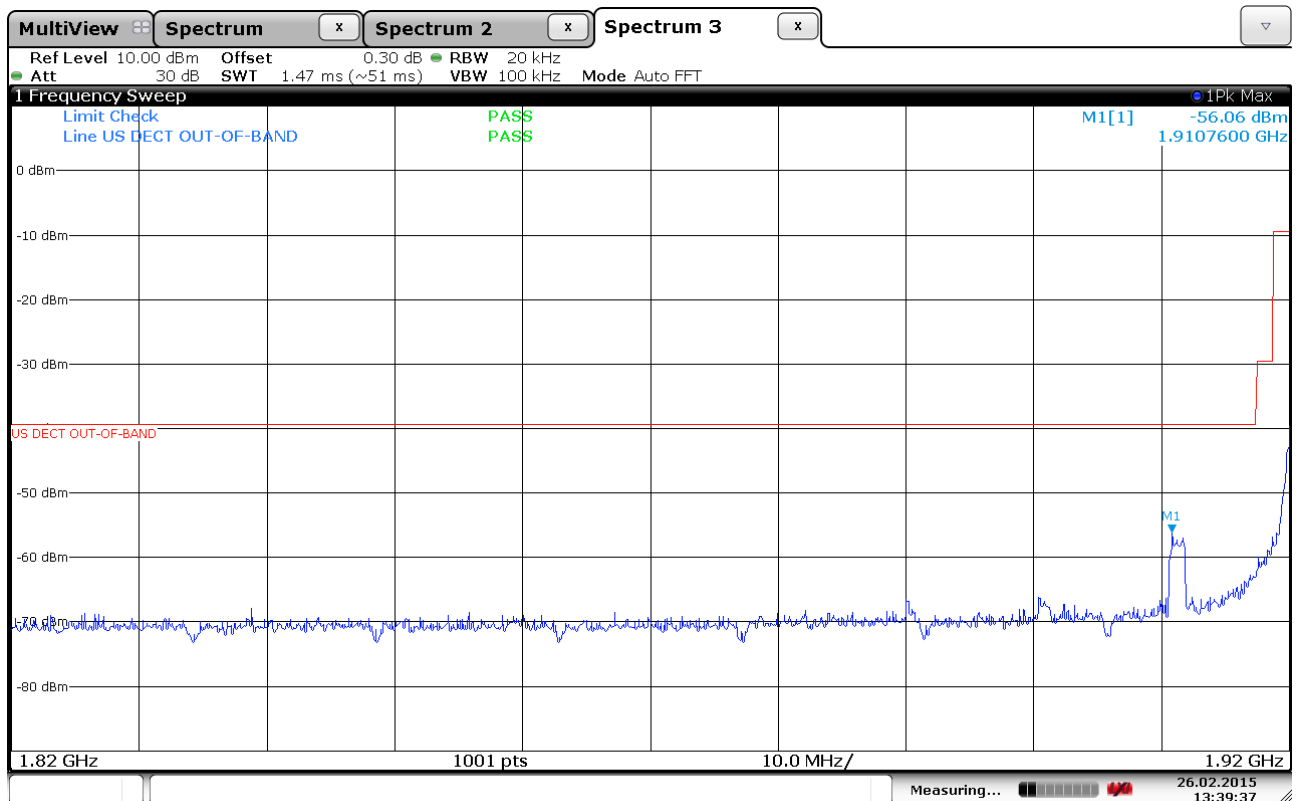

Out-of-Band Emissions, Conducted

Lower Channel:

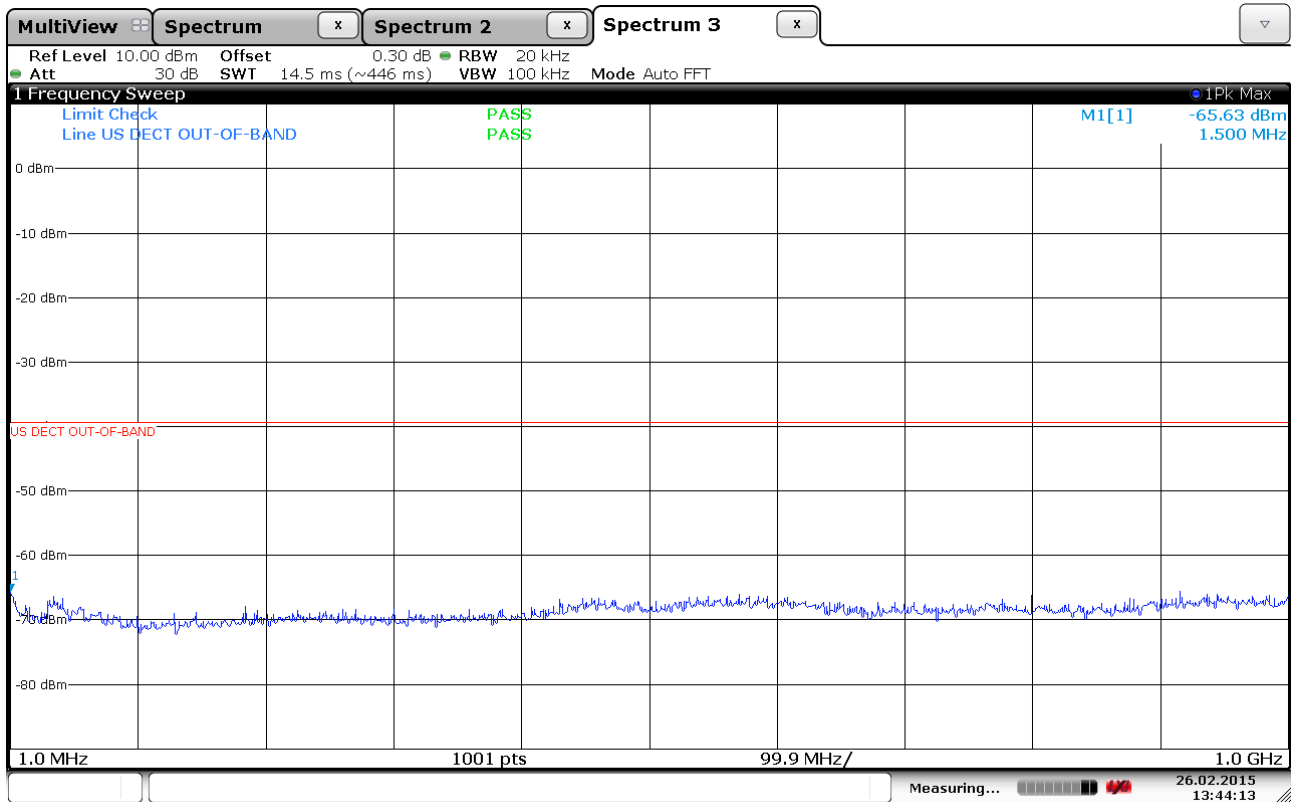
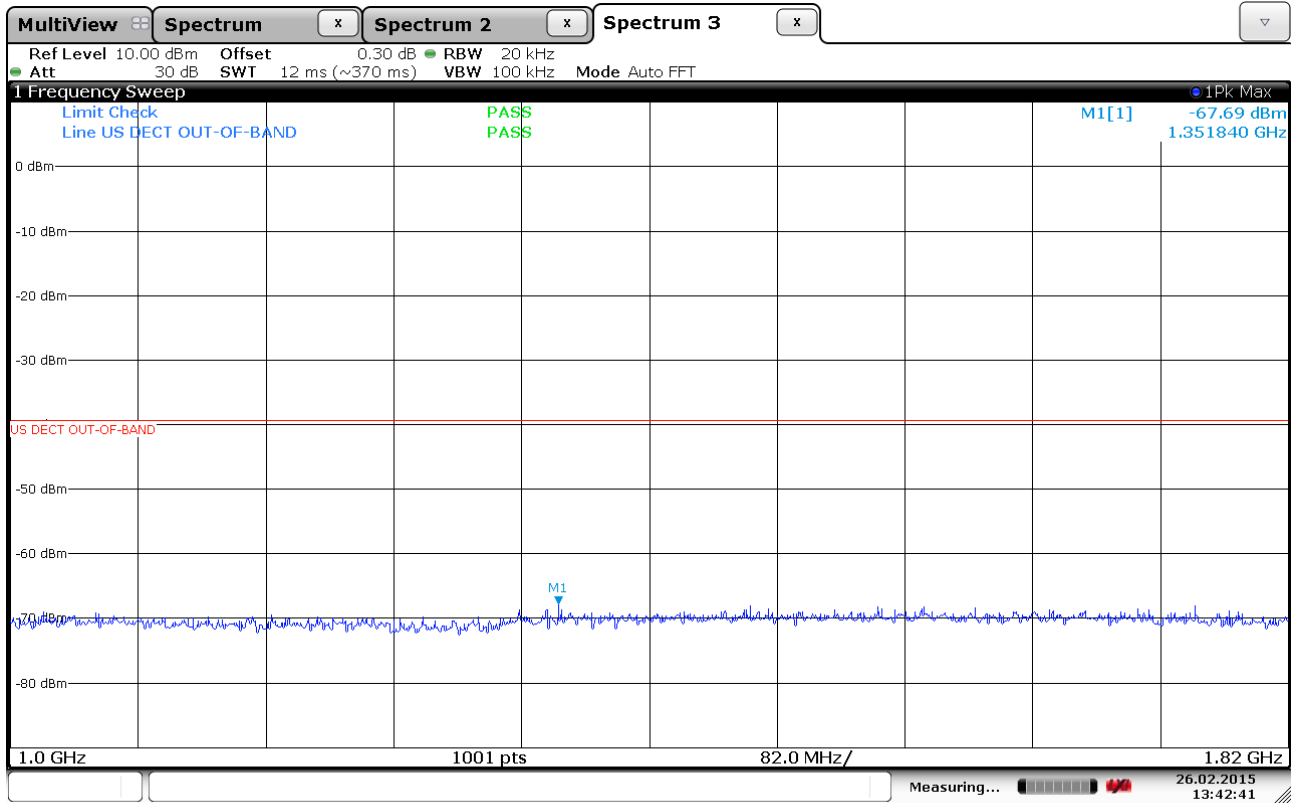

Out-of-Band Emissions, Conducted

Upper Channel:

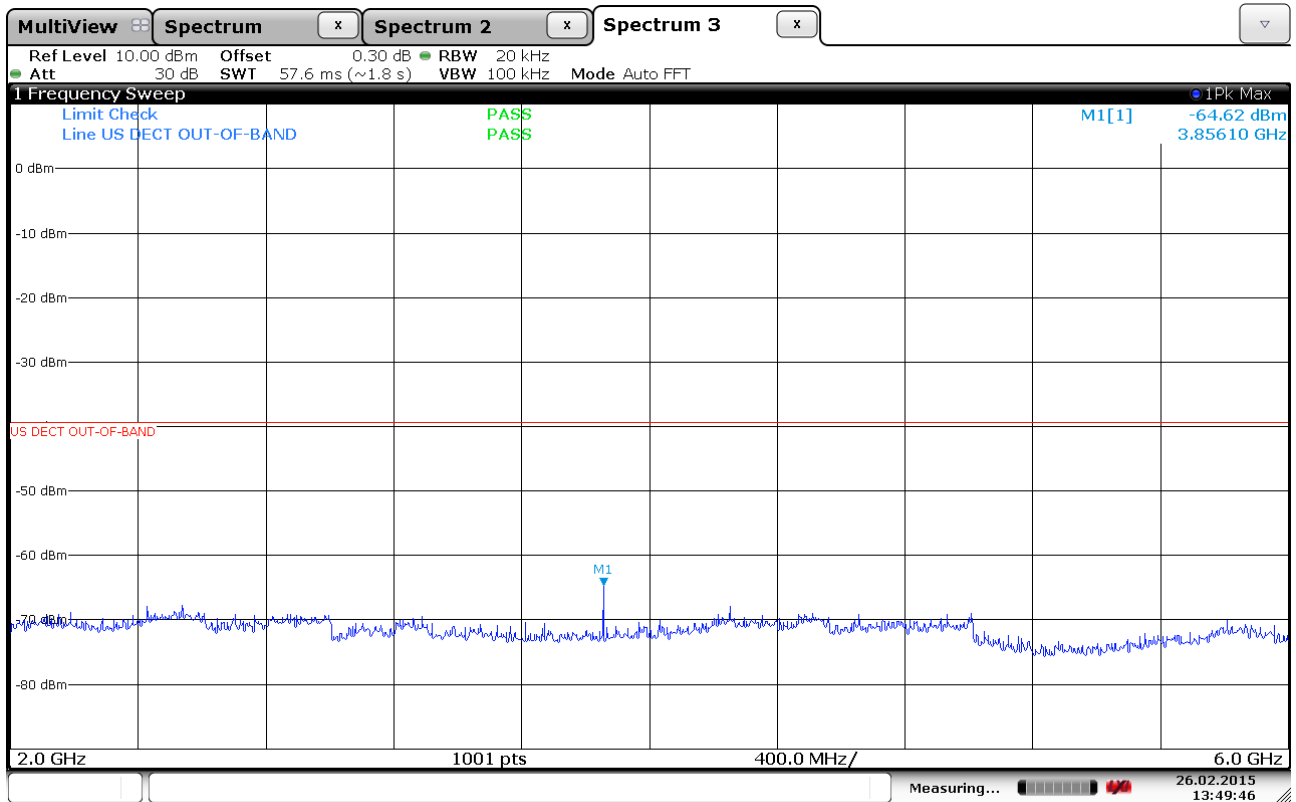
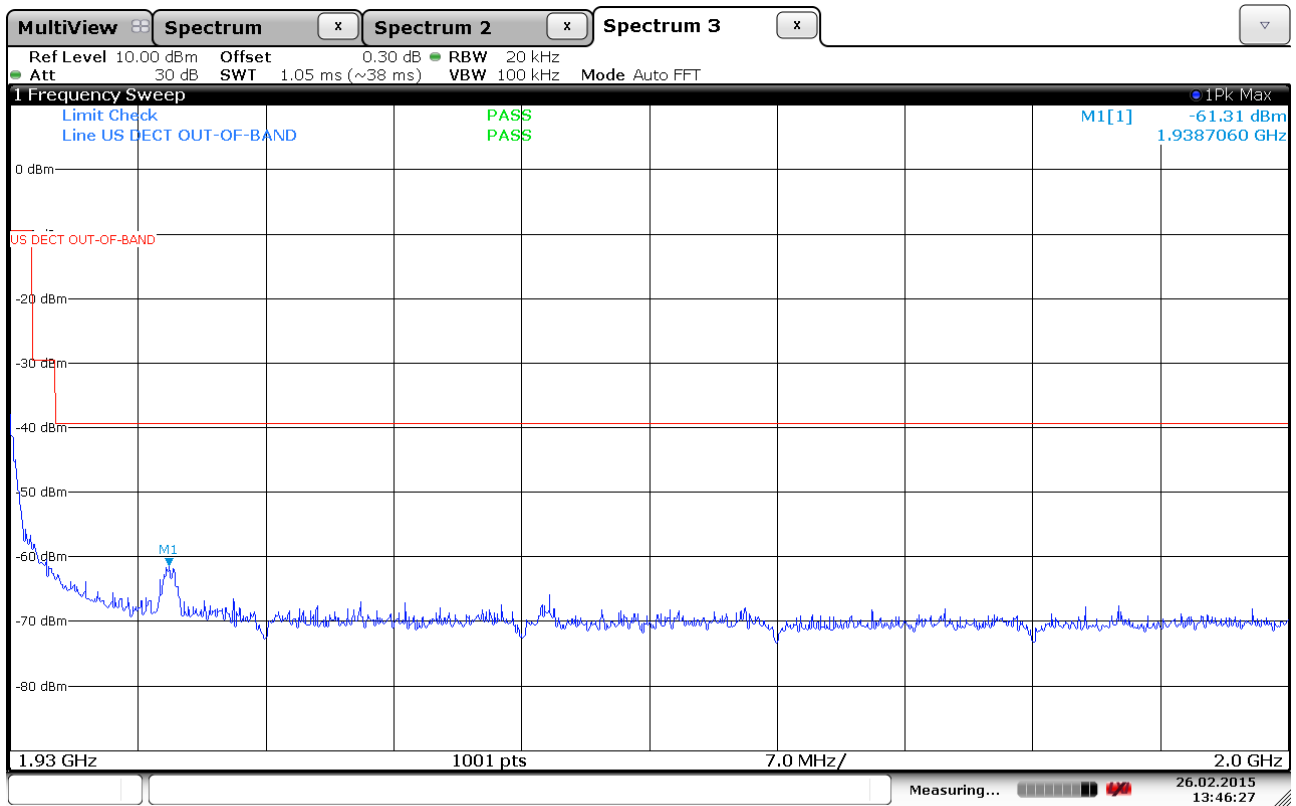

Out-of-Band Emissions, Conducted

Upper Channel:

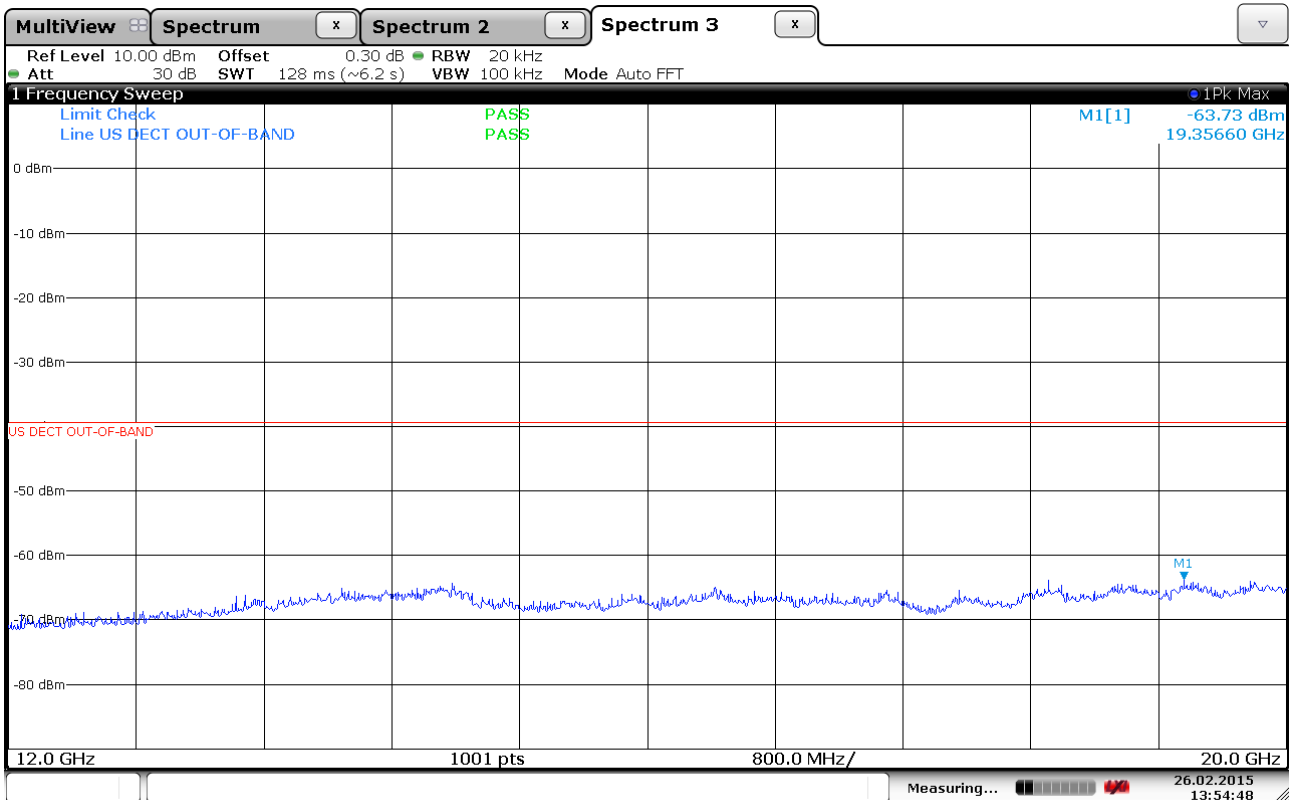
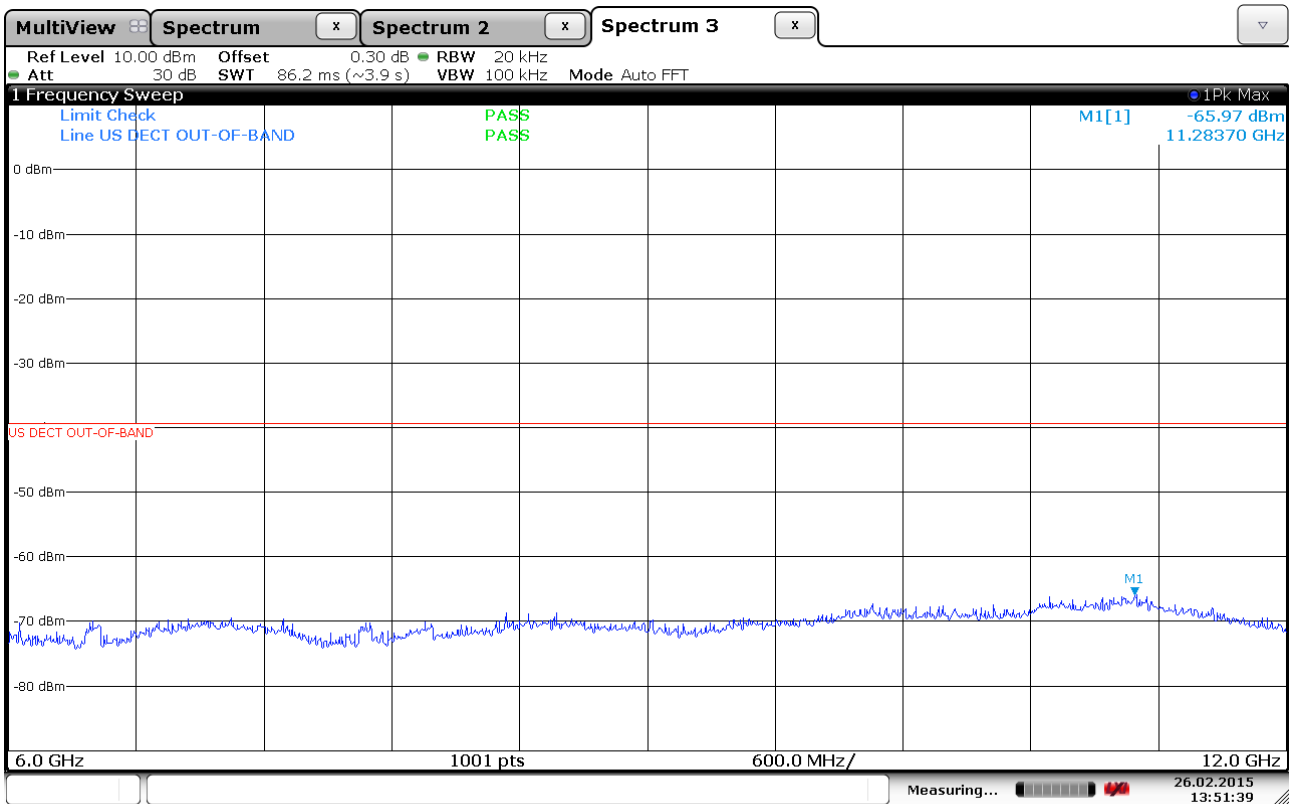

Out-of-Band Emissions, Conducted

Lower Channel:

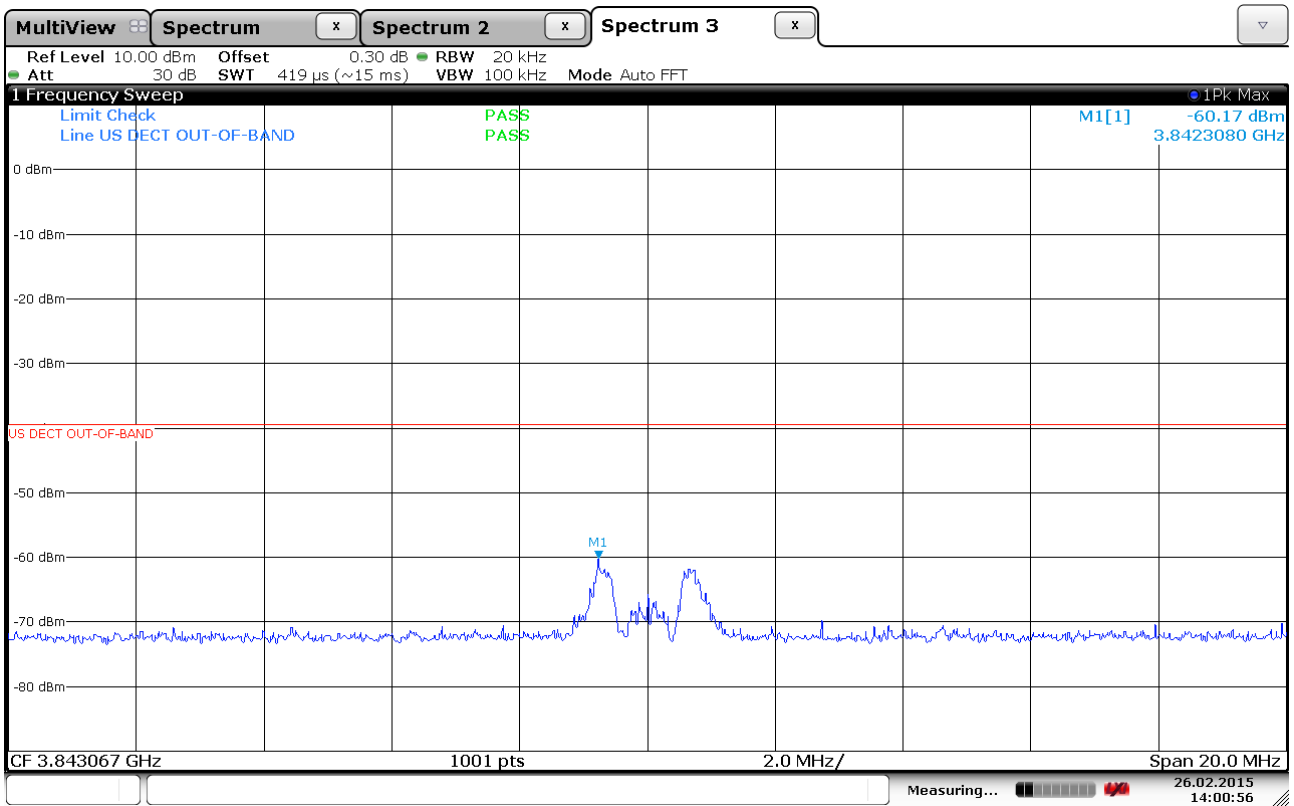

Middle Channel:

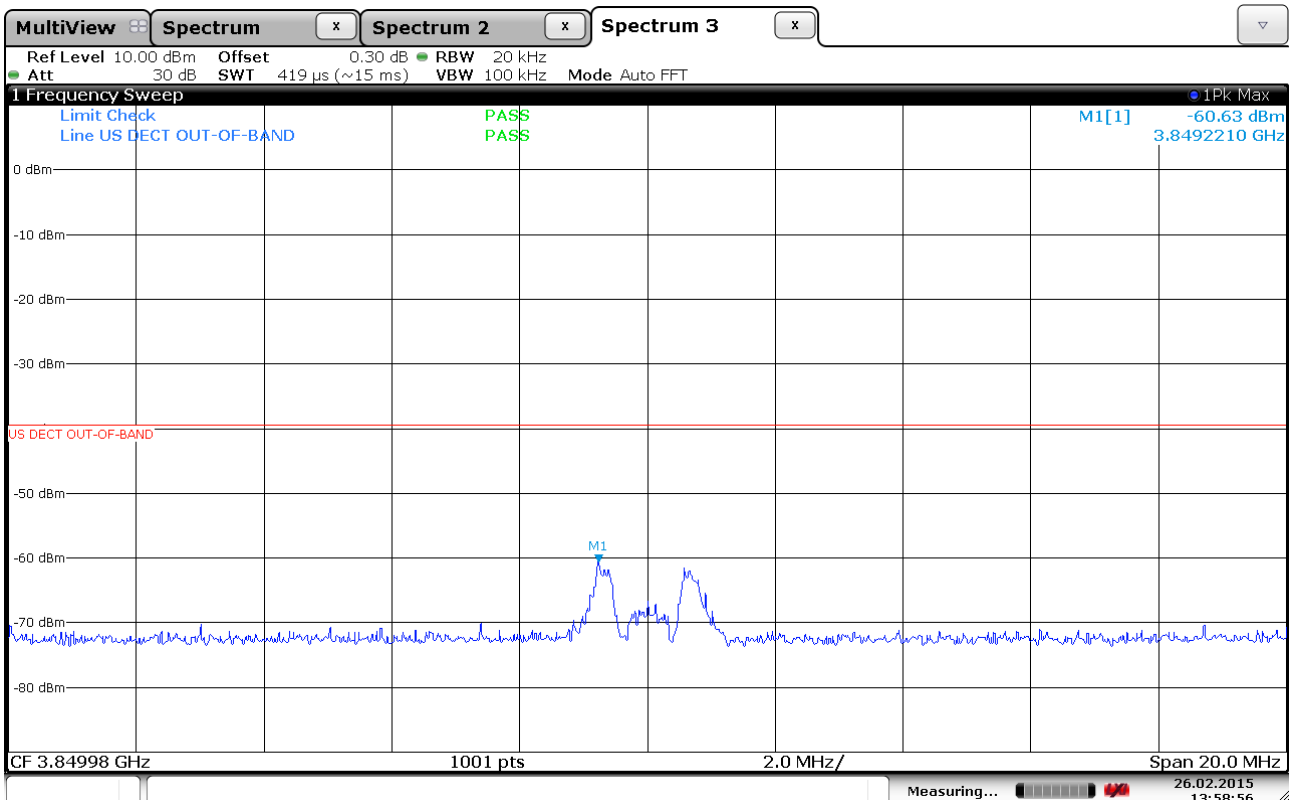

Out-of-Band Emissions, Conducted

Upper Channel:

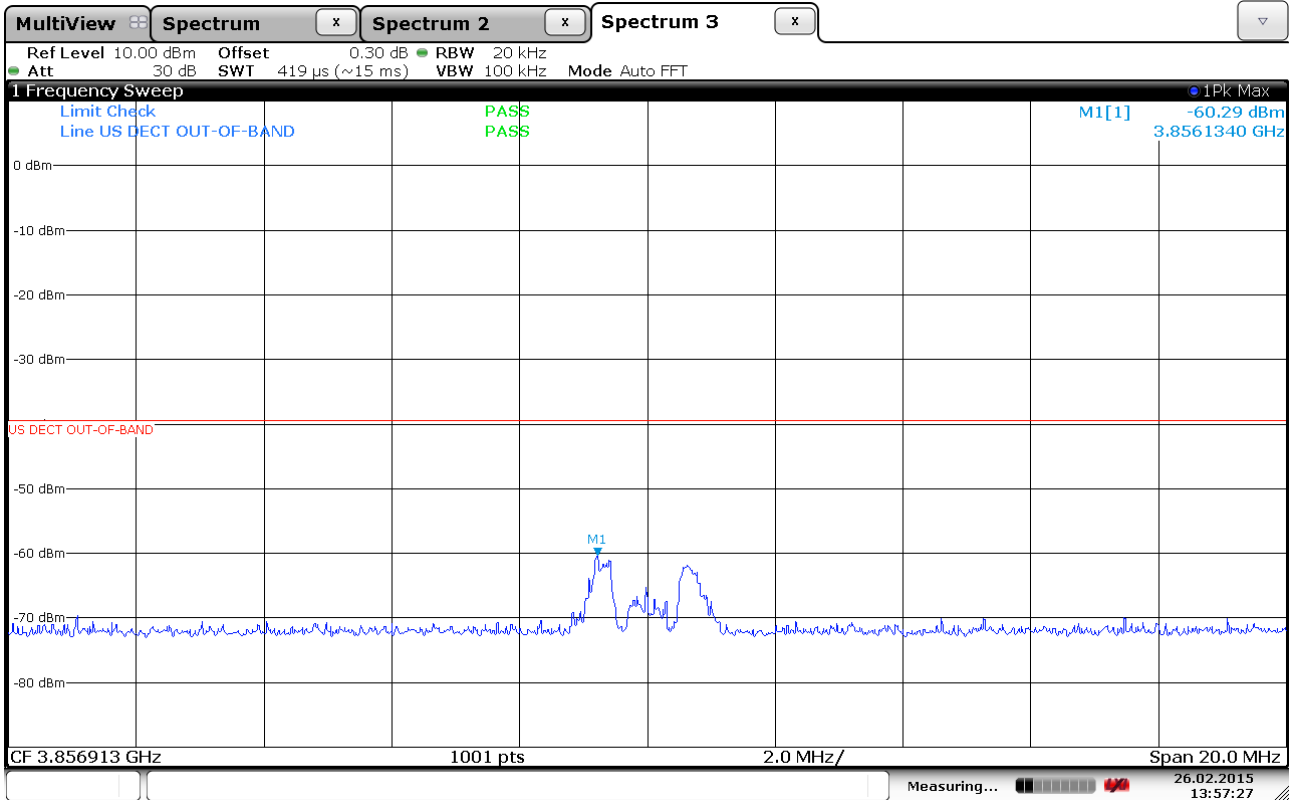

3.12 Carrier Frequency Stability

Test Method:

ANSI C63.17, clause 6.2.1.

Test Results: Complies

Measurement Data:

The Frequency Stability is measured with the HP 53310A. The HP 53310A was logged by a computer programmed to get new readings as fast as possible (about 1 reading per second) over the noted number of readings. The peak-to-peak difference was recorded and the mean value and deviation in ppm was calculated.

The Carrier Frequency Stability over Power Supply Voltage and over Temperature is measured with a Frequency Domain Analyzer in histogram mode.

Carrier Frequency Stability over Time at Nominal Temperature

Average Mean Carrier Frequency (MHz)	Max. Diff. (kHz)	Min. Diff. (kHz)	Max. Dev. (ppm)	Limit
1924.977672	-8.859	-17.829	-1.8	±10 ppm

Deviation ppm = ((Diff. - Mean Diff) / Mean Carrier Freq.) x 10⁶

Deviation (ppm) is calculated from 3000 readings.

Frequency Stability over Power Supply Voltage at Nominal Temperature

Voltage	Measured Carrier Frequency (MHz)	Difference (kHz)	Deviation (ppm)	Limit
V _{nom}	1924.9930	0	0	±10 ppm
85% of V _{nom}	1924.9930	0	0	
115% of V _{nom}	1924.9922	-0.8	-0.4	

Deviation ppm = ((Mean – Measured Frequency) / Mean) x 10⁶

This test does not apply for EUT that is powered from batteries.

Frequency Stability over Temperature

Temperature	Measured Carrier Frequency (MHz)	Difference (kHz)	Deviation (ppm)	Limit
T = +20 °C	1924.9930	0	0	±10 ppm
T = -20 °C	1924.9887	-4.3	-2.2	
T = +50 °C	1924.9842	-8.8	-4.6	

Deviation ppm = ((Mean – Measured Frequency) / Mean) x 10⁶

3.13 Frame Repetition Stability

Test Method:

ANSI C63.17, clause 6.2.2.

Test Results: Complies

Measurement Data:

The envelope of the RF signal from the EUT is detected with a Crystal Detector and the mean and standard deviation of the frame repetition frequency is then gated over 100 frames and measured with a Frequency Domain Analyzer. The frame repetition stability is 3 times the standard deviation.

Carrier Frequency (MHz)	Mean (Hz)	Standard Deviation (μHz)	Frame Repetition Stability (ppm)
1924.992	100.000	1.030	0.031

Limit:

Frame Repetition Stability	±10 ppm (TDMA)
-----------------------------------	----------------

Ref. FCC 15.323(e), ANSI C63.17, clause 6.2.2

3.14 Frame Period and Jitter

Test Method:

ANSI C63.17, clause 6.2.3.

Test Results: Complies

Measurement Data:

Carrier Frequency (MHz)	Frame Period (ms)	Max Jitter (μs)	3xStandard Deviation of Jitter (μs)
1924.992	10.000	-0.015	-0.010

Max Jitter = (1/ (Frame period + Pk-Pk/2)) - (1/Frame Period), when Pk-Pk and Frame Period are in Hz

3xSt.Dev.Jitter = 3x (1/(Frame Period + St.Dev) – 1/St.Dev) x 10⁶

Limit:

Frame Period	20 or 10 ms
Max Jitter	25 μs
3 times St.Dev of Jitter	12.5 μs

Ref. FCC 15.323(e), ANSI C63.17, clause 6.2.3

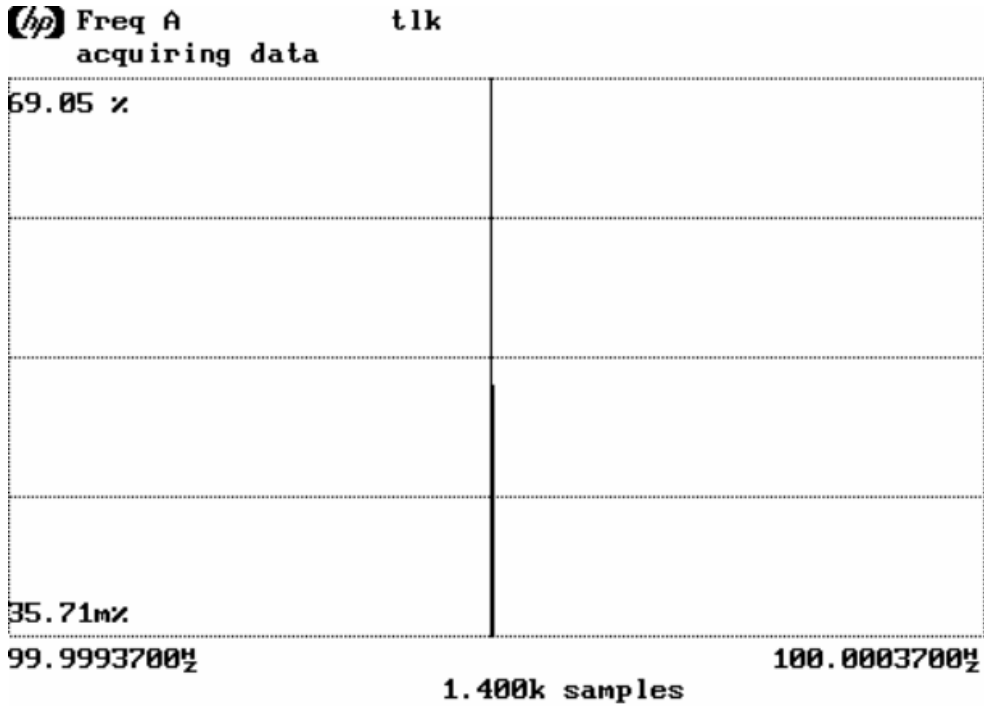

Mean 99.999865121 MHz 1/Mean 10.000ms
 Pk-Pk 2.23 MHz Std Dev 1.030 MHz

Frame Repetition Stability, Gated over 100 Frames

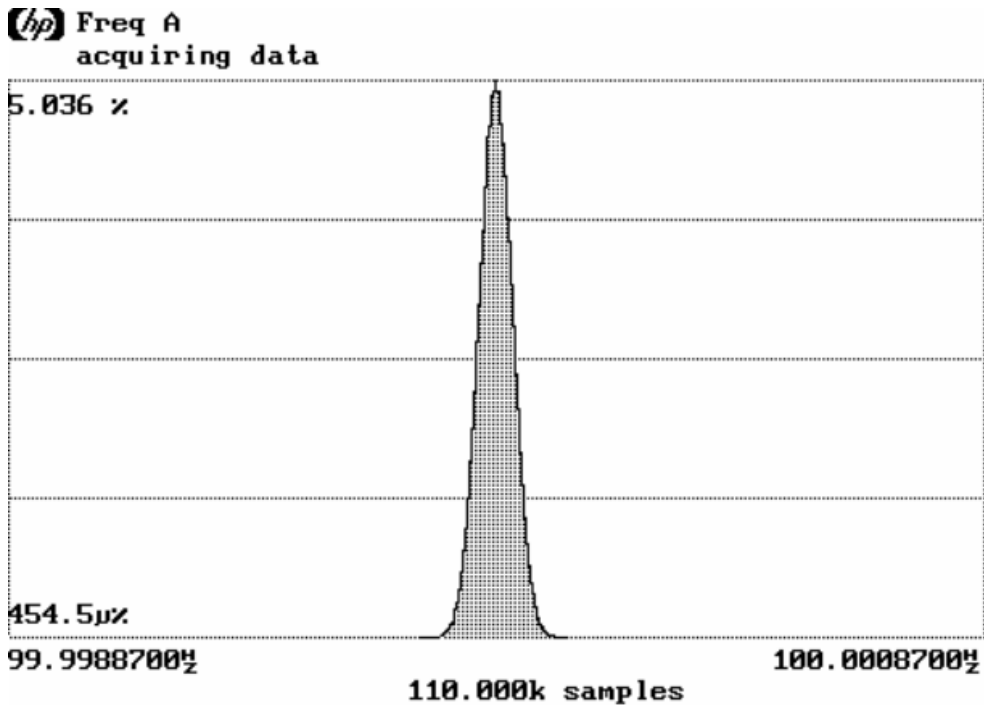

Mean 99.9998685759 MHz 1/Mean 10.000ms
 Pk-Pk 294.0 MHz Std Dev 34.6674 MHz

Frame Period and Jitter

3.15 Monitoring Threshold, Least Interfered Channel

Monitoring Threshold Limits:

Lower Threshold:

$$T_L = 15 \log B - 184 + 30 - P_{EUT} \quad (\text{dBm})$$

Upper Threshold:

$$T_U = T_L + 20 \quad (\text{dBm})$$

B is measured Emission Bandwidth in Hz
 P_{EUT} is measured Transmitter Power in dBm

Calculated values:

	FCC 15.323	RSS-213, Issue 2
Lower Threshold	-79.9 dBm	-80.6 dBm
Upper Threshold	N/A	-60.6 dBm

Least Interfered Channel Procedure (LIC) may only be used by systems with more than 20 duplex system access channels. Systems with less than 20 duplex system access channels are not allowed to transmit when interferer level is above Lower Threshold.

Upper Threshold has been removed from FCC 15D and ANSI C63.17-2013 but still exists in Industry Canada RSS-213. Upper Threshold is only defined in ANSI C63.17-2006.

Measurement Procedure:

The Upper or Lower Threshold is found by the procedures defined in ANSI C63.17-2006 clause 7.3.1 and 7.3.2.

Least Interfered Channel Procedure NOT used:	
Lower Threshold	N/A dBm
Least Interfered Channel Procedure:	
Upper Threshold	-60.6 dBm

Least Interfered Channel (LIC) Procedure Test, FCC 15.323(b), (c)(2) and (c)(5)

ANSI C63.17 clause 7.3.2 ref.	Observation	Verdict
b) f_1 at $T_L + U_M + 7$ dB, f_2 at $T_L + U_M$	Transmission always on f_2	Pass
c) f_1 at $T_L + U_M$, f_2 at $T_L + U_M + 7$ dB	Transmission always on f_1	Pass
d) f_1 at $T_L + U_M + 1$ dB, f_2 at $T_L + U_M - 6$ dB	Transmission always on f_2	Pass
e) f_1 at $T_L + U_M - 6$ dB, f_2 at $T_L + U_M + 1$ dB	Transmission always on f_1	Pass

Selected Channel Confirmation, FCC 15.323(c)(1) and (5)

ANSI C63.17 clause 7.3.3	Observation	Verdict
b) Shall not transmit on f_1	EUT transmits on f_2	Pass
d) Shall not transmit on f_2	EUT transmits on f_1	Pass

Limits:

	FCC 15.323	RSS-213, Issue 2
Lower Threshold + 6 dB margin	-73.9 dBm	-74.6 dBm
Upper Threshold + 6 dB margin	N/A	-54.6 dBm

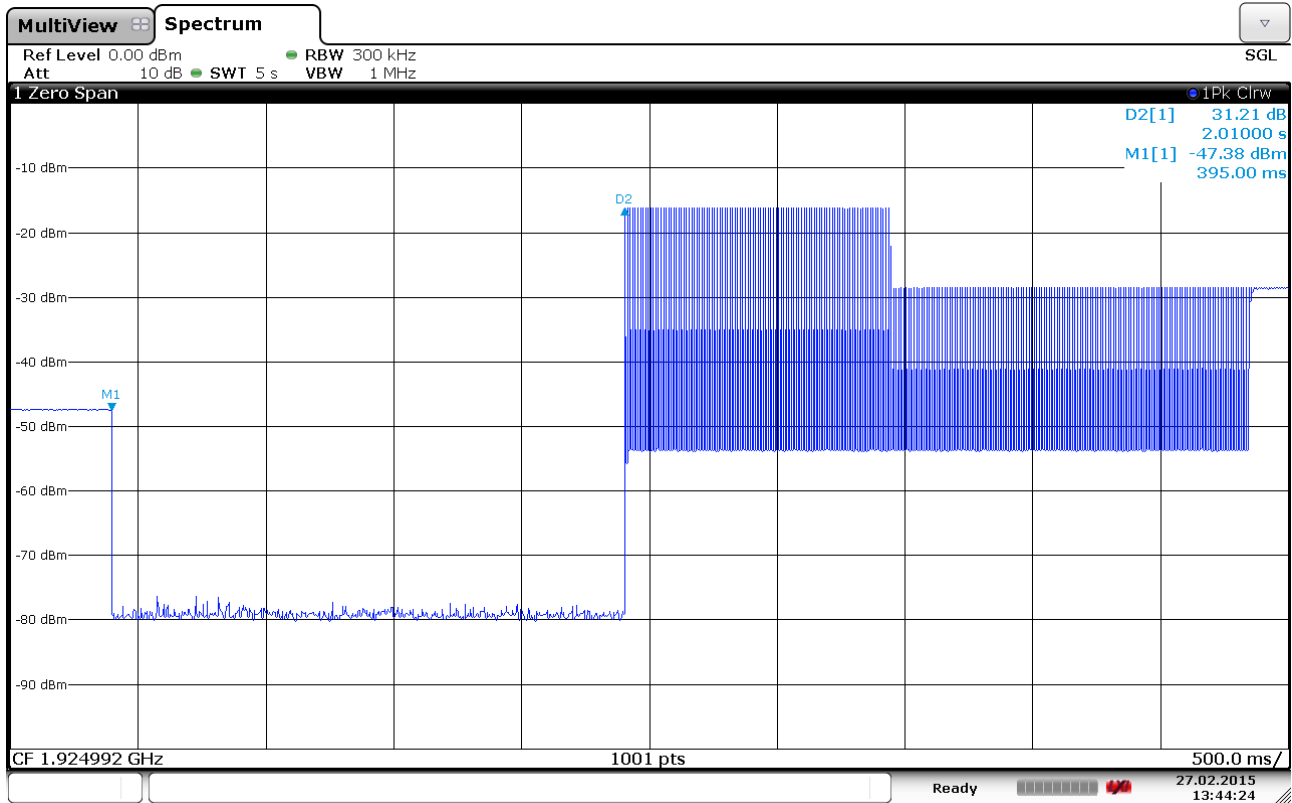

7.3.4 Selected Channel Confirmation, Connection 2.0s After Interferer Removed

3.16 Threshold Monitoring Bandwidth

This test is only required if a dedicated monitoring receiver is used. However, if the test is not carried out the manufacturer shall declare and provide proper evidence that the monitoring is made through the radio receiver used for communication.

Measurement Procedure:

Simple Compliance Test, ANSI C63.17, clause 7.4.1

More Detailed Test, ANSI C63.17, clause 7.4.2

The test is passed if **either** the Simple Compliance Test or the More Detailed test is passed.

During this test the spectrum analyzer is observed visually to see if the EUT transmits or not.

Test Results:

Test performed	Observation	Verdict
Simple Compliance test, at $\pm 30\%$ of B	N/A	N/A
More Detailed Test, at -6 dB points	N/A	N/A
More Detailed Test, at -12 dB points	N/A	N/A

The more detailed test must be pass at both the -6 and -12 dB points if the Simple Compliance test fails.

Comment: The manufacturer declares that the tested EUT uses the same receiver for monitoring and communication, this test is therefore not required.

Limits, FCC 15.323(c)(7):

The monitoring system bandwidth must be equal to or greater than the emission bandwidth of the intended transmission.

3.17 Reaction Time and Monitoring Interval

Measurement Procedure

ANSI C63.17, clause 7.5

Test results:

By administrative commands and out-of-operating region interference, the EUT is restricted to operate on two RF carrier frequencies.

A CW interferer signal at a level T_L is applied on f_1 and time-synchronized pulsed interference at a level $T_L + U_M$ dB is applied on f_2 . The level on f_2 was raised 6 dB for part d) with 35 μ s pulses.

The pulses are synchronized with the EUT timeslots and applied centered within all timeslots.

For both tests the test is passed if the EUT transmits on f_1 .

Pulse Width, ref. to ANSI C63.17 clause 7.5	Observation	Verdict
c) > largest of 50 μ s and $50 \cdot \text{SQRT}(1.25/B)$	EUT transmits on f_1	Pass
d) > largest of 35 μ s and $35 \cdot \text{SQRT}(1.25/B)$, and with interference level raised 6 dB	EUT transmits on f_1	Pass

Comment: Since B is larger than 1.25 MHz the test was performed with pulse lengths of 50 μ s and 35 μ s.

Limits, FCC 15.323(c)(1), (5) and (7)

The maximum reaction time must be less than $50 \cdot \text{SQRT}(1.25/\text{emission bandwidth in MHz})$ microseconds for signals at the applicable threshold level but shall not be required to be less than 50 μ s.

If a signal is detected that is 6 dB or more above the applicable threshold level, the maximum reaction time shall be $35 \cdot \text{SQRT}(1.25/\text{emission bandwidth in MHz})$ microseconds but shall not be required to be less than 35 μ s.

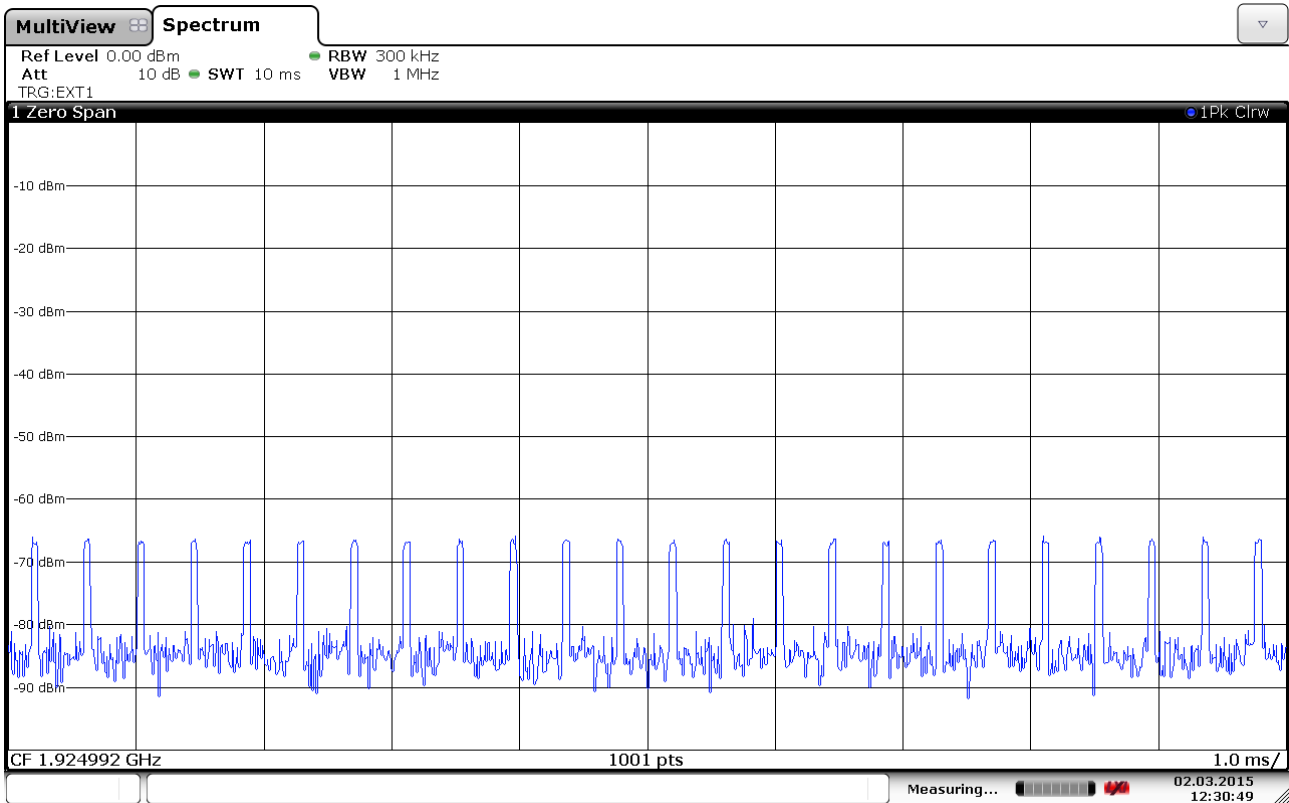

50 µs Pulses

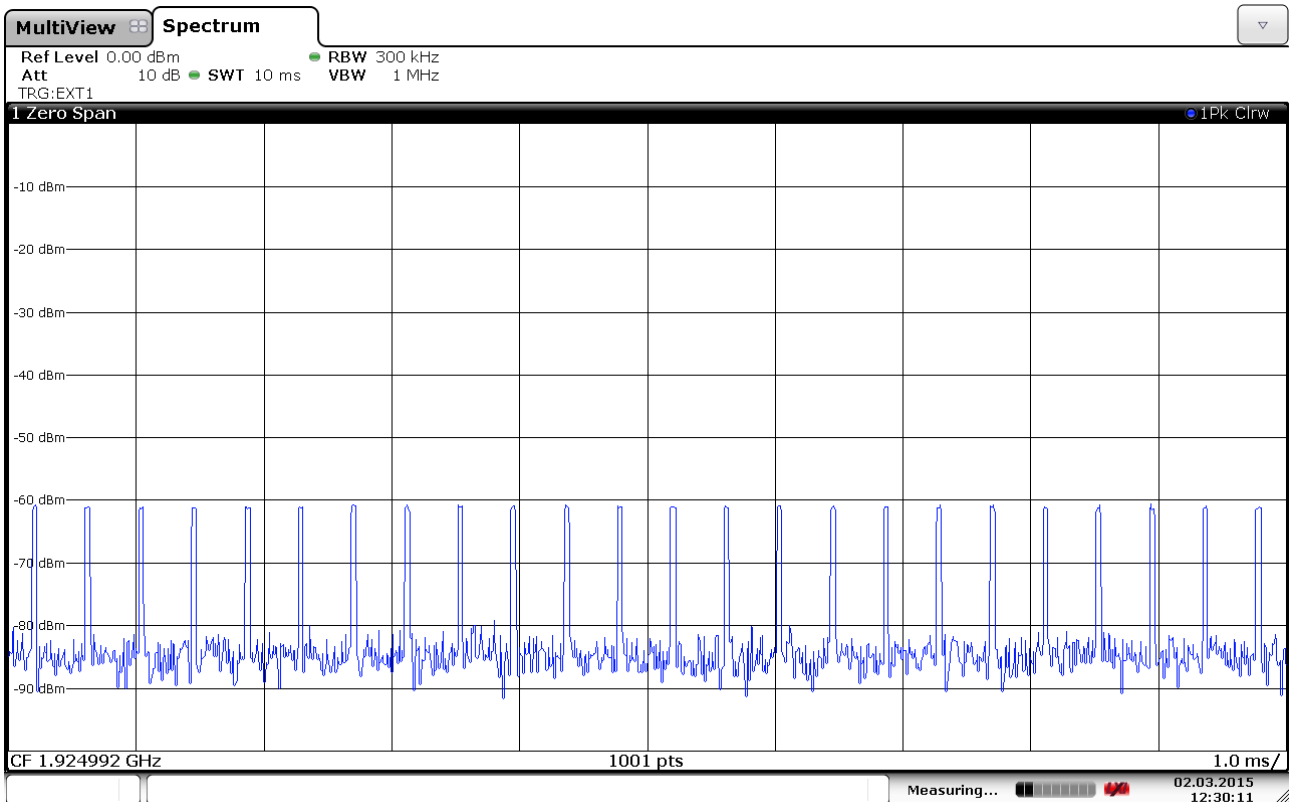

35 µs Pulses

3.18 Time and Spectrum Window Access Procedure

This requirement is only for EUTs which transmit unacknowledged control and signaling information.

Measurement Procedure:

Timing for EUTs using control and signaling channel type transmissions: ANSI C63.17, clause 8.1

Test results:

Access Criteria, ref. to ANSI C63.17 clause 8.1.1	Observation	Verdict
b) Check that the EUT transmits on the interference free time-slot	N/A	N/A
b) The EUT must terminate or pause in its repetitive transmission of the control and signalling channel on the open channel to repeat the access criteria not less frequently than every 30 s	N/A	N/A

If FCC 15.323(c)(6) option, **If Random Waiting Interval is NOT implemented**

Access Criteria, ref. to ANSI C63.17 clause 8.1.2	Observation	Verdict
b) Check that the EUT changes to an interference-free slot when interference is introduced on the time slot in use	N/A	N/A

If FCC 15.323(c)(6) option, **Only if Random Waiting Interval is implemented**

Access Criteria, ref. to ANSI C63.17 clause 8.1.3	Observation	Verdict
b-d) Check that the EUT uses random waiting interval before continuing transmission on an interfered time slot	N/A	N/A

Comment: The tested EUT does not transmit unacknowledged control and signaling information.

Limits:

FCC 15.323(c)(4):

Once access to specific combined time and spectrum windows is obtained an acknowledgement from a system participant must be received by the initiating transmitter within one second or transmission must cease. Periodic acknowledgements must be received at least every 30 seconds or transmission must cease. Channels used exclusively for control and signaling information may transmit continuously for 30 seconds without receiving an acknowledgement, at which time the access criteria must be repeated.

FCC 15.323(c)(6):

If the selected combined time and spectrum windows are unavailable, the device may either monitor and select different windows or seek to use the same windows after waiting an amount of time, randomly chosen from a uniform random distribution between 10 and 150 milliseconds, commencing when the channel becomes available

3.19 Acknowledgements and Transmission Duration

Measurement Procedure:

Acknowledgements: ANSI C63.17, clause 8.2.1

Transmission Duration: ANSI C63.17, clause 8.2.2

During the test **Initial transmission without acknowledgements** the signal from the EUT to the companion device is blocked by circulators in addition to the tunable attenuator.

The test **Transmission time after loss of acknowledgements** is performed by cutting-off the signal from the companion device by a RF switch and measuring the time until the EUT stops transmitting.

The **Transmission Duration** test is performed by monitoring the slot in use and measuring the time until the EUT changes to a different slot.

Test Results:

Acknowledgements

Test ref. to ANSI C63.17 clause 8.2.1	Observation	Verdict
a) Initial transmission without acknowledgements	0.001 sec	Pass
c) Transmission time after loss of acknowledgements	10.0 sec	Pass

Transmission Duration

Test ref. to ANSI C63.17 clause 8.2.2	Observation	Verdict
b) Transmission duration on same time and frequency window	1 hour	Pass

Comment: /

Limits, FCC 15.323(c)(3) and (4)

Occupation of the same combined time and spectrum windows by a device or group of cooperating devices continuously over a period of time longer than 8 hours is not permitted without repeating the access criteria.

Once access to specific combined time and spectrum windows is obtained an acknowledgement from a system participant must be received by the initiating transmitter within one second or transmission must cease.

Periodic acknowledgements must be received at least every 30 seconds or transmission must cease. Channels used exclusively for control and signaling information may transmit continuously for 30 seconds without receiving an acknowledgement, at which time the access criteria must be repeated.

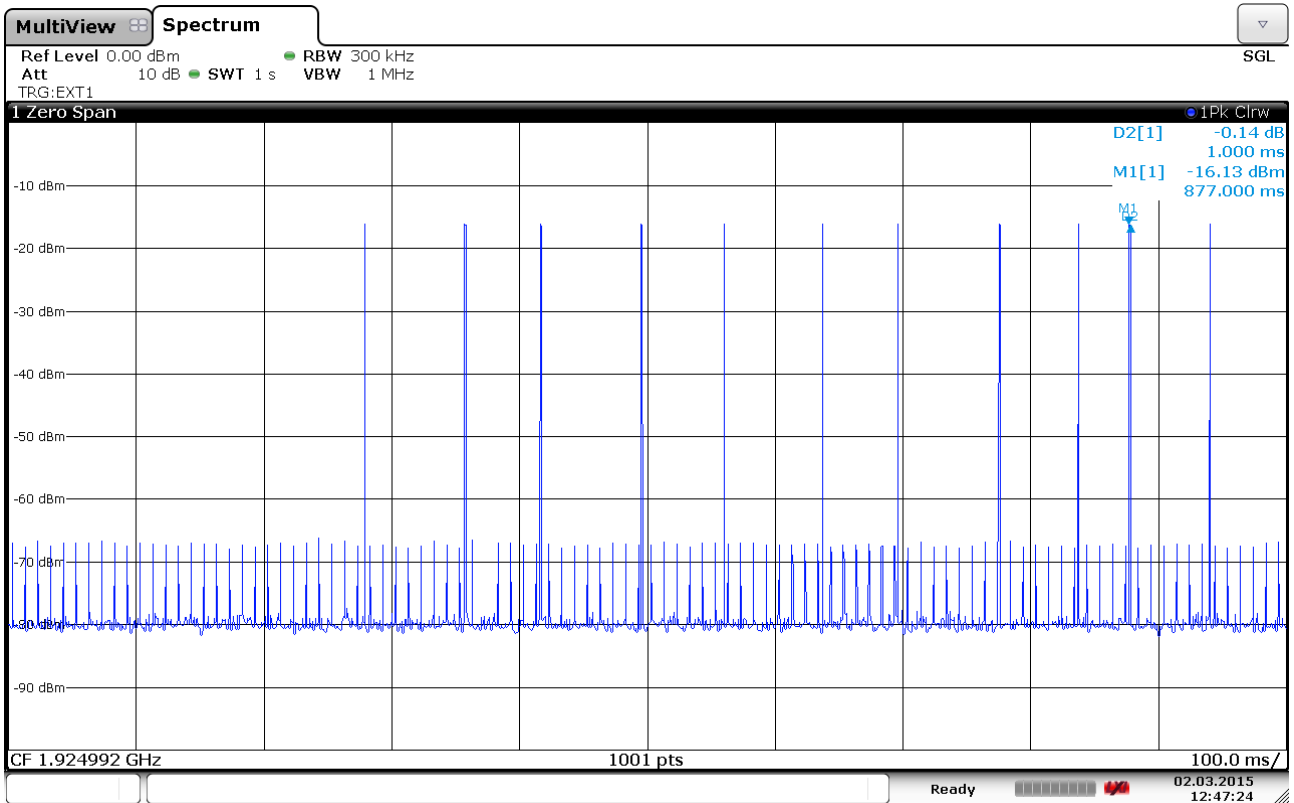

8.2.1a) Initial Transmission Without Acknowledgements



8.2.1c) Transmission Time After Loss of Acknowledgements

3.20 Dual Access Criteria Check

Measurement Procedure:

EUTs that does not implement the LIC procedure: ANSI C63.17, clause 8.3.1

EUTs that implement the LIC procedure: ANSI C63.17, clause 8.3.2

This test is required for equipment that uses the access criteria in FCC 15.323(c)(10).

Test Results:

EUTs that do NOT implements the LIC procedure:

Test ref. to ANSI C63.17 clause 8.3.1	Observation	Verdict
b) EUT is restricted to a single carrier f_i for TDMA systems. The Test is Pass if EUT can transmit	N/A	N/A
c) d) Interference at level $T_L + U_M$ on all timeslots except one receive slot where interference is at least 10 dB below T_L	N/A	N/A
e) f) Interference at level $T_L + U_M$ on all timeslots except one transmit slot where interference is at least 10 dB below T_L	N/A	N/A

EUTs that implements the LIC procedure:

Test ref. to ANSI C63.17 clause 8.3.2	Observation	Verdict
b) EUT is restricted to a single carrier f_i for TDMA systems. The Test is Pass if EUT can transmit	EUT can transmit	Pass
c) d) Transmission on interference-free receive time/spectrum window	EUT transmits on interference free receive slot	Pass
e) f) Transmission on interference-free transmit time/spectrum window	EUT transmits on interference free transmit slot	Pass

Comment: See plots.

Limits, FCC 15.323(c)(10)

An initiating device may attempt to establish a duplex connection by monitoring both its intended transmit and receive time and spectrum windows. If both the intended transmit and receive time and spectrum windows meet the access criteria, then the initiating device can initiate a transmission in the intended transmit time and spectrum window. If the power detected by the responding device can be decoded as a duplex connection signal from the initiating device, then the responding device may immediately begin transmitting on the receive time and spectrum window monitored by the initiating device.

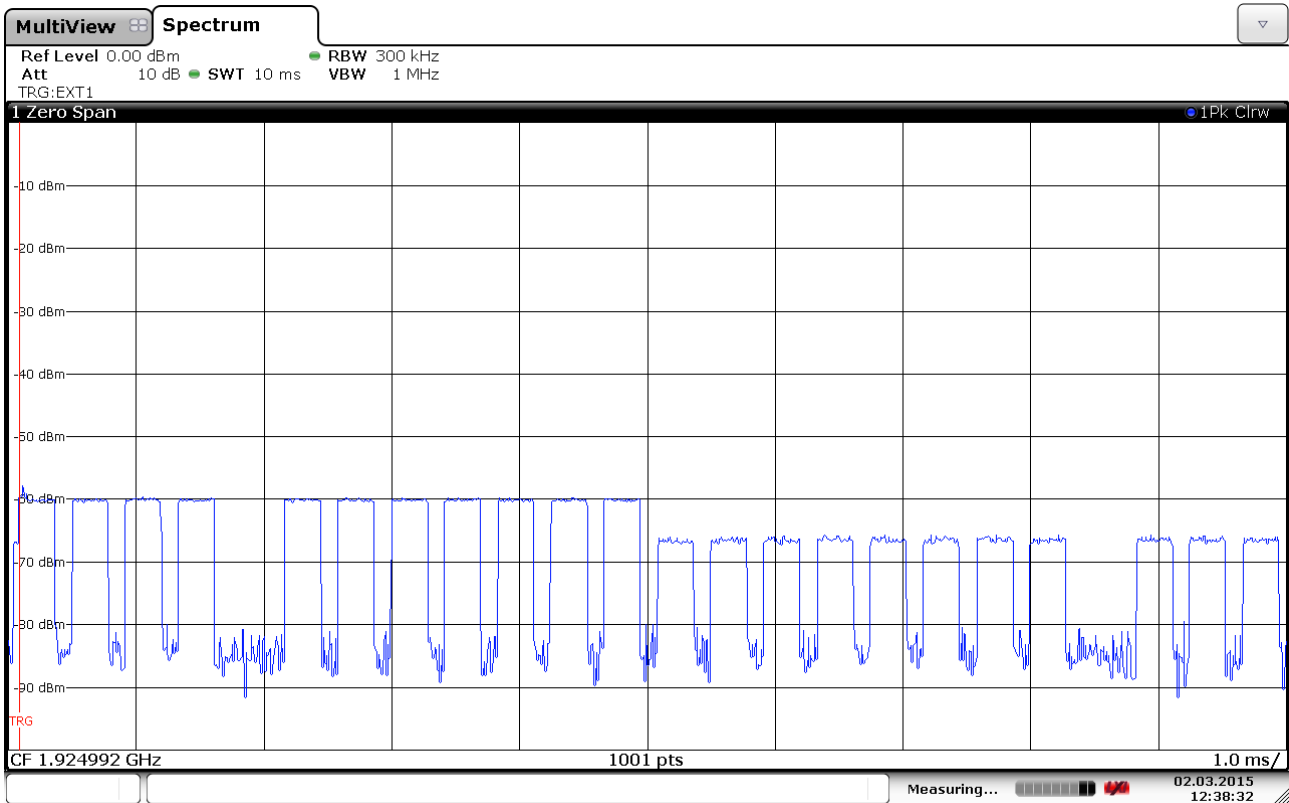

8.3.2c) EUT Transmits on Interference Free RECEIVE Slot, BEFORE

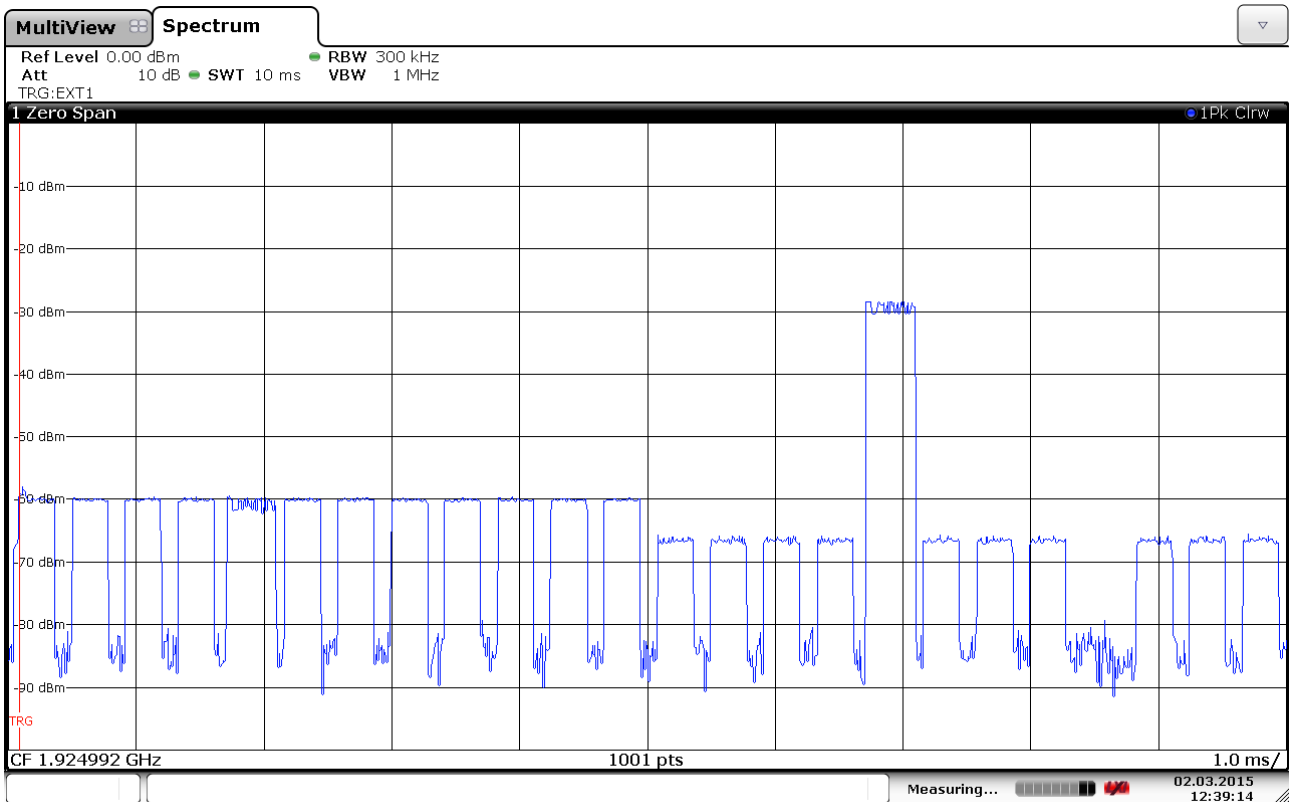

8.3.2c) EUT Transmits on Interference Free RECEIVE Slot, AFTER

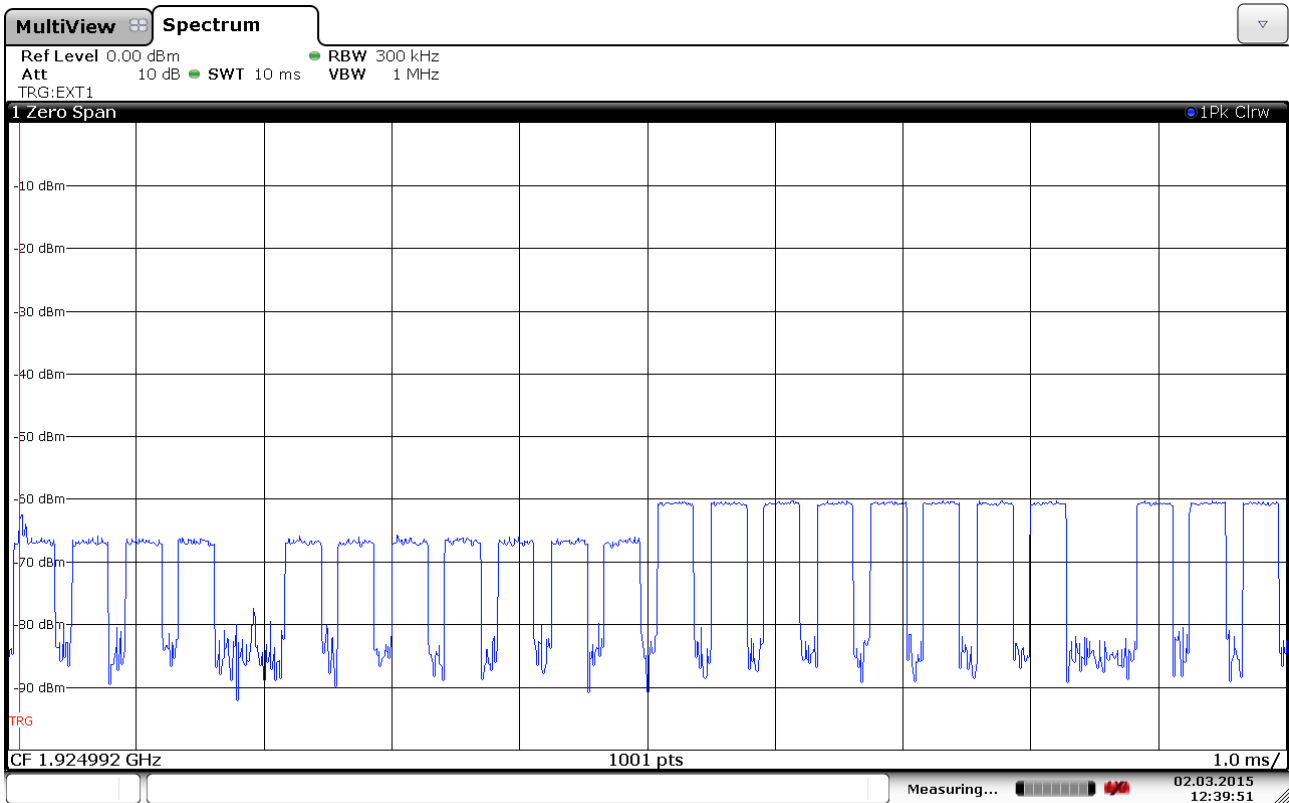

8.3.2e) EUT Transmits on Interference Free TRANSMIT Slot, BEFORE

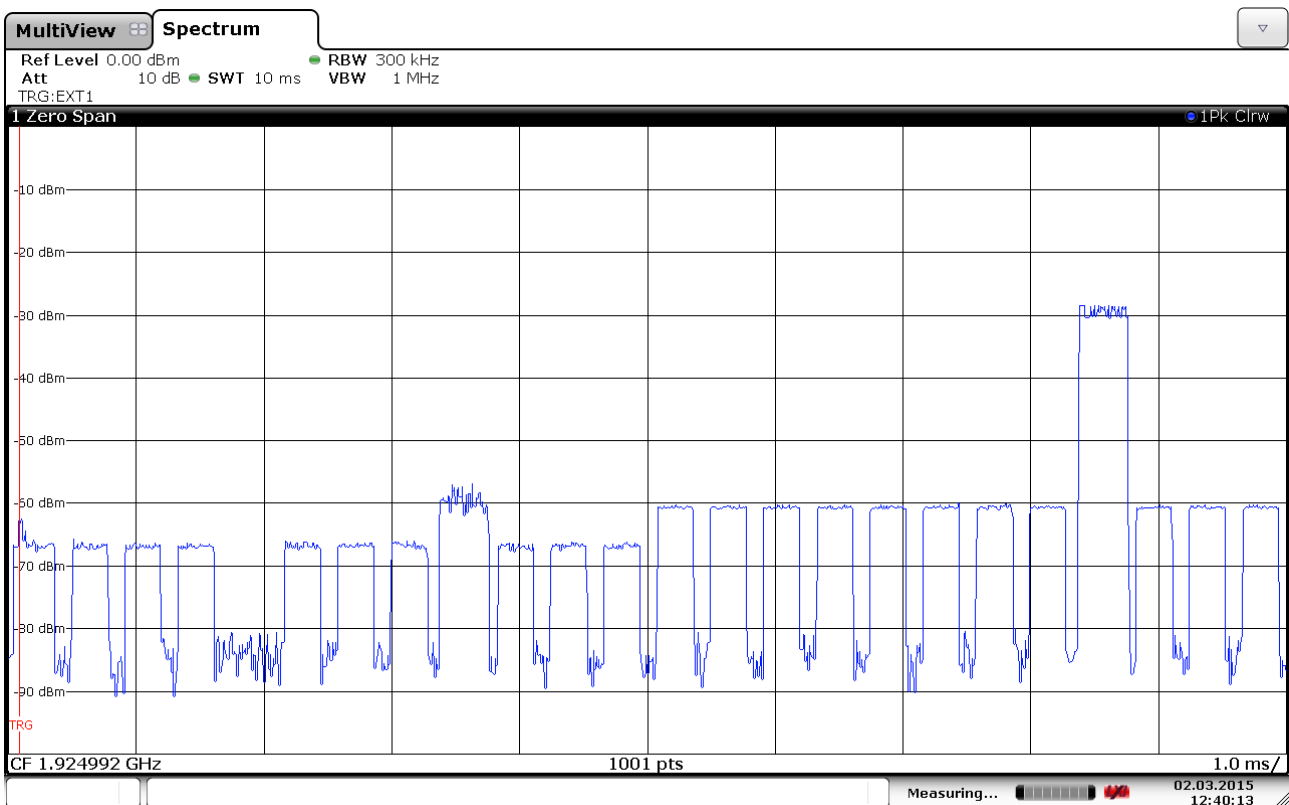

8.3.2e) EUT Transmits on Interference Free TRANSMIT Slot, AFTER

3.21 Alternative Monitoring Interval

Test procedure described in ANSI C63.17 clause 8.4.

This test is required if the EUT implements the provisions of FCC 15.323(c)(11).

Test result:

Not Tested. The tested EUT does not implement this provision. See manufacturers' declaration.

4 Measurement Uncertainty

Measurement Uncertainty Values		
Test Item		Uncertainty
Output Power		±0.5 dB
Power Spectral Density		±0.5 dB
Out of Band Emissions, Conducted (RBW < 100 kHz)	< 3.6 GHz	±0.6 dB
	> 3.6 GHz	±0.9 dB
Spurious Emissions, Radiated	< 1 GHz	±2.5 dB
	> 1 GHz	±2.2 dB
Emission Bandwidth		±4 %
Power Line Conducted Emissions		+2.9 / -4.1 dB
Spectrum Mask Measurements	Frequency	±5 %
	Amplitude	±1.0 dB
Frequency Error		±0.6 ppm
Timing and Jitter Measurements		±2.0 ns
Frame Timing Measurements		±1.4 ppm
Receiver Blocking Levels		±1.0 dB
Temperature Uncertainty		±1 °C

All uncertainty values are expanded standard uncertainty to give a confidence level of 95%, based on coverage factor k=2

5 Test Setups

5.1 Frequency Measurements



Test equipment included: 5, 9, 28

Test Set-up 1

This setup is used for measuring Carrier frequency stability at normal and extreme temperatures.

5.2 Timing Measurements

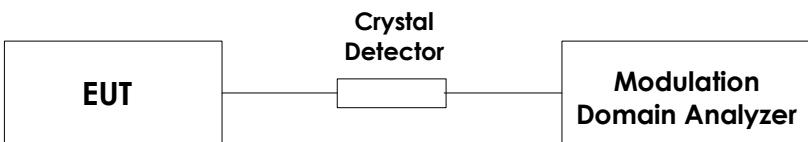

Test equipment included: 5, 7, 9, 28

Test Set-up 2

This setup is used for measuring Frame repetition stability, Frame period and Jitter.

5.3 Conducted Emission Test

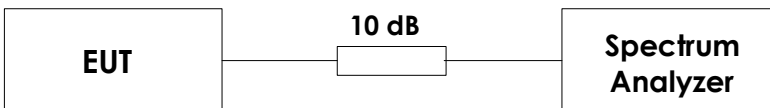

Test equipment included: 1, 2, 9, 26

Test Set-up 3

This setup is used for all conducted emission tests.

5.4 Power Line Conducted Emissions Test

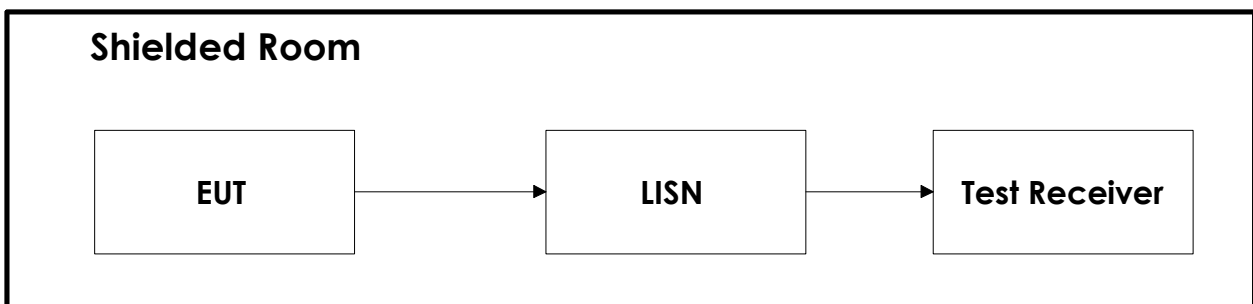

Test equipment: 8, 17, 18, 22, 27

Test Set-Up 5

5.5 Monitoring Tests

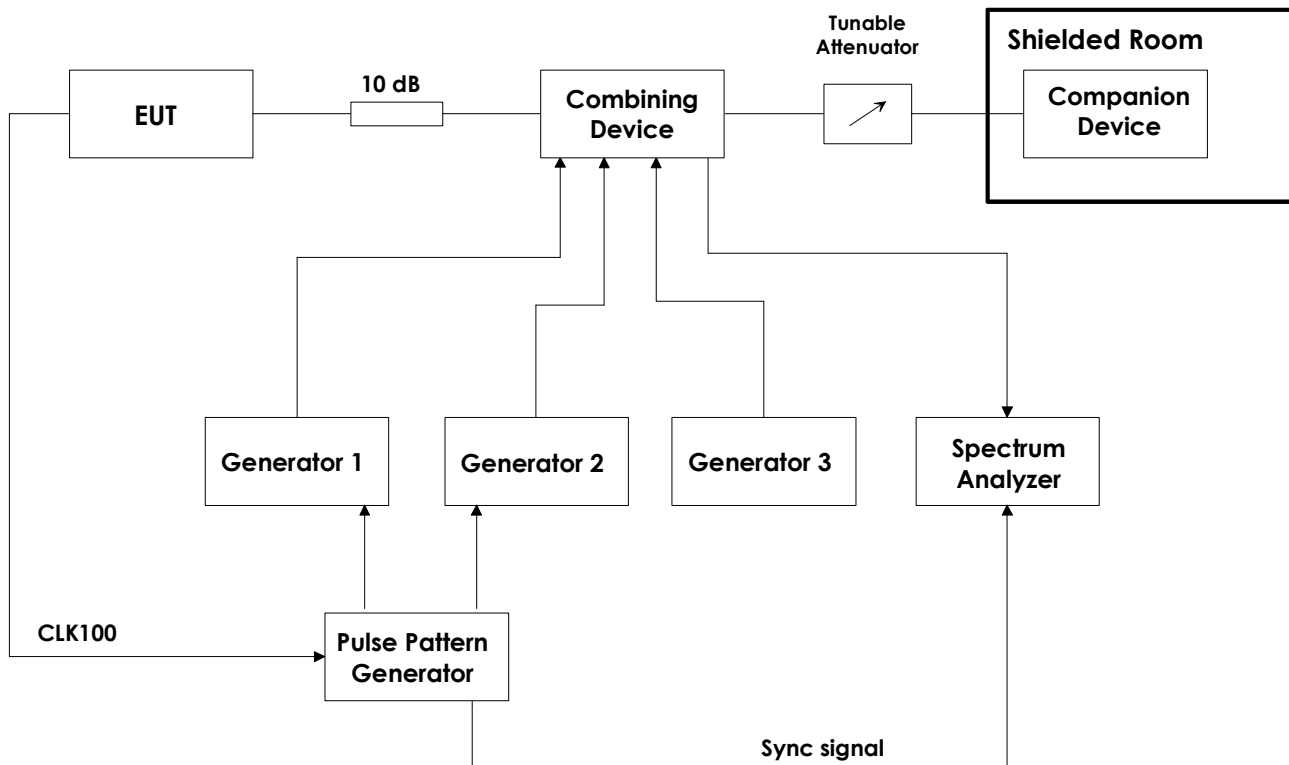

Test equipment: 1, 2, 3, 4, 6, 9, 10, 11, 12, 13, 14, 15, 19, 23, 24, 25, 26

Test Set-Up 6

This test setup is used for all Monitoring and Time and Spectrum Access Procedure tests. The path loss from the signal generators to the EUT is measured with a power meter before the testing is started.

The CLK100 is used to synchronize the Pulse-/ Pattern generator to the start of the DECT frame, this signal always comes from the base station. If the EUT is a DECT Portable Part (i.e. a handset) the CLK100 signal will come from the Companion Device.

The sync signal to the Spectrum Analyzer is the CLK100 signal that is regenerated in the Pulse-/ Pattern Generator, this is used to synchronize the Spectrum Analyzer to the DECT frame when in zero span. The Pulse-/ Pattern Generator is used for tests that require time synchronized pulses or blocking of specific time slots.

6 Test Equipment Used

To facilitate inclusion on each page of the test equipment used for related tests, each item of test equipment and ancillaries are identified (numbered) by the Testhouse.

No.	Model number	Description	Manufacturer	Ref. no.	Cal. date	Cal. Due
1	FSW26	Spectrum Analyzer	Rohde & Schwarz	LR 1640	2014.09.22	2015.09.22
2	SME03	Signal generator	Rohde & Schwarz	LR 1238	2013.03.19	2015.03.19
3	SMIQ03B	Signal generator	Rohde & Schwarz	LR 1516	Cal b4 use	
4	SMHU52	Signal generator	Rohde & Schwarz	LR 1240	Cal b4 use	
5	53310A	Modulation Domain Analyzer	Hewlett Packard	LR 1483	2013.08.14	2015.08.14
6	81104A	Pulse-/ Pattern Generator	Agilent	LR 1502	2013.03.19	2015.03.19
7	8470B	Crystal Detector	Hewlett Packard	LR 1207	N/A	
8	ESHS10	Measuring Receiver	Rohde & Schwarz	N- 3528	2014.09.15	2015.09.15
9	4768-10	Attenuator	Narda	LR 1648	Cal b4 use	
10	745-69	Step Attenuator	Narda	LR 1442	N/A	
11	WE 1506A	Power Splitter	Weinchel	LR 244	Cal b4 use	
12	WE 1506A	Power Splitter	Weinchel	LR 245	Cal b4 use	
13	H-9	Hybrid	Anzac	LR 086	Cal b4 use	
14	H-9	Hybrid	Anzac	LR 085	Cal b4 use	
15	S212DS	RF Switch	Narda	LR 1244	N/A	
16	ESH3-Z5	Two Line V-Network	Rohde & Schwarz	LR 1076	Cal b4 use	
17	ESH3-Z2	Pulse Limiter	Rohde & Schwarz	N- 3932	Cal b4 use	
18	6812B	AC Power Source	Agilent	LR 1515	2013.10.28	2015.10.28
19	Model 87 V	Multimeter	Fluke	N-4669	2014.09.17	2015.09
20	87H35-1	Circulator	Racal-MESL	s.no.: 140	N/A	
21	87H35-1	Circulator	Racal-MESL	s.no.: 141	N/A	
22	87H35-1	Circulator	Racal-MESL	s.no.: 142	N/A	
23	NRV-Z81	Peak Power Sensor	Rohde & Schwarz	LR 1644	2013.04.05	2015.04.05