

SCALE	DESIGNED	TRACED	CHECKED	APPROVED	MODEL	NAME
	T. KANASHIMA	T. KANASHIMA	SHIM	SHIM	PSLP12182A	HCM130
					PSUP13912A	

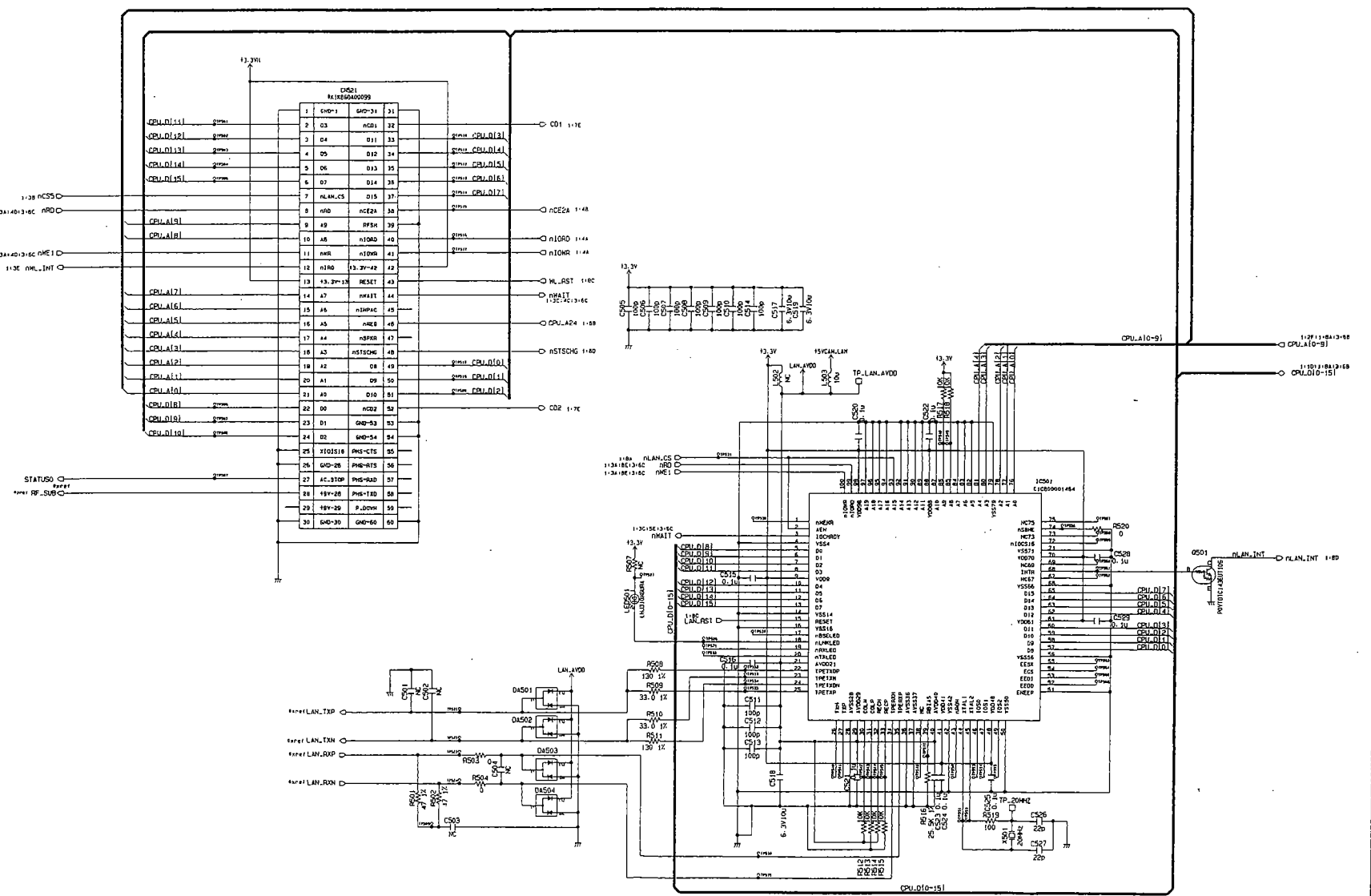

HCM130

Model	PSLP12182A
Part No	PSUP13912A
Designer	T.KAWASHIMA
Tracer	T.KAWASHIMA
Checked	#NAME
Approved	#NAME

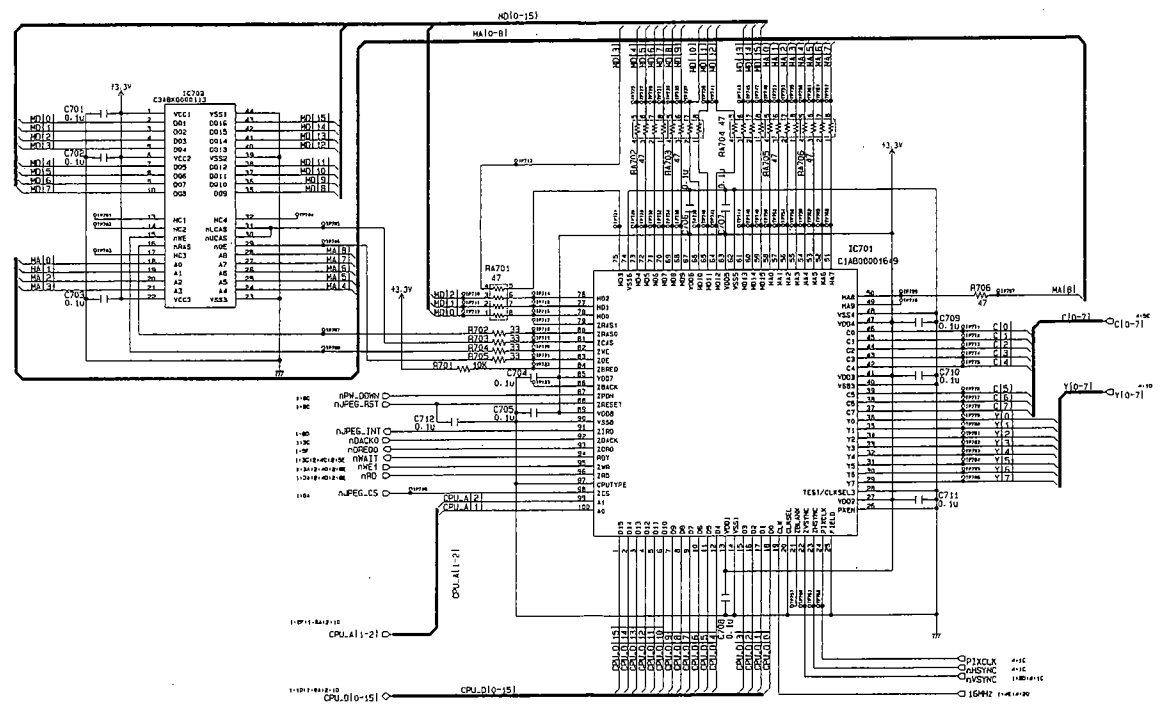

HCM130

Model	PSLP121BZA			
Scale	Designed	Traced	Checked	Approved
	T.KAMASHIMA	T.KAMASHIMA	ONAME	ONAME
Part No	PSUP1391ZA			
Name	I/O BLOCK			

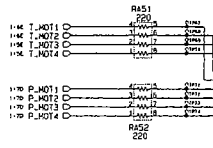
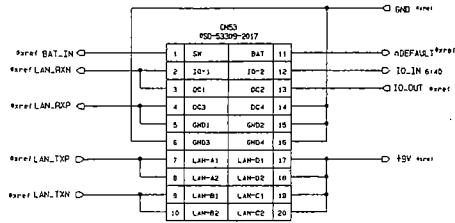
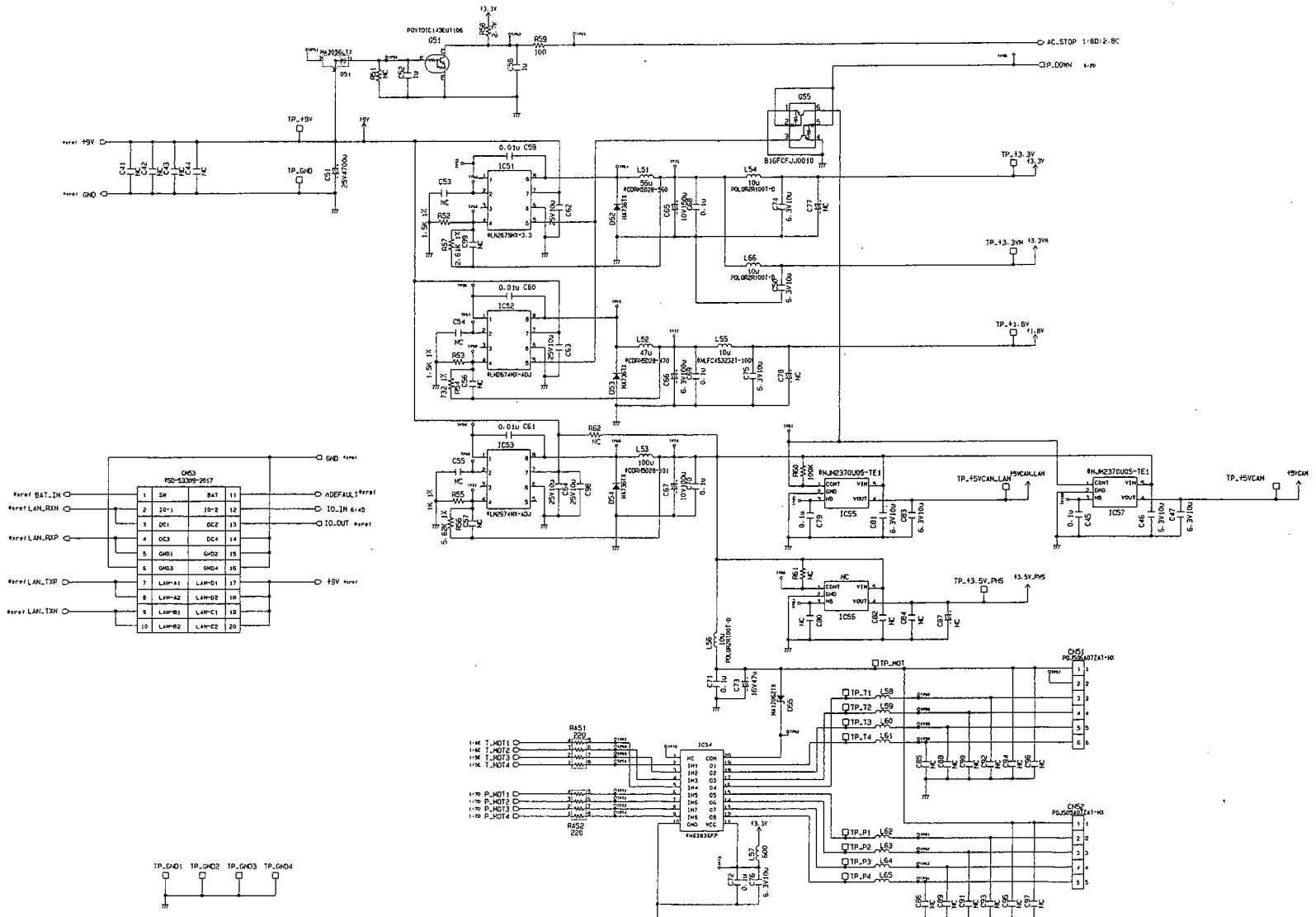

Scale	Designer	Tracer	Checked	Approved	Part No.	Name
	T.KIHARA	T.KIHARA	RNAME	RNAME	PSLP1391ZA	PSLP1391ZA

W001
PSLP1391ZA
HCM130

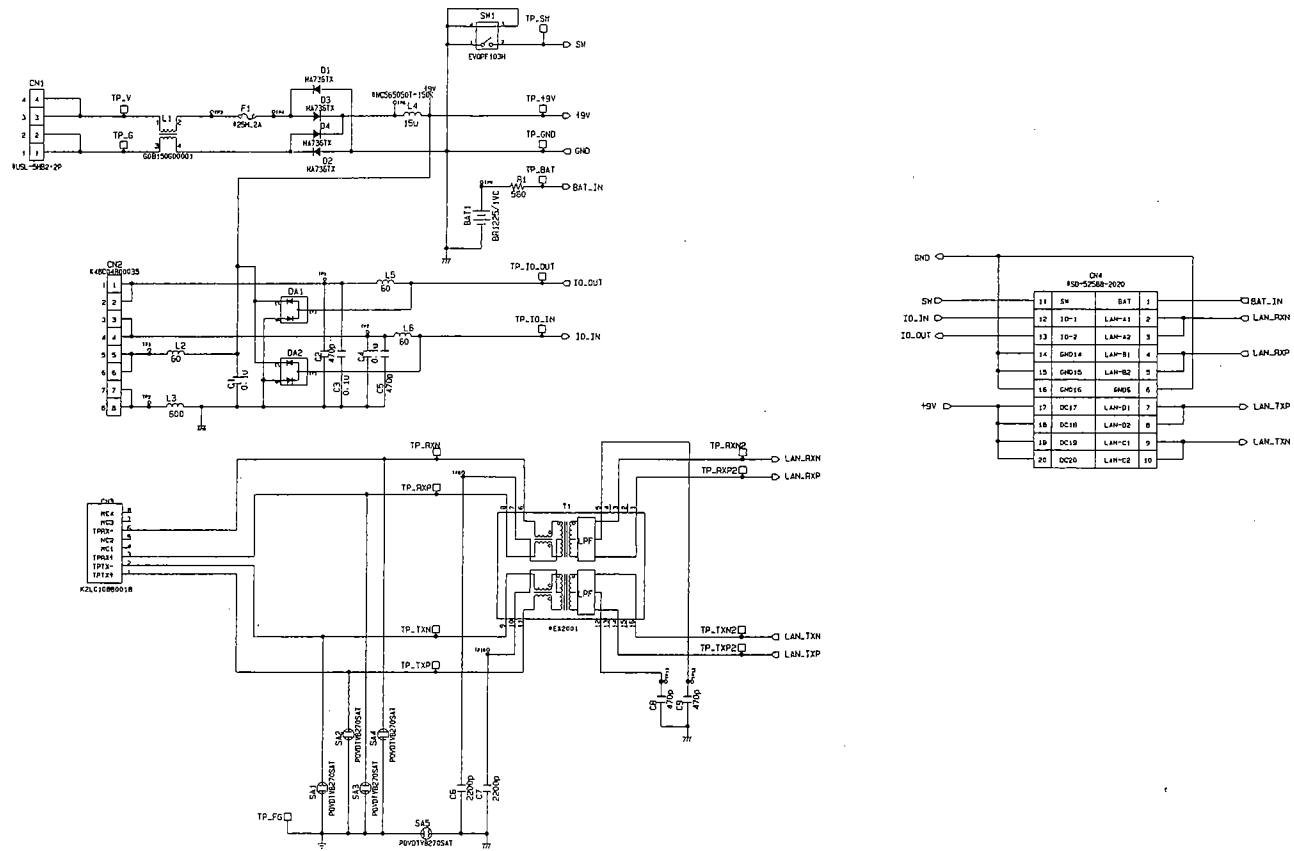

W003
PCB
PSUP1392ZA

Model	PSLP1219ZA			
Part No	PSUP1392ZA			
Name	CONNECTOR BLOCK			
Scale	Designed	Traced	Checked	Approved
	T.KAWASHIMA	T.KAWASHIMA	RNAME	RNAME

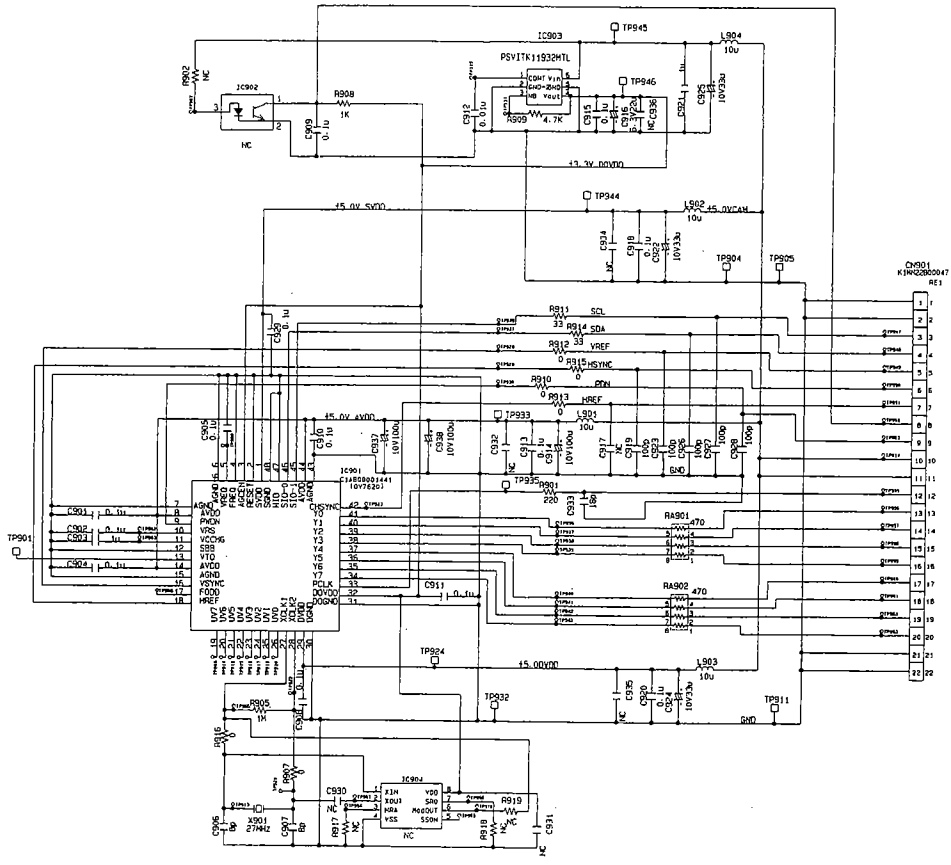

W002
PCB
PSUP1360ZA

Scale	Designed	Traced	Checked	Approved	Model	Part No.
	K. Kikuchi	K. Kikuchi	T. Yoshizaki	S. Koetsu	PSLP1221ZA	PSUP1360ZA

REV	NO	DATE	BY
1	1		

