

MP3 CD Player/Weather Band Receiver

PP P/N **PP105106**

Operating Instructions



WMA

MP3



- Please read these instructions carefully before using this product and keep this manual for future reference.

Safety Information

- Read the operating instructions for the unit and all other components of your truck audio system carefully before using the system. They contain instructions about how to use the system in a safe and effective manner. We assume no responsibility for any problems resulting from failure to observe the instructions given in this manual.



Warning

This pictograph intends to alert you to the presence of important operating instructions and installation instructions. Failure to heed the instructions may result in severe injury or death.



Caution

This pictograph intends to alert you to the presence of important operating instructions and installation instructions. Failure to heed the instructions may result in injury or material damage.



Warning

Observe the following warnings when using this unit.

- ❑ **The driver should not operate the system while driving.**

Watching the display or operating the system will distract the driver from looking ahead of the vehicle and can cause accidents.

Always stop the vehicle in a safe location and use the parking brake before watching the display or operating the system.

- ❑ **Use the proper power supply.**

This product is designed for operation with a negative grounded 12 V DC battery system. Never operate this product with other battery systems, especially a 24 V DC battery system.

- ❑ **Protect the Deck Mechanism.**

Do not insert any foreign objects into the slot of this unit.

- ❑ **Do not disassemble or modify the unit.**

Do not disassemble, modify the unit or attempt to repair the product yourself. If the product needs to be repaired, consult your dealership.

- ❑ **Do not use the unit when it is out of order.**

If the unit is out of order (no power, no sound) or in an abnormal state (has foreign objects in it, is exposed to water, is smoking, or smells), turn it off immediately and consult your dealership.

- ❑ **Any NOAA broadcast weather report, including current and forecasts, may not reflect your actual weather conditions at your exact time and location. You should always pay attention to your actual weather conditions to make safe decisions accordingly.**

- ❑ **Keep accessories out of reach of infants.**

Accessories can be ingested, so keep them out of the reach of infants. If an infant ingests accessories, please seek immediate medical attention.

Observe the following warnings when installing.

- ❑ **Disconnect the lead from the negative (–) battery terminal before installation.**

Wiring and installation with the negative (–) battery terminal connected may cause electrical shock and injury due to a short circuit.

Some cars equipped with the electrical safety system have specific procedures of battery terminal disconnection.

FAILURE TO FOLLOW THE PROCEDURE MAY LEAD TO THE UNINTENDED ACTIVATION OF THE ELECTRICAL SAFETY SYSTEM RESULTING IN DAMAGE TO THE VEHICLE AND PERSONAL INJURY OR DEATH.

- ❑ **Never use safety-related components for installation, grounding, and other such functions.**

Do not use safety-related vehicle components (fuel tank, brake, suspension, steering wheel, pedals, airbag, etc.) for wiring or fixing the product or its accessories.

- ❑ **Check for piping, gasoline tank, electric wiring, and other items before installing the product.**

If you need to open a hole in the vehicle chassis to attach or wire the product, first check where the wire harness, gasoline tank, and electric wiring are located. Then open the hole from outside if possible.

- ❑ **Never install the product in a location where it interferes with your field of vision.**

- ❑ **Never have the power cord branched to supply other equipment with power.**

- ❑ **After installation and wiring, you should check the normal operation of other electrical equipment.**

The continuation of their using in abnormal conditions may cause fire, electrical shock or a traffic accident.

- ❑ **Make sure the leads do not interfere with driving or getting in and out of the vehicle.**

- ❑ **Insulate all exposed wires to prevent short circuiting.**



Caution

Observe the following cautions when using this unit.

- ❑ **Keep the sound volume at an appropriate level.**
Keep the volume level low enough to be aware of road and traffic conditions while driving.
- ❑ **Do not insert or allow your hand or fingers to be caught in the unit.**
To prevent injury, do not get your hand or fingers caught in moving parts or in the disc slot. Especially watch out for infants.
- ❑ **This unit is designed for use exclusively in trucks.**
- ❑ **Do not operate the unit for a prolonged period with the engine turned off.**
Operating the audio system for a long period of time with the engine turned off will drain the battery.
- ❑ **Do not expose the unit to direct sunlight or excessive heat.**
Otherwise these will raise the interior temperature of the unit, and it may lead to smoke, fire, or other damage to the unit.
- ❑ **Do not use the product where it will be exposed to water, moisture, or dust.**
Exposure of the unit to water, moisture, or dust may lead to smoke, fire, or other damage to the unit. Make especially sure that the unit does not get wet in truck washes or on rainy days.
- ❑ **To ensure safety, never attempt to preset stations while you are driving.**
- ❑ **Depending upon the transmission condition of electro-magnetic waves, the geographical reasons and/or the weather conditions, you may not receive the NOAA radio partially or at all.**
- ❑ **Make sure that your weather radio can receive properly before driving, especially, before use in a critical condition.**
- ❑ **Set the volume level to low enough before the AUX connection is completed.**
Failure to observe this, the loud noise may come out and damage your speakers and your hearing. Direct connection of the speaker/headphone output of an external device without any attenuator may distort sound or damage the connected external device.
- ❑ **When using this unit, noise may occur when there is an electromagnetic-wave generator such as a cellular phone near this unit, if that noise is obvious and cannot be eliminated, please keep an electromagnetic-wave generator such as a cellular phone away from this unit.**

Observe the following cautions when installing.

- ❑ **Refer wiring and installation to qualified service personnel.**
Installation of this unit requires special skills and experience. For maximum safety, have it installed by the dealership. We are not liable for any problems resulting from your own installation of the unit.
- ❑ **Follow the instruction to install and wire the product.**
Not following the instructions to properly install and wire the product could cause an accident or fire.
- ❑ **Take care not to damage the leads.**
When wiring, take care not to damage the leads. Prevent them from getting caught in the vehicle chassis, screws, and moving parts such as seat rails. Do not scratch, pull, bend or twist the leads. Do not run them near heat sources or place heavy objects on them. If leads must be run over sharp metal edges, protect the leads by winding them with vinyl tape or similar protection.
- ❑ **Use the designated parts and tools for installation.**
Use the supplied or designated parts and appropriate tools to install the product. The use of parts other than those supplied or designated may result in internal damage to the unit. Faulty installation may lead to an accident, a malfunction or fire.
- ❑ **Do not block the air vent or the cooling plate of the unit.**
Blocking these parts will cause the interior of the unit to overheat and will result in fire or other damage.
- ❑ **Do not install the product where it is exposed to strong vibrations or is unstable.**
Avoid slanted or strongly curved surfaces for installation. If the installation is not stable, the unit may fall down while driving and this can lead to an accident or injury.
- ❑ **Installation Angle**
The product should be installed in a horizontal position with the front end up at a convenient angle, but not more than 30°. The user should bear in mind that in some areas there may be restrictions on how and where this unit must be installed. Consult your dealer for further details.
- ❑ **Wear gloves for safety. Make sure that wiring is completed before installation.**
- ❑ **To prevent damage to the unit, do not connect the power connector until the whole wiring is completed.**
- ❑ **Do not connect more than one speaker to one set of speaker leads. (except for connecting to a tweeter)**

Safety Information (continued)



Caution

Observe the following cautions when using iPod® device/iPhone® model or USB device.

- Do not connect a USB device directly to this unit. If the USB device is connected directly to this unit and an accident occurs, or if the brakes are applied suddenly, the driver or passenger may bump into the USB device and may get injured.

- Position the iPod device/iPhone model/USB device and USB extension cable so that they do not obstruct your driving.
- Do not connect any device other than iPod device/iPhone model/USB memory or a USB audio player. Do not connect multiple USB devices to the USB connector. Drawing power for multiple USB devices from the connector could cause overheating and smoking.



Caution

PLEASE FOLLOW THE LAWS AND REGULATIONS OF YOUR STATE, PROVINCE OR COUNTRY FOR WIRING, INSTALLATION, AND USE OF THIS UNIT AND THE DEVICES TO BE CONNECTED.



Caution

**THIS PRODUCT IS A CLASS I LASER PRODUCT.
USE OF CONTROLS OR ADJUSTMENTS OR PERFORMANCE OF PROCEDURES OTHER THAN THOSE SPECIFIED HEREIN MAY RESULT IN HAZARDOUS RADIATION EXPOSURE.
DO NOT OPEN COVERS AND DO NOT REPAIR BY YOURSELF. REFER SERVICING TO QUALIFIED PERSONNEL.**

The following applies only in the U.S.A.

Part 15 of the FCC Rules

FCC Warning:

This device complies with Part 15 of the FCC Rules for Radio Receiver. Operation is subject to the condition that this device may not cause harmful interference. Any unauthorized changes or modifications to this equipment may void the user's authority to operate this device.

IMPORTANT NOTE:

To comply with the FCC RF exposure compliance requirements, no change to the antenna or the device is permitted. Any change to the antenna or the device could result in the device exceeding the RF exposure requirements and void user's authority to operate the device.

This equipment complies with FCC radiation exposure limits set forth for uncontrolled equipment and meets the FCC radio frequency (RF) Exposure Guidelines in Supplement C to OET65. This equipment has very low levels of RF energy that it deemed to comply without maximum permissive exposure evaluation (MPE). But it is desirable that it should be installed and operated with at least 20 cm and more between the radiator and person's body (excluding extremities: hands, wrists, feet and legs).

NOTICE

This equipment has been tested and found to comply with the limits for a Class B digital device, pursuant to part 15 of the FCC Rules. These limits are designed to provide reasonable protection against harmful interference in a residential installation. This equipment generates, uses and can radiate radio frequency energy and, if not installed and used in accordance with the instructions, may cause harmful interference to radio communications. However, there is no guarantee that interference will not occur in a particular installation. If this equipment does cause harmful interference to radio or television reception, which can be determined by turning the equipment off and on, the user is encouraged to try to correct the interference by one or more of the following measures:

- Reorient or relocate the receiving antenna
- Increase the separation between the equipment and receiver.
- Connect the equipment into an outlet on a circuit different from that to which the receiver is connected.
- Consult the dealer or an experienced radio/ TV technician for help.

This transmitter must not be co-located or operated in conjunction with any other antenna or transmitter.

Contents

Safety Information	2	Bluetooth® - General	28
Contents	6	Registration of a Bluetooth® device to this unit	
Features	8	Display change	
Front AUX terminal (AUX1)		Setting of PIN (Personal Identity Number) code	
Rear AUX terminal (AUX2)		Connection of the registered Bluetooth® device to this unit	
Sound control		Disconnection of the Bluetooth® device	
CAN-readiness		Deletion of the registered data	
Fault detection of external amplifier		Bluetooth® - Hands-Free Phone ..	30
Non-volatile memory		Phone answering	
Illumination Interlock Control		Phone hanging up	
30 days clock memory		Switching between the private mode* and hands-free mode	
Bluetooth®		Incoming call rejection	
USB connector		Outgoing call termination	
Connectable devices	9	Setting of automatic answering function	
Compatible USB devices		Use of voice dial	
Controls Layout	10	Use of receiving/calling records or telephone directory (phonebook)	
Preparation	11	Bluetooth® - Music Player	32
First time power on		Music mode activation	
Clock Display Setting		Song selection	
Clock adjustment		Pause	
General	12	Notes on Bluetooth®	33
Power On/Off		Frequency band used	
Source Selection		Usage limitations	
Volume Adjustment		Influence from other devices	
Indication at connecting external amplifier		Application limitations	
Sound Controls	14	Alarm Setting	34
Audio modes (Bass/Treble/Balance/Fader/SQ)		Alarm time setting	
Radio	16	Turning ON/OFF the alarm	
Operation Flow		Activating snooze	
Display Change		Troubleshooting	36
Station Preset		If you suspect something wrong	
Manual preset memory		Common	
Tuning in a weather band station		Radio	
Disc Player	18	CD	
Operation Flow		MP3/WMA	
Disc Eject		USB (MP3/WMA)	
Display change		Bluetooth®	
Random, Scan, Repeat Play		Product servicing	
USB (MP3/WMA)	21	Error Display Messages	41
Notes for USB device		Disc Player	
Compatible USB devices		USB (MP3/WMA)	
Operation Flow		For use with iPod	
Display change		Bluetooth®	
Random, Scan, Repeat Play			
For use with iPod	24		
Operation Flow			
Display change			
Setting the iPod Control			
Repeat, Shuffle Play			

Notes on Discs 43

- How to hold the disc
- Unusable discs
- Disc insert
- Disc cleaning
- Notes on CD-Rs/RWs

Notes on MP3/WMA 44

- Cautions as to compressed audio files
- Cautions as to the display of this unit
- Recording MP3/WMA Files on a CD-Media/
USB-Device
- Copyright
- No warranty

Maintenance 46

- Cleaning this unit

Specifications 47

- General
- FM Stereo Radio
- AM Radio
- Weather Band Radio
- CD Player
- Bluetooth®

**Specification from the Terminal End
(Rear Connector of This Unit) 48**

Features

Front AUX terminal (AUX1)

Your mobile audio player and other devices are connectable to this unit without any difficulty.

Rear AUX terminal (AUX2)

For more convenient connection, rear AUX terminals are now provided on the unit itself.

Sound control

SQ (Sound Quality)

You have four preset modes (FLAT, ROCK, POP and VOCAL).

CAN-readiness

This unit is a CAN (Controller Area Network)-ready device that provides communication with a steering wheel remote control and other CAN-ready units.

Fault detection of external amplifier

When an anomaly of the connected external amplifier is detected, "AMP FAULT" text appears (the sound will be mute) and the power of this unit turned off after 6 seconds to remind taking inspection with the external amplifier.

Non-volatile memory

This unit stores the memories of each setting (tuner, audio, mode, alarm time settings even if the power supply is shut off or the power cable is unplugged).

Illumination Interlock Control

The intensity/illumination of display and button on this unit is controlled by a PWM dimming module located in the vehicle.

This unit is connected in the vehicle to dimming analog signal (PWM signal). It's capable of dimming the backlighting based on a voltage supplied by a PWM dimming module.

30 days clock memory

This unit stores the memory of clock time for 30 days even if the power supply is shut off or the power cable is unplugged.

Bluetooth®

This feature allows users to use a hands-free phone and Bluetooth® audio systems.

Compatible Bluetooth® devices

- Bluetooth® Version: 2.1+EDR
- HFP1.5 (Hands-Free Profile)
- OPP (Object Push Profile)
- A2DP (Advanced Audio Distribution Profile) v 1.2
- AVRCP1.0 (Audio/Video Remote Control Profile)
- HSP v 1.1 (Headset Profile)

USB connector

The USB connector is equipped on the front panel. By connecting a USB memory (not included) to the USB connector via a USB extension cable (USB 2.0, not included), you can enjoy MP3/WMA files stored on the USB memory (not included) in your vehicle. By connecting for iPod devices/iPhone models to USB connector via a USB extension cable for iPod devices and iPhone models (USB 2.0, not included), you can enjoy music files stored on the compatible with iPod devices and iPhone models in your vehicle. Further information about the compatible with iPod devices and iPhone models is described below.

*iPhone, iPod, iPod classic, iPod nano, iPod shuffle, and iPod touch are trademarks of Apple Inc., registered in the U.S. and other countries.

"Made for iPod" and "Made for iPhone" mean that an electronic accessory has been designed to connect specifically to iPod or iPhone, respectively, and has been certified by the developer to meet Apple performance standards. Apple is not responsible for the operation of this device or its compliance with safety and regulatory standards. Please note that the use of this accessory with iPod or iPhone may affect wireless performance.

Connectable devices

Compatible USB devices

● USB Mass Storage Class

For details as to whether your USB memory/USB Audio is compatible with USB Mass Storage Class, please contact the USB memory/USB Audio manufacturer.



Caution

We do not guarantee all of the USB devices (USB memory/USB audio player) on market are compatible and playable with this unit, some exceptional USB devices may have operation problem when connected to this unit. If such problem occurs, please check and contact the USB device manufacturer for its compatible information.

- **USB Standard Compatibility 1.1/2.0 Full Speed**
- **File System FAT12/16/32**
- **Maximum current less than 1 A**
- **Recommended capacity/partition:
Less than 32 GB/Only supported for 1 partition.**

iPod compatibility

This unit supports only the following iPod models. Supported iPod models are shown below. Older models can not be supported.

Made for.

- iPod touch (4th generation)
- iPod touch (3rd generation)
- iPod touch (2nd generation)
- iPod touch (1st generation)
- iPod classic (160 GB only)
- iPod classic (120 GB only)
- iPod classic
- iPod nano (6th generation)
- iPod nano (5th generation)
- iPod nano (4th generation)
- iPod nano (3rd generation)

Made for.

- iPhone 4S
- iPhone 4
- iPhone 3GS
- iPhone 3G
- iPhone

* Operation check has been completed with software available at the end of December, 2013. We do not guarantee the operation with our future products or upgraded software.



Caution

Correct function of iPhone 5, iPod touch (5th generation) and iPod nano (7th generation) can not be guaranteed when connected to this unit.

Controls Layout

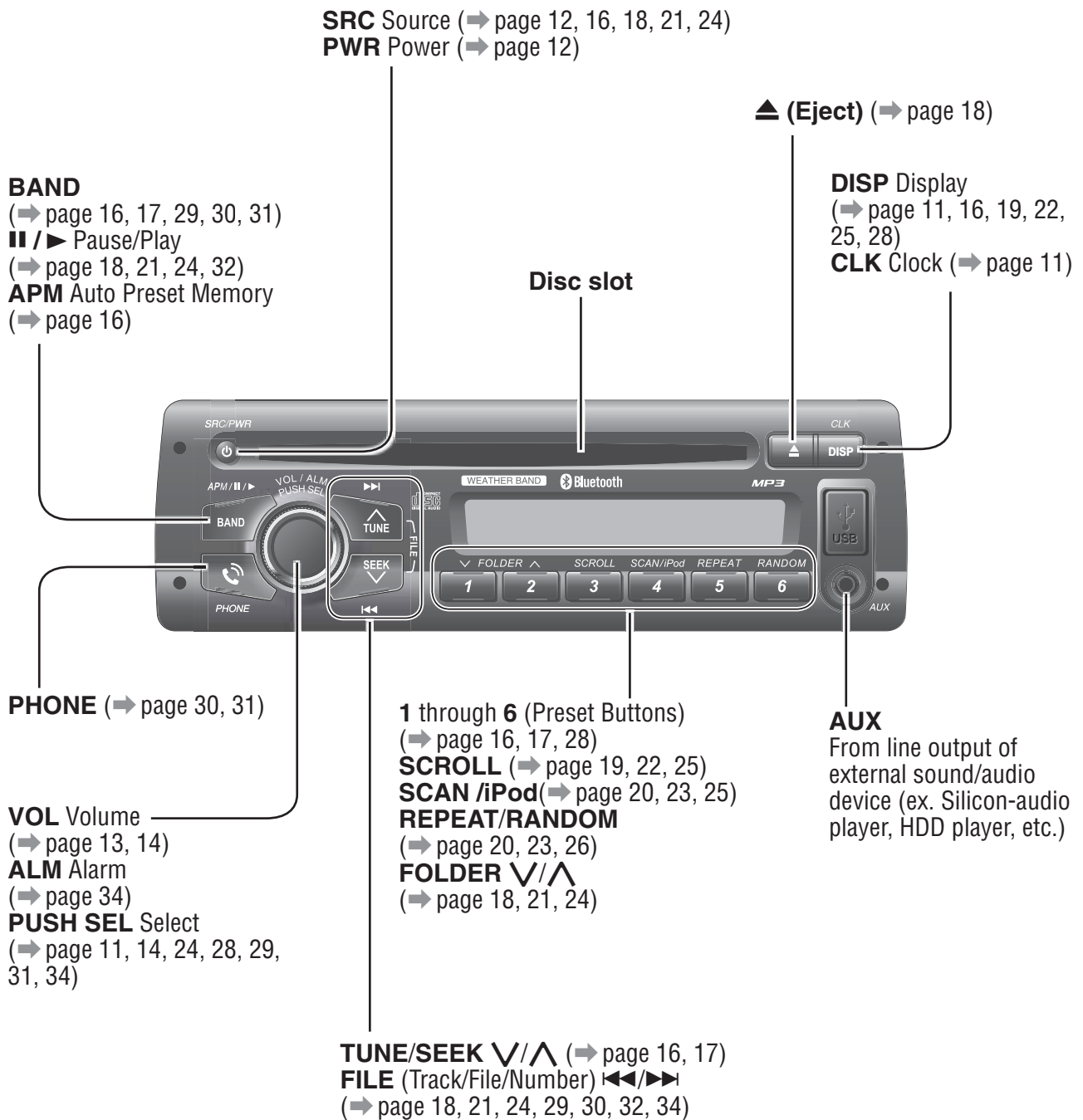

Preparation

First time power on

- 1 Turn the key in the ignition until the accessory indicator lights.
- 2 Press **[PWR]** (Power).

Clock Display Setting

- 1 Hold down **[DISP](CLK)** for more than 2 seconds to adjust clock setting.



- 2 Press **[SEL]** to open the clock display setting display.

- 3 Press **[▶▶]** or **[◀◀]** to adjust.



the 24-hour system used (default)



the 12-hour system used

- 4 Press **[SEL]** to determine the setting.

Notes:

- If no operation takes place for more than 5 seconds in the clock display setting, the display returns to the regular mode.
- To exit from the clock display setting, press **[DISP]**.

Clock adjustment

*The 12-hour system is used for example.

- 1 Press **[DISP](CLK)**.

The display shows "CLOCK ADJUST" in a large, spaced-out font.

(Clock display)

- 2 Hold down **[DISP](CLK)** for more than 2 seconds.

*Indicator for AM or PM time



Hour blinks

- 3 Adjust the hour.

[▶▶] : Sets ahead.

[◀◀] : Sets back.



Hour entered

- 4 Press **[DISP](CLK)**.



Minute blinks

- 5 Adjust the minute.

[▶▶] : Sets ahead.

[◀◀] : Sets back.



Minute entered

- 6 Press **[DISP](CLK)**.



Completed

Notes:

- Clock time is displayed when the unit is power off.
- "CLOCK ADJUST" is displayed when the clock is not adjusted.
- Hold down **[▶▶]** or **[◀◀]** to change numbers rapidly.
- When you want to readjust the time, repeat steps 2 to 6.

General

[SRC]
selects a source.
[PWR] (Power)
toggles power on/off.

[VOL] (Volume)

AUX Connector (3.5 mm ø stereo)
From line output of external sound/
audio device (ex. Silicon audio
player, HDD player, etc.)



Power On/Off

Set your car's ignition switch to the ACC or ON position.

Power on: Press **[PWR]** (Power).

WELCOME

Power off: Hold down **[PWR]** for more than 1 second.

One-Hour Timer

With the ignition off, pressing the **[PWR]** on this unit will turn on the receiver and activate the receiver's one-hour timer. The receiver will turn off automatically after one hour.

Source Selection

Press **[SRC]** to change the source.

RADIO



Radio
(→ page 16)

CD



Disc player
(→ page 18)

USB



USB (→ page 21)
iPod (→ page 24)

AUX 1

AUX1

When device connected to the front AUX terminal of this unit, the sound of connected audio device can be output from car speakers.



When no external device is connected to rear AUX terminal, "AUX" is displayed, and press **[SRC]** to return to "RADIO"

AUX2

AUX2

When device connected to the rear AUX terminal of this unit, the sound of connected audio device can be output from car speakers.



BLUETOOTH



Bluetooth®
(→ page 28)

(Return to "RADIO")

Notes:

- When an output signal from the rear AUX terminal is detected, this unit automatically changes the source to AUX2. If this unit no longer detects this input signal, the source immediately before AUX2 resumes.
- When an output signal from the rear AUX terminal is detected in the power-off mode of this unit, the power is turned on with the AUX2 source selected. If this unit no longer detects this input signal before manually selecting other sources, the power of this unit is turned off.

Volume Adjustment

(Setting Range: 0 to 40, Default: 18)

Turn **[VOL]** clockwise to increase the volume, and counterclockwise to decrease the volume.

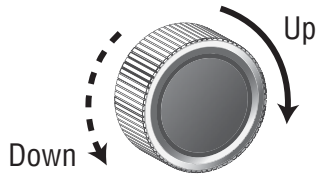

VOLUME 18

Indication at connecting external amplifier

[AMP] lights when an external amplifier is connected.

Note: When an anomaly of the external amplifier is detected, “AMP FAULT” appears (the sound will be mute/ **[AMP]** blinks repeatedly) and the power of this unit is turned off after 6 seconds.

When an external amplifier is connected, the adjustable volume level: 0 to 33 (Maximum).

Sound Controls

[VOL]

selects a value in the audio menu.

(PUSH SEL: Select)
selects items in the audio menu.



Audio modes (Bass/Treble/Balance/Fader/SQ)

1 Push [SEL] (Select) to select the audio mode in sequence.

2 Turn [VOL] (Volume) clockwise or counterclockwise to change each level or select a setting.

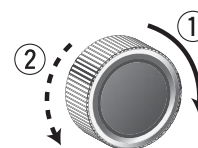

Volume



(Setting Range: 0 to 40, default: 18)



①: Up
②: Down

Bass



(Setting Range: -12 dB to +12 dB by 2 dB, default: 0 dB)



①: Increased
②: Decreased

Treble



(Setting Range: -12 dB to +12 dB by 2 dB, default: 0 dB)



①: Increased
②: Decreased

Balance



(Setting Range: 15 levels each and CENTER, default: CENTER)



①: Right enhanced
②: Left enhanced

Fader



(Setting Range: 15 levels each and CENTER, default: CENTER)



①: Front enhanced
②: Rear enhanced

Note: If no operation takes place for more than 5 seconds in audio mode (2 seconds in volume mode), the display returns to the regular mode.

SQ (Sound Quality)

SQ FLAT



SQ VOCAL

SQ is a function that can call up various sound types at the touch of button in accordance with your listening music type.

(Selectable setting: FLAT/ROCK/POP/VOCAL default: FLAT)

①, ②: Select

(FLAT) flat frequency response:
does not emphasize any part. (default)

(ROCK) speedy and heavy sound:
exaggerates bass and treble.

(POP) wide-ranged and deep sound:
slightly emphasizes bass and treble.

(VOCAL) clear sound:
emphasizes middle tone and slightly emphasizes treble.

Note: Settings of SQ, bass and treble are influenced one another. If such an influence causes distortion to the audio signal, readjust bass/treble or volume.



Caution

To ensure safety, never attempt to preset stations while you are driving.

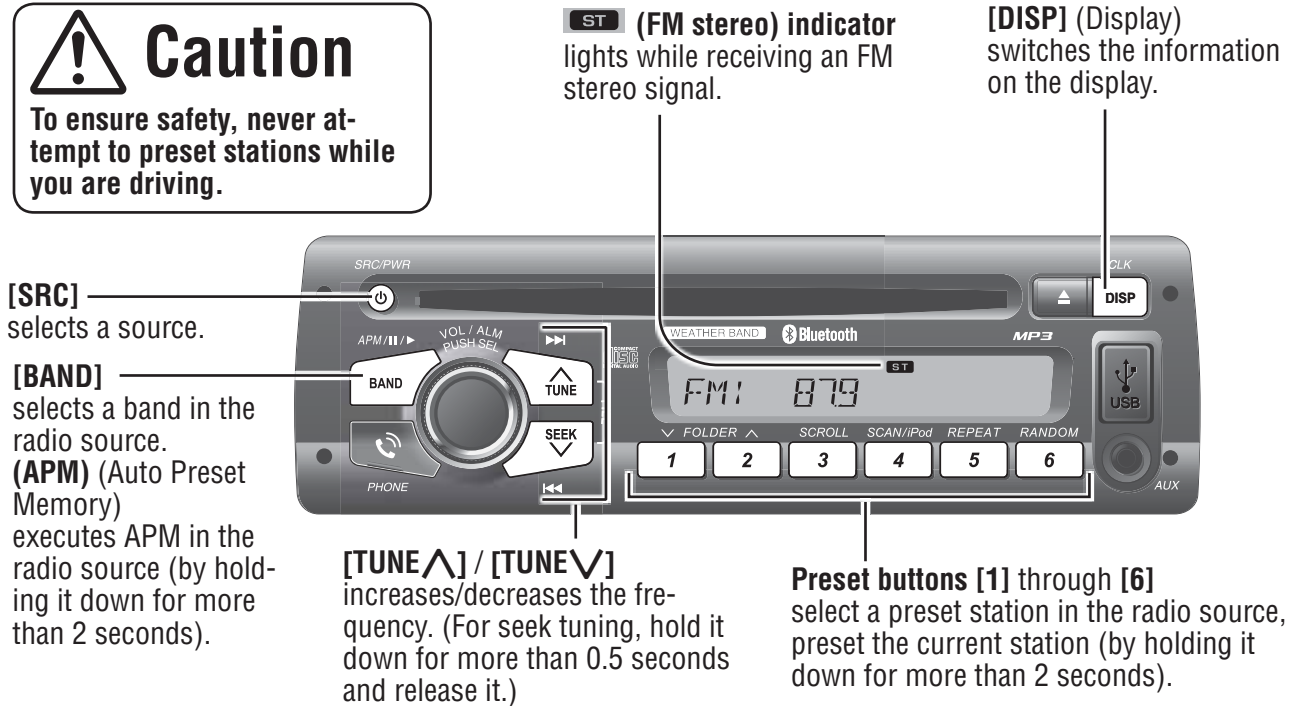

[SRC] selects a source.

[BAND] selects a band in the radio source.
(APM) (Auto Preset Memory) executes APM in the radio source (by holding it down for more than 2 seconds).

[ST] (FM stereo) indicator lights while receiving an FM stereo signal.

[DISP] (Display) switches the information on the display.

[TUNE ^] / [TUNE v] increases/decreases the frequency. (For seek tuning, hold it down for more than 0.5 seconds and release it.)

Preset buttons [1] through [6] select a preset station in the radio source, preset the current station (by holding it down for more than 2 seconds).

Operation Flow

1 Press **[SRC]** to select the radio source.

2 Press **[BAND]** to select a band.

FM1 → FM2

↑ ↓

AM ← WB Weather Band (→ page 17)

3 Select a station.

Frequency Adjustment

[TUNE v]: Lower / **[TUNE ^]**: Higher

Note: For station search, hold down either of the buttons for more than 0.5 seconds and release it.

Preset Station Selection

Press the corresponding preset button from **[1]** through **[6]** to tune in a preset station.

Display Change

Press **[DISP]** to change the display.

FM1 87.9 M4
 ↑↓ Radio mode display (Frequency)

FM1 8:15AM
 Clock display

Station Preset

The 6 stations with good reception will be automatically saved in the memory under preset buttons **[1]** through **[6]**.

Preset stations can be simply called up by pressing **[1]** through **[6]**.

Auto Preset Memory (APM)

With this operation, stations with good receiving conditions can be automatically stored in the preset memory.

1 Select a band.

2 Hold down **[BAND]** (**APM**) for more than 2 seconds.

The preset stations under best receiving conditions are received for 5 seconds each after presetting the stations (SCAN). To stop scanning, press one of the buttons from **[1]** through **[6]**.

Note: New stations overwrite existing saved stations.

Manual preset memory

- 1 Use manual or seek tuning to find a station.
- 2 Press and hold one of the preset buttons [1] through [6] until the display blinks once.



Note: New stations overwrite existing saved stations

Tuning in a weather band station

- 1 Press [BAND] to select WB (Weather Band). (→ page 16)
- 2 Press any of the buttons [1] through [6] to monitor the preset station.

Note: The weather band (CH1-6) has been preset. CH7 is selected by pressing [TUNE^] or [TUNEv].

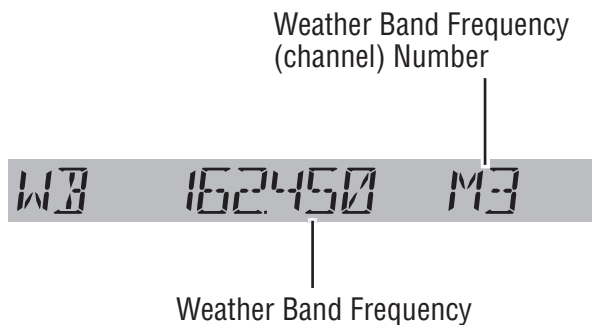

Weather Band Stations

National Weather Radio Broadcasts from over 380 locations throughout the U.S. on seven VHF/FM frequencies.

Tune to weather band to receive continuous weather information 24 hours a day on one of the following frequencies.

1. 162.400 MHz
2. 162.425 MHz
3. 162.450 MHz
4. 162.475 MHz
5. 162.500 MHz
6. 162.525 MHz
7. 162.550 MHz

Note: Further and updated information about the National Weather Radio station listing, please visit the web site:

<http://www.nws.noaa.gov/nwr/nwrbro.htm>

Occasionally the frequency of an existing or planned station must be changed because of unexpected radio frequency interfere with adjacent NOAA weather Radio Stations and/or with other Government or commercial Operations within the area. If you have a question concerning NOAA Weather Radio, please contact your nearest National Weather Service Office.



Warning

Any NOAA broadcast weather report, including current and forecasts, may not reflect your actual weather conditions at your exact time and location. You should always pay attention to your actual weather conditions to make safe decisions accordingly.

Disc Player



Caution

- A disc which has both CD-DA data and MP3/WMA data on it may not be reproduced normally.
- **Do not insert a disc when the DISC indicator lights.**
- Refer to the sections of “Notes on Discs” (→ page 43) and “Notes on MP3/WMA” (→ page 44).
- **This unit does not support 8 cm (3”) discs.**
- Do not insert foreign objects into the disc slot.

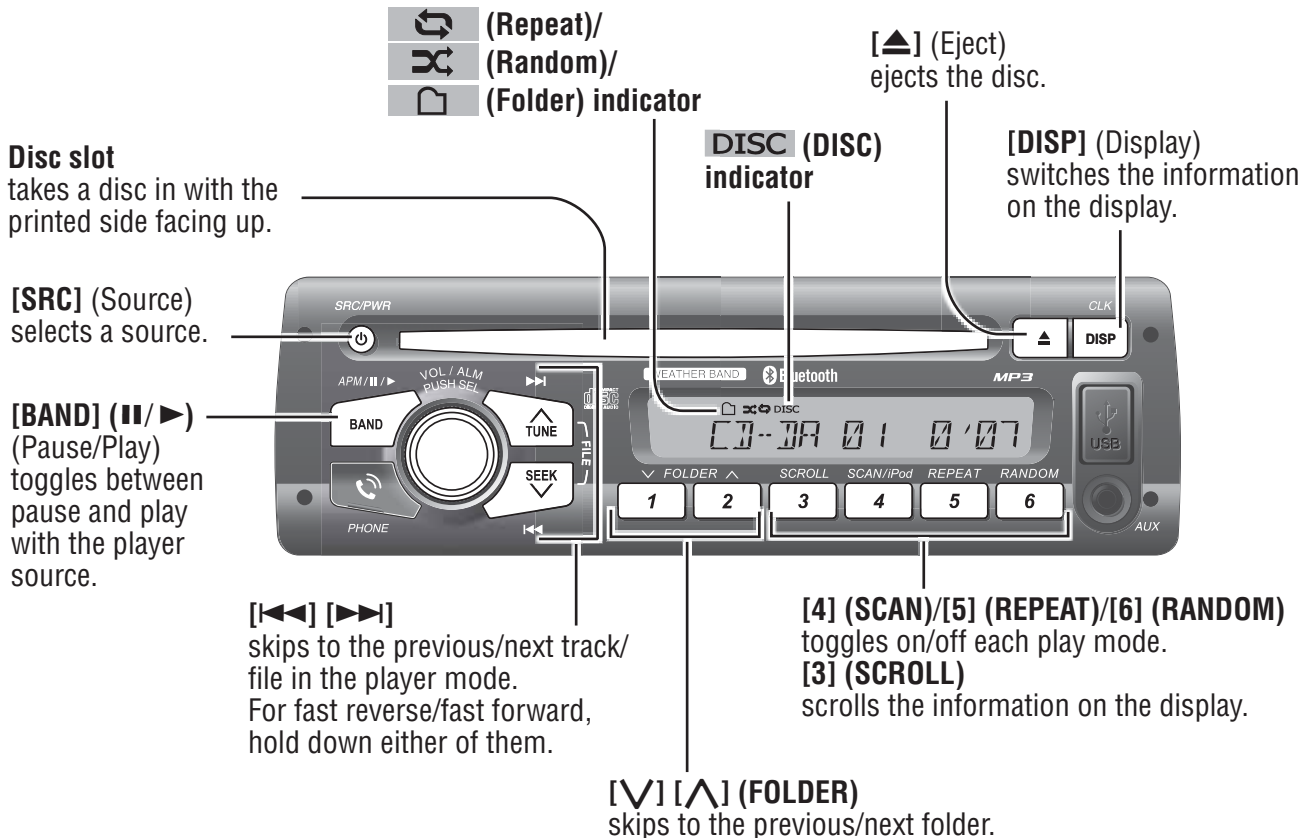

Operation Flow

- 1 Press **[SRC]** to select the Disc Player source.

Notes:

- The unit recognizes the disc and starts playing automatically.
- The power will be turned on automatically when a disc is loaded.

Disc Eject

Press **[▲]** (Eject) to eject the disc.

- 2 Select a desired portion.

Track/File Selection

Press **[◀◀] / [▶▶]**.

Note: To perform fast reverse/forward, hold down either of them.

Disc Player (CD-DA disc):

Previous/next track

Disc Player (MP3/WMA disc):

Previous/next file

Folder Selection (MP3/WMA)

[∧] (FOLDER): Next folder

[∨] (FOLDER): Preceding folder

Pause

Press **[BAND] (II/▶)**.

Press again to cancel.

Display change

Press **[DISP]** to change the display.

Notes:

- For scrolling text, press **[3](SCROLL)**.
- "NO TEXT" is displayed when there is no information on the disc.

CD-DA

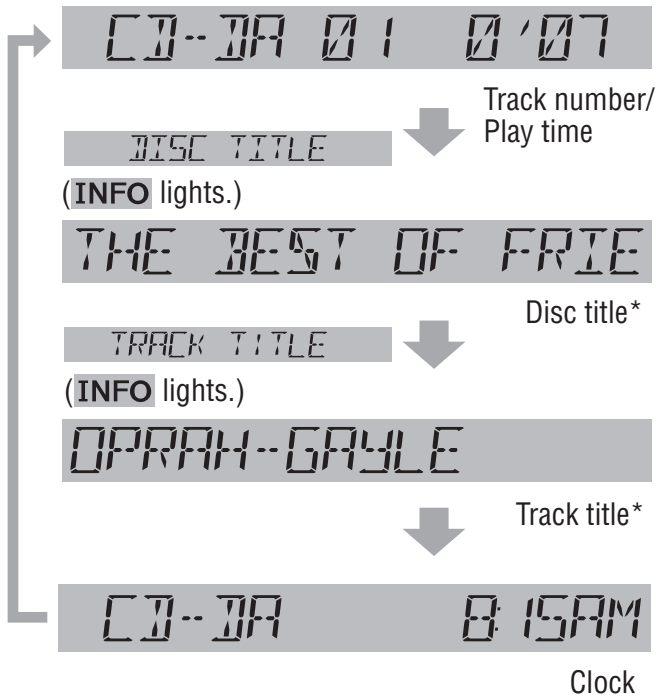

* CD TEXT Display

Disc title and Track title name are displayed.

MP3/WMA

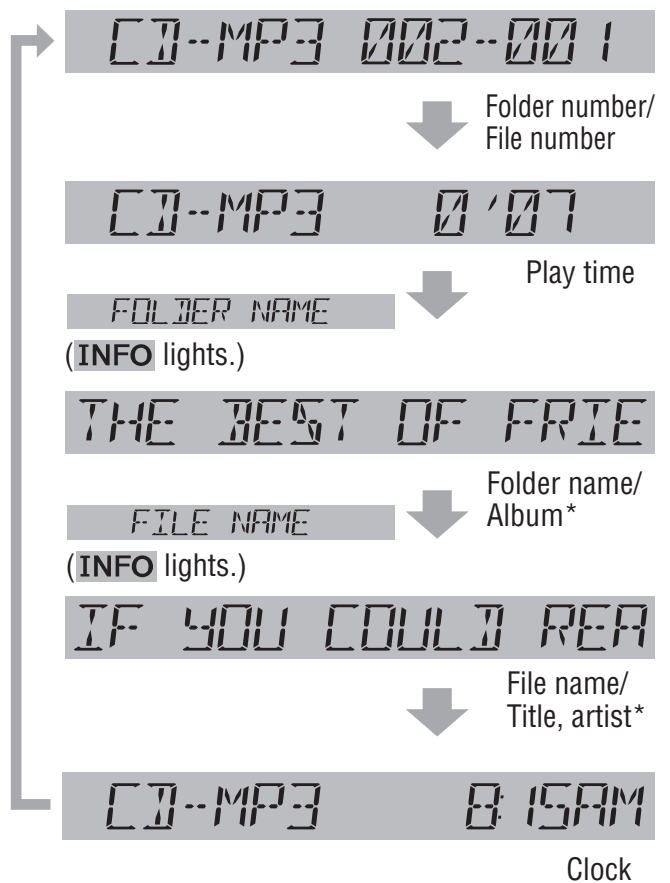

* ID3 Tag ON/OFF

Hold down **[3](SCROLL)** for more than 2 seconds.

TAG ON: album title and song title/artist name are displayed.

TAG OFF: folder name/file name are displayed.
 (Default)

Disc Player (continued)

Random, Scan, Repeat Play

Random Play Setting

Press [6] (RANDOM) to select the random play setting.

SONG RANDOM

Random play

All the available songs (tracks/files) are played in a random sequence. ( lights.)



Press [6] (RANDOM) again to select the folder random play.

FOLDER RANDOM

Folder random play

(only for MP3/WMA)

All the available files in the current folder are played in a random sequence. ( ,  lights.)



Press [6] (RANDOM) again to turn off random play.

RANDOM OFF

Random off

Return to regular play.

Scan Play Setting

Press [4] (SCAN) to select the scan play setting.

SONG SCAN

Scan play

The first 10 seconds of each song (each track/file) is played in sequence.



Press [4] (SCAN) again to select the folder scan play.

FOLDER SCAN

Folder scan play

(only for MP3/WMA)

From the next folder, the first 10 seconds of the first file in each folder is played in sequence.

( lights.)



Press [4] (SCAN) again to turn off scan play.

SCAN OFF

Scan off

Return to regular play.

Repeat Play Setting

Press [5] (REPEAT) to select the repeat play setting.

SONG REPEAT

Repeat play

The current song (track/file) is repeated.

( lights.)



Press [5] (REPEAT) again to select the folder repeat play.

FOLDER REPEAT

Folder repeat play

(only for MP3/WMA)

The current folder is repeated.

( ,  lights.)



Press [5] (REPEAT) again to turn off repeat play.

REPEAT OFF

Repeat off

Return to regular play.

USB (MP3/WMA)

Notes for USB device

- This unit plays back MP3/WMA files stored on a USB memory.
- Back up any important data beforehand. We cannot accept responsibility for any lost data.
- Refer to the section on “Compatible USB devices” (→ below).
- Refer to the section on “Notes on MP3/WMA”.
- Connect your USB device to your car audio using a standard USB extension cable. Use of a 2 m or shorter USB 2.0 cable is recommended.



Caution for USB Device

- Do not connect a USB device directly to this unit. If the USB device is connected directly to this unit and an accident occurs, or if the brakes are applied suddenly, the driver or passenger may bump into the USB device and may get injured.
- Position the USB device and USB extension cable/ optional adaptor so that they do not obstruct your driving.
- Do not connect any USB device other than a USB memory or a USB audio player. Do not connect multiple USB devices to the USB connector. Drawing power for multiple USB devices from the connector could cause overheating and smoking.

Compatible USB devices

- USB Mass Storage Class
This refers to a type of USB device, which when connected to a PC can be used as a storage device without the need for specialized drivers or software.
For details as to whether your USB memory/ USB Audio is compatible with USB Mass Storage Class, please contact the USB memory/USB Audio manufacturer.
- USB Standard Compatibility 1.1/2.0 Full Speed
- File system is FAT12/16/32
- Maximum current less than 1 A
- Recommended capacity/partition:
Less than 32 GB/Only supported for 1 partition.

Notes:

- The use of USB devices that contain data files other than MP3/WMA stored is not recommended.
- Playback or display may not be possible depending on the type of the USB device or the condition of the recording.
- Even if PC playback is possible, it may not be possible on this product, because some USB devices are not compliant with the USB standard.
- Even with a USB device in the Mass Storage Class, playback may not be possible in some cases.

Operation Flow

- 1 Press **[SRC]** to select the USB mode.
- 2 Open the USB connector cover.
- 3 Using a USB extension cable, connect the USB memory to this unit.

Notes:

- When connecting (disconnecting) the USB memory, turn down the volume of the unit.
- When connecting the cables, make sure the connector is pushed all the way into the socket.
- This unit may not operate correctly, depending on USB cable's quality and length. Use of a 2 m or shorter USB 2.0 cable is recommended.

Notes:

- MP3/WMA files recognized by the unit are played back automatically.
- If the USB memory is connected to this unit when the power is turned on, playback starts automatically.

- 4 Select a desired portion.

Folder Selection

[^] (FOLDER): Next folder

[v] (FOLDER): Preceding folder

File Selection

[▶▶]: Next file

[◀◀]: Preceding file (press twice)

Note: For fast forward/reverse, hold down either of them.

Pause

Press **[BAND]** (**||/▶**).

Press again to cancel.

USB (MP3/WMA) (continued)

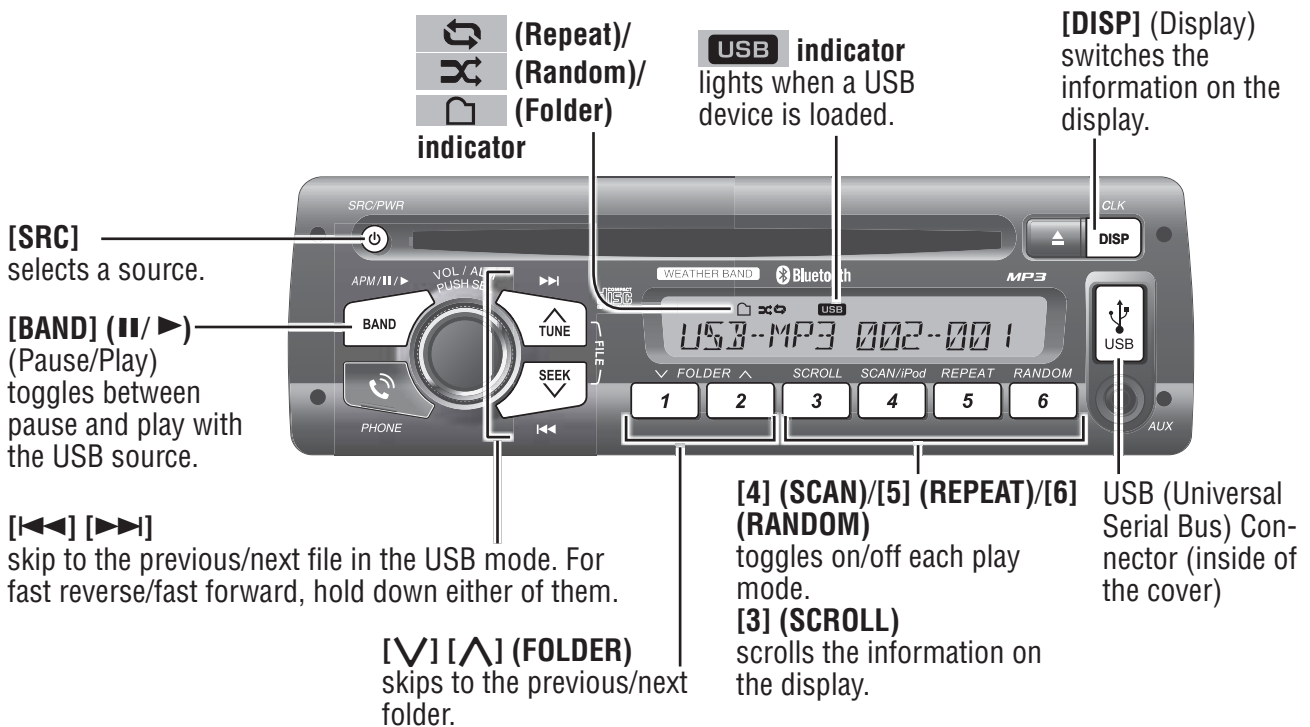

Display change

Press **[DISP]** to change the display.

Notes:

- For scrolling text, press **[3](SCROLL)**.
- "NO TEXT" is displayed when there is no information on the USB.

* ID3 Tag ON/OFF

Hold down **[3](SCROLL)** for more than 2 seconds.

TAG ON: album title and song title/artist name are displayed.

TAG OFF: folder name/file name are displayed. (Default)

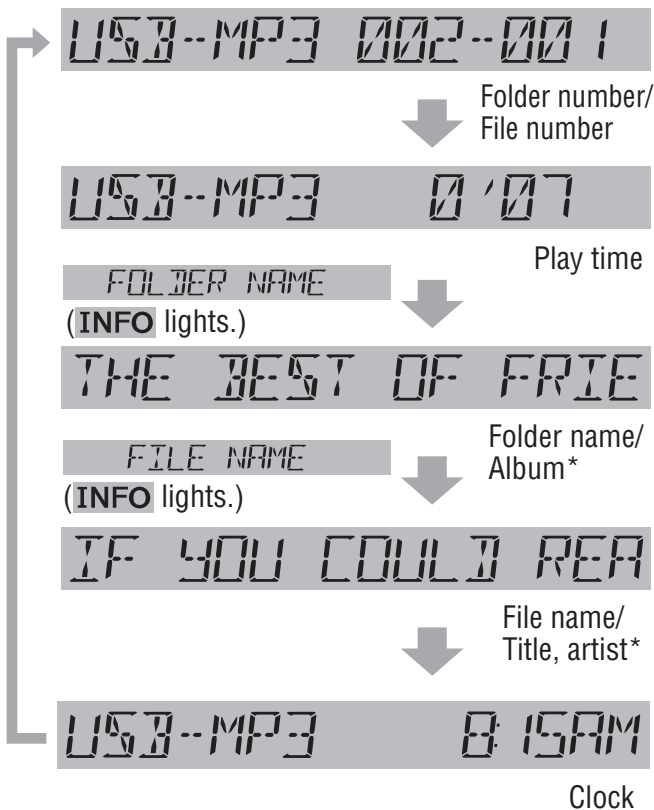

Random, Scan, Repeat Play

Random Play Setting

Press [6] (RANDOM) to select the random play setting.

SONG RANDOM

Random play

All the available songs (files) are played in a random sequence. ( lights.)



Press [6] (RANDOM) again to select the folder random play.

FOLDER RANDOM

Folder random play

All the available files in the current folder are played in a random sequence. ( ,  lights.)



Press [6] (RANDOM) again to turn off random play.

RANDOM OFF

Random off

Return to regular play.

Scan Play Setting

Press [4] (SCAN) to select the scan play setting.

SONG SCAN

Scan play

The first 10 seconds of each song (each file) is played in sequence.



Press [4] (SCAN) again to select the folder scan play.

FOLDER SCAN

Folder scan play

From the next folder, the first 10 seconds of the first file in each folder is played in sequence. ( lights.)



Press [4] (SCAN) again to turn off scan play.

SCAN OFF

Scan off

Return to regular play.

Repeat Play Setting

Press [5] (REPEAT) to select the repeat play setting.

SONG REPEAT

Repeat play

The current song (file) is repeated. ( lights.)



Press [5] (REPEAT) again to select the folder repeat play.

FOLDER REPEAT

Folder repeat play

The current folder is repeated. ( ,  lights.)



Press [5] (REPEAT) again to turn off repeat play.

REPEAT OFF

Repeat off

Return to regular play.

For use with iPod

By connecting compatible with iPod devices to USB connector via a USB extension cable for iPod (USB 2.0, not included), you can enjoy music files stored on the compatible with iPod devices in your vehicle.

Note: Refer to the section on “USB (MP3/WMA)” for connection.

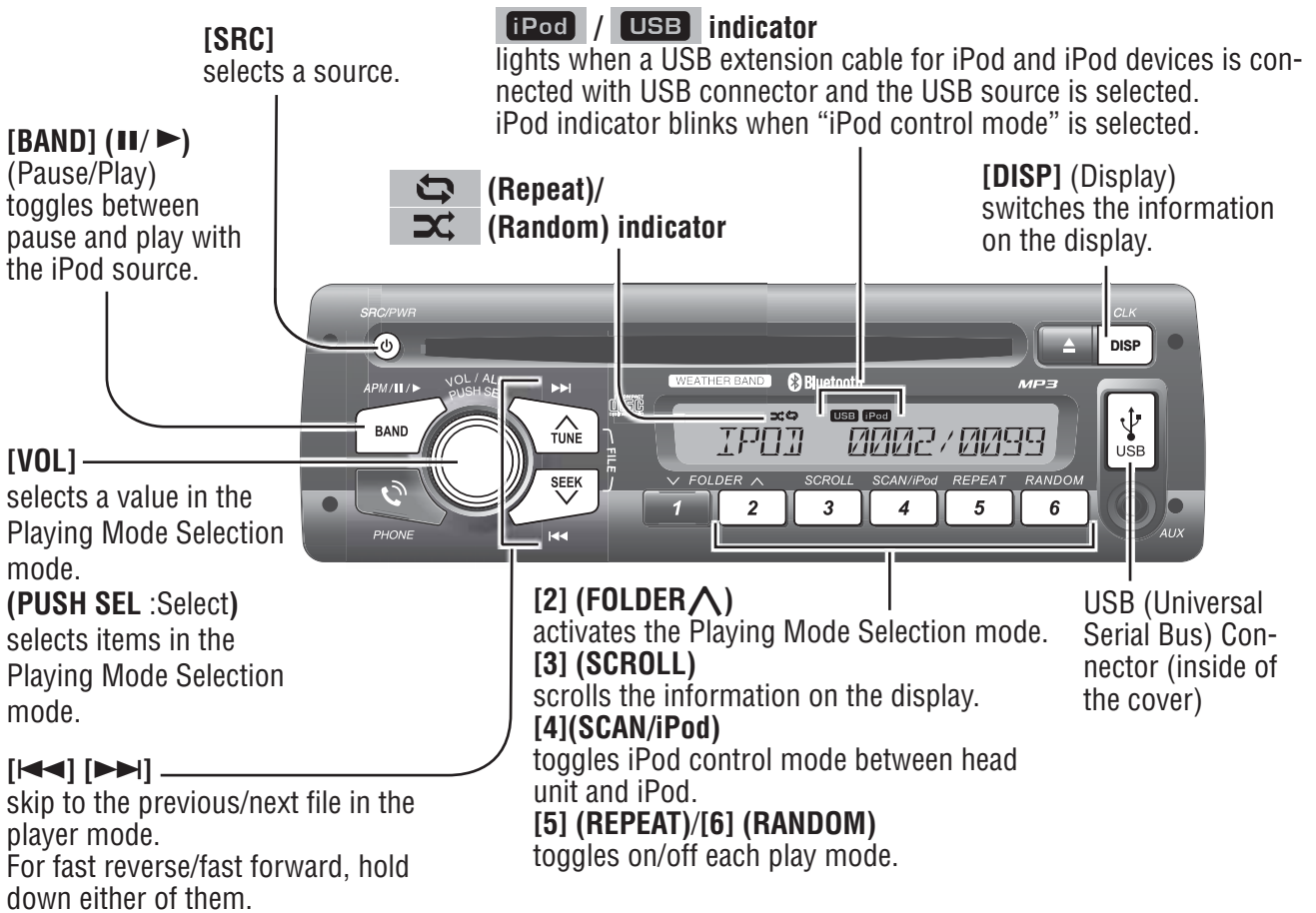

Operation Flow

- 1 Connect an iPod.
- 2 Press **[SRC]** to select the iPod (USB) mode. Playback starts.

Note: If playback does not start, press **[BAND] (||/▶)**.

File Selection

[▶▶]: Next file

[◀◀]: Beginning of the current file
For the preceding file, press twice.

Notes:

- Hold down for fast forward/reverse.
- When fast forward comes to the end of a file or fast reverse comes to the beginning of a file, regular playback starts when the fast forward or reverse button is released.

Pause

Press **[BAND] (||/▶)**.

Press again to cancel.

Playing Mode Selection

- 1 Press **[2] (FOLDER ^)** to activate the Playing Mode Selection mode.
- 2 Turn **[VOL]** clockwise or counterclockwise to adjust.

PLAYLIST: Playback by playlist (Default)
ARTIST: Playback by artist
ALBUM: Playback by album
GENRE: Playback by genre

- 3 Press **[VOL] (PUSH SEL)** to determine the selection.
- 4 Turn **[VOL]** clockwise or counterclockwise to select a portion to be played.
- 5 Press **[VOL] (PUSH SEL)** to determine the selection.

Notes:

- To exit the selection, press **[DISP]**.
- Files without an album name or an artist name are not playable in the playing mode of the album or artist display respectively.
- Playing Mode Selection is not available when this unit is switch to iPod control mode.

Display change

Press **[DISP]** to change the display.

Notes:

- For scrolling text, press **[3](SCROLL)**.
- "NO TEXT" is displayed when there is no information on iPod.

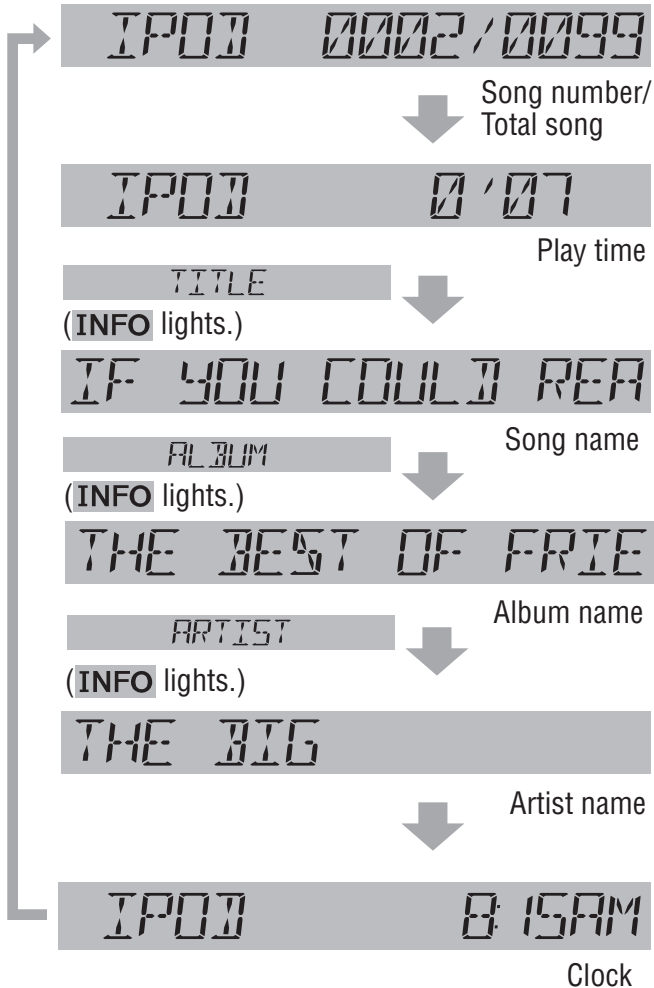

Setting the iPod Control

When an iPod/iPhone is connected, operate it from its own controls or from this head unit can be selectable.

Press **[4] (SCAN)** to switch iPod control mode between this head unit and iPod.

IPOD CTRL (HU)

iPod mode (Default):

Operate the iPod/iPhone playback via this head unit.



IPOD CTRL (IPOD)

iPod control mode:

Operate the iPod/iPhone playback using its own controls.

Note: The iPod control mode (function) may not be operated/supported on the models other than compatible models listed on page 9.

Please note the controllable function under "iPod Mode" and "iPod Control Mode" on head unit may vary with iPod models.

For use with iPod (continued)

Repeat, Shuffle Play

Repeat Play Setting

Press [5] (REPEAT) to select the repeat play setting.

ONE-REPEAT

One song repeat play

The current file is repeated. (↺ lights.)



Press [5] (REPEAT) again to select the all songs repeat play.

ALL-REPEAT

All songs repeat play

The all playable songs are repeated. (↺ blinks.)



Press [5] (REPEAT) again to turn off repeat play.

REPEAT OFF

Repeat play off

Return to regular play.

Note: When using iPod nano (4th generation) and this unit is under iPod control mode, the "IPOD CTRL <IPOD>" is always displayed on this unit when select repeat play setting from this unit. The repeat play setting is functional even without above corresponded display.

Shuffle Play Setting

The shuffle function of an iPod corresponds to the RANDOM function of this unit.

Press [6] (RANDOM) to select the shuffle play setting.

RANDOM ON

Songs

All the available files are played in a random sequence. (↻ lights.)



Press [6] (RANDOM) again to select the album shuffle play.

RANDOM ON

Albums

All the playable albums are played in a random sequence. (↻ blinks.)

Notes:

- The Album shuffle play function is only available when the unit is switch to iPod control mode or controlled directly by iPod devices. Album shuffle function is available depending on the connected iPod/iPhone equipped with album shuffle function.
- When the last selected play list with the iPod is song, song shuffle play is activated, and when it is album, album shuffle play is activated.



Press [6] (RANDOM) again to turn off shuffle play.

RANDOM OFF

Shuffle off

Return to regular play.

Note: Depending on the connected iPod/iPhone, repeat play or random play function or display may differ from this unit and your iPod/iPhone.

Notes:

- The shuffle function for iPod corresponds to the RANDOM function of this unit.
- Please make sure to detach the iPod after turning off the vehicle engine (turning the ACC to OFF). The iPod devices may not shut down while still connected, which may result in battery depletion.
- Please do not connect for iPod accessories such as for iPod remote control unit or headphones while connecting for iPod with the unit. The unit may not operate correctly.
- Connect this unit after turning down the volume for the iPod.
- "AUTHENTICATING" appears until for iPod is recognized after connecting for iPod. This indicates there is nothing wrong with the main unit.
- We do not guarantee all the operations of connectable devices.
- If your iPod or iPhone is not working correctly, disconnect it from this unit, reset it and then reconnect it to this unit.
- The iPod/iPhone will be recharged while connected to this unit.

Bluetooth® - General

Bluetooth® indicator

lights when a Bluetooth® device is connected, and blinks during a call.

Signal indicator

lights when a cellular phone is paired and connected, indicates the intensity of cellular phone's signal wave.

[DISP] (Display) switches the information on the display.

[SRC] selects a source.

[BAND] connect, or disconnect a Bluetooth® device.

[PUSH SEL] deletes the registration data. makes this unit standby for registration.

[<<]/[>>] selects a number.

[1] through [6] (preset buttons) selects a registration number of a Bluetooth® device.
[6]: sets the PIN code.

Registration number (M1 – M8)



Registration of a Bluetooth® device to this unit

1 Press one of the preset buttons from **[1]** through **[6]** to select a registration number assigned to the Bluetooth® device to be registered.

Note: Up to 8 devices memory registered with preset buttons.

[1] – [5] : Selects a registration number (1st page: 1 – 5, 2nd page: 6 – 8)

[6] : Turns the registration pages
For registration No.6: press **[6]**, then press **[1]**.
For registration No.7: press **[6]**, then press **[2]**.
For registration No.8: press **[6]**, then press **[3]**.

2 Hold down the selected preset button for more than 2 seconds.

3 Push **[SEL]** (Select) to make this unit standby for registration with waiting status.

Note: To exit waiting status, press **[DISP]**.

4 Operate your Bluetooth® device to input the PIN code for connection. (Default PIN code is "0000")

Once pairing/registration is successful, the registered Bluetooth® device can automatically communicate with this unit.

Notes:

- The text display of Bluetooth® device name and telephone directory on this unit is only supported with English characters, other languages and undisplayable characters/symbols will be converted into an asterisk (*).

- If registration is not successfully completed within 1 minute, "TIME OUT" appears and the screen for registration number selection resumes.
- If registration fails because of mismatched PIN code, "B/T PIN ERR" appears and the screen for registration number selection resumes.
- Depending on the communication status, it may takes 5 to 40 seconds for device connection.

Note on operation:

Some Bluetooth® devices/Phones may not connect to this unit or, even when connected, the operation method, displays, and functions may differ from the instructions within this manual.

For the Bluetooth® devices/Phones to be supported with this unit, please visit/consult your dealer to verify compatibility of your Bluetooth® devices or phones.

Display change

Press **[DISP]** (Display) to change the display.

P07C M1

Registered device name (Example)



BLUETOOTH 1:10:00AM

Clock

Notes:

- We shall not guarantee all the functions of the Bluetooth® device to be connected. When operations cannot be performed via this unit, operate the system via the Bluetooth® device.
- Be aware that the battery of a Bluetooth® device drains faster if the Bluetooth® device is connected to this unit.

- Even when the Bluetooth® device that is connected to this unit is located near this unit, sound may be interrupted or noise may be generated.
- The Bluetooth® device with over 5-digit PIN code is not operated with this unit.
- “B/T DISCOND” is displayed when the Bluetooth® device is disconnected.

Setting of PIN (Personal Identity Number) code

- 1 Hold down [6] for more than 2 seconds to call the PIN code entry mode.

PINCODE 0000 M I

- 2 Press [6] to prepare for adjustment.

PINCODE 0000 M I

1st digit blinks

- 3 Enter a number for each digit.

[◀◀] / [▶▶]: Selects number (0 – 9).

[6]: Selects next digit to be entered.

PINCODE 1234 M I

Digit entered

- 4 Press [6] to determine the PIN code entry when last digit is entered.

PINCODE SET M I

Completed

Note: To check the Bluetooth® address of this head unit, press [SEL] after step 1.

Connection of the registered Bluetooth® device to this unit

- 1 Press the preset button(s) [1] through [6] to select the registration number of the Bluetooth® device of interest. (Refer to the above.)

- 2 Hold down [BAND] for more than 2 seconds for connection.

CONNECTING M I



P07C M I

The Bluetooth® indicator (📶) lights.

Notes:

- Even if [SRC] (Source) is pressed to change the source, the connection stays connected.
- Depending on the communication status, it may take 5 to 40 seconds for device connection.

Disconnection of the Bluetooth® device

Hold down [BAND] for more than 2 seconds.

B/T DISCOND M I

The Bluetooth® indicator (📶) turns off.

Note: When the Bluetooth® device is out of reception range or encounter serious interference by outer signal, “ERROR” appears and this unit will automatically disconnect the connections.

Deletion of the registered data

- 1 Press the preset button(s) [1] through [6] to select a registration number assigned to the Bluetooth® device whose data is to be deleted. (Refer to the above.)

P07C M I

- 2 Hold down the preset button [1] through [5] selected above for the registration number for more than 2 seconds.

RE-PAIRING M I

- 3 Press the preset button that was pressed at the step above again.

REG. DELETION M I

- 4 Push [SEL].

PAIR DELETED M I



NO PAIRING M I

Deletion completed

Bluetooth® - Hands-Free Phone

[BAND]
switches between the private mode and hands-free mode.

[PHONE]
picks up the phone, makes a call, or rejects the call.

[VOL]
switch the record
(PUSH SEL :Select)
selects items in the selection mode.



[▶▶]
activates the voice dial.

Phone answering

Press **[PHONE]** during a call incoming.
The Bluetooth® indicator (📶) blinks during a call incoming/making a call.

Notes:

- During a call incoming, the volume of this unit automatically switches to 18, it restores to the original volume setting when phone answering or call rejecting.
- If the automatic answering function is activated, conversation can be automatically started after receiving a call. (Refer to the below.)

Phone hanging up

Press **[PHONE]** during a call.

Switching between the private mode* and hands-free mode

Press **[BAND]** during a call.

The private mode and hands-free mode switch alternately every time **[BAND]** is pressed.

PRIVATE TALK M1



(Private mode)

B/T HF TALK M1

(Hands-free mode)

* The private mode is defined as the mode where conversation is conducted with the mobile phone in a usual manner without the hands-free function.

Incoming call rejection

Hold down **[PHONE]** for more than 2 seconds during a call incoming.

CALL REJECTED M1

Outgoing call termination

Hold down **[PHONE]** for more than 2 seconds during making a call. (When other party does not answer the call.)

TERMINATED M1

Setting of automatic answering function

Hold down **[PHONE]** for more than 2 seconds at the standby state.

The automatic answering function toggles between ON and OFF every time **[PHONE]** is held down for more than 2 seconds.

AUTO-ANS OFF M1

(Automatic answering deactivated)



AUTO-ANS ON M1

(Automatic answering activated)

Use of voice dial

1 Hold down **[▶▶]** for more than 2 seconds at the standby state.

VOICE DIAL M1

2 Pronounce the name registered on the telephone directory.

If the name matches with a piece of data on the telephone directory registered with the mobile phone, the telephone number of the name is dialed.

Note: The Bluetooth® mobile phone itself must be equipped and support voice dial function.

Note: To have a mobile phone conversation with use of this unit, the mobile phone shall be compatible with the Hands-Free Profile.

Use of receiving/calling records or telephone directory (phonebook)

1 Press **[BAND]** at the standby state.

2 Push **[SEL]** (Select).

The display changes as follows:

MISSED CALL MI

Receiving record with no responding

The record of receiving calls (up to 5 records) that have not been taken is displayed.
Rotation of **[VOL]** allows users to switch the record to be displayed.
Pressing **[PHONE]** allows users to make a call to the displayed record.

RECEIVED CALL MI

Receiving record with conversation made

The record of receiving calls (up to 5 records) that have been taken is displayed.
Rotation of **[VOL]** allows users to switch the record to be displayed.
Pressing **[PHONE]** allows users to make a call to the displayed record.

MAILED CALL MI

Calling record

The calling record (up to 5 records) is displayed.
Rotation of **[VOL]** allows users to switch the record to be displayed.
Pressing **[PHONE]** allows users to make a call to the displayed record.

PHONE BOOK MI

Telephone directory

The telephone directory is displayed.

Rotation of **[VOL]** allows users to switch the data registered on the telephone directory to be displayed. (up to 6 entries)

Pressing **[PHONE]** allows users to make a call to the displayed data.

Pressing **[BAND]** allows the deletion mode to be activated to delete the displayed data on the telephone directory. If **[BAND]** is pressed again after "SURE TO DEL?" appears, the currently displayed one piece of data on the telephone directory is deleted.

Note: To use this function, the telephone directory must be imported from Bluetooth® mobile phone to this unit. (Refer to the below)

CONTACT IMPORT MI

Telephone directory manually import mode

This unit becomes standby for importing the telephone directory from a Bluetooth® mobile phone. (Each time for single directory data transmission)

Operate the Bluetooth® mobile phone to transmit the telephone directory data to this unit.

Notes:

- To use this function, the mobile phone must be compatible with the Object Push Profile.
- "IMPORT ERROR" is displayed and the regular mode is restored if 1 minute elapses in the "IMPORT" flashing period without importing the telephone directory from mobile phone.

Bluetooth® - Music Player

Note: The Bluetooth® audio devices that can be played with this unit must be compatible with A2DP (Advanced Audio Distribution Profile) or AVRCP (Audio/Video Remote Control Profile).

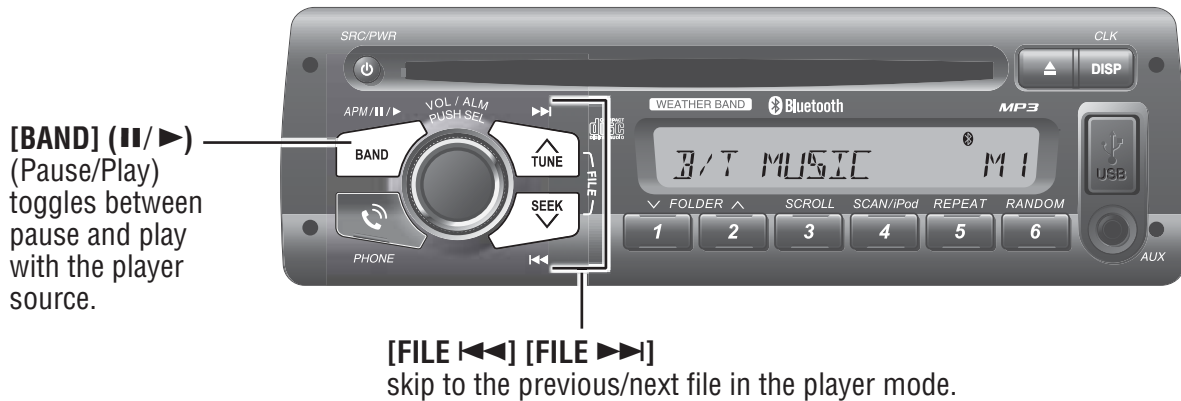

Music mode activation

Hold down [◀◀] for more than 2 seconds.

B/T MUSIC M1

(Music mode)

If [◀◀] is held down for more than 2 seconds again, the phone mode is activated.

PHONE M1

(Phone mode)

Note: "INVALID" is displayed and the Phone mode is restored if 1 minute elapse in the Music mode without detecting A2DP compatible device.

Song selection

[FILE ▶▶]: Next file
Hold down for fast forward.
Release to resume the regular play.

[FILE ◀◀]: Back to the beginning of the current file.
Back to the previous file. (press twice)

Notes:

- The control of pressing [FILE ▶▶] / [FILE ◀◀] in music mode depends on the key definitions of connected device.
- Depending on the specifications of the connected audio device, operations may not work.

Pause

Press [|| / ▶] (Pause/Play)

Press again to cancel.

Note: Some mobile phones automatically switch to energy saving mode or sleep mode when pause the music playback, and automatically disconnected the Bluetooth® connection ("B/T DISCOND" is displayed on this unit).

But if you want to reconnect the Bluetooth® connection, performing playback on the mobile phone itself.

Frequency band used

This product uses the 2.4 GHz frequency band, but other wireless devices may also use the same frequency. Note the following to prevent radio waves interfering with other wireless devices. Microwave ovens and other industrial, scientific, and medical equipment, in-plant radio stations used for mobile object identification on, for example, the production lines of factories, specified low power radio stations that do not require a license, amateur radio stations, and the like (hereafter abbreviated as “other radio stations”) operate in the same frequency band as this product.

Usage limitations

- This product is not guaranteed to be able to perform wireless communication with all Bluetooth® compatible devices.
- Bluetooth® compatible devices for wireless communication comply with the standard defined by Bluetooth® SIG, Inc., and need to receive certification. However, even if a Bluetooth® compatible device complies with the standard, a connection may not be possible, or the operating procedure, display, or operation may differ because of the specifications or settings of the device.
- This product includes support for security functions compliant with the Bluetooth® standard, but security may sometimes be insufficient depending on the operating environment and settings. Be careful during wireless communication.
- We assume no responsibility whatsoever for data generated or information leaked during wireless communication.

Influence from other devices

- If this product is used near another Bluetooth® compatible device or a device that uses the 2.4 GHz frequency band, problems such as the device not working properly and noise generation are likely to occur because of radio wave interference.
- This product may not work properly if there is a broadcasting station or the like nearby, and the surrounding signal is too strong.

Application limitations

- To use this product for listening to music or for a Hands-Free call, the Bluetooth® compatible device needs to support the following Bluetooth® version. Bluetooth® Standard Ver. 2.1
- To use this product for calling with a mobile phone, the mobile phone needs to support the Hands-Free Profile.
- To transfer the contacts of a mobile phone to this product, the mobile phone needs to support the Object Push Profile.
- A connection may not be possible, or the operating procedure, display, or operation may differ because of the specifications or settings of the Bluetooth® compatible device.
- Even if this product and Bluetooth® compatible device are close to each other, sound may be intermittent or affected by noise because of the state of the signal.

Bluetooth®

The Bluetooth word mark and logo are owned by the Bluetooth SIG, Inc.

Alarm Setting

[ALM] selects items in the alarm time setting.

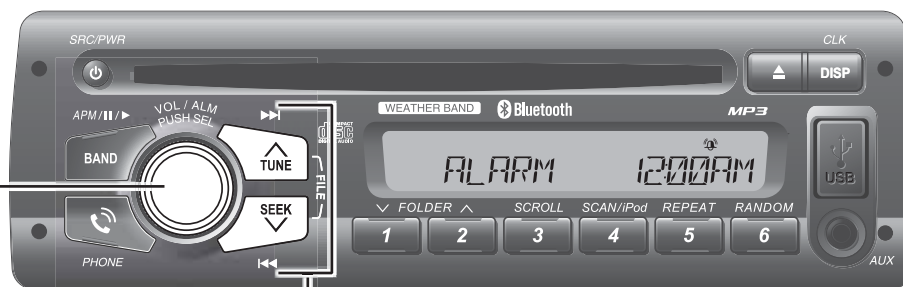

[<<<]/>>>] sets the hour and minute

Alarm time setting

*The 12-hour system is used for example.

- 1 Hold down **[ALM]** (Alarm) for more than 2 seconds.



(Alarm time display)

“ALARM ADJUST” is displayed when the alarm time is not adjusted.

- 2 Hold down **[ALM]** for more than 2 seconds after the above display is shown.



Hour blinks

- 3 Adjust the hour.

[>>>] : Sets ahead.

[<<<] : Sets back.



Hour entered

- 4 Push **[ALM]**.



Minute blinks

- 5 Adjust the minute.

[>>>] : Sets ahead.

[<<<] : Sets back.



Minute entered

- 6 Push **[ALM]** to complete.



Completed

The alarm is set to ON automatically after complete alarm time setting.

Alarm indicator (🔔) lights.

Notes:

- When the clock (→ page 11) is not set, perform and complete the alarm time setting, the clock time will set to “13:00” automatically. Please readjust the clock time depending on the actual clock time.
- Hold down **[>>>]** or **[<<<]** to change numbers rapidly.
- When you want to readjust the alarm time, repeat steps **1** to **6**.

Turning ON/OFF the alarm

- 1 Hold down **[ALM]** for more than 2 seconds.



ALARM 12:00AM

(Alarm time display)

- 2 Push **[ALM]**.



ALARM OFF

(Alarm ON/OFF setting)

- 3 Turn **[VOL]** (Volume) clockwise or counterclockwise to select alarm ON or OFF, then push **[ALM]** again to confirm the setting.

(Select alarm ON,  lights.)

Notes:

- Before turn ON the alarm, make sure the alarm time is set. Failure to heed this will cause invalid selection of alarm ON.
- Hold down **[ALM]** for more than 2 seconds when the alarm is sounding also turns off the alarm.
- Access of alarm ON/OFF is available by push **[ALM]** in the “Alarm time display”.

Activating snooze

Press any button on this unit when the alarm is sounding.



SNOOZE

The alarm will sound again in 9 minutes.

Notes:

- If you do not turn the alarm off when the alarm is sounding, the alarm sound will shut off after an hour. (Including the amount of time the alarm was postponed (snooze))
- If you connect with the optional wired remote control unit (RSA-300), please notice the ALARM button on RSA-300 only reflect the function of Display Alarm Time. (It's not feasible for long key operation)

Troubleshooting

If you suspect something wrong

Check and take steps as described below. If the described suggestions do not solve the problem, it is recommended to take the unit to your dealership. The product should be serviced only by qualified personnel. Please refer the checking and the repair to professionals. We shall not be liable for any accidents arising out of neglect of checking the unit or your own repair after your checking.

Never take measures especially for those other than indicated by *italic* letters in “Possible Solution” described below because those are too dangerous for users to handle themselves.



Warning

- Do not use the unit in an irregular condition, for example, without sound, or with smoke or a foul smell, which can cause ignition or electric shock. Immediately stop using the unit and consult your dealership.
- Never try to repair the unit by yourself because it is dangerous to do so.

Common

Problem	Possible cause → Possible solution
No power to the unit	<p>The power cord (battery, power and ground) is connected in the wrong way. → Check the wiring.</p>
Sound is not generated.	<p>Volume is set to zero (0). → Adjust volume.</p>
	<p>There is contact between the external mute lead and the chassis. → Connect the external mute lead correctly. If the lead is unused, insulate it.</p>
	<p>The wiring of speaker lines are not correct, or a break or poor contact arises. → Check the wiring in accordance with the wiring diagram.</p>
Noise	<p>There is an electromagnetic-wave generator such as a mobile phone near the unit or its electrical lines. → Keep an electromagnetic-wave generator such as a mobile phone away from the unit and the wiring of the unit. In case that noise cannot be eliminated due to the wiring harness of the vehicle, consult your dealership.</p>
	<p>The contact of the ground lead is poor. → Make sure that the ground lead is connected to an unpainted part of the chassis securely.</p>
Noise is made in step with engine revolutions.	<p>Alternator noise comes from the vehicle. → Change the wiring position of the ground lead. → Mount a noise filter on the power supply.</p>
Some operations are not executable.	<p>Some operations are not executable in particular modes such as menu mode. → Read the operating instructions carefully and cancel the mode. If the unit is still out of order, consult your dealership.</p>
No sound from speaker(s)	<p>BALANCE/FADER setting is not appropriate. → Readjust BALANCE/FADER.</p>
	<p>There is a break, a short circuit, poor contact or wrong wiring regarding the speaker wiring. → Check the speaker wiring.</p>

<p>The speaker channels are reversed between right and left.</p>	<p>The speaker wiring is confused between right and left. ➔ Perform the speaker wiring in accordance with the wiring diagram.</p>
<p>The sound field is not clear in the stereo mode. Central sound does not settled.</p>	<p>The plus and minus terminals at right and left channels of speakers are connected reversely. ➔ Perform the speaker wiring in accordance with the wiring diagram.</p>
<p>The power fails unintentionally.</p>	<p>The safety device works. ➔ Consult your dealership.</p>
<p>Clock time is reset.</p>	<p>Battery cable is not correctly connected. ➔ Connect the battery cable to the terminal that is always active.</p>

Radio

<p>Poor reception or noise</p>	<p>Antenna installation or wiring of antenna cable is faulty. ➔ Check whether the antenna mounting position and its wiring are correct. In addition, check to see whether the antenna ground is securely connected to the chassis.</p>
	<p>No power is supplied to the antenna amplifier (when using a film antenna, etc.). ➔ Check the wiring of the antenna battery lead.</p>
<p>The number of auto preset stations is less than 6.</p>	<p>The number of receivable stations is less than 6. ➔ Move to an area where receivable stations number is maximum, and try presetting.</p>

CD

<p>No playback or disc ejected</p>	<p>The disc is inserted upside down. ➔ Insert a disc correctly.</p>
	<p>There is a flaw or foreign material on the disc. ➔ Remove the foreign material, or use a flawless disc.</p>
<p>Sound skipping or noise</p>	<p>There is a flaw or foreign material on the disc. ➔ Remove the foreign material, or use a flawless disc.</p>
<p>Sound skipping due to vibration</p>	<p>The unit is not sufficiently secured. ➔ Secure the unit to the console box.</p>
	<p>The unit is tilted at over 30° in the front-to-end direction. ➔ Make the angle 30° or less.</p>
<p>Disc unejectable</p>	<p>Something such as a peeled label obstructs the disc coming out. ➔ Consult your dealership.</p>
	<p>The microcontroller in the unit operates abnormally due to noise or other factors. ➔ Unplug the power cord and plug it again. In case the unit is still out of order, consult your dealership.</p>

Troubleshooting (continued)

MP3/WMA

No playback or disc ejected

The disc has unplayable formatted data.
→ **Check the file format.**

The CD-R/RWs that are playable on other devices are not playable on this unit.

The playability of some CD-Rs/RWs may depend on the combination of media, recording software and recorder to be used even if these CD-Rs/RWs are playable on other devices such as a PC.
→ **Make CD-R/RWs in different combination of media, recording software and recorder after referring to the description about the compressed audio player.**

Sound skipping or noise

There is a flaw or foreign material on the disc.
→ **Remove the foreign material, or use a flawless disc.**

Playing VBR (Variable Bit Rate) files may cause sound skipping.
→ **Play Non-VBR files**

Note: Refer to “Notes on MP3/WMA”. (→ Page 44)

USB (MP3/WMA)

Music is not played back even if a USB device is connected.

The USB device and USB extension cable are not connected correctly.
→ **Connect the USB device and USB extension cable correctly.**

There is no music stored in a format that is supported on this unit.
→ **Check if there is any music data that can be played stored on the USB device.**

The file system of the USB device is not compatible with this unit.
→ **Use a USB device with a FAT12/16/32 file system.**

Use a USB device with a FAT12/16/32 file system.
→ **Use a USB device with a current consumption lower than 1 A.**

“READING” is displayed but music is not played back.

A USB hub is connected.
→ **Do not use a USB hub.**

Too many recorded folders/files exist.
→ **When there are too many recorded folders/files, it may take a long time to read all of the files.**

Bluetooth®

Unable to register, connect, or call.

Devices incompatible with HFP (Hands-Free Profile) cannot be used.

➔ **Use devices compatible with HFP (Hands-Free Profile).**

The mobile phone is not registered on this product.

➔ **Connecting and calling with an unregistered mobile phone is not possible. Register the mobile phone on this product.**

The mobile phone is not connected.

➔ **Calling is not possible if the mobile phone is not connected to this product. Connect the mobile phone to this product.**

The Bluetooth® device can not pair/register with this unit successfully.

➔ **Check the device Bluetooth® setting is set to ON.**

➔ **Delete the paired memory within Bluetooth® device and main unit, then pair again.**

➔ **Switch OFF and ON with device Bluetooth® function, then pair again.**

➔ **Check the device PIN code, then input the correct PIN code for connection.**

This unit and Bluetooth® device are too far apart.

➔ **Bring this unit and Bluetooth® device closer together and try to pair again.**

The other party in the call complains of echoing or noise.

The voice of the other party heard from the car speakers is being picked up by the microphone and returned to the other party.

➔ **Close the windows.**

➔ **Move the microphone away from the car speakers.**

➔ **Lower the volume.**

Phone voice is of poor quality.
Phone voice is inaudible.

Mobile phone reception is poor.

➔ **Check mobile phone reception.**

Bluetooth® audio does not work.

The Bluetooth® audio-compliant device does not support A2DP/AVRCP.

➔ **Check the instruction manual of the Bluetooth® audio-compliant device for support conditions.**

Some mobile phones can not play music via Bluetooth® if mobile phone is not in the music player mode.

➔ **Operate mobile phone, select the music player mode, then press PLAY to play the desired music file via Bluetooth® communication.**

Troubleshooting (continued)

Bluetooth®

Bluetooth® audio cannot be heard.

The main unit is not in the Bluetooth® music mode.
 ➔ **Check and switch to the Bluetooth® music mode.**

The Bluetooth® audio is not output from mobile phone or Bluetooth® audio device.
 ➔ **Switch OFF and ON with mobile phone or Bluetooth® audio device for reestablish the communication.**

The music is paused temporarily.
 ➔ **Press [BAND] button on this unit to resume music play.**

Some mobile phones can not restore the A2DP communication with music mode after ended phone conversation.
 ➔ **Press [BAND] button twice on this unit to restore the A2DP communication.**

Telephone voice dial does not work.

The mobile phone does not support the voice dial function.
 ➔ **Change to another mobile phone which supports the voice dial function.**

The distance between user and microphone is too far apart, the sound is low, or the surrounding is noisy.
 ➔ **Speak toward the microphone closer and keep the surrounding quiet.**

Sound skipping with Bluetooth® audio

This unit and Bluetooth® device are too far apart.
 ➔ **Bring the Bluetooth® device closer to this unit.**

There is another wireless device near this unit and interference occurs.
 ➔ **Switch off the other wireless device and keep it away from this unit.**

Other wireless device is using the Bluetooth® profile excluding from main unit. (Ex. All phonebook transmission)
 ➔ **Switch off the transmission with wireless device.**

Unable to import the telephone directory.

The mobile phone dose not support Bluetooth® OPP (Object Push Profile) function.
 ➔ **Change to another mobile phone which supports Bluetooth® OPP function.**

There is no telephone or name information within exported directory.
 ➔ **Confirm the directory information is completely and correctly.**

The mobile phone is too far apart or communication interference occurs.
 ➔ **Bring the mobile phone closer to this unit or switch off the other wireless device and keep it away from this unit.**

Product servicing

If the suggestions in the charts do not solve the problem, we recommend that you take it to your dealership. The product should be serviced only by a qualified technician.

Error Display Messages

Disc Player

Display

CD--DA --E1--

CD--DA --E2--

CD--DA --E3--

CD--DA --E4--

CD--WMA --E5--

NO DISC

Possible cause → Possible solution

The disc is dirty, or is upside down.

→ **Check the disc.**

The disc has scratches.

→ **Check the disc.**

No operation by some cause.

→ **Unplug the power cord and plug it again. In case the unit is still out of order, consult your dealership.**

The player for some reason cannot read the file you are trying to play. (File recorded in an unsupported file system, compression scheme, data format, file name extension, damaged data, etc.)

→ **Select a file that the player can read. Check the type of data recorded on the disc. Create a new disc if necessary.**

A WMA file can be copyrighted.

→ **The file protected by copyright is not playable.**

No disc in the player.

→ **Insert disc into the disc slot.**

USB (MP3/WMA)

NO USB

A USB device is not connected or the connected device cannot be recognized.

→ **Use a USB memory that is suitable for this unit.**

No playable files exist.

An unsupported USB device is connected.

→ **Use a USB memory that is suitable for this unit.**

→ **Record files that can be played back on this unit onto the USB memory.**

A USB device that exceeds the current capacity that can be supplied is connected. For some reason, an over-current was detected.

→ **Use a USB memory that has a consumption current of less than 1 A.**

→ **Switch the Source, and select the USB (MP3/WMA) mode again.**

→ **Switch the power off/on, and select the USB (MP3/WMA) mode again.**

→ **Check that the USB connector section is not dirty, and that there is no foreign objects.**

USB--MP3 --E2--

Error Display Messages (continued)

USB (MP3/WMA)

USB--MP3 --E3--

No operation by some cause

→ **Turn off the power and turn on the power again, or turn the key to the ACC OFF position and turn the key to ACC ON position again. If this does not solve the problem, unplug the power cord and plug it in again. In case the unit is still out of order, consult your dealership.**

USB--MP3 --E4--

The player cannot read the file you are trying to play for some reason. (File recorded in an unsupported file system, compression scheme, data format, file name extension, damaged data, etc.)

→ **Confirm that the USB extension cable is firmly connected, and reconnect if not. Select a file that the player can read. Check the type of data stored in the USB memory. Format the USB memory if necessary.**

USB--WMA --E5--

The WMA file can be copyrighted.

→ **The file protected by copyright is not playable.**

For use with iPod

NO IPOD

The iPod is not recognized correctly.

→ Some time could be taken for the iPod to be recognized.
→ **Check the connection.**
→ **Reset the iPod, and then connect it again.**

NO DATA

Your iPod has no playable music.

→ **Download playable music to your iPod.**

NO TITLE

The song has no title.

→ **Name the title to the song.**

UNSUPPORTED

The connected iPod is not supported by this unit.

→ **Connect a supported iPod to this unit.**

Bluetooth®

B/T MODULE ERR

The Bluetooth® module for some reason cannot function.

→ **Switch the power or ACC ON/OFF. In case the unit is still out of order, consult your dealership.**

B/T COMM. ERR

Bluetooth® communication error (Module and System)

→ **Switch the power or ACC ON/OFF. In case the unit is still out of order, consult your dealership.**

Notes on Discs

How to hold the disc

- Do not touch the underside of the disc.
- Do not scratch the disc.
- Do not bend disc.
- When not in use, keep disc in the case.

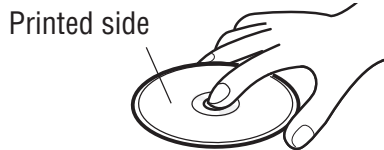

Unusable discs

Do not use discs that fit any of the descriptions given below. Using these discs may damage the discs or cause the unit to malfunction.

- Special discs in a shape which is not round



- Partly or wholly transparent disc



Wholly transparent disc* Partly transparent disc

*Wholly semi-transparent disc may not be played back.

- Discs with adhered labels, etc. on them



Disc with adhered stickers or tape

Labels created by a printer



Protective films or sheets

Disc accessories (stabilizers, etc.)

- Damaged or deformed discs



Shoddily made discs

Discs with cracks, scratches or parts missing



Discs with burrs
Please remove the burrs before use.

Disc insert

The surfaces of new discs tend to be slippery. Therefore, when using such a disc for the first time, it may not load satisfactorily even when it has been inserted into the unit. At a time like this, insert the disc into the unit as far as it will go until it is loaded properly.

- **When inserting a disc into or ejecting and removing it from the unit, insert it straight in or eject and remove it straight out in parallel with the unit. Otherwise, the disc may be scratched or marked in the process.**
- **When inserting a disc, do not put one disc on another. Failure to observe this may cause the discs to be jammed.**

Do not leave discs in the following places:

- Direct sunlight
- Near vehicle heaters
- Dirty, dusty and damp areas
- On seats and dashboards

Disc cleaning

Use a dry, soft cloth to wipe from the center outward.

Do not attach any seals or labels to your discs. Do not write on the disc label in a heavy pen or ballpoint pen.



<Correct>



<Wrong>

Notes on CD-Rs/RWs

- You may have trouble playing back some CD-R/RW discs recorded on CD recorders (CD-R/RW drives), either due to their recording characteristics or dirt, fingerprints, scratches, etc. on the disc surface.
- CD-R/RW discs are less resistant to high temperatures and high humidity than ordinary music CDs. Leaving them inside a vehicle for extended periods may damage and make playback impossible.
- The unit may not successfully playback a CD-R/RW that was made by the combination of writing software, a CD recorder (CD-R/RW drives) and a disc if they are incompatible with one another.
- This player does not play CD-R/RW discs if the session is not closed.
- Be sure to observe the handling instructions of CD-R/RW discs.
- This player does not play CD-R/RW discs which contain other than CD-DA or MP3/WMA data.

Notes on MP3/WMA

MP3 (MPEG Audio Layer-3) is a format for compressed audio file. These formats allow users to save all the files contained in approximately 10 pieces of existing CDs on one piece of CD-R/RW.

Note: Each of encoding software is not included with this unit.

*MPEG Layer-3 audio coding technology licensed from Fraunhofer IIS and Thomson.

Cautions as to compressed audio files

- High bit rate and high sampling frequency are recommended for high quality sounds.
- Selecting VBR (Variable Bit Rate) is not recommended because playing time is not displayed properly and sound may be skipped.
- The playback sound quality differs depending on the encoding circumstances. For details, refer to the user manual of your own encoding software and writing software.
- Be sure to put an extension compatible with the format.
- It is recommended to set the bit rate to “128 kbps or more” and “fixed”.

Compression formats

Compression method	Bit rate	VBR	Sampling frequency
MPEG 1 audio layer 3 (MP3)	32 k – 320 kbps	Yes	32, 44.1, 48 kHz
MPEG 2 audio layer 3 (MP3)	8 k – 160 kbps	Yes	16, 22.05, 24 kHz
MPEG 2.5 audio layer 3 (MP3)	8 k – 160 kbps	Yes	8, 11.025, 12 kHz
Windows Media Audio Ver. 2, 7, 8, 9*	64 k – 160 kbps	Yes	32, 44.1, 48 kHz

* WMA 9 Professional/LossLess/Voice are not supported.



Caution

Never put an extension indicating compressed audio (such as “.mp3”) to files other than compressed audio files. This may not only produce noise from the speaker damage, but also damage your hearing.

Cautions as to the display of this unit

Display Information

- **CD-TEXT**
 - Disc title
 - Track title
- **MP3**
 - Folder name,
 - File name
- **MP3 (ID3 tag)**
 - Album name,
 - Title name/artist name
- **WMA (WMA tag)**
 - Album name,
 - Title name/artist name

Displayable characters

- Displayable length of file name/folder name: within 30 characters. (Unicode file and folder names are reduced by half in the number of displayable characters.)
- Name files and folders in accordance with the standard of each file system. Refer to the instructions of writing software for details.
- ASCII character set and special characters in each language can be displayed.

ASCII character set

A to Z, a to z, digits 0 to 9, and the following symbols:

(space) ! " # \$ % & ' () * + , - . / : ; < = > ? @ [\] ^ _ { | } ~

Notes:

- Characters may be garbled depending on encoding software to be used
- Undisplayable characters and symbols will be converted into an asterisk (*).

Recording MP3/WMA Files on a CD-Media/USB-Device

Compressed audio file writing

- Do not save an audio file (CD-DA file) and a compressed audio file on the same disc. Failure to observe this may result in difficulty in playing.
- If compressed audio files formatted with two or more types are saved on the same disc, each format shall have a different folder.
- Do not write files other than compressed audio files.
- Playability may depend on the combination of writing software and disc writer to be used.
- This unit does not support the play list function.
- Write files in a disc-at-once manner unless otherwise needed.
- You can shorten the duration between data read and playback by decreasing the quantity of files or folders, or the depth of the hierarchy.

Supported file systems

■ CD-media

ISO 9660 Level 1/Level 2, Apple Extension to ISO 9660, Joliet, Romeo

Note: Apple HFS, UDF 1.50, Mix CD and CD Extra are not supported.

■ USB-device

File system is FAT12/16/32.

Maximum number of files/folders

- Maximum depth of trees: 8
- Maximum number of files
 - CD-media: 512 (folder is included.)
 - USB device: 65 535
- Maximum number of files in one folder
 - CD-media: 255
 - USB device: 512
- Maximum number of folders:
 - 128 (Root folder is included.)

Notes:

- You can shorten the duration between data read and playback by decreasing the quantity of files or folders, or the depth of the hierarchy.
- This unit counts the number of folders irrespective of the presence or absence of an MP3/WMA file.

- If the selected folder does not contain any MP3/WMA files, the nearest MP3/WMA files in the order of playback will be played.
- Playback order may be different from other MP3/WMA players even if the same disc is used.
- “ROOT” appears when displaying the root folder name.
- Empty folders stored on the USB memory are not included in the folder count.
- Depending on the connected USB memory, the order in which the files are played back may differ to the order in which the files were stored.

Folder selection order/file playback order

■ CD-media/USB-device

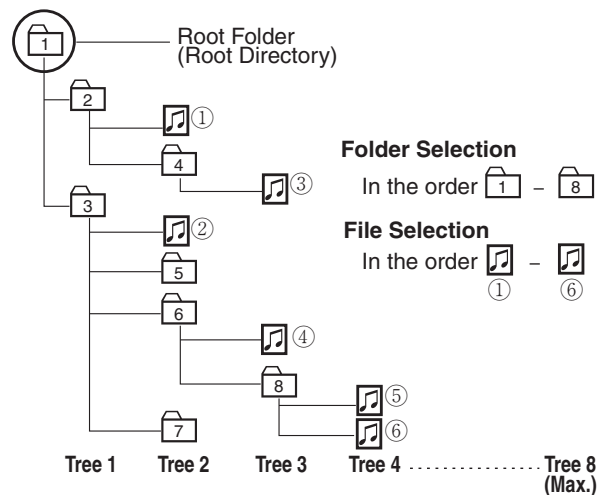

Copyright

It is prohibited by copyright laws to copy, distribute and deliver copyrighted materials such as music without the approval of copyright holder except enjoying yourself personally.

No warranty

Above description complies with our investigations as of December 2013. It has no warranty for reproducibility and displayability of MP3/WMA.

Maintenance

Cleaning this unit

Your product is designed and manufactured to ensure a minimum of maintenance. Use a dry soft cloth for routine exterior cleaning. Never use benzine, thinner or other solvents.

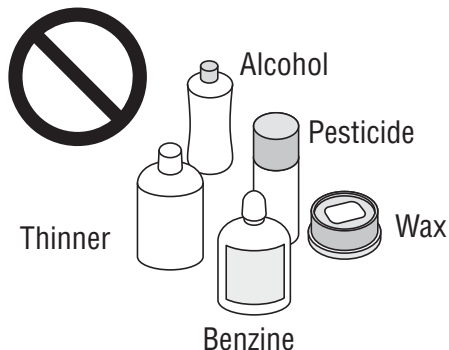

To remove stubborn stains

- ① Moisten the soft cloth in dish-washing soap diluted with water and wring well.
- ② Wipe lightly. Go over the same surface with a dry cloth.



Notes:

- Since there is the possibility of water drops getting inside of the unit, do not directly apply cleanser to the surface.
- Do not scratch the screen with your nails or other hard objects. The resulting scratches or marks will obscure the images.



Caution

If water drops or similar wet substances get inside the unit, it may cause a malfunction.

Specifications

General

Power Supply:	12 V DC (11 V – 16 V), test Voltage 14.4 V, Negative \ominus ground
Current consumption:	Less than 2.5 A (CD mode, 0.5 W x 4 channels)
Maximum Power Output:	45 W x 4 channels at 400 Hz, Volume Control maximum
Tone adjustment range:	
Bass:	± 12 dB at 100 Hz
Treble:	± 12 dB at 10 kHz
Power Output:	18 W per channel into 4 Ω , 40 Hz to 30 000 Hz at 3 % THD
Suitable Speaker Impedance:	4 Ω
Dimensions (W x H x D):	178(W) x 50(H) x 155(D) mm {7" x 1-15/16" x 6-1/8"}
Weight:	1.4 kg {3 lbs. 1 oz.}
USB connector	
USB standard compatibility:	1.1/2.0 full speed
File system:	FAT12/16/32
Maximum supply current:	1 A
Playable audio format:	MP3/WMA
Recommended capacity/partition:	Less than 32 GB/Only supported for 1 partition.
Front AUX input	
Input impedance:	10 k Ω
Maximum input level:	2.0 V
Connector:	3.5 mm \varnothing Stereo mini pin
Input sensitivity:	200 mVrms
Rear AUX input	
Input impedance:	10 k Ω
Maximum input level:	2.0 V
Input sensitivity:	200 mVrms

FM Stereo Radio

Frequency Range:	87.9 MHz – 107.9 MHz
Usable Sensitivity:	12 dBf (1.1 μ V/ 75 Ω , S/N 30 dB)
50 dB Quieting Sensitivity:	17 dBf (1.8 μ V/ 75 Ω)
Frequency Response:	30 Hz – 15 000 Hz ± 3 dB
Alternate Channel Selectivity:	75 dB
Stereo Separation:	35 dB at 1 kHz
Signal/Noise Ratio:	70 dB (Mono)

AM Radio

Frequency range:	530 kHz – 1 710 kHz
Usable sensitivity:	28 dB/ μ V (25 μ V, S/N 20 dB)

Weather Band Radio

Frequency range:	162.400 MHz – 162.550 MHz
Usable sensitivity:	3 dB/ μ V (S/N 20 dB)
Signal/Noise Ratio (40 dB/ μ V):	50 dB

CD Player

Sampling Frequency:	8 times oversampling
DA Converter:	1 bit 4 DAC System
Pick-Up Type:	3-beam
Light Source:	Semiconductor laser
Wavelength:	790 nm
Frequency Response:	20 Hz – 20 000 Hz (± 1 dB)
Signal to Noise Ratio:	85 dB
Wow and Flutter:	Below measurable limits
Channel Separation:	75 dB

Bluetooth®

Communication	
Frequency:	2 402 MHz – 2 480 MHz
Number of Channels:	79 Channels
Communication Mode:	Frequency Hopped Spread Spectrum Communication
RF Output:	0 dBm (0.8 mW)
Service Area:	Within 10 m
Applicable Bluetooth®	
Version:	Version 2.1 + EDR

Bluetooth QD ID B016993.

Notes:

- Specifications and design are subject to modification without notice due to improvements.
- Some figures and illustrations in this manual may be different from your product.

Above specifications comply with EIA standards.

Power Output:
16 W RMS x 4 Channels at 4 Ω
and $\leq 1\%$ THD+N
Signal to Noise Ratio:
85 dBA (reference: 1 W into 4 Ω)



Specification from the Terminal End (Rear Connector of This Unit)

Specification from the terminal end (Rear connector of this unit)

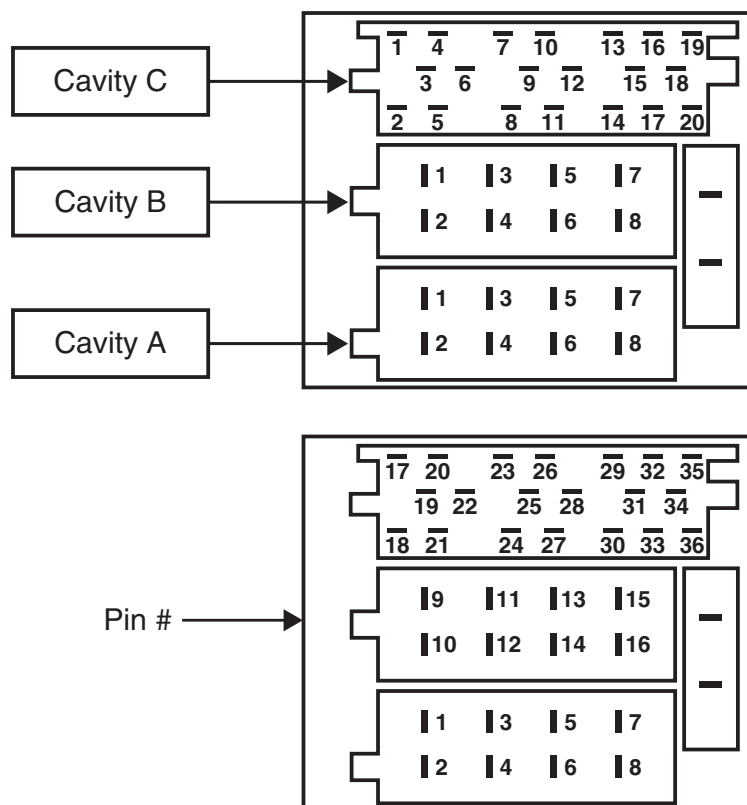

Cavity	Pin #	Function	I/O
A1	1	J1939 CAN-H*	I/O
A2	2	J1939 CAN-L*	I/O
A3	3	Park Lights	I
A4	4	ACC (Ignition)	I
A5	5	Amp Control	O
A6	6	Dimmer PWM	I
A7	7	Battery	I
A8	8	Power Ground	I
B1	9	RR+ (Speaker)	O
B2	10	RR- (Speaker)	O
B3	11	RF+ (Speaker)	O
B4	12	RF- (Speaker)	O
B5	13	LF+ (Speaker)	O
B6	14	LF- (Speaker)	O
B7	15	LR+ (Speaker)	O
B8	16	LR- (Speaker)	O
C1	17	Power Ground	I
C2	18	Amp Sense	I
C3	19	N/C	NA
C4	20	N/C	NA
C5	21	N/C	NA
C6	22	N/C	NA
C7	23	L_AUX_IN	I
C8	24	AUX_SHIELD_GND	I
C9	25	AUX_COM	I
C10	26	R_AUX_IN	I
C11	27	AUX_ON_OFF	I
C12	28	Power Ground	I
C13	29	N/C	NA
C14	30	Power Ground	I
C15	31	MIC +	I
C16	32	MIC -	I
C17	33	Pre-out GND_RR	O
C18	34	Pre-out GND_RL	O
C19	35	Pre-out RL	O
C20	36	Pre-out RR	O



Caution

This product is designed without a fuse inside due to fuses already exist in your vehicle. If your vehicle is without the fuse or a circuit breaker to protect this unit, please consult your dealership add the specified fuse* or a circuit breaker at the BATTERY lead of your vehicle's harness.

*We would recommend to use fuses of the specified rating not exceed (15 A). Using fuses that exceed the prescribed capacity could cause this product to start smoking, ignite or other malfunction.

Note: * This pin (J1939 CAN-H/J1939 CAN-L) is not available because it is for future use. Please do not connect to this pin.

