

Schematic Diagram Index

EXHIBIT # : 5
FCC ID : ACJ927128AH
OUR REF. : MKES99-F018
MODEL NO. : PV-V4520

| <u>Circuit Name</u> | <u>Drawing No.</u> |
|---|--------------------|
| INTER CONNECTION | 1 |
| POWER | 2 |
| MAIN 1 | 3 |
| MAIN 2 | 4 |
| MAIN 3 | 5 |
| MAIN 4 | 6 |
| RF DEMODULATOR Type No.: VEQS0614 (RF CONVERTER) | 7 |
| Hi-Fi 4 HEAD AMP. | 8 |
| CAP. STATOR | 9 |

KG-20 SERIES INTER CONNECTIC

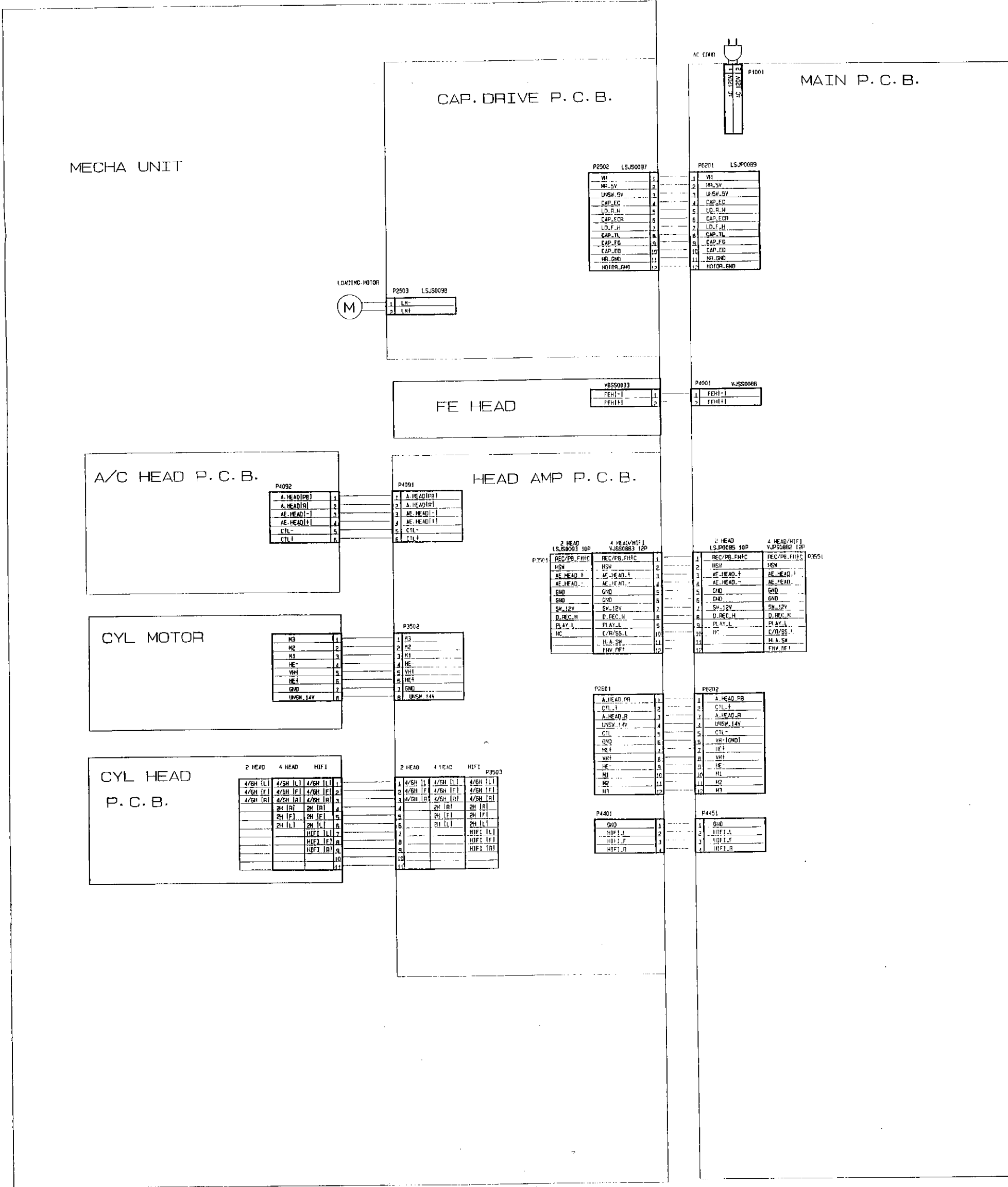

TIOND

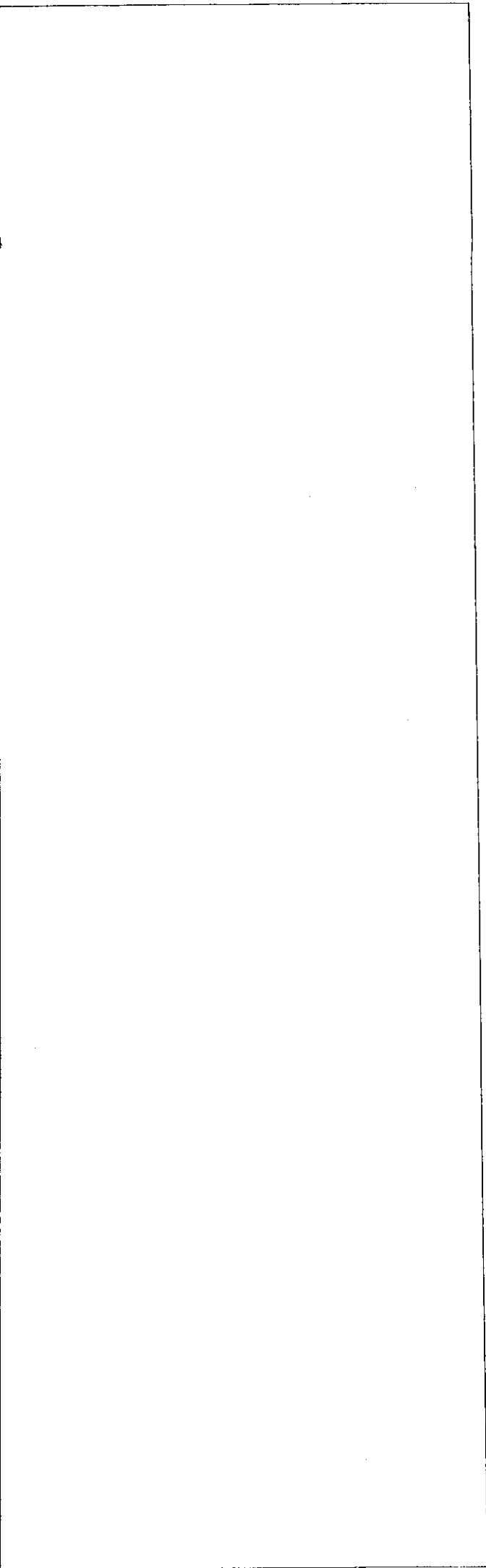

DRAWING FILE

NET CONNECTION

| Δ | Date | Rev. No. | Name |
|---|------|----------|------|
| | | | |
| | | | |
| | | | |
| | | | |
| | | | |
| | | | |
| | | | |
| | | | |
| | | | |
| | | | |
| | | | |

| | |
|--------------------|------------------|
| Drawing No. | |
| Item | INTER CONNECTION |
| Part No. | KG-20series |
| Application Models | |
| Date of Issue | 09/08/02 |
| Drawn by | E. Hassan |

PV-V4520

MASTER | 47/25 |

RCUIT

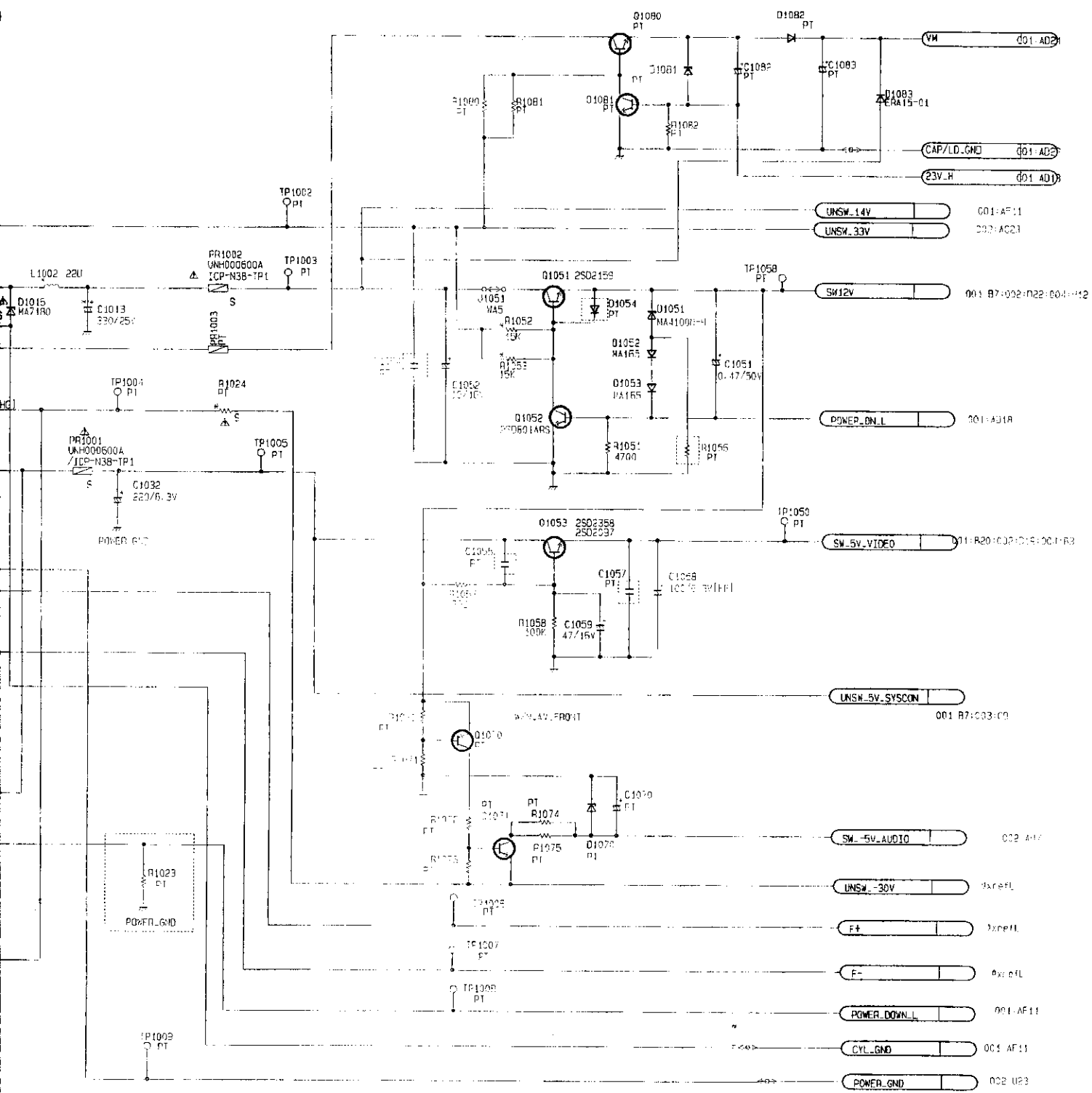

DRAWN: 102

POWER

2000_MODEL MAIN_1

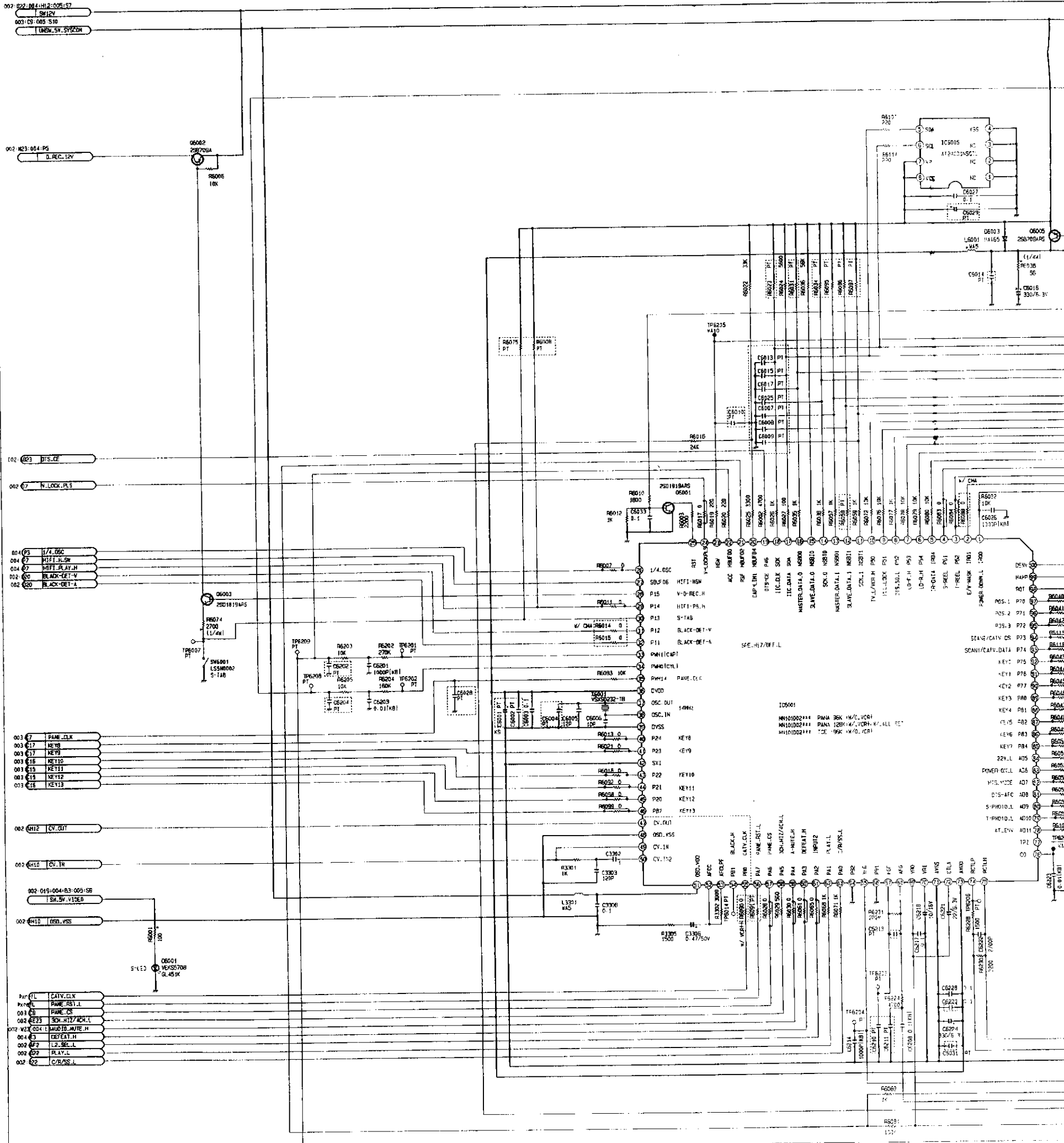

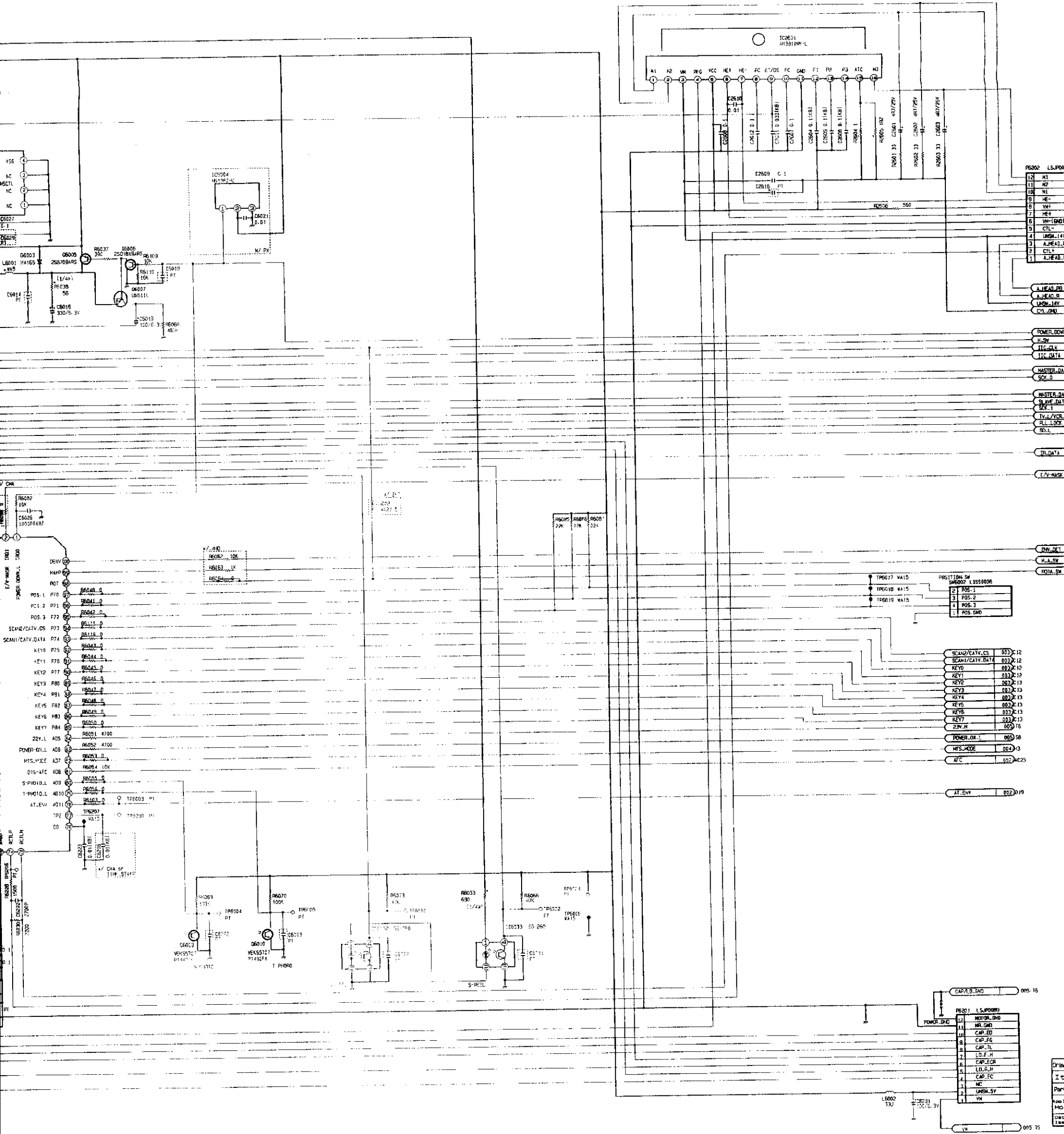

P6202 LS.P006

| | |
|----|----------|
| 12 | N3 |
| 11 | N2 |
| 10 | N1 |
| 9 | HE- |
| 8 | VH1 |
| 7 | HE+ |
| 6 | VH-(GND) |
| 5 | CTL- |
| 4 | LSM-14V |
| 3 | A-HEAD-R |
| 2 | CTL+ |
| 1 | A-HEAD-L |

POSITION: SW

SPEE002 L5S0006

| | |
|---|---------|
| 2 | POS-1 |
| 3 | POS-2 |
| 4 | POS-3 |
| 1 | POS-GND |

| | | |
|-----------------|-----|-----|
| SCAN2/CATV_CS | 003 | C12 |
| SCAN1/CATV_Data | 003 | C12 |
| KEY0 | 003 | C12 |
| KEY2 | 003 | C12 |
| KEY3 | 003 | C12 |
| KEY4 | 003 | C12 |
| KEY5 | 003 | C12 |
| KEY6 | 003 | C12 |
| KEY7 | 003 | C12 |
| 2W_H | 003 | C12 |

| | | |
|------------|-----|----|
| POWER_ON_1 | 002 | S8 |
| MIS_MODE | 002 | S8 |
| AFC | 002 | S8 |

AT_ENH 002 D19

CAP/LD_BND 005 16

P6201 L5.P000F3

| | |
|----|-----------|
| 12 | MOTOR_GND |
| 11 | MTR_GND |
| 10 | CAP_ED |
| 9 | CAP_PG |
| 8 | CAP_FL |
| 7 | LD_F_H |
| 6 | CAP_ECR |
| 5 | LD_R_H |
| 4 | CAP_FC |
| 3 | NC |
| 2 | LSM-SV |
| 1 | VH |

005 15

KG-20 Series MAIN 2

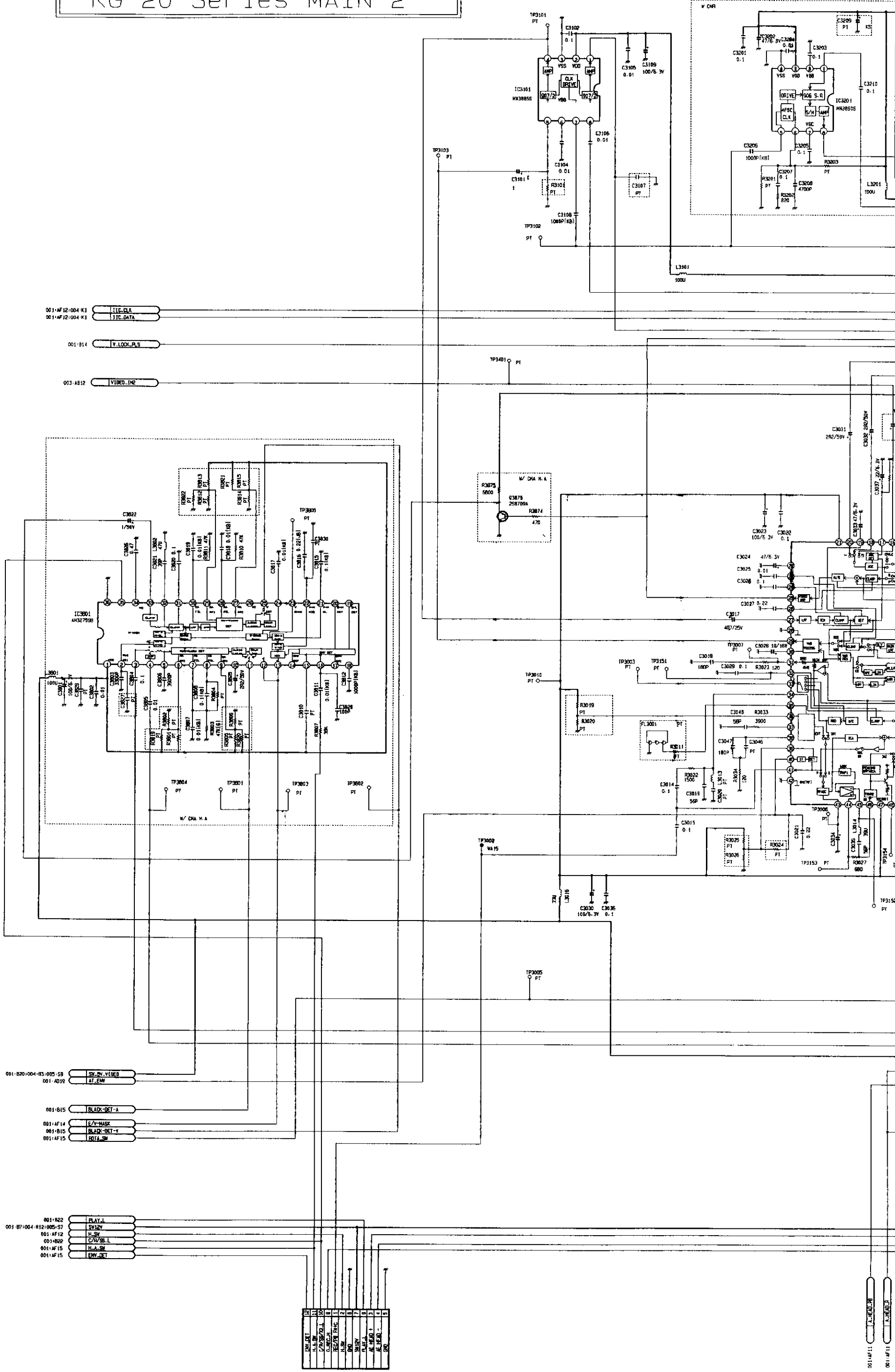

- 001 AF 12:004 K3 TIC_CLK
- 001 AF 12:004 K3 TIC_DATA
- 001 B14 Y_LOCK_PLS
- 003 B12 VIDEO_LINE

- 001 B20:004 B3:005 S8 SW_PV_VTRD
- 001 A019 AT_SW
- 001 B15 BLACK_DET_A
- 001 AF 14 L/V_MASK
- 001 B15 BLACK_DET_Y
- 001 AF 15 DATA_SW

- 001 B22 PLAY_L
- 001 B7:004 H12:005 S7 SW12Y
- 001 AF 12 H_SW
- 001 B22 C/R/SE_L
- 001 AF 15 H.A.-SW
- 001 AF 15 EW_DET

| | | | | | | | | | | | | | | | | | | | | |
|--------|---------|----------|------|-------|--------|---------|-------------|-------------|-------|------------|----|----|----|----|----|----|----|----|----|----|
| 10 | 11 | 12 | 13 | 14 | 15 | 16 | 17 | 18 | 19 | 20 | 21 | 22 | 23 | 24 | 25 | 26 | 27 | 28 | 29 | 30 |
| EW_DET | H.A.-SW | C/R/SE_L | H_SW | SW12Y | PLAY_L | DATA_SW | BLACK_DET_Y | BLACK_DET_A | AT_SW | SW_PV_VTRD | | | | | | | | | | |

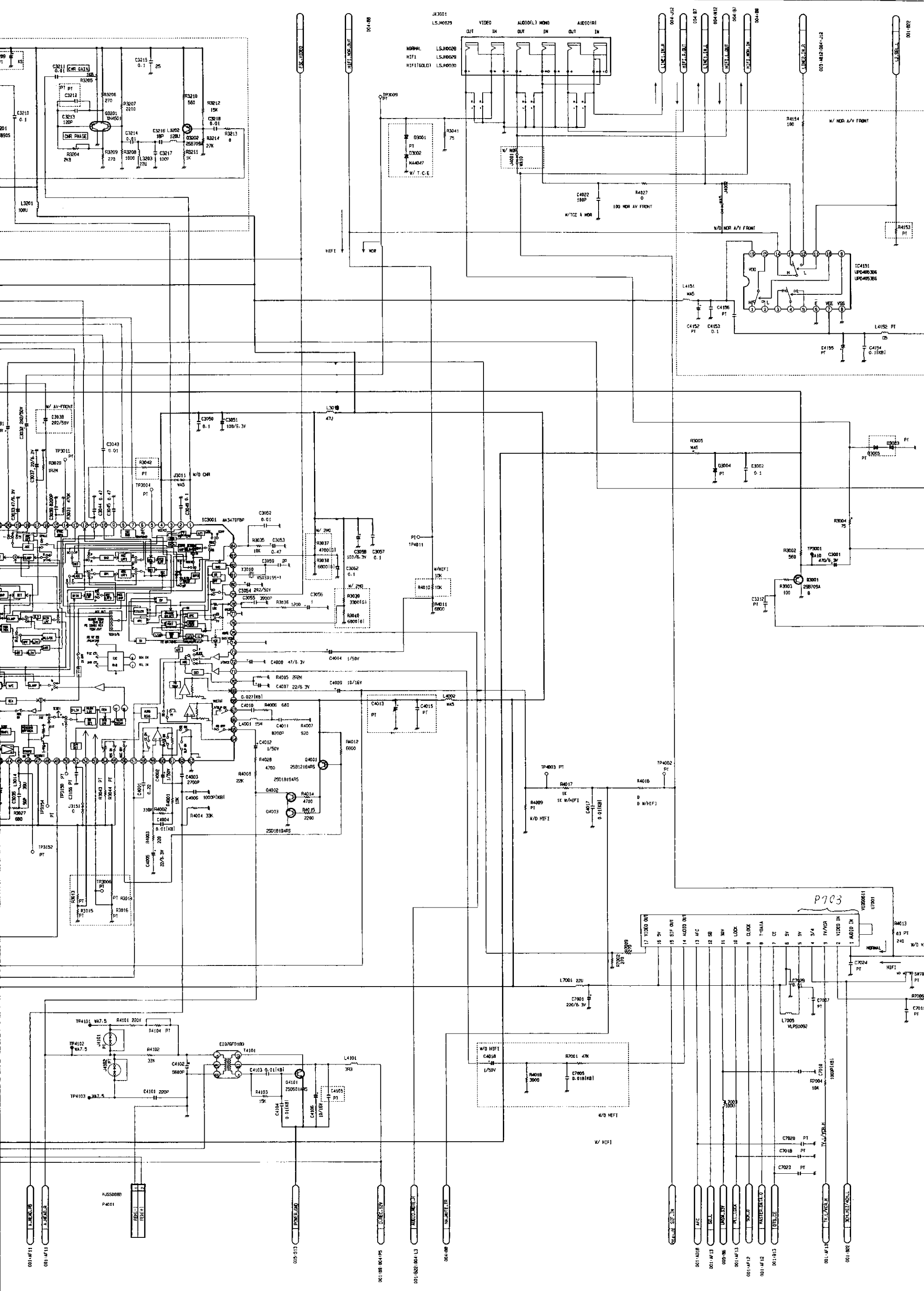

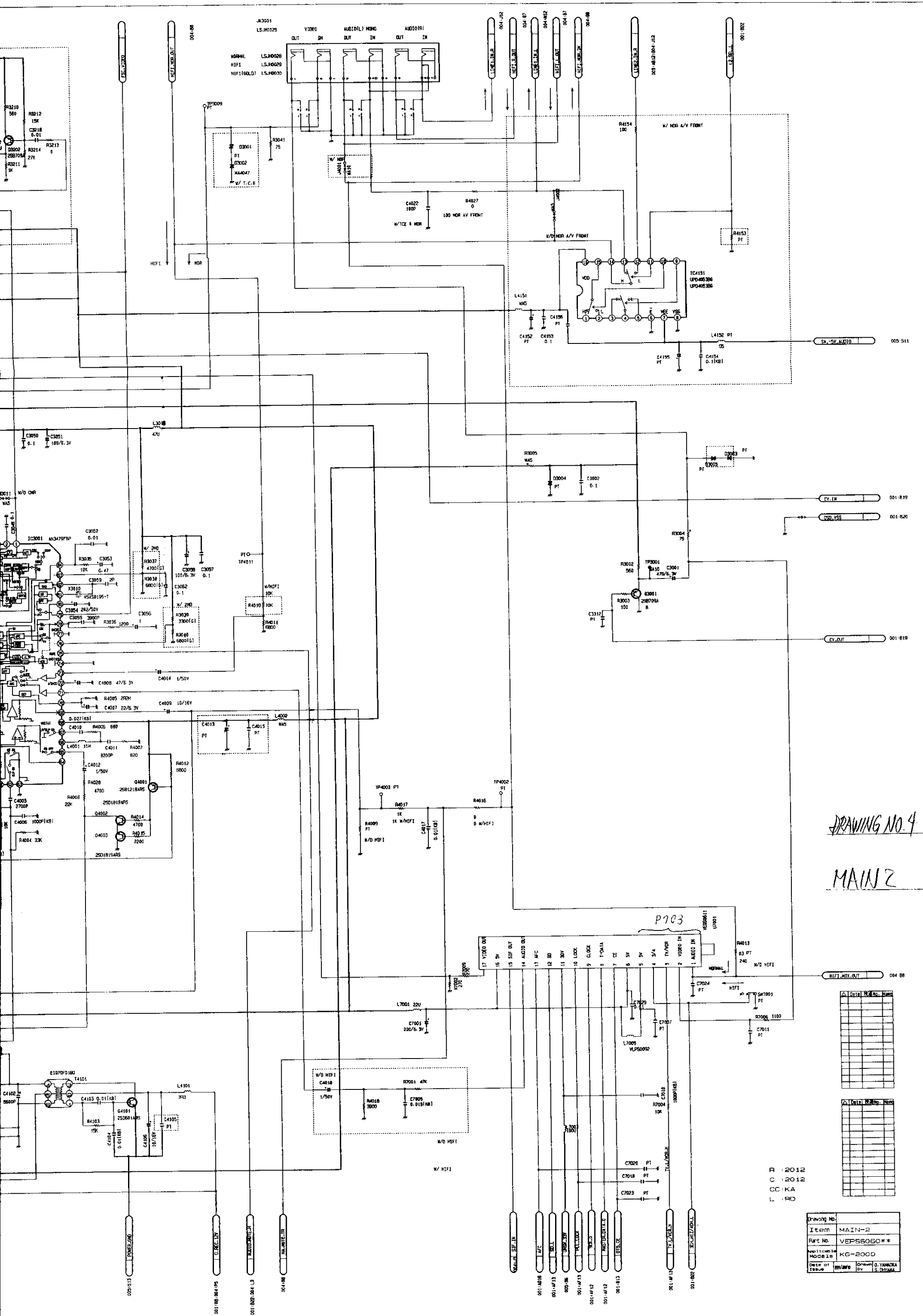

DRAWING NO. 4
 MAIN 2

R : 2012
 C : 2012
 CC : KA
 L : RD

| | |
|---------------|-----------|
| Drawing No. | 004 88 |
| Item | MAIN-2 |
| Part No. | VEPS060** |
| Application | KG-2000 |
| Mode 1st | |
| Date of Issue | 01/01/81 |
| By | S. YAMADA |

| | | | |
|------|-----|------|----|
| REV. | NO. | DATE | BY |
| | | | |
| | | | |
| | | | |
| | | | |

KG-20series MAIN 3

LITEON LED PA MEC DRIVER TY

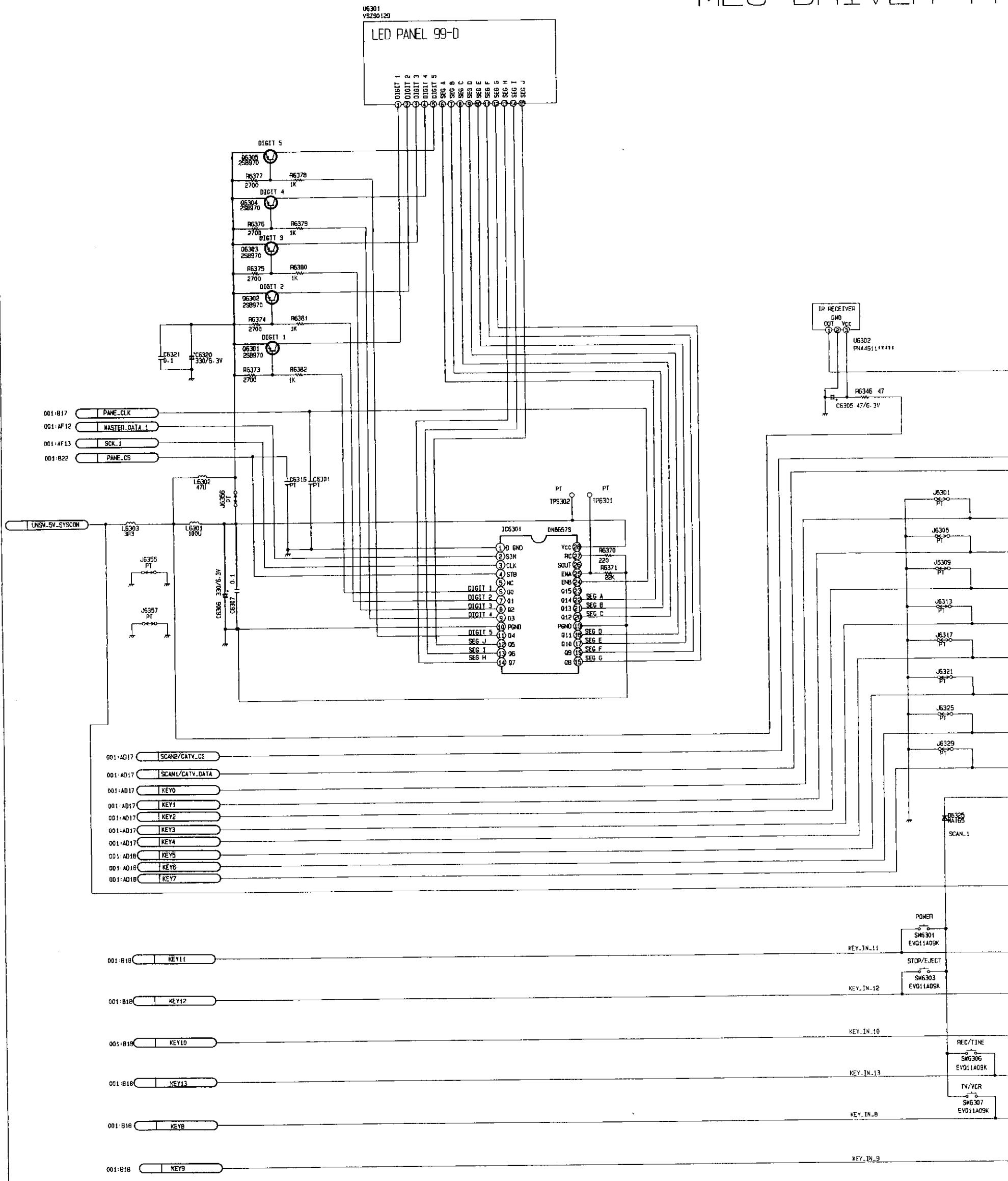

PANEL TYPE

| | 99PANA_A | 99PANA_B | 99_GE |
|--------|------------|----------|------------|
| SW6301 | POWER | # --- | --- |
| SW6302 | --- | --- | --- |
| SW6303 | STOP/EJECT | --- | --- |
| SW6304 | --- | --- | POWER |
| SW6305 | --- | # --- | TV/VCR |
| SW6306 | REC/TIME | --- | CH.DOWN |
| SW6307 | TV/VCR | REC/TIME | CH.UP |
| SW6308 | --- | TV/VCR | --- |
| SW6309 | CH.DOWN | CH.DOWN | --- |
| SW6310 | --- | --- | --- |
| SW6311 | CH.UP | CH.UP | REC |
| SW6312 | --- | --- | STOP/EJECT |
| SW6313 | REW | # --- | --- |
| SW6314 | PLAY | # --- | REW |
| SW6315 | --- | # --- | PLAY/PAUSE |
| SW6316 | FF | # --- | FWD |
| J6351 | | ○ | |
| J6352 | ○ | | ○ |

| | 99PANA_A | 99PANA_B |
|--------|------------|----------|
| SW6301 | POWER | # --- |
| SW6302 | --- | --- |
| SW6303 | STOP/EJECT | # --- |
| SW6304 | --- | --- |
| SW6305 | CH.DOWN | # --- |
| SW6306 | CH.UP | # --- |
| SW6307 | --- | --- |
| SW6308 | --- | --- |
| SW6309 | --- | --- |
| SW6310 | TV/VCR | TV/VCR |
| SW6311 | --- | --- |
| SW6312 | REW | REW |
| SW6313 | PLAY | PLAY |
| SW6314 | FF | FF |
| SW6315 | REC/TIME | REC/TIME |
| SW6316 | --- | --- |
| J6351 | | |
| J6352 | ○ | ○ |

| | FF | DPH | FTF |
|-------|-------------|-------------|---------|
| J6302 | HIFI | HIFI | HIFI |
| J6303 | 4HD | FIP-D | 4HD |
| J6306 | --- | VCRH | --- |
| J6307 | --- | VCRH | --- |
| J6310 | LINE2 | LINE2 | LINE2 |
| J6311 | SPATIALIZER | SPATIALIZER | --- |
| J6314 | 99PANA.A/B | 99PANA.A/B | --- |
| J6315 | PX | PX | --- |
| J6318 | --- | ALL.SET | --- |
| J6319 | --- | PCI | --- |
| J6322 | --- | --- | --- |
| J6323 | --- | TOOL | 99GE |
| J6326 | TNR.DBG | TNR.DBG | TNR.DBG |
| J6327 | --- | --- | --- |
| J6330 | --- | --- | --- |
| J6332 | --- | --- | --- |

IR_DATA 001:AF13

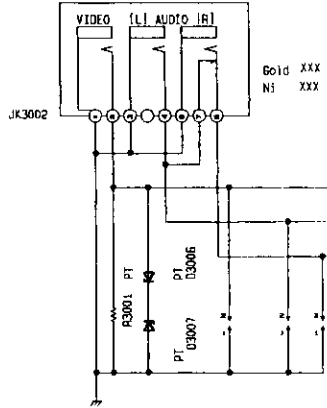
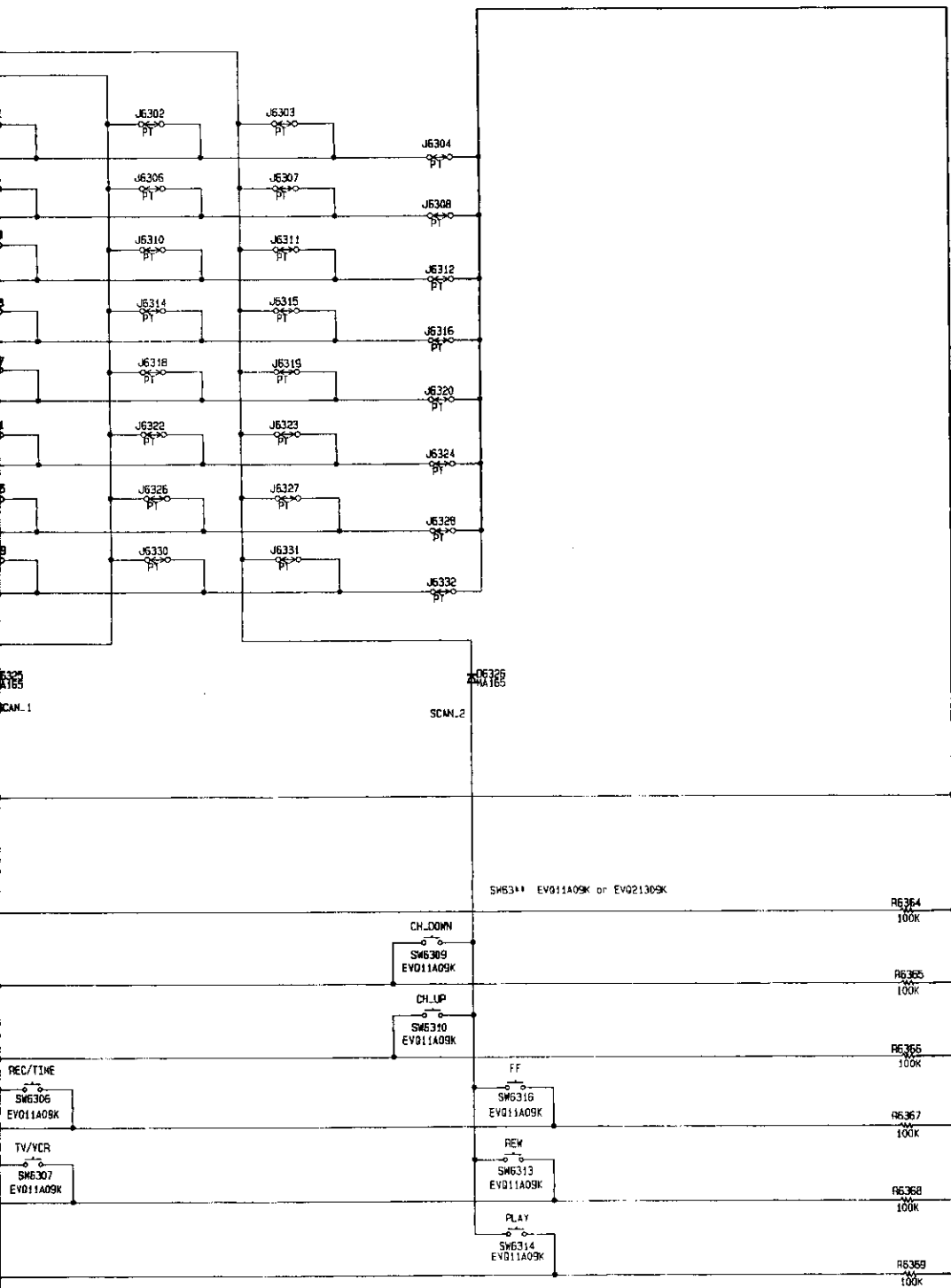

DRAWING NO. 3

11A/1/3

| P6321 | PT |
|-------|------------|
| 7 | scan.1 |
| 6 | keyin.11 |
| 5 | keyin.10 |
| 4 | VIDEO.IN.2 |
| 3 | AV.GND |
| 2 | AUDIO.IN.2 |
| 1 | AUDIO.IN.1 |

| P6322 | PT | RIGHT J-OP |
|-------|----------|------------|
| 7 | keyin.9 | VJ50869 |
| 6 | scan.2 | |
| 5 | keyin.8 | |
| 4 | keyin.13 | |
| 3 | keyin.10 | |
| 2 | keyin.12 | |
| 1 | keyin.11 | |

| | 99PANA_A | 99PANA_B | 99_GE | 99_RA | 99_PB |
|--------|------------|----------|------------|------------|------------|
| SW6301 | POWER | --- | --- | --- | --- |
| SW6302 | --- | --- | --- | --- | --- |
| SW6303 | STOP/EJECT | --- | --- | --- | --- |
| SW6304 | --- | --- | POWER | POWER | --- |
| SW6305 | --- | --- | TV/VCR | TV/VCR | --- |
| SW6306 | REC/TIME | --- | CH.DOWN | CH.DOWN | --- |
| SW6307 | TV/VCR | --- | CH.UP | CH.UP | --- |
| SW6308 | --- | TV/VCR | --- | --- | CH.DOWN |
| SW6309 | CH.DOWN | CH.DOWN | --- | --- | --- |
| SW6310 | --- | --- | --- | --- | --- |
| SW6311 | CH.UP | CH.UP | REC | REC | TAPE SPEED |
| SW6312 | --- | --- | STOP/EJECT | REW | STOP/EJECT |
| SW6313 | REW | --- | --- | PLAY | REC |
| SW6314 | PLAY | --- | REW | FWD | REW |
| SW6315 | --- | --- | PLAY/PAUSE | STOP/EJECT | PLAY |
| SW6316 | FF | --- | FWD | --- | FWD |
| J6351 | | | | | |
| J6352 | | | | | |

| | 99PANA_A | 99PANA_B | | |
|--------|------------|----------|--|--|
| SW6301 | POWER | --- | | |
| SW6302 | --- | --- | | |
| SW6303 | STOP/EJECT | --- | | |
| SW6304 | --- | --- | | |
| SW6305 | CH.DOWN | --- | | |
| SW6306 | CH.UP | --- | | |
| SW6307 | --- | --- | | |
| SW6308 | --- | --- | | |
| SW6309 | --- | --- | | |
| SW6310 | TV/VCR | TV/VCR | | |
| SW6311 | --- | --- | | |
| SW6312 | REW | REW | | |
| SW6313 | PLAY | PLAY | | |
| SW6314 | FF | FF | | |
| SW6315 | REC/TIME | REC/TIME | | |
| SW6316 | --- | --- | | |
| J6351 | | | | |
| J6352 | | | | |

| | FPF | GFH | FTF | GTJ |
|-------|-------------|-------------|---------|----------|
| J6302 | HIFI | HIFI | HIFI | HIFI |
| J6303 | 4HD | FIP-D | 4HD | --- |
| J6306 | --- | VCRH | --- | VCRH |
| J6307 | --- | VCRH | --- | VCRH |
| J6310 | LINE2 | LINE2 | LINE2 | LINE2 |
| J6311 | SPATIALIZER | SPATIALIZER | --- | --- |
| J6314 | SPANA_A/B | SPANA_A/B | --- | AUTO.REP |
| J6315 | PX | PX | --- | B.SET |
| J6318 | --- | ALL.SET | --- | --- |
| J6319 | --- | PCI | --- | --- |
| J6322 | --- | --- | --- | --- |
| J6323 | --- | TOOL | 99GE | --- |
| J6326 | TNR.D86 | TNR.D85 | TNR.D86 | TNR.D86 |
| J6327 | --- | --- | --- | --- |
| J6330 | --- | --- | --- | --- |
| J6332 | --- | --- | --- | --- |

IR_DATA 001:AF13

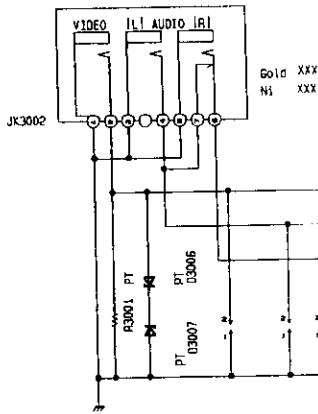
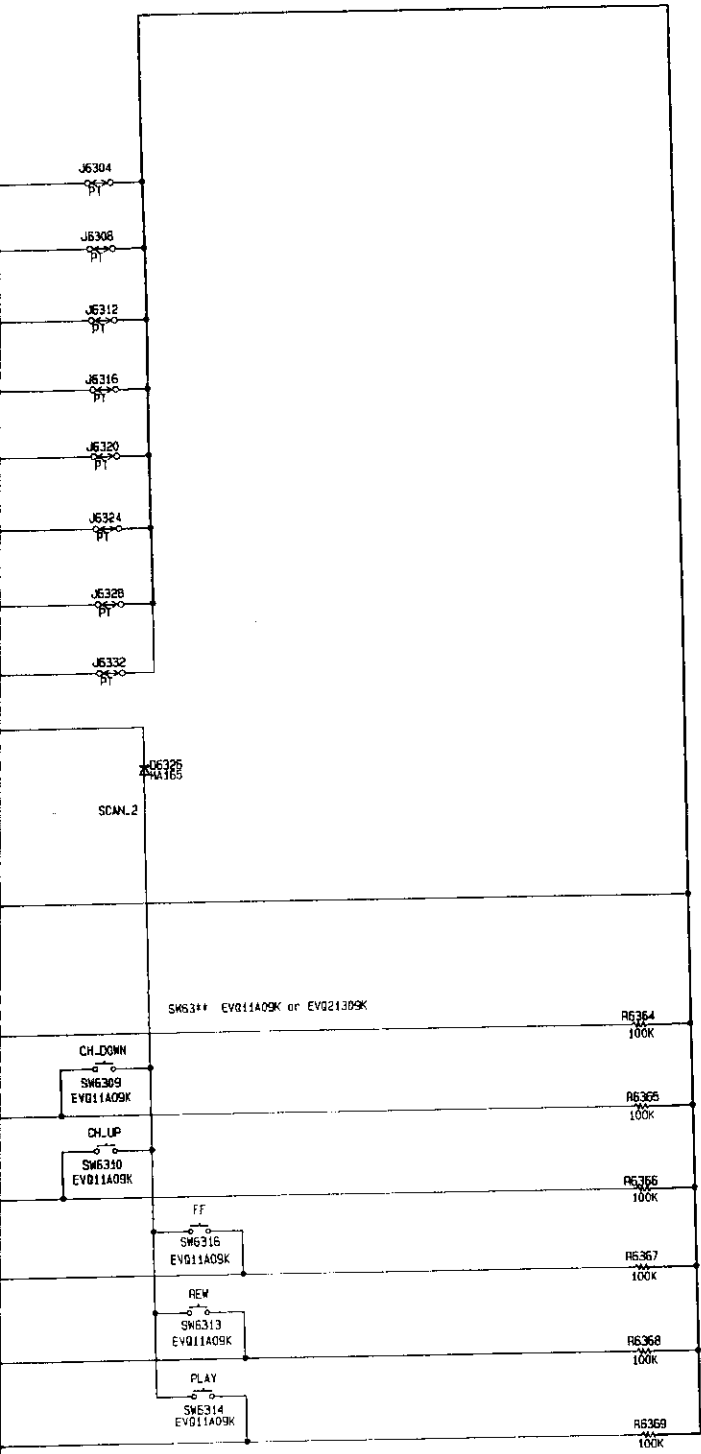

DRAWING NO. 3

11A/1/3

| Pin | Label |
|-----|-------------|
| 7 | scan.1 |
| 6 | keyin.11 |
| 5 | keyin.10 |
| 4 | VIDEO_IN.2 |
| 3 | AV_GND |
| 2 | AUDIO_IN2_R |
| 1 | AUDIO_IN2_L |

| Pin | Label |
|-----|----------|
| 7 | keyin.9 |
| 6 | scan.2 |
| 5 | keyin.8 |
| 4 | keyin.13 |
| 3 | keyin.10 |
| 2 | keyin.12 |
| 1 | keyin.11 |

| Pin | Label |
|-----|-------------|
| 14 | AUDIO_IN2_L |
| 13 | AV_GND |
| 12 | AUDIO_IN2_R |
| 11 | VIDEO_IN2 |
| 10 | CATV_SEK |
| 9 | keyin.8 |
| 8 | scan2 |
| 7 | keyin.12 |
| 6 | keyin.13 |
| 5 | keyin.11 |
| 4 | scan.1 |
| 3 | keyin.10 |
| 2 | CATV_DATA |
| 1 | CATV_CS |
| 17 | UNSW 5V |
| 16 | UNSW 14V |
| 15 | GND |

Drawing No. _____
 Item **MAIN-3**
 Part No. _____
 Application Model **KG-19series**
 Date of Issue **JUL-15-98** Drawn by **Y. SAIKI**
 V6060-003

R : 2012
 C : 2012
 CC : KA
 L : PD

UNSW_14V #refL CATV_CLK #refL

KG-20 MAIN 4 Hi-Fi MTS

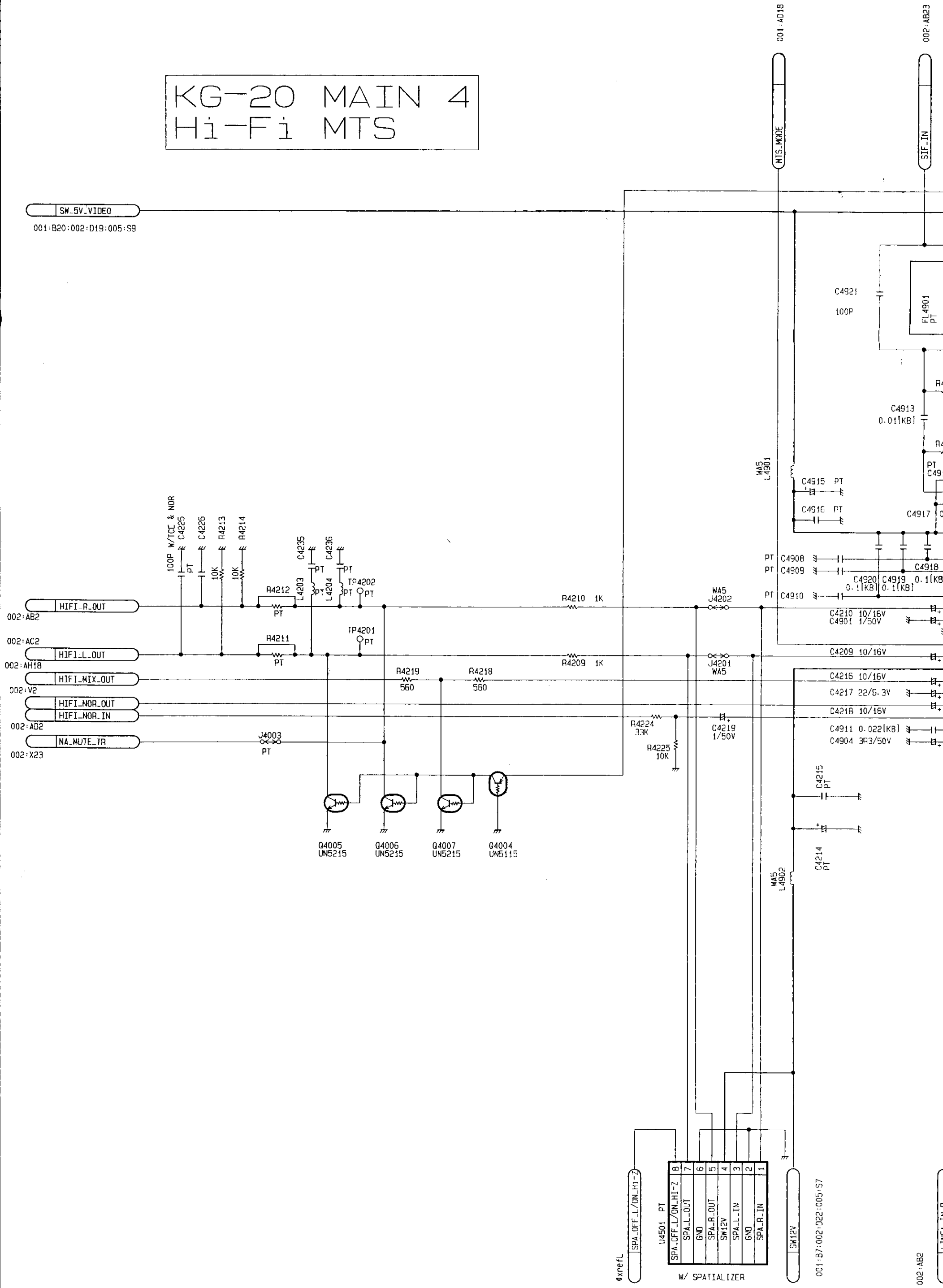

SW_5V_VIDEO
001:B20:002:D19:005:S9

HIFI_R_OUT
002:AB2
HIFI_L_OUT
002:AC2
HIFI_MIX_OUT
002:AH18
HIFI_NOR_OUT
002:V2
HIFI_NOR_IN
002:AD2
NA_MUTE_TR
002:X23

001:AD18
MTS-MODE

002:AB23
SIF-IN

0xrefL
SPA_OFF_L/ON_HI-Z

| | |
|-------------------|---|
| SPA_OFF_L/ON_HI-Z | 8 |
| SPA_L-OUT | 7 |
| GND | 6 |
| SPA_R-OUT | 5 |
| SW12V | 4 |
| SPA_L-IN | 3 |
| GND | 2 |
| SPA_R-IN | 1 |

W/ SPATIALIZER

001:B7:002:D22:005:S7
SW12V

002:AB2

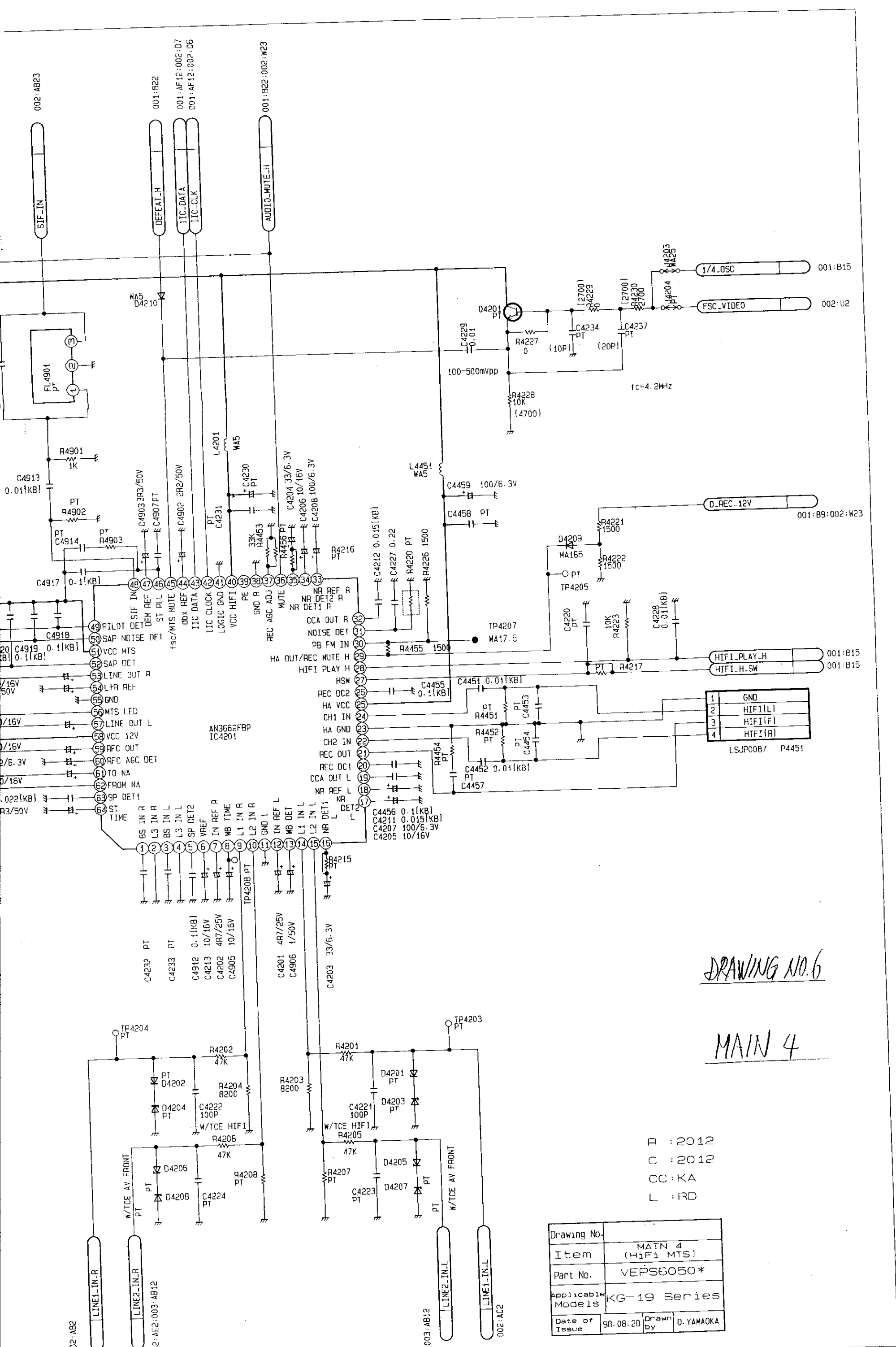

DRAWING NO.6

MAIN 4

R : 2012
 C : 2012
 CC : KA
 L : RD

| | | |
|-------------------|-------------------|---------------------|
| Drawing No. | | |
| Item | MAIN 4 (HiFi MTS) | |
| Part No. | VEPS6050* | |
| Applicable Models | KG-19 Series | |
| Date of Issue | 98.08.28 | Drawn by O. YAMAOKA |

RF Converter Circuit

RF DEMODUL

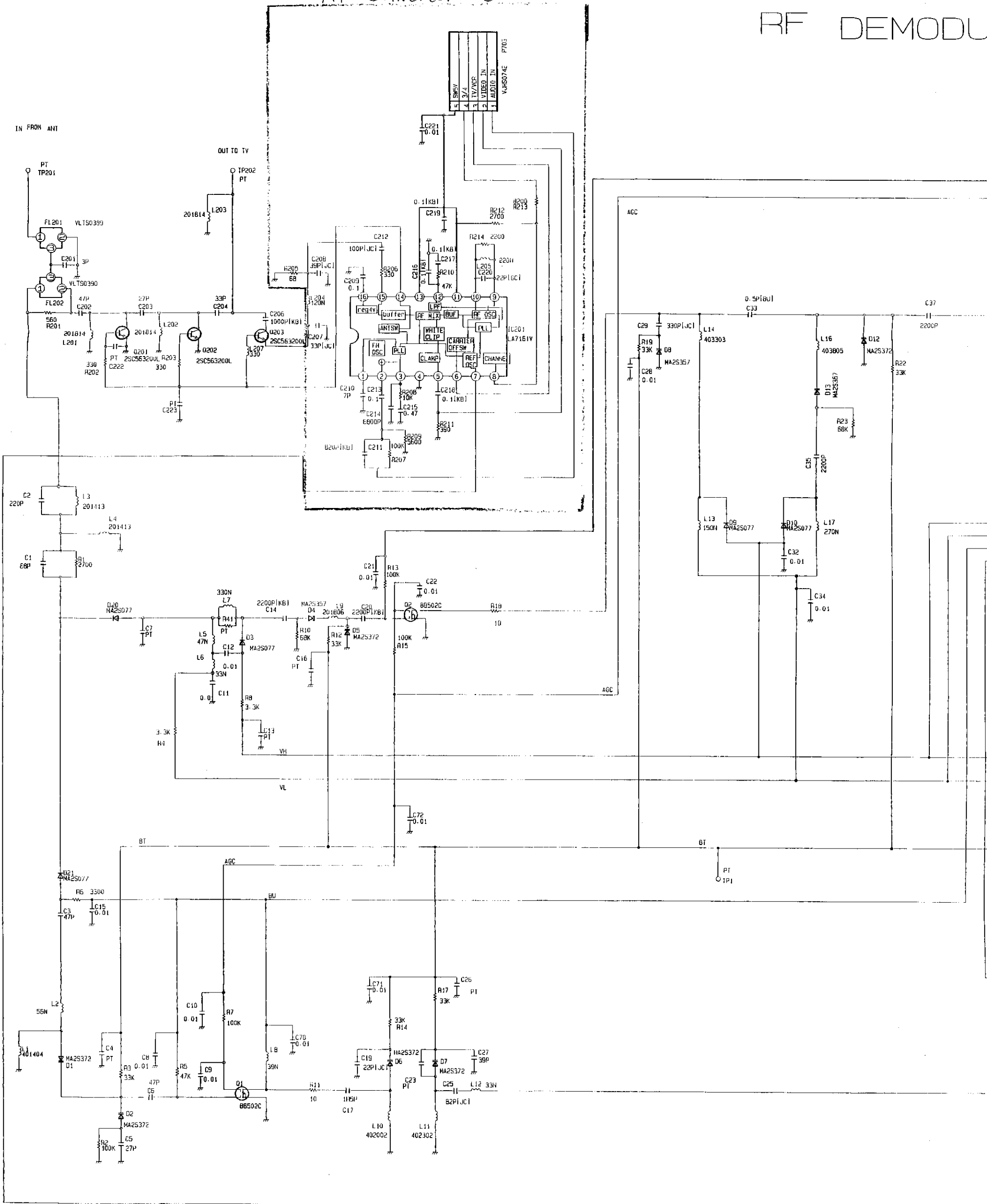

MODULATOR

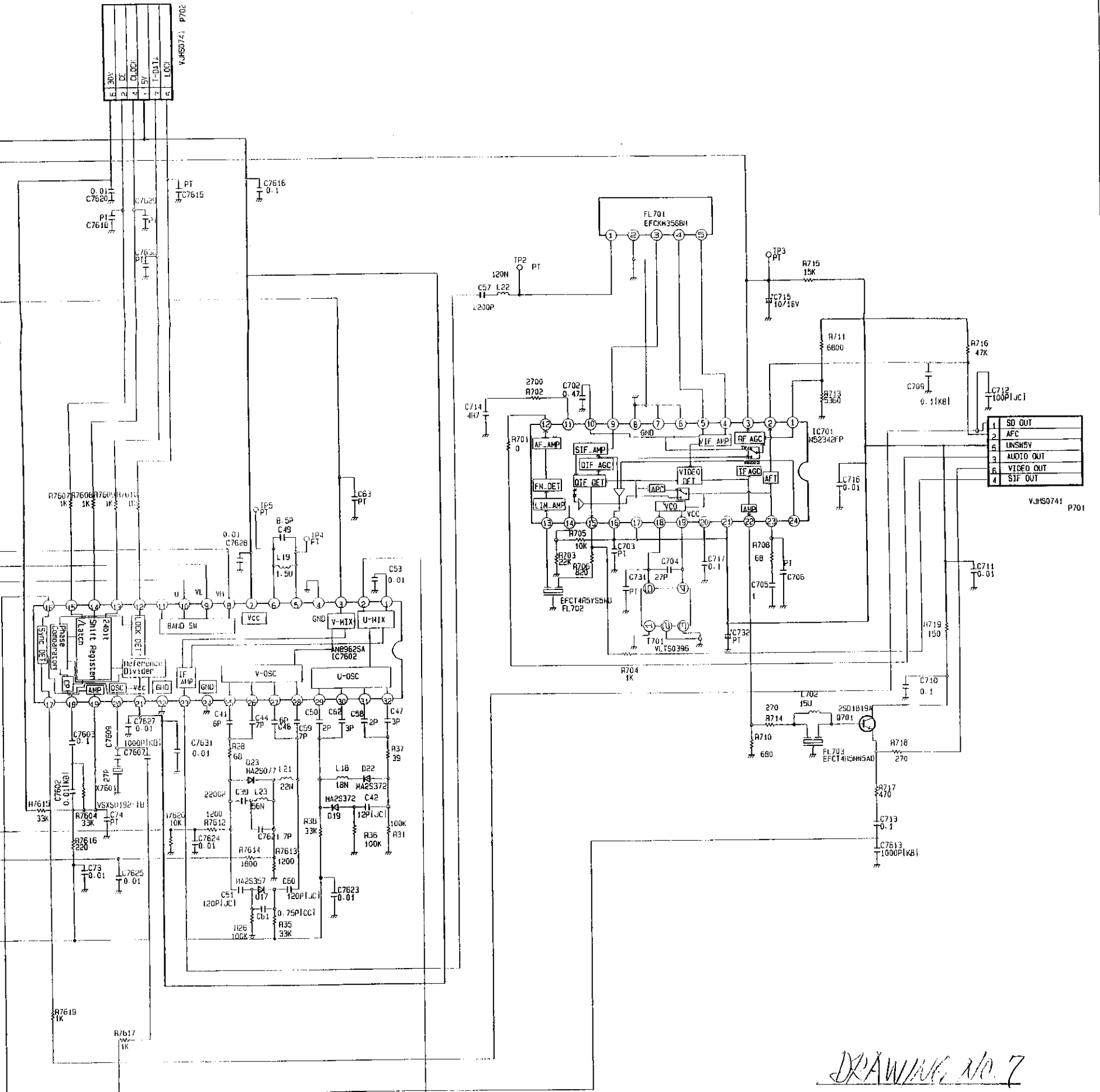

DRAWING NO. 7
TUNING

| △ | Date | 接通No. | Name |
|---|------|-------|------|
| | | | |
| | | | |
| | | | |
| | | | |
| | | | |
| | | | |
| | | | |
| | | | |
| | | | |
| | | | |

| REF. NO. | SERIES |
|----------|--------------|
| LAST NO. | NOT USED NO. |
| | |
| | |
| | |
| | |
| | |
| | |
| | |
| | |
| | |
| | |

| △ | Date | 接通No. | Name |
|---|------|-------|------|
| | | | |
| | | | |
| | | | |
| | | | |
| | | | |
| | | | |
| | | | |
| | | | |
| | | | |
| | | | |

| | |
|-------------------|----------------|
| Drawing No. | |
| Item | RF DEMODULATOR |
| Part No. | VE050614M |
| Applicable Models | K8-20 |
| Date of Issue | 99/8/23 |
| Drawn by | KANAHARA |

MASTER HC 100.4

KG-20 Hi-Fi 4HEAD AMP

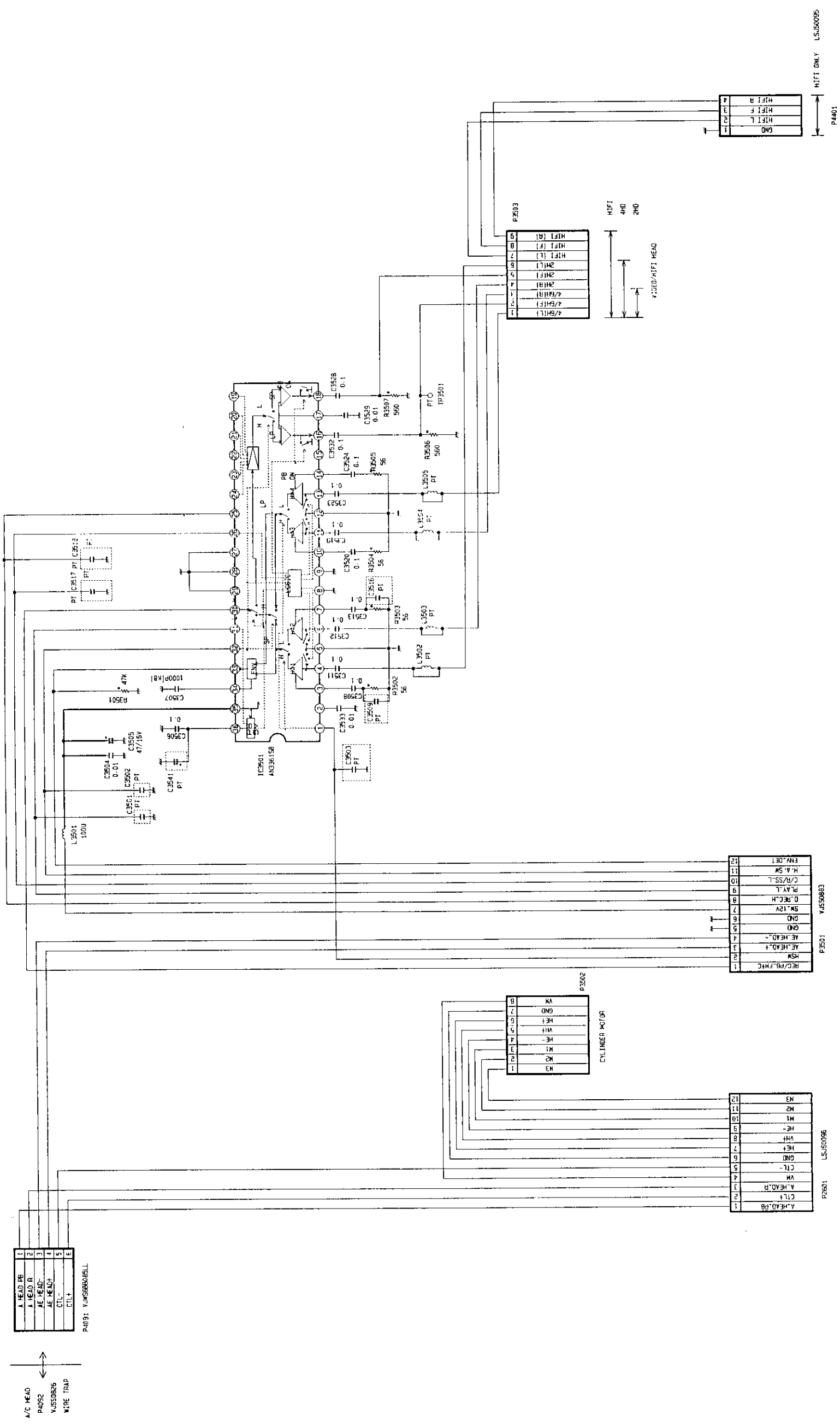

| | |
|---|-----------|
| 1 | A/HEAD PB |
| 2 | A/HEAD R |
| 3 | A/HEAD L |
| 4 | A/HEAD |
| 5 | CTL- |
| 6 | CTL+ |

P4092 YUKIGAWA/BELL

A/C HEAD
P4092
YUKIGAWA
WIRE TRAP

| | |
|-----|----|
| 1 | M3 |
| 2 | M2 |
| 3 | M1 |
| 4 | M0 |
| 5 | MH |
| 6 | MH |
| 7 | MH |
| 8 | MH |
| 9 | MH |
| 10 | MH |
| 11 | MH |
| 12 | MH |
| 13 | MH |
| 14 | MH |
| 15 | MH |
| 16 | MH |
| 17 | MH |
| 18 | MH |
| 19 | MH |
| 20 | MH |
| 21 | MH |
| 22 | MH |
| 23 | MH |
| 24 | MH |
| 25 | MH |
| 26 | MH |
| 27 | MH |
| 28 | MH |
| 29 | MH |
| 30 | MH |
| 31 | MH |
| 32 | MH |
| 33 | MH |
| 34 | MH |
| 35 | MH |
| 36 | MH |
| 37 | MH |
| 38 | MH |
| 39 | MH |
| 40 | MH |
| 41 | MH |
| 42 | MH |
| 43 | MH |
| 44 | MH |
| 45 | MH |
| 46 | MH |
| 47 | MH |
| 48 | MH |
| 49 | MH |
| 50 | MH |
| 51 | MH |
| 52 | MH |
| 53 | MH |
| 54 | MH |
| 55 | MH |
| 56 | MH |
| 57 | MH |
| 58 | MH |
| 59 | MH |
| 60 | MH |
| 61 | MH |
| 62 | MH |
| 63 | MH |
| 64 | MH |
| 65 | MH |
| 66 | MH |
| 67 | MH |
| 68 | MH |
| 69 | MH |
| 70 | MH |
| 71 | MH |
| 72 | MH |
| 73 | MH |
| 74 | MH |
| 75 | MH |
| 76 | MH |
| 77 | MH |
| 78 | MH |
| 79 | MH |
| 80 | MH |
| 81 | MH |
| 82 | MH |
| 83 | MH |
| 84 | MH |
| 85 | MH |
| 86 | MH |
| 87 | MH |
| 88 | MH |
| 89 | MH |
| 90 | MH |
| 91 | MH |
| 92 | MH |
| 93 | MH |
| 94 | MH |
| 95 | MH |
| 96 | MH |
| 97 | MH |
| 98 | MH |
| 99 | MH |
| 100 | MH |

P3502
CYLINDER MOTOR

| | |
|----|-----------|
| 1 | A/HEAD PB |
| 2 | CTL+ |
| 3 | A/HEAD R |
| 4 | M |
| 5 | CTL- |
| 6 | GND |
| 7 | VH |
| 8 | MH |
| 9 | MH |
| 10 | MH |
| 11 | M2 |
| 12 | M3 |

P3501 LSJ50096

| | |
|----|------------|
| 1 | REC/PB/PHC |
| 2 | MSW |
| 3 | A/HEAD L |
| 4 | A/HEAD R |
| 5 | GND |
| 6 | SM 12V |
| 7 | D.MECH |
| 8 | PLAY L |
| 9 | C/H/SSL |
| 10 | H.A.SW |
| 11 | ENV.DET |

P3501 YJSS0883

| | |
|-----|---------|
| 1 | A/SHILL |
| 2 | A/SHILL |
| 3 | SHR |
| 4 | SHR |
| 5 | SHR |
| 6 | SHR |
| 7 | SHR |
| 8 | SHR |
| 9 | SHR |
| 10 | SHR |
| 11 | SHR |
| 12 | SHR |
| 13 | SHR |
| 14 | SHR |
| 15 | SHR |
| 16 | SHR |
| 17 | SHR |
| 18 | SHR |
| 19 | SHR |
| 20 | SHR |
| 21 | SHR |
| 22 | SHR |
| 23 | SHR |
| 24 | SHR |
| 25 | SHR |
| 26 | SHR |
| 27 | SHR |
| 28 | SHR |
| 29 | SHR |
| 30 | SHR |
| 31 | SHR |
| 32 | SHR |
| 33 | SHR |
| 34 | SHR |
| 35 | SHR |
| 36 | SHR |
| 37 | SHR |
| 38 | SHR |
| 39 | SHR |
| 40 | SHR |
| 41 | SHR |
| 42 | SHR |
| 43 | SHR |
| 44 | SHR |
| 45 | SHR |
| 46 | SHR |
| 47 | SHR |
| 48 | SHR |
| 49 | SHR |
| 50 | SHR |
| 51 | SHR |
| 52 | SHR |
| 53 | SHR |
| 54 | SHR |
| 55 | SHR |
| 56 | SHR |
| 57 | SHR |
| 58 | SHR |
| 59 | SHR |
| 60 | SHR |
| 61 | SHR |
| 62 | SHR |
| 63 | SHR |
| 64 | SHR |
| 65 | SHR |
| 66 | SHR |
| 67 | SHR |
| 68 | SHR |
| 69 | SHR |
| 70 | SHR |
| 71 | SHR |
| 72 | SHR |
| 73 | SHR |
| 74 | SHR |
| 75 | SHR |
| 76 | SHR |
| 77 | SHR |
| 78 | SHR |
| 79 | SHR |
| 80 | SHR |
| 81 | SHR |
| 82 | SHR |
| 83 | SHR |
| 84 | SHR |
| 85 | SHR |
| 86 | SHR |
| 87 | SHR |
| 88 | SHR |
| 89 | SHR |
| 90 | SHR |
| 91 | SHR |
| 92 | SHR |
| 93 | SHR |
| 94 | SHR |
| 95 | SHR |
| 96 | SHR |
| 97 | SHR |
| 98 | SHR |
| 99 | SHR |
| 100 | SHR |

P3503

HIFI
4HD
2HD
VJSS0883 HEAD

| | |
|-----|--------|
| 1 | GND |
| 2 | HIFI L |
| 3 | HIFI R |
| 4 | HIFI |
| 5 | HIFI |
| 6 | HIFI |
| 7 | HIFI |
| 8 | HIFI |
| 9 | HIFI |
| 10 | HIFI |
| 11 | HIFI |
| 12 | HIFI |
| 13 | HIFI |
| 14 | HIFI |
| 15 | HIFI |
| 16 | HIFI |
| 17 | HIFI |
| 18 | HIFI |
| 19 | HIFI |
| 20 | HIFI |
| 21 | HIFI |
| 22 | HIFI |
| 23 | HIFI |
| 24 | HIFI |
| 25 | HIFI |
| 26 | HIFI |
| 27 | HIFI |
| 28 | HIFI |
| 29 | HIFI |
| 30 | HIFI |
| 31 | HIFI |
| 32 | HIFI |
| 33 | HIFI |
| 34 | HIFI |
| 35 | HIFI |
| 36 | HIFI |
| 37 | HIFI |
| 38 | HIFI |
| 39 | HIFI |
| 40 | HIFI |
| 41 | HIFI |
| 42 | HIFI |
| 43 | HIFI |
| 44 | HIFI |
| 45 | HIFI |
| 46 | HIFI |
| 47 | HIFI |
| 48 | HIFI |
| 49 | HIFI |
| 50 | HIFI |
| 51 | HIFI |
| 52 | HIFI |
| 53 | HIFI |
| 54 | HIFI |
| 55 | HIFI |
| 56 | HIFI |
| 57 | HIFI |
| 58 | HIFI |
| 59 | HIFI |
| 60 | HIFI |
| 61 | HIFI |
| 62 | HIFI |
| 63 | HIFI |
| 64 | HIFI |
| 65 | HIFI |
| 66 | HIFI |
| 67 | HIFI |
| 68 | HIFI |
| 69 | HIFI |
| 70 | HIFI |
| 71 | HIFI |
| 72 | HIFI |
| 73 | HIFI |
| 74 | HIFI |
| 75 | HIFI |
| 76 | HIFI |
| 77 | HIFI |
| 78 | HIFI |
| 79 | HIFI |
| 80 | HIFI |
| 81 | HIFI |
| 82 | HIFI |
| 83 | HIFI |
| 84 | HIFI |
| 85 | HIFI |
| 86 | HIFI |
| 87 | HIFI |
| 88 | HIFI |
| 89 | HIFI |
| 90 | HIFI |
| 91 | HIFI |
| 92 | HIFI |
| 93 | HIFI |
| 94 | HIFI |
| 95 | HIFI |
| 96 | HIFI |
| 97 | HIFI |
| 98 | HIFI |
| 99 | HIFI |
| 100 | HIFI |

P4401 HIFI ONLY LSJ50095

P4451
LSJ50087

P3551
YJSS0882
MAIN P.C.B.

P3502
LSJ50086

| | | |
|---|-------------------|--------------------|
| △ | Date | 7.7.77 |
| | Drawing No. | 7.7.77 |
| | Item | Hi-Fi 4HD HEAD AMP |
| | Part No. | YJSS0882 |
| | Applicable Models | KG-20 SERIES |
| | Date of Issue | 99/05/11 |
| | Drawn by | YAMADA |
| | Checked by | IS |
| | Issue | 15 |

DRAWING NO. C
HEAD AMP

