

External Antenna

Test Mode		Number of hopping channels	conclusion
Bluetooth	DH5	79	PASS
	2DH5	79	PASS
	3DH5	79	PASS

Hopping No. 1-DH5 2402MHz

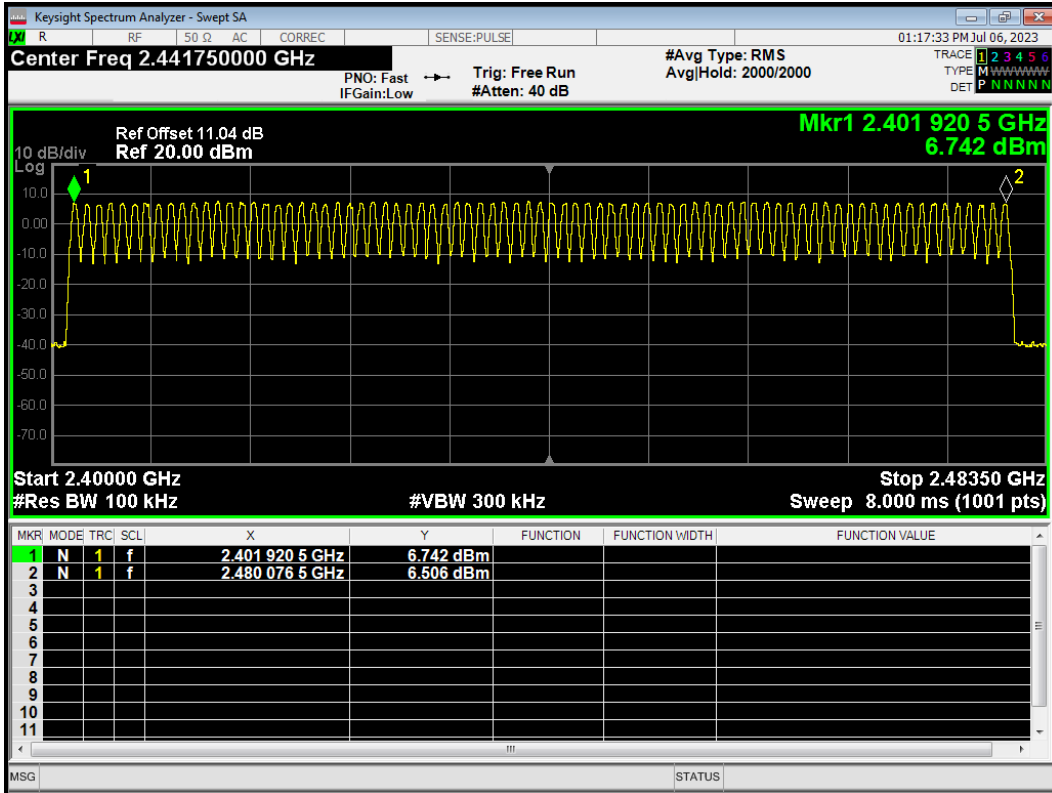

Hopping No. 2-DH5 2402MHz

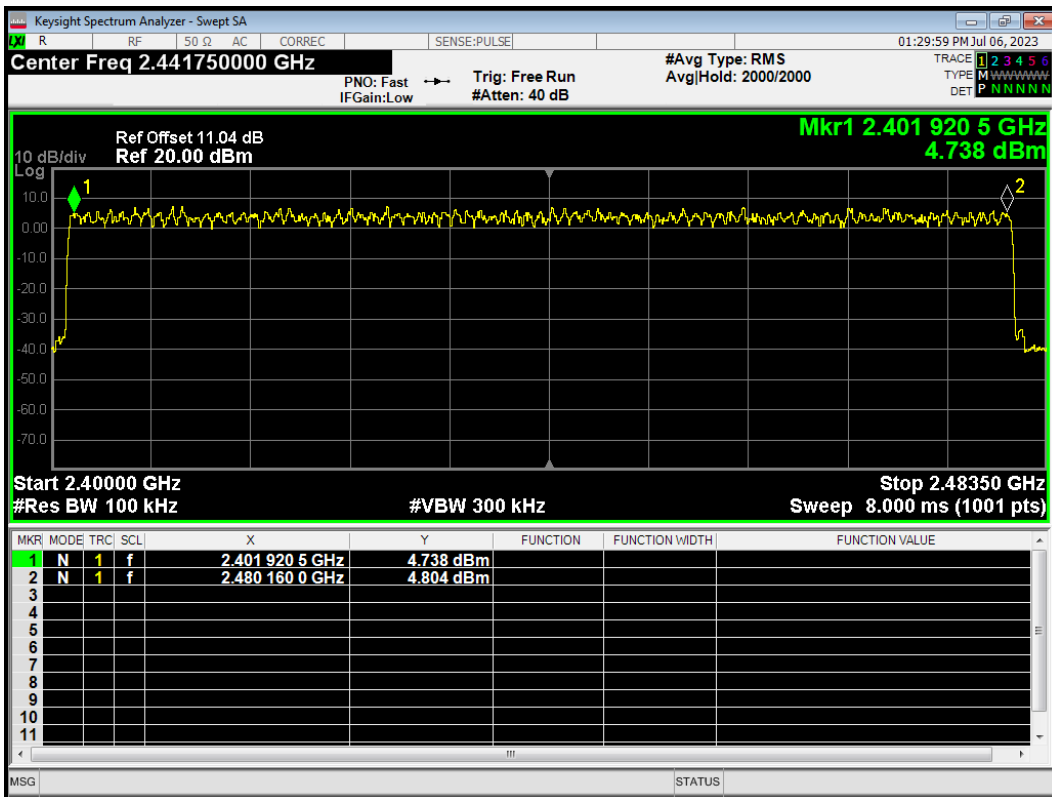

Hopping No. 3-DH5 2402MHz

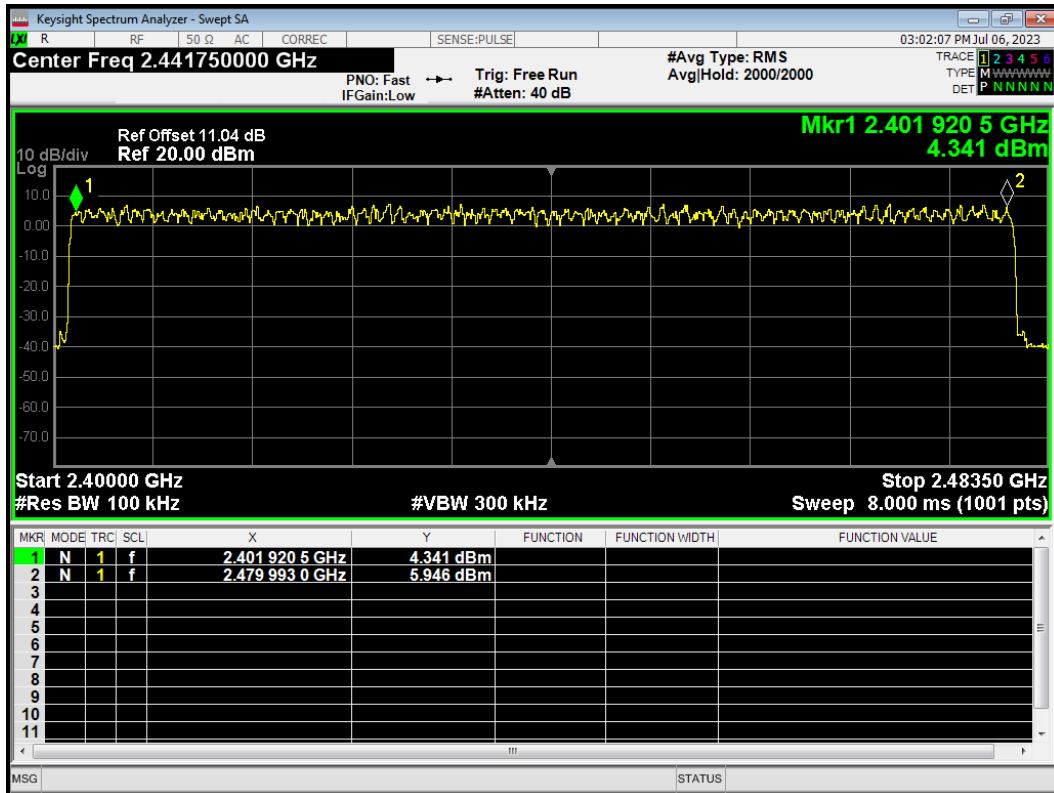

5.7 Spurious RF Conducted Emissions

Ambient condition

Temperature	Relative humidity
20°C ~ 25°C	45% ~ 50%

Method of Measurement

The EUT was connected to the spectrum analyzer and Bluetooth test set via a power splitter with a known loss. The spectrum analyzer scans from 30MHz to the 10th harmonic of the carrier. The peak detector is used. Set RBW 100kHz and VBW 300 kHz, Sweep is set to ATUO.

The test is in transmitting mode.

Test setup

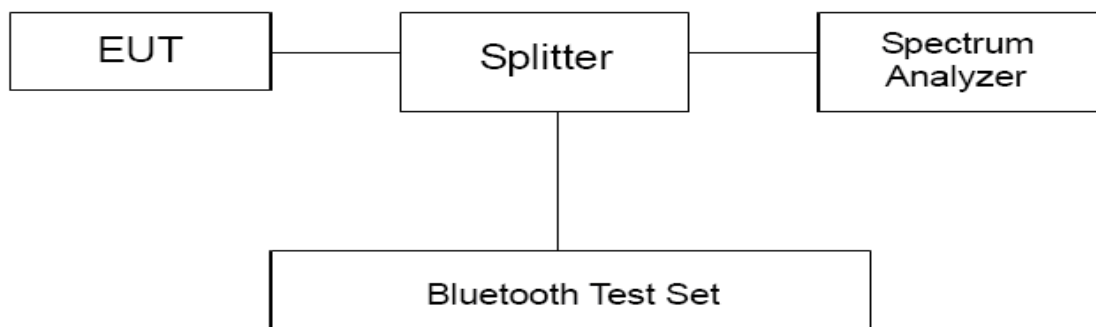

Limits

Rule Part 15.247(d) pacifies that “In any 100 kHz bandwidth outside the frequency band in which the spread spectrum intentional radiator is operating, the radio frequency power that is produced by the intentional radiator shall be at least 20 dB below that in the 100 kHz bandwidth within the band that contains the highest level of the desired power.”

Internal Antenna

Test Mode	Carrier frequency (MHz)	Reference value (dBm)	Limit
DH5	2402	6.700	-13.30
	2441	6.530	-13.47
	2480	6.270	-13.73
2DH5	2402	6.710	-13.29
	2441	6.650	-13.35
	2480	6.470	-13.53
3DH5	2402	6.820	-13.18
	2441	5.980	-14.02
	2480	6.590	-13.41

External Antenna

Test Mode	Carrier frequency (MHz)	Reference value (dBm)	Limit
DH5	2402	6.660	-13.34
	2441	6.690	-13.31
	2480	6.960	-13.04
2DH5	2402	6.560	-13.44
	2441	6.950	-13.05
	2480	7.190	-12.81
3DH5	2402	7.170	-12.83
	2441	7.110	-12.89
	2480	7.080	-12.92

Measurement Uncertainty

The assessed measurement uncertainty to ensure 95% confidence level for the normal distribution is with the coverage factor $k = 1.96$.

Frequency	Uncertainty
100kHz-2GHz	0.684 dB
2GHz-26GHz	1.407 dB

Test Results:

The signal beyond the limit is carrier.

Internal Antenna

Tx. Spurious 1-DH5 2402MHz Ref

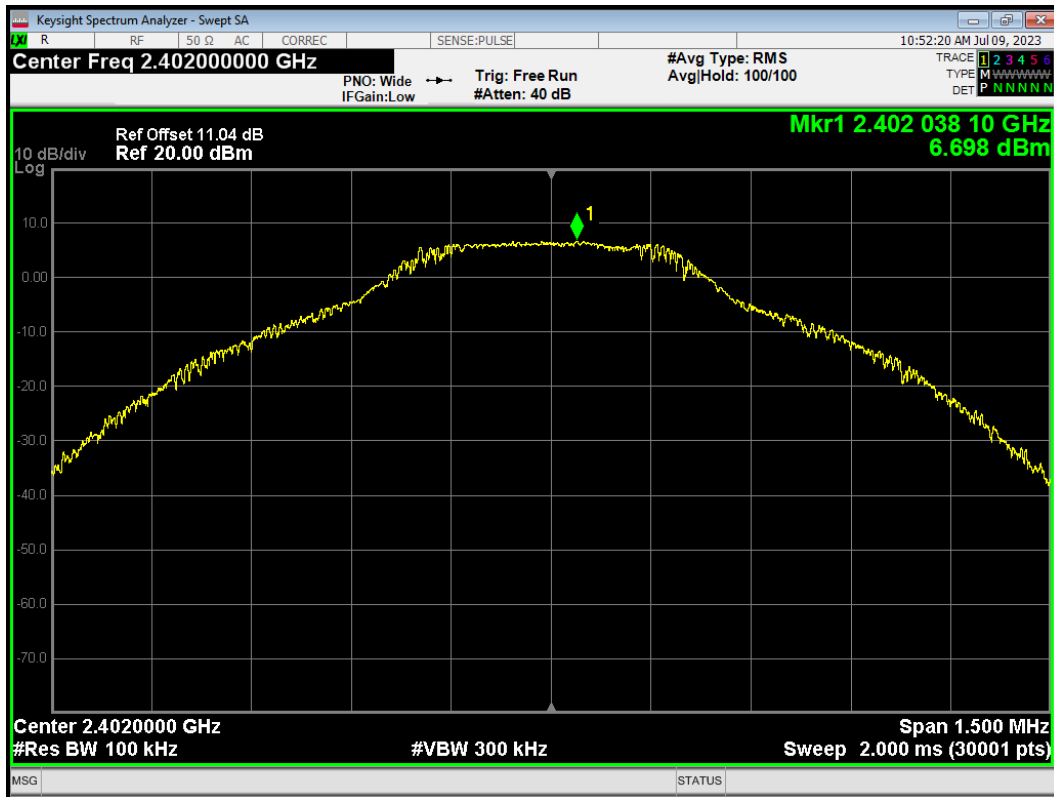

Tx. Spurious 1-DH5 2402MHz Emission

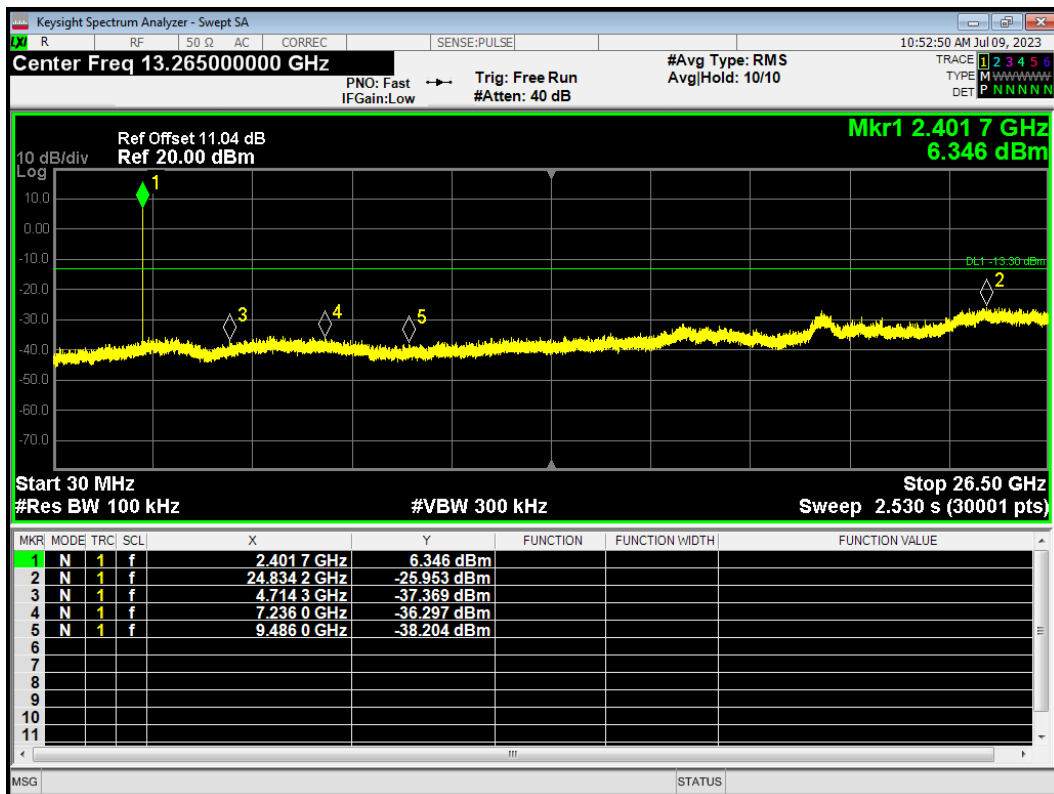

Tx. Spurious 1-DH5 2441MHz Ref

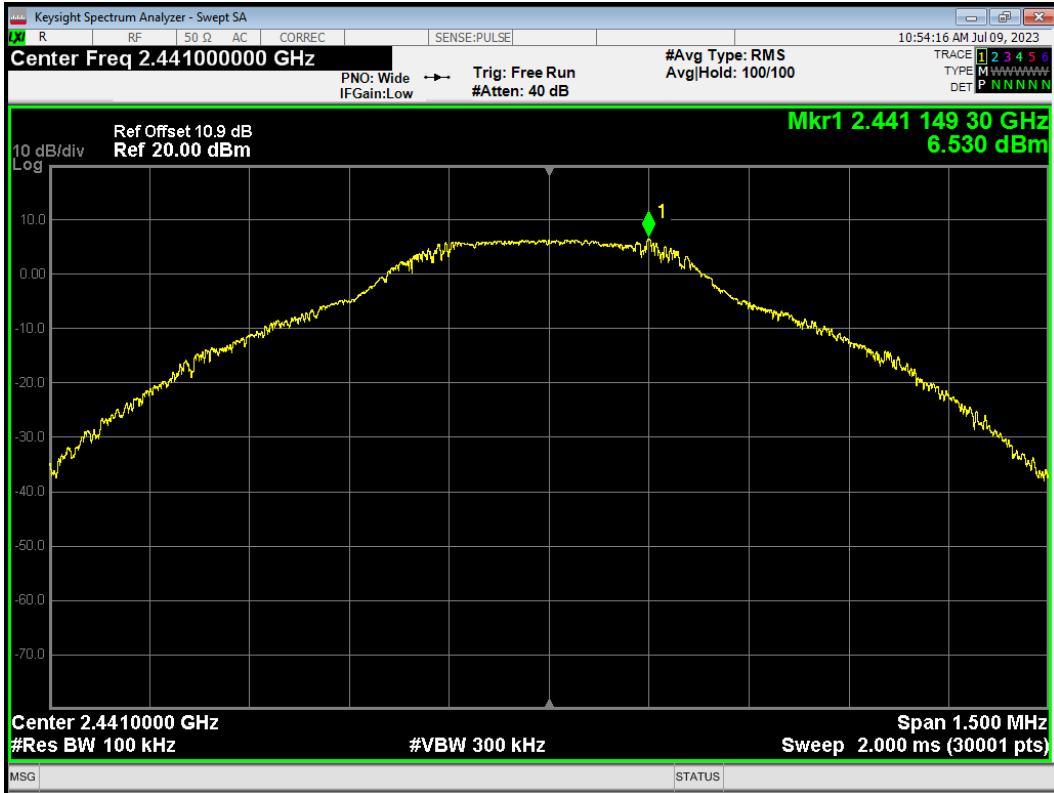

Tx. Spurious 1-DH5 2441MHz Emission

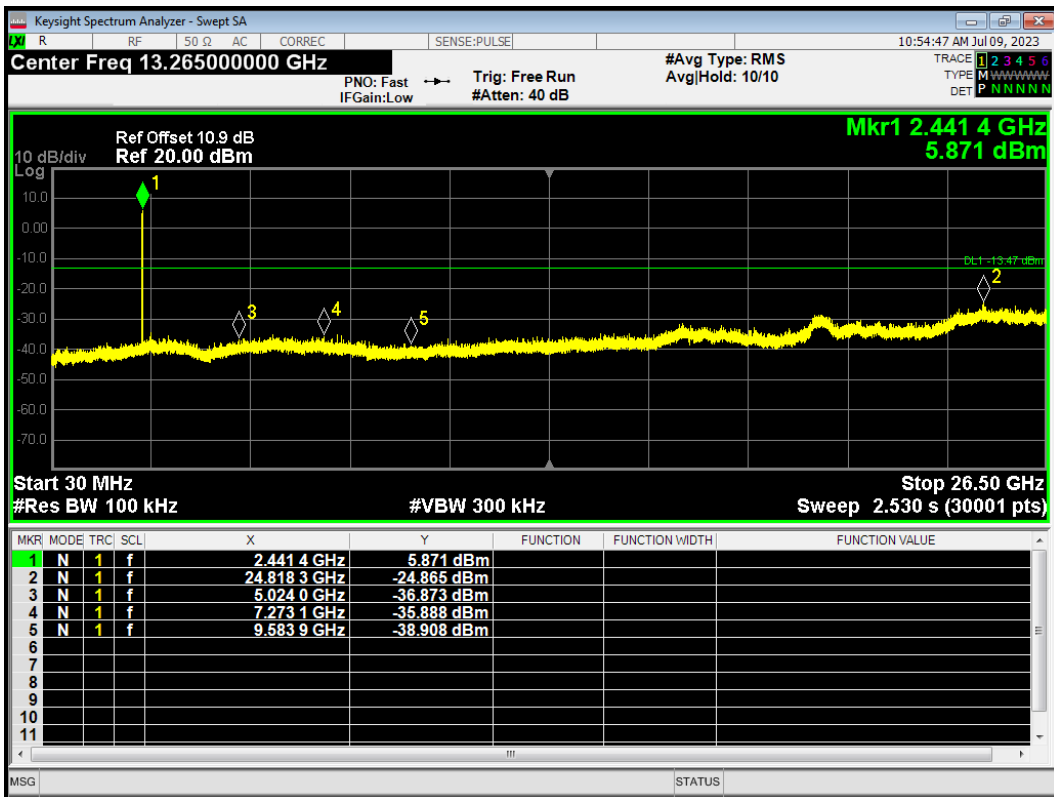

Tx. Spurious 1-DH5 2480MHz Ref

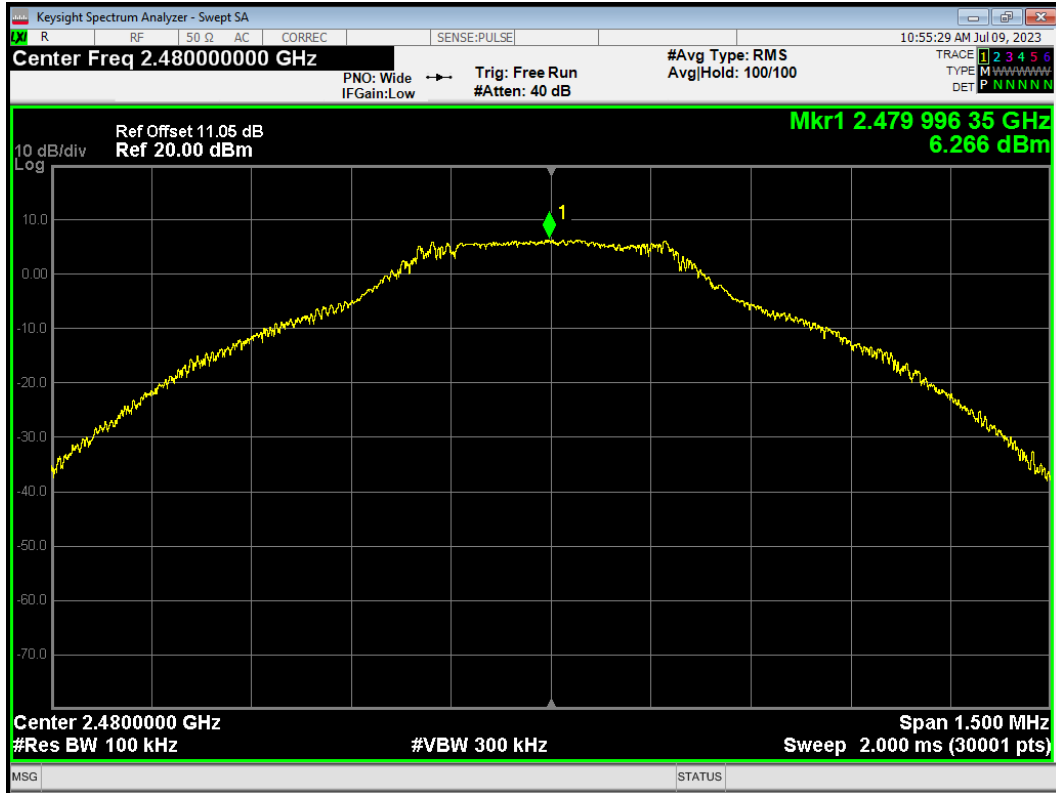

Tx. Spurious 1-DH5 2480MHz Emission

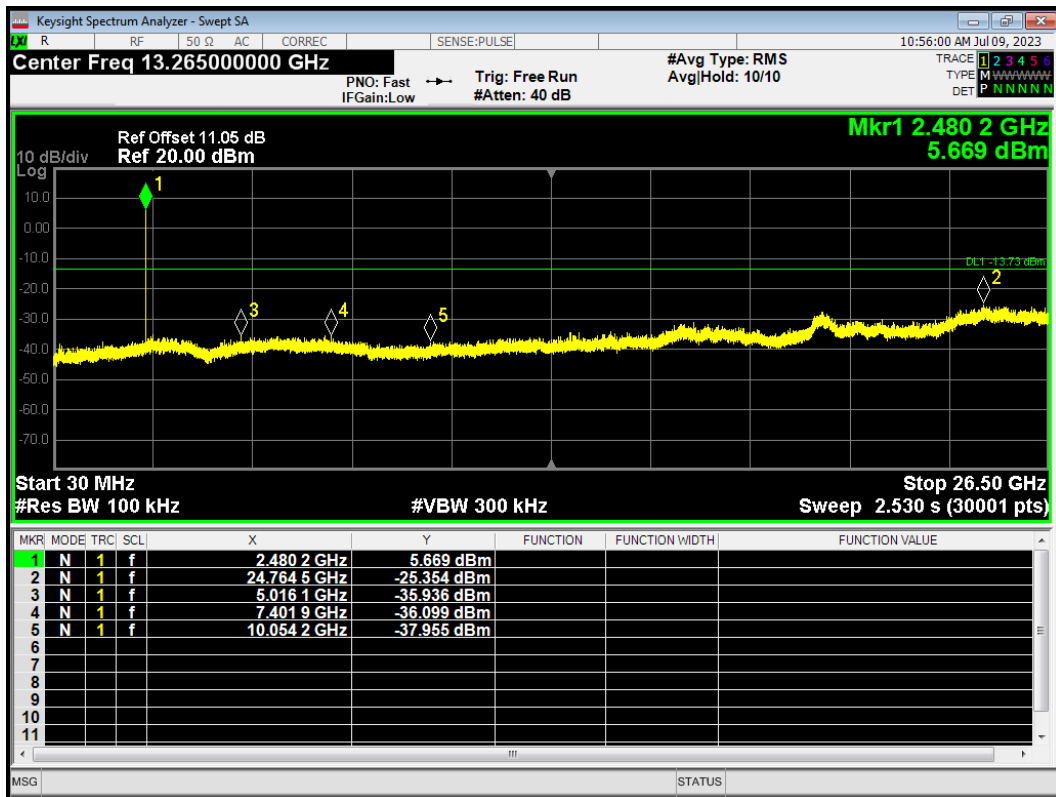

Tx. Spurious 2-DH5 2402MHz Ref

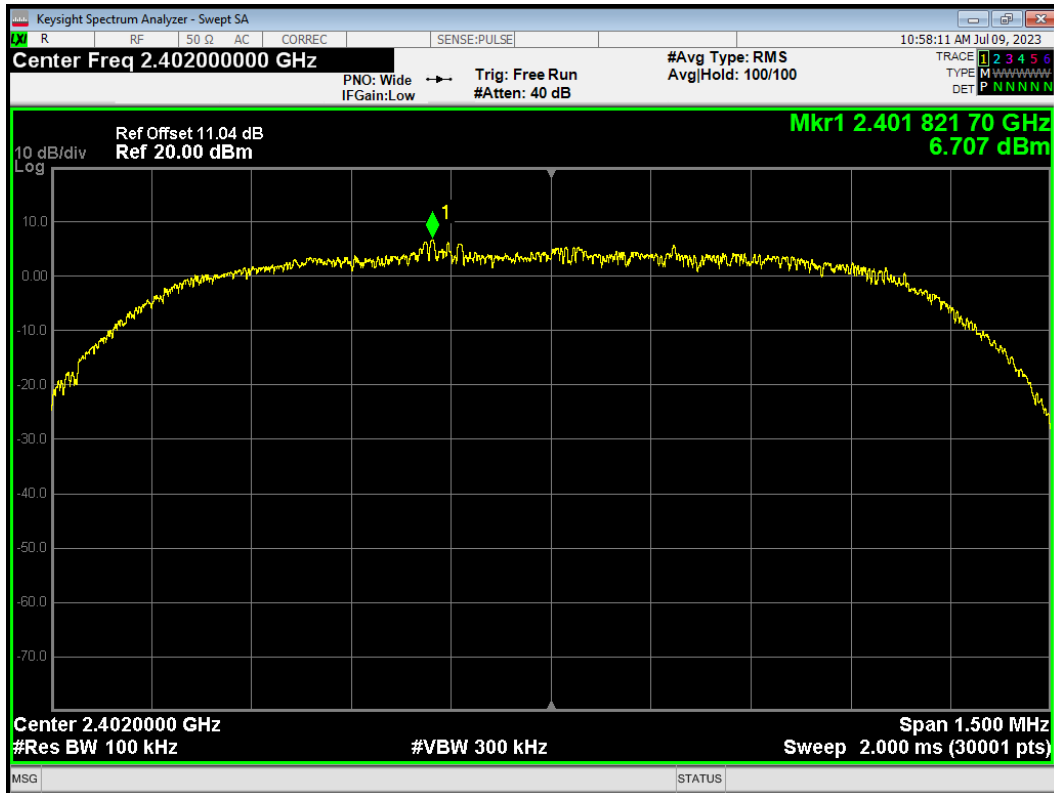

Tx. Spurious 2-DH5 2402MHz Emission

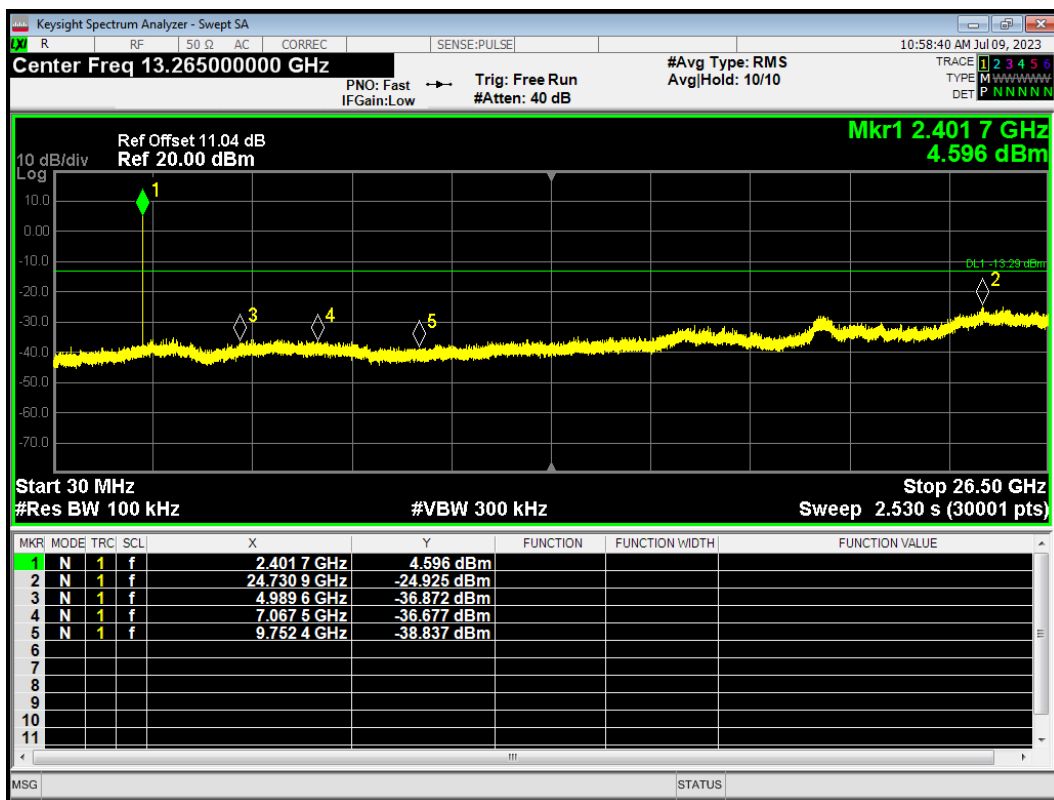

Tx. Spurious 2-DH5 2441MHz Ref

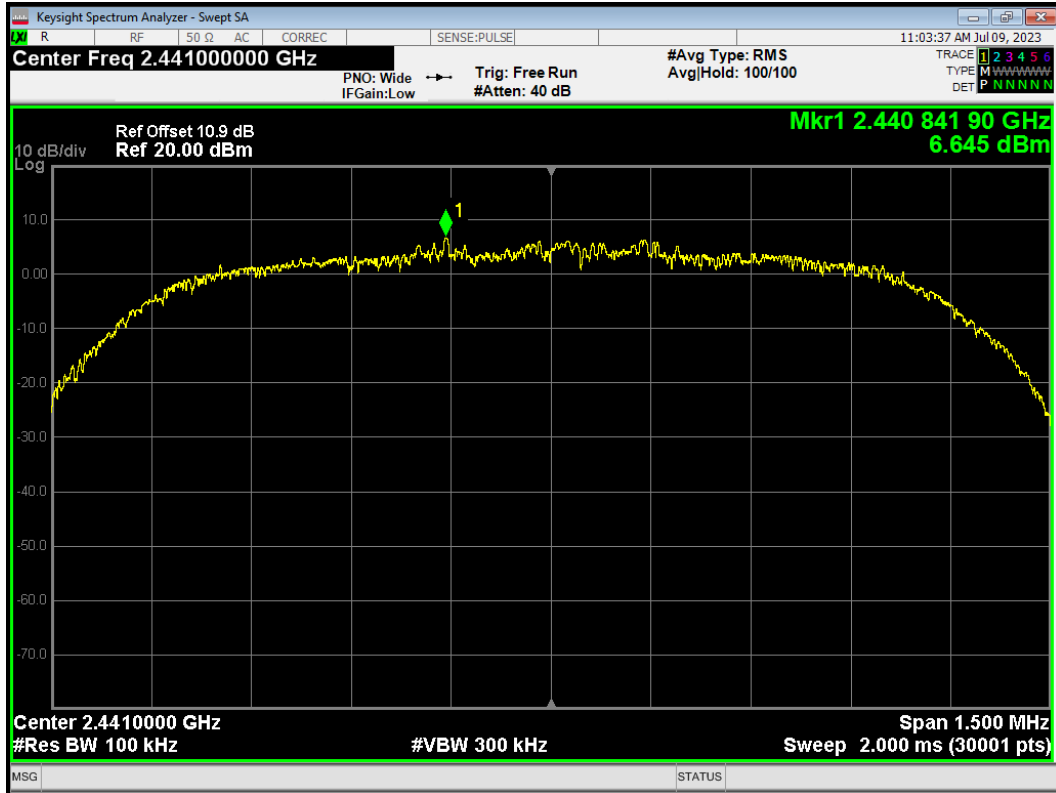

Tx. Spurious 2-DH5 2441MHz Emission

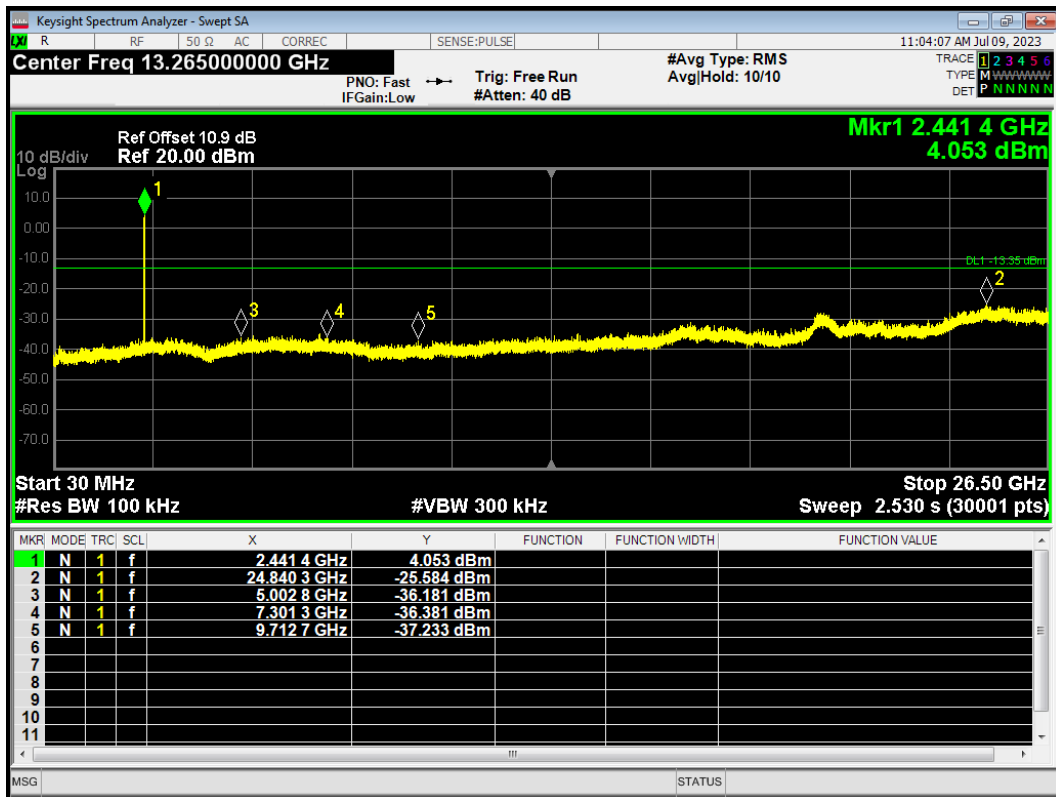

Tx. Spurious 2-DH5 2480MHz Ref

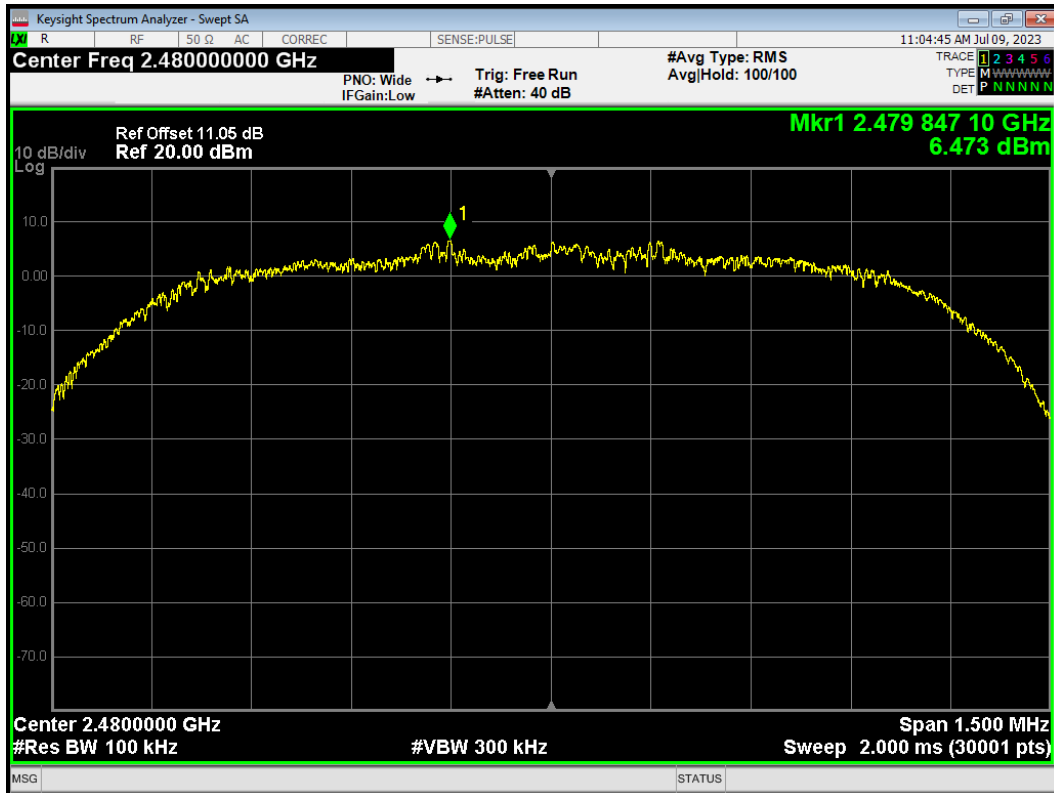

Tx. Spurious 2-DH5 2480MHz Emission

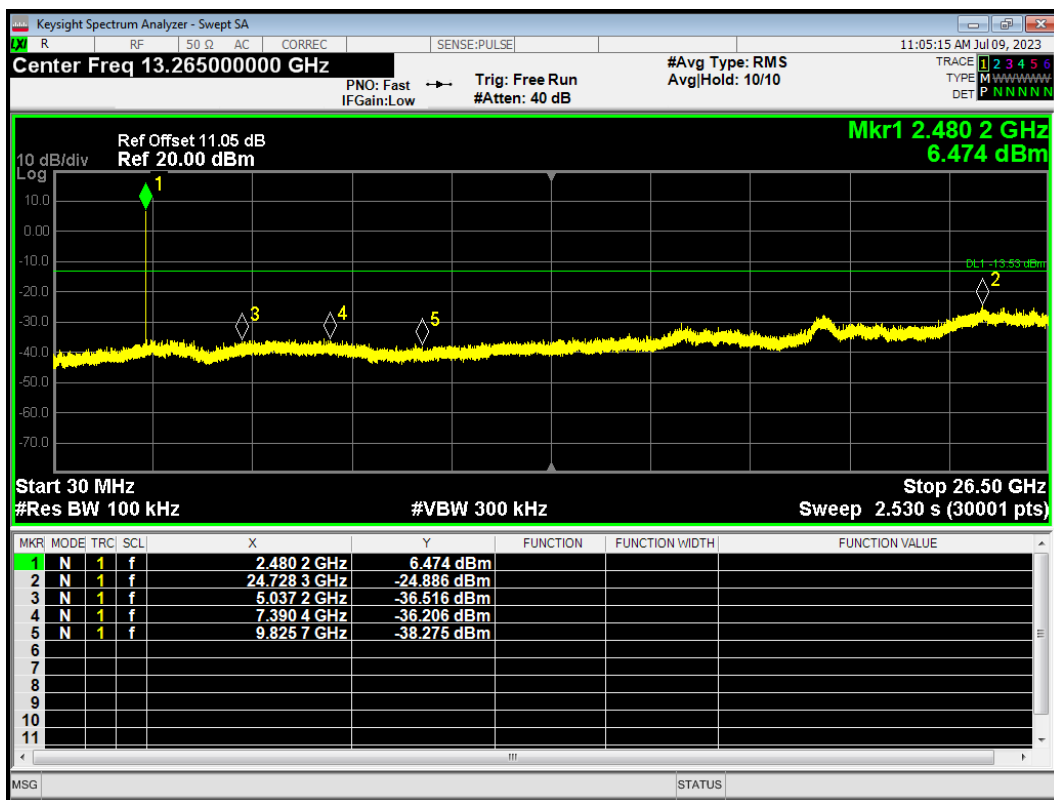

Tx. Spurious 3-DH5 2402MHz Ref

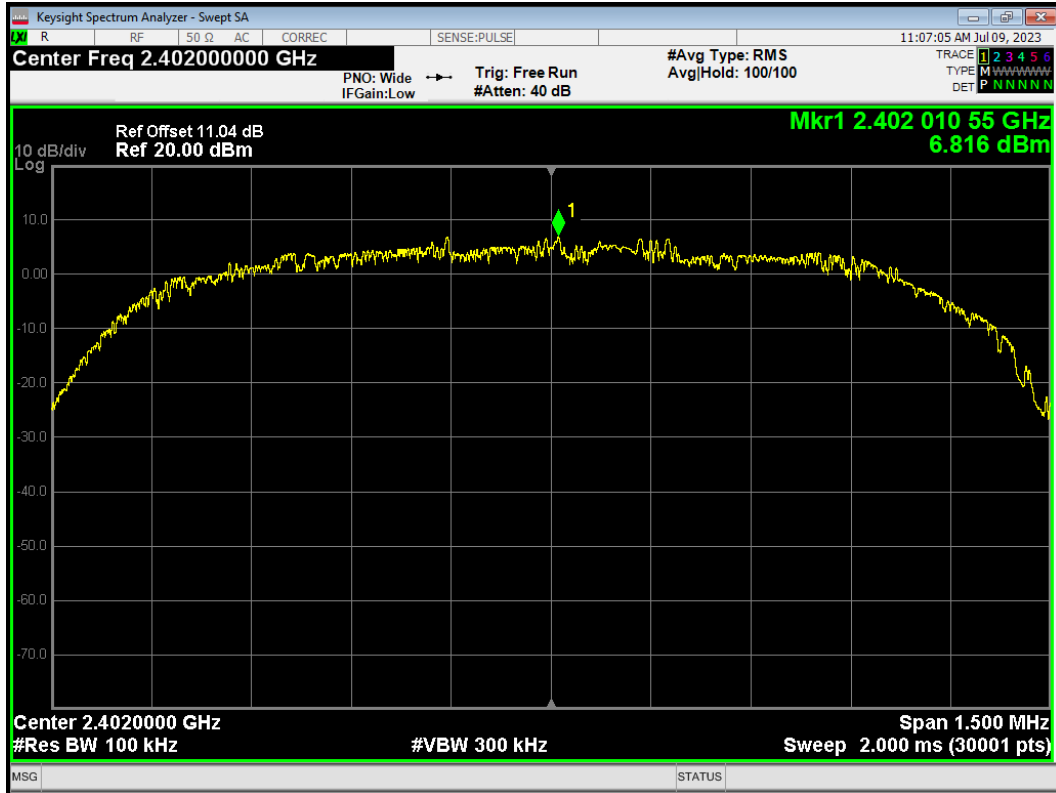

Tx. Spurious 3-DH5 2402MHz Emission

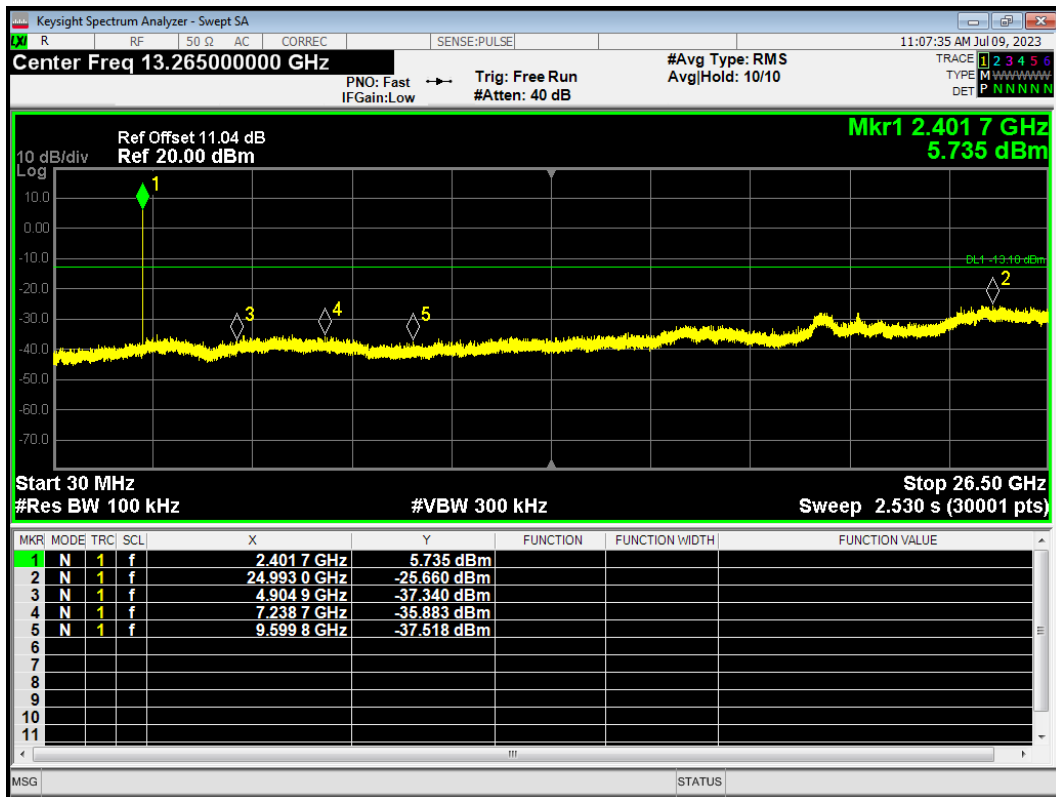

Tx. Spurious 3-DH5 2441MHz Ref

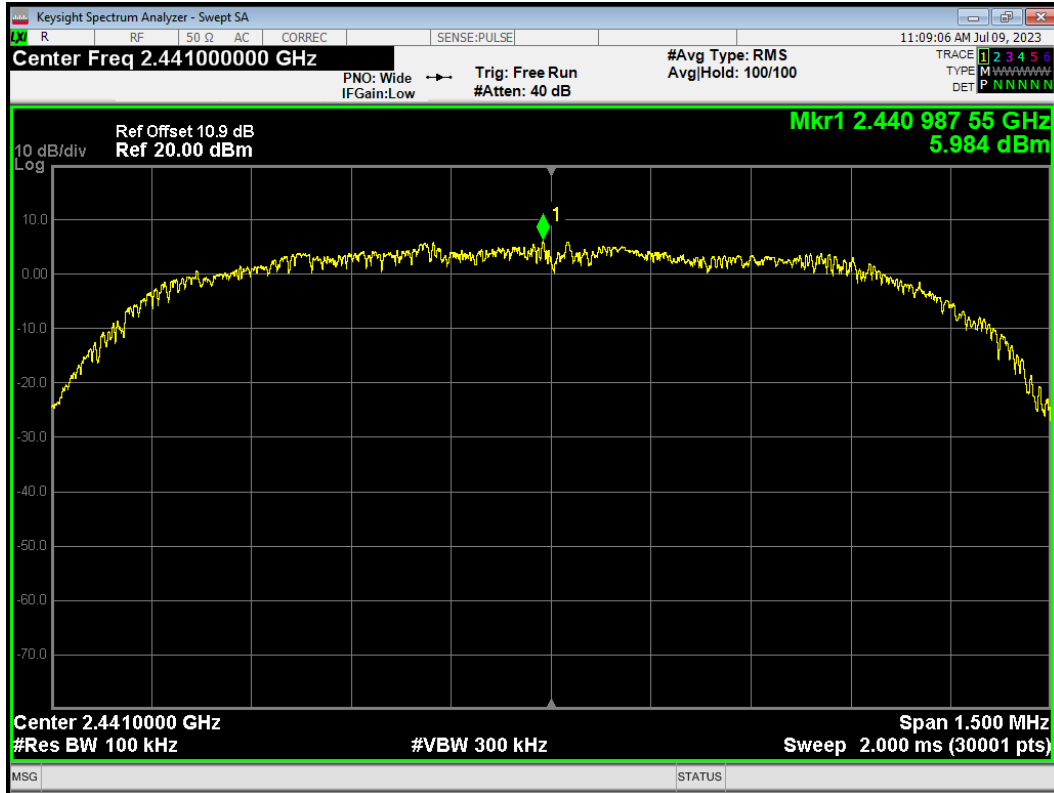

Tx. Spurious 3-DH5 2441MHz Emission

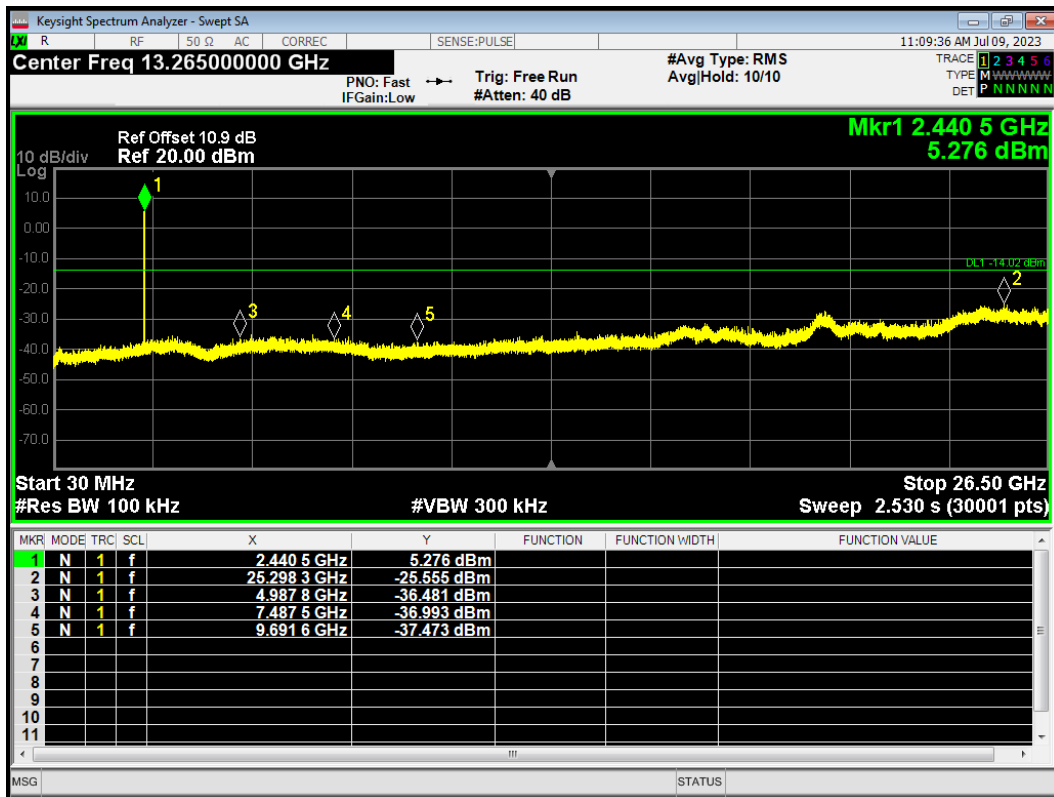

Tx. Spurious 3-DH5 2480MHz Ref

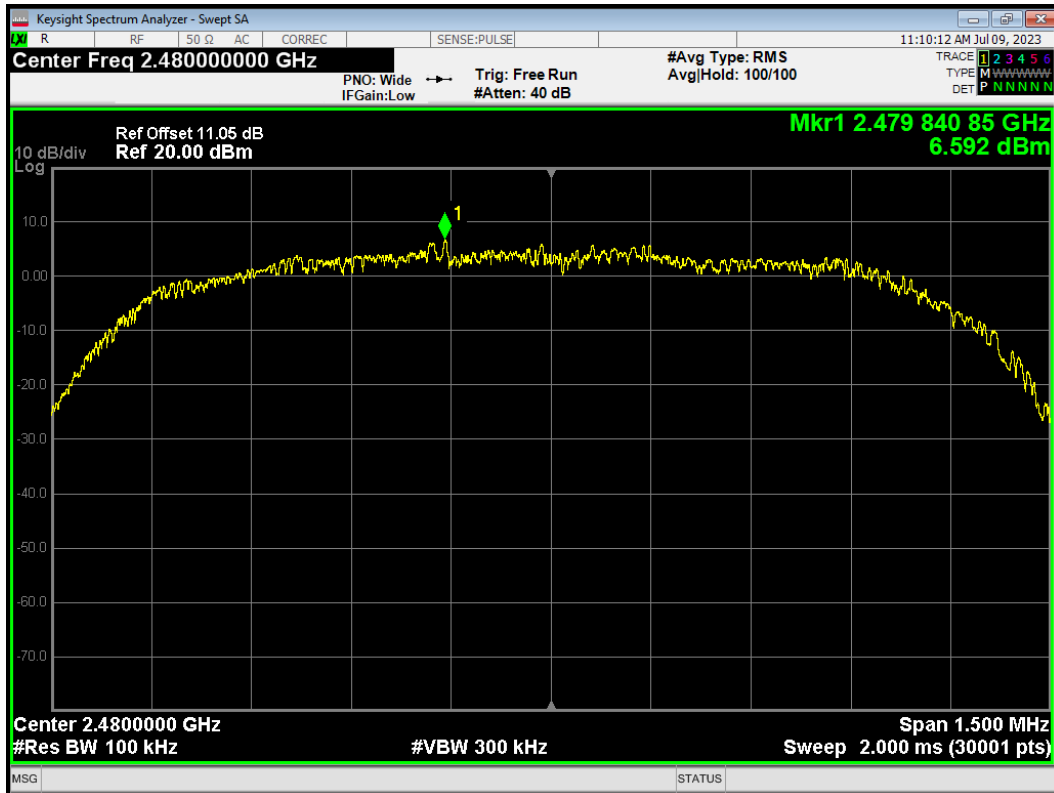

Tx. Spurious 3-DH5 2480MHz Emission

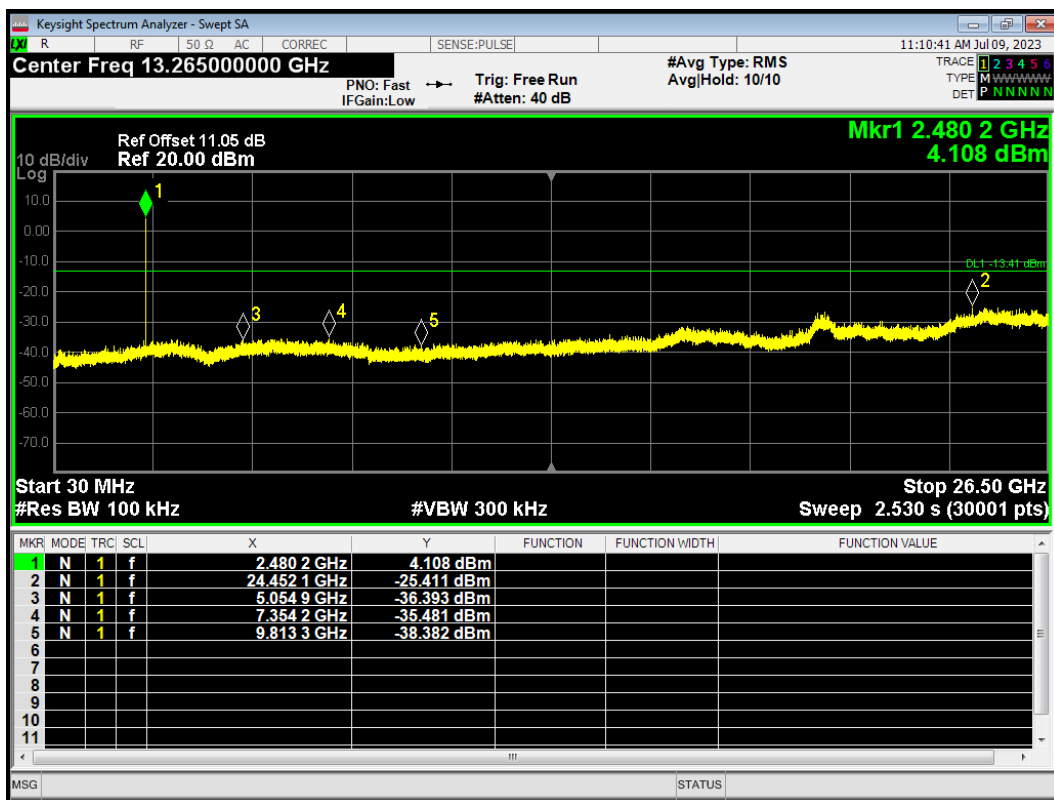

External Antenna

Tx. Spurious 1-DH5 2402MHz Ref

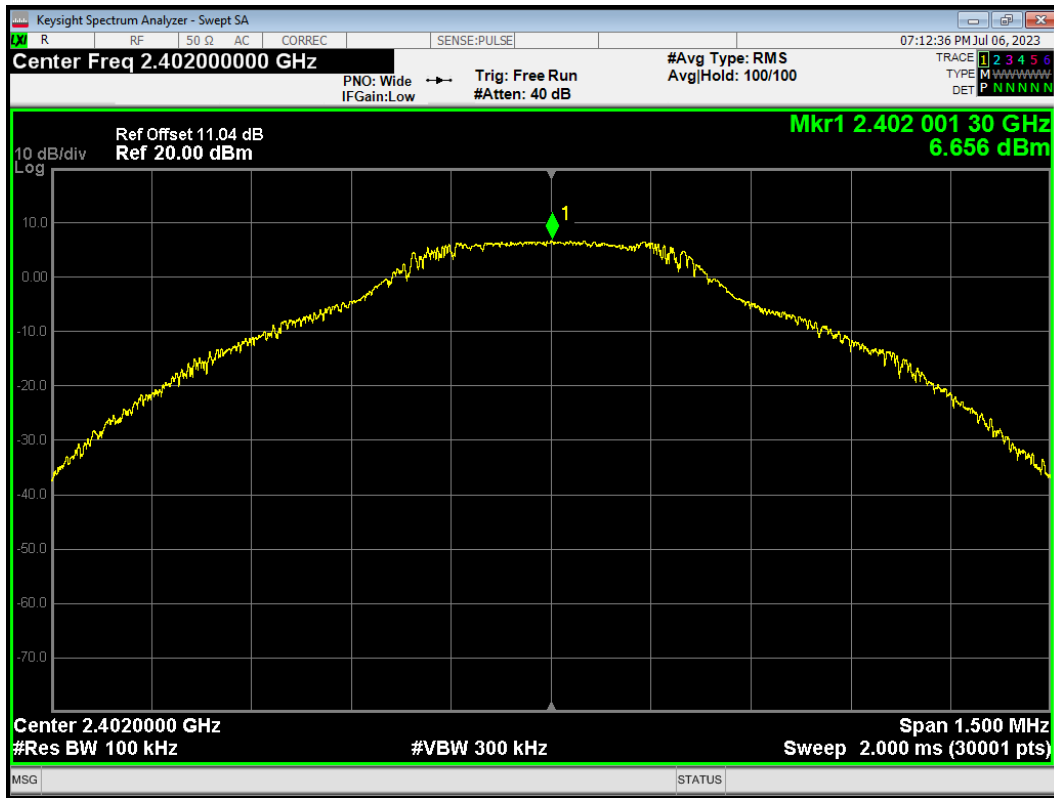

Tx. Spurious 1-DH5 2402MHz Emission

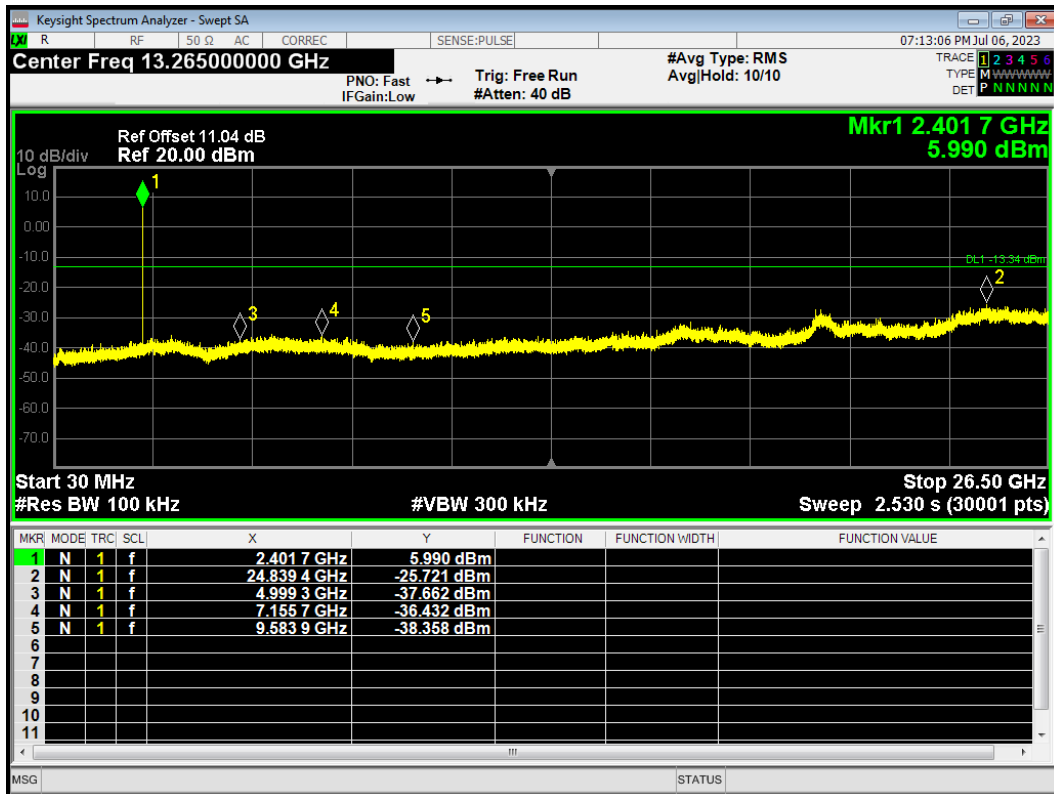

Tx. Spurious 1-DH5 2441MHz Ref

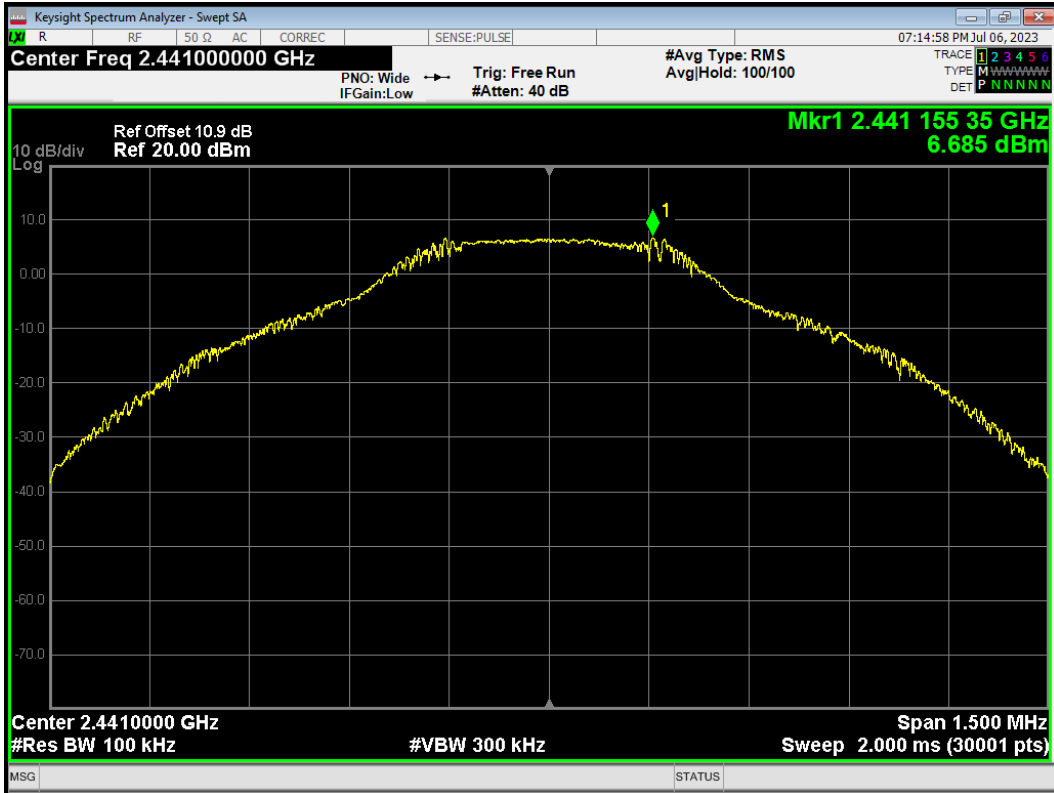

Tx. Spurious 1-DH5 2441MHz Emission

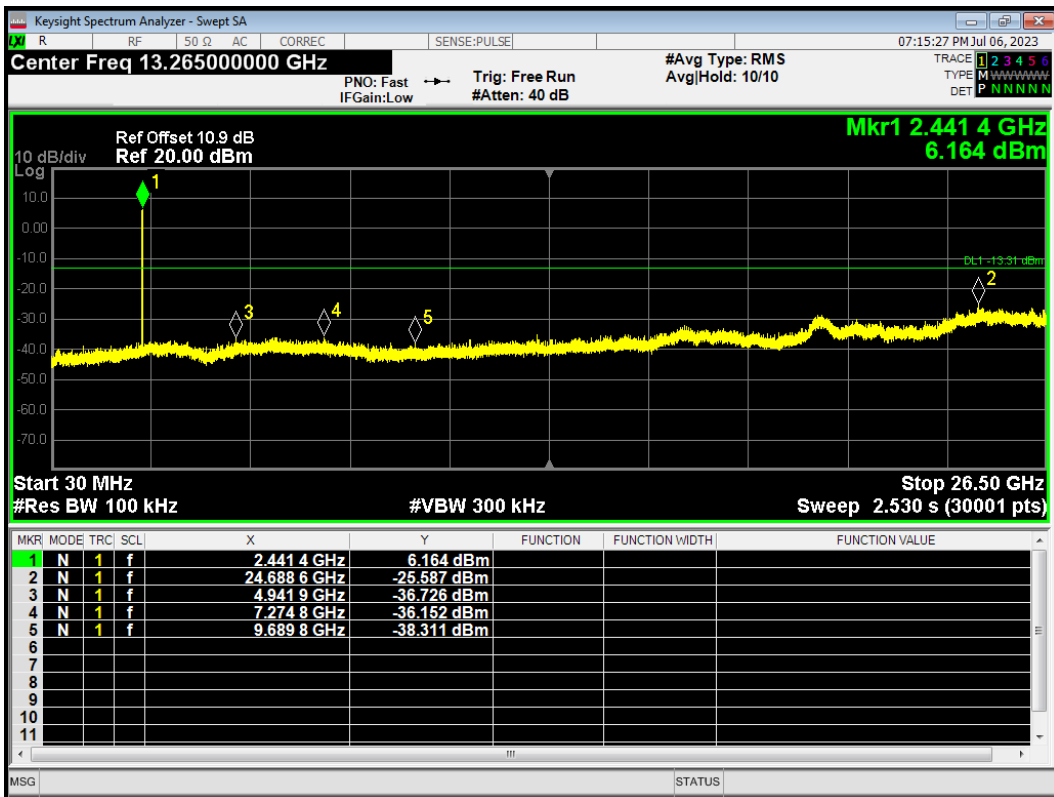

Tx. Spurious 1-DH5 2480MHz Ref

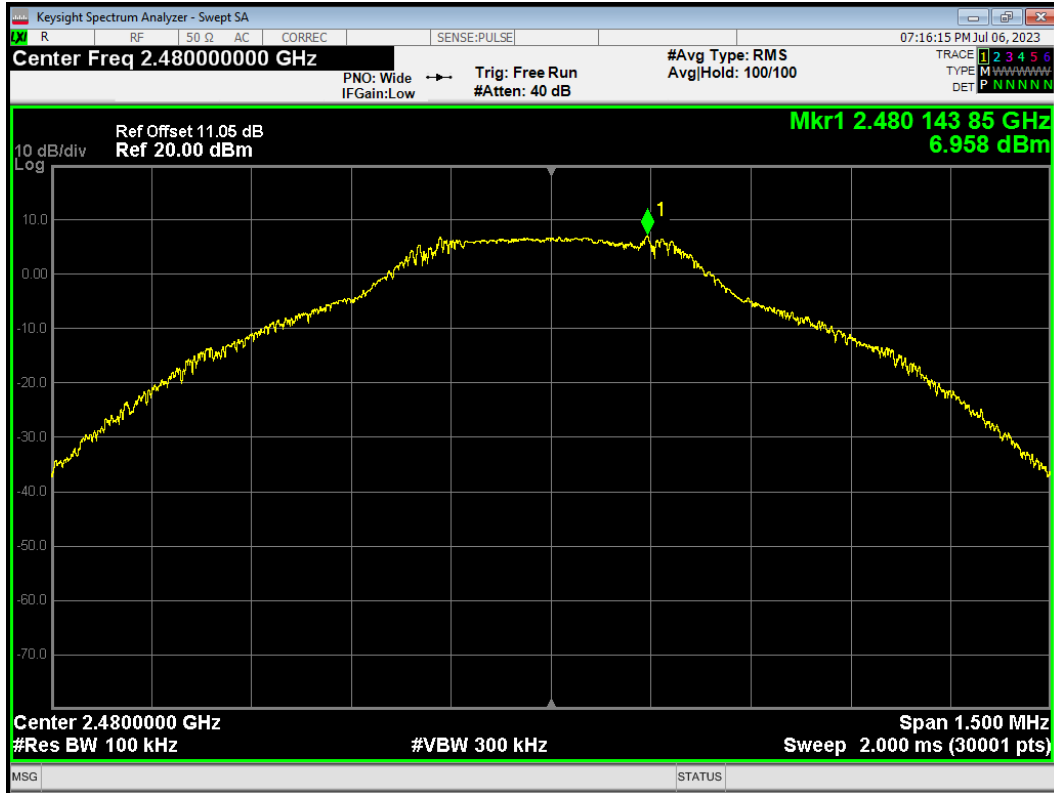

Tx. Spurious 1-DH5 2480MHz Emission

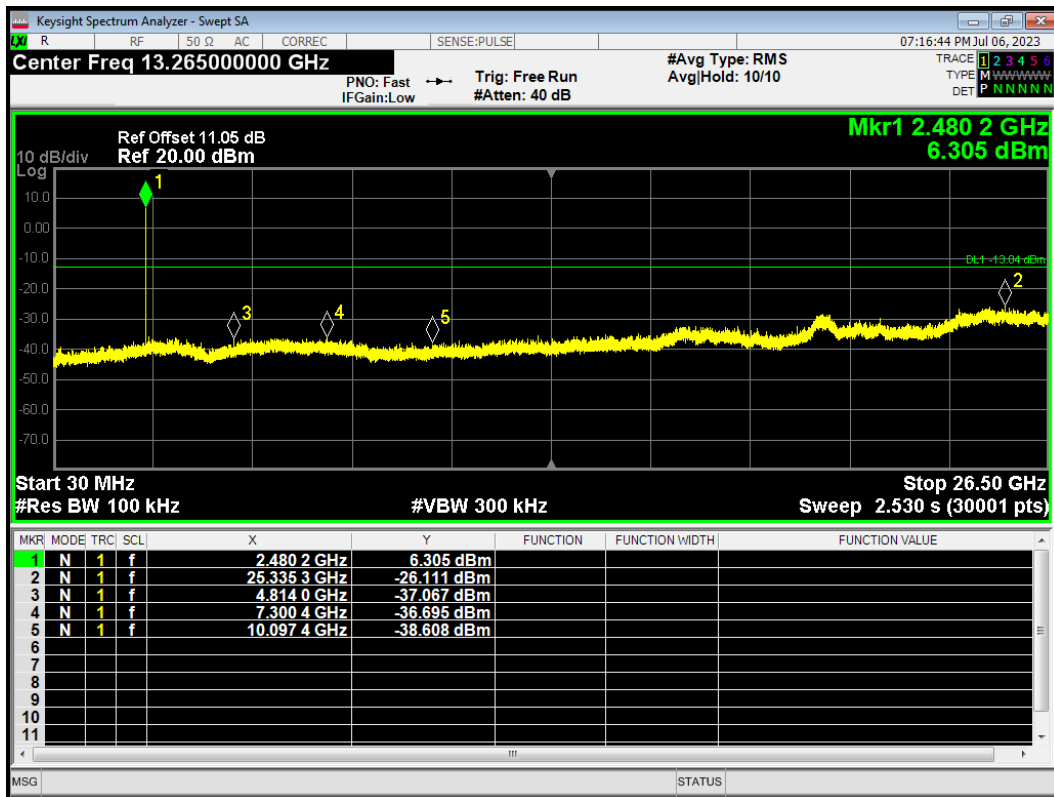

Tx. Spurious 2-DH5 2402MHz Ref

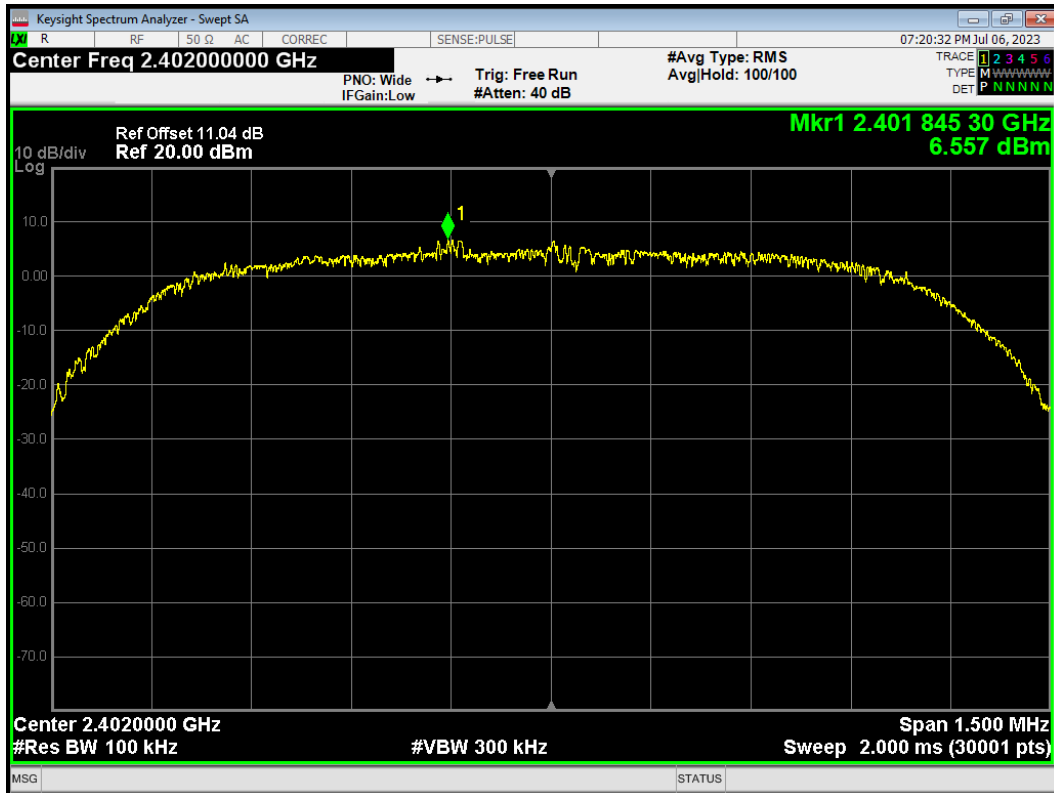

Tx. Spurious 2-DH5 2402MHz Emission

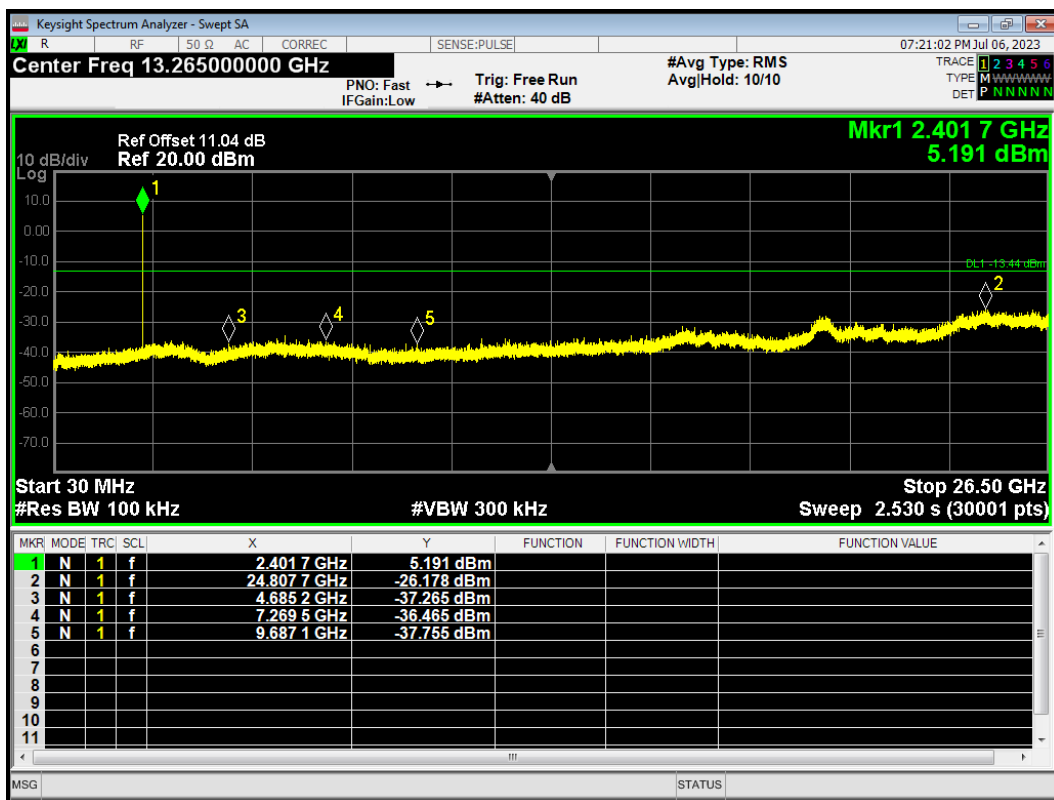

Tx. Spurious 2-DH5 2441MHz Ref

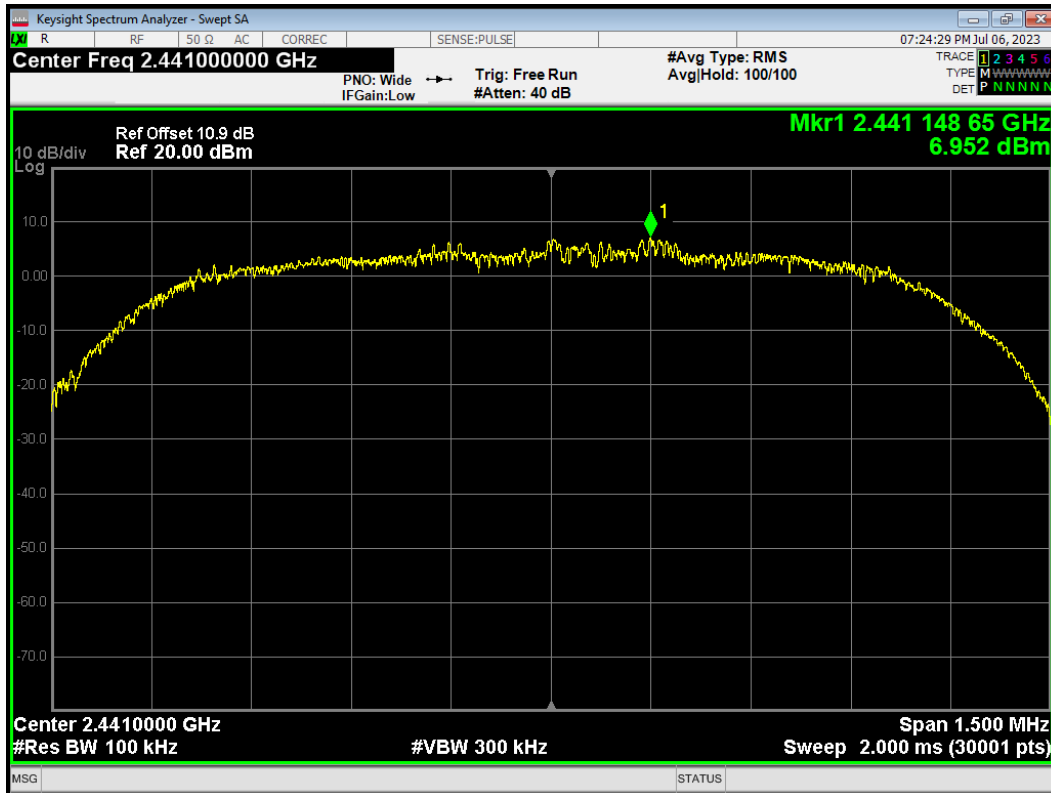

Tx. Spurious 2-DH5 2441MHz Emission

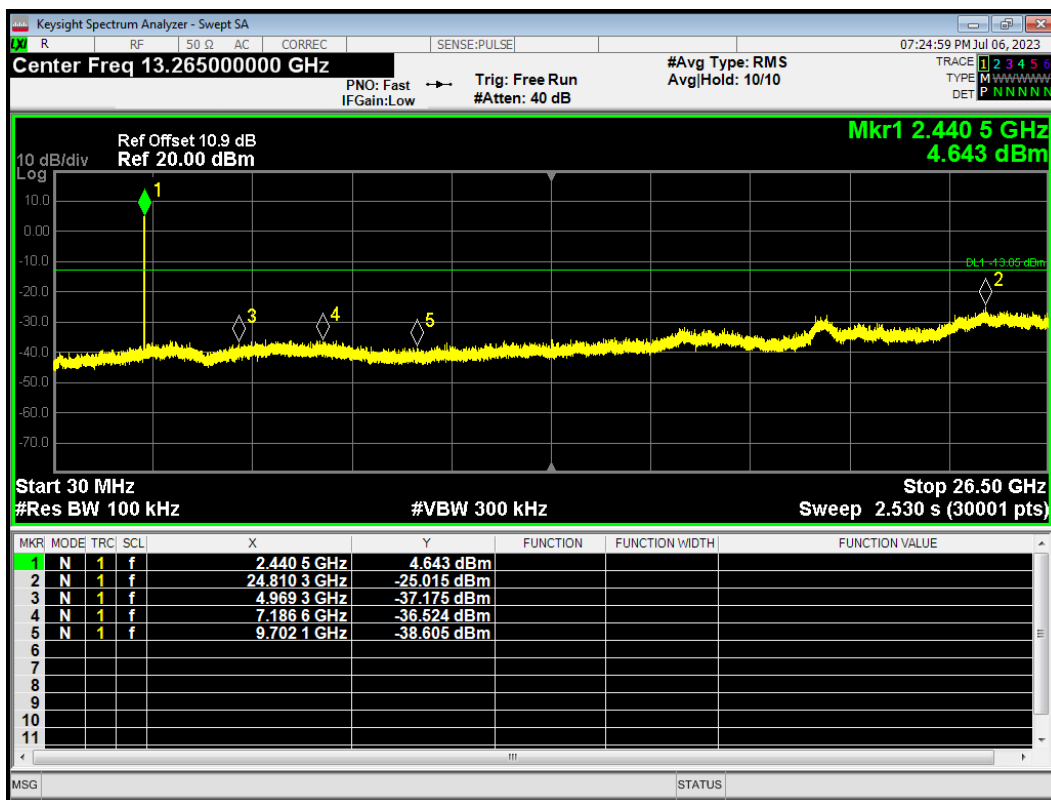

Tx. Spurious 2-DH5 2480MHz Ref

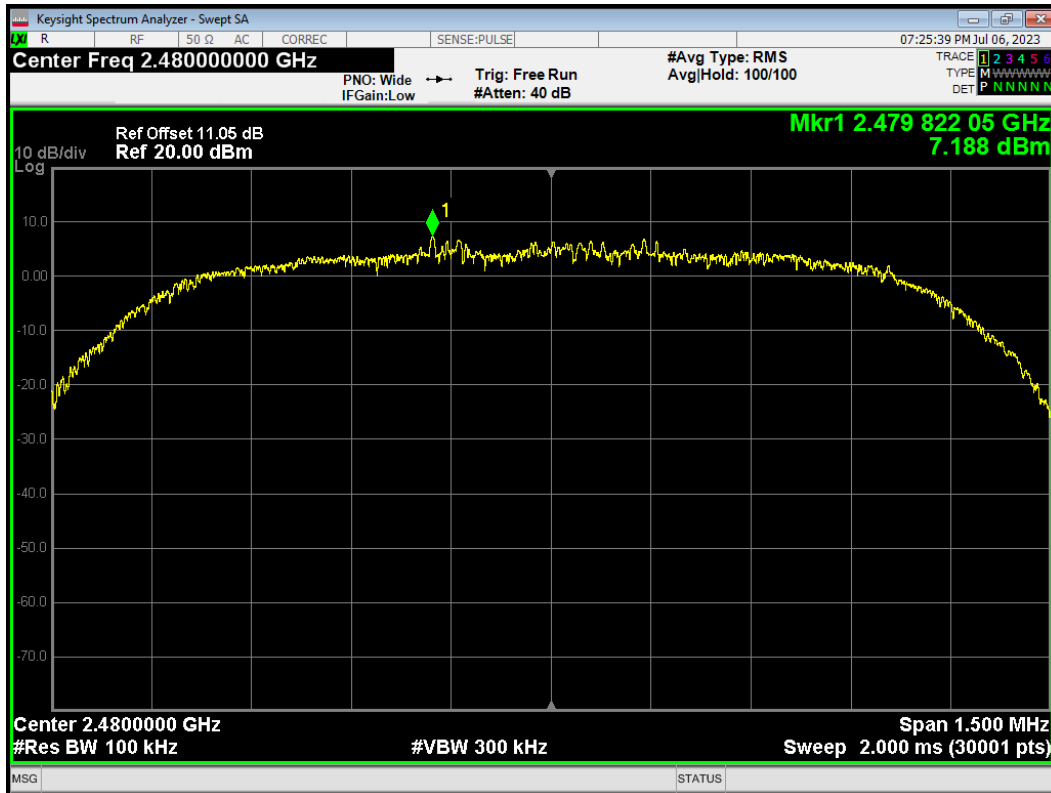

Tx. Spurious 2-DH5 2480MHz Emission

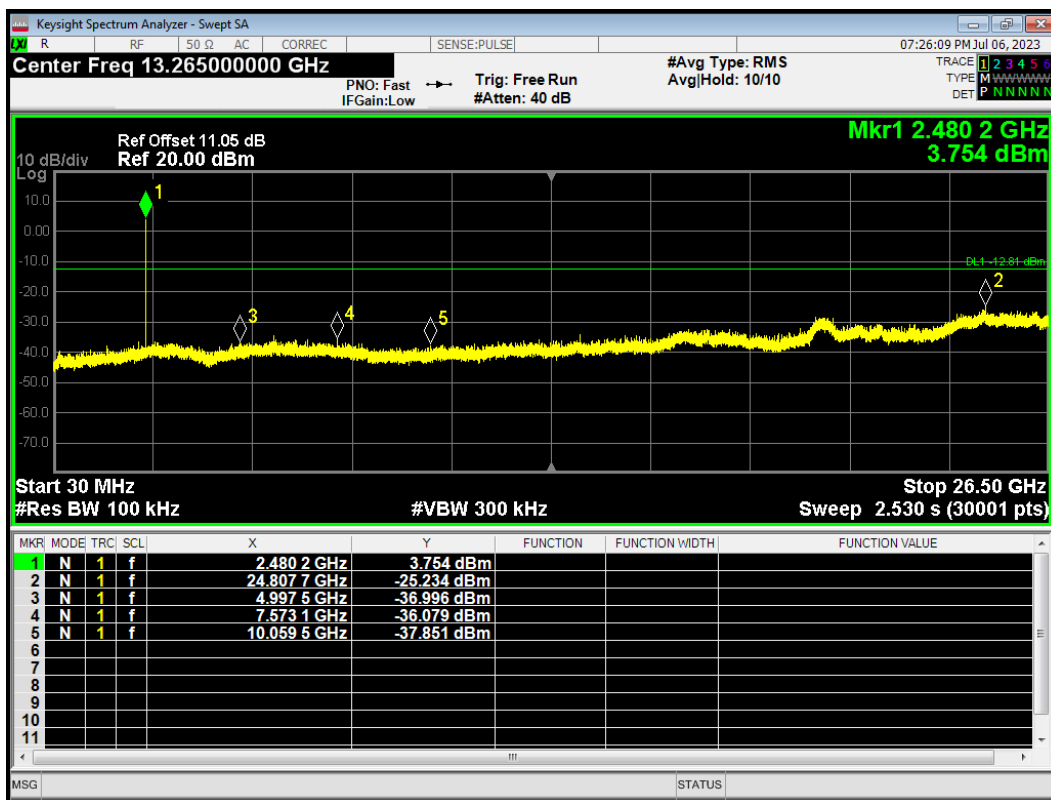

Tx. Spurious 3-DH5 2402MHz Ref

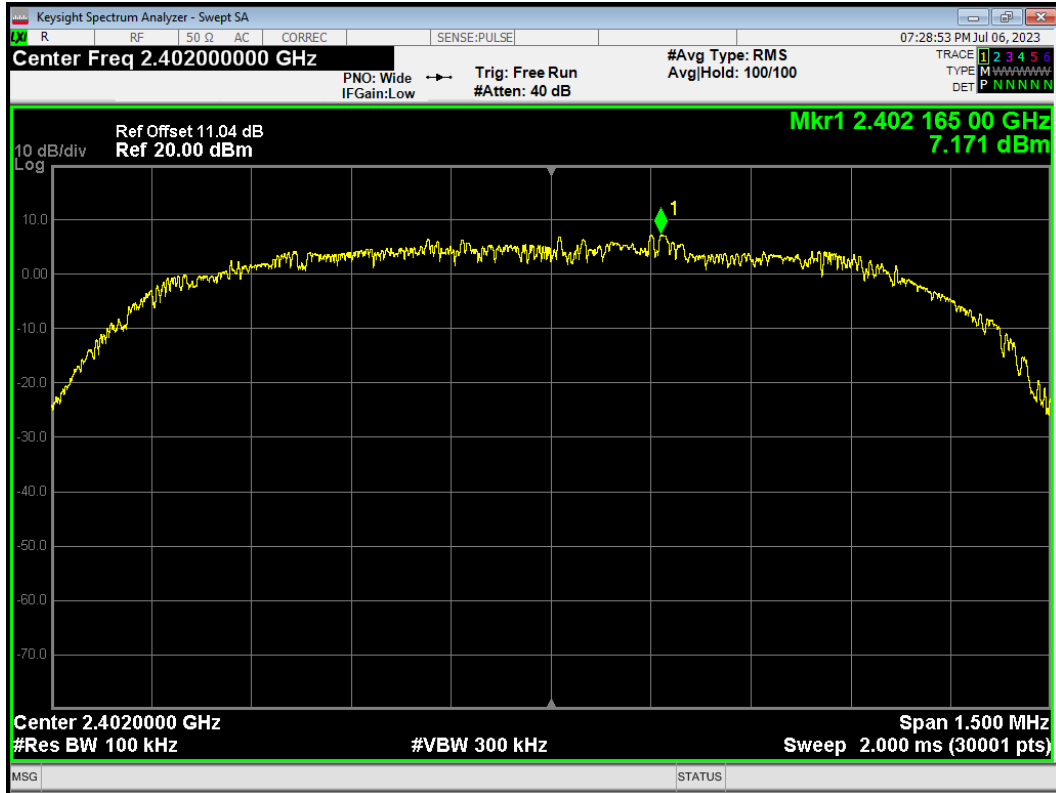

Tx. Spurious 3-DH5 2402MHz Emission

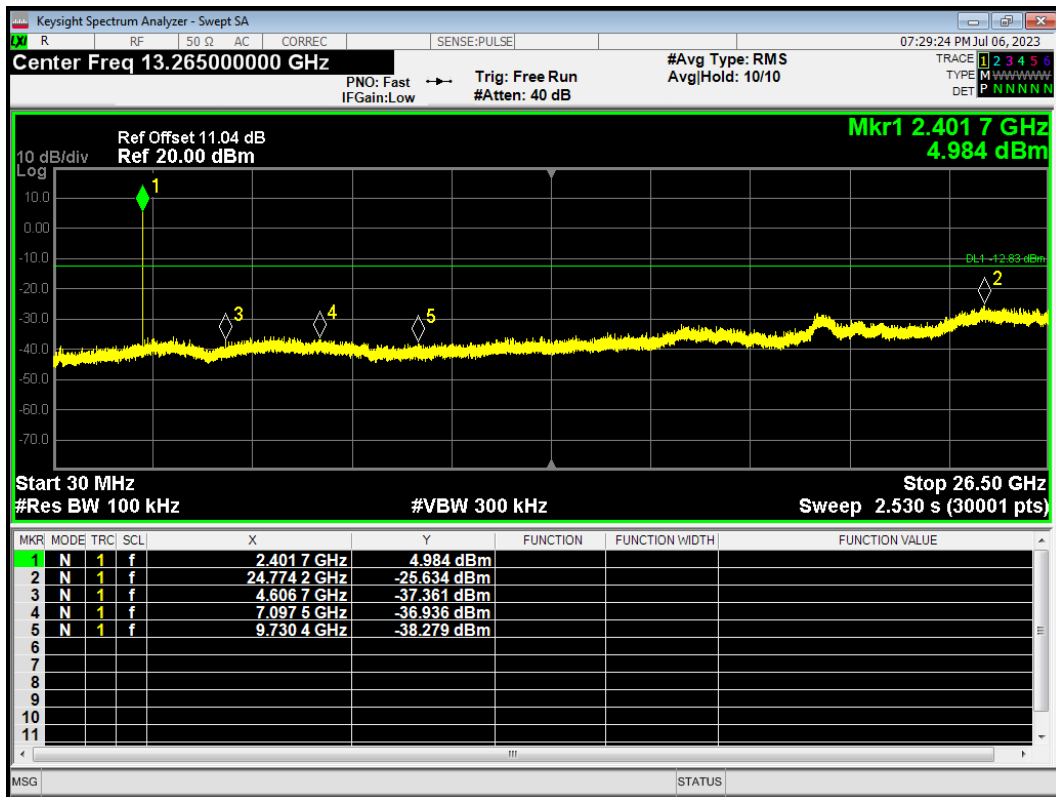

Tx. Spurious 3-DH5 2441MHz Ref

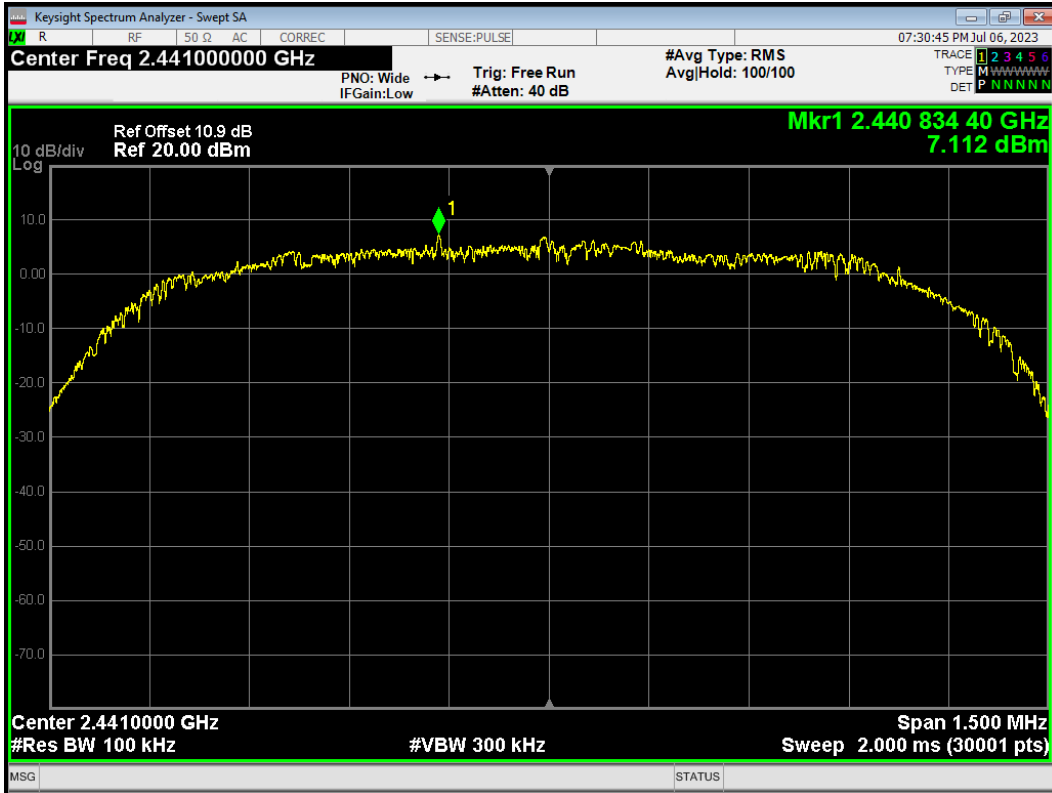

Tx. Spurious 3-DH5 2441MHz Emission

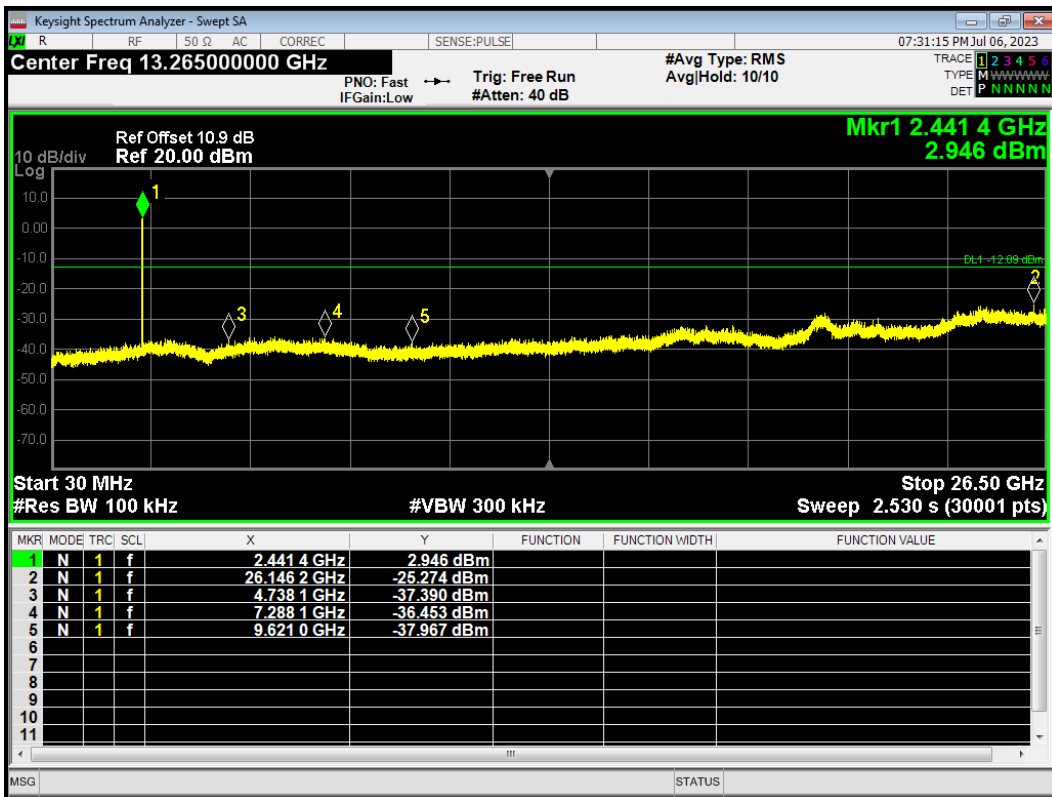

Tx. Spurious 3-DH5 2480MHz Ref

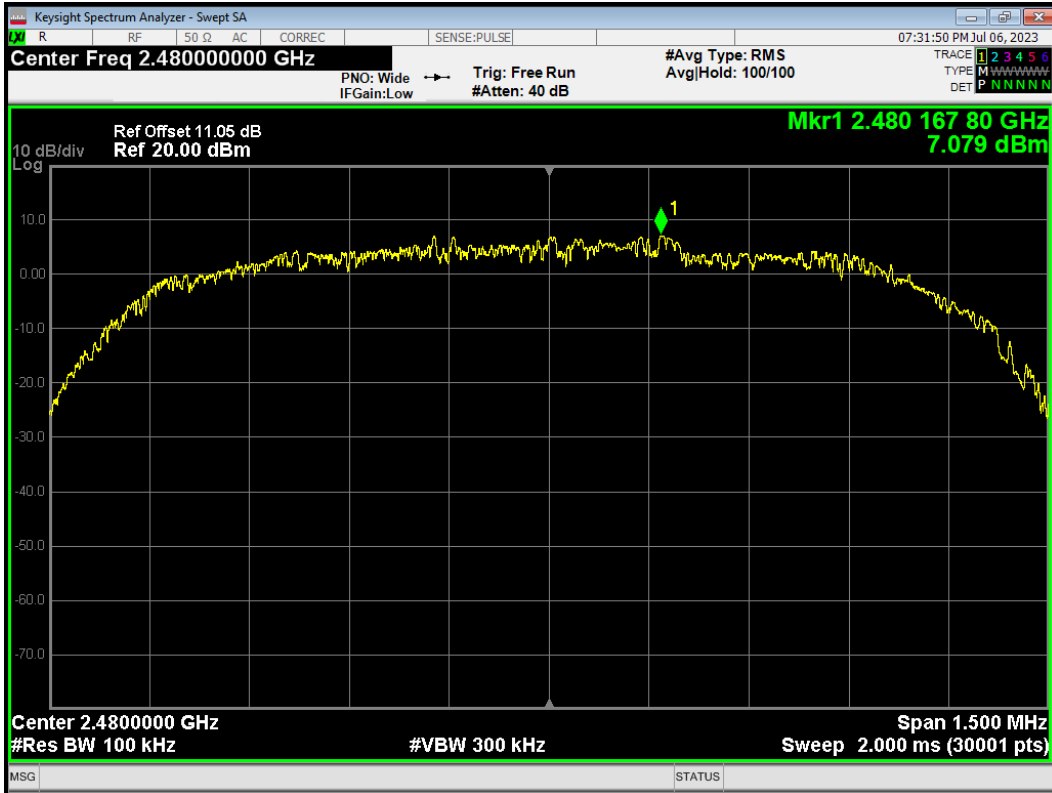

Tx. Spurious 3-DH5 2480MHz Emission

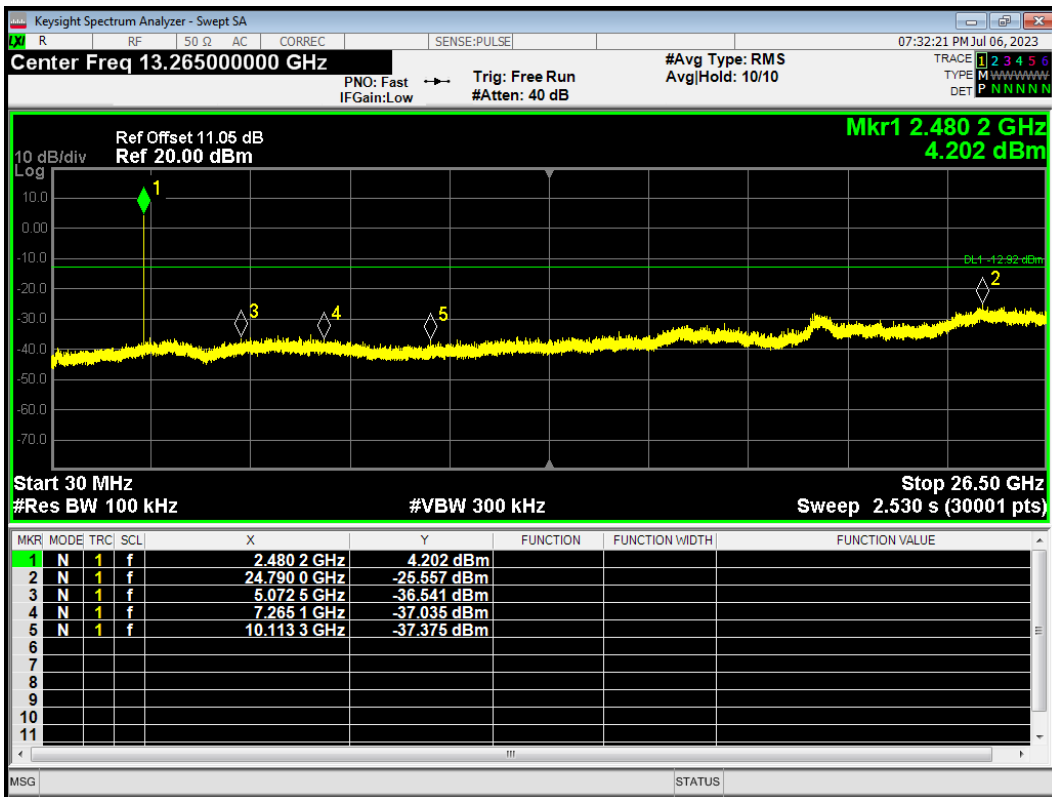

5.8 Unwanted Emission

Ambient condition

Temperature	Relative humidity
20°C ~ 25°C	45% ~ 50%

Method of Measurement

The test set-up was made in accordance to the general provisions of ANSI C63.10. The Equipment Under Test (EUT) was set up on a non-conductive table in the semi-anechoic chamber. The test was performed at the distance of 3 m between the EUT and the receiving antenna. The radiated emissions measurements were made in a typical installation configuration.

Sweep the whole frequency band through the range from 9 kHz to the 10th harmonic of the carrier, and the emissions less than 20 dB below the permissible value are reported.

During the test, below 30MHz, the center of the loop shall be 1 meters; above 30MHz, the height of receive antenna shall be moved from 1 to 4 meters, and the antenna shall be performed under horizontal and vertical polarization. The turntable shall be rotated from 0 to 360 degrees for detecting the maximum of radiated spurious signal level. The measurements shall be repeated with orthogonal polarization of the test antenna. The data of cable loss and antenna factor has been calibrated in full testing frequency range before the testing.

Set the spectrum analyzer in the following:

9kHz~150 kHz

RBW=200Hz, VBW=1kHz/ Sweep=AUTO

150 kHz~30MHz

RBW=9KHz, VBW=30KHz,/ Sweep=AUTO

Below 1GHz

RBW=100kHz / VBW=300kHz / Sweep=AUTO

Above 1GHz

(a) PEAK: RBW=1MHz VBW=3MHz/ Sweep=AUTO

(b) AVERAGE: RBW=1MHz / VBW=3MHz / Sweep=AUTO

detector; The measurements employing a CISPR quasi-peak detector except for the frequency bands 9-90 kHz, 110-490 kHz and above 1000 MHz. Radiated emission limits in these three bands are based on measurements employing an average detector.

The dwell time per channel of the hopping signal is less than 100 ms, then the reading obtained with the 10 Hz VBW may be further adjusted by a “duty cycle correction factor”, derived from $20\log(\text{dwell time}/100 \text{ ms})$, in an effort to demonstrate compliance with the 15.209 limit.

If the emission is pulsed, modify the unit for continuous operation; use the settings shown above, then correct the reading by subtracting the peak- average correction factor, derived form the appropriate duty cycle calculation.

This setting method can refer to **KDB 558074 D01**.

This mode was measured in the following mode: EUT with cradle and EUT without cradle. The worst emission was found in EUT with cradle mode and the worst case was recorded.

The test is in transmitting mode.

Test setup

9kHz~ 30MHz

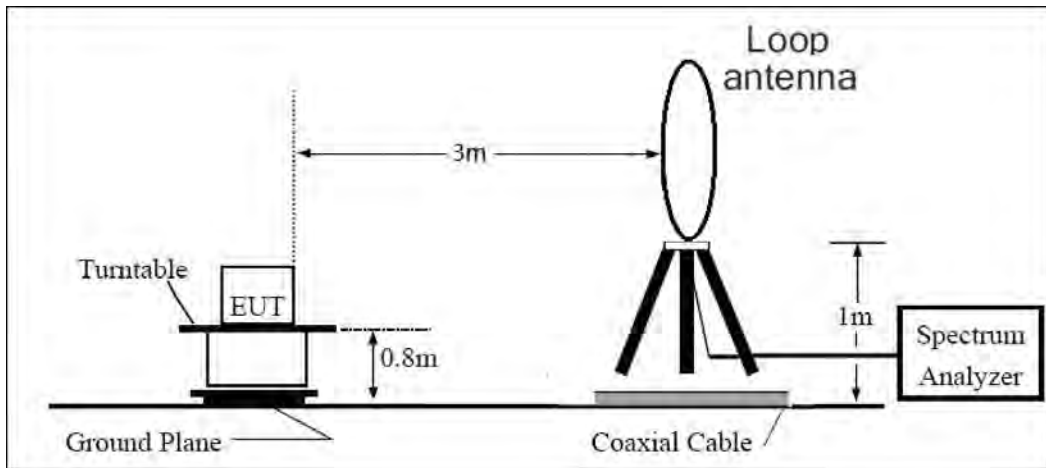

30MHz~ 1GHz

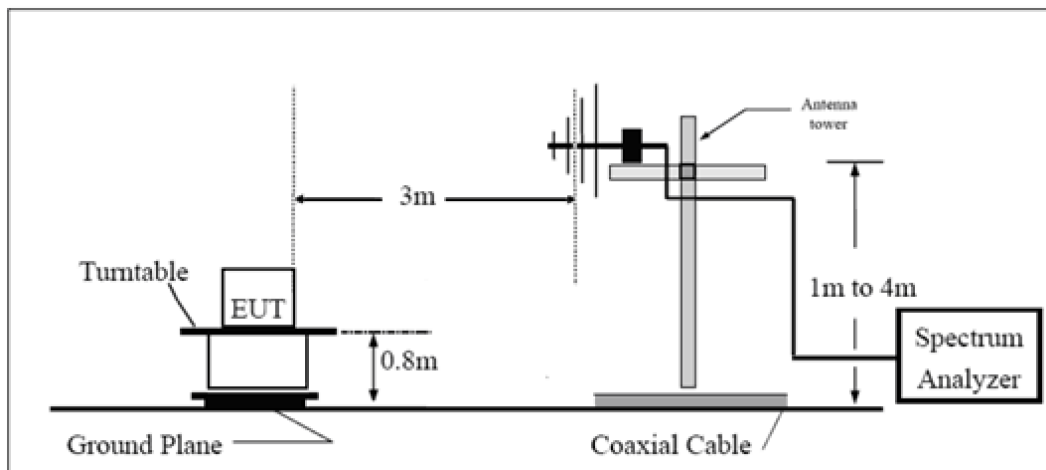

Above 1GHz

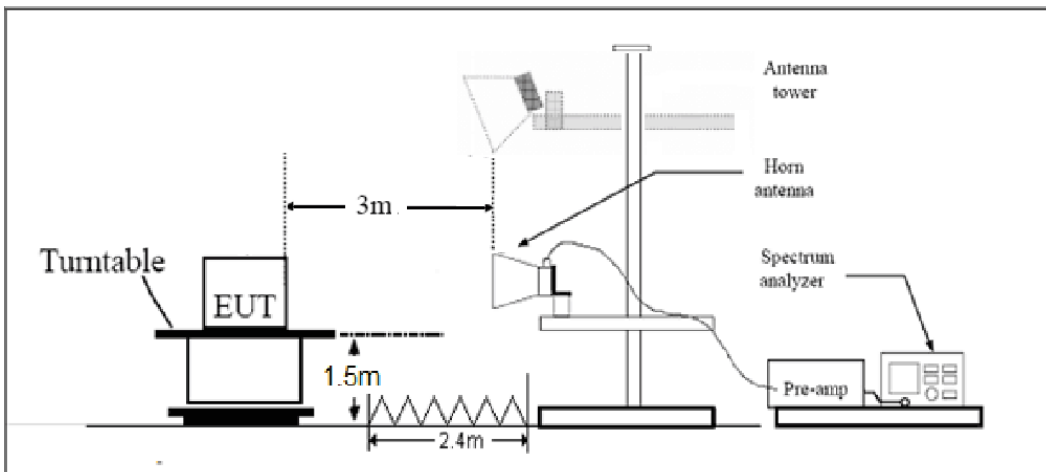

Note: Area side:2.4mX3.6m

Limits

Rule Part 15.247(d) specifies that “In addition, radiated emissions which fall in the restricted bands, as defined in § 15.205(a), must also comply with the radiated emission limits specified in § 15.209(a) (see § 15.205(c)).”

Limit in restricted band

Frequency of emission (MHz)	Field strength($\mu\text{V}/\text{m}$)	Field strength($\text{dB}\mu\text{V}/\text{m}$)
0.009–0.490	2400/F(kHz)	/
0.490–1.705	24000/F(kHz)	/
1.705–30.0	30	/
30-88	100	40
88-216	150	43.5
216-960	200	46
Above960	500	54

§15.35(b)

There is also a limit on the radio frequency emissions, as measured using instrumentation with a peak detector function, corresponding to 20 dB above the maximum permitted average limit.

Peak Limit=74dB $\mu\text{V}/\text{m}$

Average Limit=54dB $\mu\text{V}/\text{m}$

Spurious Radiated Emissions are permitted in any of the frequency bands listed below:

MHz	MHz	MHz	GHz
0.090-0.110	16.42-16.423	399.9-410	4.5-5.15
¹ 0.495-0.505	16.69475-16.69525	608-614	5.35-5.46
2.1735-2.1905	16.80425-16.80475	960-1240	7.25-7.75
4.125-4.128	25.5-25.67	1300-1427	8.025-8.5
4.17725-4.17775	37.5-38.25	1435-1626.5	9.0-9.2
4.20725-4.20775	73-74.6	1645.5-1646.5	9.3-9.5
6.215-6.218	74.8-75.2	1660-1710	10.6-12.7
6.26775-6.26825	108-121.94	1718.8-1722.2	13.25-13.4
6.31175-6.31225	123-138	2200-2300	14.47-14.5
8.291-8.294	149.9-150.05	2310-2390	15.35-16.2
8.362-8.366	156.52475-156.52525	2483.5-2500	17.7-21.4
8.37625-8.38675	156.7-156.9	2690-2900	22.01-23.12
8.41425-8.41475	162.0125-167.17	3260-3267	23.6-24.0
12.29-12.293	167.72-173.2	3332-3339	31.2-31.8
12.51975-12.52025	240-285	3345.8-3358	36.43-36.5
12.57675-12.57725	322-335.4	3600-4400	(²)
13.36-13.41			

Measurement Uncertainty

The assessed measurement uncertainty to ensure 95% confidence level for the normal distribution is with the coverage factor $k = 1.96$.

Frequency	Uncertainty
9KHz-30MHz	3.55 dB
30MHz-200MHz	4.17 dB
200MHz-1GHz	4.84 dB
1-18GHz	4.35 dB
18-26.5GHz	5.90 dB
26.5GHz~40GHz	5.92 dB

Test Results:

After the pretest, Internal Antenna was selected as the worst antenna.

A symbol ($\text{dB } \mu\text{V/m}$) in the test plot below means (dB $\mu\text{V/m}$)

The signal beyond the limit is carrier.

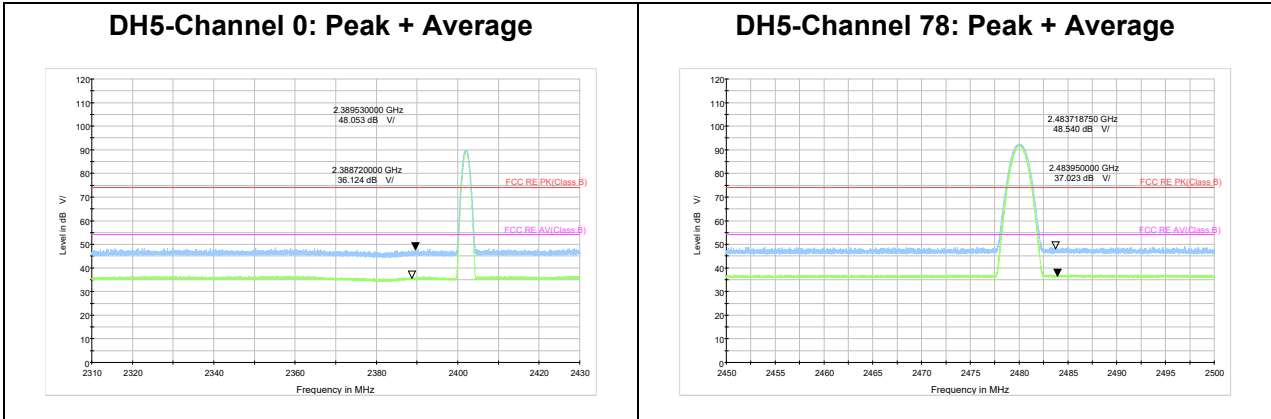

The bandage was performed in all EDR mode (2DH5 and 3DH5), 3DH5 was selected as the worse condition. The test data of the worst-case condition was recorded in this report.

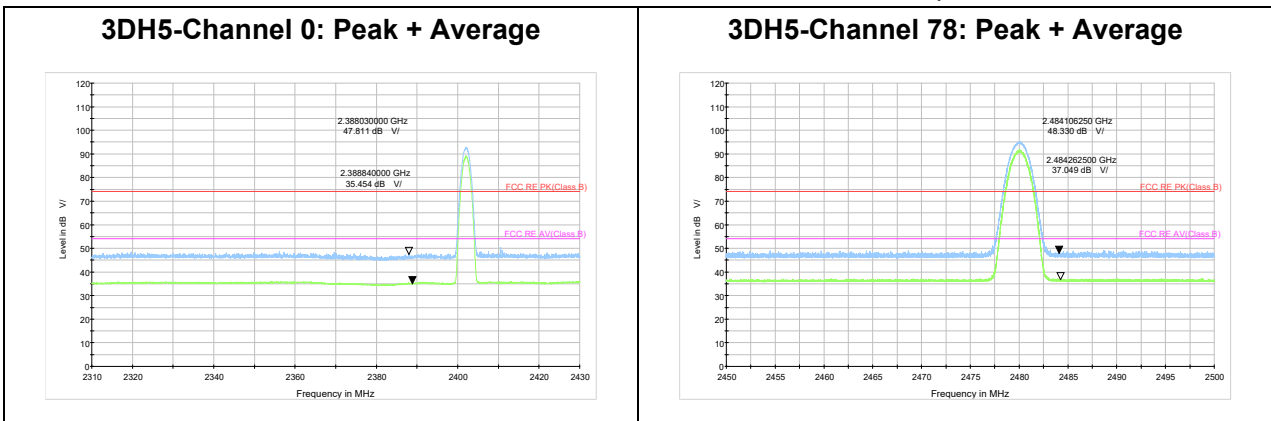

Result of RE

Test result

After the pretest, Internal Antenna was selected as the worst antenna.

Sweep the whole frequency band through the range from 9kHz to the 10th harmonic of the carrier, the Emissions in the frequency band 9kHz-30MHz are more than 20dB below the limit are not reported.

The following graphs display the maximum values of horizontal and vertical by software. For above 1GHz, Blue trace uses the peak detection, Green trace uses the average detection.

During the test, the Radiates Emission from 30MHz to 1GHz was performed in all modes with all channels, GFSK DH5-Channel 78 are selected as the worst condition. The test data of the worst-case condition was recorded in this report.

A symbol ($\text{dB } \mu\text{V/m}$) in the test plot below means (dB $\mu\text{V/m}$)

Continuous TX mode:

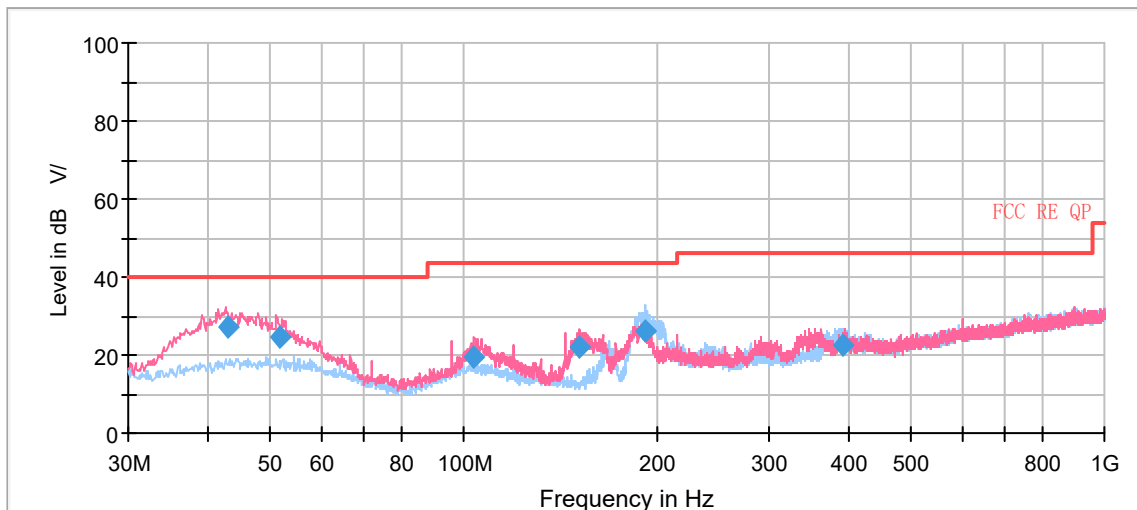

Radiates Emission from 30MHz to 1GHz

Frequency (MHz)	Quasi-Peak (dB $\mu\text{V/m}$)	Limit (dB $\mu\text{V/m}$)	Margin (dB)	Height (cm)	Polarization	Azimuth (deg)	Correct Factor (dB)
43.088750	27.32	40.00	12.68	100.0	V	9.0	20.2
51.788750	24.50	40.00	15.50	100.0	V	342.0	20.4
103.722500	19.54	43.50	23.96	109.0	V	177.0	18.8
151.700000	22.07	43.50	21.43	100.0	V	76.0	14.7
192.035000	26.29	43.50	17.21	125.0	H	256.0	18.0
390.028750	22.59	46.00	23.41	100.0	H	227.0	22.7

Remark: 1. Correction Factor = Antenna factor + Insertion loss (cable loss + amplifier gain)

2. Margin = Limit – Quasi-Peak

DH5-Channel 0

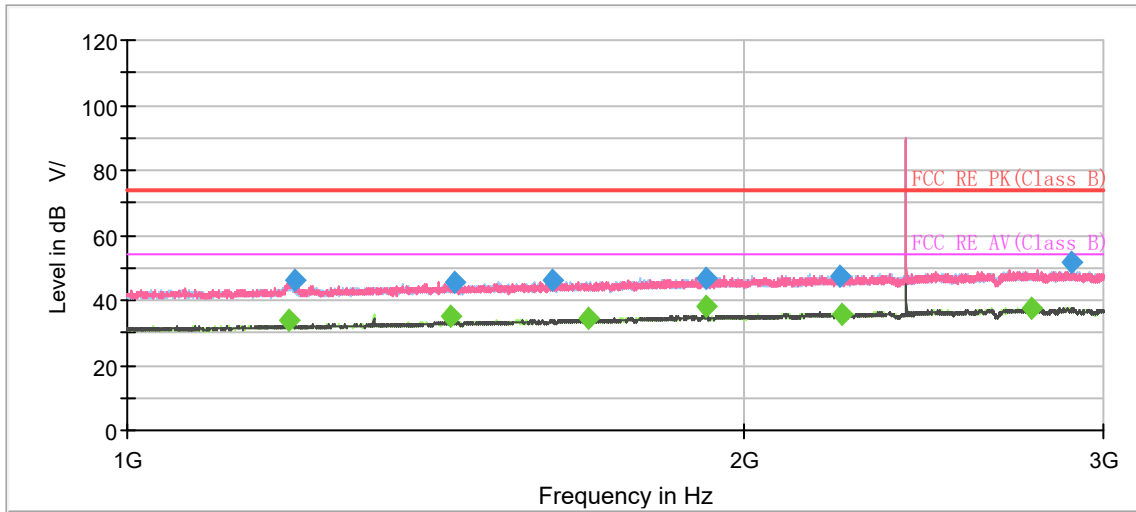

Note: The signal beyond the limit is carrier.
Radiates Emission from 1GHz to 3GHz

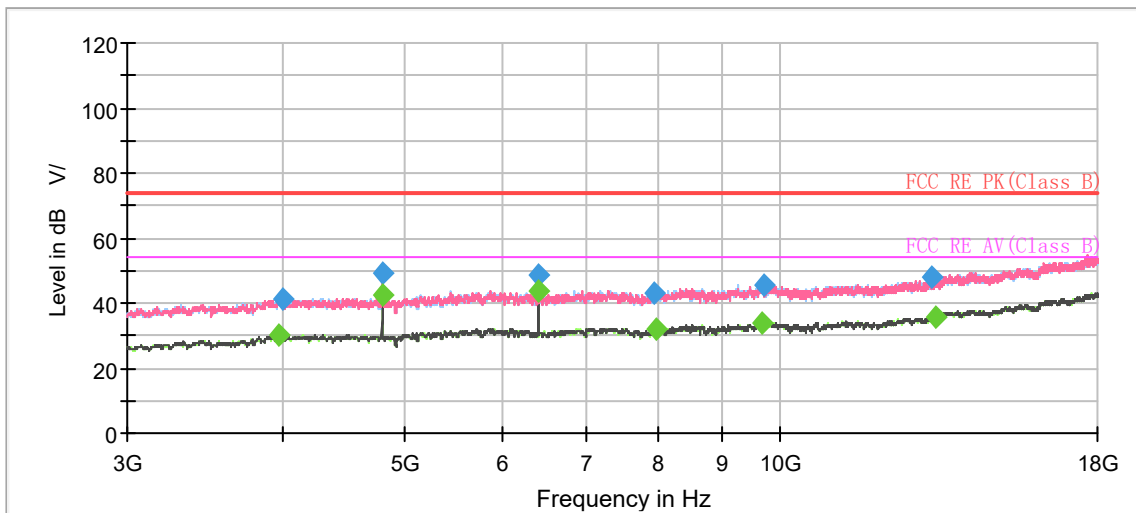

Radiates Emission from 3GHz to 18GHz

Frequency (MHz)	MaxPeak (dBμV/m)	Average (dBμV/m)	Limit (dBμV/m)	Margin (dB)	Meas. Time (ms)	Height (cm)	Pol	Azimuth (deg)	Corr. (dB/m)
1200.000000	---	33.57	54.00	20.43	500.0	100.0	V	246.0	-7.7
1206.500000	46.32	---	74.00	27.68	500.0	100.0	V	274.0	-7.7
1440.000000	---	35.23	54.00	18.77	500.0	200.0	V	359.0	-6.2
1445.500000	45.77	---	74.00	28.23	500.0	100.0	V	320.0	-6.2
1614.500000	46.28	---	74.00	27.72	500.0	100.0	H	98.0	-5.4
1679.500000	---	34.21	54.00	19.79	500.0	100.0	V	188.0	-5.0
1920.250000	46.88	---	74.00	27.12	500.0	100.0	V	164.0	-3.9
1920.500000	---	38.13	54.00	15.87	500.0	100.0	V	159.0	-3.8
2229.000000	47.61	---	74.00	26.39	500.0	200.0	V	46.0	-2.5
2234.250000	---	35.54	54.00	18.46	500.0	100.0	V	57.0	-2.4
2768.750000	---	37.67	54.00	16.33	500.0	100.0	V	345.0	-0.1
2896.250000	51.97	---	74.00	22.03	500.0	100.0	H	98.0	0.3

Remark: 1. Correction Factor = Antenna factor + Insertion loss (cable loss + amplifier gain)

2. Margin = Limit –MAX Peak/ Average

DH5-Channel 39

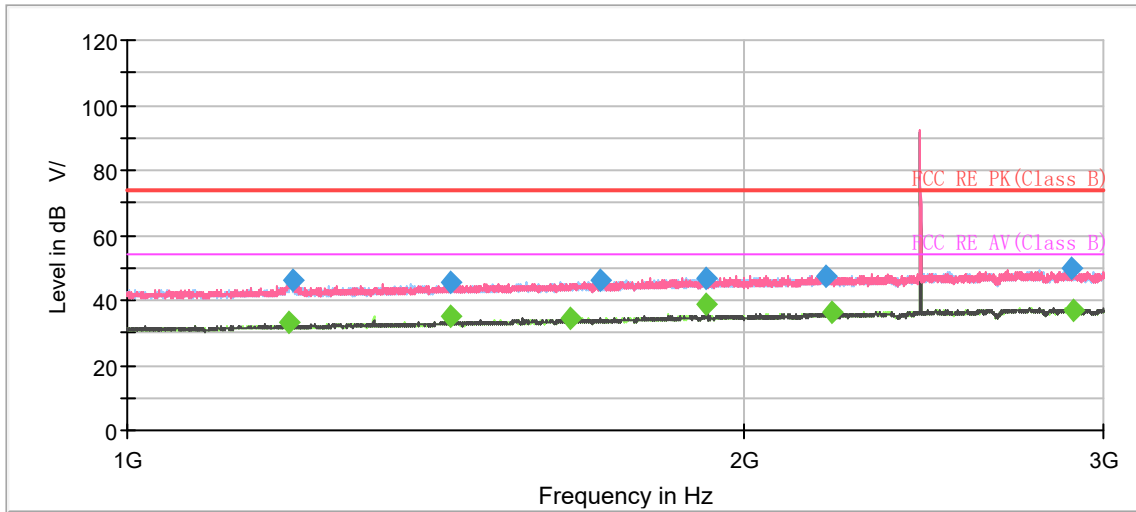

Note: The signal beyond the limit is carrier.
Radiates Emission from 1GHz to 3GHz

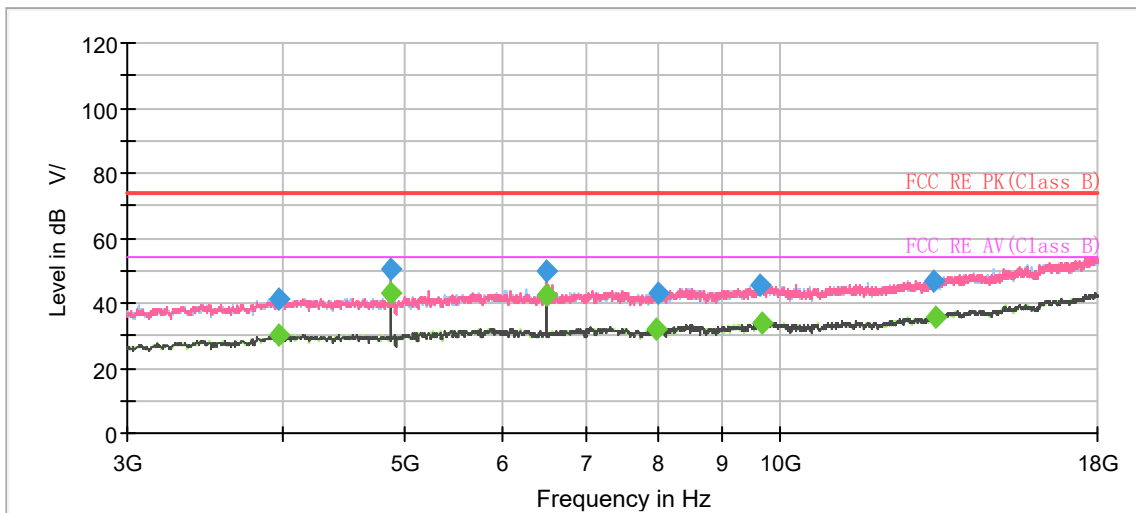

Radiates Emission from 3GHz to 18GHz

Frequency (MHz)	MaxPeak (dBμV/m)	Average (dBμV/m)	Limit (dBμV/m)	Margin (dB)	Meas. Time (ms)	Height (cm)	Pol	Azimuth (deg)	Corr. (dB/m)
1200.000000	---	33.46	54.00	20.54	500.0	100.0	V	172.0	-7.7
1204.250000	46.14	---	74.00	27.86	500.0	100.0	V	328.0	-7.7
1440.250000	---	35.18	54.00	18.82	500.0	100.0	V	204.0	-6.2
1440.250000	45.73	---	74.00	28.27	500.0	200.0	H	216.0	-6.2
1647.000000	---	34.52	54.00	19.48	500.0	200.0	H	286.0	-5.2
1704.750000	46.04	---	74.00	27.96	500.0	200.0	V	60.0	-4.9
1919.750000	46.73	---	74.00	27.27	500.0	100.0	V	159.0	-3.9
1920.250000	---	38.72	54.00	15.28	500.0	100.0	V	159.0	-3.9
2197.500000	47.57	---	74.00	26.43	500.0	200.0	V	188.0	-2.6
2209.250000	---	36.04	54.00	17.96	500.0	100.0	V	128.0	-2.5
2895.750000	49.61	---	74.00	24.39	500.0	100.0	V	194.0	0.3
2901.500000	---	36.99	54.00	17.01	500.0	100.0	H	120.0	0.3

Remark: 1. Correction Factor = Antenna factor + Insertion loss (cable loss + amplifier gain)

2. Margin = Limit –MAX Peak/ Average

DH5-Channel 78

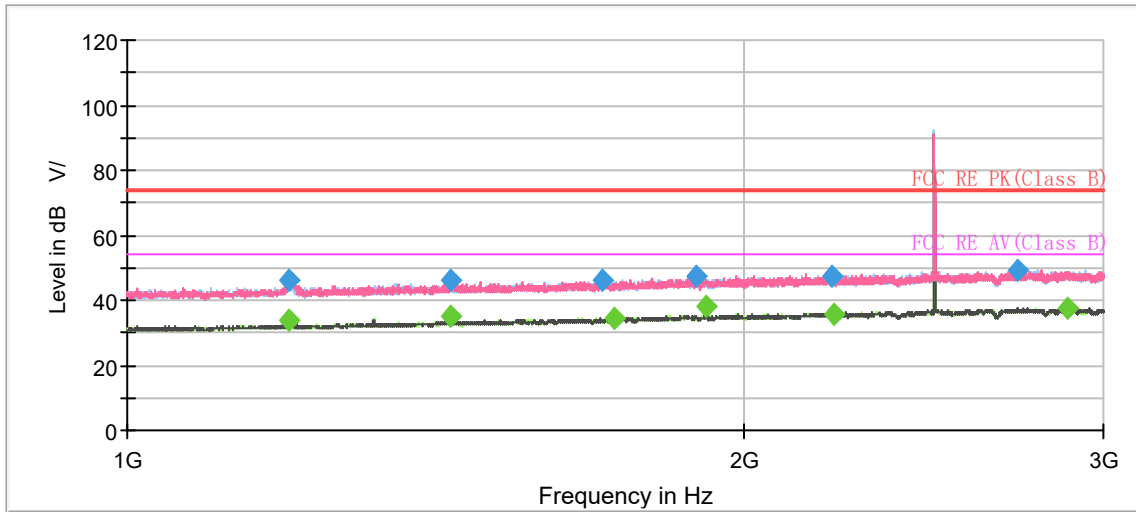

Note: The signal beyond the limit is carrier.
Radiates Emission from 1GHz to 3GHz

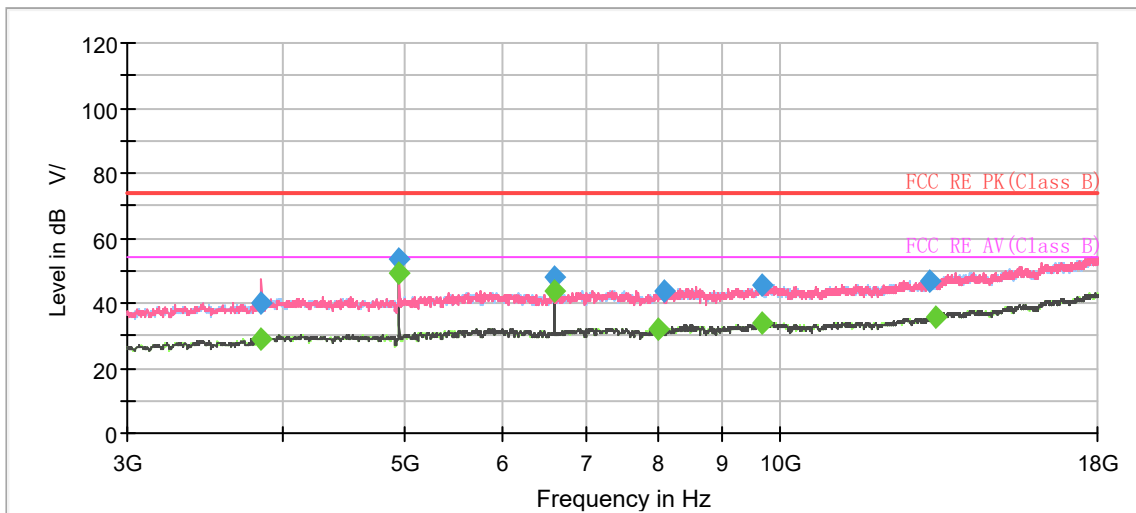

Radiates Emission from 3GHz to 18GHz

Frequency (MHz)	MaxPeak (dBμV/m)	Average (dBμV/m)	Limit (dBμV/m)	Margin (dB)	Meas. Time (ms)	Height (cm)	Pol	Azimuth (deg)	Corr. (dB/m)
1200.000000	---	33.63	54.00	20.37	500.0	100.0	V	166.0	-7.7
1200.000000	46.16	---	74.00	27.84	500.0	100.0	V	166.0	-7.7
1440.000000	46.00	---	74.00	28.00	500.0	200.0	V	0.0	-6.2
1440.250000	---	35.33	54.00	18.67	500.0	100.0	V	359.0	-6.2
1706.750000	45.89	---	74.00	28.11	500.0	100.0	H	13.0	-4.9
1728.500000	---	34.41	54.00	19.59	500.0	200.0	H	340.0	-4.8
1897.750000	47.31	---	74.00	26.69	500.0	200.0	H	254.0	-3.9
1920.250000	---	38.32	54.00	15.68	500.0	100.0	V	157.0	-3.9
2210.500000	47.21	---	74.00	26.79	500.0	200.0	V	118.0	-2.5
2212.750000	---	35.67	54.00	18.33	500.0	100.0	H	212.0	-2.5
2726.500000	49.43	---	74.00	24.57	500.0	100.0	V	6.0	-0.1
2880.250000	---	37.52	54.00	16.48	500.0	100.0	V	157.0	0.2
4959.375000	---	49.16	54.00	4.84	500.0	100.0	V	155.0	-3.7

Remark: 1. Correction Factor = Antenna factor + Insertion loss (cable loss + amplifier gain)

2. Margin = Limit –MAX Peak/ Average

During the test, the Radiates Emission from 18GHz to 26.5GHz was performed in all modes with all channels, BT GFSK DH5-Channel 78 are selected as the worst condition. The test data of the worst-case condition was recorded in this report.

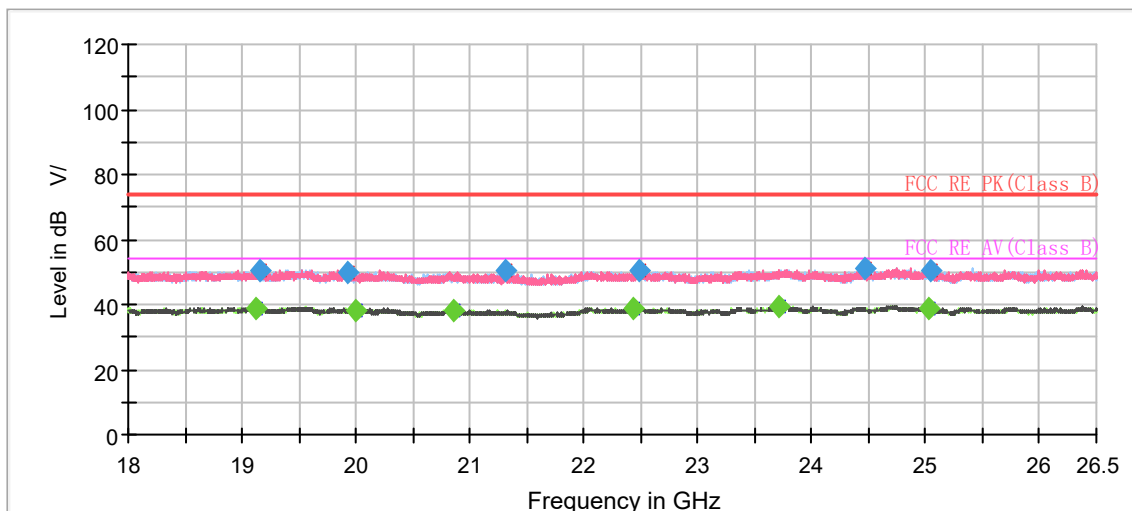

Radiates Emission from 18GHz to 26.5GHz

Frequency (MHz)	MaxPeak (dBµV/m)	Average (dBµV/m)	Limit (dBµV/m)	Margin (dB)	Meas. Time (ms)	Height (cm)	Pol	Azimuth (deg)	Corr. (dB/m)
19127.312500	---	39.01	54.00	14.99	500.0	200.0	V	222.0	-5.7
19163.437500	50.71	---	74.00	23.29	500.0	200.0	H	338.0	-5.6
19926.312500	49.61	---	74.00	24.39	500.0	100.0	H	243.0	-5.2
20001.750000	---	38.36	54.00	15.64	500.0	200.0	H	53.0	-5.2
20863.437500	---	38.37	54.00	15.63	500.0	200.0	H	9.0	-5.1
21318.187500	50.35	---	74.00	23.65	500.0	200.0	H	87.0	-5.2
22433.812500	---	38.80	54.00	15.20	500.0	200.0	V	294.0	-4.0
22492.250000	50.33	---	74.00	23.67	500.0	100.0	H	179.0	-3.9
23708.812500	---	39.56	54.00	14.44	500.0	100.0	V	145.0	-2.4
24458.937500	51.15	---	74.00	22.85	500.0	200.0	H	112.0	-2.7
25032.687500	---	38.89	54.00	15.11	500.0	100.0	V	72.0	-2.5
25052.875000	50.26	---	74.00	23.74	500.0	100.0	V	171.0	-2.6

Remark: 1. Correction Factor = Antenna factor + Insertion loss (cable loss + amplifier gain)
 2. Margin = Limit –MAX Peak/ Average

The Radiates Emission was performed in all EDR mode(2DH5 and 3DH5), 3DH5 was selected as the worse condition. The test data of the worst-case condition was recorded in this report.

During the test, the Radiates Emission from 30MHz to 1GHz was performed in all modes with all channels, 8DPSK 3DH5-Channel 78 are selected as the worst condition. The test data of the worst-case condition was recorded in this report.

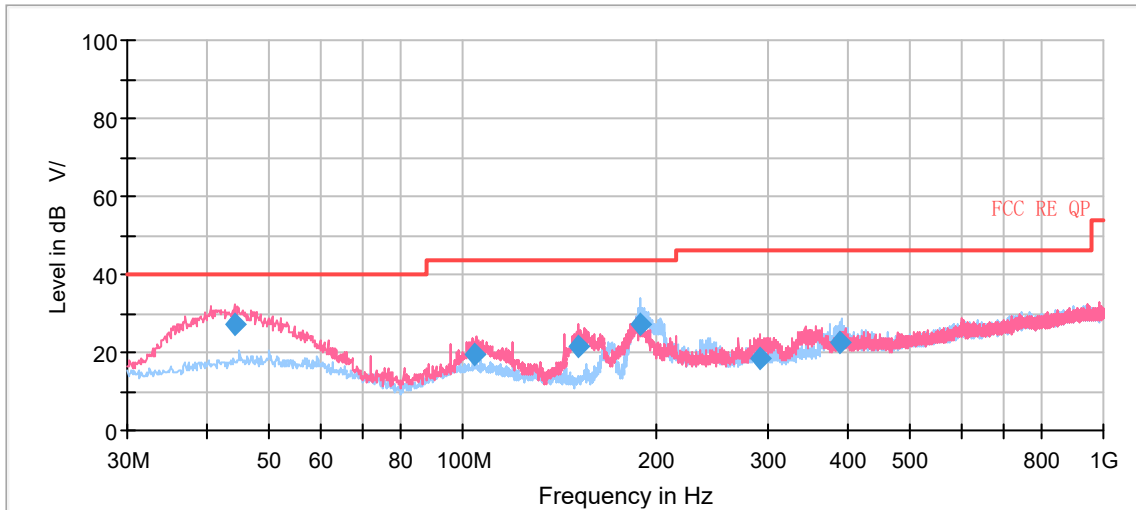

Radiates Emission from 30MHz to 1GHz

Frequency (MHz)	Quasi-Peak (dB μ V/m)	Limit (dB μ V/m)	Margin (dB)	Height (cm)	Polarization	Azimuth (deg)	Correct Factor (dB)
44.225000	26.94	40.00	13.06	100.0	V	1.0	20.3
104.492500	19.67	43.50	23.83	100.0	V	168.0	18.7
151.732500	21.78	43.50	21.72	100.0	V	42.0	14.7
189.560000	27.33	43.50	16.17	175.0	H	252.0	17.5
290.845000	18.32	46.00	27.68	100.0	V	140.0	20.2
389.426250	22.43	46.00	23.57	100.0	H	108.0	22.7

Remark: 1. Correction Factor = Antenna factor + Insertion loss (cable loss + amplifier gain)
 2. Margin = Limit – Quasi-Peak

3DH5-Channel 0

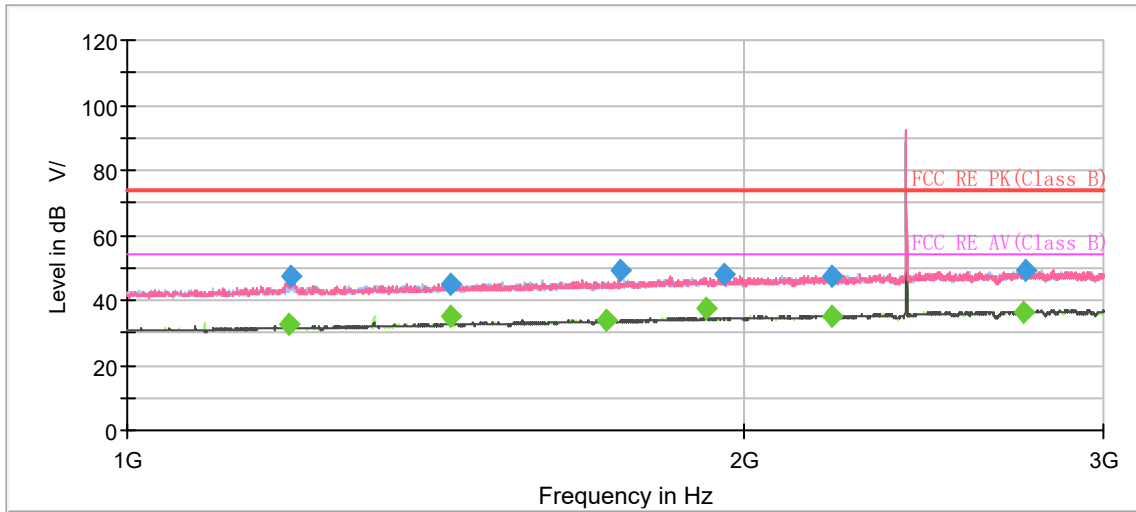

Note: The signal beyond the limit is carrier.
Radiates Emission from 1GHz to 3GHz

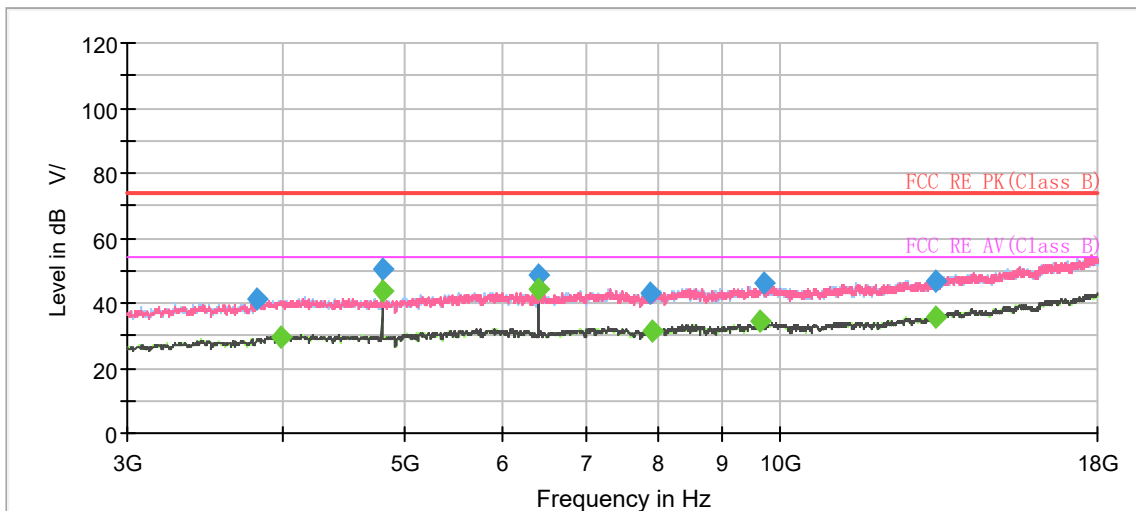

Radiates Emission from 3GHz to 18GHz

Frequency (MHz)	MaxPeak (dBμV/m)	Average (dBμV/m)	Limit (dBμV/m)	Margin (dB)	Meas. Time (ms)	Height (cm)	Pol	Azimuth (deg)	Corr. (dB/m)
1200.000000	---	32.63	54.00	21.37	500.0	100.0	H	48.0	-7.7
1202.000000	47.52	---	74.00	26.48	500.0	100.0	V	77.0	-7.7
1440.000000	---	35.03	54.00	18.97	500.0	200.0	V	163.0	-6.2
1440.000000	45.06	---	74.00	28.94	500.0	100.0	V	255.0	-6.2
1713.000000	---	33.79	54.00	20.21	500.0	200.0	V	133.0	-4.9
1742.000000	49.19	---	74.00	24.81	500.0	100.0	H	145.0	-4.8
1920.000000	---	37.79	54.00	16.21	500.0	100.0	V	157.0	-3.9
1956.000000	47.75	---	74.00	26.25	500.0	100.0	H	230.0	-3.7
2208.000000	47.56	---	74.00	26.44	500.0	100.0	V	353.0	-2.6
2210.000000	---	35.03	54.00	18.97	500.0	100.0	H	90.0	-2.5
2739.500000	---	36.39	54.00	17.62	500.0	200.0	H	284.0	-0.1
2748.500000	49.31	---	74.00	24.69	500.0	200.0	H	230.0	-0.1

Remark: 1. Correction Factor = Antenna factor + Insertion loss (cable loss + amplifier gain)

2. Margin = Limit –MAX Peak/ Average

3DH5-Channel 39

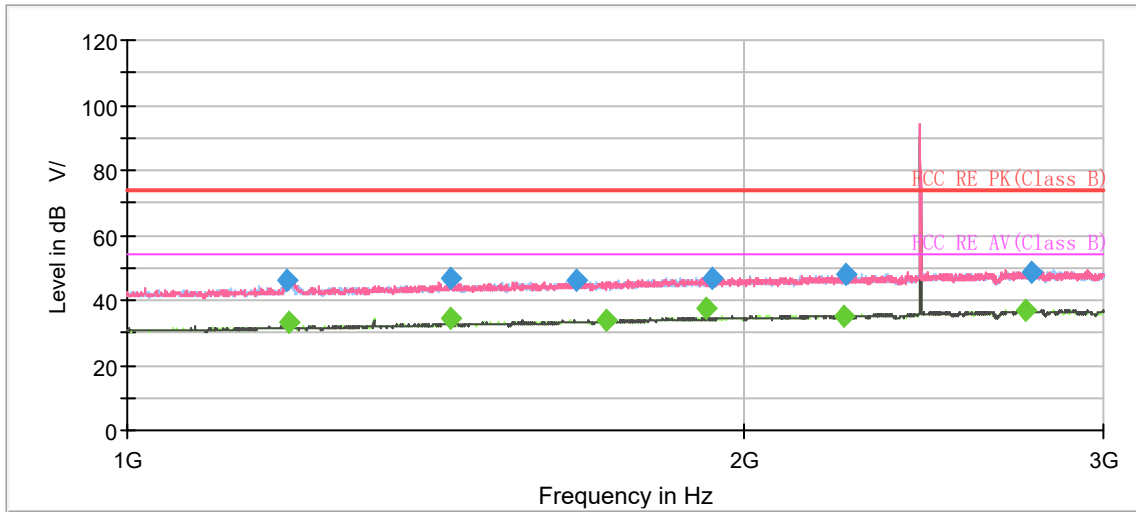

Note: The signal beyond the limit is carrier.
Radiates Emission from 1GHz to 3GHz

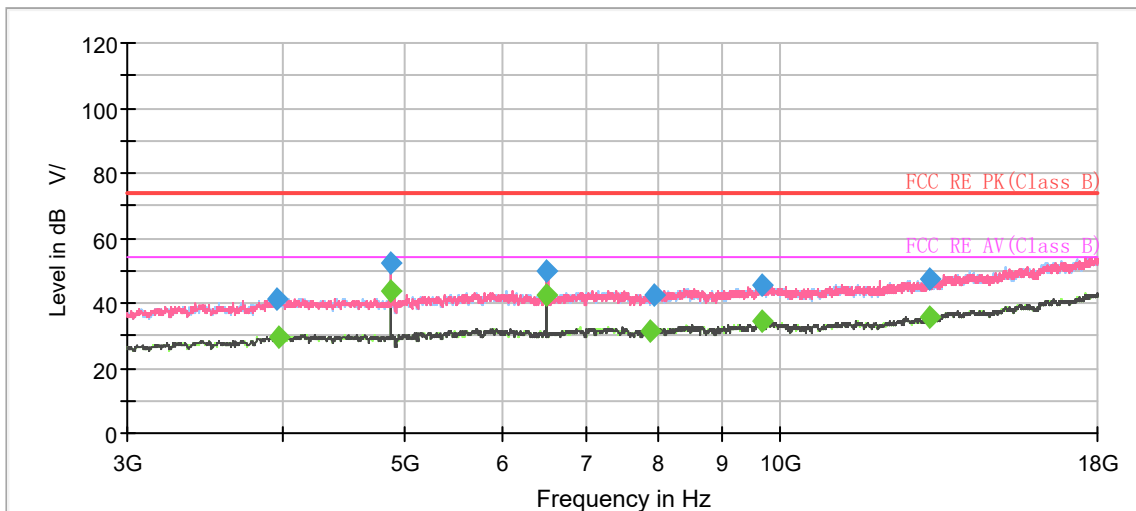

Radiates Emission from 3GHz to 18GHz

Frequency (MHz)	MaxPeak (dBμV/m)	Average (dBμV/m)	Limit (dBμV/m)	Margin (dB)	Meas. Time (ms)	Height (cm)	Pol	Azimuth (deg)	Corr. (dB/m)
1197.500000	45.86	---	74.00	28.14	500.0	200.0	V	114.0	-7.7
1199.500000	---	32.95	54.00	21.05	500.0	100.0	V	168.0	-7.7
1440.000000	---	34.47	54.00	19.53	500.0	200.0	V	0.0	-6.2
1440.000000	46.91	---	74.00	27.09	500.0	200.0	V	0.0	-6.2
1657.000000	46.15	---	74.00	27.85	500.0	200.0	H	310.0	-5.1
1714.000000	---	33.82	54.00	20.18	500.0	200.0	H	257.0	-4.9
1920.000000	---	37.71	54.00	16.29	500.0	100.0	V	160.0	-3.9
1929.500000	46.55	---	74.00	27.45	500.0	200.0	H	257.0	-3.8
2241.500000	---	35.08	54.00	18.92	500.0	200.0	H	359.0	-2.4
2246.500000	48.08	---	74.00	25.92	500.0	200.0	V	0.0	-2.4
2751.000000	---	36.89	54.00	17.11	500.0	100.0	V	356.0	-0.1
2765.000000	48.75	---	74.00	25.25	500.0	200.0	H	237.0	-0.1

Remark: 1. Correction Factor = Antenna factor + Insertion loss (cable loss + amplifier gain)

2. Margin = Limit –MAX Peak/ Average

3DH5-Channel 78

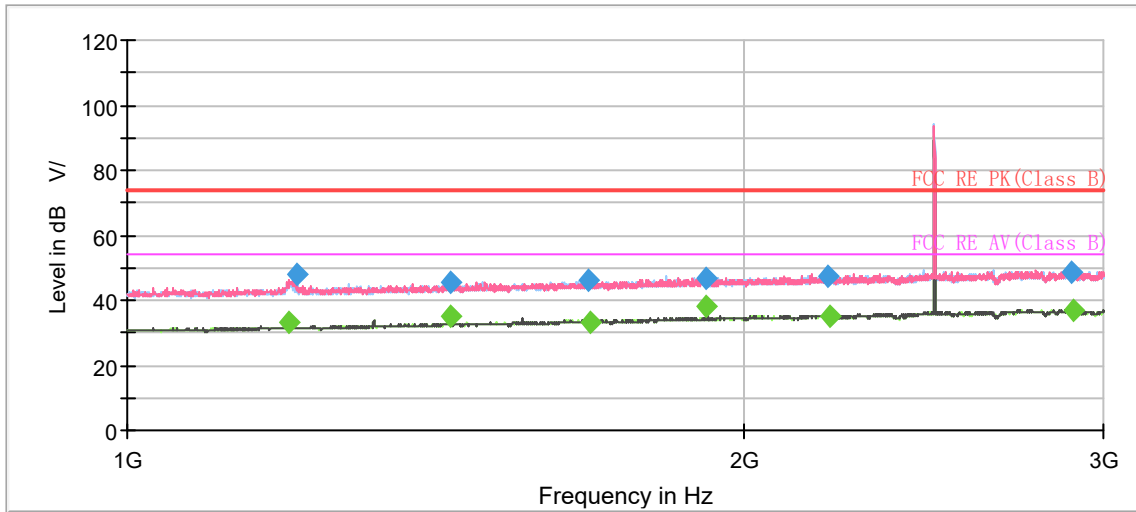

Note: The signal beyond the limit is carrier.
Radiates Emission from 1GHz to 3GHz

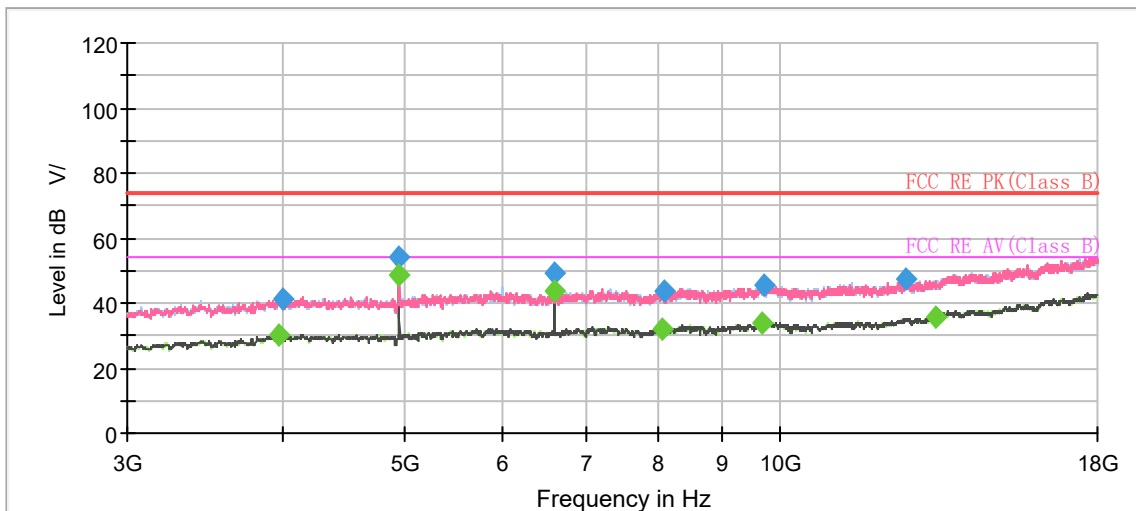

Radiates Emission from 3GHz to 18GHz

Frequency (MHz)	MaxPeak (dBμV/m)	Average (dBμV/m)	Limit (dBμV/m)	Margin (dB)	Meas. Time (ms)	Height (cm)	Pol	Azimuth (deg)	Corr. (dB/m)
1200.000000	---	33.50	54.00	20.50	500.0	100.0	V	214.0	-7.7
1211.500000	47.79	---	74.00	26.21	500.0	100.0	H	0.0	-7.6
1439.500000	45.29	---	74.00	28.71	500.0	100.0	V	258.0	-6.2
1440.000000	---	34.79	54.00	19.21	500.0	200.0	V	8.0	-6.2
1679.500000	45.99	---	74.00	28.01	500.0	200.0	V	77.0	-5.0
1683.500000	---	33.14	54.00	20.86	500.0	100.0	H	100.0	-5.0
1920.000000	47.06	---	74.00	26.94	500.0	100.0	V	163.0	-3.9
1920.000000	---	38.21	54.00	15.79	500.0	100.0	V	163.0	-3.9
2198.000000	47.65	---	74.00	26.35	500.0	100.0	H	44.0	-2.6
2204.000000	---	35.18	54.00	18.82	500.0	200.0	H	179.0	-2.6
2895.000000	48.84	---	74.00	25.16	500.0	200.0	V	69.0	0.3
2898.000000	---	37.00	54.00	17.00	500.0	200.0	V	202.0	0.3
4959.375000	---	48.69	54.00	5.31	500.0	100.0	V	152.0	-3.7

Remark: 1. Correction Factor = Antenna factor + Insertion loss (cable loss + amplifier gain)

2. Margin = Limit -MAX Peak/ Average

During the test, the Radiates Emission from 18GHz to 26.5GHz was performed in all modes with all channels, 8DPSK 3DH5-Channel 78 are selected as the worst condition. The test data of the worst-case condition was recorded in this report.

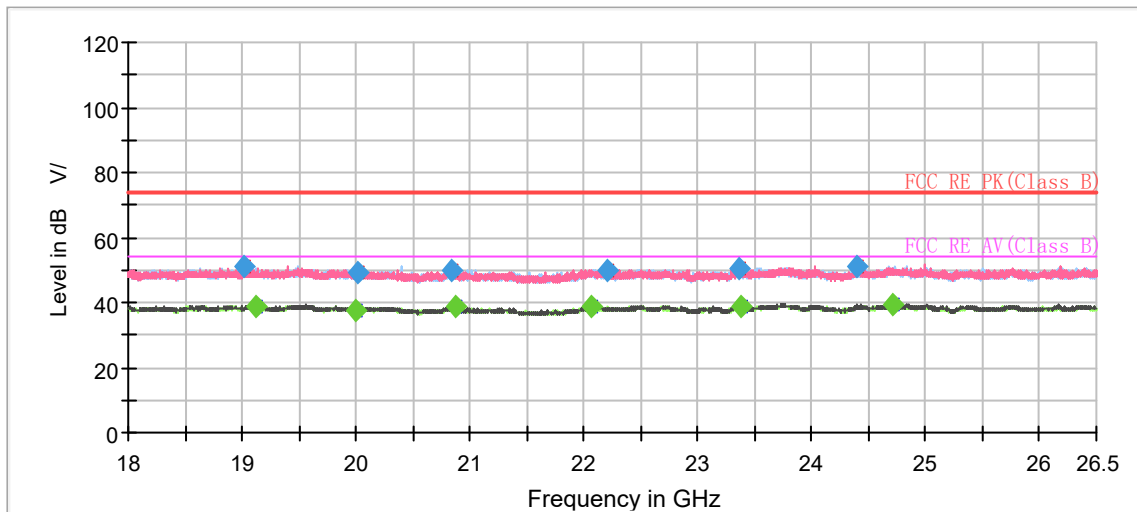

Radiates Emission from 18GHz to 26.5GHz

Frequency (MHz)	MaxPeak (dBμV/m)	Average (dBμV/m)	Limit (dBμV/m)	Margin (dB)	Meas. Time (ms)	Height (cm)	Pol	Azimuth (deg)	Corr. (dB/m)
19009.375000	50.89	---	74.00	23.11	500.0	100.0	H	278.0	-5.6
19127.312500	---	39.04	54.00	14.96	500.0	100.0	H	353.0	-5.7
19990.062500	---	37.83	54.00	16.17	500.0	100.0	H	239.0	-5.2
20013.437500	49.22	---	74.00	24.78	500.0	100.0	V	286.0	-5.2
20833.687500	50.09	---	74.00	23.91	500.0	200.0	V	353.0	-5.1
20868.750000	---	38.68	54.00	15.33	500.0	100.0	V	286.0	-5.1
22066.187500	---	38.87	54.00	15.13	500.0	100.0	V	335.0	-4.2
22211.750000	50.14	---	74.00	23.86	500.0	200.0	V	114.0	-4.1
23360.312500	50.29	---	74.00	23.71	500.0	200.0	V	40.0	-3.4
23375.187500	---	38.83	54.00	15.17	500.0	200.0	H	97.0	-3.3
24397.312500	51.37	---	74.00	22.63	500.0	100.0	V	146.0	-2.9
24712.875000	---	39.50	54.00	14.50	500.0	100.0	H	338.0	-2.1

Remark: 1. Correction Factor = Antenna factor + Insertion loss (cable loss + amplifier gain)
 2. Margin = Limit –MAX Peak/ Average

5.9 Conducted Emission

Ambient condition

Temperature	Relative humidity
20°C ~ 25°C	45% ~ 50%

Methods of Measurement

The EUT is placed on a non-metallic table of 80cm height above the horizontal metal reference ground plane. During the test, the EUT was operating in its typical mode. The test method is according to ANSI C63.10. Connect the AC power line of the EUT to the L.I.S.N. Use EMI receiver to detect the average and Quasi-peak value. RBW is set to 9 kHz, VBW is set to 30kHz. The measurement result should include both L line and N line.

The test is in transmitting mode.

Test Setup

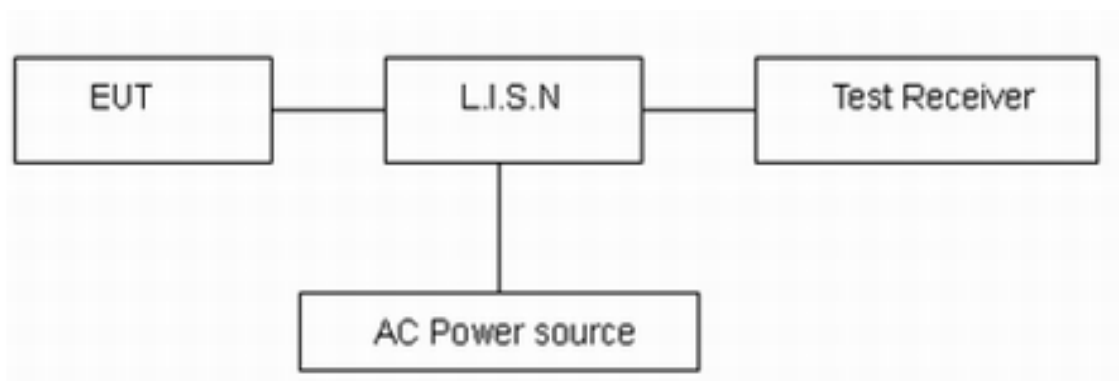

Note: AC Power source is used to 120V/60Hz.

Limits

Frequency (MHz)	Conducted Limits(dB μ V)	
	Quasi-peak	Average
0.15 - 0.5	66 to 56 *	56 to 46 *
0.5 - 5	56	46
5 - 30	60	50

*: Decreases with the logarithm of the frequency.

Measurement Uncertainty

The assessed measurement uncertainty to ensure 95% confidence level for the normal distribution is with the coverage factor $k = 1.96$, $U=2.69$ dB.

Test Results:

The equipment doesn't connect to public network, therefore this requirement does not apply.

6 Main Test Instruments

Name	Manufacturer	Type	Serial Number	Calibration Date	Expiration Date
EMI Test Receiver	R&S	ESR	102389	2023-05-12	2024-05-11
Signal Analyzer	R&S	FSV40	101186	2023-05-12	2024-05-11
Loop Antenna	SCHWARZBECK	FMZB1519	1519-047	2023-04-16	2026-04-15
TRILOG Broadband Antenna	SCHWARZBECK	VULB 9163	1023	2023-07-14	2026-07-13
Horn Antenna	R&S	HF907	102723	2021-07-24	2024-07-23
Horn Antenna	ETS-Lindgren	3160-09	00102643	2021-10-10	2024-10-09
Software	R&S	EMC32	9.26.0	/	/
Spectrum Analyzer	KEYSIGHT	N9020A	MY51330870	2023-05-12	2024-05-11
DC Power Supply	UNI-T	UTP1306S+	2205D0517426	2022-12-10	2023-12-09

ANNEX A: The EUT Appearance

The EUT Appearance are submitted separately.

ANNEX B: Test Setup Photos

The Test Setup Photos are submitted separately.

***** END OF REPORT *****