



Neutron Engineering Inc.

# FCC&IC Radio Test Report

**FCC ID: ACJ-SH-ALL1C**

**IC: 216A-SHALL1C**

This report concerns (check one):  Original Grant  Class II Change

Issued Date : Jan. 23, 2014  
Project No. : 1312C280  
Equipment : NETWORK AUDIO CONNECTOR  
Model Name : SH-ALL1C  
Applicant for FCC : Panasonic Corporation of North America  
Applicant for IC : Panasonic Canada Inc.  
Address for FCC : Two Riverfront Plaza, 9<sup>th</sup> Floor Newark  
New Jersey United States 07102-5490  
Address for IC : 5770 Ambler Drive Mississauga  
Ontario L4W 2T3 Canada

Tested by: Neutron Engineering Inc. EMC Laboratory  
Date of Receipt: Dec. 31, 2013  
Date of Test: Dec. 31, 2013 ~ Jan. 22, 2014

Testing Engineer : David Mao  
(David Mao)

Technical Manager : Leo Hung  
(Leo Hung)

Authorized Signatory : Steven Lu  
(Steven Lu)

## Neutron Engineering Inc.

No.3, Jinshagang 1st Road, ShiXia,  
Dalang Town, Dong Guan, China.

TEL: 0769-8318-3000

FAX: 0769-8319-6000



### **Declaration**

**Neutron** represents to the client that testing is done in accordance with standard procedures as applicable and that test instruments used has been calibrated with the standards traceable to National Measurement Laboratory (**NML**) of **R.O.C.**, or National Institute of Standards and Technology (**NIST**) of **U.S.A.**

**Neutron's** reports apply only to the specific samples tested under conditions. It is manufacture's responsibility to ensure that additional production units of this model are manufactured with the identical electrical and mechanical components. **Neutron** shall have no liability for any declarations, inferences or generalizations drawn by the client or others from **Neutron** issued reports.

**Neutron's** reports must not be used by the client to claim product endorsement by the authorities or any agency of the Government.

This report is the confidential property of the client. As a mutual protection to the clients, the public and **Neutron-self**, extracts from the test report shall not be reproduced except in full with **Neutron's** authorized written approval.

**Neutron's** laboratory quality assurance procedures are in compliance with the **ISO Guide 17025** requirements, and accredited by the conformity assessment authorities listed in this test report.

### **Limitation**

For the use of the authority's logo is limited unless the Test Standard(s)/Scope(s)/Item(s) mentioned in this test report is (are) included in the conformity assessment authorities acceptance respective.



<b>Table of Contents</b>	<b>Page</b>
<b>1 . CERTIFICATION</b>	<b>6</b>
<b>2 . SUMMARY OF TEST RESULTS</b>	<b>7</b>
2.1 TEST FACILITY	8
2.2 MEASUREMENT UNCERTAINTY	8
<b>3 . GENERAL INFORMATION</b>	<b>9</b>
3.1 GENERAL DESCRIPTION OF EUT	9
3.2 DESCRIPTION OF TEST MODES	11
3.3 TABLE OF PARAMETERS OF TEXT SOFTWARE SETTING	12
3.4 BLOCK DIAGRAM SHOWING THE CONFIGURATION OF SYSTEM TESTED	13
3.5 DESCRIPTION OF SUPPORT UNITS	14
<b>4 . EMC EMISSION TEST</b>	<b>15</b>
4.1 CONDUCTED EMISSION MEASUREMENT	15
4.1.1 POWER LINE CONDUCTED EMISSION LIMITS	15
4.1.2 TEST PROCEDURE	15
4.1.3 DEVIATION FROM TEST STANDARD	15
4.1.4 TEST SETUP	16
4.1.5 EUT OPERATING CONDITIONS	16
4.1.6 EUT TEST CONDITIONS	16
4.1.7 TEST RESULTS	16
4.2 RADIATED EMISSION MEASUREMENT	19
4.2.1 RADIATED EMISSION LIMITS	19
4.2.2 TEST PROCEDURE	20
4.2.3 DEVIATION FROM TEST STANDARD	20
4.2.4 TEST SETUP	21
4.2.5 EUT OPERATING CONDITIONS	22
4.2.6 EUT TEST CONDITIONS	22
4.2.7 TEST RESULTS (9K~ 30MHZ)	23
4.2.8 TEST RESULTS (BETWEEN 30 – 1000 MHZ)	24
4.2.9 TEST RESULTS (ABOVE 1000 MHZ)	31
<b>5 . BANDWIDTH TEST</b>	<b>51</b>
5.1 APPLIED PROCEDURES	51
5.1.1 TEST PROCEDURE	51
5.1.2 DEVIATION FROM STANDARD	51
5.1.3 TEST SETUP	51
5.1.4 EUT OPERATION CONDITIONS	51
5.1.5 EUT TEST CONDITIONS	51
5.1.6 TEST RESULTS	52



Table of Contents	Page
<b>6 . MAXIMUM OUTPUT POWER TEST</b>	<b>62</b>
<b>6.1 APPLIED PROCEDURES / LIMIT</b>	<b>62</b>
6.1.1 TEST PROCEDURE	62
6.1.2 DEVIATION FROM STANDARD	62
6.1.3 TEST SETUP	62
6.1.4 EUT OPERATION CONDITIONS	62
6.1.5 EUT TEST CONDITIONS	62
6.1.6 TEST RESULTS	63
<b>7 . ANTENNA CONDUCTED SPURIOUS EMISSION</b>	<b>66</b>
<b>7.1 APPLIED PROCEDURES / LIMIT</b>	<b>66</b>
7.1.1 TEST PROCEDURE	66
7.1.2 DEVIATION FROM STANDARD	66
7.1.3 TEST SETUP	66
7.1.4 EUT OPERATION CONDITIONS	66
7.1.5 EUT TEST CONDITIONS	66
7.1.6 TEST RESULTS	67
<b>8 . POWER SPECTRAL DENSITY TEST</b>	<b>90</b>
<b>8.1 APPLIED PROCEDURES / LIMIT</b>	<b>90</b>
8.1.1 TEST PROCEDURE	90
8.1.2 DEVIATION FROM STANDARD	90
8.1.3 TEST SETUP	90
8.1.4 EUT OPERATION CONDITIONS	90
8.1.5 EUT TEST CONDITIONS	90
8.1.6 TEST RESULTS	91
<b>9 . MEASUREMENT INSTRUMENTS LIST</b>	<b>103</b>
<b>10 . EUT TEST PHOTO</b>	<b>105</b>



**REPORT ISSUED HISTORY**

Issued No.	Description	Issued Date
NEI-FICP-3-1312C280	Original Issue.	Jan. 23, 2014



## 1. CERTIFICATION

Equipment : NETWORK AUDIO CONNECTOR  
Brand Name : Panasonic  
Model Name : SH-ALL1C  
Applicant for : Panasonic Corporation of North America  
FCC  
Applicant for : Panasonic Canada Inc.  
IC  
Manufacturer : Panasonic  
Address : 1-15 Matsuo-cho, Kadoma City, Osaka 571-8504, Japan  
Factory : Panasonic AVC Networks Johor Malaysia Sdn.Bhd.  
Address : IE,PLO 460,Jalan Bandar, 81700 Pasir Gudang,Johor, Malaysia  
Date of Test : Dec. 31, 2013 ~ Jan. 22, 2014  
Test Item : ENGINEERING SAMPLE  
Standard(s) : FCC Part15, Subpart C(15.247) / ANSI C63.4-2009  
Canada RSS-210:2010  
RSS-GEN Issue 3, Dec 2010

The above equipment has been tested and found compliance with the requirement of the relative standards by Neutron Engineering Inc. EMC Laboratory.  
The test data, data evaluation, and equipment configuration contained in our test report (Ref No. NEI-FICP-3-1312C280) were obtained utilizing the test procedures, test instruments, test sites that has been accredited by the Authority of TAF according to the ISO-17025 quality assessment standard and technical standard(s).



**2. SUMMARY OF TEST RESULTS**

Test procedures according to the technical standard(s):

<b>Applied Standard(s): FCC Part15 (15.247) , Subpart C Canada RSS-210:2010; RSS-GEN Issue 3, Dec 2010</b>					
Standard(s)		Section	Test Item	Judgment	Remark
FCC	IC				
15.207		RSS-GEN 7.2.2	Conducted Emission	PASS	
15.247(d)		RSS-210 Annex 8 (A8.5)	Antenna conducted Spurious Emission	PASS	
15.247(a)(2)		RSS-210 Annex 8 (A8.2(a))	6dB Bandwidth	PASS	
15.247(b)(3)		RSS-210 Annex 8 (A8.4(4))	Peak Output Power	PASS	
15.247(e)		RSS-210 Annex 8 (A8.2(b))	Power Spectral Density	PASS	
15.203		-	Antenna Requirement	PASS	
15.209/15.205		RSS-210 Annex 8 (A8.5)	Transmitter Radiated Emissions	PASS	

**NOTE:**

- (1) "N/A" denotes test is not applicable in this test report.
- (2) The test follows FCC KDB Publication No. 558074 D01 DTS Meas Guidance v03r01 (Measurement Guidelines of DTS)



**2.1 TEST FACILITY**

The test facilities used to collect the test data in this report is **DG-C02/DG-CB03** at the location of No.3,Jinshagang 1st Road, ShiXia, Dalang Town, Dong Guan, China.523792

Neutron's test firm number for FCC: 319330

Neutron's test firm number for IC: 4428B-1

**2.2 MEASUREMENT UNCERTAINTY**

Where relevant, the following measurement uncertainty levels have been estimated for tests performed on the EUT as specified in CISPR 16-4-2:

The reported uncertainty of measurement  $y \pm U$ , where expanded uncertainty  $U$  is based on a standard uncertainty multiplied by a coverage factor of  $k=2$ , providing a level of confidence of approximately 95 %.

**A. Conducted Measurement :**

Test Site	Method	Measurement Frequency Range	U , (dB)	NOTE
DG-C02	CISPR	150 KHz ~ 30MHz	1.94	

**B. Radiated Measurement :**

Test Site	Method	Measurement Frequency Range	Ant. H / V	U , (dB)	NOTE
DG-CB03	CISPR	9KHz~30MHz	V	3.79	
		9KHz~30MHz	H	3.57	
		30MHz ~ 200MHz	V	3.82	
		30MHz ~ 200MHz	H	3.60	
		200MHz ~ 1,000MHz	V	3.86	
		200MHz ~ 1,000MHz	H	3.94	
		1GHz~18GHz	V	3.12	
		1GHz~18GHz	H	3.68	
		18GHz~40GHz	V	4.15	
		18GHz~40GHz	H	4.14	



**3. GENERAL INFORMATION**

**3.1 GENERAL DESCRIPTION OF EUT**

Equipment	NETWORK AUDIO CONNECTOR	
Brand Name	Panasonic	
Model Name	SH-ALL1C	
Model Difference	N/A	
Product Description	Operation Frequency	5745~5825 MHz
	Modulation Technology	802.11a/n:OFDM
	Bit Rate of Transmitter	300Mbps
	Output Power (Max.)	802.11a: 21.71 dBm 802.11n(20MHz): 23.77 dBm 802.11n(40MHz): 23.42 dBm
Power Source	AC mains.	
Power Rating	120V 60Hz	
Connecting I/O Port(s)	Please refer to the User's Manual	

**Note:**

1. For a more detailed features description, please refer to the manufacturer's specifications or the User's Manual.



2.

802.11a / 802.11n 20M					
Channel	Frequency (MHz)	Channel	Frequency (MHz)	Channel	Frequency (MHz)
<b>149</b>	<b>5745</b>	153	5765	<b>157</b>	<b>5785</b>
161	5805	<b>165</b>	<b>5825</b>		

802.11n 40M			
Channel	Frequency (MHz)	Channel	Frequency (MHz)
<b>151</b>	<b>5755</b>	<b>159</b>	<b>5795</b>

3. Table for Filed Antenna

Ant.	Manufacturer	Model Name	Antenna Type	Connector	Gain (dBi)	Note
1	N/A	N/A	Internal	N/A	3.1	TX/RX
2	N/A	N/A	Internal	N/A	3.0	TX/RX

Note:

(1) The EUT incorporates a MIMO function. Physically, the EUT provides two completed two transmitters and two receivers (2T2R), all transmit signals are completely uncorrelated, then, **Direction gain = G<sub>ANT</sub>**, that is Directional gain=3.1.

(2) The EUT is considered two different ANT types, internal ANT is testing and recording in test report, PCB ANT is not used.

4.

Operating Mode	1TX	2TX
	TX Mode	
802.11a	V (ANT 1 or ANT 2)	-
802.11n(20MHz)	-	V (ANT 1 + ANT 2)
802.11n(40MHz)	-	V (ANT 1 + ANT 2)



**3.2 DESCRIPTION OF TEST MODES**

To investigate the maximum EMI emission characteristics generates from EUT, the test system was pre-scanning tested base on the consideration of following EUT operation mode or test configuration mode which possible have effect on EMI emission level. Each of these EUT operation mode(s) or test configuration mode(s) mentioned above was evaluated respectively.

Pretest Mode	Description
Mode 1	TX A MODE CHANNEL 149/157/165
Mode 2	TX N-20MHZ MODE CHANNEL 149/157/165
Mode 3	TX N-40MHZ MODE CHANNEL 151/159
Mode 4	TX MODE

The EUT system operated these modes were found to be the worst case during the pre-scanning test as following:

<b>For Conducted Test</b>	
Final Test Mode	Description
Mode 4	TX MODE

<b>For Radiated Test</b>	
Final Test Mode	Description
Mode 1	TX A MODE CHANNEL 149/157/165
Mode 2	TX N-20MHZ MODE CHANNEL 149/157/165
Mode 3	TX N-40MHZ MODE CHANNEL 151/159

Note:

- (1) For radiated below 1G test, the 802.11a is found to be the worst case and recorded.



**3.3 TABLE OF PARAMETERS OF TEXT SOFTWARE SETTING**

During testing, channel & power controlling software provided by the customer was used to control the operating channel as well as the output power level. The RF output power selection is for the setting of RF output power expected by the customer and is going to be fixed on the firmware of the final end product power parameters of WLAN

Test software version	art_ver_4_6_153_10		
<b>Frequency</b>	<b>5745 MHz</b>	<b>5785 MHz</b>	<b>5825 MHz</b>
IEEE 802.11a	28.5	24.5	25
IEEE 802.11 n (20MHz)	22	22	22

Test software version	art_ver_4_6_153_10	
<b>Frequency</b>	<b>5755 MHz</b>	<b>5795 MHz</b>
IEEE 802.11 n (40MHz)	19	19



**3.4 BLOCK DIAGRAM SHOWING THE CONFIGURATION OF SYSTEM TESTED**

**Conducted TX Mode:**

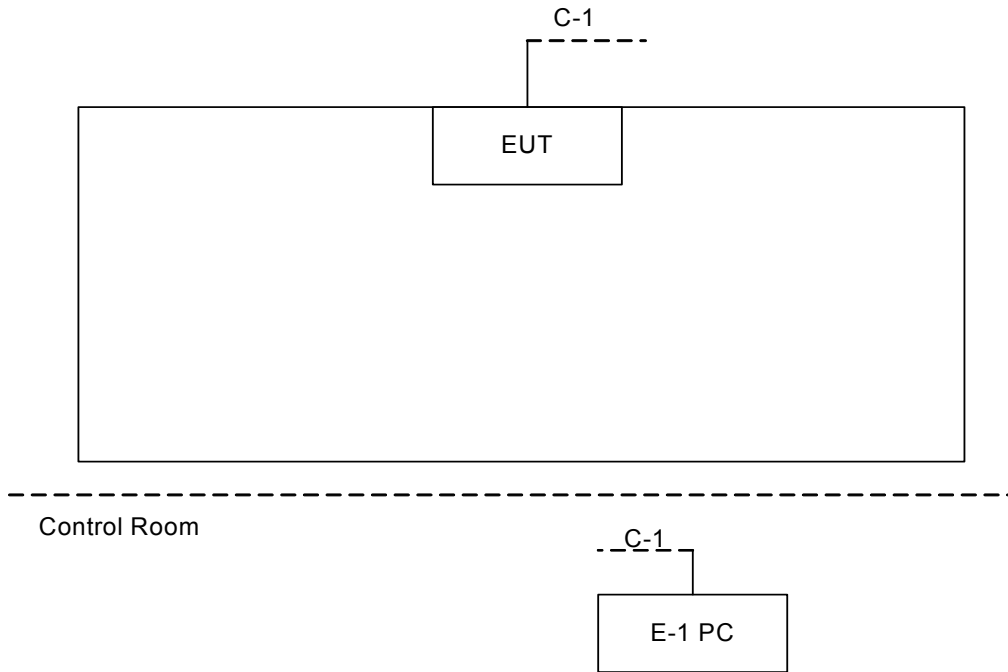

**Radiated TX Mode:**

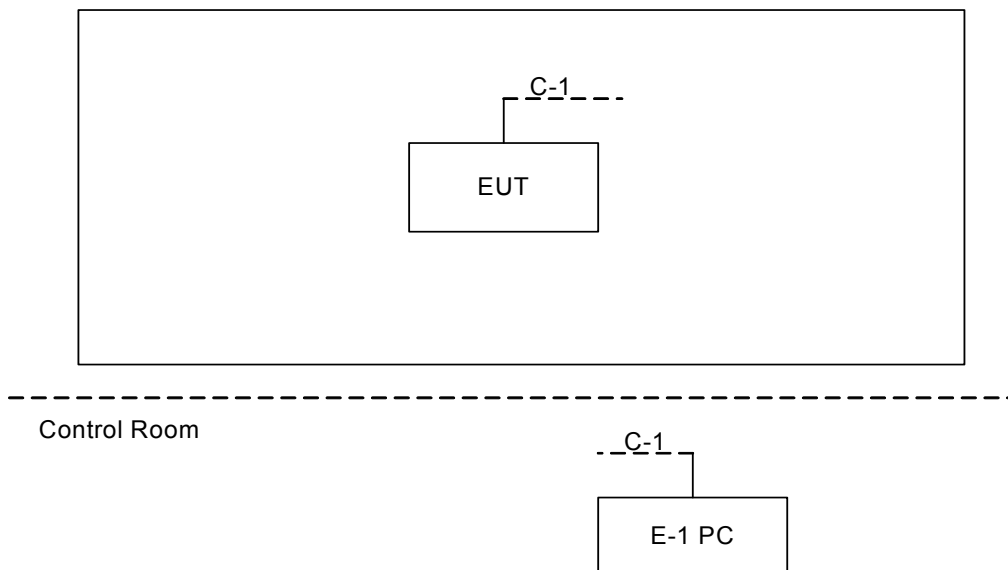



### 3.5 DESCRIPTION OF SUPPORT UNITS

The EUT has been tested as an independent unit together with other necessary accessories or support units. The following support units or accessories were used to form a representative test configuration during the tests.

Item	Equipment	Mfr/Brand	Model/Type No.	FCC ID/IC	Series No.	Note
E-1	PC	HP	G3321Cx	DOC	CNX8120R16	

Item	Shielded Type	Ferrite Core	Length	Note
C-1	NO	NO	10m	RJ45 Cable



**4. EMC EMISSION TEST**

**4.1 CONDUCTED EMISSION MEASUREMENT**

**4.1.1 POWER LINE CONDUCTED EMISSION Limits (Frequency Range 150KHz-30MHz)**

Frequency (MHz)	Class A (dBuV)		Class B (dBuV)		Standard
	Quasi-peak	Average	Quasi-peak	Average	
0.15 -0.5	79.00	66.00	66 - 56 *	56 - 46 *	CISPR
0.50 -5.0	73.00	60.00	56.00	46.00	CISPR
5.0 -30.0	73.00	60.00	60.00	50.00	CISPR
0.15 -0.5	79.00	66.00	66 - 56 *	56 - 46 *	FCC
0.50 -5.0	73.00	60.00	56.00	46.00	FCC
5.0 -30.0	73.00	60.00	60.00	50.00	FCC

Note:

- (1) The tighter limit applies at the band edges.
- (2) The limit of " \* " marked band means the limitation decreases linearly with the logarithm of the frequency in the range.

The following table is the setting of the receiver

Receiver Parameters	Setting
Attenuation	10 dB
Start Frequency	0.15 MHz
Stop Frequency	30 MHz
IF Bandwidth	9 KHz

**4.1.2 TEST PROCEDURE**

- a. The EUT was placed 0.8 meters from the horizontal ground plane with EUT being connected to the power mains through a line impedance stabilization network (LISN). All other support equipments powered from additional LISN(s). The LISN provide 50 Ohm/ 50uH of coupling impedance for the measuring instrument.
- b. Interconnecting cables that hang closer than 40 cm to the ground plane shall be folded back and forth in the center forming a bundle 30 to 40 cm long.
- c. I/O cables that are not connected to a peripheral shall be bundled in the center. The end of the cable may be terminated, if required, using the correct terminating impedance. The overall length shall not exceed 1 m.
- d. LISN at least 80 cm from nearest part of EUT chassis.
- e. For the actual test configuration, please refer to the related Item –EUT Test Photos.

**4.1.3 DEVIATION FROM TEST STANDARD**

No deviation

**4.1.4 TEST SETUP**

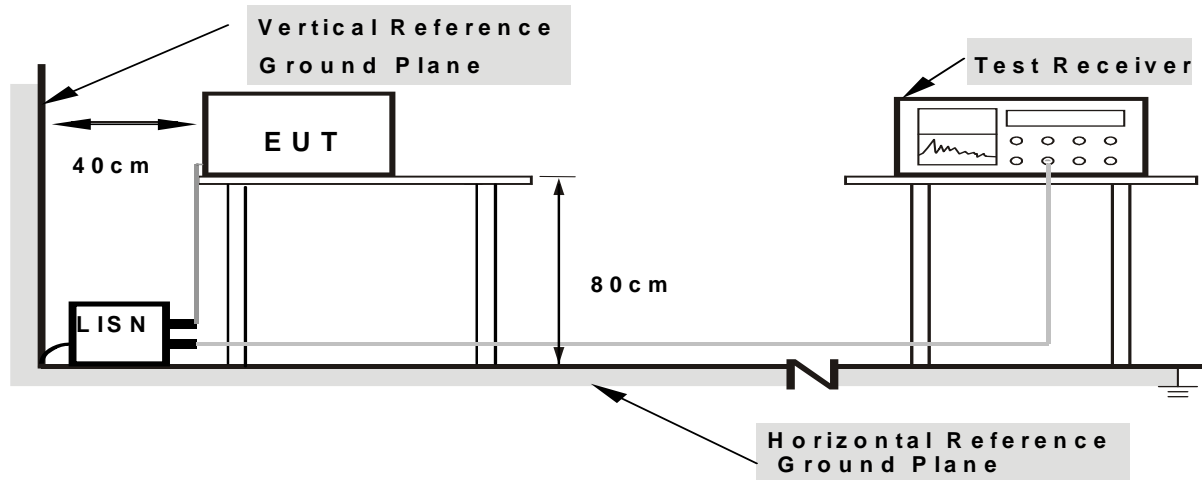

- Note:**
- 1. Support units were connected to second LISN.
  - 2. Both of LISNs (AMN) are 80 cm from EUT and at least 80 from other units and other metal planes

**4.1.5 EUT OPERATING CONDITIONS**

The EUT was configured for testing in a typical fashion (as a customer would normally use it). The EUT has been programmed to continuously transmit during test. This operating condition was tested and used to collect the included data.

**4.1.6 EUT TEST CONDITIONS**

Temperature: 25°C  
 Relative Humidity: 55%  
 Test Voltage: AC 120V/60Hz

**4.1.7 TEST RESULTS**

Remark:

- (1) All readings are QP Mode value unless otherwise stated AVG in column of 『Note 』. If the QP Mode Measured value compliance with the QP Limits and lower than AVG Limits, the EUT shall be deemed to meet both QP & AVG Limits and then only QP Mode was measured, but AVG Mode didn't perform. In this case, a “ \* ” marked in AVG Mode column of Interference Voltage Measured.
- (2) Measuring frequency range from 150KHz to 30MHz.



Test Mode : TX MODE

Line

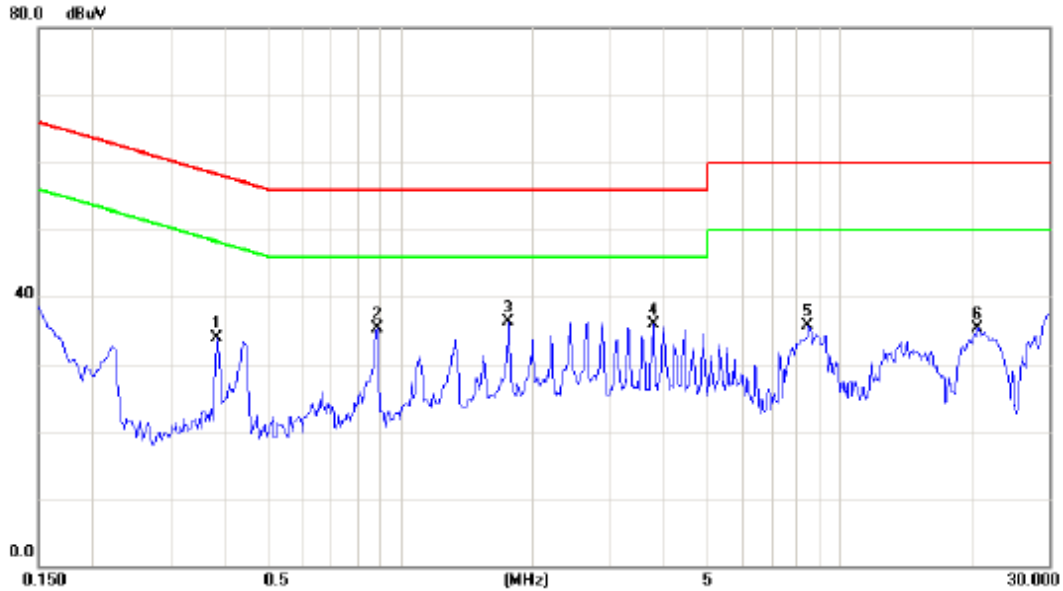

No. Mk.	Freq. MHz	Reading Level dBuV	Correct Factor dB	Measure- ment dBuV	Limit dBuV	Over dB	Detector	Comment
1	0.3842	24.24	9.68	33.92	58.19	-24.27	peak	
2	0.8881	25.66	9.74	35.40	56.00	-20.60	peak	
3 *	1.7710	26.58	9.82	36.40	56.00	-19.60	peak	
4	3.7850	26.01	9.88	35.89	56.00	-20.11	peak	
5	8.4570	25.71	10.02	35.73	60.00	-24.27	peak	
6	20.6952	25.10	10.25	35.35	60.00	-24.65	peak	



Test Mode : TX MODE

Neutral

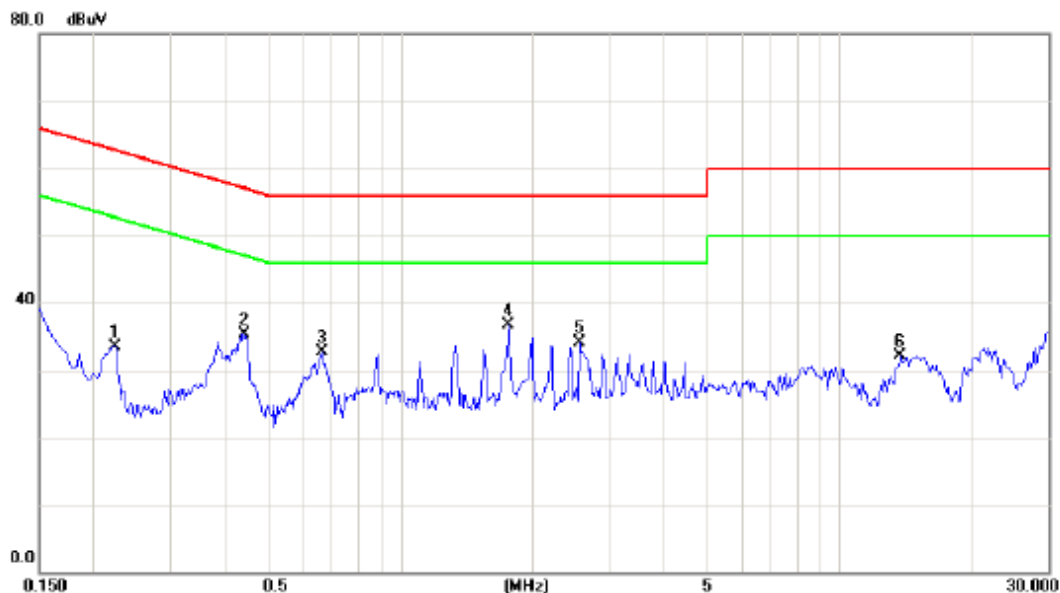

No.	Mk.	Freq. MHz	Reading Level dBuV	Correct Factor dB	Measure- ment dBuV	Limit dBuV	Over dB	Detector	Comment
1		0.2242	23.80	9.71	33.51	62.66	-29.15	peak	
2		0.4396	25.58	9.73	35.31	57.07	-21.76	peak	
3		0.6616	22.91	9.75	32.66	56.00	-23.34	peak	
4	*	1.7670	26.92	9.84	36.76	56.00	-19.24	peak	
5		2.5640	24.32	9.88	34.20	56.00	-21.80	peak	
6		13.7850	21.66	10.46	32.12	60.00	-27.88	peak	



**4.2 RADIATED EMISSION MEASUREMENT**

**4.2.1 RADIATED EMISSION LIMITS (Frequency Range 9KHz-1000MHz)**

20dB in any 100 KHz bandwidth outside the operating frequency band. In case the emission fall within the restricted band specified on 15.205(a) & RSS-210 section 2.2& Annex 8 (A8.5), then the 15.209(a)& RSS-Gen limit in the table below has to be followed.

Frequency (MHz)	Field Strength (microvolts/meter)	Measurement Distance (meters)
0.009~0.490	2400/F(KHz)	300
0.490~1.705	24000/F(KHz)	30
1.705~30.0	30	30
30~88	100	3
88~216	150	3
216~960	200	3
960~1000	500	3

**LIMITS OF RADIATED EMISSION MEASUREMENT (Above 1000MHz)**

Frequency (MHz)	(dBuV/m) (at 3 meters)	
	PEAK	AVERAGE
Above 1000	74	54

**Notes:**

- (1) The limit for radiated test was performed according to FCC PART 15C.
- (2) The tighter limit applies at the band edges.
- (3) Emission level (dBuV/m)=20log Emission level (uV/m).

Spectrum Parameter	Setting
Attenuation	Auto
Start Frequency	1000 MHz
Stop Frequency	10th carrier harmonic
RBW / VBW (Emission in restricted band)	1MHz / 1MHz for Peak, 1 MHz / 10Hz for Average

Receiver Parameter	Setting
Attenuation	Auto
Start ~ Stop Frequency	9KHz~90KHz for PK/AVG detector
Start ~ Stop Frequency	90KHz~110KHz for QP detector
Start ~ Stop Frequency	110KHz~490KHz for PK/AVG detector
Start ~ Stop Frequency	490KHz~30MHz for QP detector
Start ~ Stop Frequency	30MHz~1000MHz for QP detector



**4.2.2 TEST PROCEDURE**

- a. The EUT was placed on the top of a rotating table 0.8 meters above the ground at a 3 meter semi-anechoic chamber. The table was rotated 360 degrees to determine the position of the highest radiation.(below 1GHz)
- b. The EUT was placed on the top of a rotating table 0.8 meters above the ground at a 3 meter fully-anechoic chamber. The table was rotated 360 degrees to determine the position of the highest radiation.(above 1GHz)
- c. The height of the equipment or of the substitution antenna shall be 0.8 m; the height of the test antenna shall vary between 1 m to 4 m. Both horizontal and vertical polarizations of the antenna are set to make the measurement.
- d. The initial step in collecting conducted emission data is a spectrum analyzer peak detector mode pre-scanning the measurement frequency range. Significant peaks are then marked and then Quasi Peak detector mode re-measured.
- e. If the Peak Mode measured value compliance with and lower than Quasi Peak Mode Limit, the EUT shall be deemed to meet QP Limits and then no additional QP Mode measurement performed.
- f. For the actual test configuration, please refer to the related Item –EUT Test Photos.

**4.2.3 DEVIATION FROM TEST STANDARD**

No deviation

**4.2.4 TEST SETUP**

(A) Radiated Emission Test Set-Up Frequency Below 1 GHz

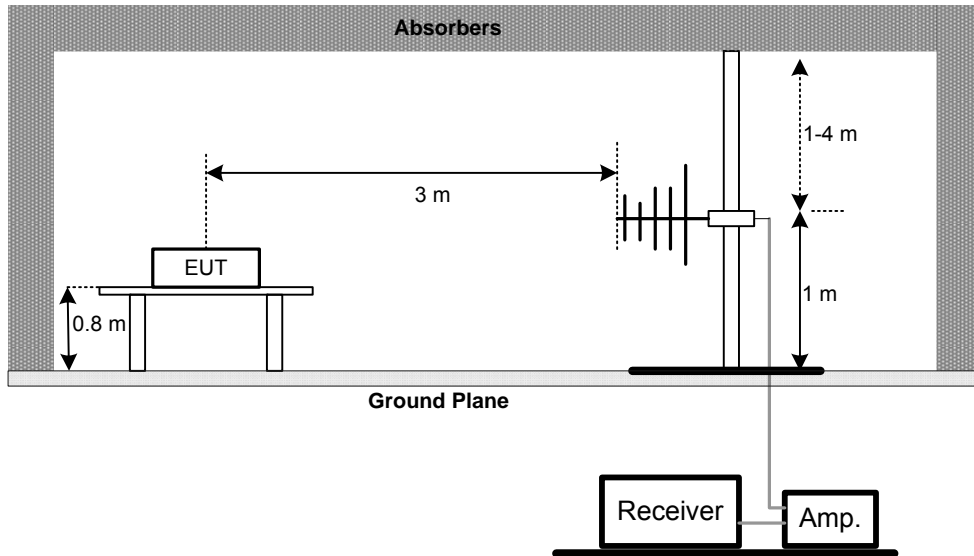

(B) Radiated Emission Test Set-Up Frequency Above 1 GHz

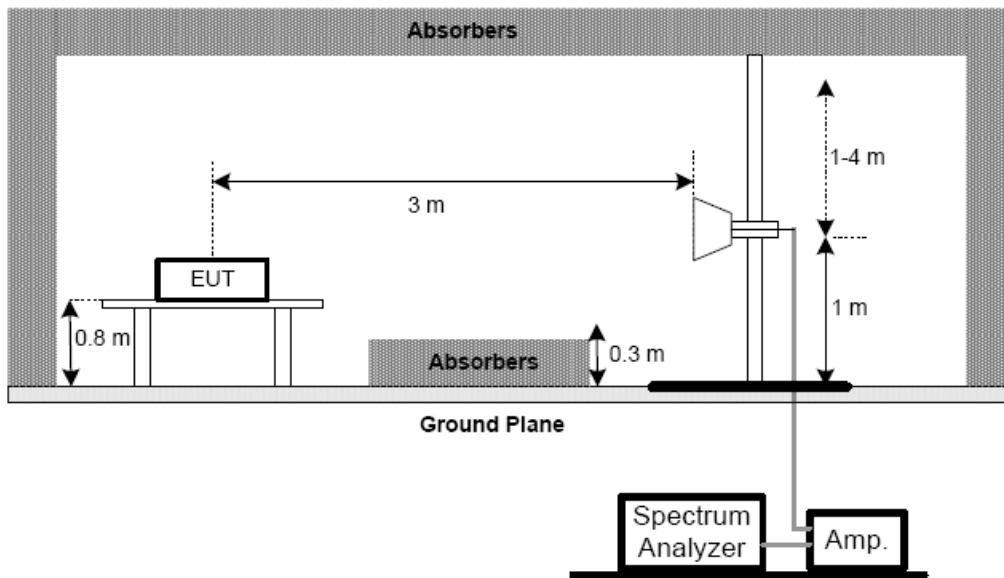

(C) For radiated emissions below 30MHz

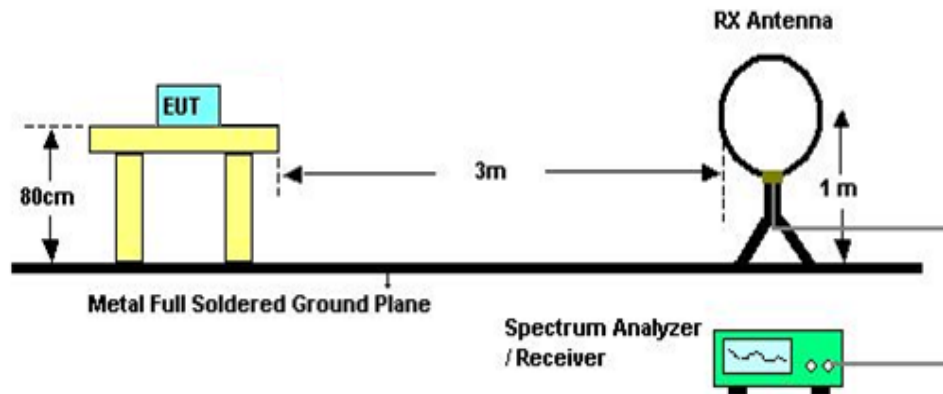

#### 4.2.5 EUT OPERATING CONDITIONS

The EUT tested system was configured as the statements of 4.1.6 Unless otherwise a special operating condition is specified in the follows during the testing.

#### 4.2.6 EUT TEST CONDITIONS

Temperature: 25°C

Relative Humidity: 55%

Test Voltage: AC 120V/60Hz



**4.2.7 TEST RESULTS (9K~ 30MHZ)**

Test Mode : TX Mode 5745MHz

Freq. (MHz)	Ant. 0°/90°	Reading(RA) (dBuV)	Corr.Factor(CF) (dB)	Measured(FS) (dBuV/m)	Limits(QP) (dBuV/m)	Margin (dB)	Note
0.0213	0°	16.52	24.22	40.74	121.04	-80.30	AV
0.0213	0°	18.19	24.22	42.41	141.04	-98.63	PK
0.0279	0°	17.15	23.80	40.95	118.69	-77.74	AV
0.0279	0°	19.03	23.80	42.83	138.69	-95.86	PK
0.0331	0°	17.16	23.47	40.63	117.21	-76.58	AV
0.0331	0°	20.08	23.47	43.55	137.21	-93.66	PK
0.0528	0°	18.47	22.34	40.81	113.15	-72.34	AV
0.0528	0°	21.55	22.34	43.89	133.15	-89.26	PK
0.3170	0°	18.36	20.24	38.60	97.58	-58.98	AVG
0.3170	0°	21.05	20.24	41.29	117.58	-76.29	PK
1.5250	0°	18.73	19.55	38.28	63.94	-25.66	QP

Freq. (MHz)	Ant. 0°/90°	Reading(RA) (dBuV)	Corr.Factor(CF) (dB)	Measured(FS) (dBuV/m)	Limits(QP) (dBuV/m)	Margin (dB)	Note
0.0175	90°	17.51	24.30	41.81	122.74	-80.93	AVG
0.0175	90°	19.23	24.30	43.53	142.74	-99.21	PK
0.0269	90°	16.95	23.86	40.81	119.01	-78.20	AVG
0.0269	90°	18.33	23.86	42.19	139.01	-96.82	PK
0.0378	90°	20.03	23.17	43.20	116.05	-72.85	AVG
0.0378	90°	21.68	23.17	44.85	136.05	-91.20	PK
0.0519	90°	20.25	22.36	42.61	113.30	-70.69	AVG
0.0519	90°	23.39	22.36	45.75	133.30	-87.55	PK
0.3270	90°	18.45	20.22	38.67	97.31	-58.65	AVG
0.3270	90°	20.72	20.22	40.94	117.31	-76.38	PK
1.6750	90°	18.63	19.53	38.16	63.12	-24.96	QP

Remark:

- (1) The amplitude of spurious emissions which are attenuated by more than 20 dB below the permissible value has no need to be reported.
- (2) Distance extrapolation factor =  $40 \log(\text{specific distance} / \text{test distance})$  (dB);
- (3) Limit line = specific limits (dBuV) + distance extrapolation factor.



#### **4.2.8 TEST RESULTS (BETWEEN 30 – 1000 MHZ)**

Remark:

- (1) Reading in which marked as QP or Peak means measurements by using are Quasi-Peak Mode or Peak Mode with Detector BW=120KHz ; SPA setting in RBW=120KHz, VBW =120KHz, Swp. Time = 0.3 sec./MHz.
- (2) All readings are Peak unless otherwise stated QP in column of 『Note』 . Peak denotes that the Peak reading compliance with the QP Limits and then QP Mode measurement didn't perform.
- (3) Measuring frequency range from 30MHz to 1000MHz.
- (4) If the peak scan value lower limit more than 20dB, then this signal data does not show in table.



Test Mode: TX A MODE 5745MHz

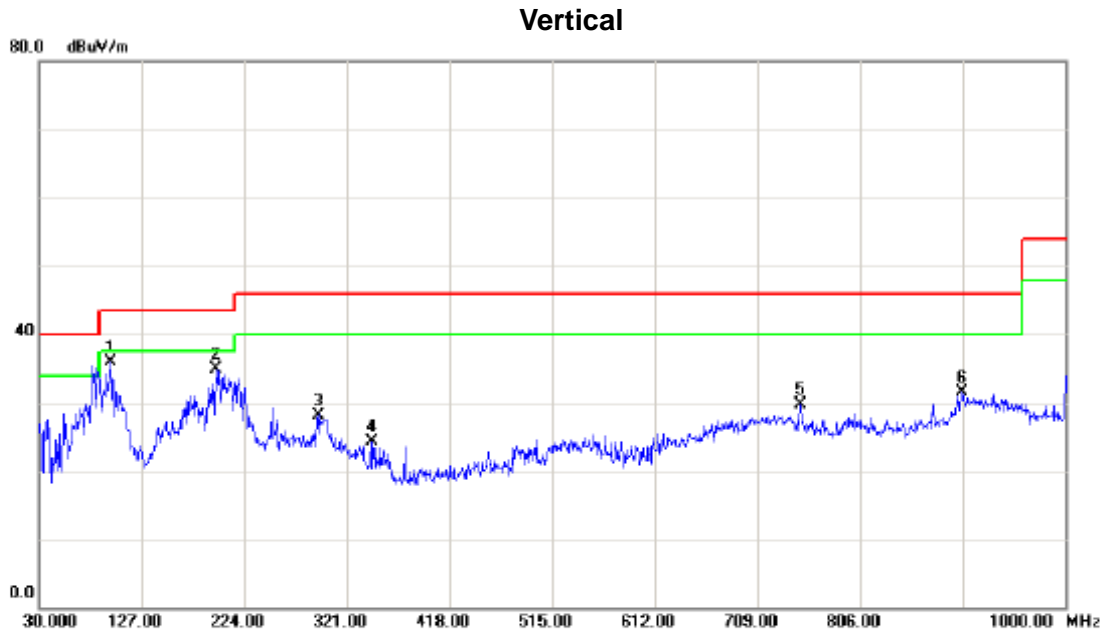

No.	Mk.	Freq. MHz	Reading Level dBuV	Correct Factor dB	Measure- ment dBuV/m	Limit dBuV/m	Over dB	Detector	Comment
1	*	97.9000	52.25	-16.38	35.87	43.50	-7.63	peak	
2		196.8400	50.23	-15.28	34.95	43.50	-8.55	peak	
3		293.8400	39.62	-11.42	28.20	46.00	-17.80	peak	
4		344.2800	35.61	-11.32	24.29	46.00	-21.71	peak	
5		749.7400	35.07	-5.30	29.77	46.00	-16.23	peak	
6		902.0300	30.84	0.58	31.42	46.00	-14.58	peak	



Test Mode: TX A MODE 5745MHz

Horizontal

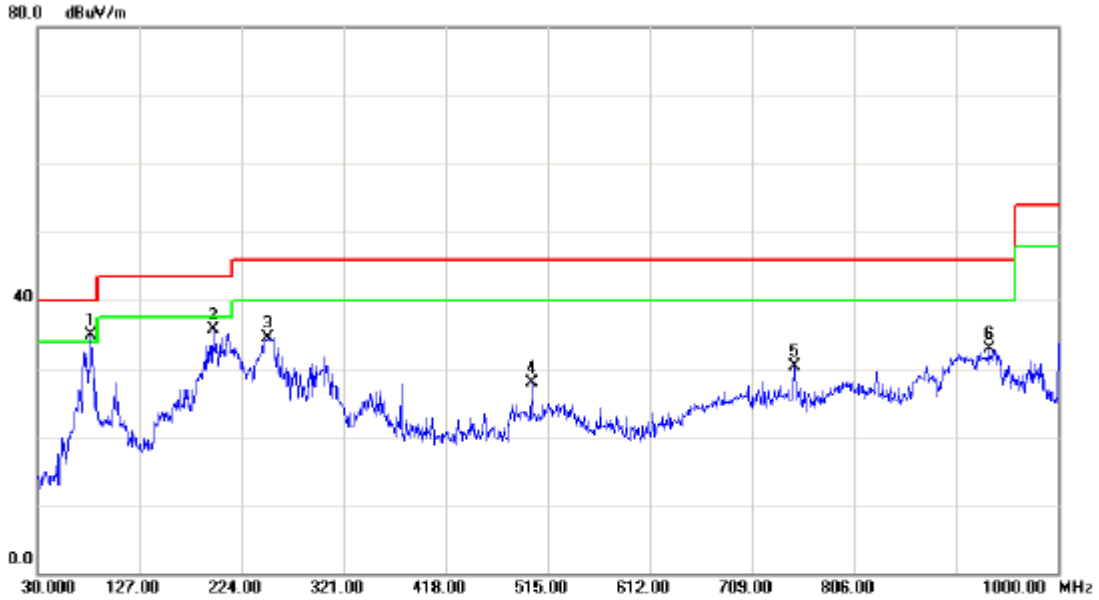

No.	Mk.	Freq. MHz	Reading Level dBuV	Correct Factor dB	Measure- ment dBuV/m	Limit dBuV/m	Over dB	Detector	Comment
1	*	81.4100	51.41	-16.57	34.84	40.00	-5.16	peak	
2		196.8400	51.06	-15.28	35.78	43.50	-7.72	peak	
3		249.2200	49.41	-14.86	34.55	46.00	-11.45	peak	
4		500.4500	38.50	-10.50	28.00	46.00	-18.00	peak	
5		749.7400	35.61	-5.30	30.31	46.00	-15.69	peak	
6		934.0400	33.03	-0.16	32.87	46.00	-13.13	peak	



Test Mode: TX A MODE 5785MHz

Vertical

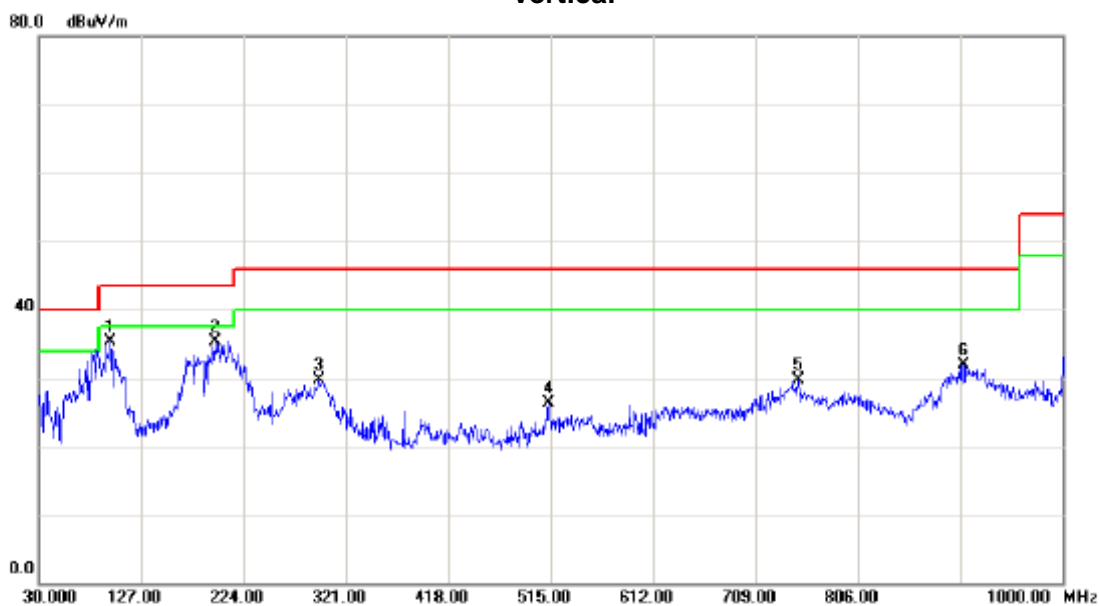

No.	Mk.	Freq. MHz	Reading Level dBuV	Correct Factor dB	Measure- ment dBuV/m	Limit dBuV/m	Over dB	Detector	Comment
1		97.9000	51.69	-16.38	35.31	43.50	-8.19	peak	
2	*	196.8400	50.67	-15.28	35.39	43.50	-8.11	peak	
3		295.7800	40.92	-11.28	29.64	46.00	-16.36	peak	
4		513.0600	35.54	-9.32	26.22	46.00	-19.78	peak	
5		749.7400	35.00	-5.30	29.70	46.00	-16.30	peak	
6		905.9100	31.34	0.49	31.83	46.00	-14.17	peak	



Test Mode: TX A MODE 5785MHz

Horizontal

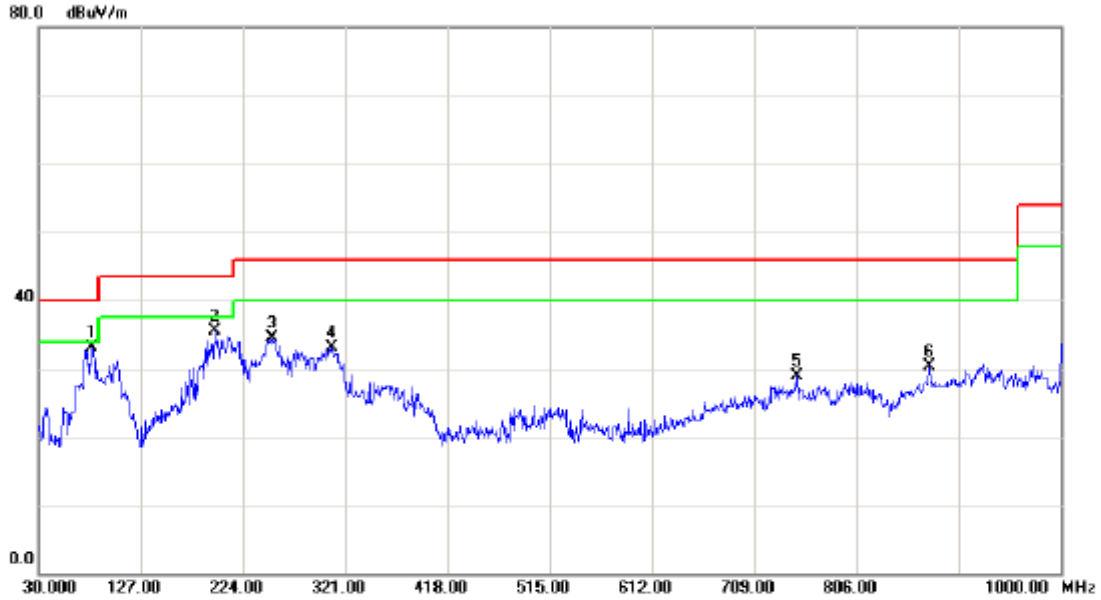

No.	Mk.	Freq. MHz	Reading Level dBuV	Correct Factor dB	Measure- ment dBuV/m	Limit dBuV/m	Over dB	Detector	Comment
1	*	80.4400	49.66	-16.54	33.12	40.00	-6.88	peak	
2		196.8400	50.87	-15.28	35.59	43.50	-7.91	peak	
3		252.1300	49.44	-14.85	34.59	46.00	-11.41	peak	
4		308.3900	44.16	-11.02	33.14	46.00	-12.86	peak	
5		749.7400	34.20	-5.30	28.90	46.00	-17.10	peak	
6		874.8700	32.09	-1.78	30.31	46.00	-15.69	peak	



Test Mode: TX A MODE 5825MHz

**Vertical**

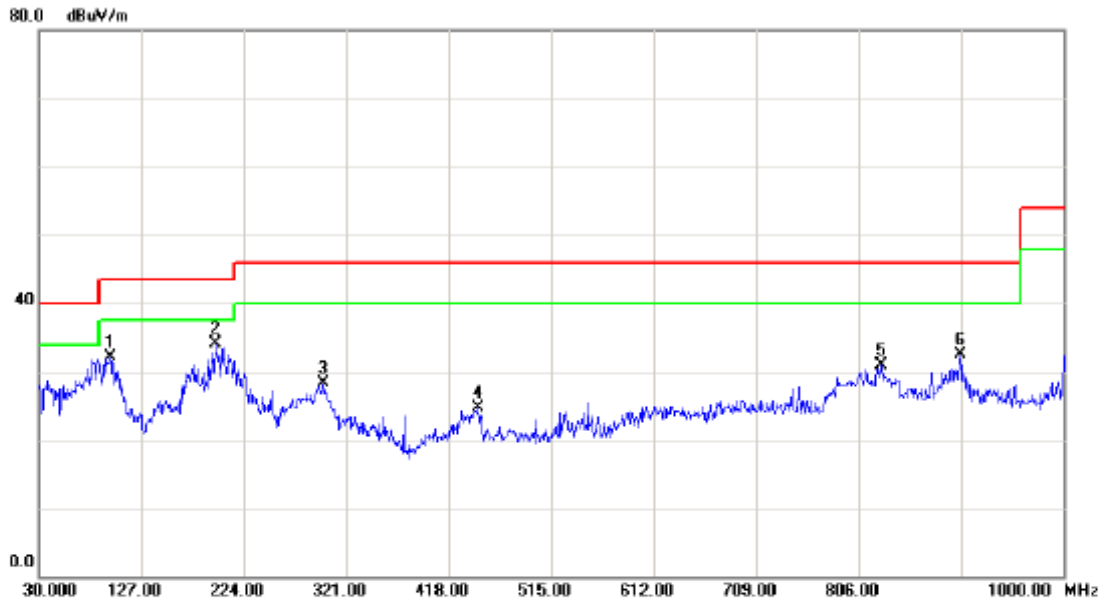

No.	Mk.	Freq. MHz	Reading Level dBuV	Correct Factor dB	Measure- ment dBuV/m	Limit dBuV/m	Over dB	Detector	Comment
1		97.9000	48.57	-16.38	32.19	43.50	-11.31	peak	
2	*	196.8400	49.46	-15.28	34.18	43.50	-9.32	peak	
3		299.6600	39.26	-10.97	28.29	46.00	-17.71	peak	
4		446.1300	33.56	-8.79	24.77	46.00	-21.23	peak	
5		827.3400	33.88	-3.02	30.86	46.00	-15.14	peak	
6		902.0300	31.95	0.58	32.53	46.00	-13.47	peak	



Test Mode: TX A MODE 5825MHz

Horizontal

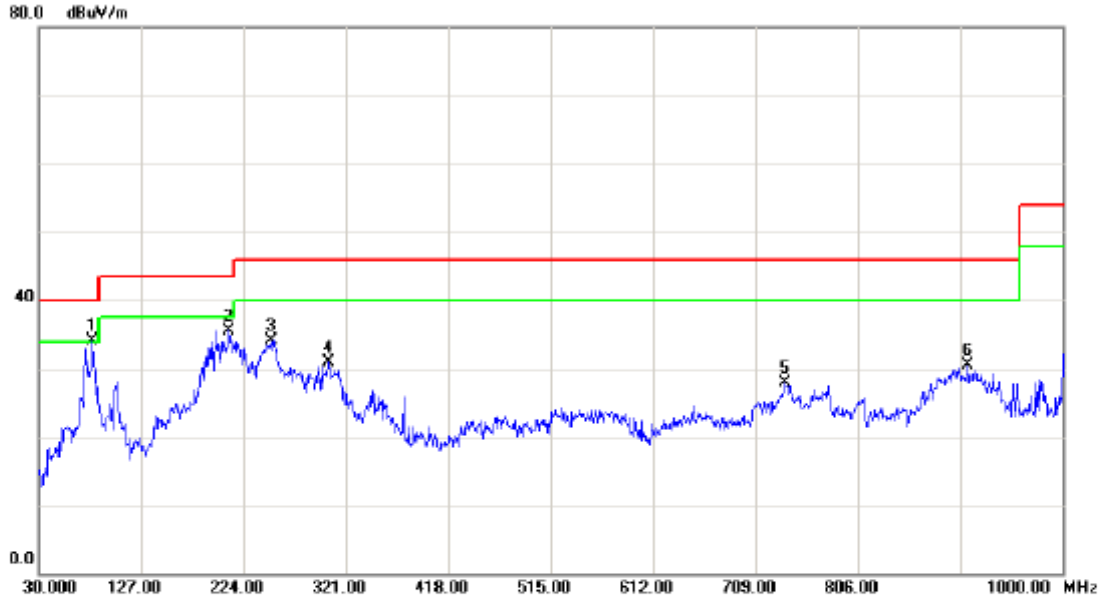

No.	Mk.	Freq. MHz	Reading Level dBuV	Correct Factor dB	Measure- ment dBuV/m	Limit dBuV/m	Over dB	Detector	Comment
1	*	81.4100	50.62	-16.57	34.05	40.00	-5.95	peak	
2		210.4200	50.65	-15.05	35.60	43.50	-7.90	peak	
3		250.1900	49.04	-14.87	34.17	46.00	-11.83	peak	
4		304.5100	41.94	-10.99	30.95	46.00	-15.05	peak	
5		736.1600	32.90	-5.06	27.84	46.00	-18.16	peak	
6		909.7900	30.18	0.40	30.58	46.00	-15.42	peak	



#### **4.2.9 TEST RESULTS (ABOVE 1000 MHZ)**

**Remark:**

- (1) All readings are Peak unless otherwise stated QP in column of 『Note 』 . Peak denotes that the Peak reading compliance with the QP Limits and then QP Mode measurement didn't perform.
- (2) Measuring frequency range from 30MHz to 1000MHz or the 10th harmonic of highest fundamental frequency. "F" denotes fundamental frequency; "H" denotes spurious frequency; "E" denotes band edge frequency. (This judgment method includes the Band Edge Requirement.)
- (3) Radiated emissions measured in frequency range above 1000MHz were made with an instrument using Peak detector mode and AV detector mode of the emission.
- (4) Data of measurement within this frequency range shown " \* " in the table above means the reading of emissions are attenuated more than 20dB below the permissible limits or the field strength is too small to be measured.
- (5) A preamp and high pass filter were used for this test in order to provide sufficient measurement sensitivity.
- (6) EUT Orthogonal Axis:  
"X" - denotes Laid on Table; "Y" - denotes Vertical Stand; "Z" - denotes Side Stand
- (7) During the measurements above 1 GHz it is taken care of that the EUT is always within the 3 dB cone of radiation BW of the used antenna
- (8) "#" The radiated frequency is out of the restricted band. Limit line= fundamental - 20dB



Test Mode : TX A MODE 5745MHz

Freq. (MHz)	Ant.Pol. H/V	Reading (dBuV)		Ant./CF CF(dB)	Act. (dBuV/m)		Limit (dBuV/m)		Note
		Peak	AV		Peak	AV	Peak	AV	
#5725.00	V	41.00	30.03	44.34	85.34	86.20	77.93	54.00	X/E
<b>5738.60</b>	<b>V</b>	<b>61.80</b>	<b>53.53</b>	<b>44.40</b>	<b>106.20</b>	<b>97.93</b>			<b>X/F</b>
11490.80	V	37.12	27.34	18.47	55.59	45.81	74.00	54.00	X/H

Freq. (MHz)	Ant.Pol. H/V	Reading (dBuV)		Ant./CF CF(dB)	Act. (dBuV/m)		Limit (dBuV/m)		Note
		Peak	AV		Peak	AV	Peak	AV	
#5725.00	H	41.91	31.90	44.34	86.25	87.67	79.57	54.00	X/E
<b>5740.60</b>	<b>H</b>	<b>63.27</b>	<b>55.17</b>	<b>44.40</b>	<b>107.67</b>	<b>99.57</b>			<b>X/F</b>
11491.50	H	38.62	28.02	18.47	57.09	46.49	74.00	54.00	X/H

Test Mode : TX A MODE 5785MHz

Freq. (MHz)	Ant.Pol. H/V	Reading (dBuV)		Ant./CF CF(dB)	Act. (dBuV/m)		Limit (dBuV/m)		Note
		Peak	AV		Peak	AV	Peak	AV	
<b>5784.00</b>	<b>V</b>	<b>61.03</b>	<b>52.73</b>	<b>44.55</b>	<b>105.58</b>	<b>97.28</b>			<b>X/F</b>
11570.20	V	35.18	25.87	18.67	53.85	44.54	74.00	54.00	X/H

Freq. (MHz)	Ant.Pol. H/V	Reading (dBuV)		Ant./CF CF(dB)	Act. (dBuV/m)		Limit (dBuV/m)		Note
		Peak	AV		Peak	AV	Peak	AV	
<b>5782.80</b>	<b>H</b>	<b>63.26</b>	<b>54.86</b>	<b>44.55</b>	<b>107.81</b>	<b>99.41</b>			<b>X/F</b>
11570.80	H	36.89	27.65	18.67	55.56	46.32	74.00	54.00	X/H

Test Mode : TX A MODE 5825MHz

Freq. (MHz)	Ant.Pol. H/V	Reading (dBuV)		Ant./CF CF(dB)	Act. (dBuV/m)		Limit (dBuV/m)		Note
		Peak	AV		Peak	AV	Peak	AV	
<b>5827.70</b>	<b>V</b>	<b>61.52</b>	<b>52.68</b>	<b>44.70</b>	<b>106.22</b>	<b>97.38</b>			<b>X/F</b>
#5850.00	V	29.38	21.54	44.78	74.16	66.32	86.22	77.38	X/E
11650.00	V	37.35	27.87	18.86	56.21	46.73	74.00	54.00	X/H

Freq. (MHz)	Ant.Pol. H/V	Reading (dBuV)		Ant./CF CF(dB)	Act. (dBuV/m)		Limit (dBuV/m)		Note
		Peak	AV		Peak	AV	Peak	AV	
<b>5822.70</b>	<b>H</b>	<b>62.89</b>	<b>54.74</b>	<b>44.69</b>	<b>107.58</b>	<b>99.43</b>			<b>X/F</b>
#5850.00	H	36.36	24.15	44.78	81.14	68.93	87.58	79.43	X/E
11651.30	H	35.59	27.09	18.87	54.46	45.96	74.00	54.00	X/H



TX CH149 (Above 1000 MHz, Vertical)

116.0 dBuV/m

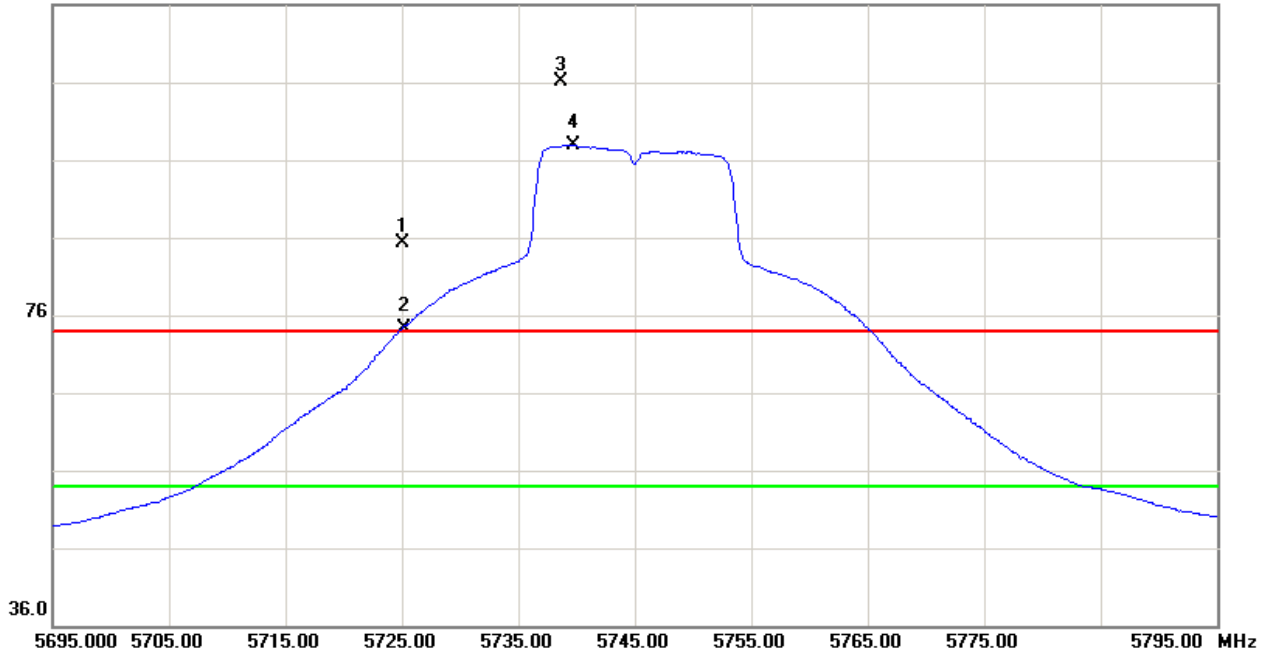

80.0 dBuV/m

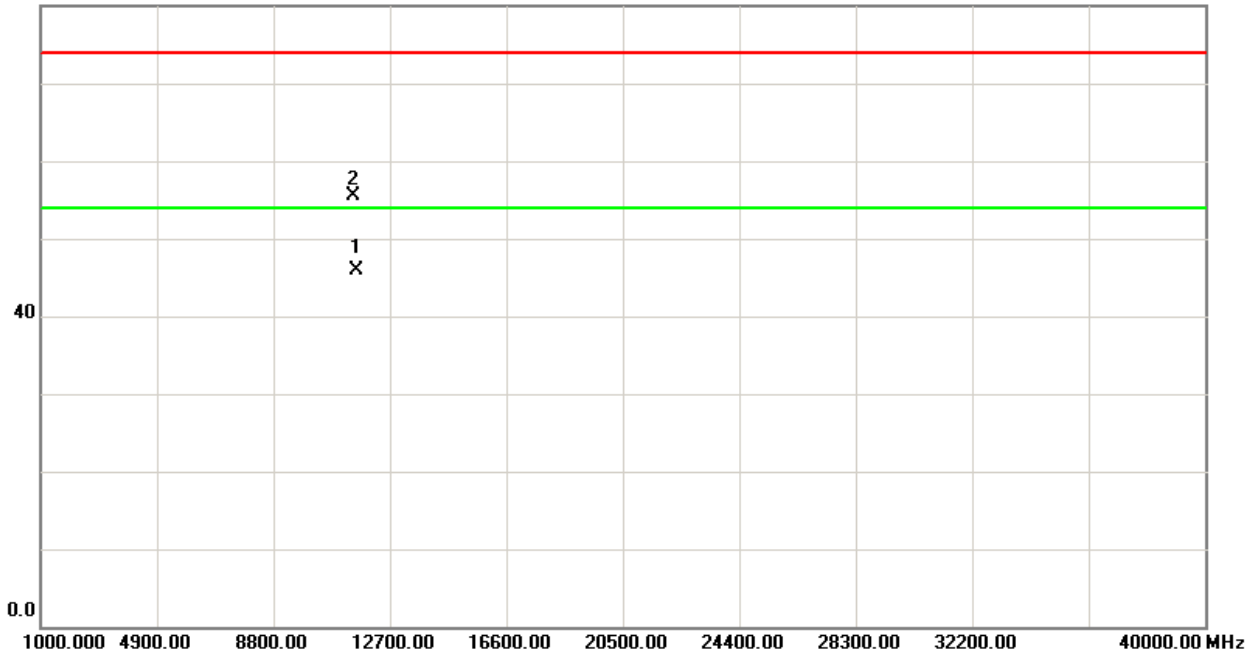



TX CH149 (Above 1000 MHz, Horizontal)

116.0 dBuV/m

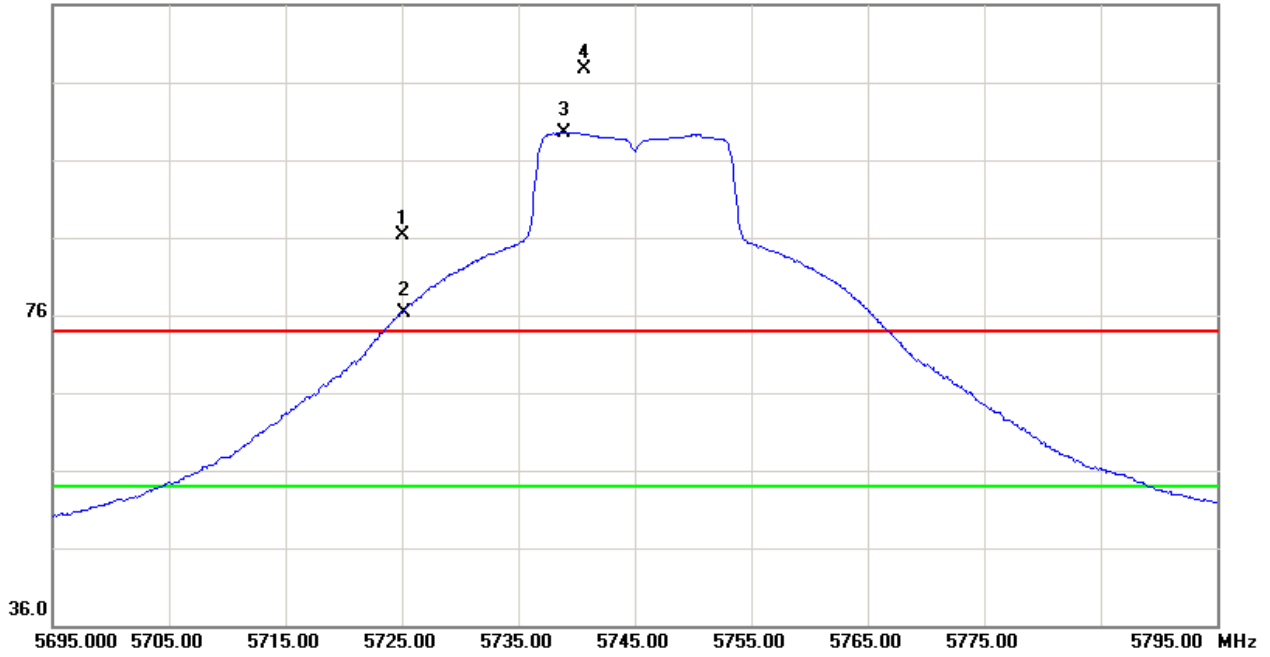

90.0 dBuV/m

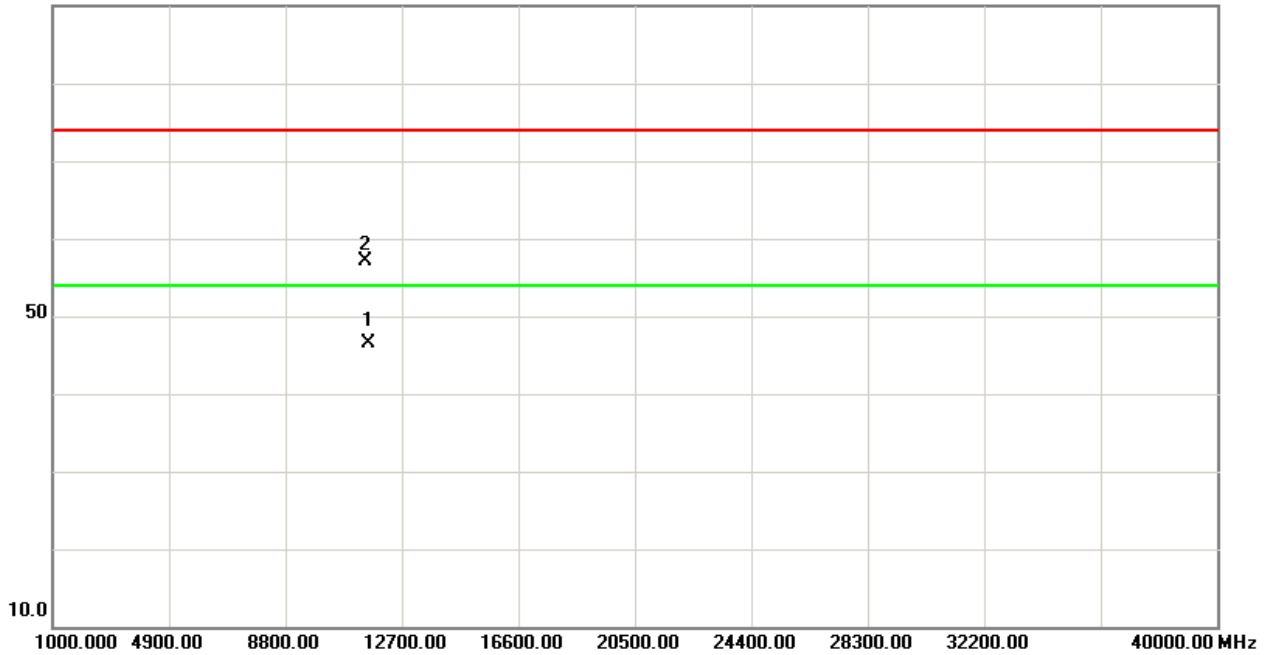



TX CH157 (Above 1000 MHz, Vertical)

116.0 dBuV/m

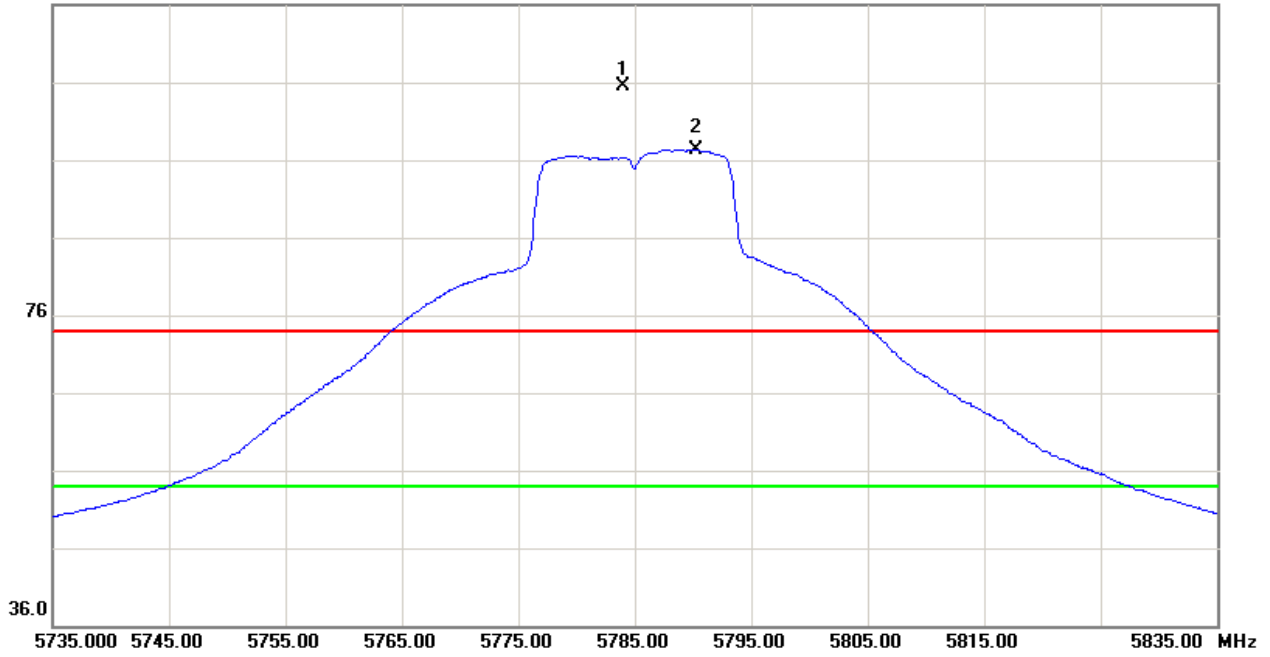

90.0 dBuV/m

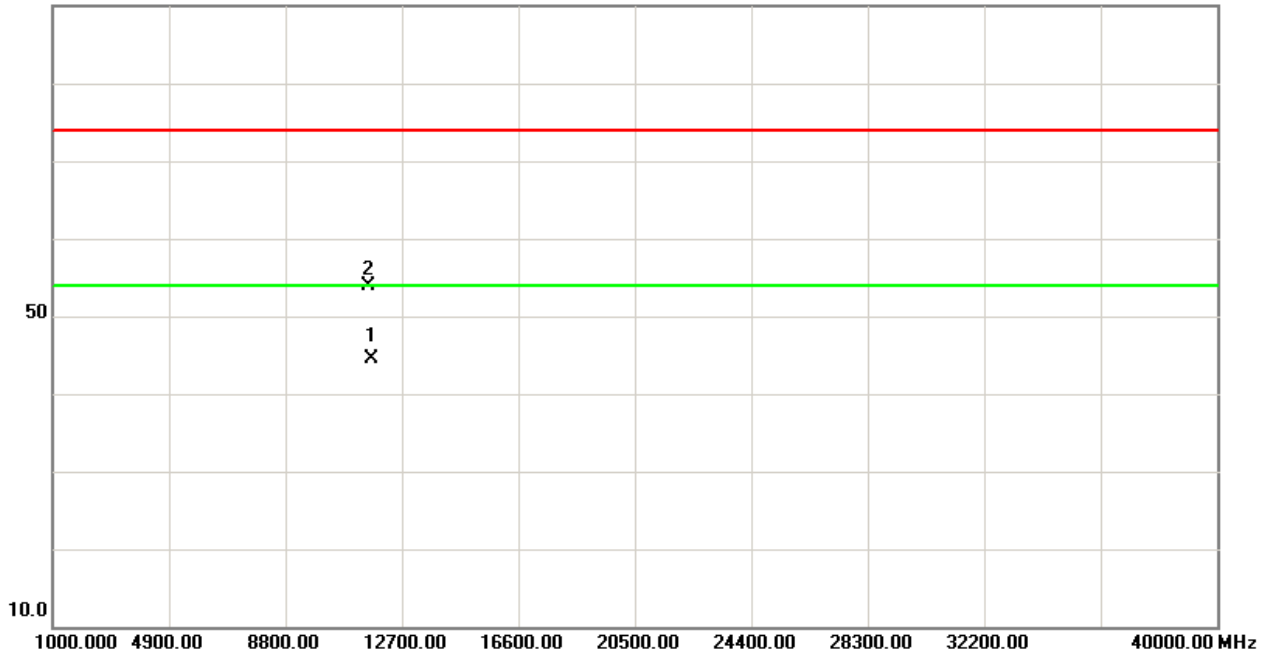



TX CH157 (Above 1000 MHz, Horizontal)

116.0 dBuV/m

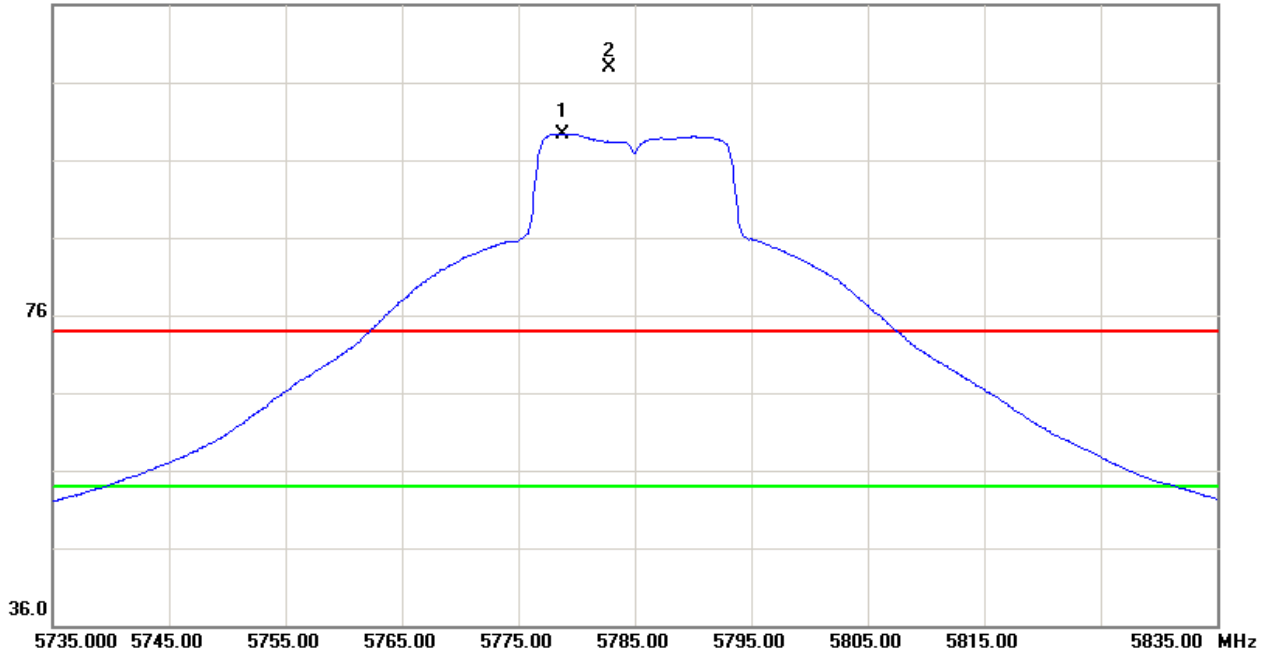

90.0 dBuV/m

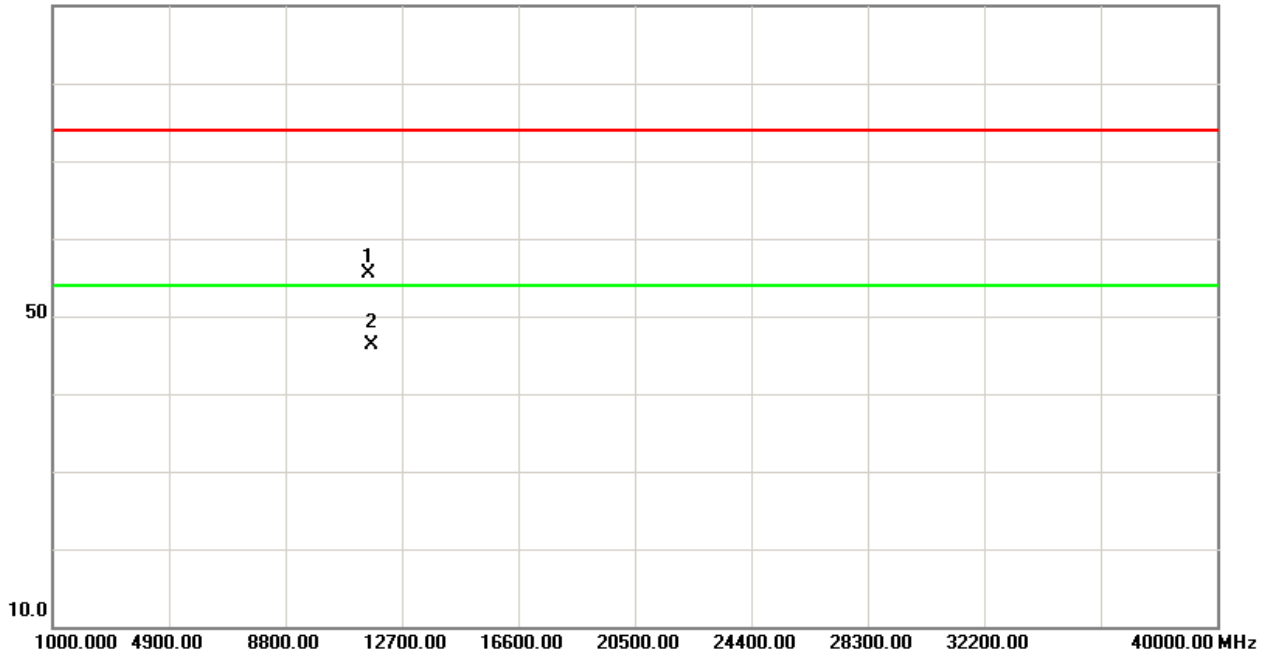



TX CH165 (Above 1000 MHz, Vertical)

116.0 dBuV/m

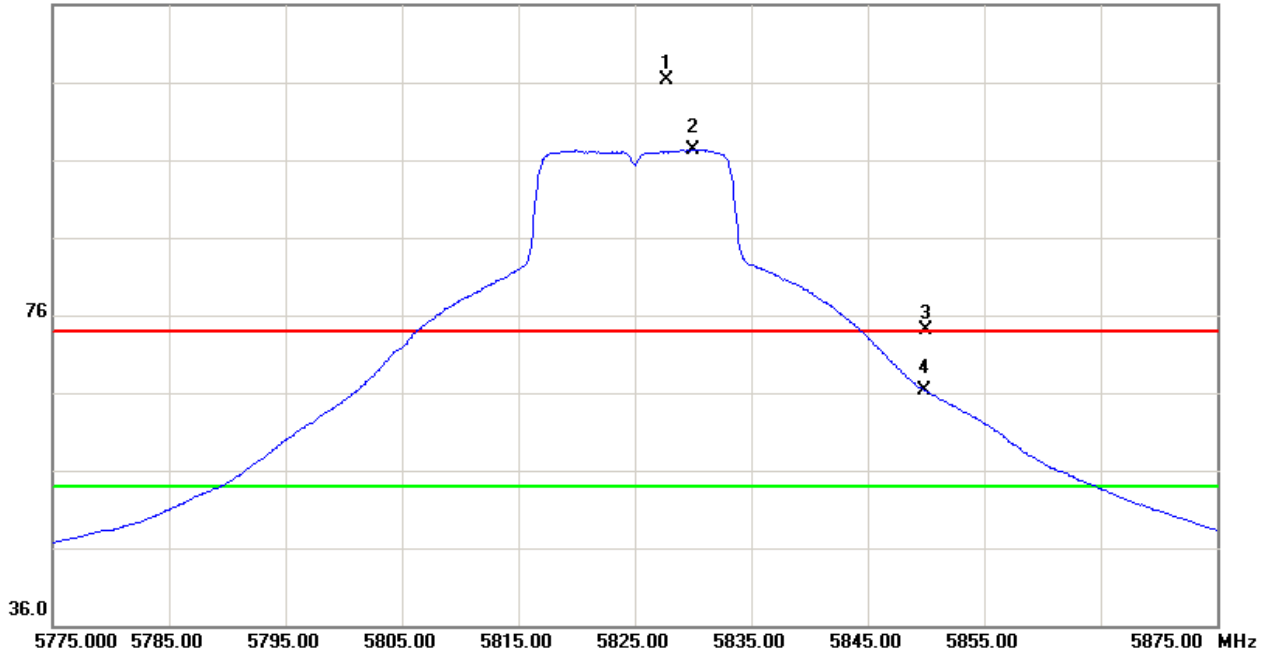

90.0 dBuV/m

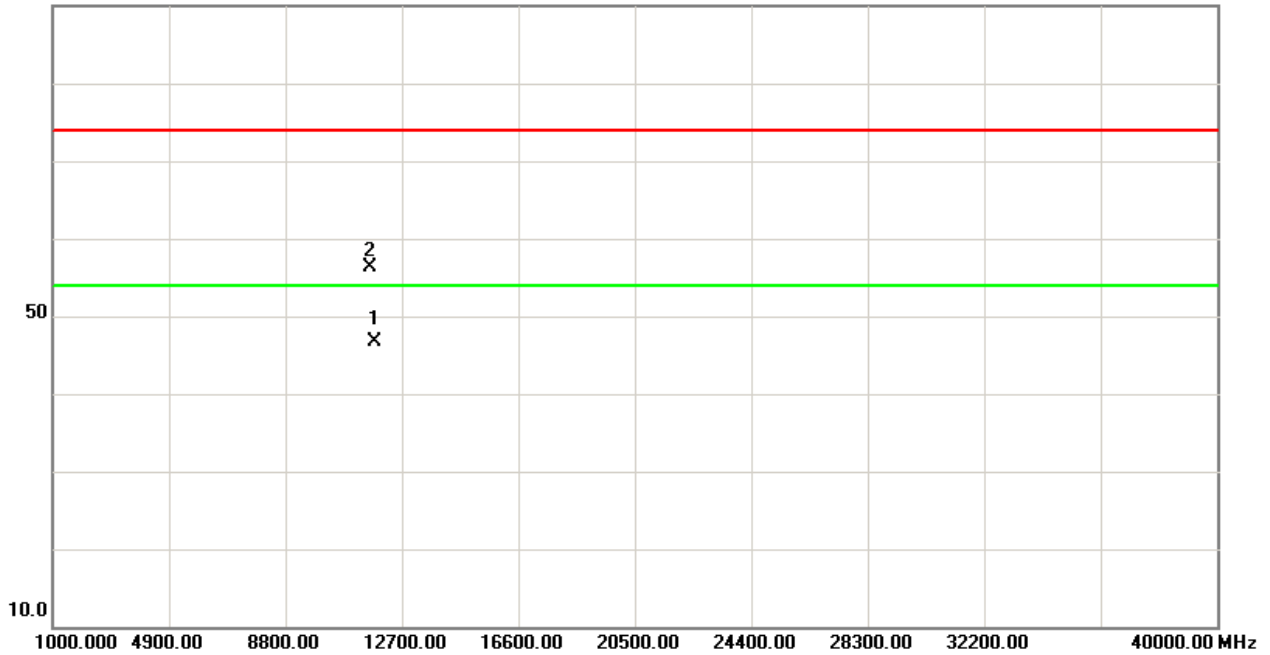



TX CH165 (Above 1000 MHz, Horizontal)

116.0 dBuV/m

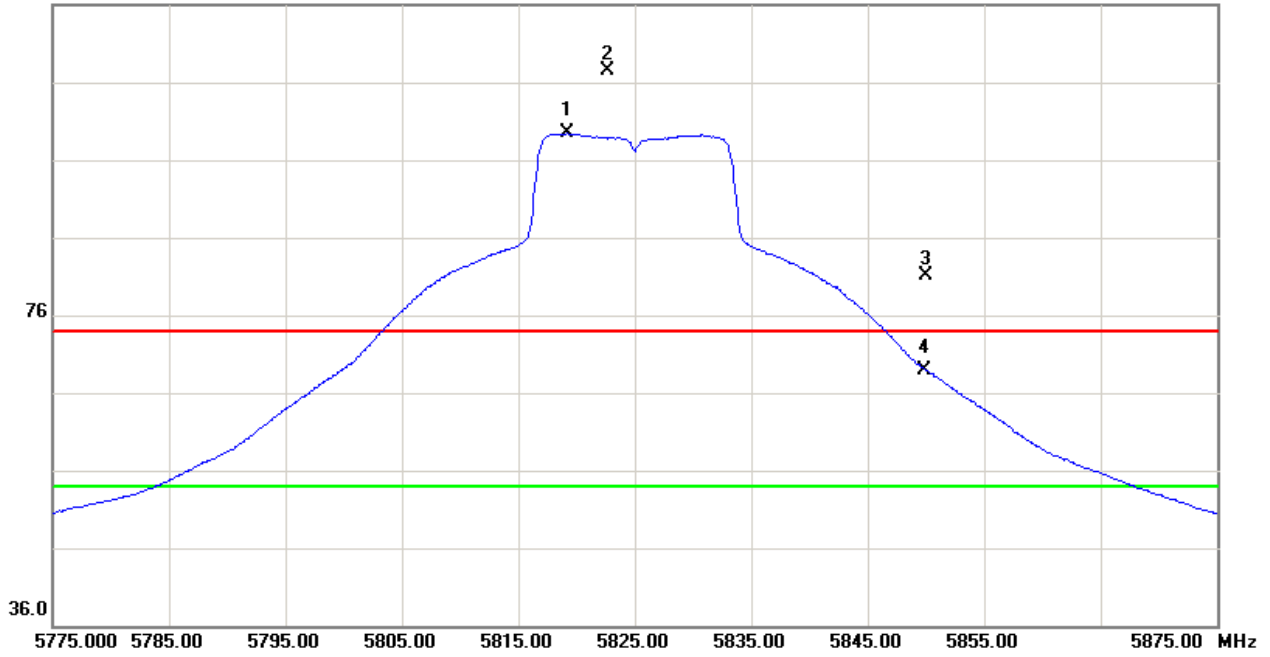

90.0 dBuV/m

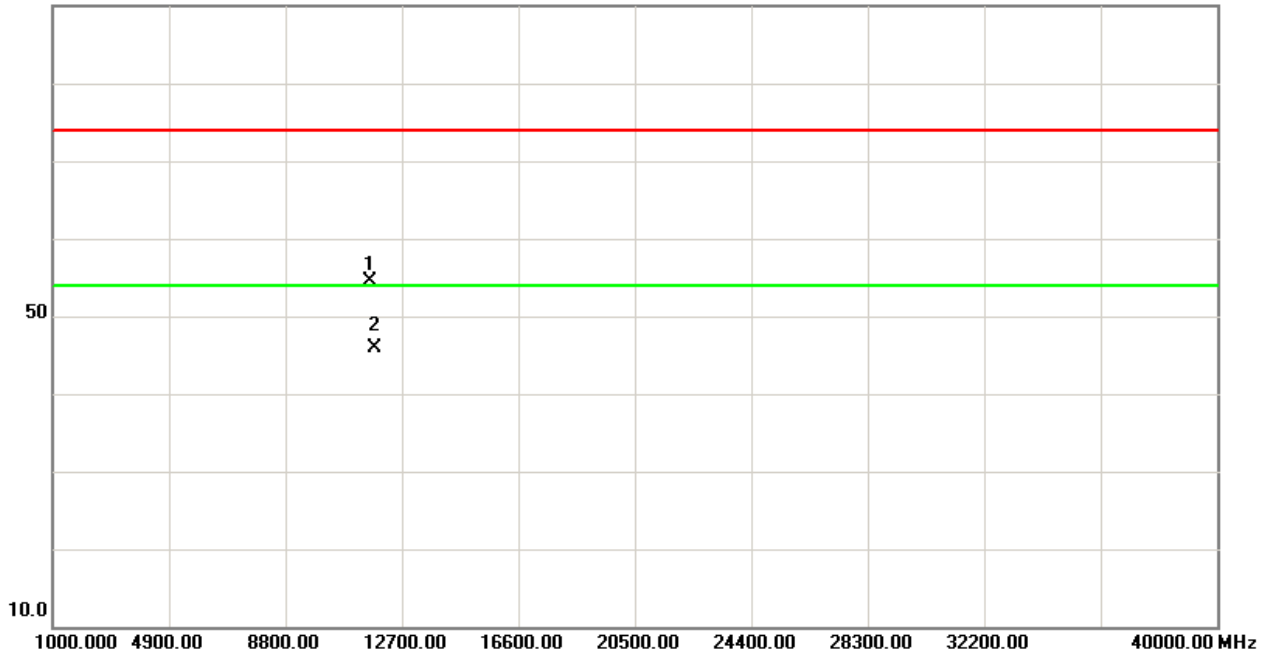



Test Mode : TX N-20M MODE 5745MHz

Freq. (MHz)	Ant.Pol. H/V	Reading (dBuV)		Ant./CF CF(dB)	Act. (dBuV/m)		Limit (dBuV/m)		Note
		Peak	AV		Peak	AV	Peak	AV	
#5725.00	V	35.78	23.60	44.34	80.12	67.94	84.93	75.81	X/E
<b>5739.20</b>	<b>V</b>	<b>60.53</b>	<b>51.41</b>	<b>44.40</b>	<b>104.93</b>	<b>95.81</b>			<b>X/F</b>
11491.90	V	37.58	27.86	18.47	56.05	46.33	74.00	54.00	X/H

Freq. (MHz)	Ant.Pol. H/V	Reading (dBuV)		Ant./CF CF(dB)	Act. (dBuV/m)		Limit (dBuV/m)		Note
		Peak	AV		Peak	AV	Peak	AV	
#5725.00	H	37.23	25.03	44.34	81.57	69.37	86.25	76.74	X/E
<b>5746.70</b>	<b>H</b>	<b>61.83</b>	<b>52.32</b>	<b>44.42</b>	<b>106.25</b>	<b>96.74</b>			<b>X/F</b>
11490.40	H	38.98	28.25	18.47	57.45	46.72	74.00	54.00	X/H

Test Mode : TX N-20M MODE 5785MHz

Freq. (MHz)	Ant.Pol. H/V	Reading (dBuV)		Ant./CF CF(dB)	Act. (dBuV/m)		Limit (dBuV/m)		Note
		Peak	AV		Peak	AV	Peak	AV	
<b>5781.40</b>	<b>V</b>	<b>61.98</b>	<b>51.32</b>	<b>44.54</b>	<b>106.52</b>	<b>95.86</b>			<b>X/F</b>
11569.10	V	35.72	26.12	18.67	54.39	44.79	74.00	54.00	X/H

Freq. (MHz)	Ant.Pol. H/V	Reading (dBuV)		Ant./CF CF(dB)	Act. (dBuV/m)		Limit (dBuV/m)		Note
		Peak	AV		Peak	AV	Peak	AV	
<b>5779.10</b>	<b>H</b>	<b>60.37</b>	<b>50.86</b>	<b>44.54</b>	<b>104.91</b>	<b>95.40</b>			<b>X/F</b>
11571.40	H	35.64	27.11	18.67	54.31	45.78	74.00	54.00	X/H

Test Mode : TX N-20M MODE 5825MHz

Freq. (MHz)	Ant.Pol. H/V	Reading (dBuV)		Ant./CF CF(dB)	Act. (dBuV/m)		Limit (dBuV/m)		Note
		Peak	AV		Peak	AV	Peak	AV	
<b>5818.20</b>	<b>V</b>	<b>62.94</b>	<b>51.48</b>	<b>44.66</b>	<b>107.60</b>	<b>96.14</b>			<b>X/F</b>
#5850.00	V	25.57	12.74	44.78	70.35	57.52	87.60	76.14	X/E
11650.80	V	37.89	27.97	18.87	56.76	46.84	74.00	54.00	X/H

Freq. (MHz)	Ant.Pol. H/V	Reading (dBuV)		Ant./CF CF(dB)	Act. (dBuV/m)		Limit (dBuV/m)		Note
		Peak	AV		Peak	AV	Peak	AV	
<b>5820.80</b>	<b>H</b>	<b>61.63</b>	<b>51.22</b>	<b>44.67</b>	<b>106.30</b>	<b>95.89</b>			<b>X/F</b>
#5850.00	H	23.01	13.51	44.78	67.79	58.29	86.30	75.89	X/E
11650.50	H	35.90	27.34	18.87	54.77	46.21	74.00	54.00	X/H



TX CH149 (Above 1000 MHz, Vertical)

116.0 dBuV/m

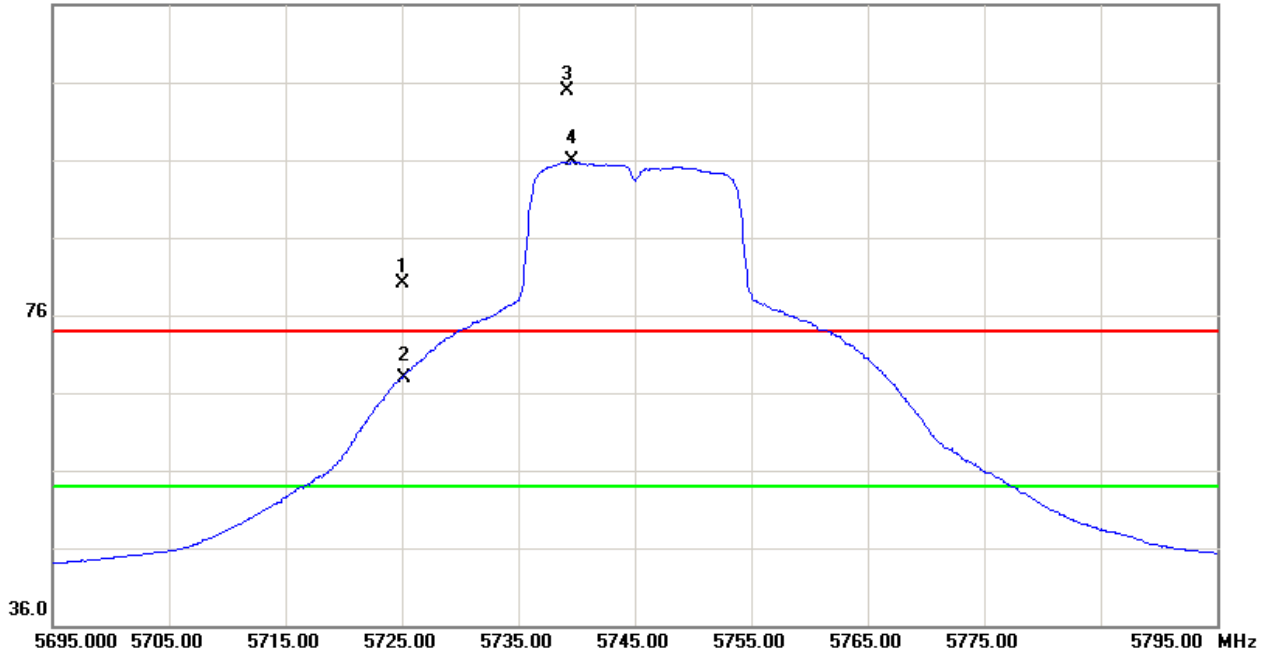

80.0 dBuV/m

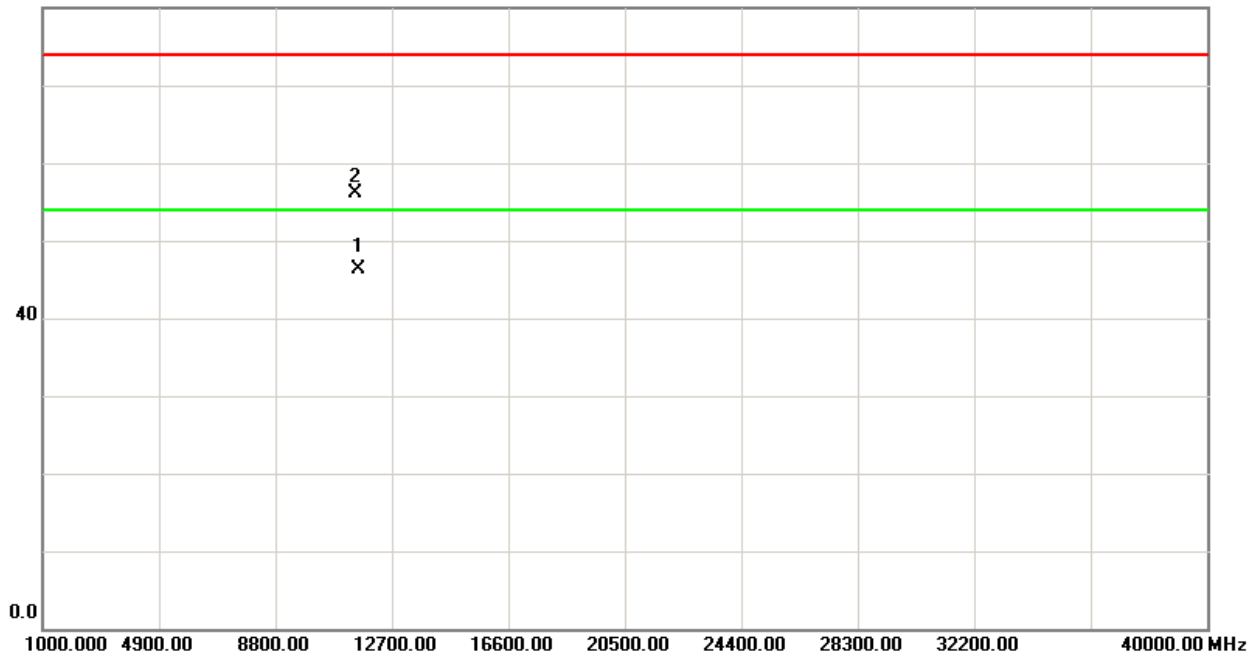



TX CH149 (Above 1000 MHz, Horizontal)

116.0 dBuV/m

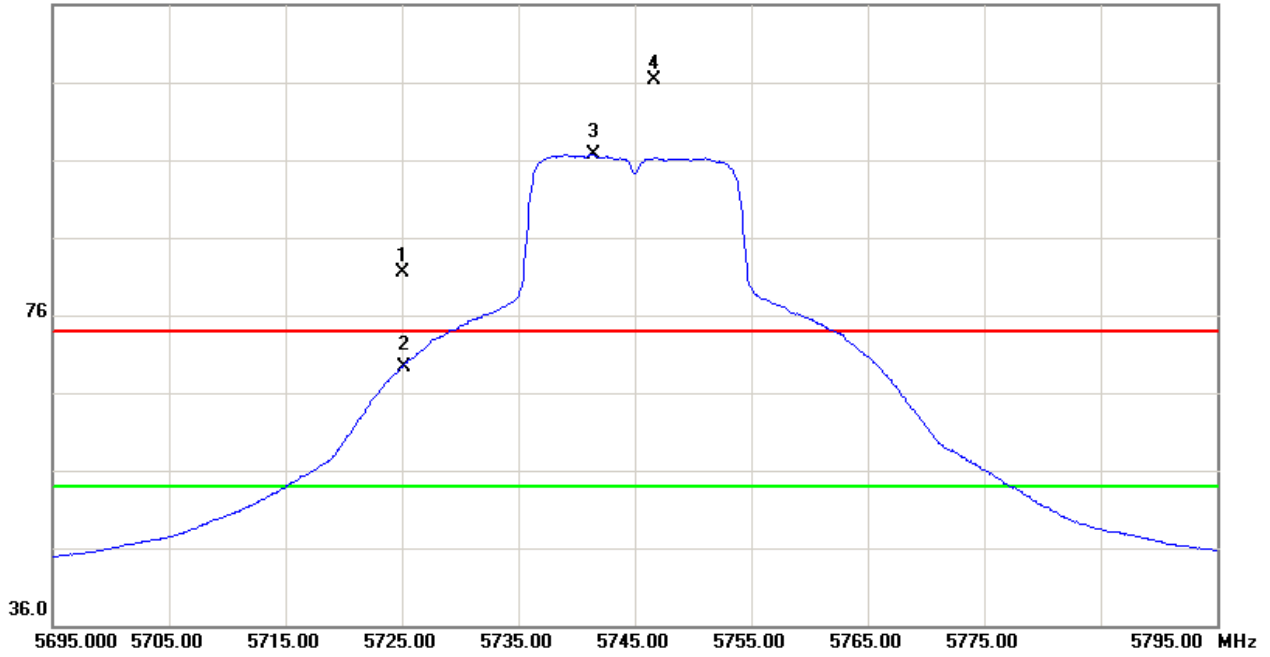

90.0 dBuV/m

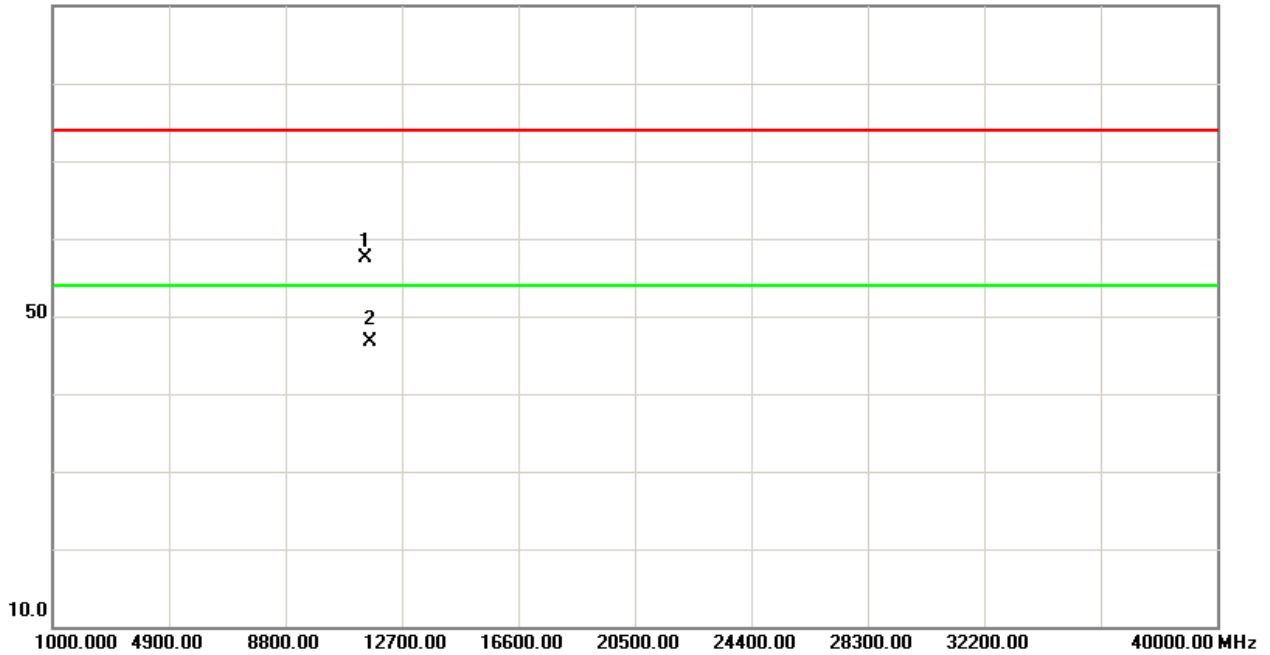



TX CH157 (Above 1000 MHz, Vertical)

116.0 dBuV/m

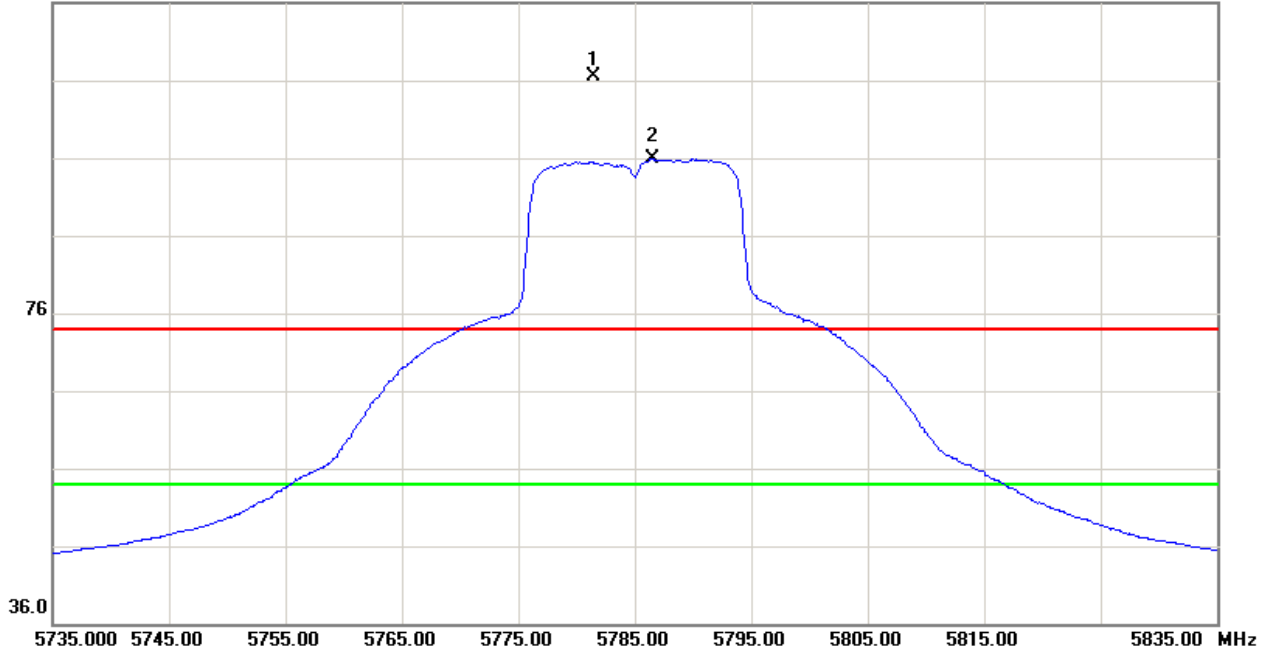

90.0 dBuV/m

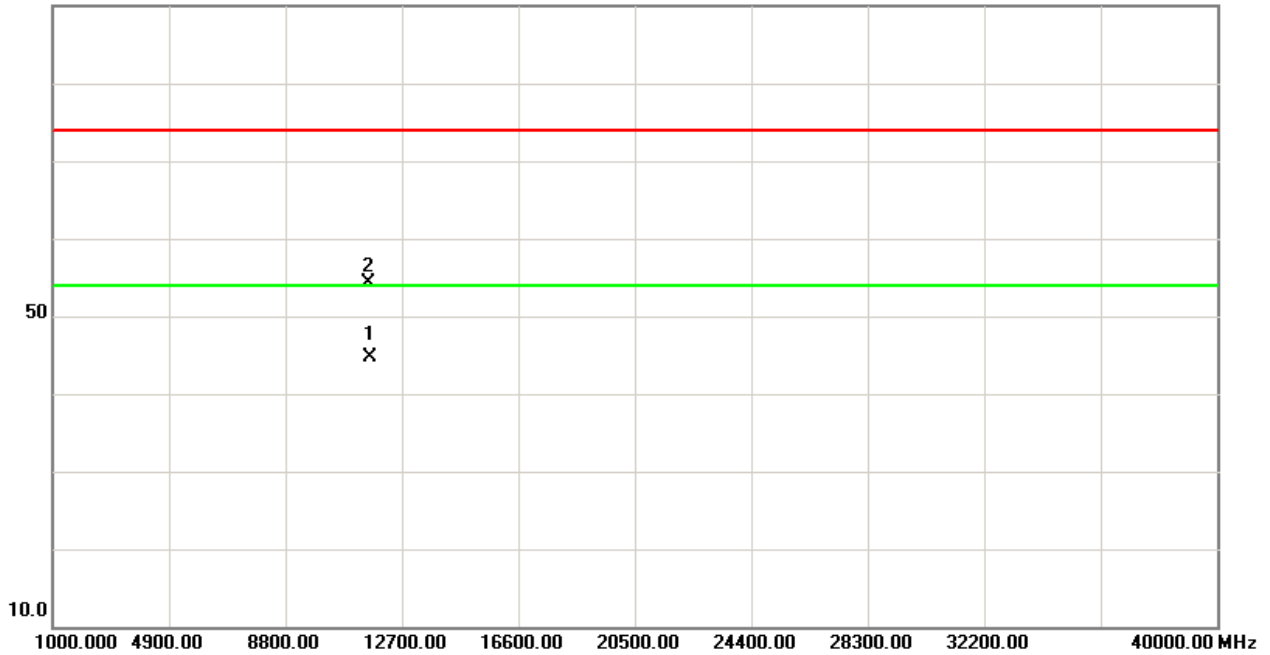



TX CH157 (Above 1000 MHz, Horizontal)

116.0 dBuV/m

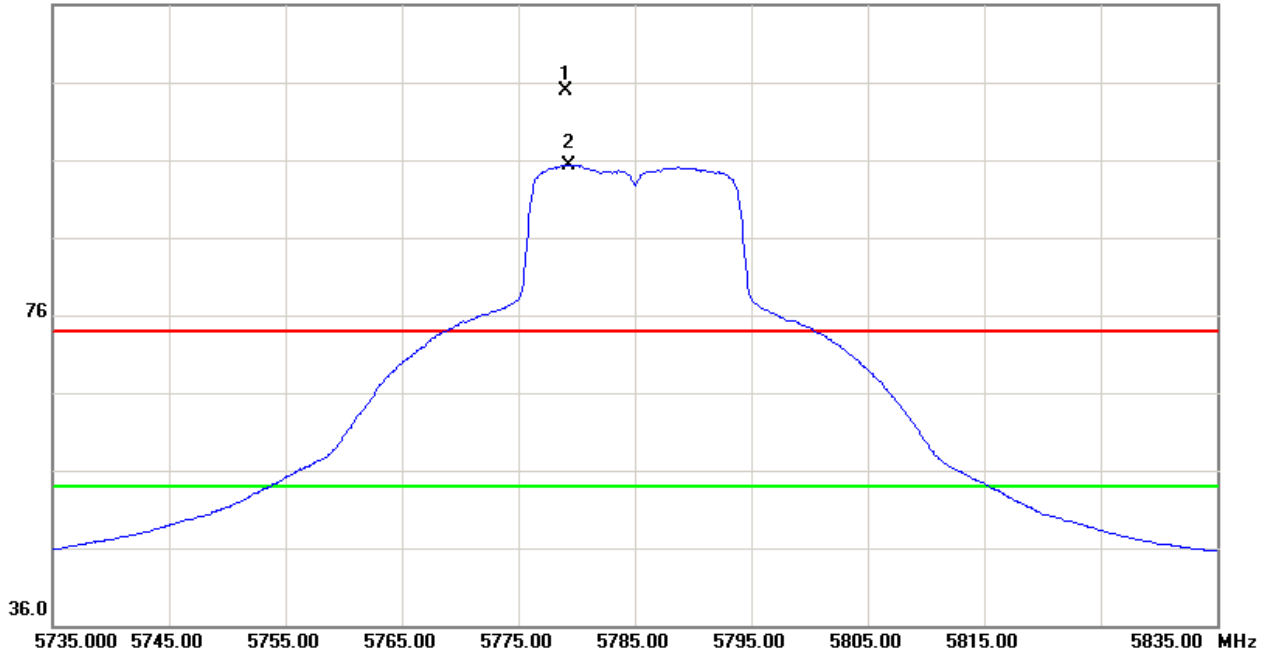

90.0 dBuV/m

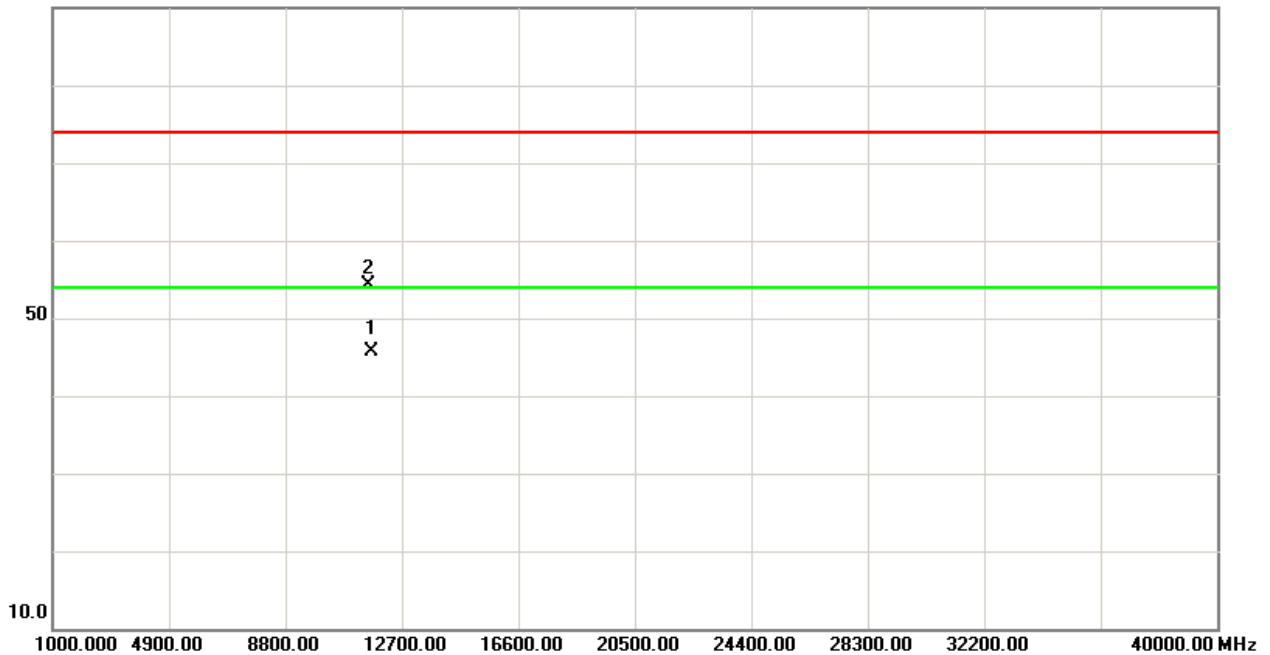



TX CH165 (Above 1000 MHz, Vertical)

116.0 dBuV/m

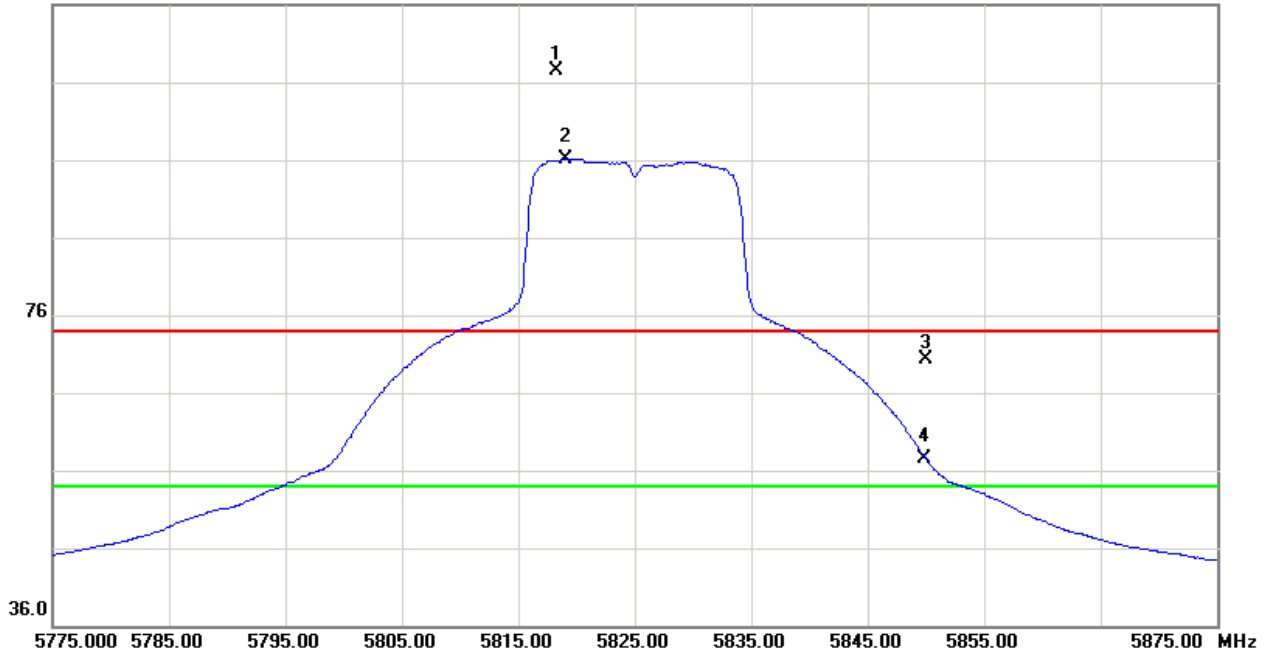

90.0 dBuV/m

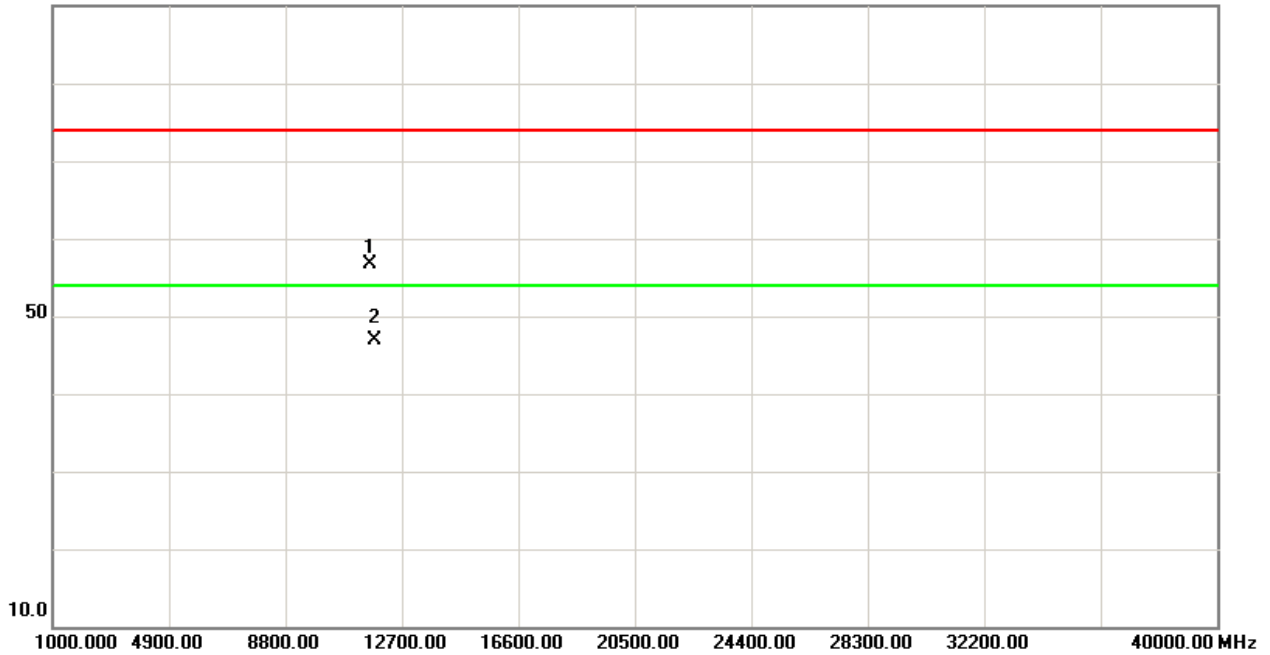



TX CH165 (Above 1000 MHz, Horizontal)

116.0 dBuV/m

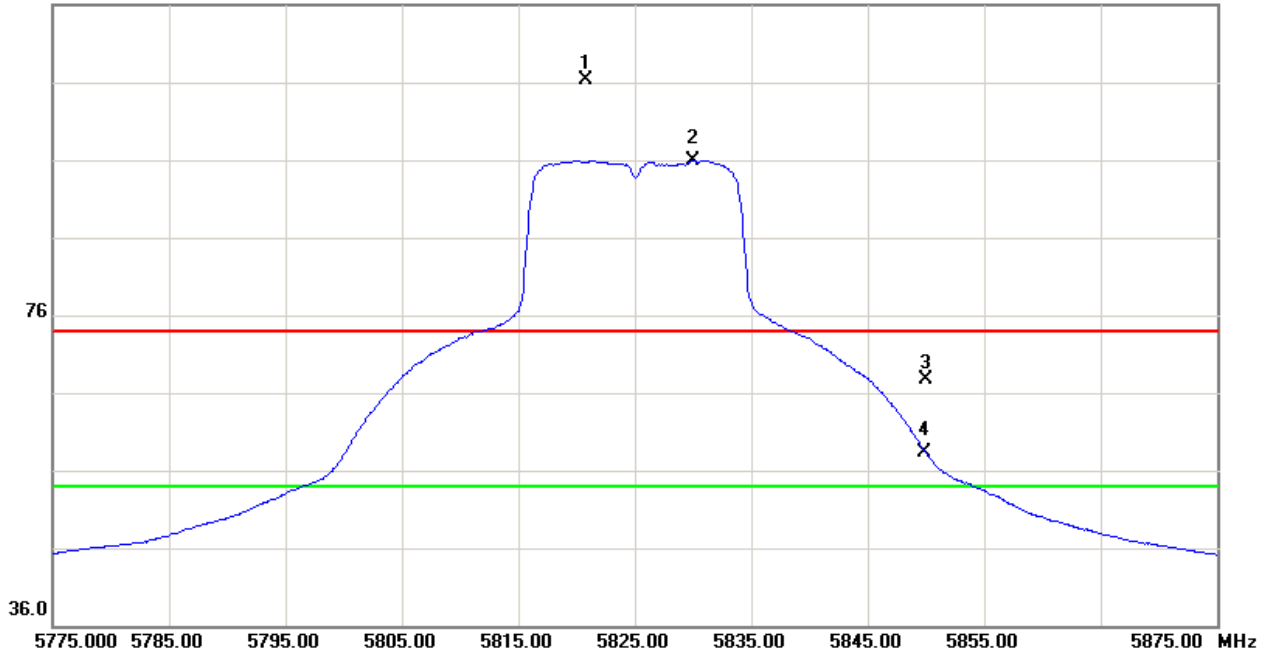

90.0 dBuV/m

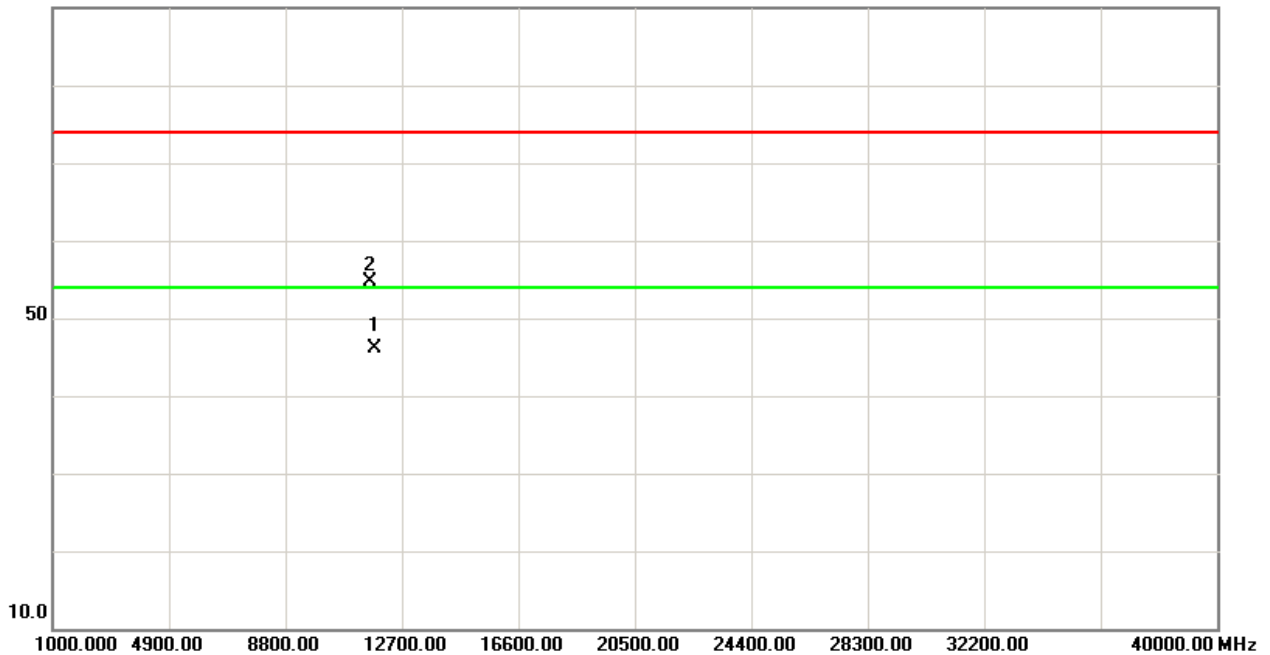



Test Mode : TX N-40M MODE 5755MHz

Freq. (MHz)	Ant.Pol. H/V	Reading (dBuV)		Ant./CF CF(dB)	Act. (dBuV/m)		Limit (dBuV/m)		Note
		Peak	AV		Peak	AV	Peak	AV	
#5725.00	V	33.09	20.72	44.34	77.43	65.06	82.11	71.82	X/E
<b>5751.20</b>	<b>V</b>	<b>57.67</b>	<b>47.38</b>	<b>44.44</b>	<b>102.11</b>	<b>91.82</b>			<b>X/F</b>
11512.80	V	36.88	27.24	18.52	55.40	45.76	74.00	54.00	X/H

Freq. (MHz)	Ant.Pol. H/V	Reading (dBuV)		Ant./CF CF(dB)	Act. (dBuV/m)		Limit (dBuV/m)		Note
		Peak	AV		Peak	AV	Peak	AV	
#5725.00	H	32.77	22.35	44.34	77.11	66.69	82.50	72.46	X/E
<b>5748.80</b>	<b>H</b>	<b>58.07</b>	<b>48.03</b>	<b>44.43</b>	<b>102.50</b>	<b>92.46</b>			<b>X/F</b>
11510.30	H	37.25	26.30	18.51	55.76	44.81	74.00	54.00	X/H

Test Mode : TX N-40M MODE 5795MHz

Freq. (MHz)	Ant.Pol. H/V	Reading (dBuV)		Ant./CF CF(dB)	Act. (dBuV/m)		Limit (dBuV/m)		Note
		Peak	AV		Peak	AV	Peak	AV	
<b>5800.60</b>	<b>V</b>	<b>58.91</b>	<b>48.25</b>	<b>44.61</b>	<b>103.52</b>	<b>92.86</b>			<b>X/F</b>
#5850.00	V	13.76	1.73	44.78	58.54	46.51	83.52	72.86	X/E
11590.40	V	35.29	27.34	18.72	54.01	46.06	74.00	54.00	X/H

Freq. (MHz)	Ant.Pol. H/V	Reading (dBuV)		Ant./CF CF(dB)	Act. (dBuV/m)		Limit (dBuV/m)		Note
		Peak	AV		Peak	AV	Peak	AV	
<b>5799.20</b>	<b>H</b>	<b>57.50</b>	<b>47.26</b>	<b>44.61</b>	<b>102.11</b>	<b>91.87</b>			<b>X/F</b>
#5850.00	H	12.57	2.99	44.78	57.35	47.77	82.11	71.87	X/E
11590.50	H	35.84	26.73	18.72	54.56	45.45	74.00	54.00	X/H



TX CH151 (Above 1000 MHz, Vertical)

116.0 dBuV/m

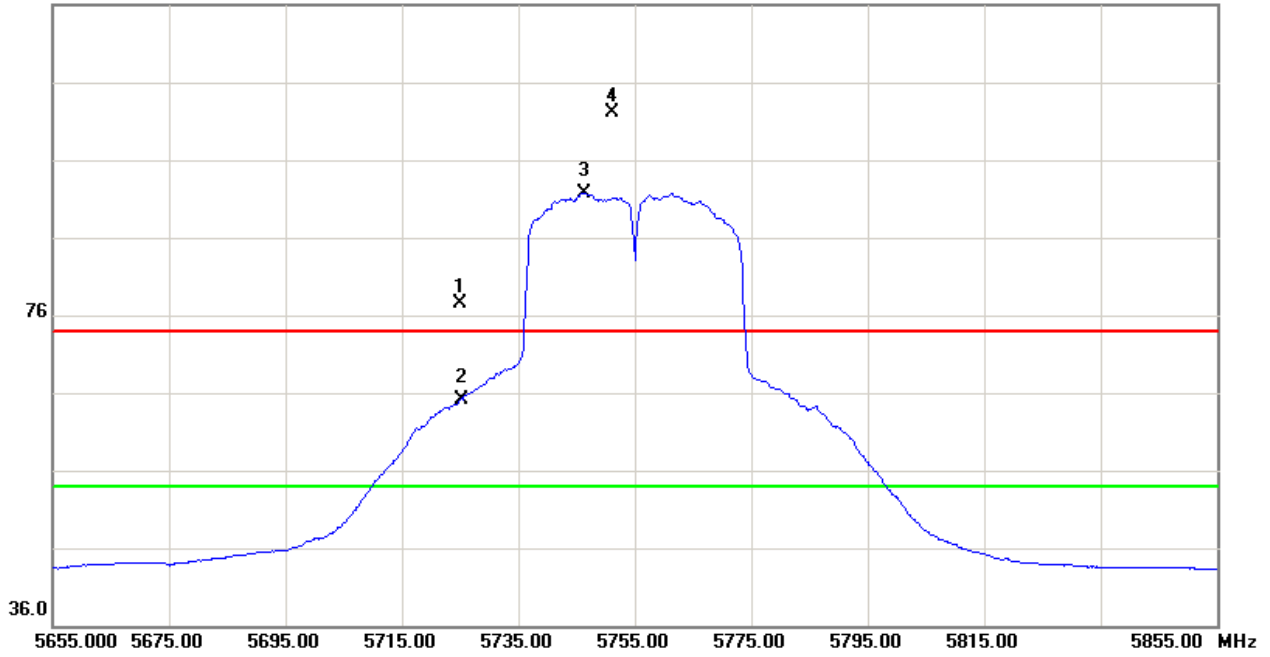

80.0 dBuV/m

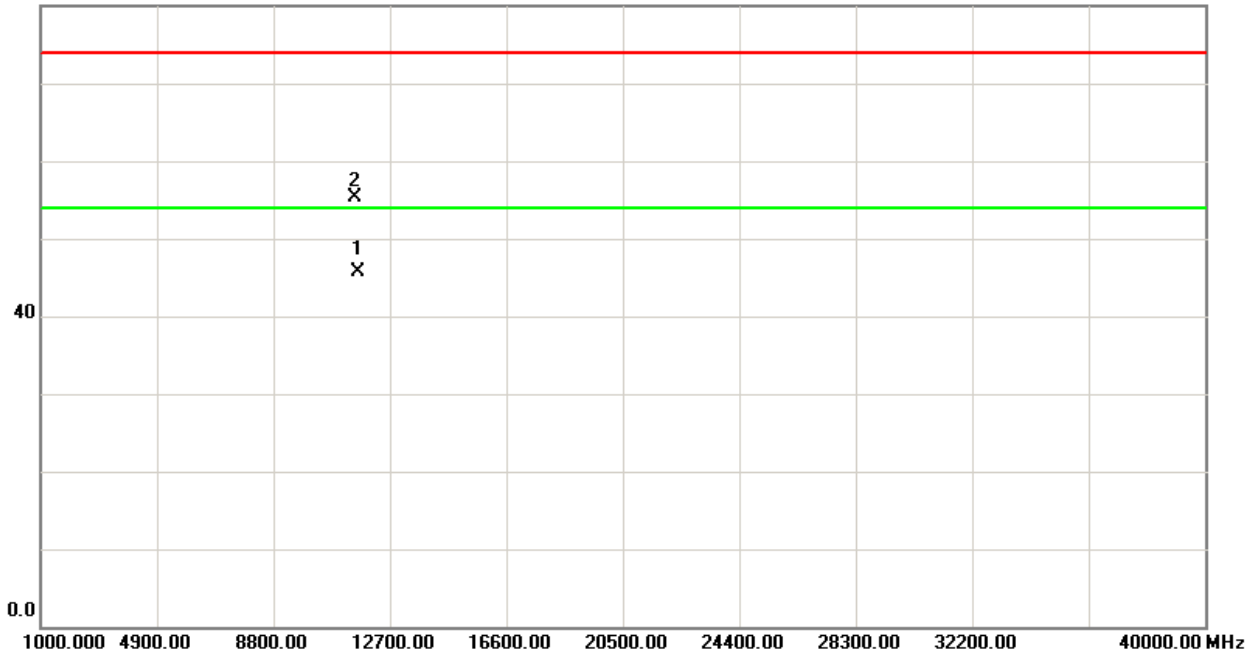



TX CH151 (Above 1000 MHz, Horizontal)

116.0 dBuV/m

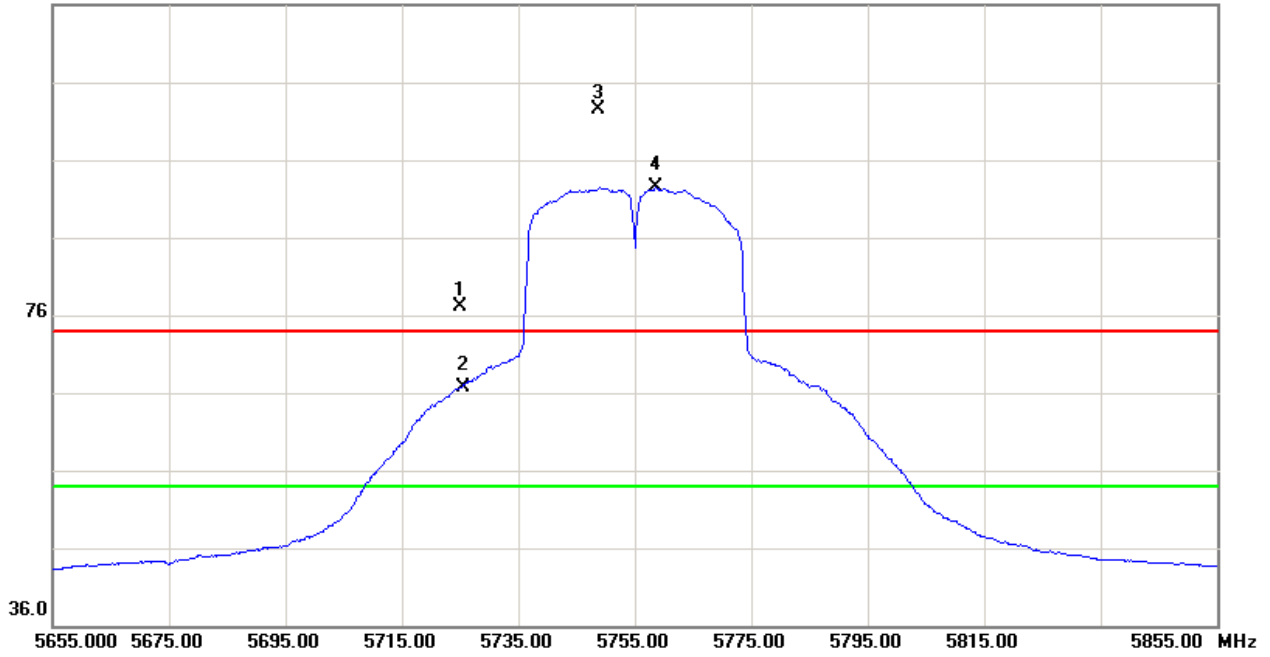

90.0 dBuV/m

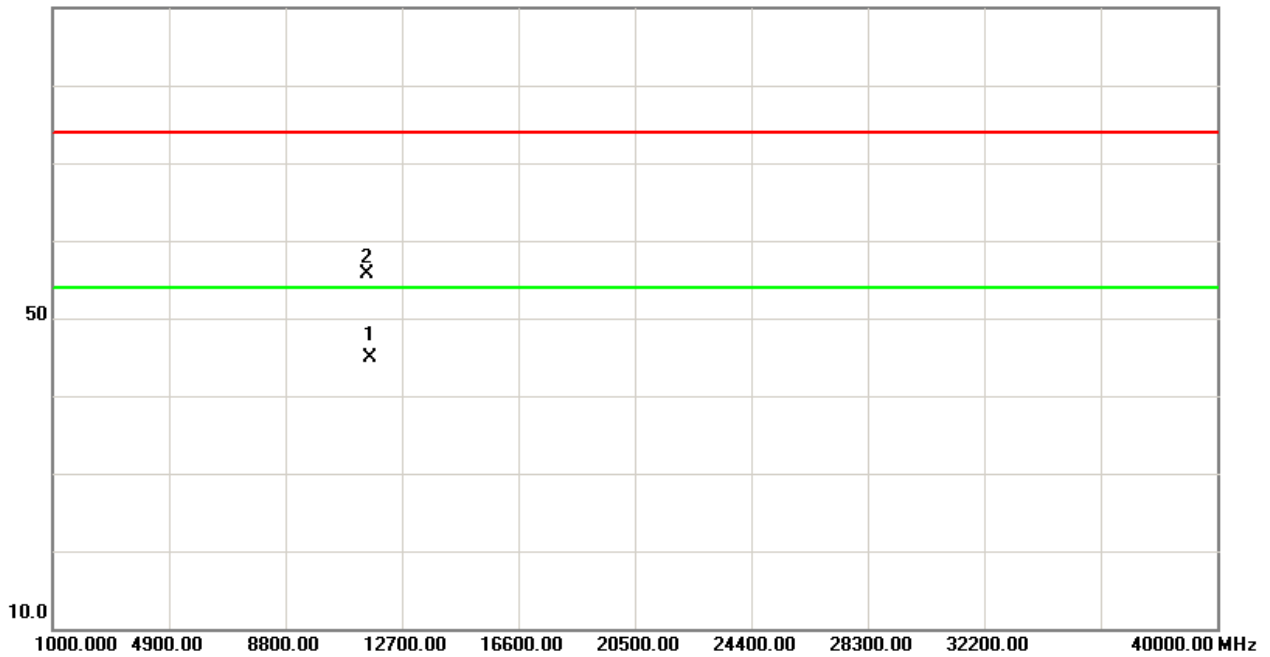



TX CH159 (Above 1000 MHz, Vertical)

116.0 dBuV/m

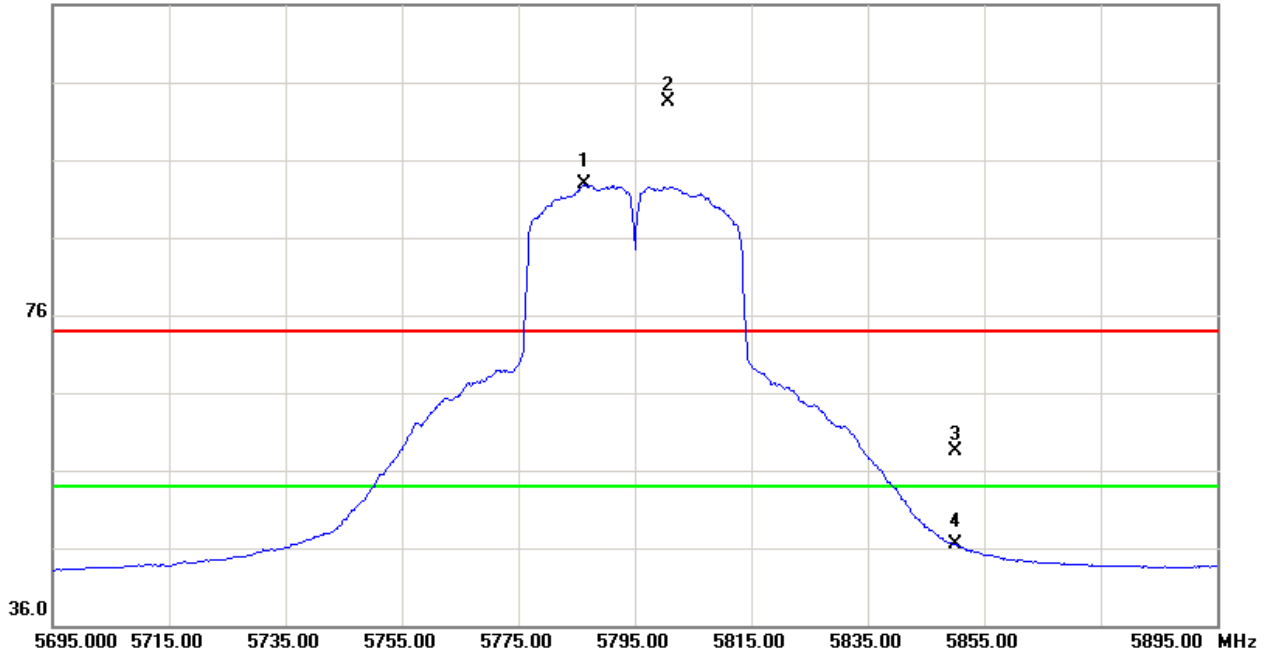

90.0 dBuV/m

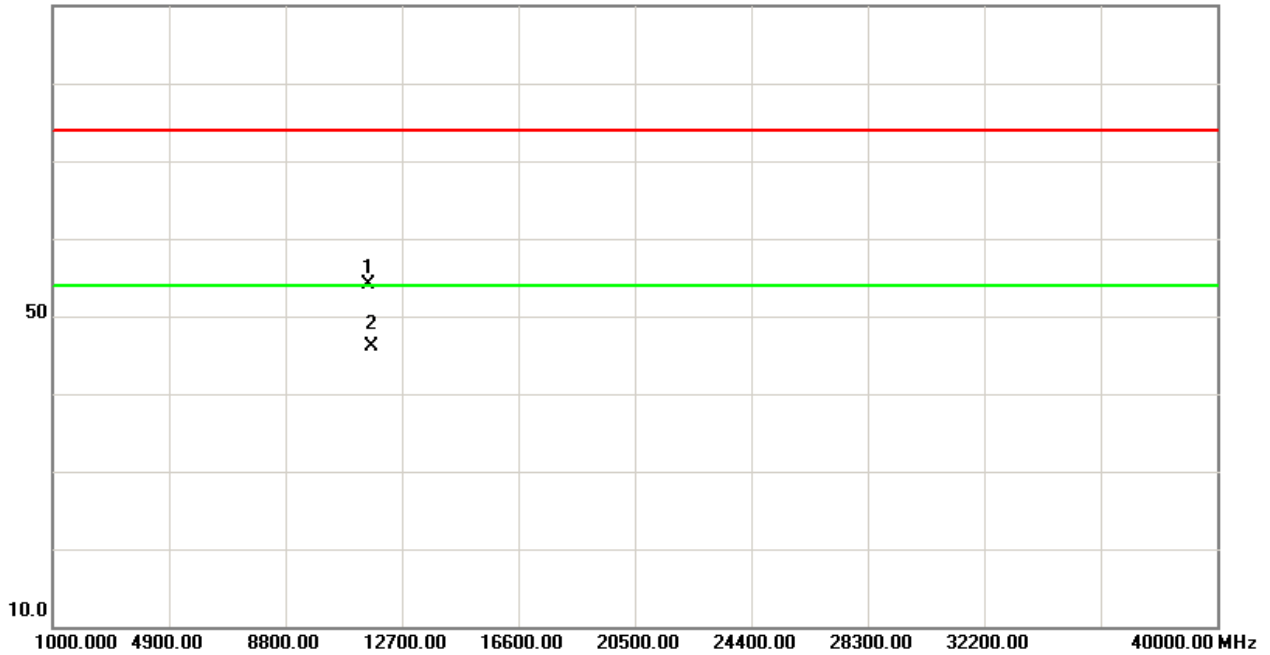



TX CH159 (Above 1000 MHz, Horizontal)

116.0 dBuV/m

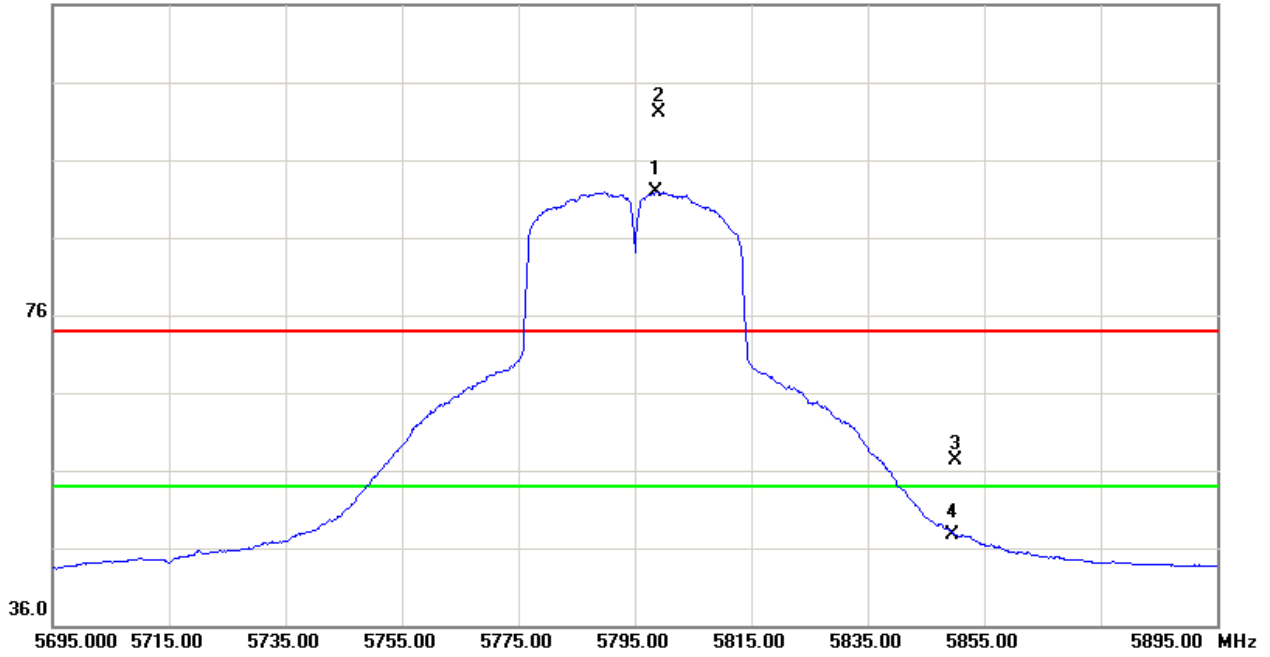

90.0 dBuV/m

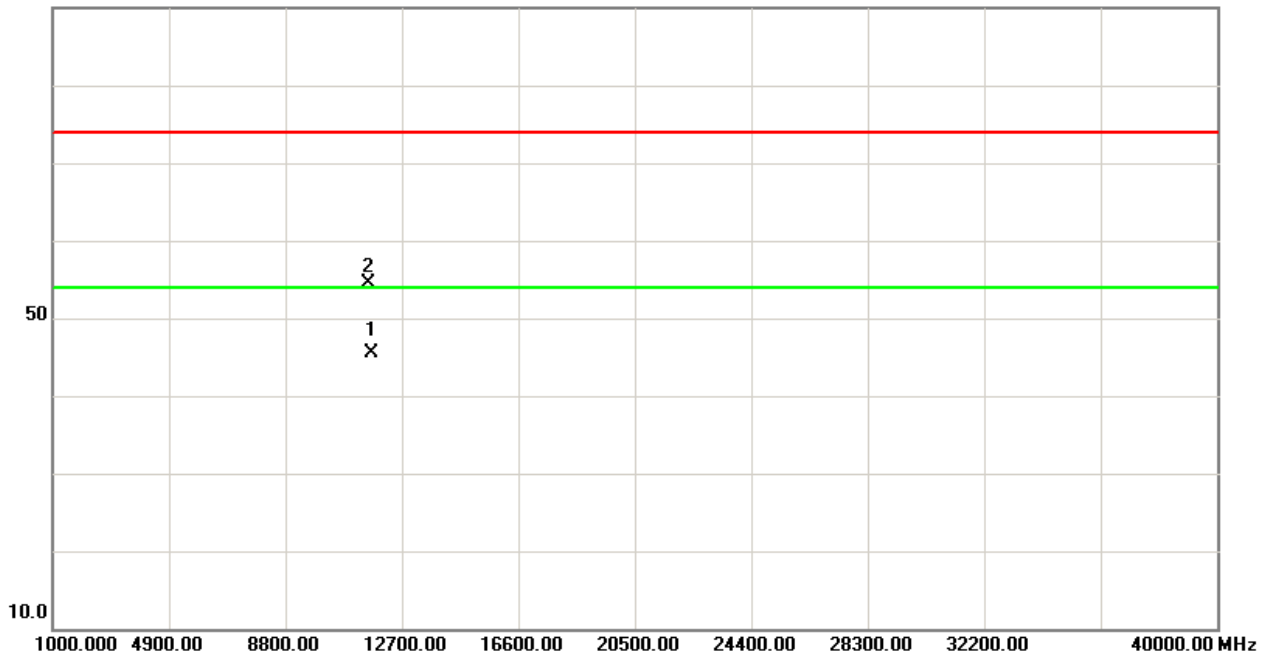



**5. BANDWIDTH TEST**

**5.1 Applied procedures**

FCC Part15 (15.247) , Subpart C/ RSS-GEN and RSS-210			
Section	Test Item	Frequency Range (MHz)	Result
15.247(a)(2) RSS-GEN section 4.6.1 RSS-210 Annex 8 (A8.2(a))	Bandwidth	5725 - 5825	PASS

**5.1.1 TEST PROCEDURE**

- a. The EUT was directly connected to the spectrum analyzer and antenna output port as show in the block diagram below,
- b. Spectrum Setting: RBW= 100KHz, VBW=300KHz, Sweep time = Auto.

**5.1.2 DEVIATION FROM STANDARD**

No deviation.

**5.1.3 TEST SETUP**



**5.1.4 EUT OPERATION CONDITIONS**

The EUT tested system was configured as the statements of 4.1.6 Unless otherwise a special operating condition is specified in the follows during the testing.

**5.1.5 EUT TEST CONDITIONS**

Temperature: 25°C  
 Relative Humidity: 55%  
 Test Voltage: AC 120V/60Hz



5.1.6 TEST RESULTS

Test Mode : TX A Mode\_CH149/157/165

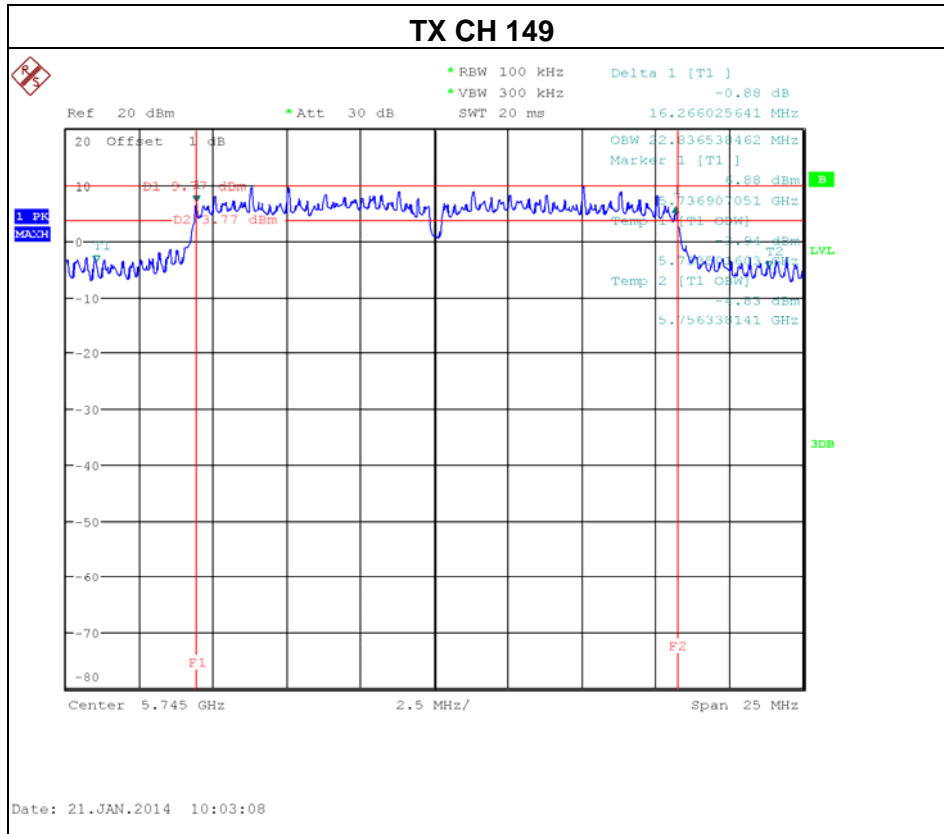

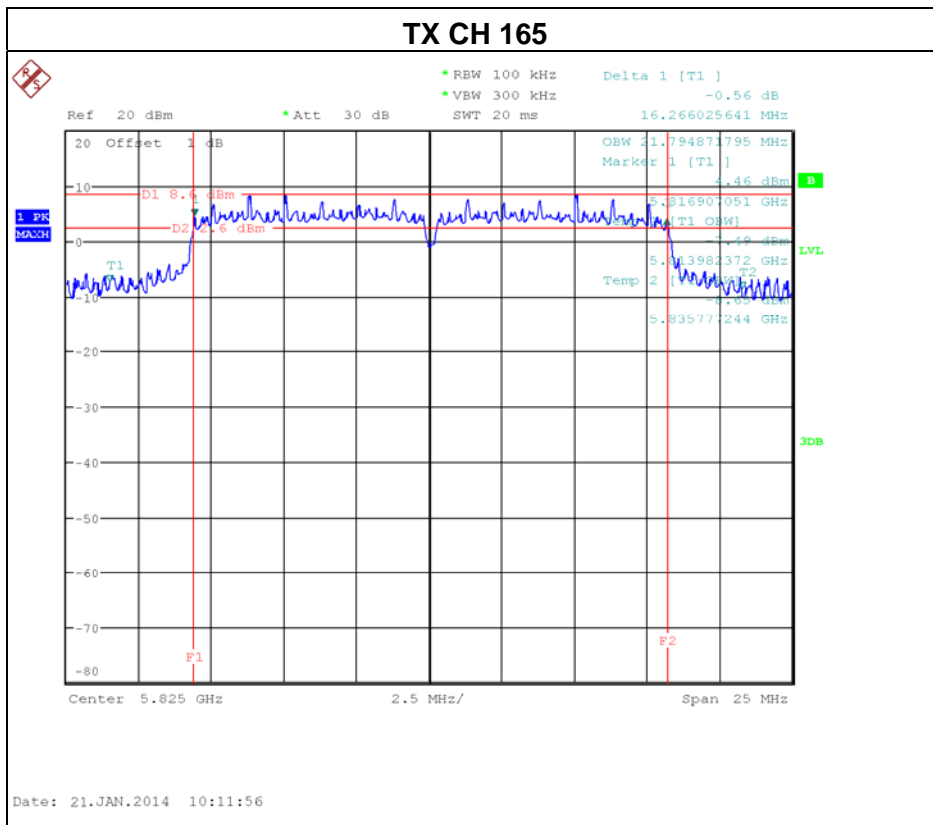
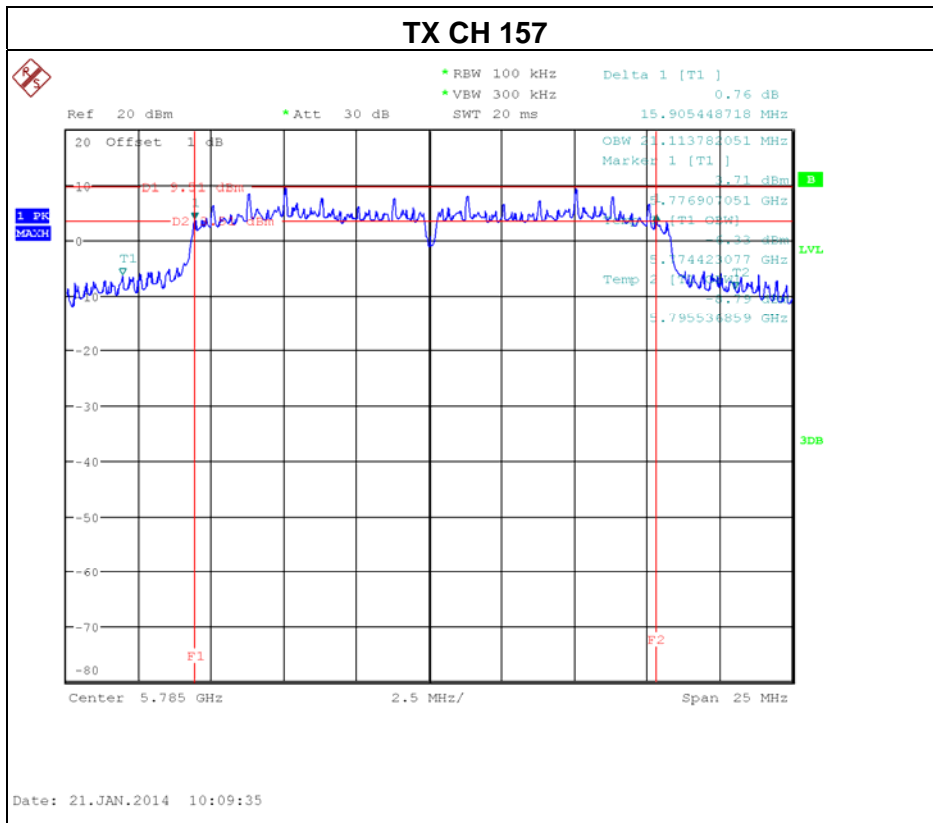



Test Mode : TX N-20MHz Mode\_CH149/157/165\_ANT 1

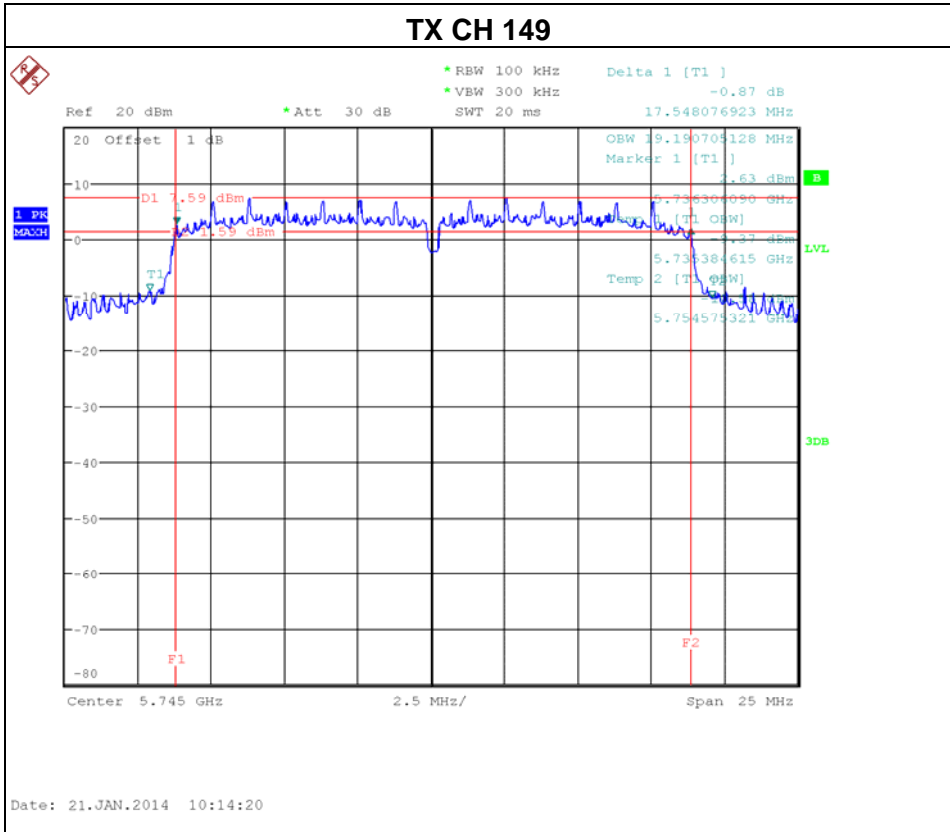

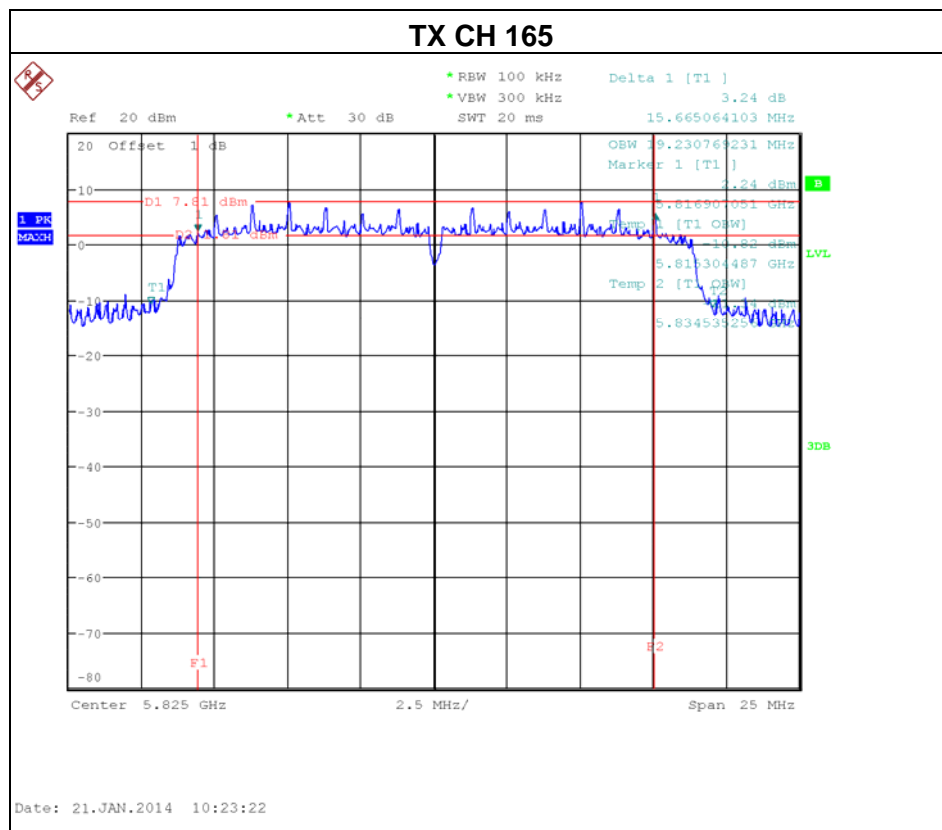
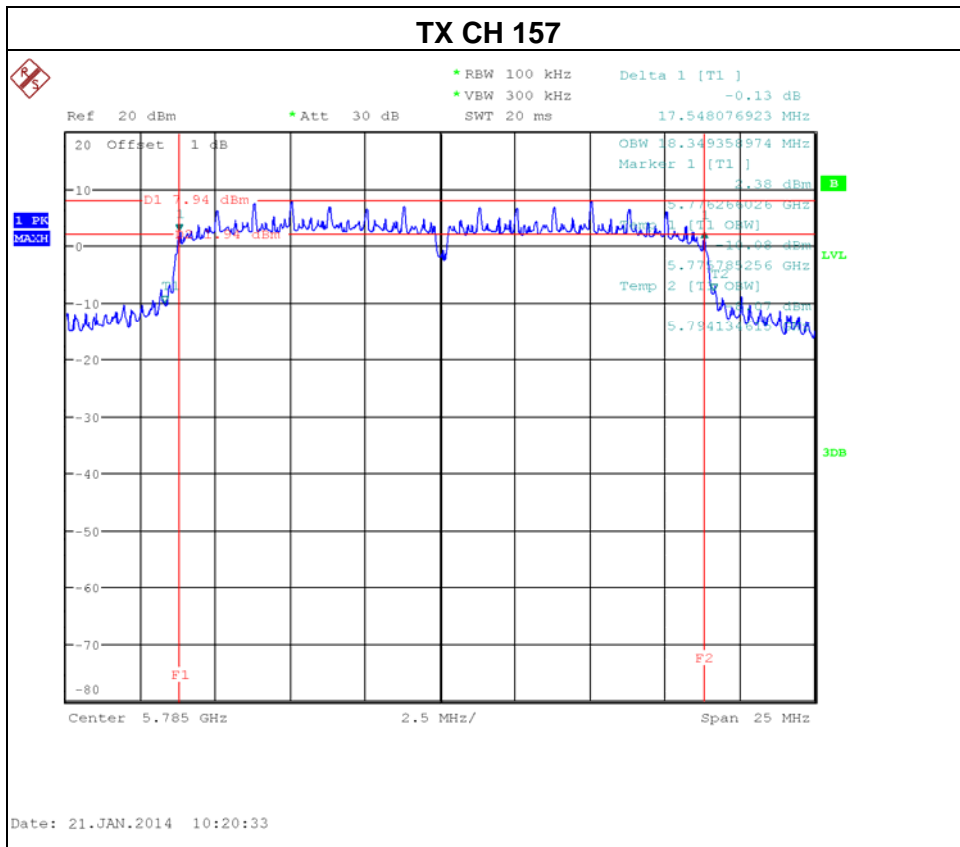



Test Mode : TX N-20MHz Mode\_CH149/157/165\_ANT 2

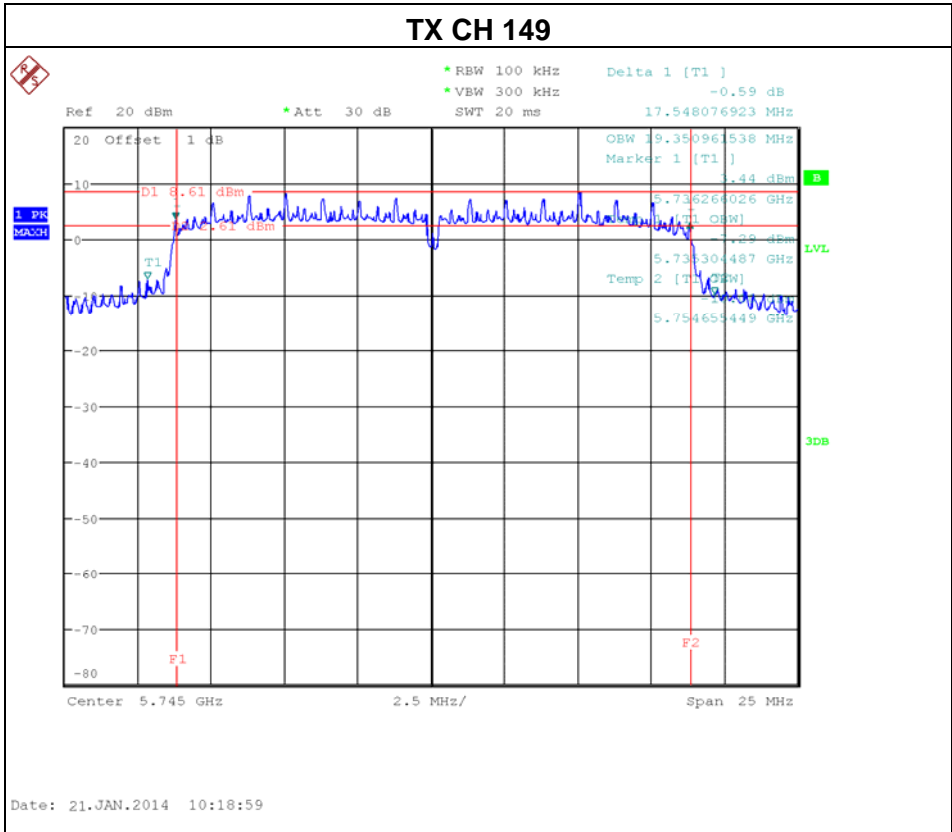

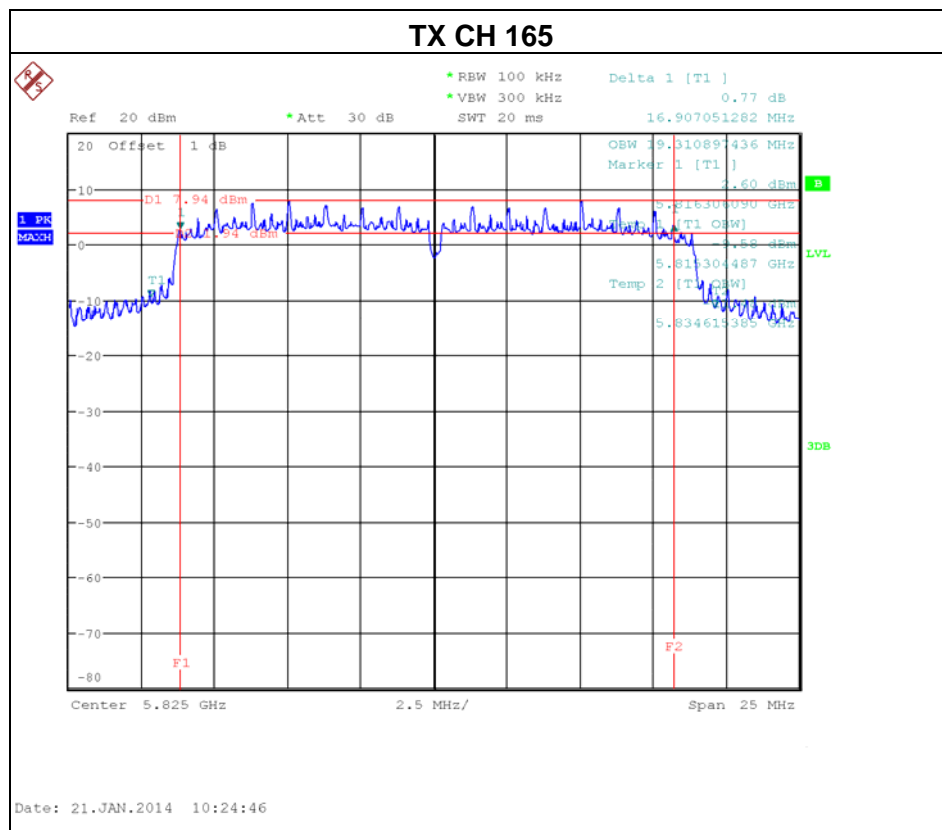
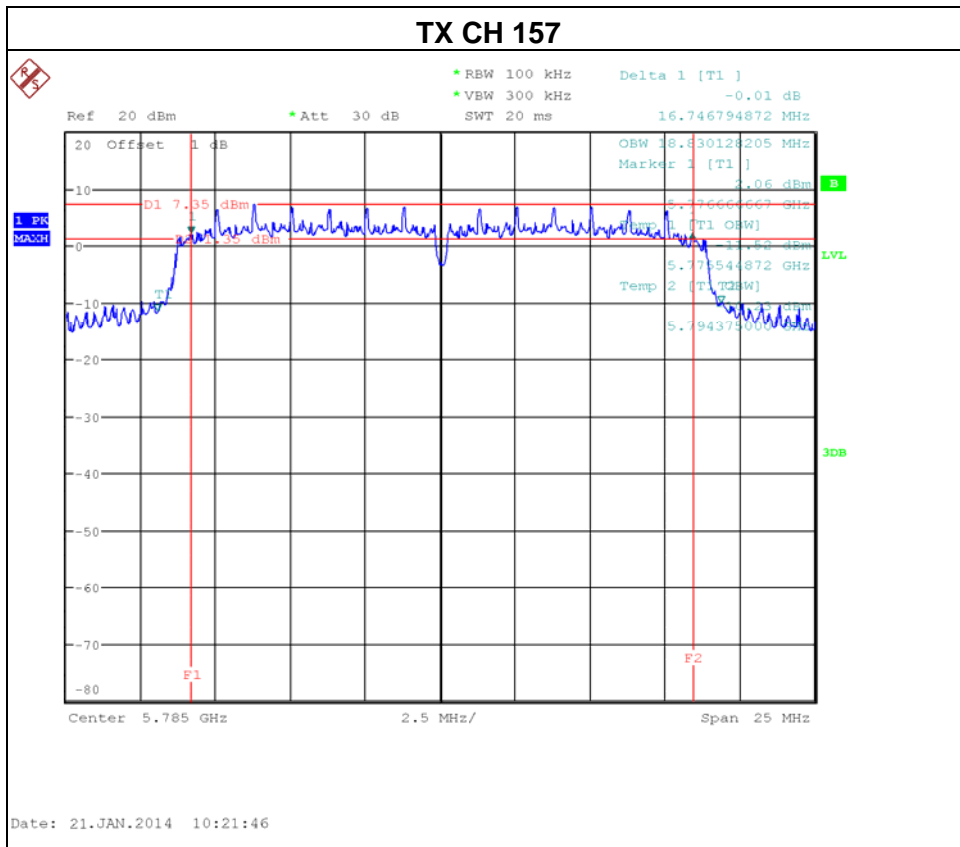



Test Mode : TX N-40MHz Mode\_CH151/159\_ANT 1

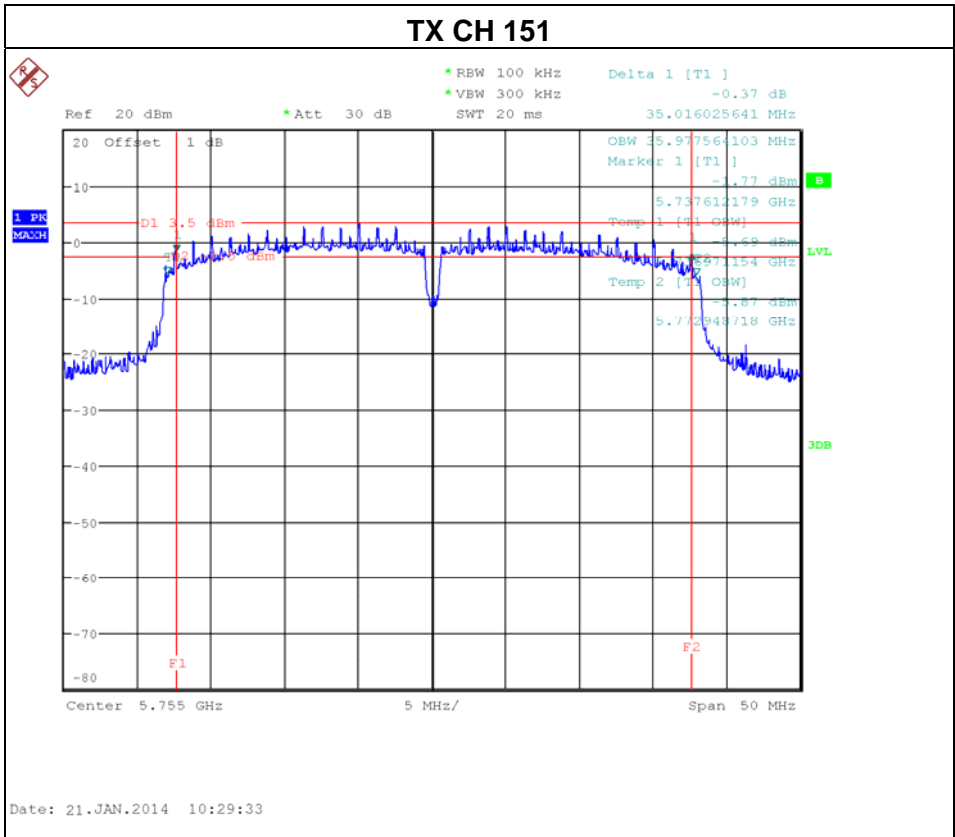

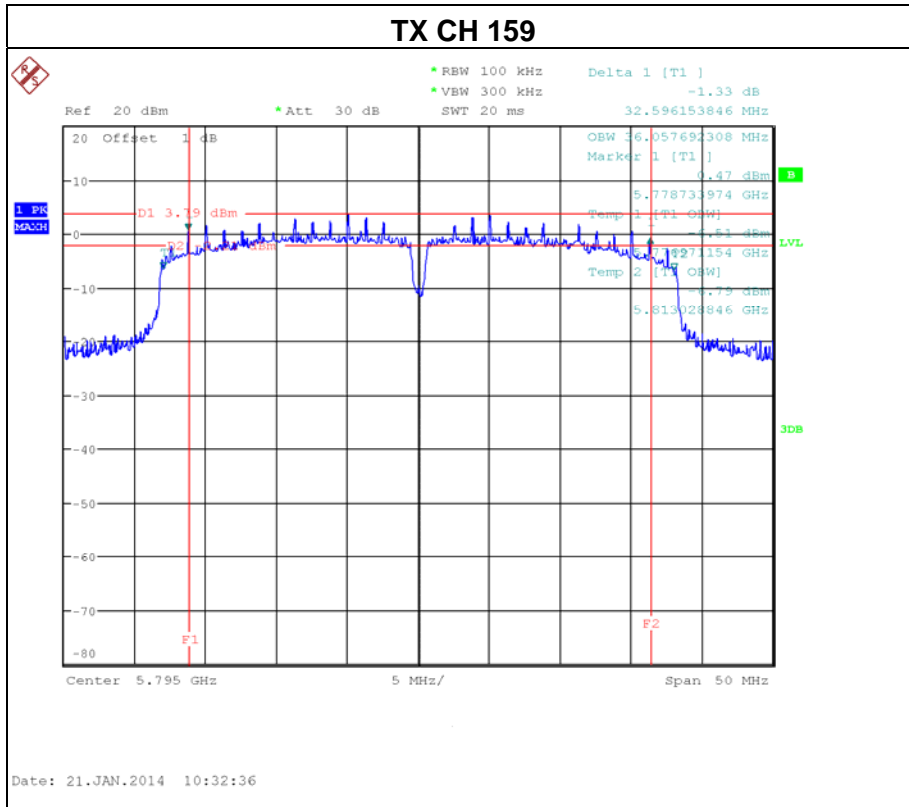



Test Mode : TX N-40MHz Mode\_CH151/159\_ANT 2

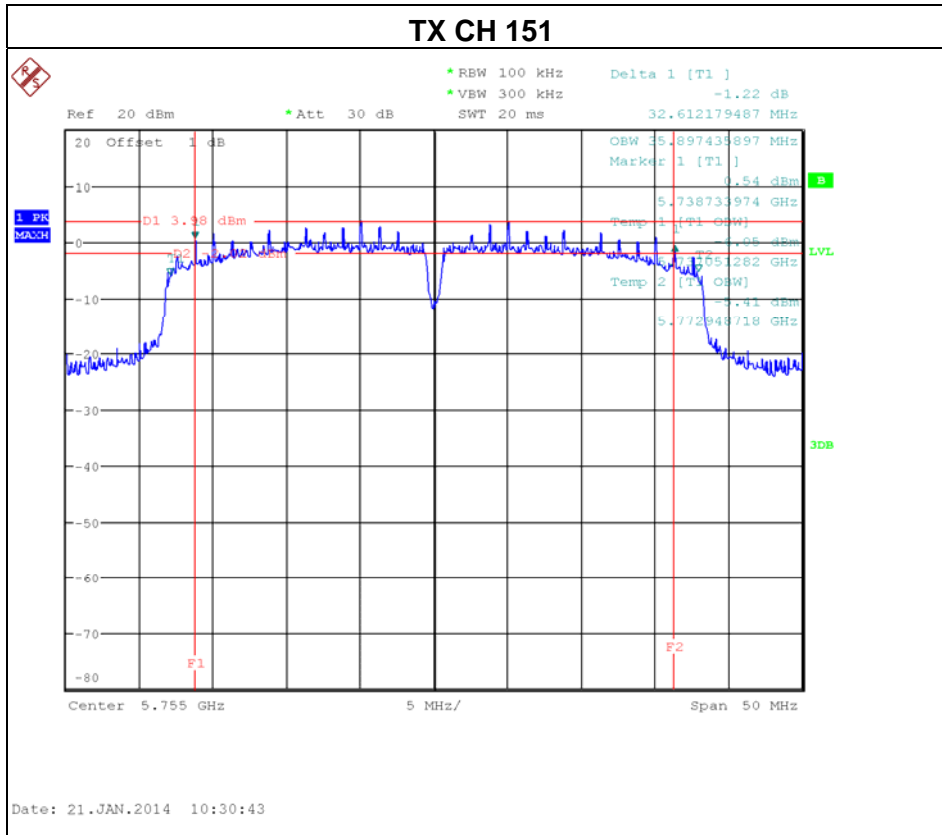

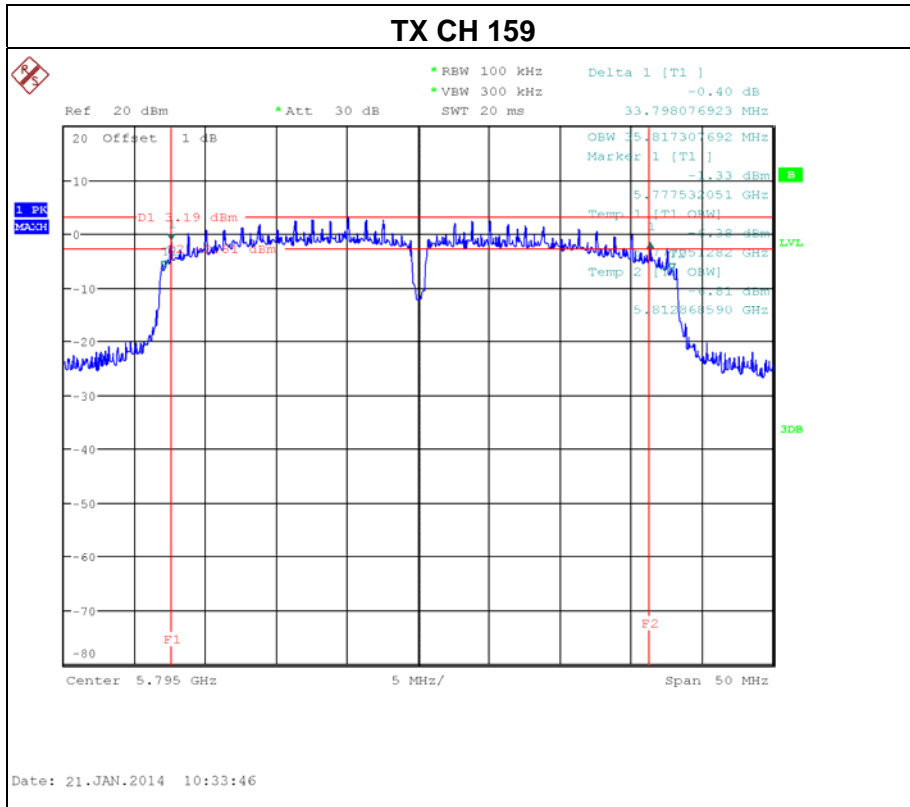



**6. MAXIMUM OUTPUT POWER TEST**

**6.1 Applied procedures / limit**

FCC Part15 (15.247) , Subpart C/ RSS-210				
Section	Test Item	Limit	Frequency Range (MHz)	Result
15.247(b)(3) RSS-210 Annex 8.4(4)	Maximum Output Power	1 Watt or 30dBm	5725 - 5825	PASS

**6.1.1 TEST PROCEDURE**

- a. The EUT was directly connected to the power meter and antenna output port as show in the block diagram below,
- b. The maximum peak conducted output power was performed in accordance with method 9.1.3 of FCC KDB 558074 D01 DTS Meas Guidance v03r01.

**6.1.2 DEVIATION FROM STANDARD**

No deviation.

**6.1.3 TEST SETUP**



**6.1.4 EUT OPERATION CONDITIONS**

The EUT tested system was configured as the statements of 4.1.6 Unless otherwise a special operating condition is specified in the follows during the testing. Transmit output power was measured while the host equipment supply voltage was varied from 85 % to 115 % of the nominal rated supply voltage. No change in transmit output power was observed.

**6.1.5 EUT TEST CONDITIONS**

Temperature: 25°C  
 Relative Humidity: 55%  
 Test Voltage: AC 120V/60Hz



**6.1.6 TEST RESULTS**

Test Mode : TX A Mode				
Test Channel	Frequency (MHz)	Output Power (dBm)	Limit (dBm)	Limit (Watt)
CH149	5745	21.71	30	1
CH157	5785	21.62	30	1
CH165	5825	21.51	30	1



**Test Mode : TX N-20M Mode\_ANT 1**

Test Channel	Frequency (MHz)	Output Power (dBm)	Limit (dBm)	Limit (Watt)
CH149	5745	20.45	30	1
CH157	5785	20.25	30	1
CH165	5825	20.17	30	1

**Test Mode : TX N-20M Mode\_ANT 2**

Test Channel	Frequency (MHz)	Output Power (dBm)	Limit (dBm)	Limit (Watt)
CH149	5745	21.04	30	1
CH157	5785	20.87	30	1
CH165	5825	20.84	30	1

**Test Mode : TX N-20M Mode\_Total**

Test Channel	Frequency (MHz)	Output Power (dBm)	Limit (dBm)	Limit (Watt)
CH149	5745	23.77	30	1
CH157	5785	23.58	30	1
CH165	5825	23.53	30	1



**Test Mode : TX N-40M Mode\_ANT 1**

Test Channel	Frequency (MHz)	Output Power (dBm)	Limit (dBm)	Limit (Watt)
CH151	5755	20.12	30	1
CH159	5795	20.04	30	1

**Test Mode : TX N-40M Mode\_ANT 2**

Test Channel	Frequency (MHz)	Output Power (dBm)	Limit (dBm)	Limit (Watt)
CH151	5755	20.69	30	1
CH159	5795	20.63	30	1

**Test Mode : TX N-40M Mode\_Total**

Test Channel	Frequency (MHz)	Output Power (dBm)	Limit (dBm)	Limit (Watt)
CH151	5755	23.42	30	1
CH159	5795	23.36	30	1



## **7. ANTENNA CONDUCTED SPURIOUS EMISSION**

### **7.1 Applied procedures / limit**

In any 100 kHz bandwidth outside the frequency band in which the spread spectrum or digitally modulated intentional radiator is operating, the radio frequency power that is produced by the intentional radiator shall be at least 20 dB below that in the 100 kHz bandwidth within the band that contains the highest level of the desired power, based on either an RF conducted measurement, provided the transmitter demonstrates compliance with the peak conducted power limits.

#### **7.1.1 TEST PROCEDURE**

- a. The EUT was directly connected to the spectrum analyzer and antenna output port as show in the block diagram below,
- b. Spectrum Setting: RBW= 100KHz, VBW=300KHz, Sweep time = Auto.

#### **7.1.2 DEVIATION FROM STANDARD**

No deviation.

#### **7.1.3 TEST SETUP**



#### **7.1.4 EUT OPERATION CONDITIONS**

The EUT tested system was configured as the statements of 4.1.6 Unless otherwise a special operating condition is specified in the follows during the testing.

#### **7.1.5 EUT TEST CONDITIONS**

Temperature: 25°C  
Relative Humidity: 55%  
Test Voltage: AC 120V/60Hz



**7.1.6 TEST RESULTS**

Test Mode :	TX A Mode
-------------	-----------

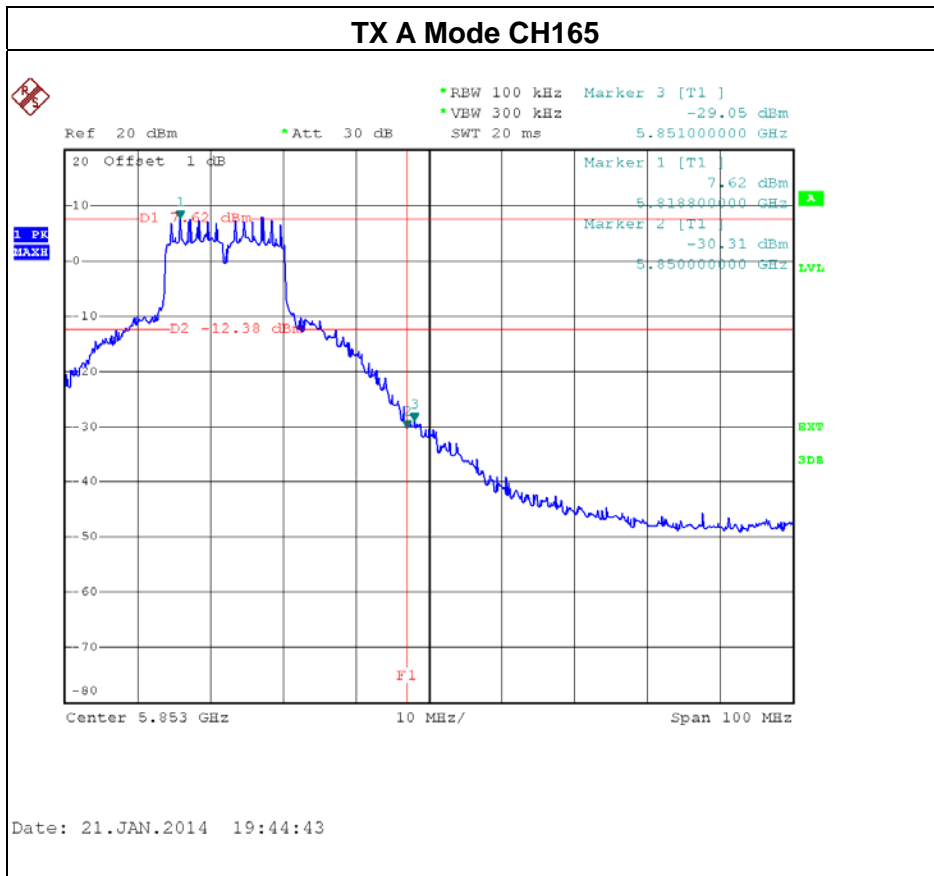
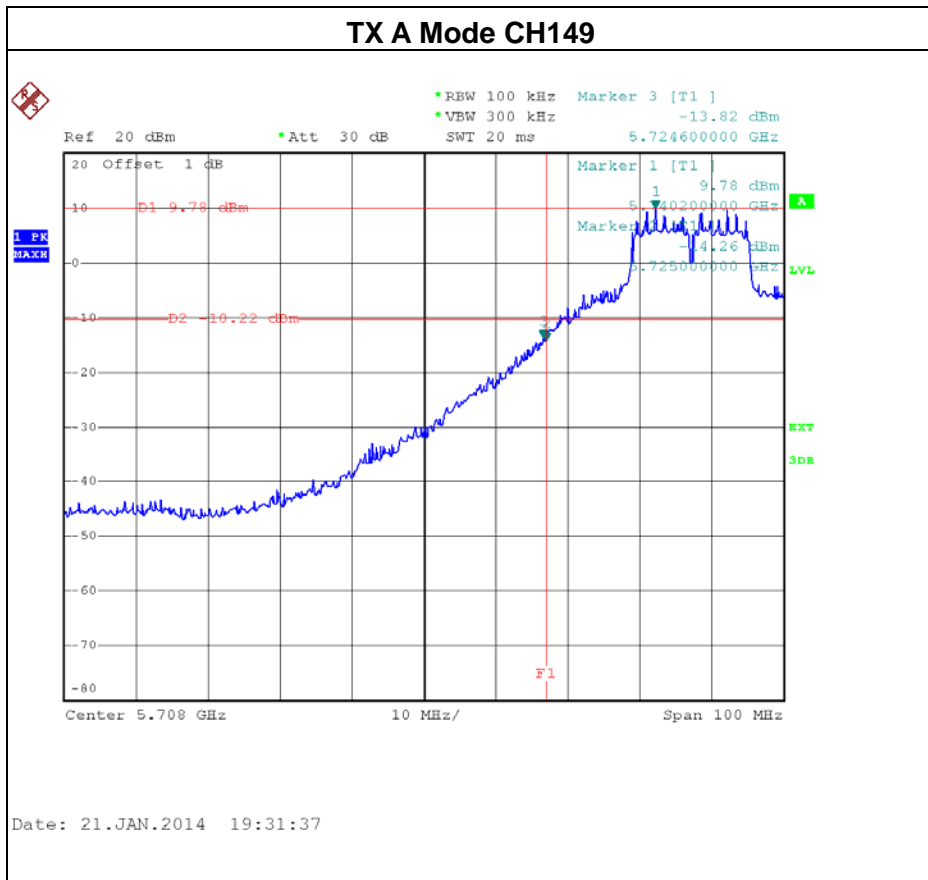

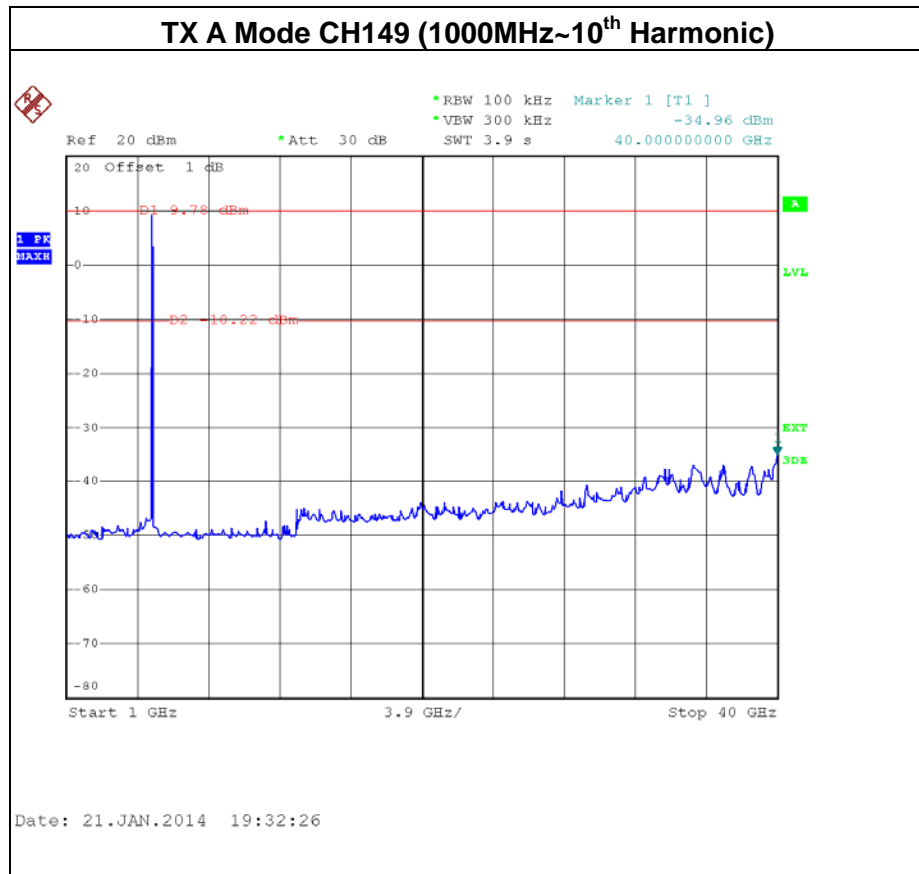
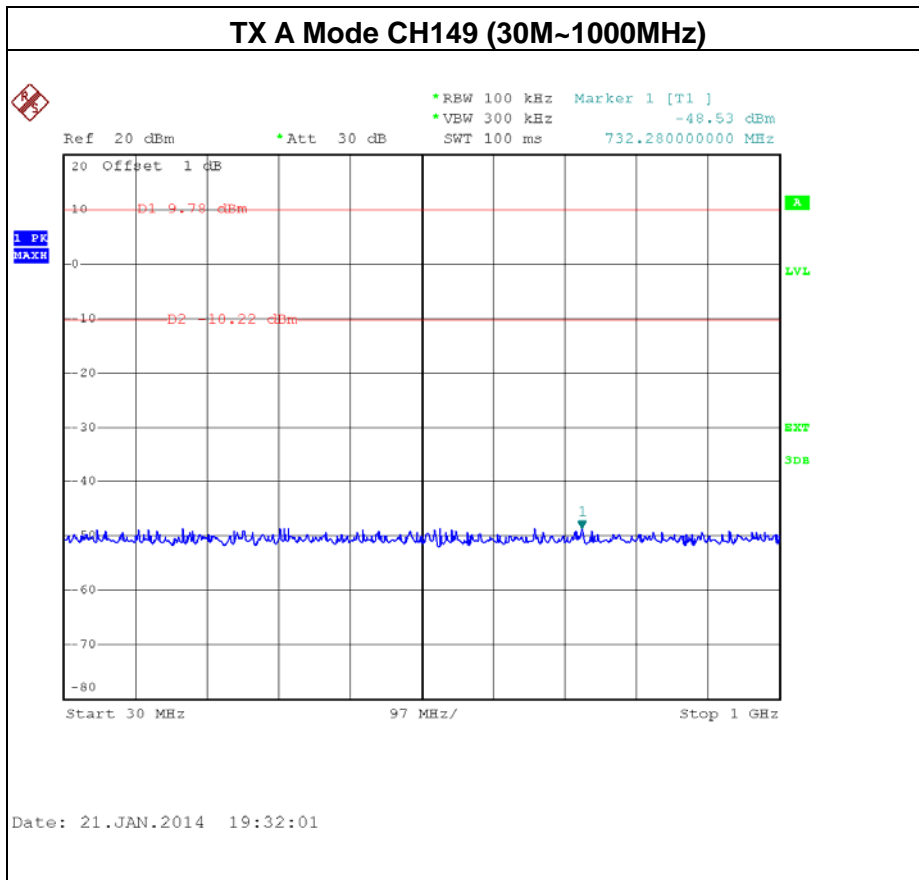

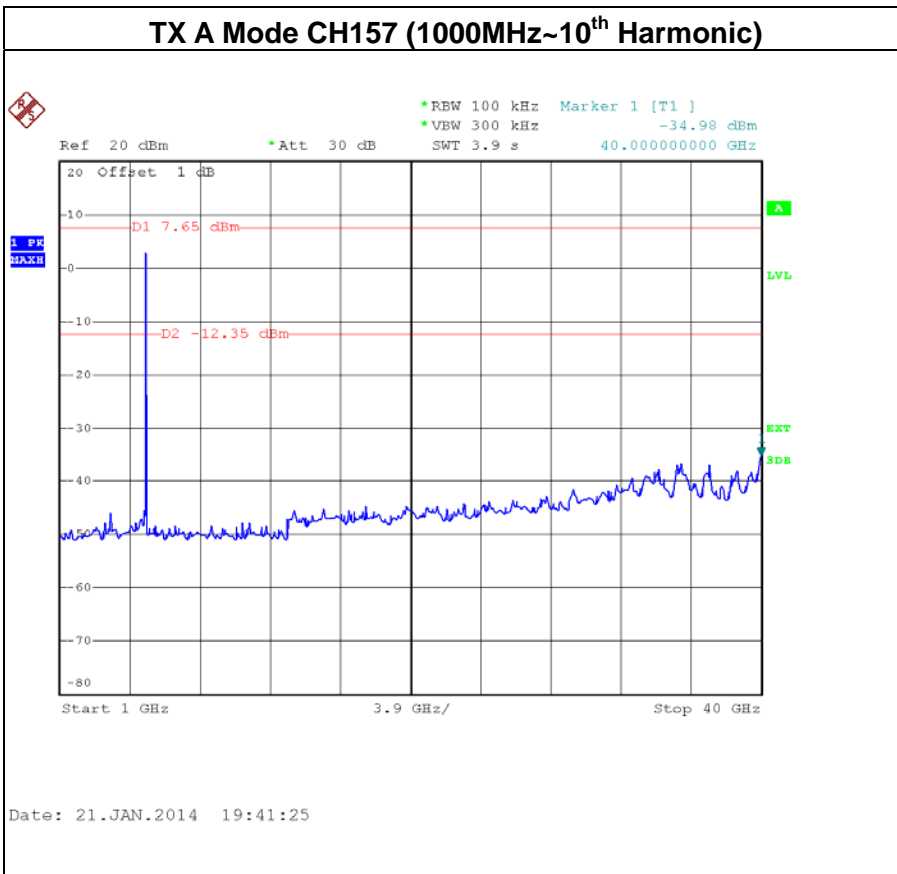
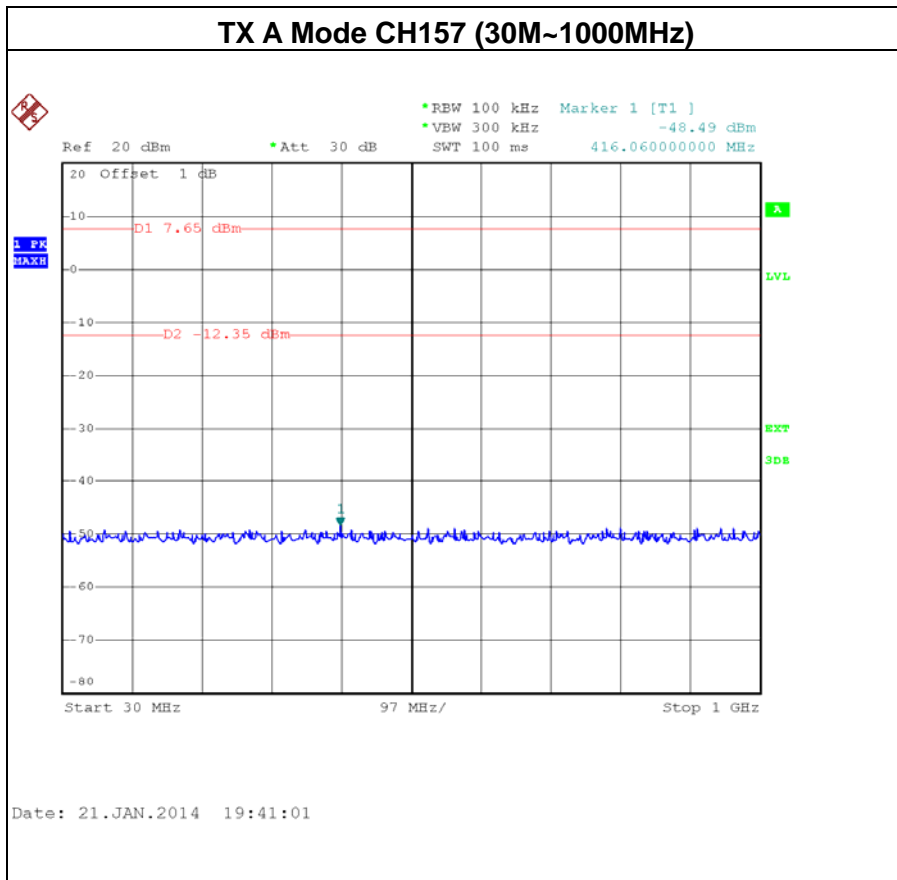

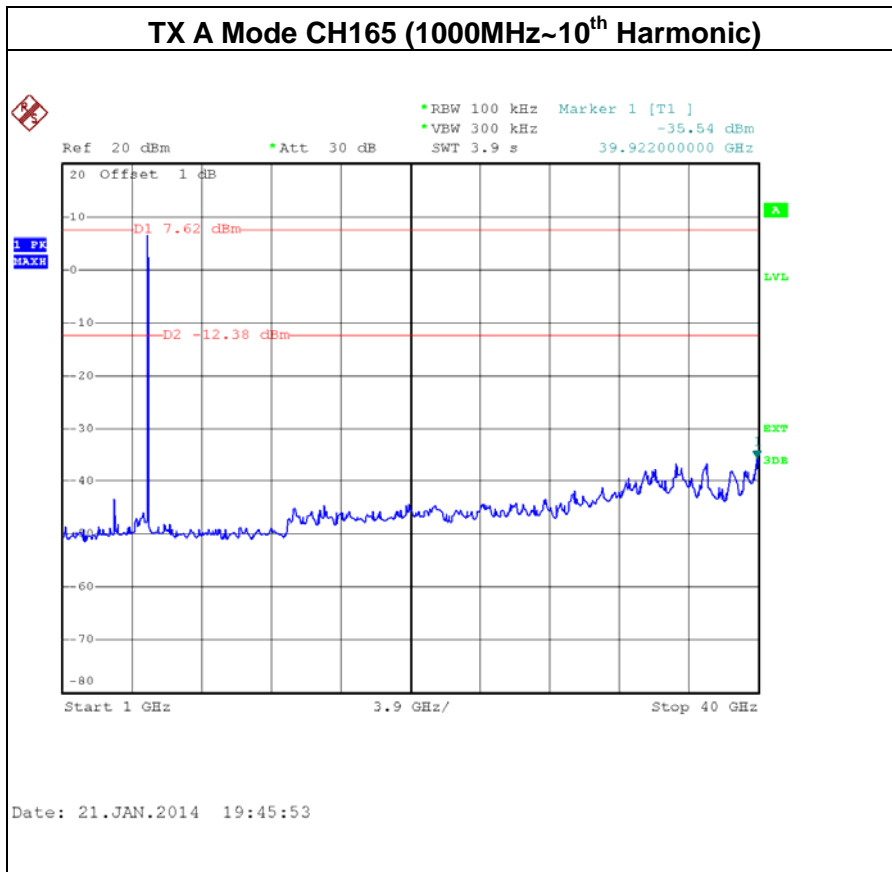
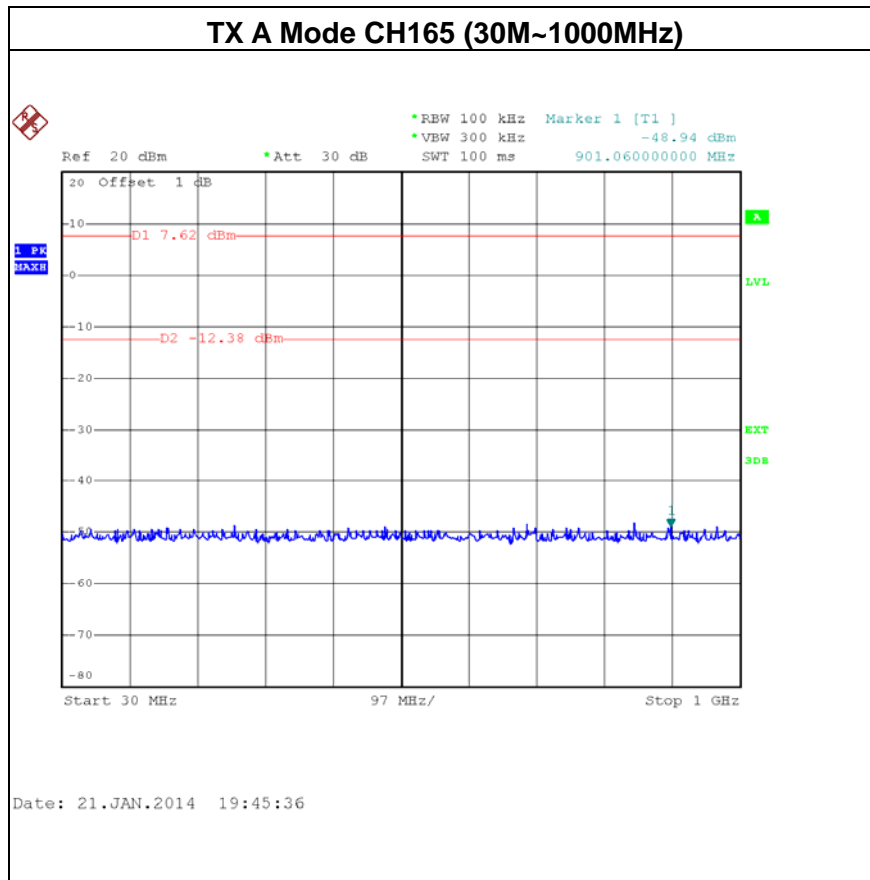



Test Mode :	TX N-20M Mode_ANT 1
-------------	---------------------

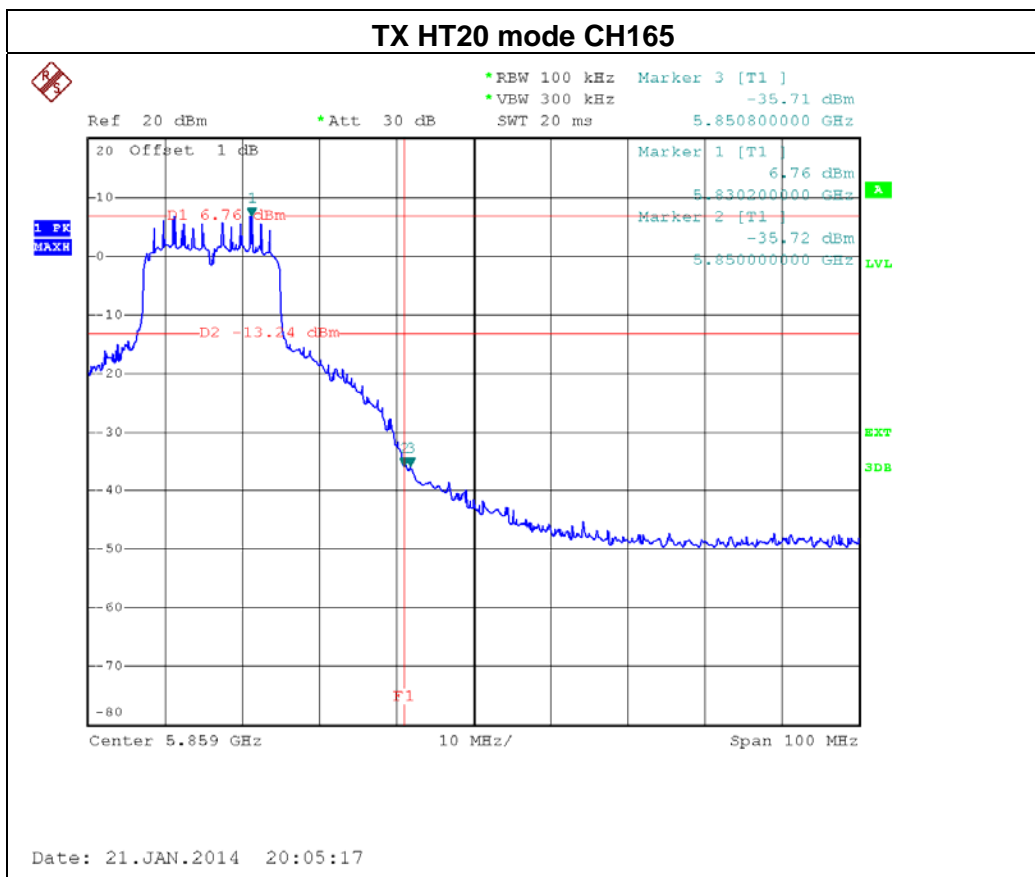
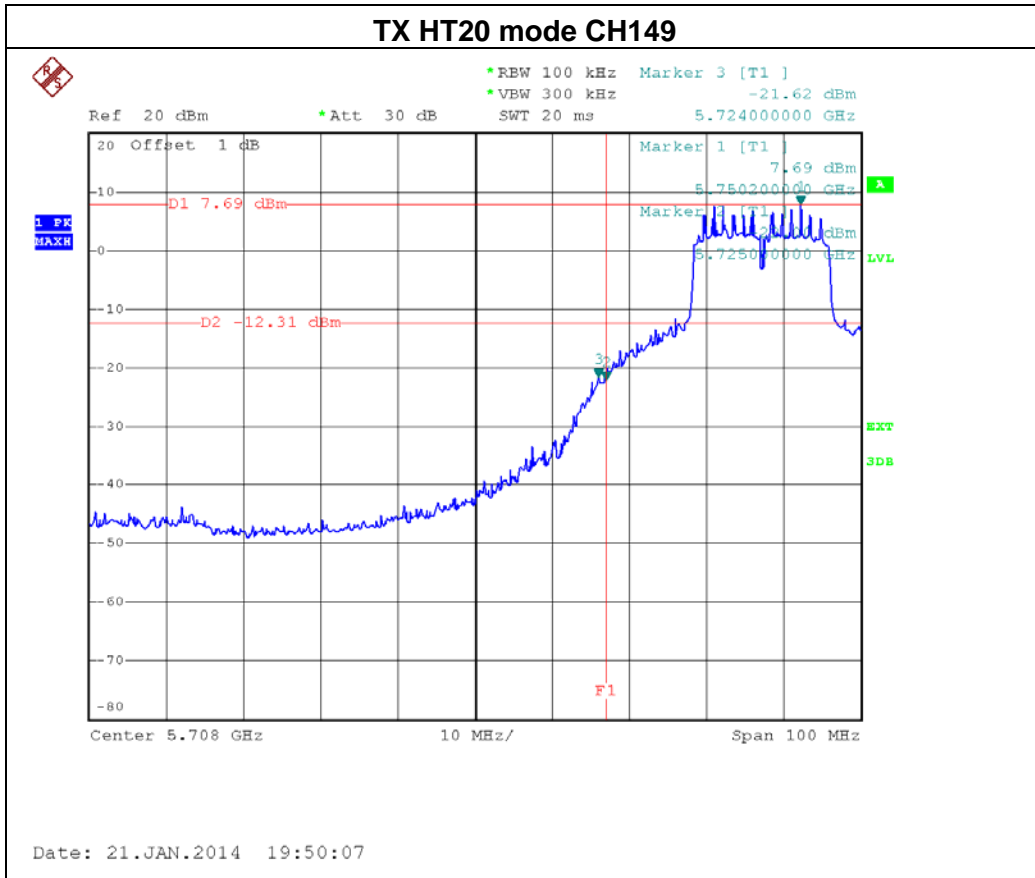



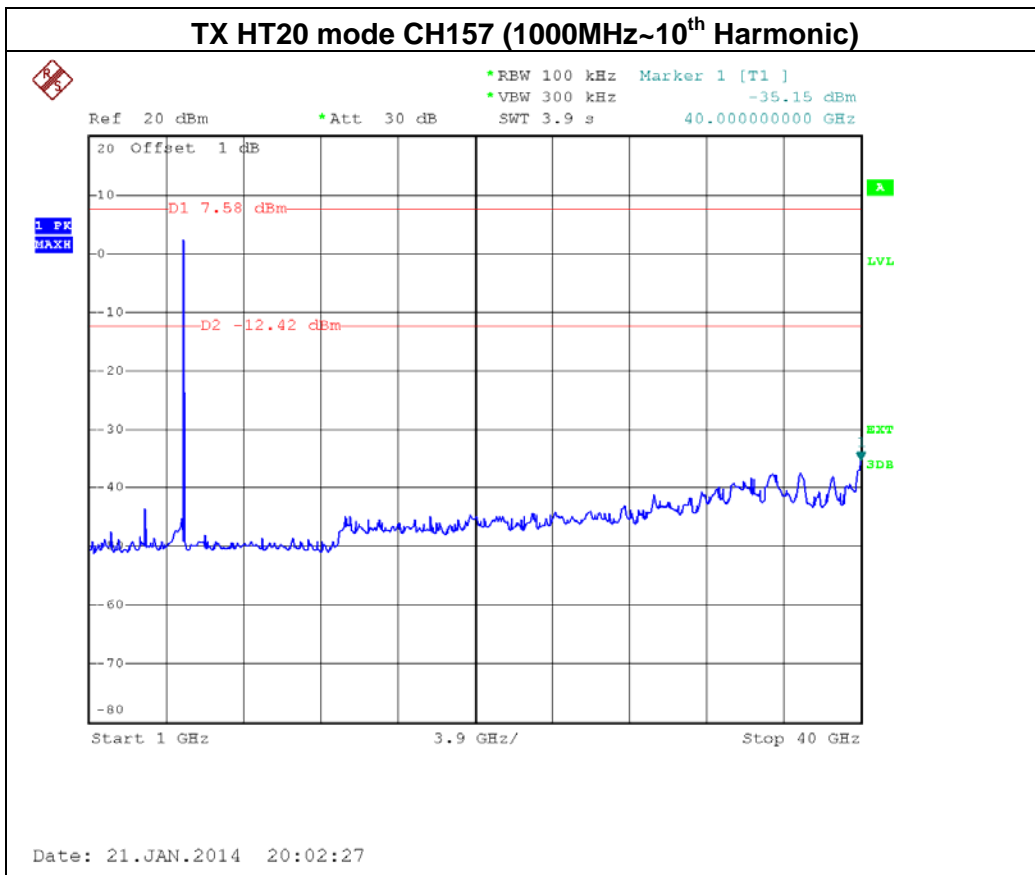
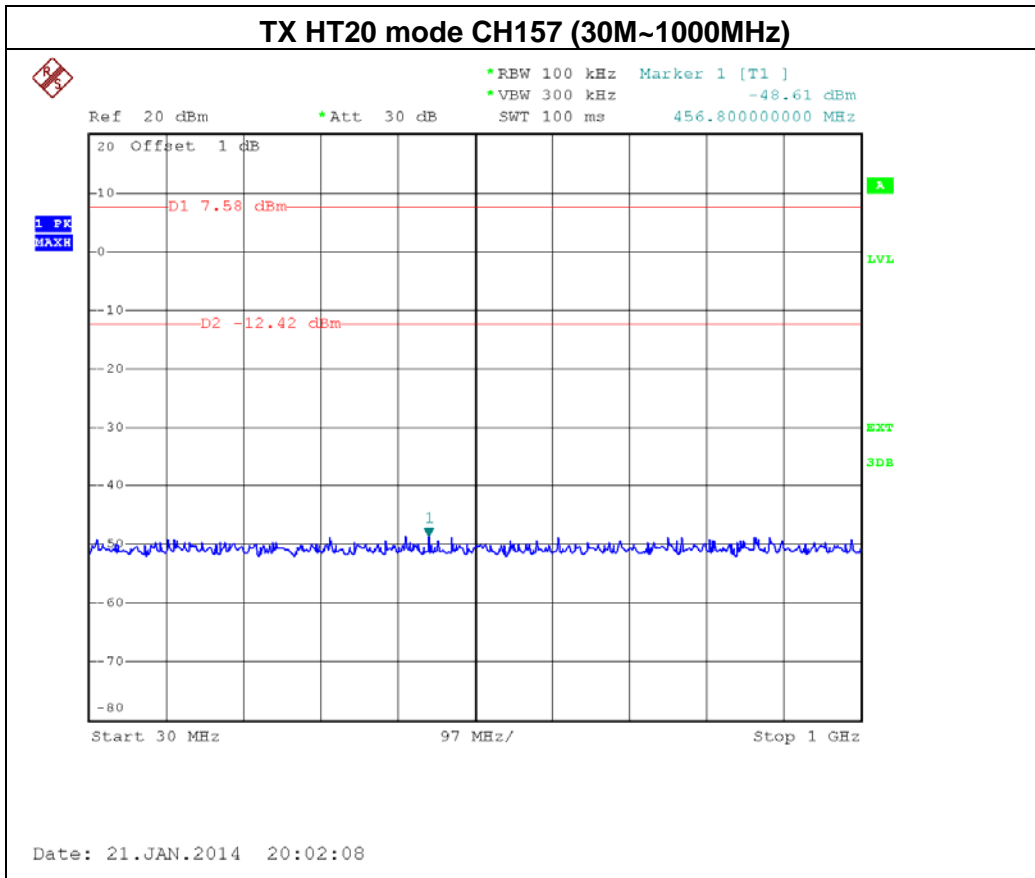

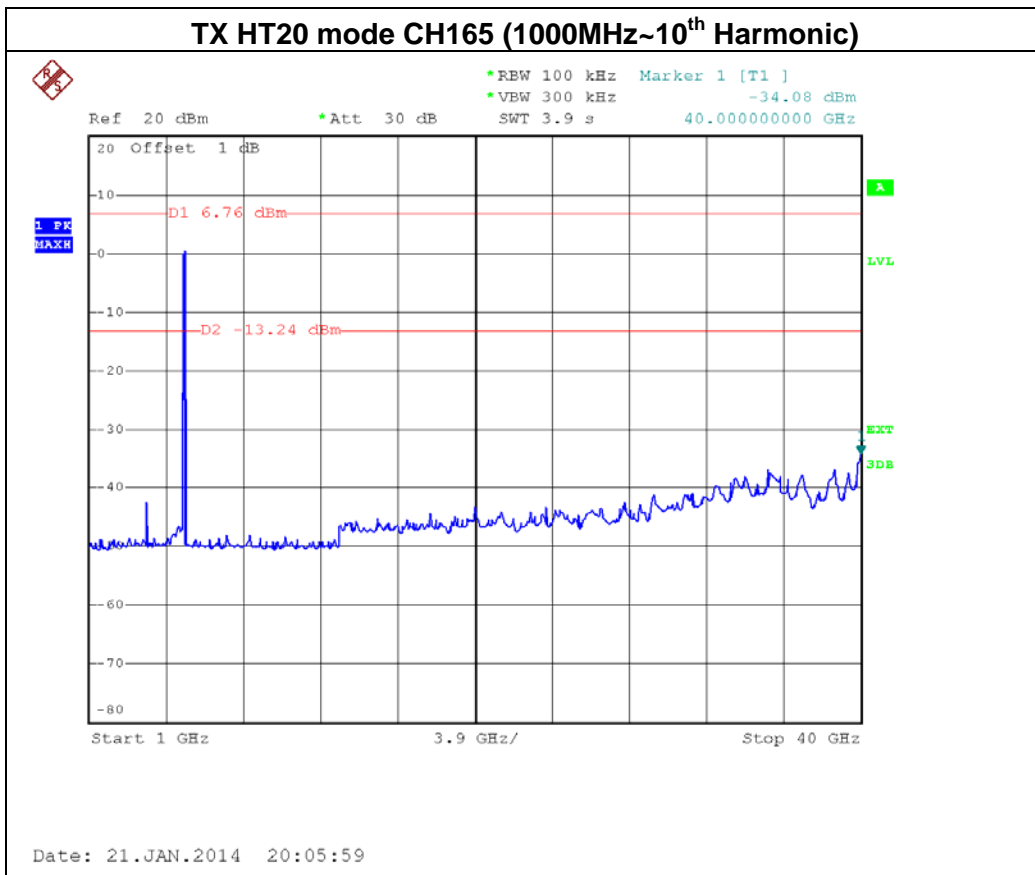
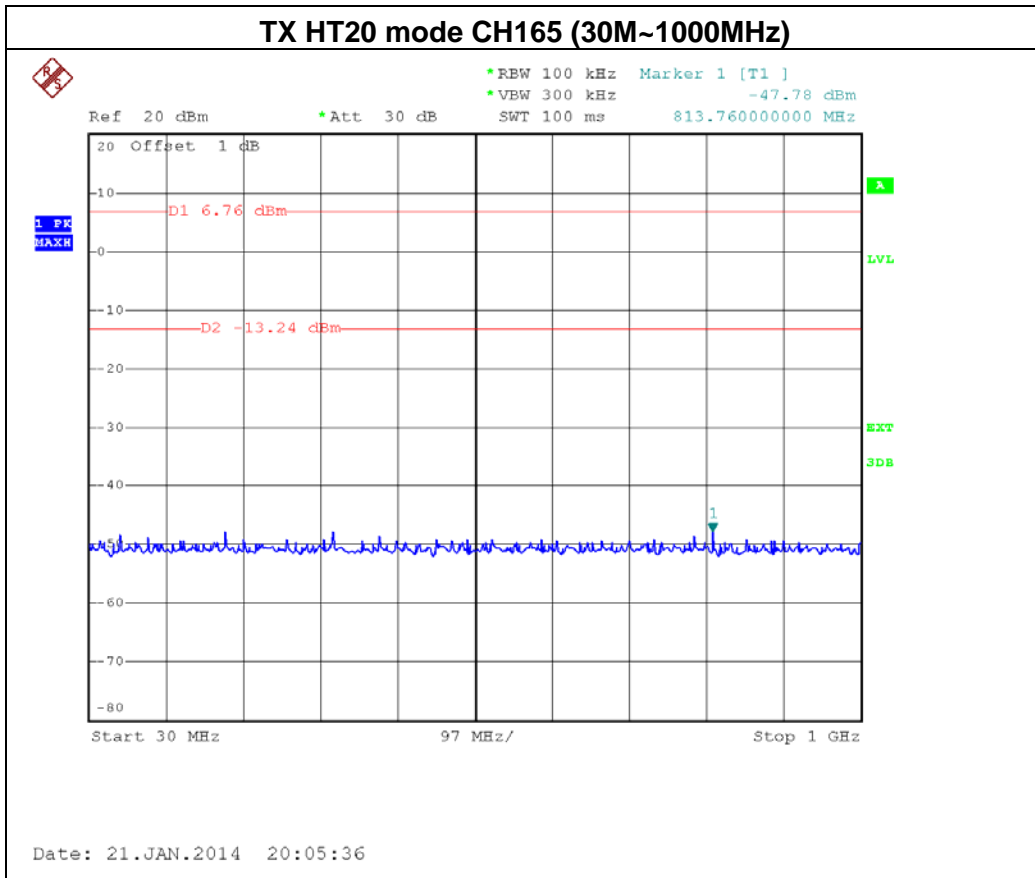



Test Mode :	TX N-20M Mode_ANT 2
-------------	---------------------

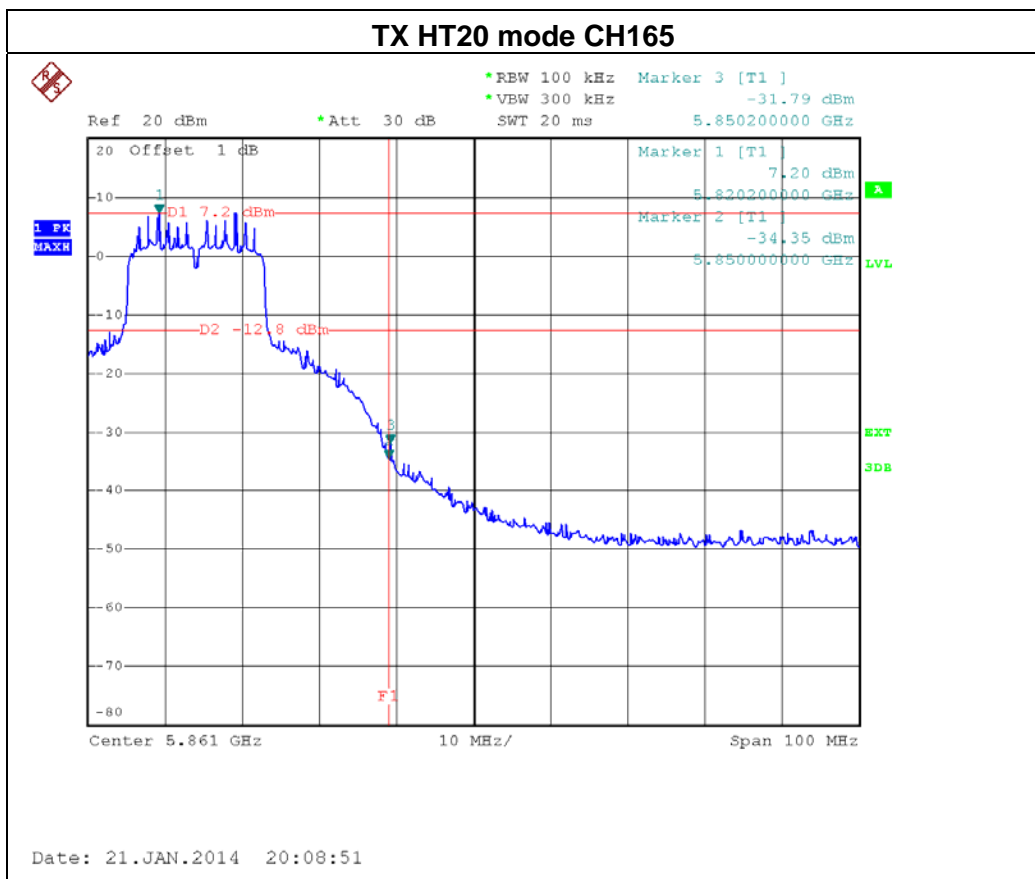
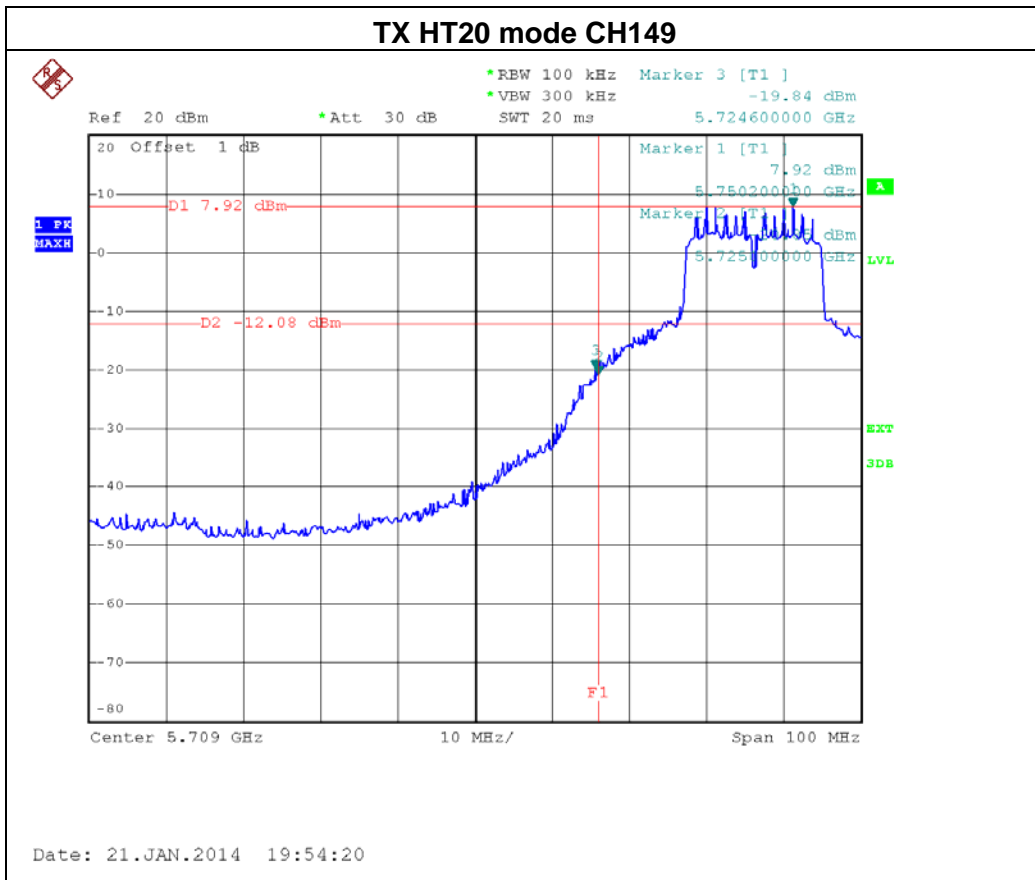

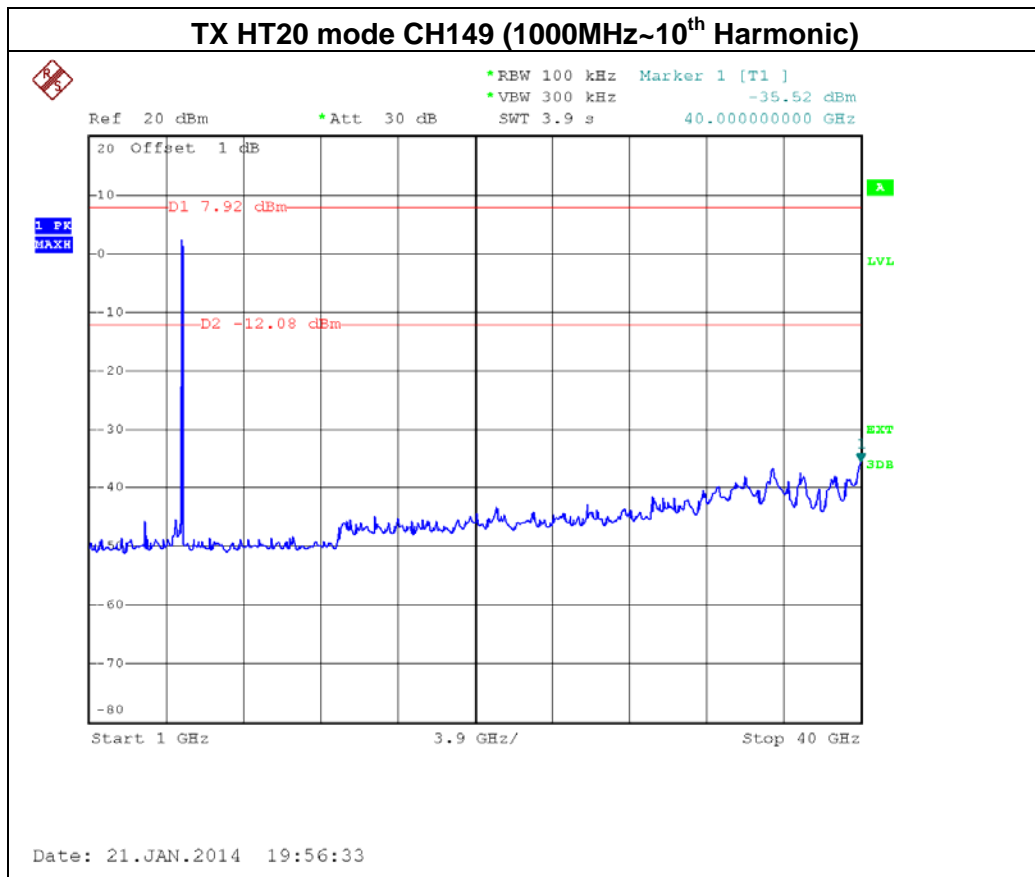
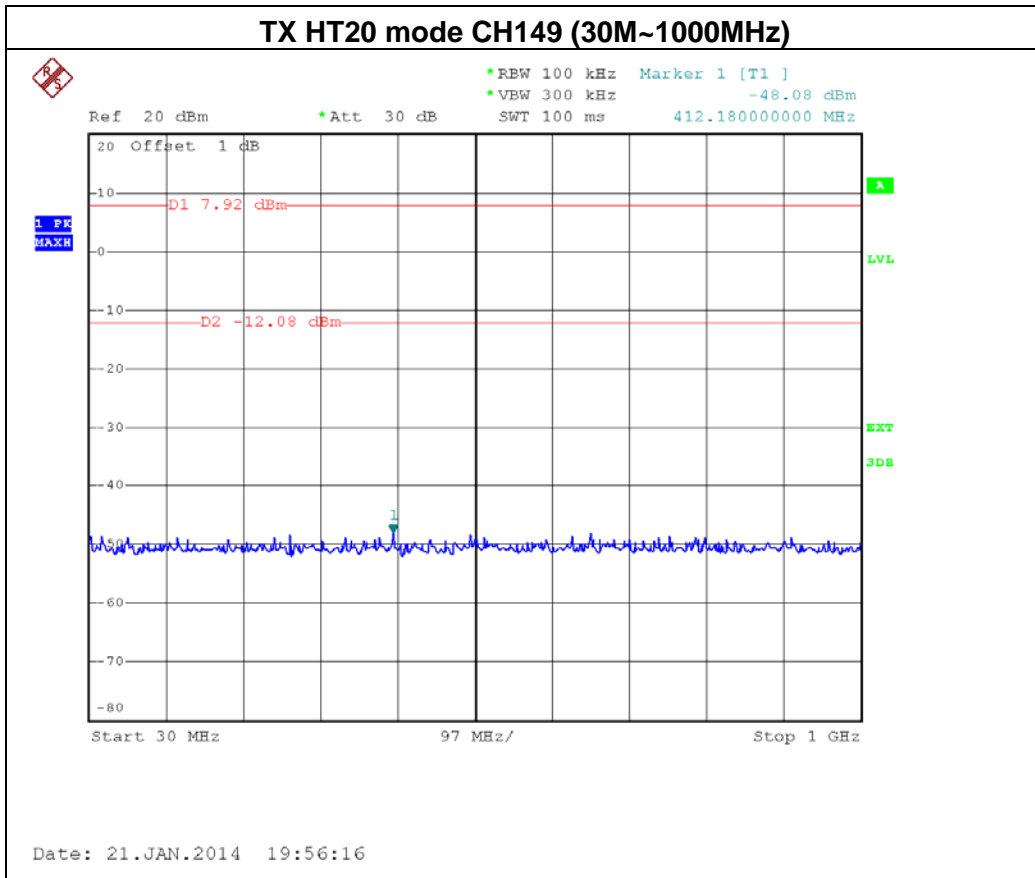

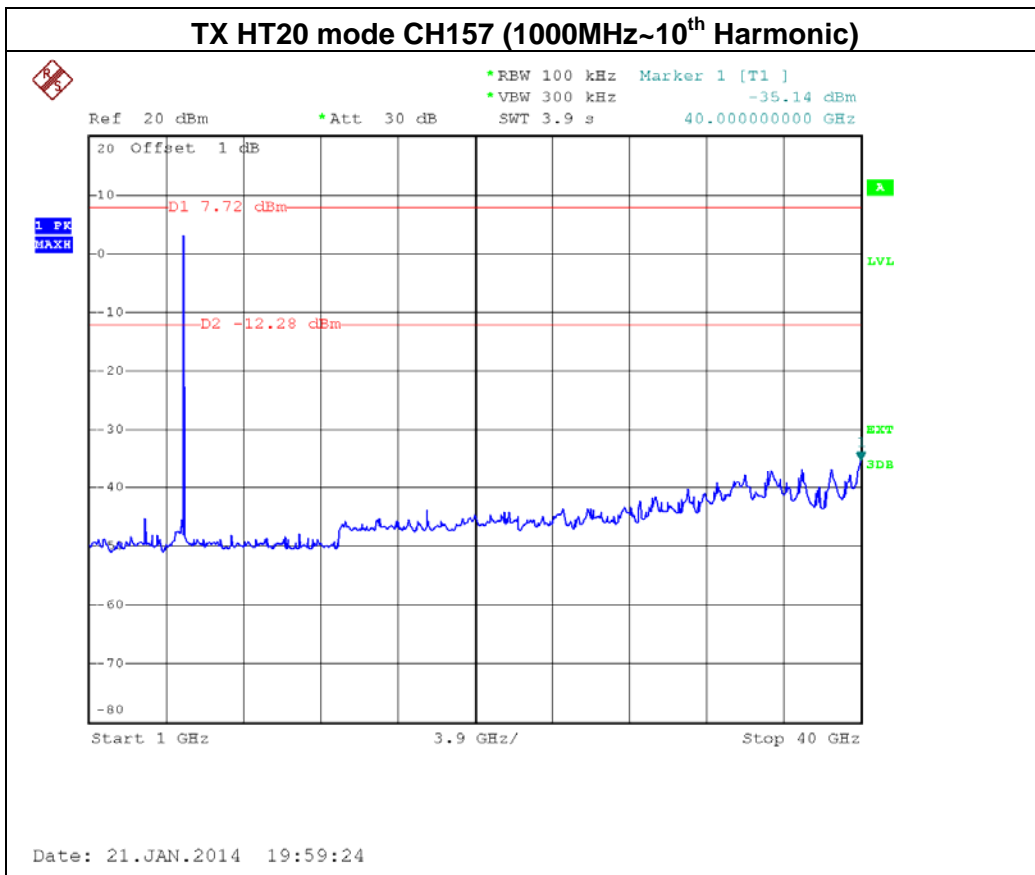
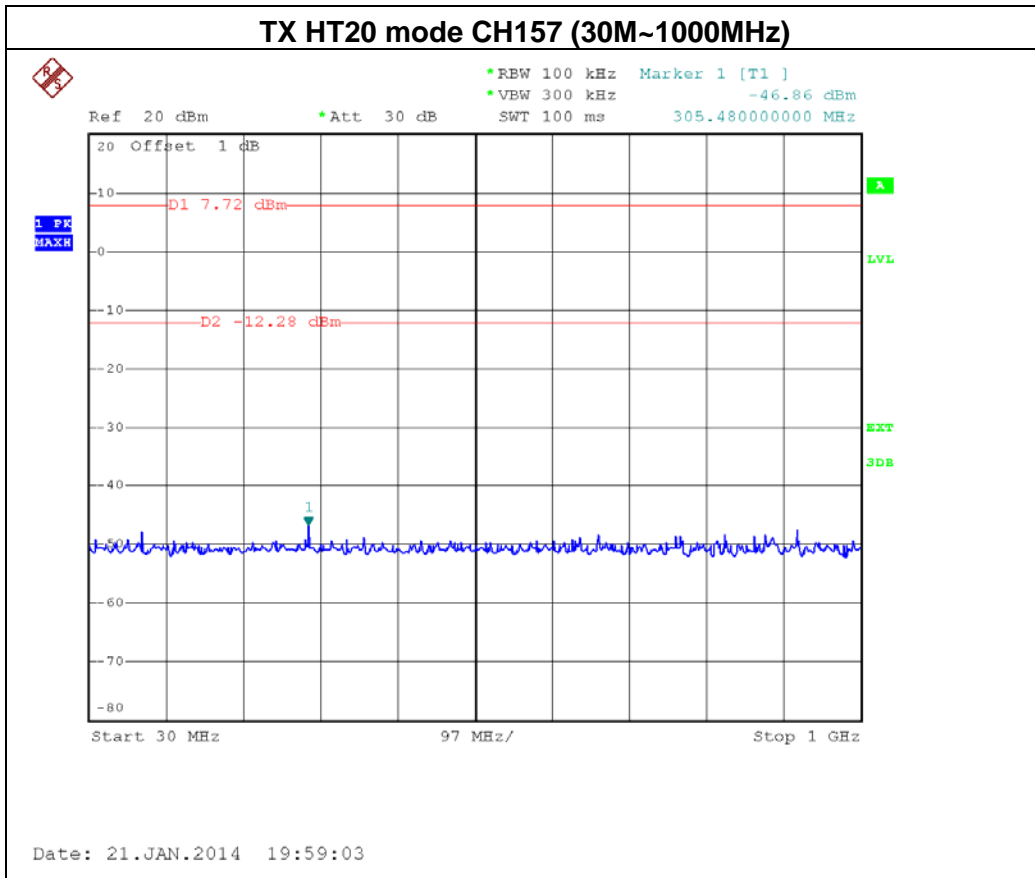





Test Mode :	TX N-40M Mode_ANT 1
-------------	---------------------

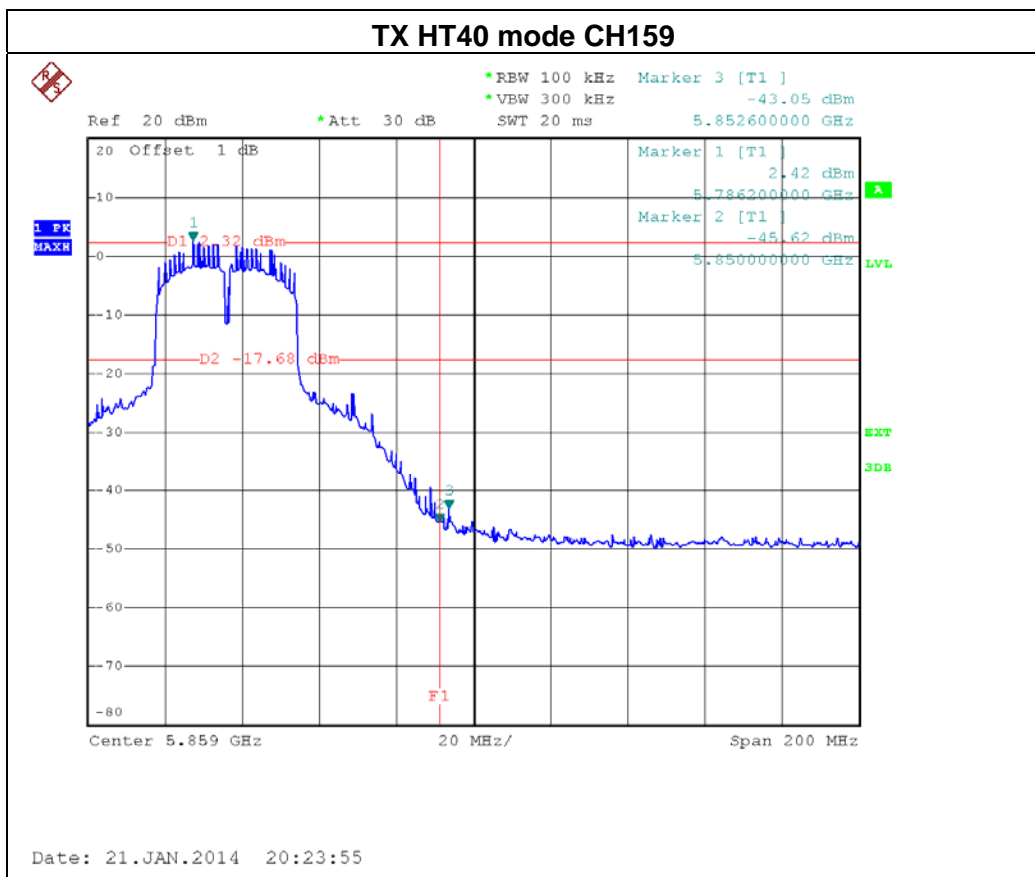
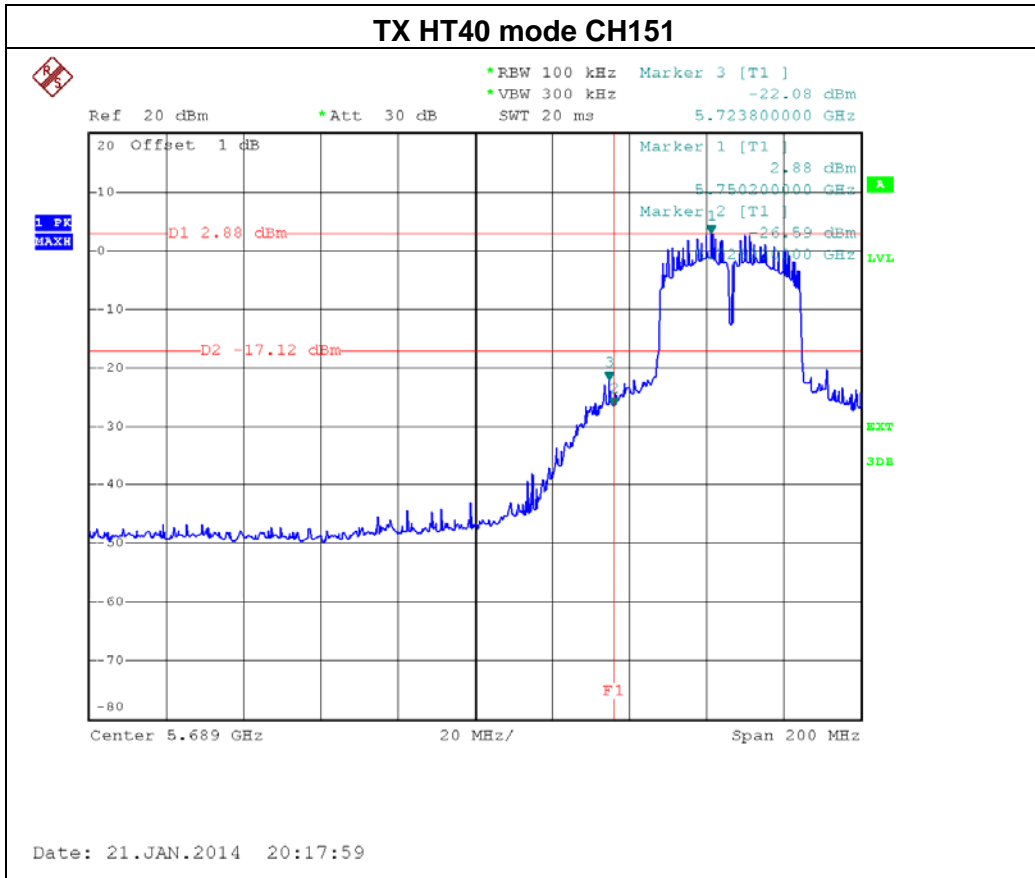

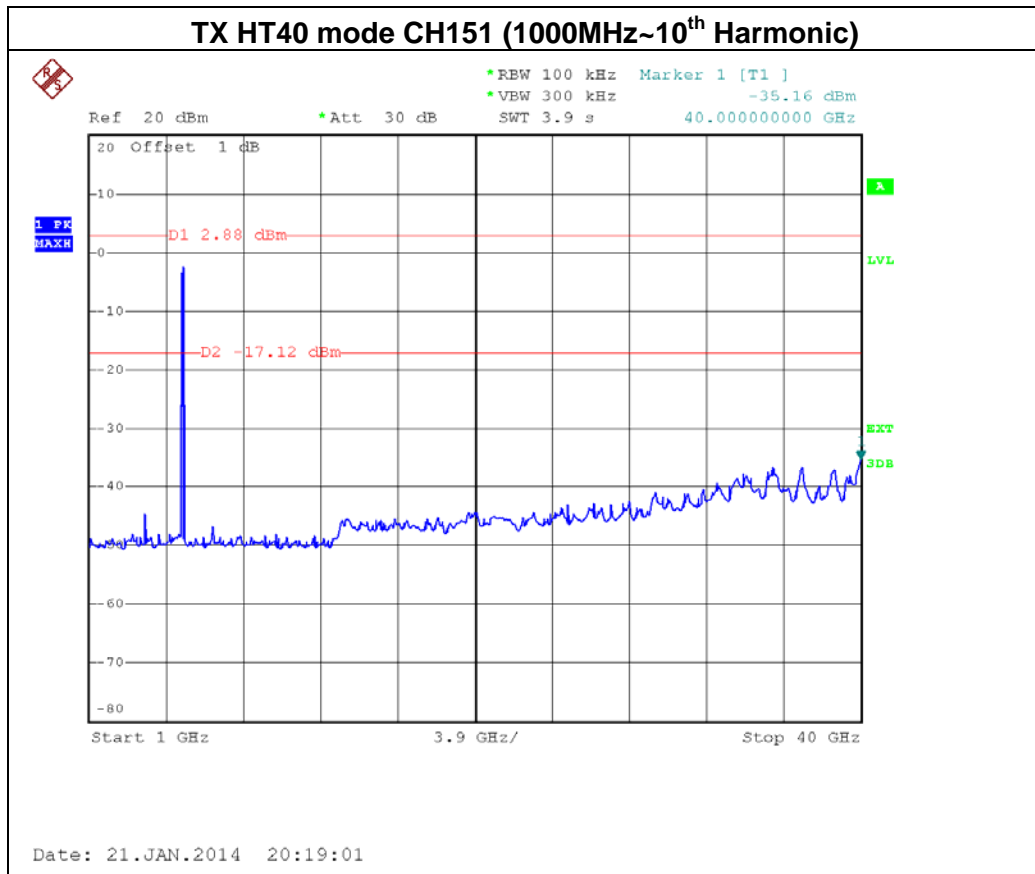
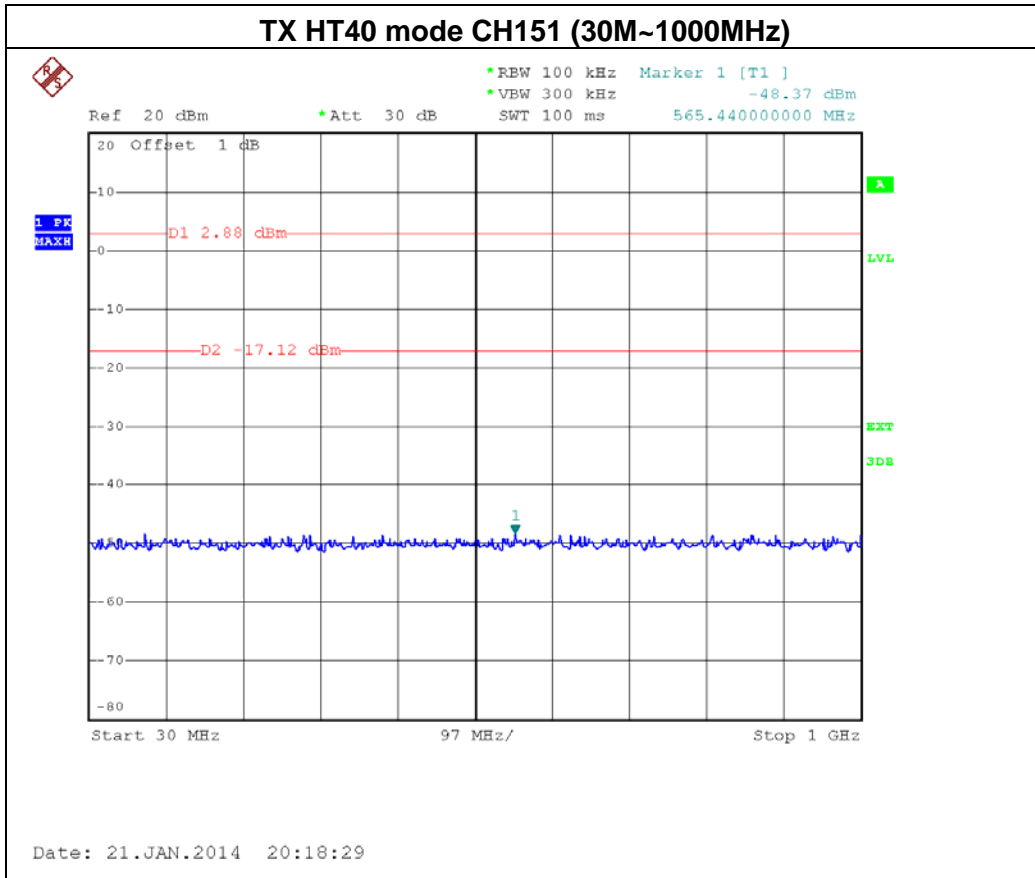

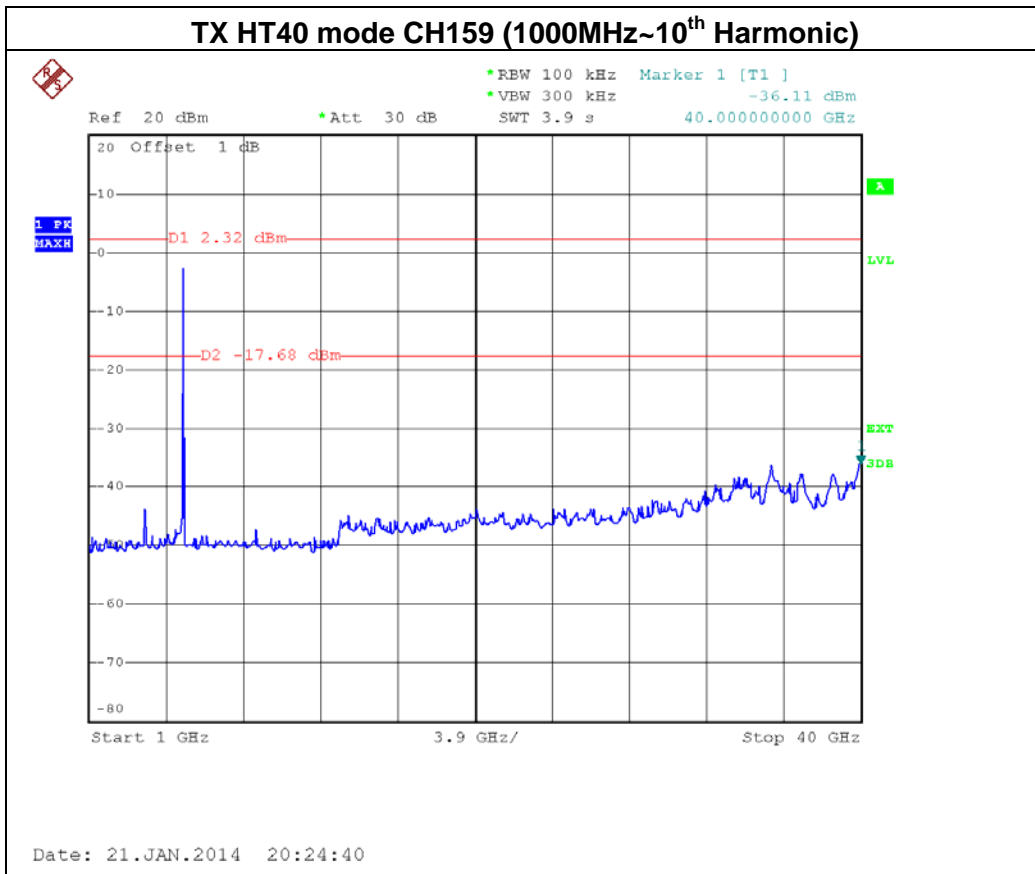
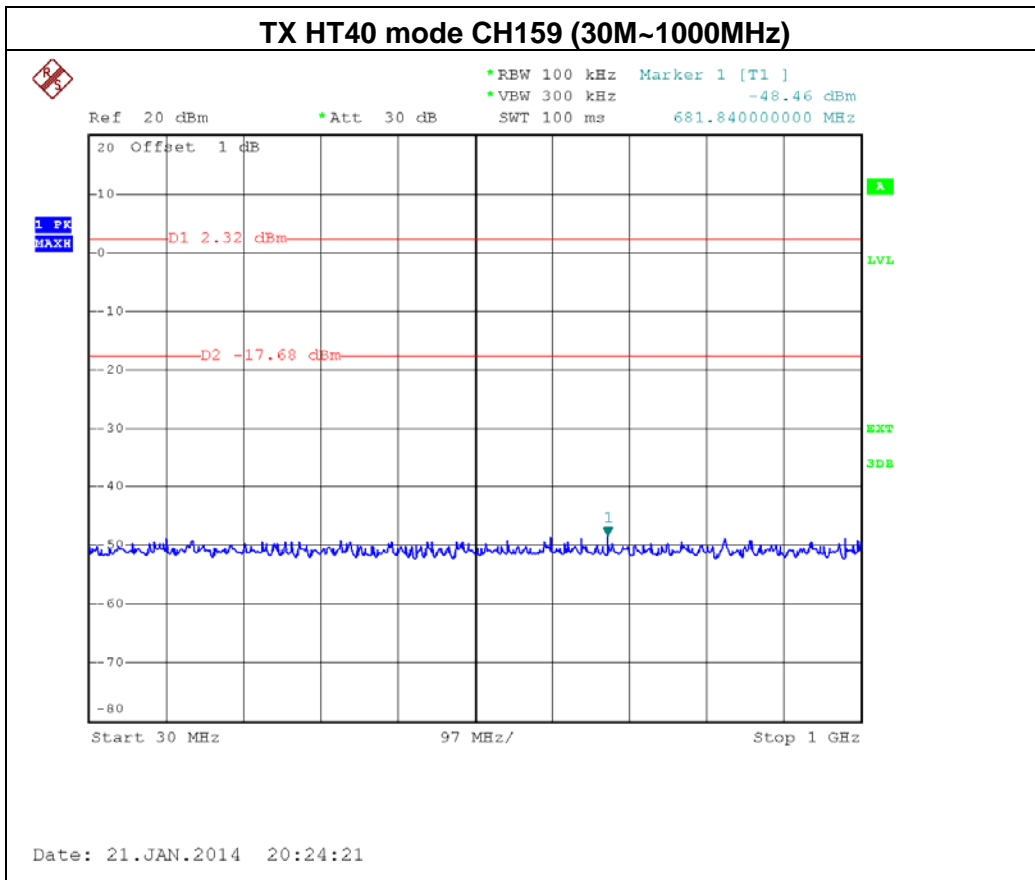



Test Mode :	TX N-40M Mode_ANT 2
-------------	---------------------

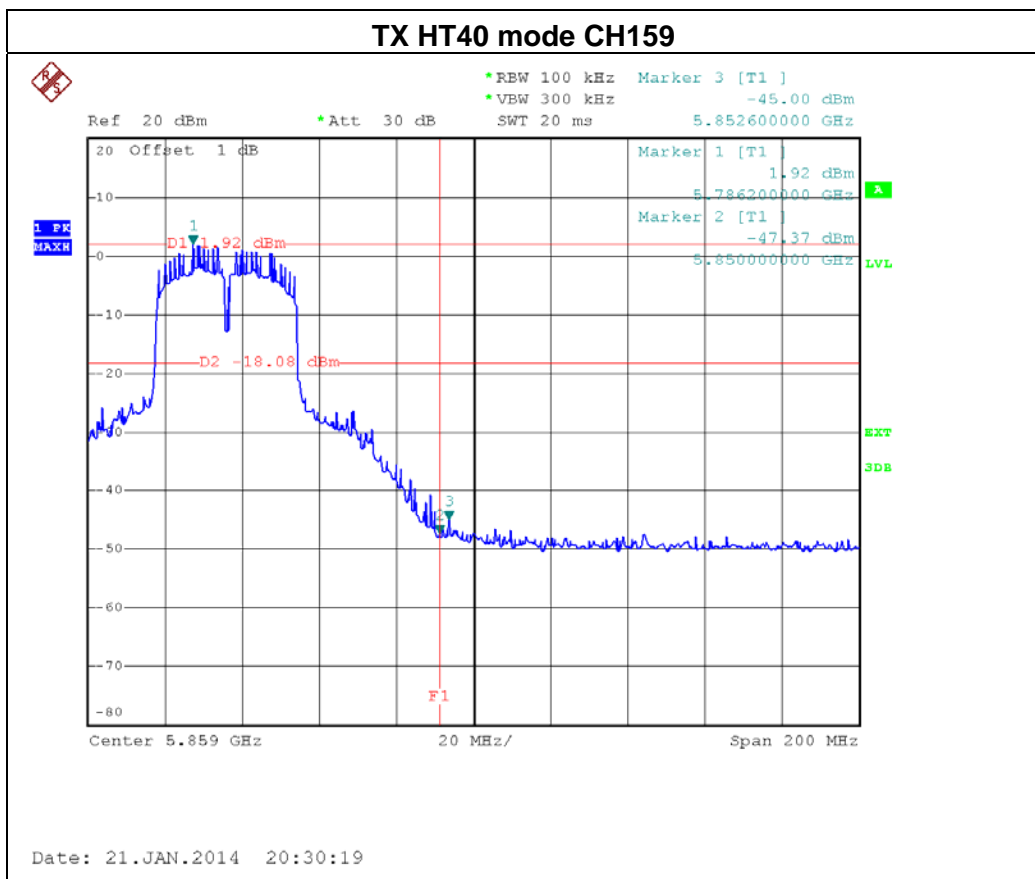
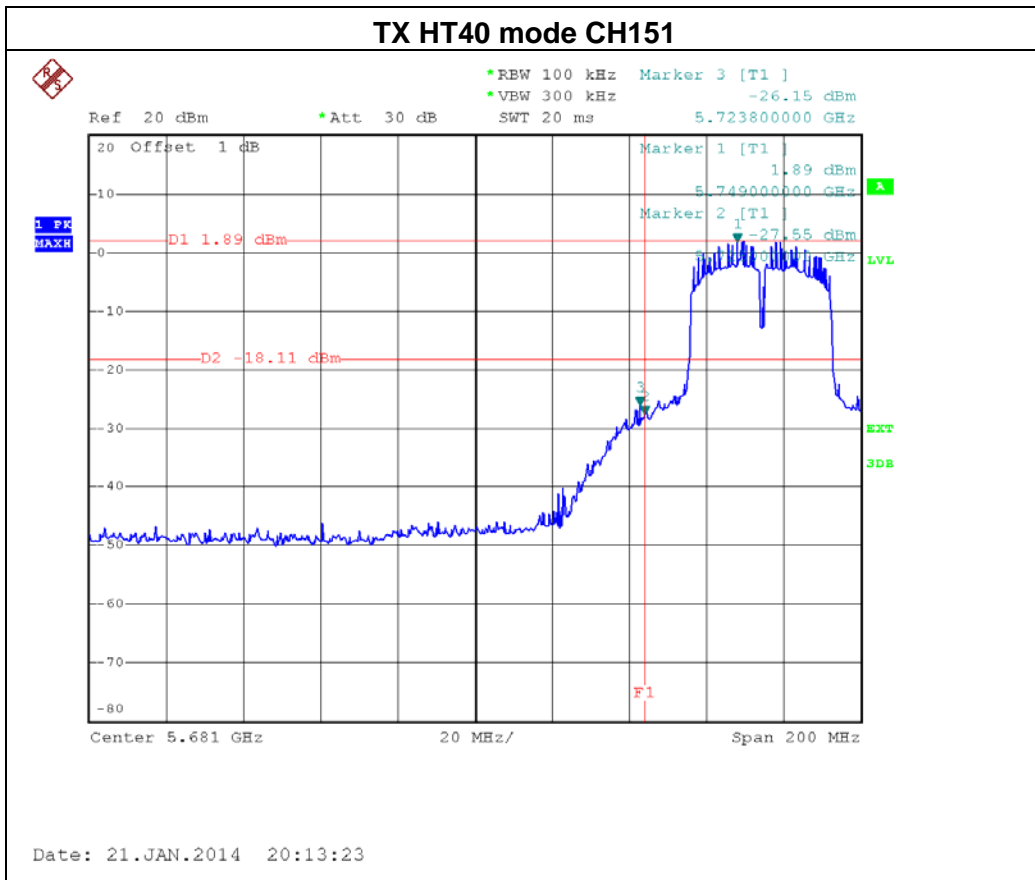

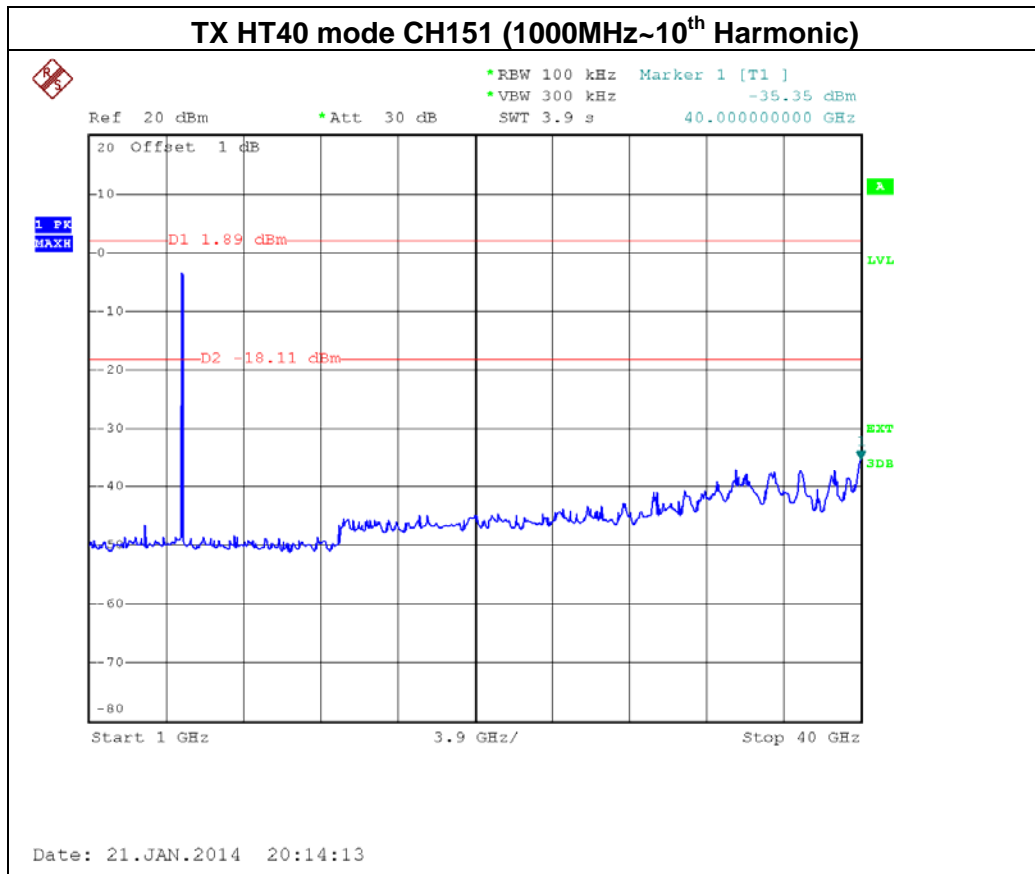
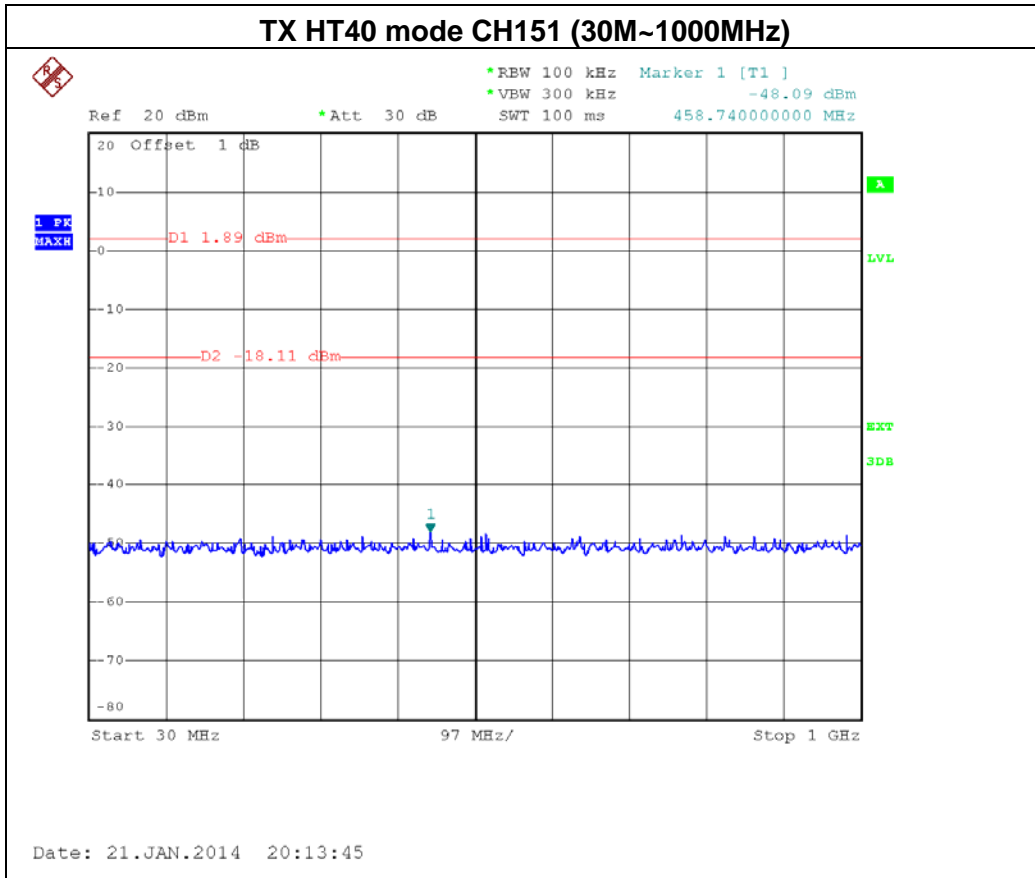

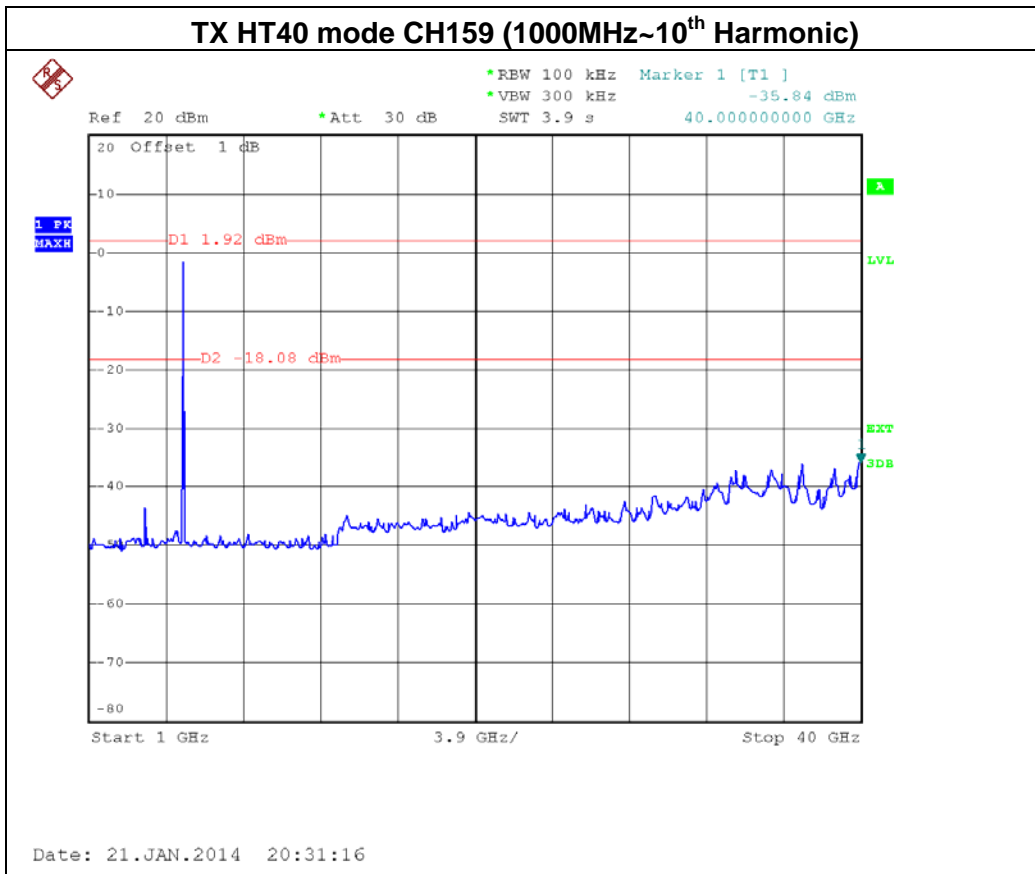
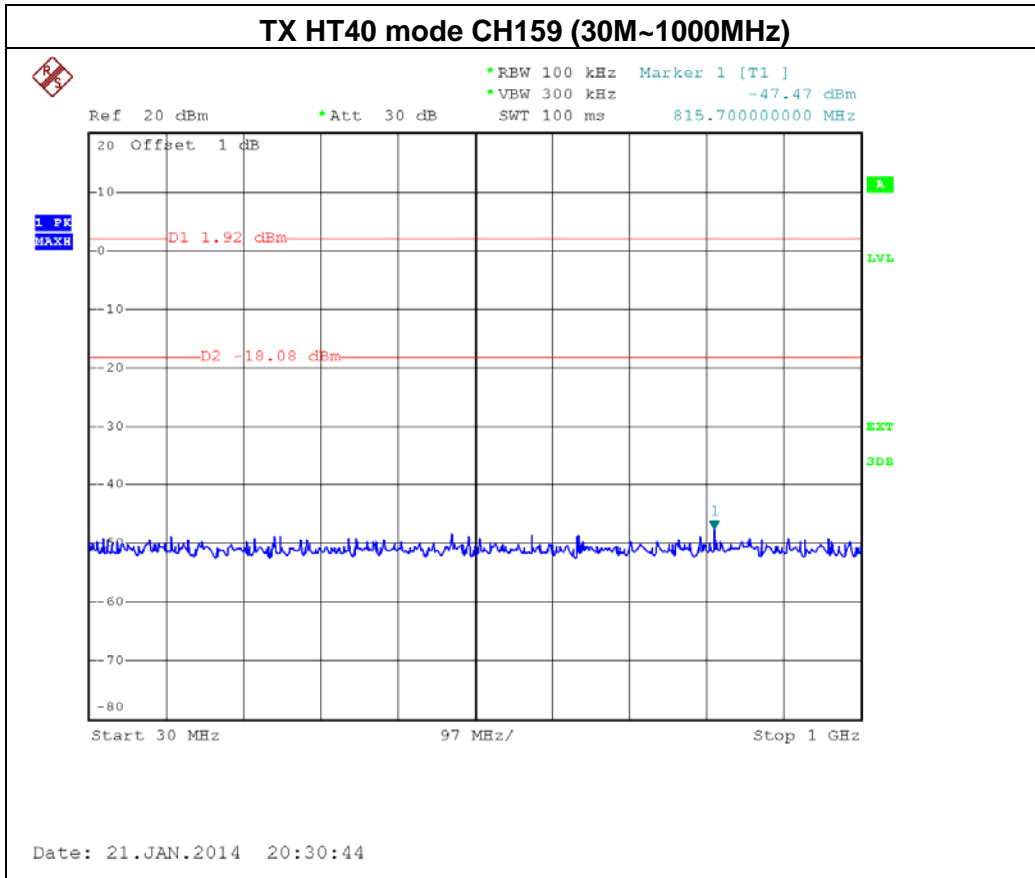



**8. POWER SPECTRAL DENSITY TEST**

**8.1 Applied procedures / limit**

FCC Part15 (15.247) , Subpart C / RSS-210				
Section	Test Item	Limit	Frequency Range (MHz)	Result
15.247(e) RSS-210 Annex 8( A8.2(b))	Power Spectral Density	8 dBm (in any 3KHz)	5745 - 5825	PASS

**8.1.1 TEST PROCEDURE**

- a. The EUT was directly connected to the spectrum analyzer and antenna output port as show in the block diagram below,
- b. Spectrum Setting: RBW=3KHz, VBW=10KHz, Sweep time = Auto.

**8.1.2 DEVIATION FROM STANDARD**

No deviation.

**8.1.3 TEST SETUP**



**8.1.4 EUT OPERATION CONDITIONS**

The EUT tested system was configured as the statements of 4.1.6 Unless otherwise a special operating condition is specified in the follows during the testing.

**8.1.5 EUT TEST CONDITIONS**

Temperature: 25°C  
 Relative Humidity: 55%  
 Test Voltage: AC 120V/60Hz



8.1.6 TEST RESULTS

Test Mode :TX A Mode\_CH149/157/165

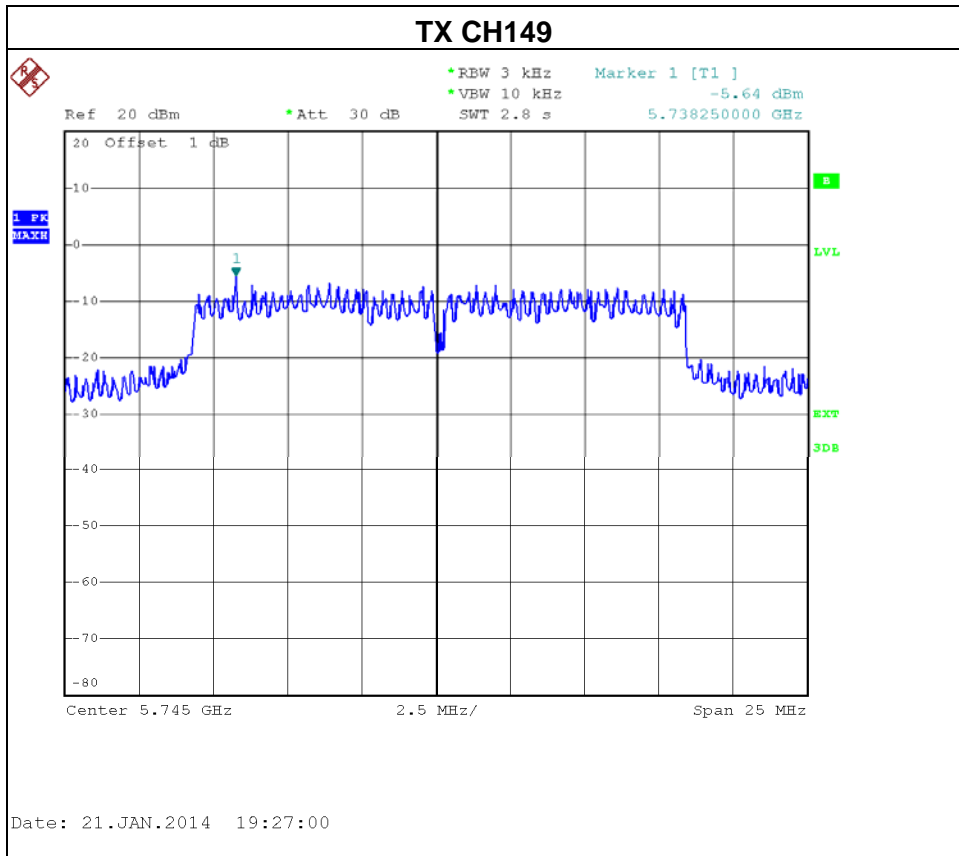

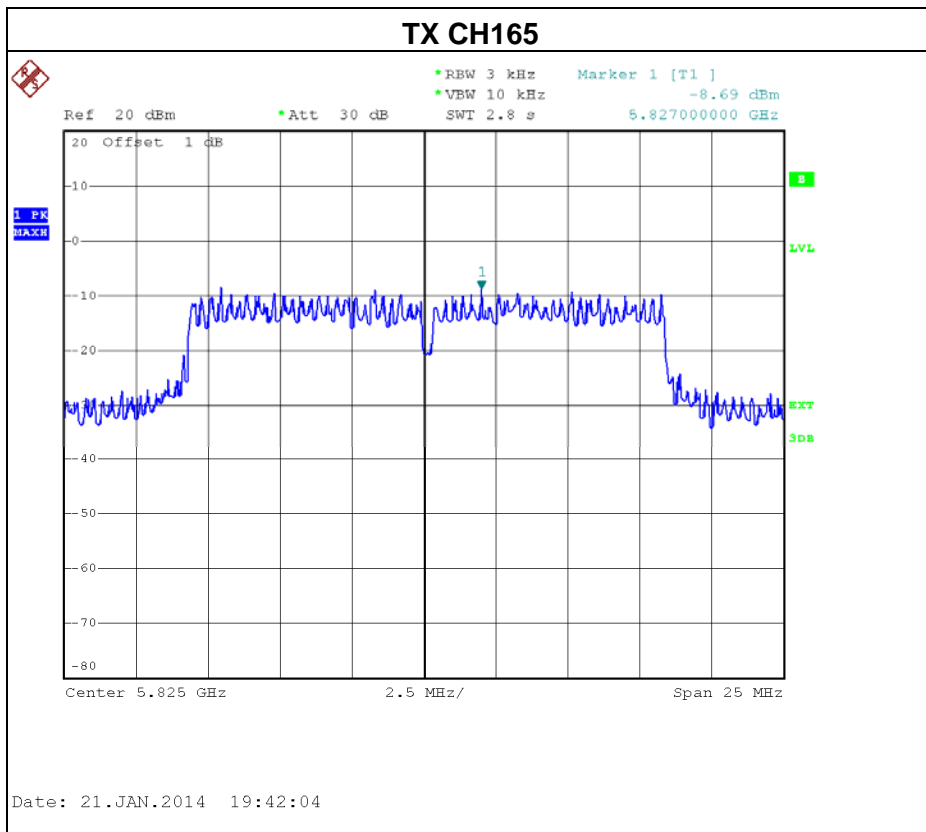
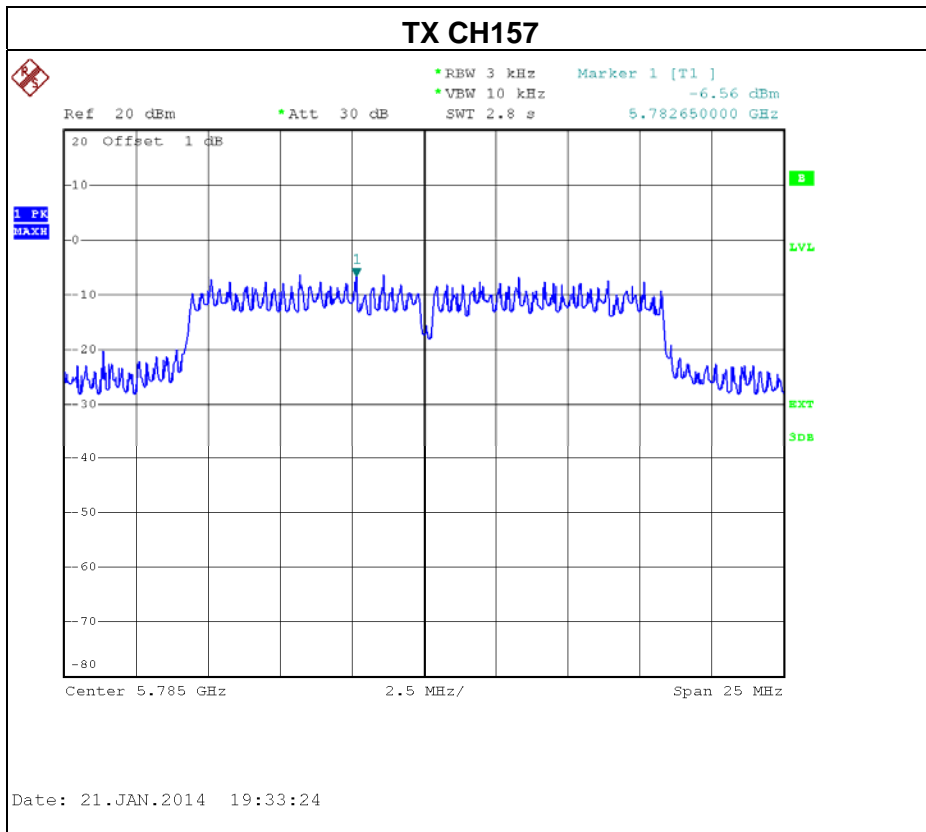



Test Mode : TX N-20M Mode\_CH149/157/165\_ANT 1

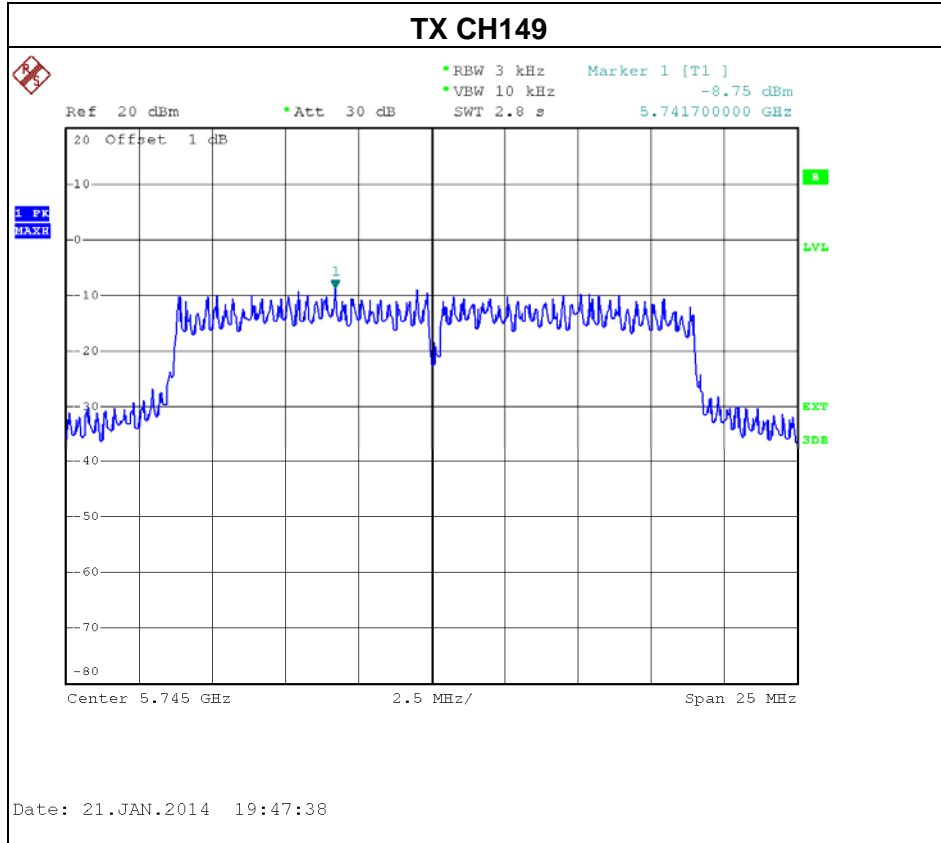

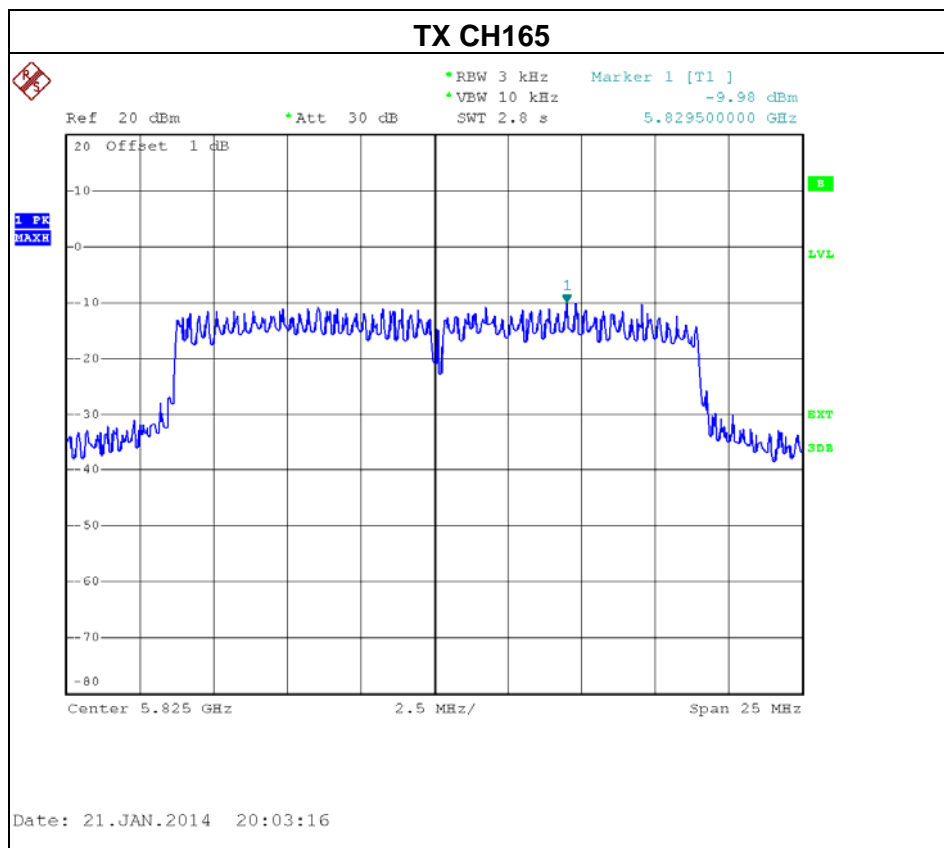
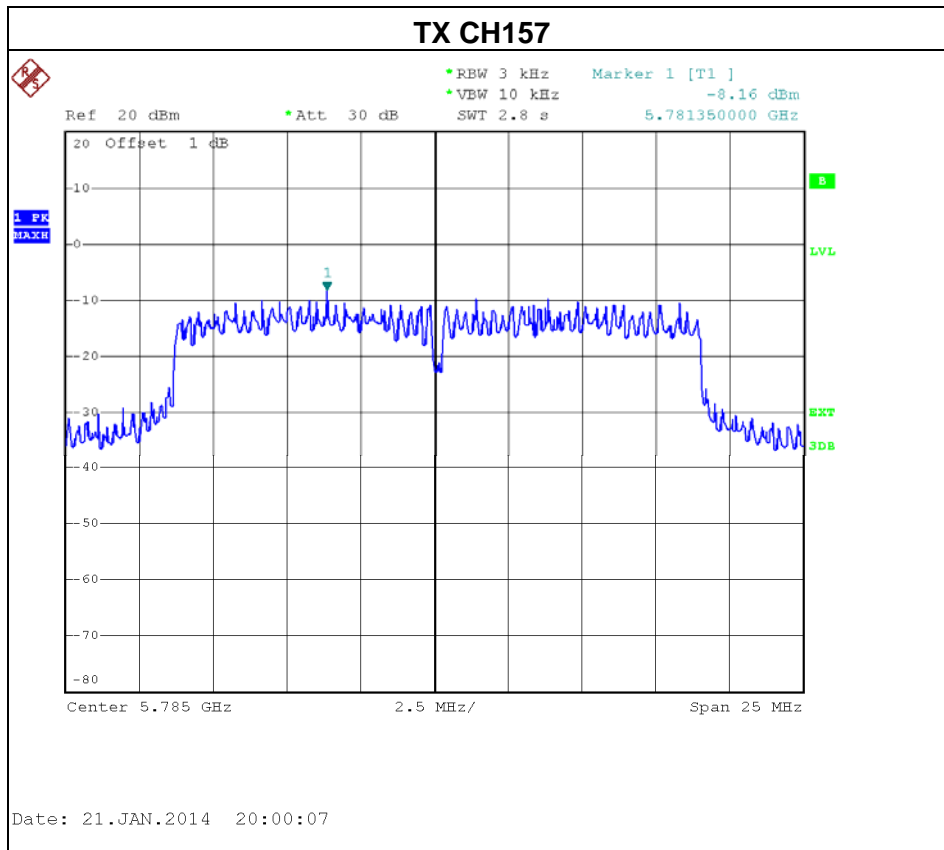



Test Mode : TX N-20M Mode\_CH149/157/165\_ANT 2

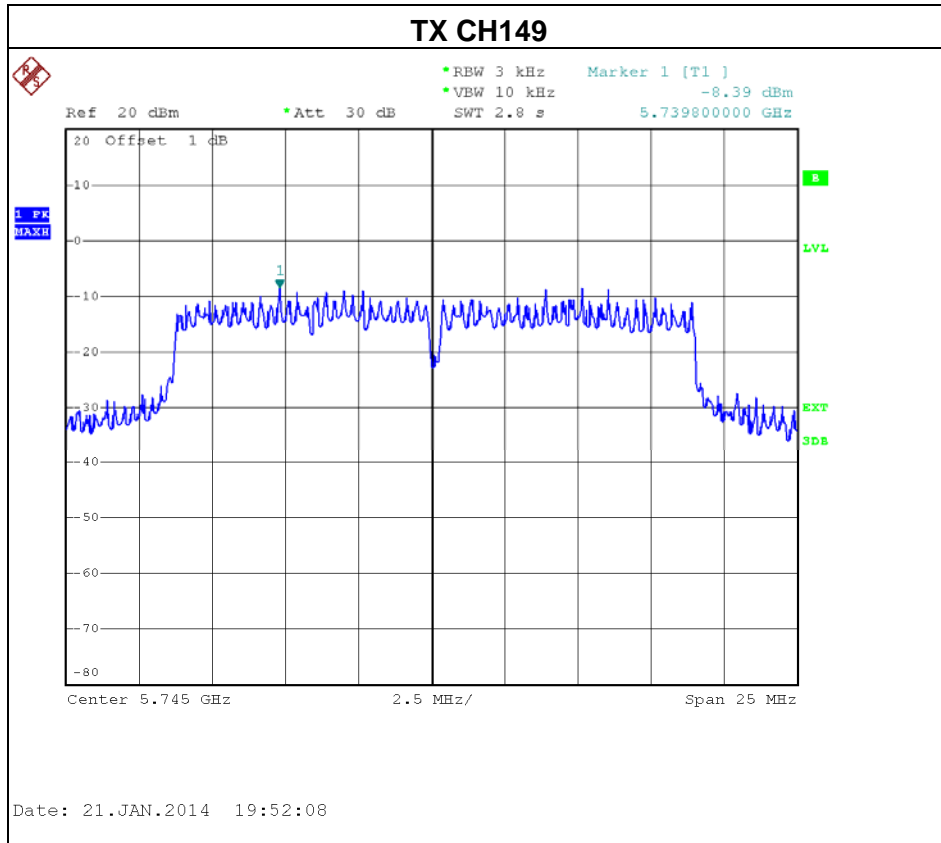

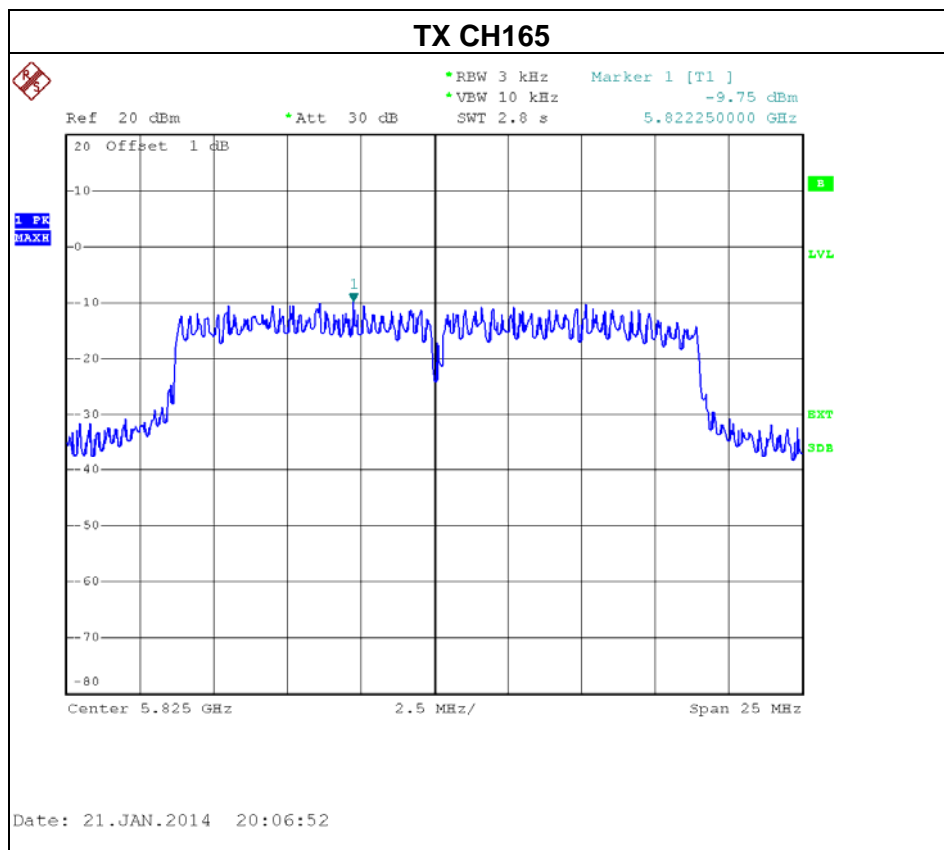
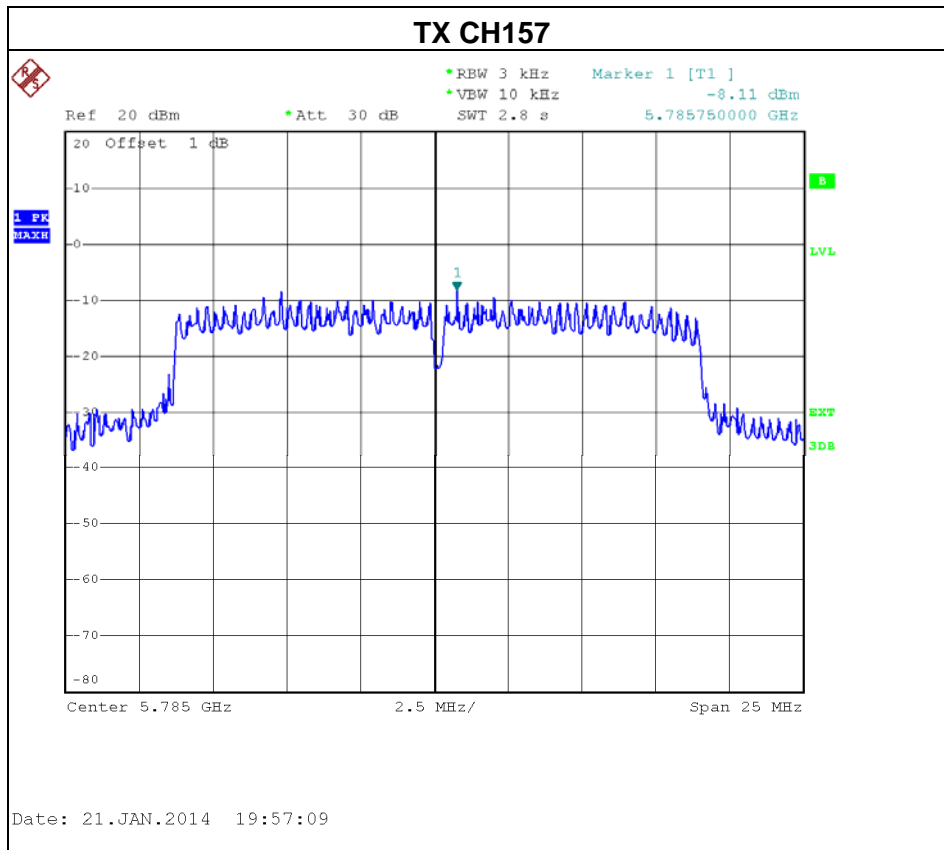



<b>Test Mode : TX N-20M Mode_CH149/157/165_Total</b>			
<b>Test Channel</b>	<b>Frequency (MHz)</b>	<b>Power Density (dBm)</b>	<b>Limit (dBm)</b>
CH149	5745	-5.56	8
CH157	5785	-5.12	8
CH165	5825	-6.85	8



Test Mode : TX N-40M Mode\_CH151/159\_ANT 1

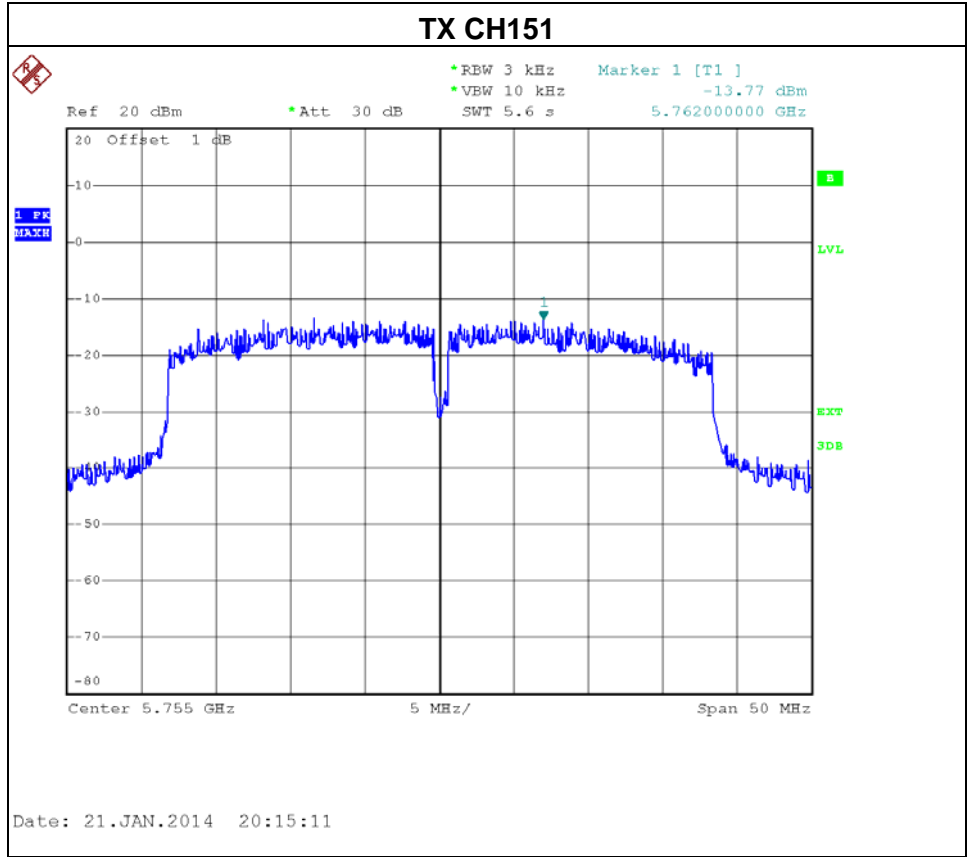

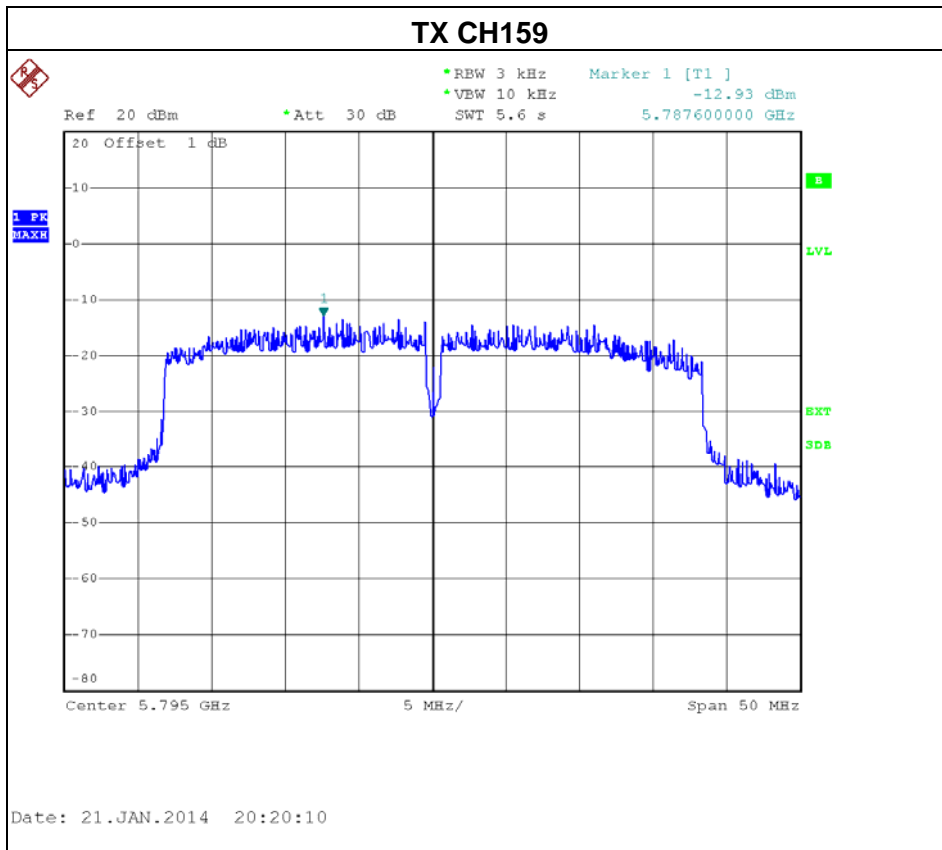



Test Mode : TX N-40M Mode\_CH151/159\_ANT 2

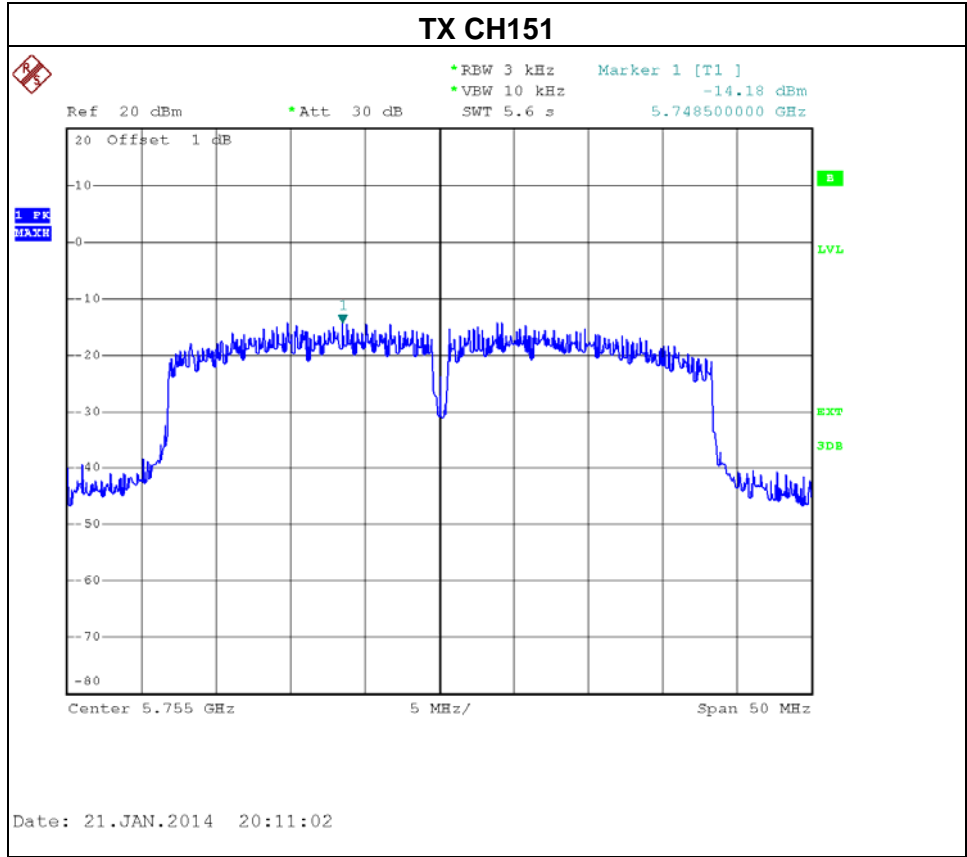

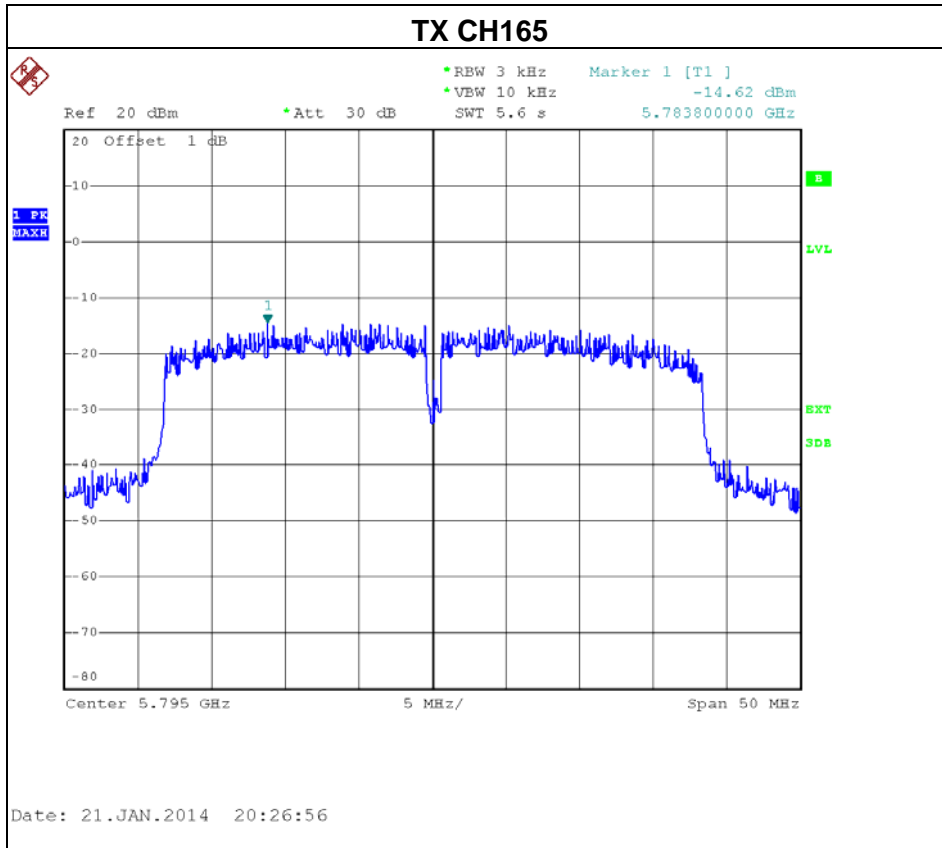



Test Mode : TX N-40M Mode_CH151/159_Total			
Test Channel	Frequency (MHz)	Power Density (dBm)	Limit (dBm)
CH151	5755	-10.96	8
CH159	5795	-10.68	8



**9. MEASUREMENT INSTRUMENTS LIST**

<b>Conducted Emission Measurement</b>					
Item	Kind of Equipment	Manufacturer	Type No.	Serial No.	Calibrated until
1	LISN	EMCO	3816/2	00052765	Apr. 25, 2014
2	LISN	R&S	ENV216	100087	Nov. 09, 2014
3	Test Cable	N/A	C_17	N/A	Mar.15, 2014
4	EMI TEST RECEIVER	R&S	ESCS30	826547/022	Apr. 25, 2014
5	50Ω Terminator	SHX	TF2-3G-A	08122902	Apr. 25, 2014

<b>Radiated Emission Measurement</b>					
Item	Kind of Equipment	Manufacturer	Type No.	Serial No.	Calibrated until
1	Antenna	Schwarbeck	VULB9160	9160-3232	Apr. 25, 2014
2	Amplifier	HP	8447D	2944A09673	Apr. 25, 2014
3	Test Receiver	R&S	ESCI	100382	Apr. 25, 2014
4	Test Cable	N/A	C-01_CB03	N/A	Jul. 02, 2014
5	Antenna	ETS	3115	00075789	Apr. 25, 2014
6	Amplifier	Agilent	8449B	3008A02274	Apr. 25, 2014
7	Spectrum	Agilent	E4408B	US39240143	Nov. 09, 2014
8	Test Cable	HUBER+SUHNER	C-45	N/A	Apr. 30, 2014
9	Controller	CT	SC100	N/A	N/A
10	Horn Antenna	EMCO	3115	9605-4803	Apr. 25, 2014
11	Active Loop Antenna	R&S	HFH2-Z2	830749/020	Apr. 25, 2014
12	Broad-Band Horn Antenna	Schwarzbeck	BBHA 9170	9170319	Oct. 22, 2014

<b>6dB Bandwidth Measurement</b>					
Item	Kind of Equipment	Manufacturer	Type No.	Serial No.	Calibrated until
1	Spectrum Analyzer	R&S	FSP 40	100185	Nov. 09, 2014

<b>Peak Output Power Measurement</b>					
Item	Kind of Equipment	Manufacturer	Type No.	Serial No.	Calibrated until
1	P-series Power meter	Agilent	N1911A	MY45100473	Apr. 25, 2014
2	Wireband Power sensor	Agilent	N1921A	MY51100041	Apr. 25, 2014



<b>Antenna Conducted Spurious Emission Measurement</b>					
Item	Kind of Equipment	Manufacturer	Type No.	Serial No.	Calibrated until
1	Spectrum Analyzer	R&S	FSP 40	100185	Nov. 09, 2014

<b>Power Spectral Density Measurement</b>					
Item	Kind of Equipment	Manufacturer	Type No.	Serial No.	Calibrated until
1	Spectrum Analyzer	R&S	FSP 40	100185	Nov. 09, 2014

Remark: "N/A" denotes no model name, serial no. or calibration specified.  
All calibration period of equipment list is one year.