



A D T

FCC TEST REPORT (PART 24)

REPORT NO.: RF121115C09-6

MODEL NO.: JT-B1APAAVAM

FCC ID: ACJ-JT-B1APAAZAMV

RECEIVED: Oct. 17, 2012

TESTED: Dec. 20, 2012 ~ Jan. 03, 2013

ISSUED: Jan. 21, 2013

APPLICANT: Panasonic Corporation of North America

ADDRESS: One Panasonic way, 4B-8, Secaucus, New Jersey,
United States 07094

ISSUED BY: Bureau Veritas Consumer Products Services
(H.K.) Ltd., Taoyuan Branch

LAB ADDRESS: No. 47, 14th Ling, Chia Pau Vil., Lin Kou Dist., New
Taipei City, Taiwan, R.O.C.

TEST LOCATION: No. 19, Hwa Ya 2nd Rd, Wen Hwa Tsuen, Kwei
Shan Hsiang, Taoyuan Hsien 333, Taiwan, R.O.C.

This report should not be used by the client to claim product certification, approval, or endorsement by TAF or any government agencies.



This report is for your exclusive use. Any copying or replication of this report to or for any other person or entity, or use of our name or trademark, is permitted only with our prior written permission. This report sets forth our findings solely with respect to the test samples identified herein. The results set forth in this report are not indicative or representative of the quality or characteristics of the lot from which a test sample was taken or any similar or identical product unless specifically and expressly noted. Our report includes all of the tests requested by you and the results thereof based upon the information that you provided to us. You have 60 days from date of issuance of this report to notify us of any material error or omission caused by our negligence, provided, however, that such notice shall be in writing and shall specifically address the issue you wish to raise. A failure to raise such issue within the prescribed time shall constitute your unqualified acceptance of the completeness of this report, the tests conducted and the correctness of the report contents. Unless specific mention, the uncertainty of measurement has been explicitly taken into account to declare the compliance or non-compliance to the specification.



TABLE OF CONTENTS

RELEASE CONTROL RECORD.....	3
1 CERTIFICATION	4
2 SUMMARY OF TEST RESULTS.....	5
2.1 MEASUREMENT UNCERTAINTY	5
2.2 TEST SITE AND INSTRUMENTS.....	6
3 GENERAL INFORMATION.....	7
3.1 GENERAL DESCRIPTION OF EUT.....	7
3.2 CONFIGURATION OF SYSTEM UNDER TEST.....	8
3.3 DESCRIPTION OF SUPPORT UNITS.....	8
3.4 TEST ITEM AND TEST CONFIGURATION	10
3.5 EUT OPERATING CONDITIONS.....	11
3.6 GENERAL DESCRIPTION OF APPLIED STANDARDS.....	11
4 TEST TYPES AND RESULTS.....	12
4.1 OUTPUT POWER MEASUREMENT	12
4.1.1 LIMITS OF OUTPUT POWER MEASUREMENT	12
4.1.2 TEST PROCEDURES	12
4.1.3 TEST SETUP.....	13
4.1.4 TEST RESULTS	14
4.2 FREQUENCY STABILITY MEASUREMENT	17
4.2.1 LIMITS OF FREQUENCY STABILITY MEASUREMENT	17
4.2.2 TEST PROCEDURE	17
4.2.3 TEST SETUP.....	17
4.2.4 TEST RESULTS	18
4.3 OCCUPIED BANDWIDTH MEASUREMENT.....	19
4.3.1 TEST PROCEDURES	19
4.3.2 TEST SETUP.....	19
4.3.3 TEST RESULTS	20
4.4 BAND EDGE MEASUREMENT	21
4.4.1 LIMITS OF BAND EDGE MEASUREMENT.....	21
4.4.2 TEST SETUP.....	21
4.4.3 TEST PROCEDURES	21
4.4.4 TEST RESULTS	22
4.5 CONDUCTED SPURIOUS EMISSIONS.....	23
4.5.1 LIMITS OF CONDUCTED SPURIOUS EMISSIONS MEASUREMENT	23
4.5.2 TEST PROCEDURE	23
4.5.3 TEST SETUP.....	23
4.5.4 TEST RESULTS	24
4.6 RADIATED EMISSION MEASUREMENT	25
4.6.1 LIMITS OF RADIATED EMISSION MEASUREMENT	25
4.6.2 TEST PROCEDURES	25
4.6.3 DEVIATION FROM TEST STANDARD	25
4.6.4 TEST SETUP.....	26
4.6.5 TEST RESULTS	27
5 PHOTOGRAPHS OF THE TEST CONFIGURATION	31
6 INFORMATION ON THE TESTING LABORATORIES.....	32
7 APPENDIX A – MODIFICATIONS RECORDERS FOR ENGINEERING CHANGES TO THE EUT BY THE LAB	33



A D T

RELEASE CONTROL RECORD

ISSUE NO.	REASON FOR CHANGE	DATE ISSUED
RF121115C09-6	Original release.	Jan. 21, 2013

1 CERTIFICATION

PRODUCT: Tablet Computer

MODEL: JT-B1APAAVAM

BRAND: Panasonic

APPLICANT: Panasonic Corporation of North America

TESTED: Dec. 20, 2012 ~ Jan. 03, 2013

TEST SAMPLE: Production Unit

STANDARDS: FCC Part 24, Subpart E

The above equipment (model: JT-B1APAAVAM) has been tested by **Bureau Veritas Consumer Products Services (H.K.) Ltd., Taoyuan Branch**, and found compliance with the requirement of the above standards. The test record, data evaluation & Equipment Under Test (EUT) configurations represented herein are true and accurate accounts of the measurements of the sample's EMC characteristics under the conditions specified in this report.

PREPARED BY : Sunt Lee , DATE : Jan. 21 2013
Sunt Lee / Specialist

APPROVED BY : Anderson Chiu , DATE : Jan. 21 2013
Anderson Chiu / Senior Engineer



2 SUMMARY OF TEST RESULTS

The EUT has been tested according to the following specifications:

APPLIED STANDARD: FCC Part 24 & Part 2			
STANDARD SECTION	TEST TYPE	RESULT	REMARK
2.1046 24.232	Equivalent isotropically radiated power	PASS	Meet the requirement of limit.
2.1055 24.235	Frequency Stability	PASS	Meet the requirement of limit.
2.1049 24.238(b)	Occupied Bandwidth	PASS	Meet the requirement of limit.
24.238(b)	Band Edge Measurements	PASS	Meet the requirement of limit.
2.1051 24.238	Conducted Spurious Emissions	PASS	Meet the requirement of limit.
2.1053 24.238	Radiated Spurious Emissions	PASS	Meet the requirement of limit. Minimum passing margin is -40.25dB at 3760.00MHz.

2.1 MEASUREMENT UNCERTAINTY

Where relevant, the following measurement uncertainty levels have been estimated for tests performed on the EUT as specified in CISPR 16-4-2:

MEASUREMENT	FREQUENCY	UNCERTAINTY
Conducted emissions	150kHz~30MHz	2.44 dB
Radiated emissions	30MHz ~ 200MHz	2.93 dB
	200MHz ~1000MHz	2.95 dB
	1GHz ~ 18GHz	2.26 dB
	18GHz ~ 40GHz	1.94 dB

This uncertainty represents an expanded uncertainty expressed at approximately the 95% confidence level using a coverage factor of k=2.



2.2 TEST SITE AND INSTRUMENTS

DESCRIPTION & MANUFACTURER	MODEL NO.	SERIAL NO.	DATE OF CALIBRATION	DUE DATE OF CALIBRATION
Test Receiver ROHDE & SCHWARZ	ESIB7	100212	Aug. 06, 2012	Aug. 05, 2013
Spectrum Analyzer ROHDE & SCHWARZ	FSP40	100039	Feb. 03, 2012	Feb. 02, 2013
BILOG Antenna SCHWARZBECK	VULB9168	9168-160	Apr. 06, 2012	Apr. 05, 2013
HORN Antenna SCHWARZBECK	9120D	209	Sep. 03, 2012	Sep. 02, 2013
HORN Antenna SCHWARZBECK	BBHA 9170	148	Jul. 11, 2012	Jul. 10, 2013
Loop Antenna	HFH2-Z2	100070	Jan. 31, 2012	Jan. 30, 2014
Preamplifier Agilent	8447D	2944A10633	Oct. 25, 2012	Oct. 24, 2013
Preamplifier Agilent	8449B	3008A01964	Oct. 25, 2012	Oct. 24, 2013
RF signal cable HUBER+SUHNNER	SUCOFLEX 104	250723/4	Aug. 28, 2012	Aug. 27, 2013
RF signal cable HUBER+SUHNNER	SUCOFLEX 106	12738/6+309224/4	Aug. 28, 2012	Aug. 27, 2013
Software ADT.	ADT_Radiated_ V7.6.15.9.2	NA	NA	NA
Antenna Tower inn-co GmbH	MA 4000	013303	NA	NA
Antenna Tower Controller inn-co GmbH	CO2000	017303	NA	NA
Turn Table ADT.	TT100	TT93021703	NA	NA
Turn Table Controller ADT.	SC100	SC93021703	NA	NA
Mini-Circuits Power Splitter	ZN2PD-9G	NA	Mar. 23, 2012	Mar. 22, 2013
JFW 20dB attenuation	50HF-020-SMA	NA	NA	NA
Communications Tester-Wireless	E5515C	MY50266653	Oct. 08, 2012	Oct. 09, 2013

- NOTE:**
1. The calibration interval of the above test instruments is 12 months and the calibrations are traceable to NML/ROC and NIST/USA.
 2. The calibration interval of the loop antenna is 24 months and the calibrations are traceable to NML/ROC and NIST/USA.
 3. The test was performed in HwaYa Chamber 3.
 4. The horn antenna and HP preamplifier (model: 8449B) are used only for the measurement of emission frequency above 1GHz if tested.
 5. The FCC Site Registration No. is 988962.
 6. The IC Site Registration No. is IC 7450F-3.



3 GENERAL INFORMATION

3.1 GENERAL DESCRIPTION OF EUT

EUT	Tablet Computer
MODEL NO.	JT-B1APAAVAM
POWER SUPPLY	5Vdc (adapter or host equipment) 3.7Vdc (Li-ion battery)
MODULATION TYPE	QPSK, OQPSK, HPSK
FREQUENCY RANGE	1851.25MHz ~ 1908.75MHz
MAX. EIRP POWER	21.36dBm (136.8mW)
ANTENNA TYPE	Fixed Internal antenna with -0.4dBi gain
I/O PORTS	Refer to users' manual
DATA CABLE	N/A
ACCESSORY DEVICES	Refer to NOTE as below

NOTE:

1. The EUT uses following accessories.

No.	Product	Brand	MODEL	Description
1	Power adapter	Panasonic	JT-H300AD-11	I/P: 100-240Vac, 220mA O/P: 5.0Vdc, 1600mA DC 1.4m shielded cable with 1 core
2	Battery	Panasonic	JT-B1-BT000U	Rating: 3.7 Vdc, 5720mAh Type: Li-ion
3	USB cable	Mitsumi	ADP-717SR	1.2m shielded cable with 2 cores

2. The above EUT information is declared by the manufacturer and for more detailed features description, please refer to the manufacturer's specifications or User's Manual.

3.2 CONFIGURATION OF SYSTEM UNDER TEST

FOR RADIATION EMISSION TEST

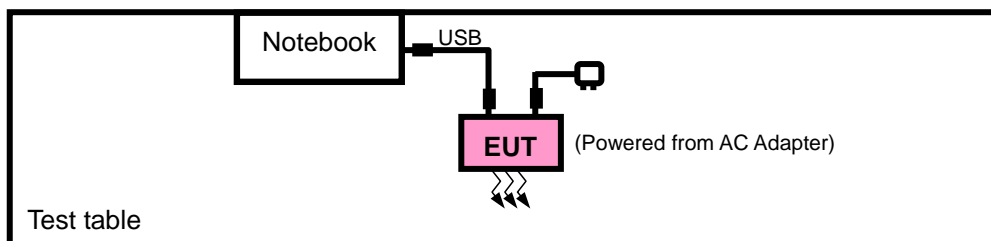

FOR E.R.P. TEST

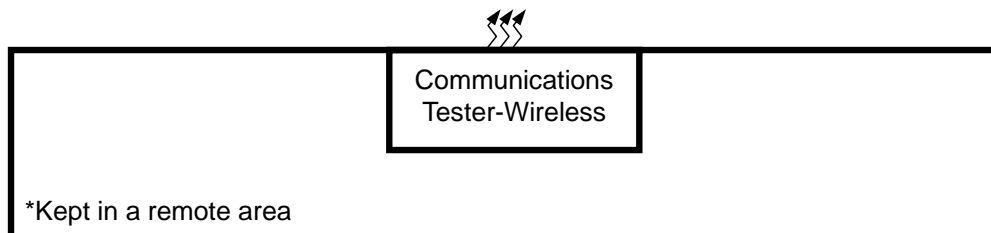
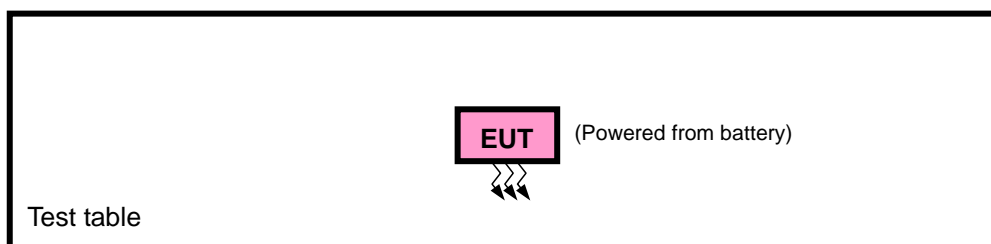



A D T

3.3 DESCRIPTION OF SUPPORT UNITS

The EUT has been tested as an independent unit together with other necessary accessories or support units. The following support units or accessories were used to form a representative test configuration during the tests.

NO.	PRODUCT	BRAND	MODEL NO.	SERIAL NO.	FCC ID
1	Notebook	DELL	D531	CN-0XM006-48643-81 U-2610	QDS-BRCM1020

NO.	SIGNAL CABLE DESCRIPTION OF THE ABOVE SUPPORT UNITS
1	NA

NOTE: All power cords of the above support units are non shielded (1.8m).



3.4 TEST ITEM AND TEST CONFIGURATION

Pre-Scan has been conducted to determine the worst-case mode from all possible combinations between available modulations, data rates, XYZ axis and antenna ports. The worst case was found when positioned on **Z-plane**. Following channel(s) was (were) selected for the final test as listed below:

EUT CONFIGURE MODE	TEST ITEM	AVAILABLE CHANNEL	TESTED CHANNEL	MODE
-	EIRP	25 to 1175	25, 600, 1175	CDMA, 1xEVDO Rev. 0
-	FREQUENCY STABILITY	25 to 1175	600	CDMA
-	OCCUPIED BANDWIDTH	25 to 1175	25, 600, 1175	CDMA
-	BAND EDGE	25 to 1175	25, 1175	CDMA
-	CONDCUETED EMISSION	25 to 1175	600	CDMA
-	RADIATED EMISSION Below 1GHz	25 to 1175	25	CDMA
-	RADIATED EMISSION Above 1GHz	25 to 1175	25, 600, 1175	CDMA

TEST CONDITION:

TEST ITEM	ENVIRONMENTAL CONDITIONS	INPUT POWER	TESTED BY
ERP	24deg. C, 64%RH	3.7Vdc	Howard Kao
FREQUENCY STABILITY	24deg. C, 64%RH	3.7Vdc	Howard Kao
OCCUPIED BANDWIDTH	24deg. C, 64%RH	3.7Vdc	Howard Kao
BAND EDGE	24deg. C, 64%RH	3.7Vdc	Howard Kao
CONDCUETED EMISSION	24deg. C, 64%RH	3.7Vdc	Howard Kao
RADIATED EMISSION	24deg. C, 64%RH	120Vac, 60Hz	Match Tsui

3.5 EUT OPERATING CONDITIONS

The EUT makes a call to the communication simulator. The communication simulator station system controlled a EUT to export maximum output power under transmission mode and specific channel frequency

3.6 GENERAL DESCRIPTION OF APPLIED STANDARDS

The EUT is a RF product. According to the specifications of the manufacturer, it must comply with the requirements of the following standards:

FCC 47 CFR Part 2

FCC 47 CFR Part 24

ANSI/TIA/EIA-603-C 2004

NOTE: All test items have been performed and recorded as per the above standards.

4 TEST TYPES AND RESULTS

4.1 OUTPUT POWER MEASUREMENT

4.1.1 LIMITS OF OUTPUT POWER MEASUREMENT

Mobile and portable stations are limited to 2 watts EIRP

4.1.2 TEST PROCEDURES

EIRP MEASUREMENT:

- a. All measurements were done at low, middle and high operational frequency range. RBW and VBW is 5MHz for CDMA mode.
- b. Substitution method is used for E.I.R.P measurement. In the semi-anechoic chamber, EUT placed on the 0.8m height of Turn Table, rotated the table around 360 degrees to search the maximum radiation power and receiver antenna shall be rotated vertical and horizontal polarization and moved height from 1m to 4m to find the maximum polar radiated power. The “Read Value” is the spectrum reading the maximum power value.
- c. The substitution horn antenna is substituted for EUT at the same position and signals generator export the CW signal to the substitution antenna via a tx cable. Rotated the Turn Table and moved receiving antenna to find the maximum radiation power. Adjust output power level of S.G to get a Value of spectrum reading equal to “Read Value” of step b. Record the power level of S.G
- d. $EIRP = \text{Output power level of S.G} - \text{TX cable loss} + \text{Antenna gain of substitution horn.}$

CONDUCTED POWER MEASUREMENT:

The EUT was set up for the maximum power with CDMA link data modulation and link up with simulator. Set the EUT to transmit under low, middle and high channel and record the power level shown on simulator.

4.1.3 TEST SETUP

EIRP MEASUREMENT:

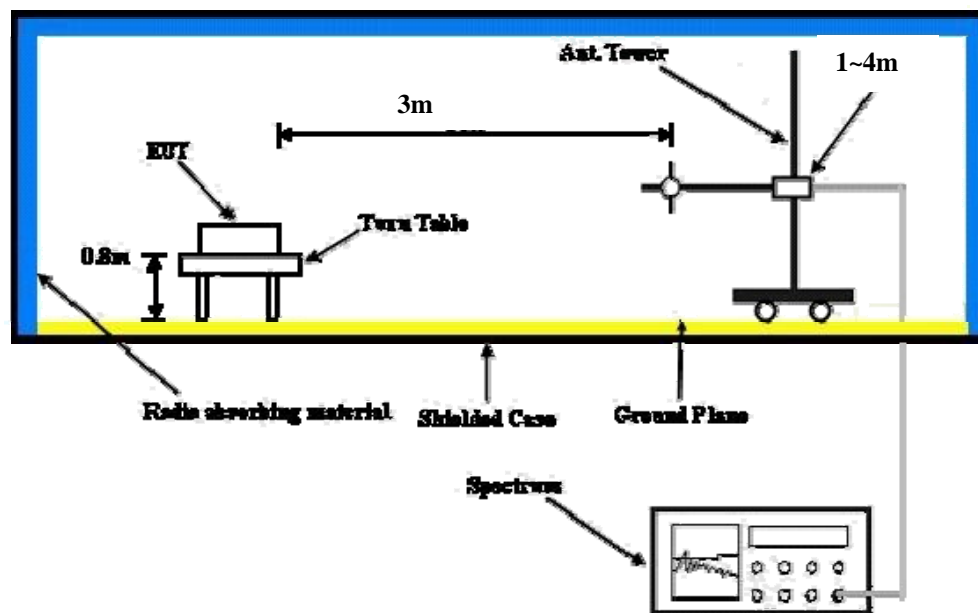

For the actual test configuration, please refer to the attached file (Test Setup Photo).

CONDUCTED POWER MEASUREMENT:

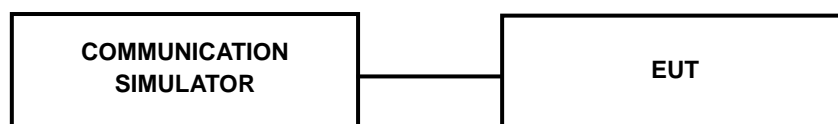

For the actual test configuration, please refer to the attached file (Test Setup Photo).

4.1.4 TEST RESULTS

CONDUCTED OUTPUT POWER (dBm)

Band	CDMA2000 BC0		
	25	600	1175
Channel	25	600	1175
Frequency (MHz)	1851.25	1880	1908.75
RC1+SO55	19.05	19.13	17.90
RC3+SO55	19.13	19.21	17.98
RC3+SO32(+ F-SCH)	19.08	19.16	17.93
RC3+SO32(+SCH)	19.09	19.17	17.94
RTAP 153.6	19.00	19.08	17.65
RETAP 4096	18.94	19.02	17.79



A D T

EIRP POWER (dBm)

FOR CDMA MODE:

MODE		TX channel 25					
ANTENNA POLARITY & TEST DISTANCE: HORIZONTAL AT 3 M							
No.	Freq. (MHz)	Reading (dBm)	S.G Power Value (dBm)	Correction Factor (dB)	EIRP (dBm)	Limit (dBm)	Margin (dB)
1	1851.25	-15.79	20.29	1.07	21.36	33.00	-11.64
ANTENNA POLARITY & TEST DISTANCE: VERTICAL AT 3 M							
No.	Freq. (MHz)	Reading (dBm)	S.G Power Value (dBm)	Correction Factor (dB)	EIRP (dBm)	Limit (dBm)	Margin (dB)
1	1851.25	-18.83	16.12	1.07	17.19	33.00	-15.81

NOTE: Power Value (dBm) = S.G Power Value (dBm) + Correction Factor (dB).

MODE		TX channel 600					
ANTENNA POLARITY & TEST DISTANCE: HORIZONTAL AT 3 M							
No.	Freq. (MHz)	Reading (dBm)	S.G Power Value (dBm)	Correction Factor (dB)	EIRP (dBm)	Limit (dBm)	Margin (dB)
1	1880.00	-15.76	19.74	1.12	20.86	33.00	-12.14
ANTENNA POLARITY & TEST DISTANCE: VERTICAL AT 3 M							
No.	Freq. (MHz)	Reading (dBm)	S.G Power Value (dBm)	Correction Factor (dB)	EIRP (dBm)	Limit (dBm)	Margin (dB)
1	1880.00	-18.97	15.40	1.12	16.52	33.00	-16.48

NOTE: Power Value (dBm) = S.G Power Value (dBm) + Correction Factor (dB).

MODE		TX channel 1175					
ANTENNA POLARITY & TEST DISTANCE: HORIZONTAL AT 3 M							
No.	Freq. (MHz)	Reading (dBm)	S.G Power Value (dBm)	Correction Factor (dB)	EIRP (dBm)	Limit (dBm)	Margin (dB)
1	1908.75	-16.42	19.00	1.11	20.11	33.00	-12.89
ANTENNA POLARITY & TEST DISTANCE: VERTICAL AT 3 M							
No.	Freq. (MHz)	Reading (dBm)	S.G Power Value (dBm)	Correction Factor (dB)	EIRP (dBm)	Limit (dBm)	Margin (dB)
1	1908.75	-17.85	17.46	1.11	18.57	33.00	-14.43

NOTE: Power Value (dBm) = S.G Power Value (dBm) + Correction Factor (dB).



A D T

FOR 1xEVDO Rev. 0 MODE:

MODE		TX channel 25					
ANTENNA POLARITY & TEST DISTANCE: HORIZONTAL AT 3 M							
No.	Freq. (MHz)	Reading (dBm)	S.G Power Value (dBm)	Correction Factor (dB)	EIRP (dBm)	Limit (dBm)	Margin (dB)
1	1851.25	-15.97	20.11	1.07	21.18	33.00	-11.82
ANTENNA POLARITY & TEST DISTANCE: VERTICAL AT 3 M							
No.	Freq. (MHz)	Reading (dBm)	S.G Power Value (dBm)	Correction Factor (dB)	EIRP (dBm)	Limit (dBm)	Margin (dB)
1	1851.25	-19.05	15.90	1.07	16.97	33.00	-16.03

NOTE: Power Value (dBm) = S.G Power Value (dBm) + Correction Factor (dB).

MODE		TX channel 600					
ANTENNA POLARITY & TEST DISTANCE: HORIZONTAL AT 3 M							
No.	Freq. (MHz)	Reading (dBm)	S.G Power Value (dBm)	Correction Factor (dB)	EIRP (dBm)	Limit (dBm)	Margin (dB)
1	1880.00	-15.93	19.57	1.12	20.69	33.00	-12.31
ANTENNA POLARITY & TEST DISTANCE: VERTICAL AT 3 M							
No.	Freq. (MHz)	Reading (dBm)	S.G Power Value (dBm)	Correction Factor (dB)	EIRP (dBm)	Limit (dBm)	Margin (dB)
1	1880.00	-19.13	15.24	1.12	16.36	33.00	-16.64

NOTE: Power Value (dBm) = S.G Power Value (dBm) + Correction Factor (dB).

MODE		TX channel 1175					
ANTENNA POLARITY & TEST DISTANCE: HORIZONTAL AT 3 M							
No.	Freq. (MHz)	Reading (dBm)	S.G Power Value (dBm)	Correction Factor (dB)	EIRP (dBm)	Limit (dBm)	Margin (dB)
1	1908.75	-16.59	18.83	1.11	19.94	33.00	-13.06
ANTENNA POLARITY & TEST DISTANCE: VERTICAL AT 3 M							
No.	Freq. (MHz)	Reading (dBm)	S.G Power Value (dBm)	Correction Factor (dB)	EIRP (dBm)	Limit (dBm)	Margin (dB)
1	1908.75	-18.03	17.28	1.11	18.39	33.00	-14.61

NOTE: Power Value (dBm) = S.G Power Value (dBm) + Correction Factor (dB).

4.2 FREQUENCY STABILITY MEASUREMENT

4.2.1 LIMITS OF FREQUENCY STABILITY MEASUREMENT

The frequency stability shall be sufficient to ensure that the fundamental emission stays within the authorized frequency block.

4.2.2 TEST PROCEDURE

- Device is placed at the oven room. The oven room could control the temperatures and humidity. Power warm up is at least 15 min and power applied should perform before recording frequency error.
- EUT is connected the external power supply to control the DC input power. The test voltage range is from minimum to maximum working voltage. Each step shall be record the frequency error rate.
- The temperature range step is 10 degrees in this test items. All temperature levels shall be hold the $\pm 0.5^{\circ}\text{C}$ during the measurement testing. The each temperature step shall be at least 0.5 hours, consider the EUT could be test under the stability condition.

NOTE: The frequency error was recorded frequency error from the communication simulator.

4.2.3 TEST SETUP

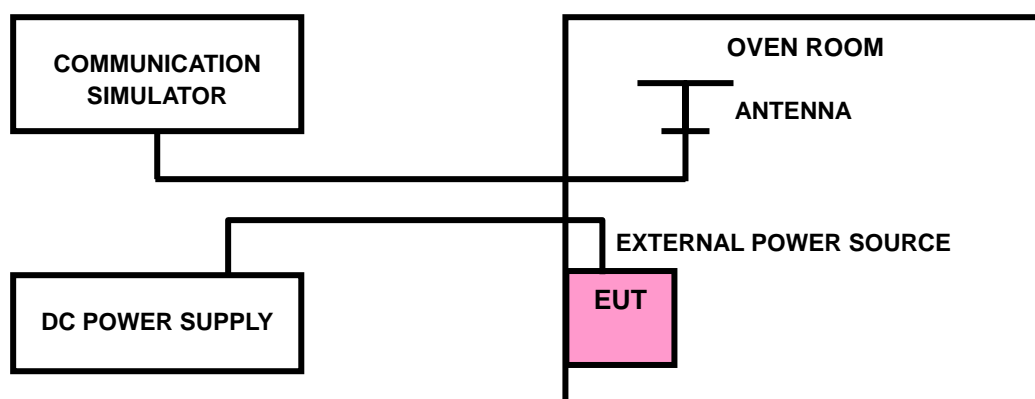

4.2.4 TEST RESULTS

1xRTT RC3+SO32(+ F-SCH) MODE

FREQUENCY ERROR VS. VOLTAGE

VOLTAGE (Volts)	FREQUENCY ERROR (ppm)	LIMIT (ppm)
3.7	0.003	2.5
3.0	-0.002	2.5
5.0	0.003	2.5

NOTE: The applicant defined the normal working voltage of the battery is from 7.0Vdc to 8.4Vdc.

FREQUENCY ERROR vs. TEMPERATURE.

TEMP. (°C)	FREQUENCY ERROR (ppm)	LIMIT (ppm)
-10	0.001	2.5
0	0.002	2.5
10	0.002	2.5
20	-0.003	2.5
30	-0.003	2.5
40	-0.004	2.5

4.3 OCCUPIED BANDWIDTH MEASUREMENT

4.3.1 TEST PROCEDURES

The EUT makes a call to the communication simulator. All measurements were done at low, middle and high operational frequency range. The communication simulator station system controlled a EUT to export maximum output power under transmission mode and specific channel frequency. Use OBW measurement function of Spectrum analyzer to measure 99 % occupied bandwidth.

4.3.2 TEST SETUP

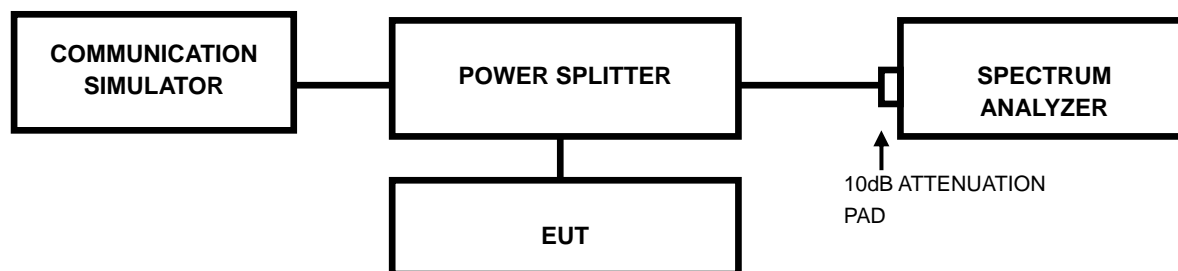



A D T

4.3.3 TEST RESULTS

1xRTT RC3+SO32(+ F-SCH) MODE

CHANNEL	FREQUENCY (MHz)	99% OCCUPIED BANDWIDTH (MHz)	26dB BANDWIDTH (MHz)
25	1851.25	1.279	1.437
600	1880.00	1.277	1.430
1175	1908.75	1.288	1.567

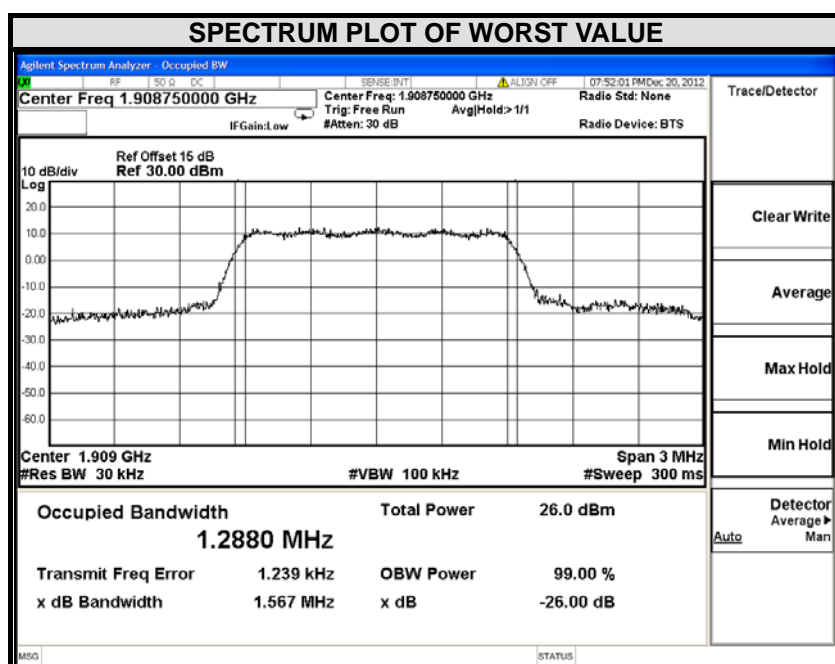

4.4 BAND EDGE MEASUREMENT

4.4.1 LIMITS OF BAND EDGE MEASUREMENT

Power of any emission outside of the authorized operating frequency ranges must be attenuated below the transmitting power (P) by a factor of at least $43 + 10 \log(P)$ dB. In the 1 MHz bands immediately outside and adjacent to the frequency block a resolution bandwidth of at least one percent of the emission bandwidth of the fundamental emission of the transmitter may be employed.

4.4.2 TEST SETUP

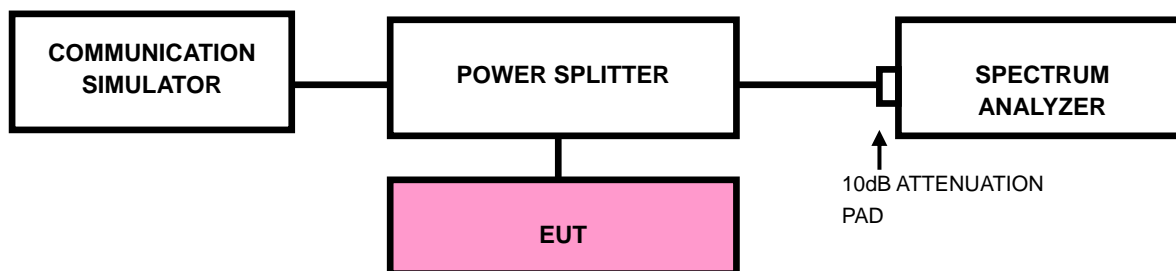

4.4.3 TEST PROCEDURES

- All measurements were done at low and high operational frequency range.
- The center frequency of spectrum is the band edge frequency and span is 2 MHz. RB of the spectrum is 13kHz and VB of the spectrum is 51kHz.
- Record the max trace plot into the test report.



A D T

4.4.4 TEST RESULTS

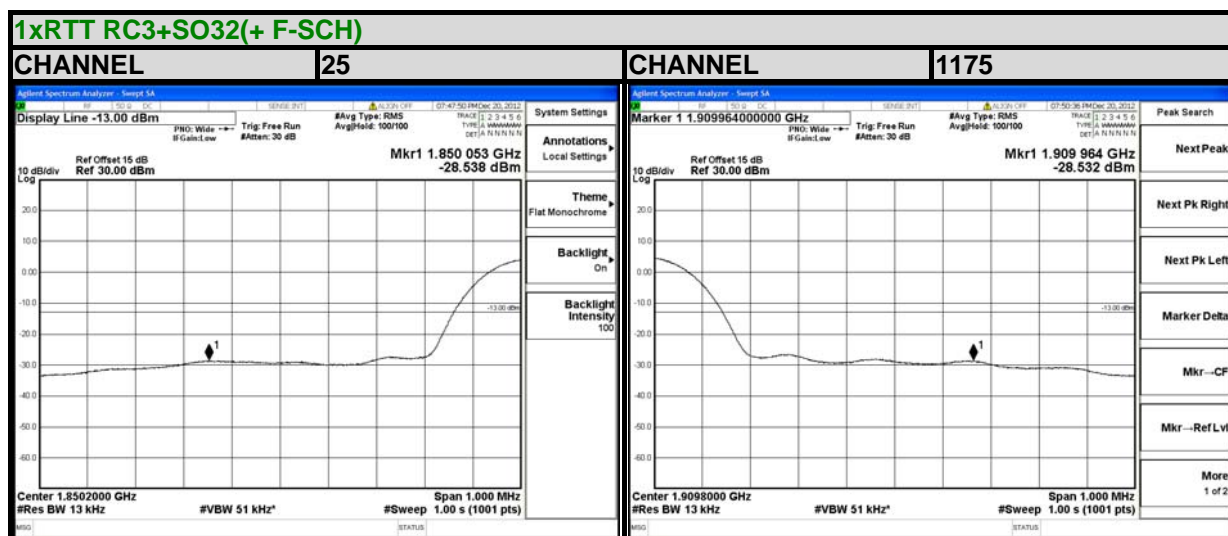

4.5 CONDUCTED SPURIOUS EMISSIONS

4.5.1 LIMITS OF CONDUCTED SPURIOUS EMISSIONS MEASUREMENT

The power of any emission outside of the authorized operating frequency ranges must be attenuated below the transmitting power (P) by a factor of at least $43 + 10 \log(P)$ dB. The emission limit equal to -13dBm .

4.5.2 TEST PROCEDURE

- The EUT makes a phone call to the communication simulator. All measurements were done at low, middle and high operational frequency range.
- Measuring frequency range is from 30MHz to 19.1GHz. 10dB attenuation pad is connected with spectrum. RBW=1MHz and VBW=3MHz is used for conducted emission measurement.

4.5.3 TEST SETUP

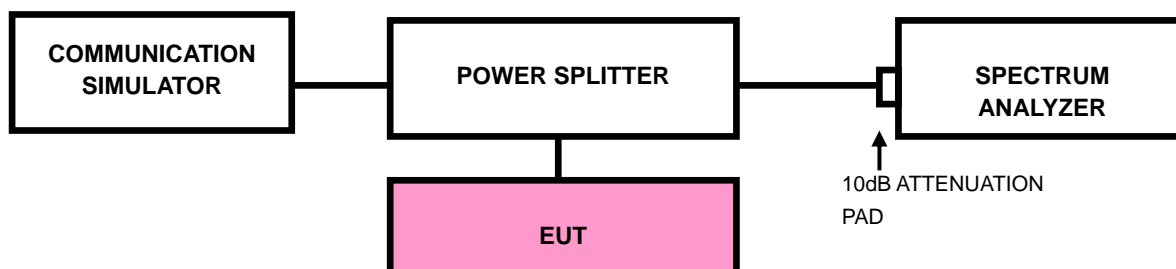



A D T

4.5.4 TEST RESULTS

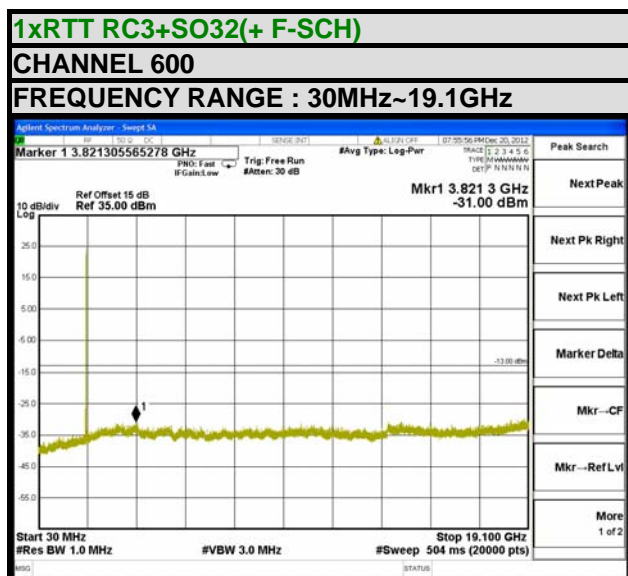

4.6 RADIATED EMISSION MEASUREMENT

4.6.1 LIMITS OF RADIATED EMISSION MEASUREMENT

The power of any emission outside of the authorized operating frequency ranges must be attenuated below the transmitting power (P) by a factor of at least $43 + 10 \log(P)$ dB. The emission limit equal to -13dBm .

4.6.2 TEST PROCEDURES

- a. Substitution method is used for E.I.R.P measurement. In the semi-anechoic chamber, EUT placed on the 0.8m height of Turn Table, rotated the table around 360 degrees to search the maximum radiation power and receiver antenna shall be rotated vertical and horizontal polarization and moved height from 1m to 4m to find the maximum polar radiated power. The “Read Value” is the spectrum reading the maximum power value.
- b. The substitution horn antenna is substituted for EUT at the same position and signals generator export the CW signal to the substitution antenna via a TX cable. Rotated the Turn Table and moved receiving antenna to find the maximum radiation power. Adjust output power level of S.G to get a Value of spectrum reading equal to “Read Value” of step a. Record the power level of S.G
- c. $\text{EIRP} = \text{Output power level of S.G} - \text{TX cable loss} + \text{Antenna gain of substitution horn}$.
- d. E.R.P power can be calculated form E.I.R.P power by subtracting the gain of dipole, $\text{E.R.P power} = \text{E.I.P.R power} - 2.15\text{dBi}$.

NOTE: The resolution bandwidth and video bandwidth of test receiver/spectrum analyzer is 1MHz/3MHz.

4.6.3 DEVIATION FROM TEST STANDARD

No deviation

4.6.4 TEST SETUP

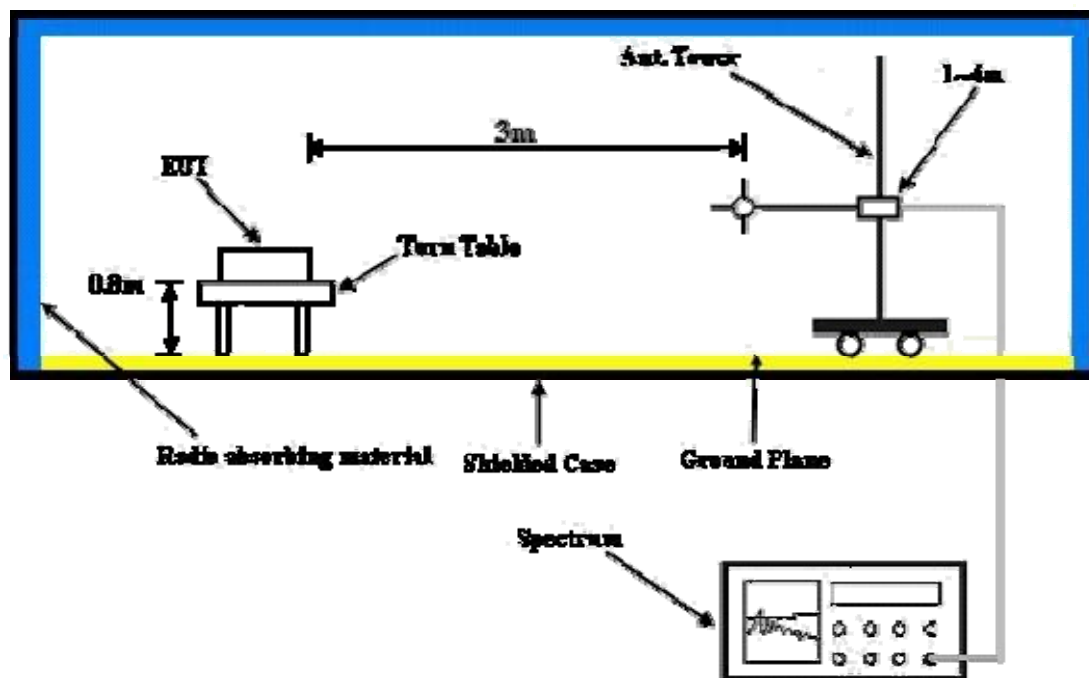

For the actual test configuration, please refer to the attached file (Test Setup Photo).

4.6.5 TEST RESULTS

FOR CDMA MODE:

Below 1GHz

MODE	Channel 25	FREQUENCY RANGE	Below 1000MHz
INPUT POWER	120Vac, 60 Hz	ENVIRONMENTAL CONDITIONS	24deg. C, 64%RH
TESTED BY	Match Tsui		

ANTENNA POLARITY & TEST DISTANCE: HORIZONTAL AT 3 M							
No.	Freq. (MHz)	Reading (dBm)	S.G Power Value (dBm)	Correction Factor (dB)	EIRP (dBm)	Limit (dBm)	Margin (dB)
1	730.34	-75.93	-73.70	4.86	-68.84	-13	-55.84
2	840.92	-75.74	-71.84	3.97	-67.87	-13	-54.87
3	873.90	-75.27	-70.71	3.94	-66.77	-13	-53.77
4	887.48	-75.04	-70.18	3.92	-66.26	-13	-53.26
5	914.64	-74.46	-68.98	3.91	-65.07	-13	-52.07
6	988.36	-75.47	-68.72	3.90	-64.82	-13	-51.82
ANTENNA POLARITY & TEST DISTANCE: VERTICAL AT 3 M							
No.	Freq. (MHz)	Reading (dBm)	S.G Power Value (dBm)	Correction Factor (dB)	EIRP (dBm)	Limit (dBm)	Margin (dB)
1	747.80	-76.26	-73.45	4.65	-68.80	-13	-55.80
2	796.30	-75.53	-72.38	4.07	-68.31	-13	-55.31
3	873.90	-75.10	-70.54	3.94	-66.60	-13	-53.60
4	897.18	-75.04	-69.98	3.91	-66.07	-13	-53.07
5	935.98	-74.87	-68.87	3.92	-64.95	-13	-51.95
6	976.72	-75.35	-68.74	3.92	-64.82	-13	-51.82

REMARKS:

1. ERP(dBm) = S.G Power Value (dBm) + Correction Factor (dB).
2. Correction Factor = gain of substitution antenna + cable loss



A D T

Above 1GHz

MODE	Channel 25	FREQUENCY RANGE	Above 1000MHz
INPUT POWER	120Vac, 60 Hz	ENVIRONMENTAL CONDITIONS	24deg. C, 64%RH
TESTED BY	Match Tsui		

ANTENNA POLARITY & TEST DISTANCE: HORIZONTAL AT 3 M

No.	Freq. (MHz)	Reading (dBm)	S.G Power Value (dBm)	Correction Factor (dB)	EIRP (dBm)	Limit (dBm)	Margin (dB)
1	3702.50	-64.54	-64.11	7.16	-56.95	-13.00	-43.95

ANTENNA POLARITY & TEST DISTANCE: VERTICAL AT 3 M

No.	Freq. (MHz)	Reading (dBm)	S.G Power Value (dBm)	Correction Factor (dB)	EIRP (dBm)	Limit (dBm)	Margin (dB)
1	3702.50	-64.42	-60.82	7.16	-53.66	-13.00	-40.66

REMARKS:

1. ERP(dBm) = S.G Power Value (dBm) + Correction Factor (dB).
2. Correction Factor = gain of substitution antenna + cable loss



A D T

MODE	Channel 600	FREQUENCY RANGE	Above 1000MHz
INPUT POWER	120Vac, 60 Hz	ENVIRONMENTAL CONDITIONS	24deg. C, 64%RH
TESTED BY	Match Tsui		

ANTENNA POLARITY & TEST DISTANCE: HORIZONTAL AT 3 M							
No.	Freq. (MHz)	Reading (dBm)	S.G Power Value (dBm)	Correction Factor (dB)	EIRP (dBm)	Limit (dBm)	Margin (dB)
1	3760.00	-64.69	-64.20	7.10	-57.10	-13.00	-44.10

ANTENNA POLARITY & TEST DISTANCE: VERTICAL AT 3 M							
No.	Freq. (MHz)	Reading (dBm)	S.G Power Value (dBm)	Correction Factor (dB)	EIRP (dBm)	Limit (dBm)	Margin (dB)
1	3760.00	-64.01	-60.35	7.10	-53.25	-13.00	-40.25

REMARKS:

1. ERP(dBm) = S.G Power Value (dBm) + Correction Factor (dB).
2. Correction Factor = gain of substitution antenna + cable loss



A D T

MODE	Channel 1175	FREQUENCY RANGE	Above 1000MHz
INPUT POWER	120Vac, 60 Hz	ENVIRONMENTAL CONDITIONS	24deg. C, 64%RH
TESTED BY	Match Tsui		

ANTENNA POLARITY & TEST DISTANCE: HORIZONTAL AT 3 M

No.	Freq. (MHz)	Reading (dBm)	S.G Power Value (dBm)	Correction Factor (dB)	EIRP (dBm)	Limit (dBm)	Margin (dB)
1	3817.50	-64.88	-64.35	7.06	-57.29	-13.00	-44.29

ANTENNA POLARITY & TEST DISTANCE: VERTICAL AT 3 M

No.	Freq. (MHz)	Reading (dBm)	S.G Power Value (dBm)	Correction Factor (dB)	EIRP (dBm)	Limit (dBm)	Margin (dB)
1	3817.50	-64.45	-60.75	7.06	-53.69	-13.00	-40.69

REMARKS:

1. ERP(dBm) = S.G Power Value (dBm) + Correction Factor (dB).
2. Correction Factor = gain of substitution antenna + cable loss



A D T

5 PHOTOGRAPHS OF THE TEST CONFIGURATION

Please refer to the attached file (Test Setup Photo).



6 INFORMATION ON THE TESTING LABORATORIES

We, Bureau Veritas Consumer Products Services (H.K.) Ltd., Taoyuan Branch, were founded in 1988 to provide our best service in EMC, Radio, Telecom and Safety consultation. Our laboratories are accredited and approved according to ISO/IEC 17025.

If you have any comments, please feel free to contact us at the following:

Linko EMC/RF Lab

Tel: 886-2-26052180

Fax: 886-2-26051924

Hsin Chu EMC/RF Lab

Tel: 886-3-5935343

Fax: 886-3-5935342

Hwa Ya EMC/RF/Safety/Telecom Lab

Tel: 886-3-3183232

Fax: 886-3-3270892

Email: service.adt@tw.bureauveritas.com

Web Site: www.bureauveritas-adt.com

The address and road map of all our labs can be found in our web site also.

--- END ---



A D T

7 APPENDIX A – MODIFICATIONS RECORDERS FOR ENGINEERING CHANGES TO THE EUT BY THE LAB

No any modifications were made to the EUT by the lab during the test.

---END---