

Panasonic[®]

Owner's Manual
CD Stereo System

Model No. **SC-AKX18**



Thank you for purchasing this product.
For optimum performance and safety, please read these instructions carefully.
Please keep this manual for future reference.

If you have any questions, visit: www.panasonic.com/support

Register online at www.panasonic.com/register (U.S. customers only)

La referencia rápida en español se puede encontrar en la página 17.

P

RQT9899-P

Confidential
Until: 9 May 2014

Do the procedures with the remote control. You can also use the buttons on the main unit if they are the same.

Your system and the illustrations can look differently. These operating instructions are applicable to the following system.

System	SC-AKX18
Main unit	SA-AKX18
Speakers	SB-AKX18

The model number and serial number of this product can be found on either the back or the bottom of the unit. Please note them in the space provided below and keep for future reference.

MODEL NUMBER SC-AKX18
SERIAL NUMBER _____

User memo:

DATE OF PURCHASE _____
DEALER NAME _____
DEALER ADDRESS _____
TELEPHONE NUMBER _____

CAUTION - VISIBLE AND INVISIBLE LASER RADIATION WHEN OPEN.
DO NOT STARE INTO BEAM.
FDA 21CFR / CLASS II (IIa) RQLS0512

Inside of product

- If you see this symbol -

Information on Disposal in other Countries outside the European Union



This symbol is only valid in the European Union. If you wish to discard this product, please contact your local authorities or dealer and ask for the correct method of disposal.

IMPORTANT SAFETY INSTRUCTIONS

Read these operating instructions carefully before using the unit. Follow the safety instructions on the unit and the applicable safety instructions listed below. Keep these operating instructions handy for future reference.

1. Read these instructions.
2. Keep these instructions.
3. Heed all warnings.
4. Follow all instructions.
5. Do not use this apparatus near water.
6. Clean only with dry cloth.
7. Do not block any ventilation openings. Install in accordance with the manufacturer's instructions.
8. Do not install near any heat sources such as radiators, heat registers, stoves, or other apparatus (including amplifiers) that produce heat.
9. Do not defeat the safety purpose of the polarized or grounding-type plug. A polarized plug has two blades with one wider than the other. A grounding-type plug has two blades and a third grounding prong. The wide blade or the third prong are provided for your safety. If the provided plug does not fit into your outlet, consult an electrician for replacement of the obsolete outlet.
10. Protect the power cord from being walked on or pinched particularly at plugs, convenience receptacles, and the point where they exit from the apparatus.
11. Only use attachments/accessories specified by the manufacturer.
12. Use only with the cart, stand, tripod, bracket, or table specified by the manufacturer, or sold with the apparatus. When a cart is used, use caution when moving the cart/apparatus combination to avoid injury from tip-over. 
13. Unplug this apparatus during lightning storms or when unused for long periods of time.
14. Refer all servicing to qualified service personnel. Servicing is required when the apparatus has been damaged in any way, such as power-supply cord or plug is damaged, liquid has been spilled or objects have fallen into the apparatus, the apparatus has been exposed to rain or moisture, does not operate normally, or has been dropped.

ENGLISH

Safety precautions

WARNING!

Unit

- To reduce the risk of fire, electric shock or product damage,
 - Do not expose this unit to rain, moisture, dripping or splashing.
 - Do not place objects filled with liquids, such as vases, on this unit.
 - Use only the recommended accessories.
 - Do not remove covers.
 - Do not repair this unit by yourself. Refer servicing to qualified service personnel.
 - Do not let metal objects fall inside this unit.

AC power supply cord

- The power plug is the disconnecting device. Install this unit so that the power plug can be unplugged from the socket outlet immediately.

CAUTION!

Unit

- To reduce the risk of fire, electric shock or product damage,
 - Do not install or place this unit in a bookcase, built-in cabinet or in another confined space. Ensure this unit is well ventilated.
 - Do not obstruct this unit's ventilation openings with newspapers, tablecloths, curtains, and similar items.
 - Do not place sources of naked flames, such as lighted candles, on this unit.
- This unit utilizes a laser. Use of controls or adjustments or performance of procedures other than those specified herein may result in hazardous radiation exposure.
- Set the unit up on an even surface away from direct sunlight, high temperatures, high humidity, and excessive vibration.

Battery

- Danger of explosion if battery is incorrectly replaced. Replace only with the type recommended by the manufacturer.
- When disposing of the batteries, please contact your local authorities or dealer and ask for the correct method of disposal.
- Do not heat or expose to flame.
- Do not leave the battery(ies) in a car exposed to direct sunlight for a long period of time with doors and windows closed.
- Do not break open or short-circuit the battery.
- Do not charge the alkaline or manganese battery.
- Do not use the battery if the cover has peeled off.
- Remove the battery if you do not use the remote control for a long period of time. Keep in a cool, dark area.



CAUTION

RISK OF ELECTRIC SHOCK

DO NOT OPEN



CAUTION: TO REDUCE THE RISK OF ELECTRIC SHOCK, DO NOT REMOVE SCREWS. NO USER-SERVICEABLE PARTS INSIDE. REFER SERVICING TO QUALIFIED SERVICE PERSONNEL.

 The lightning flash with arrowhead symbol, within an equilateral triangle, is intended to alert the user to the presence of uninsulated "dangerous voltage" within the product's enclosure that may be of sufficient magnitude to constitute a risk of electric shock to persons.

 The exclamation point within an equilateral triangle is intended to alert the user to the presence of important operating and maintenance (servicing) instructions in the literature accompanying the appliance.

FCC Note:

This equipment has been tested and found to comply with the limits for a Class B digital device, pursuant to Part 15 of the FCC Rules. These limits are designed to provide reasonable protection against harmful interference in a residential installation. This equipment generates, uses and can radiate radio frequency energy and, if not installed and used in accordance with the instructions, may cause harmful interference to radio communications. However, there is no guarantee that interference will not occur in a particular installation. If this equipment does cause harmful interference to radio or television reception, which can be determined by turning the equipment off and on, the user is encouraged to try to correct the interference by one or more of the following measures:

- Reorient or relocate the receiving antenna.
- Increase the separation between the equipment and receiver.
- Connect the equipment into an outlet on a circuit different from that to which the receiver is connected.
- Consult the dealer or an experienced radio/TV technician for help.

Any unauthorized changes or modifications to this equipment would void the user's authority to operate this device.

This device complies with Part 15 of the FCC Rules. Operation is subject to the following two conditions:
 (1) This device may not cause harmful interference, and
 (2) this device must accept any interference received, including interference that may cause undesired operation.

Responsible Party:
 Panasonic Corporation of North America
 Two Riverfront Plaza, Newark, NJ 07102-5490

Support Contact:
<http://www.panasonic.com/contactinfo>

RQT9899
3

Table of contents

IMPORTANT SAFETY INSTRUCTIONS2
 Safety precautions3
 Maintenance4
 About Bluetooth®4
 Supplied accessories5
 Preparing the remote control5
 Placement of speakers5
 Making the connections6
 Overview of controls7
 Preparing the media8
 Media playback9
 Sound effects10
 Radio11
 Clock and timers12
 External equipment13
 Others13
 Troubleshooting14
 Specifications16
 Spanish quick reference / Referencia rápida en español17
 Limited Warranty (ONLY FOR U.S.A.)19

About Bluetooth®

Parasonic bears no responsibility for data and/or information that can possibly be compromised during a wireless transmission.

Frequency band

- This system uses the 2.4 GHz frequency band.

Certification

- This system conforms to the frequency restrictions and has received certification based on frequency laws. Thus, a wireless permit is not necessary.
- The actions below are punishable by law:
 - Taking apart or modifying the main unit.
 - Removing specification indications.

Restrictions of use

- Wireless transmission and/or usage with all Bluetooth® equipped devices is not guaranteed.
- All devices must conform to standards set by Bluetooth SIG, Inc.
- Depending on the specifications and settings of a device, it can fail to connect or some operations can be different.
- This system supports Bluetooth® security features. But depending on the operating environment and/or settings, this security is possibly not sufficient. Transmit data wirelessly to this system with caution.
- This system cannot transmit data to a Bluetooth® device.

Range of use

- Use this device at a maximum range of 10 m (33 ft).
- The range can decrease depending on the environment, obstacles or interference.

Interference from other devices

- This system may not function properly and troubles such as noise and sound jumps may arise due to radio wave interference if this unit is located too close to other Bluetooth® devices or the devices that use the 2.4 GHz band.
- This system may not function properly if radio waves from a nearby broadcasting station, etc. is too strong.

Intended usage

- This system is for normal, general use only.
- Do not use this system near an equipment or in an environment that is sensitive to radio frequency interference (example: airports, hospitals, laboratories, etc.).

The Bluetooth® word mark and logos are owned by the Bluetooth SIG, Inc. and any use of such marks by Panasonic Corporation is under license. Other trademarks and trade names are those of their respective owners.

Google Play and Android are trademarks of Google Inc.

MPEG Layer-3 audio coding technology licensed from Fraunhofer IIS and Thomson.

Maintenance

To clean this system, wipe with a soft, dry cloth.

- Never use alcohol, paint thinner or benzine to clean this system.
- Before using chemically treated cloth, read the instructions that came with the cloth carefully.

Supplied accessories

Check and identify the supplied accessories.

Use numbers indicated in parentheses when asking for replacement parts. (Product numbers correct as of April 2014. This may be subject to change.)

To order accessories, refer to "Accessory Purchases (United States)" on page 19.

- 1 AC power supply cord (K2CB2CB00022)
- 1 FM indoor antenna (RSAX0002)



- 1 Remote control battery
- 1 Remote control (N2QAYB000944)

Preparing the remote control

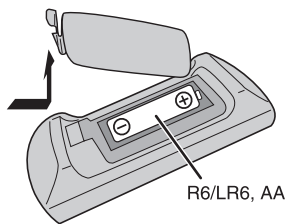

Use alkaline or manganese battery.

Install the battery so that the poles (+ and -) align with those in the remote control.

Placement of speakers



ENGLISH

The left and right speakers are the same. You cannot remove the net of the speakers.

Use only the supplied speakers.

You can cause damage to the system and decrease the sound quality if you use other speakers.

Note:

- Keep your speakers more than 10 mm ($\frac{3}{8}$ ") from the main unit for ventilation.
- Put the speakers on a flat safe surface.
- These speakers do not have magnetic shielding. Do not put them near TVs, PCs or other equipment easily influenced by magnetism.
- When you play at high levels for a long period, it can cause damage to the speakers and decrease the life of the speakers.
- Decrease the volume in these conditions to prevent damage:
 - When the sound is distorted.
 - When you adjust the sound quality.

CAUTION!

- Use the speakers only with the recommended system. If not, you can cause damage to the amplifier and speakers and can cause a fire. Consult an approved service personnel if damage occurs or if there is a sudden apparent change in performance.
- Do the procedures included in these instructions when you attach the speakers.

Making the connections

Connect the AC power supply cord only after all the other connections have been made.

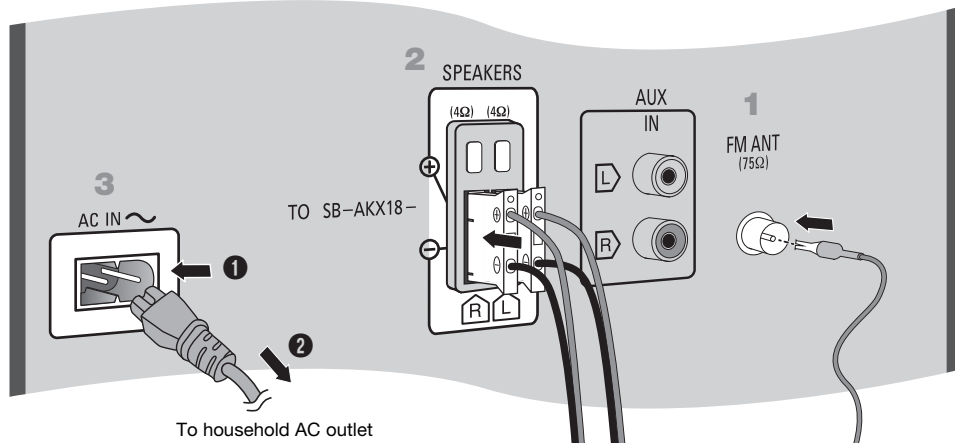

- 1** Connect the FM indoor antenna.
Put the antenna where reception is best.
- 2** Connect the speakers.

- 3** Connect the AC power supply cord.
Do not use an AC power supply cord from other equipment.

Conserving power

The system consumes a small amount of power even when it is in standby mode. Disconnect the power supply if you do not use the system. Some settings will be lost after you disconnect the system. You have to set them again.

Overview of controls

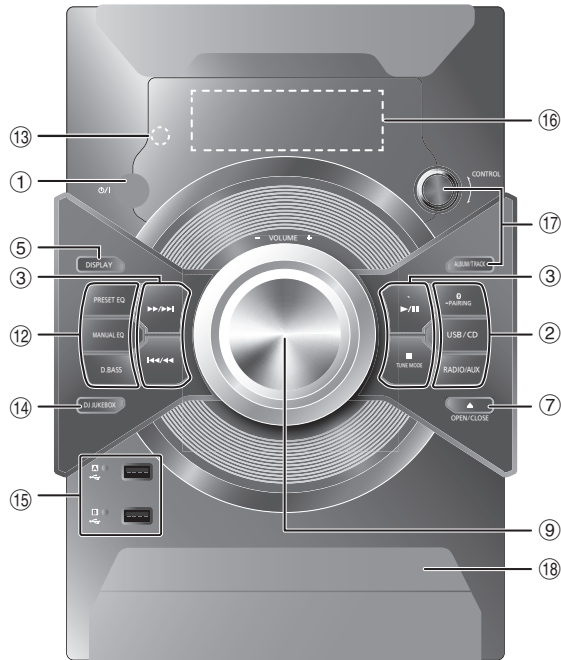
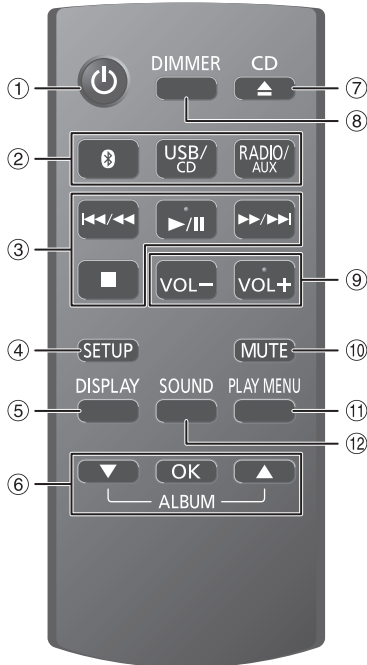

ENGLISH

- ① **Standby/on switch** [⏻], [⏻/⏹]
Press to turn the unit from on to standby mode or vice versa. In standby mode, the unit is still consuming a small amount of power.
- ② **Select the audio source**
On the main unit:
To start Bluetooth® pairing, press and hold [Ⓜ-PAIRING] when you are in Bluetooth® source.
- ③ Basic playback control
- ④ View the setup menu
- ⑤ View the content information
- ⑥ Select or confirm the option
- ⑦ Open or close the disc tray
- ⑧ **Decrease the brightness of the display panel**
To cancel, press the button again.
- ⑨ Adjust the volume level
- ⑩ **Mute the sound**
To cancel, press the button again.
“MUTE” is also canceled when you adjust the volume or when you turn off the system.

- ⑪ View the play menu
- ⑫ Select the sound effects
- ⑬ **Remote control sensor**
Distance: Within approximately 7 m
Angle: Approximately 20° up and down, 30° left and right
- ⑭ Select the DJ jukebox
- ⑮ **USB A | USB B**
USB port (←→)
USB status indicator
- ⑯ Display panel
- ⑰ **Select MP3 album or track**
Press [ALBUM/TRACK] to select album or track.
Browse tracks or albums
Turn [CONTROL] to browse.
To start playback from the selection, press [▶/⏹].
- ⑱ Disc tray

Preparing the media

Disc

- 1 Press [USB/CD] to select "CD".
- 2 Press [CD ▲] (main unit: [▲ OPEN/CLOSE]) to open the disc tray.
Put in a disc with the label facing up.

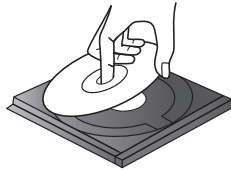

- 3 Press [CD ▲] (main unit: [▲ OPEN/CLOSE]) again to close the disc tray.

USB

Preparation

Before you connect a USB device to the system, make sure you do a backup of the data.



- 1 Decrease the volume and connect the USB device to the USB port.
Hold the main unit when connecting or disconnecting the USB device.
- 2 Press [USB/CD] to select "USB A" or "USB B".

Note:

Do not use a USB extension cable. The system cannot recognize USB device connected through a cable.

Bluetooth®

You can connect and play an audio device wirelessly through Bluetooth®.

Preparation

- Turn on the Bluetooth® feature of the device and put the device near the system.
- Read the operating instructions of the device for details.

RQT9899
8

Pairing a device

Preparation

If this system is connected to a Bluetooth® device, disconnect it (→ "Disconnecting a device").

- 1 Press [Ⓜ].
If "PAIRING" is shown, continue with step 4.
- 2 Press [PLAY MENU] to select "PAIRING".
Or press and hold [Ⓜ -PAIRING] on the main unit until "PAIRING" is shown. Continue with step 4.
- 3 Press [▲, ▼] to select "OK? YES" and then press [OK].
"PAIRING" is shown.
To cancel, select "OK? NO".
- 4 Select "SC-AKX18" from the Bluetooth® menu of the device.
If prompted for a passkey, input "0000".
The device connects with this system automatically after pairing is complete.
The name of the connected device is shown for a few seconds.

Note:

You can pair up to 8 devices with this system. If a 9th device is paired, the device that has not been used for the longest time will be replaced.

Connecting a device

Preparation

If this system is connected to a Bluetooth® device, disconnect it (→ "Disconnecting a device").

- 1 Press [Ⓜ].
"BLUETOOTH READY" is shown.
- 2 Select "SC-AKX18" from the Bluetooth® menu of the device.
The name of the connected device is shown for a few seconds.
- 3 Start playback on the device.

Note:

- A device must be paired to connect.
- The system can only connect to one device at a time.
- When "BLUETOOTH" is selected as the source, this system will automatically try to connect to the last connected device.

Disconnecting a device

- 1 Press [Ⓜ].
- 2 Press [PLAY MENU] to select "DISCONNECT?".
- 3 Press [▲, ▼] to select "OK? YES" and then press [OK].
"BLUETOOTH READY" is shown.
To cancel, select "OK? NO".

Using the main unit

Press and hold [Ⓜ -PAIRING] until "PAIRING" is shown.

Note:

A device is disconnected when you:

- Select a different source.
- Move the device out of the maximum range.
- Disable the Bluetooth® transmission of the device.
- Turn off the system or the device.

ENGLISH

Media playback

The following marks indicate the availability of the feature.

- CD**: CD-R/RW in CD-DA format or with MP3 files.
- USB**: USB device with MP3 files.
- BLUETOOTH**: Bluetooth® device.

Basic playback

CD **USB** **BLUETOOTH**

Play	Press [▶/II].
Stop	Press [■]. USB The position is memorized. "RESUME" is shown. Press again to stop fully.
Pause	Press [▶/II]. Press again to continue playback.
Skip	Press [◀◀/▶▶] or [▶▶/▶▶] to skip track. CD USB Press [▲, ▼] to skip MP3 album.
Search	Press and hold [◀◀/▶▶] or [▶▶/▶▶].

Note:
Depending on the Bluetooth® device, some operations may not work.

Viewing available information

CD **USB** **BLUETOOTH**

You can view the available information on the display panel.

Press [DISPLAY].

- Note:**
- Maximum characters that can be shown:
CD **USB**: approximately 32
BLUETOOTH: approximately 16
 - This system supports ver. 1.0 and 1.1 ID3 tags.
 - Text data that the system does not support can show differently.
 - Example: MP3 album and track number display.

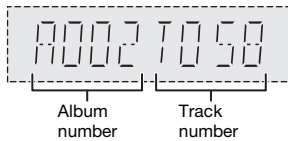

Play menu

CD **USB**

- 1 Press [PLAY MENU] to select "PLAYMODE" or "REPEAT".
- 2 Press [▲, ▼] to select the setting and then press [OK].

PLAYMODE

OFF	Cancel the setting.
PLAYMODE	
1-TRACK 1TR	Play one selected track. Press [◀◀/▶▶] or [▶▶/▶▶] to select the track.
1-ALBUM 1ALBUM	Play one selected MP3 album. Press [▲, ▼] to select the MP3 album.
RANDOM RND	Play all tracks randomly.
1-ALBUM RANDOM 1ALBUM RND	Play all tracks in one selected MP3 album randomly. Press [▲, ▼] to select the MP3 album.

REPEAT

OFF REPEAT	Cancel the setting.
ON REPEAT	Repeat playback.

- Note:**
- During random playback, you cannot skip to tracks which have been played.
 - The setting is canceled when you open the disc tray.

Link mode

BLUETOOTH

You can change the link mode to suit the connection type.

Preparation

If this system is connected to a Bluetooth® device, disconnect it (⇒ "Disconnecting a device").

- 1 Press [PLAY MENU] to select "LINK MODE".
- 2 Press [▲, ▼] to select the setting and then press [OK].

MODE 1	Emphasis on connectivity.
MODE 2	Emphasis on sound quality.

Note:
The default setting is "MODE 2".

Note on disc

- This system can play CD-R/RW with CD-DA or MP3 format content.
- Before playback, finalize the disc on the device it was recorded on.
- Some CD-R/RW cannot be played because of the condition of the recording.

Note about using a DualDisc

- The digital audio content side of a DualDisc does not meet the technical specifications of the Compact Disc Digital Audio (CD-DA) format so playback may not be possible.

Note on USB device

- This system supports USB 2.0 full speed.
- This system can support USB devices of up to 32 GB.
- Only FAT 12/16/32 file system is supported.

Note on MP3 file

- Files are defined as tracks and folders are defined as albums.
- Tracks must have the extension “.mp3” or “.MP3”.
- Tracks will not necessarily be played in the order you recorded them.
- Some files can fail to work because of the sector size.

MP3 file on disc

- This system can access up to:
 - 255 albums (including root folder)
 - 999 tracks
 - 20 sessions
- Disc must conform to ISO9660 level 1 or 2 (except for extended formats).

MP3 file on USB device

- This system can access up to:
 - 800 albums (including root folder)
 - 8000 tracks
 - 999 tracks in one album

Sound effects

- 1 Press [SOUND] to select the sound effect.
- 2 Press [▲, ▼] to select the setting and then press [OK].

PRESET EQ	Select the desired preset EQ setting. Using the main unit Press [PRESET EQ].
BASS	–4 to +4
MID	Using the main unit
TREBLE	1. Press [MANUAL EQ] to select “BASS”, “MID” or “TREBLE”. 2. Press [◀◀/▶▶] or [▶▶/▶▶] to adjust the level.
D.BASS	“ON D.BASS” or “OFF D.BASS” Using the main unit Press [D.BASS].
SURROUND	“ON SURROUND” or “OFF SURROUND”

Note:
The default setting is underlined. Changed settings will be kept until it is changed again, unless otherwise indicated.

DJ jukebox

USB

You can use DJ jukebox to add cross-fading effect between songs. You can also use additional features with the “Panasonic MAX Juke” app (➔ see below).

- 1 Press [PLAY MENU] to select “JUKEBOX” and then press [▲, ▼] to select the setting.
Or press [DJ JUKEBOX] on the main unit to select the setting. Continue with step 3.

OFF CROSS FADE	Cancel cross-fading.
ON CROSS FADE	Add cross-fading.
OFF	Turn off DJ jukebox.

- 2 Press [OK].
- 3 Press [PLAY MENU] to select “PLAYMODE”.
- 4 Press [▲, ▼] to select the setting and then press [OK].

RANDOM REPEAT RND	Play all tracks randomly and repeat all tracks.
ALL TITLE REPEAT RND	Repeat all tracks.

Note:
DJ jukebox effect is canceled when you turn off the system or change to another source.

Using the “Panasonic MAX Juke” app
You can download and install the free Android™ app “Panasonic MAX Juke” on Google Play™ for additional features, such as to request song playback from multiple devices simultaneously.

Radio

Preparation

Press [RADIO/AUX] to select "FM".

Manual tuning

- 1 Press [PLAY MENU] to select "TUNE MODE".
- 2 Press [▲, ▼] to select "MANUAL" and then press [OK].
- 3 Press [◀◀/▶▶] or [▶▶/▶▶] to tune in to the station.
To tune automatically, press and hold the button until the frequency starts changing quickly.
"STEREO" is shown when a stereo broadcast is being received.

Using the main unit

- 1 Press [TUNE MODE] to select "MANUAL".
- 2 Press [◀◀/▶▶] or [▶▶/▶▶] to tune in to the station.

Memory presetting

You can preset up to 30 FM stations.

Automatic presetting

- 1 Press [PLAY MENU] to select "A.PRESET".
- 2 Press [▲, ▼] to select "LOWEST" or "CURRENT" and then press [OK].
The tuner presets all the stations it can receive into the channels in ascending order.
To cancel, press [■].

LOWEST	Tuning begins from the lowest frequency.
CURRENT	Tuning begins from the current frequency.

Manual presetting

- 1 Press [PLAY MENU] to select "TUNE MODE".
- 2 Press [▲, ▼] to select "MANUAL" and then press [OK].
- 3 Press [◀◀/▶▶] or [▶▶/▶▶] to tune in to the station.
- 4 Press [OK].
- 5 Press [▲, ▼] to select a preset number and then press [OK].
Do steps 3 through 5 again to preset more stations.
The new station replaces any station that occupies the same preset number.

Selecting a preset station

- 1 Press [PLAY MENU] to select "TUNE MODE".
- 2 Press [▲, ▼] to select "PRESET" and then press [OK].
- 3 Press [◀◀/▶▶] or [▶▶/▶▶] to select the preset station.

Using the main unit

- 1 Press [TUNE MODE] to select "PRESET".
- 2 Press [◀◀/▶▶] or [▶▶/▶▶] to select the preset station.

Improving the sound quality

- 1 Press [PLAY MENU] to select "FM MODE".
- 2 Press [▲, ▼] to select "MONO" and then press [OK].
To cancel, select "STEREO".
"MONO" is also canceled when you change the frequency.

To memorise the setting

Continue with step 4 of "Manual presetting".

Checking the signal status

Press [DISPLAY].

FM	The FM signal is in monaural. The system is not tuned in to a station.
FM ST	The FM signal is in stereo.
FM MONO	"MONO" is selected as the "FM MODE".

FM allocation setting

By main unit only

This system can also receive FM broadcasts allocated in 0.1 MHz steps.

- 1 Press [RADIO/AUX] to select "FM".
- 2 Press and hold [RADIO/AUX].

After a few seconds, the display panel shows the current minimum radio frequency. Release the button when the minimum frequency changes.

- To go back to the initial setting, do the above steps again.
- Preset frequencies are erased after you change the setting.

External equipment

You can connect a VCR, DVD player etc. and listen to the audio through this system.

Preparation

- Disconnect the AC power supply cord.
- Turn off all equipment and read the appropriate operating instructions.

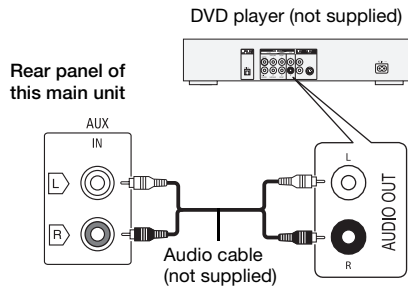

- 1 Connect the external equipment.
- 2 Press [RADIO/AUX] to select "AUX".
- 3 Play the external equipment.

To adjust the input level

- 1 Press [SOUND] to select "INPUT LEVEL".
- 2 Press [▲, ▼] to select "NORMAL" or "HIGH" and then press [OK].

Note:

- The default setting is "NORMAL".
- Select "NORMAL" if the sound is distorted during "HIGH" input level.
- Components and cables are sold separately.
- If you want to connect equipment other than those described, refer to the audio dealer.
- Sound distortion can occur when you use an adapter.

Others

Auto off

This system automatically turns off when you do not use it for approximately 20 minutes.

- 1 Press [SETUP] to select "AUTO OFF".
- 2 Press [▲, ▼] to select "ON" and then press [OK]. "A.OFF" is shown. To cancel, select "OFF".

Note:

This function does not work when you are in radio source or when a Bluetooth® device is connected.

Bluetooth® standby

This function automatically turns on the system when you establish a Bluetooth® connection from a paired device.

- 1 Press [SETUP] to select "BLUETOOTH STANDBY".
- 2 Press [▲, ▼] to select "ON" and then press [OK]. To cancel, select "OFF".

Software version

You can check the software version of the system.

- 1 Press [SETUP] to select "SW VER." and then press [OK]. The software version is shown.
- 2 Press [OK] again to exit.

Troubleshooting

Before requesting service, make the following checks. If you are in doubt about some of the check points, or if the solutions indicated do not solve the problem, consult your dealer for instructions.

Common problems

The unit does not work.

- The safety device has been activated. Do the following:
 1. Press [⏻/|] on the main unit to turn the unit to standby mode. If the unit does not turn to standby mode,
 - Press and hold the button for a minimum of 10 seconds. Or,
 - Disconnect the AC power supply cord and connect it again.
 2. Press [⏻/|] again to turn on the unit. If the problem persists, consult your dealer.

The display panel lights up and changes continuously in standby mode.

- Press and hold [■] on the main unit to select "DEMO OFF".

No operations can be done with the remote control.

- Examine that the battery is installed correctly.

Sound is distorted or no sound.

- Adjust the volume of the system.
- Turn off the system, determine and correct the cause, then turn on again. It can be caused by straining of the speakers through excessive volume or power, and when using the system in a hot environment.

A humming sound can be heard during playback.

- An AC power supply cord or fluorescent light is near the cables. Keep other appliances and cords away from the cables of this system.

The sound level reduces.

- The protection circuit has been activated due to the continuous use at high volume output. This is to protect the system and maintain the sound quality.

Disc

Display not shown correctly.

Playback does not start.

- You have not put in the disc correctly. Put it in correctly.
- Disc is dirty. Clean the disc.
- Replace the disc if it is scratched, warped, or non-standard.
- There is condensation. Let the system dry for 1 to 2 hours.

The total number of tracks displayed is incorrect.

The disc cannot be read.

Distorted sound is heard.

- You put in a disc that the system cannot play. Change to a playable disc.
- You put in a disc that has not been finalized.

USB

The USB device or the contents in it cannot be read.

- The format of the USB device or the contents in it are not compatible with the system.
- USB devices with storage capacity of more than 32 GB cannot work in some conditions.

Slow operation of the USB device.

- Large content size or large memory USB device takes longer time to read.

Bluetooth®

Pairing cannot be done.

- Check the Bluetooth® device condition.
- The device is out of the 10 m (33 ft) communication range. Move the device nearer to the system.

The device cannot be connected.

- The pairing of the device was unsuccessful. Do pairing again.
- The pairing of the device has been replaced. Do pairing again.
- This system might be connected to a different device. Disconnect the other device and try pairing the device again.

The device is connected but audio cannot be heard through the system.

- For some built-in Bluetooth® devices, you have to set the audio output to "SC-AKX18" manually. Read the operating instructions of the device for details.

Sound from the device is interrupted.

- The device is out of the 10 m (33 ft) communication range. Move the device nearer to the system.
- Remove any obstacle between the system and the device.
- Other devices that use the 2.4 GHz frequency band (wireless router, microwaves, cordless phones, etc.) are interfering. Move the device nearer to the system and distance it from the other devices.
- Select "MODE 1" for stable communication.

Radio

Sound is distorted.

- Use an optional outdoor antenna. The antenna should be installed by a competent technician.

A beat sound is heard.

- Turn off the TV or move it away from the system.
- Move mobile telephones away from the system if the interference is apparent.

Main unit displays

“ADJUST CLOCK”

- The clock is not set. Adjust the clock.

“ADJUST TIMER”

- The play timer is not set. Adjust the play timer.

“AUTO OFF”

- The system has not been used for 20 minutes and will turn off within a minute. To cancel, press any button.

“ERROR”

- An incorrect operation was done. Read the instructions and try again.

“F61”

- Examine and correct the speaker cords connection.
- Disconnect the USB device. Turn off the system and then turn on again.

“F70”

- Examine the Bluetooth® connection.
- Disconnect the Bluetooth® device. Turn off the system and then turn on again.

“F76”

- There is a problem with the power supply.
- Disconnect the AC power supply cord and consult your dealer.

“F77”

- Disconnect the AC power supply cord and consult your dealer.

“NODEVICE”

- The USB device is not connected. Examine the connection.

“NO DISC”

- You have not put in a disc.

“NO PLAY”

“UNSUPPORT”

- Examine the content. You can only play supported format.
- The system may have a problem. Turn off the system and then turn on again.

“NO TRACK”

- There is no album or track in the USB device.

“PLAYERERROR”

- You played an unsupported MP3 file. The system will skip that track and play the next one.

“REMOTE 1”

“REMOTE 2”

- The remote control and the main unit are using different codes. Change the code of the remote control.
 - When “REMOTE 1” is shown, press and hold [OK] and [8] for a minimum of 4 seconds.
 - When “REMOTE 2” is shown, press and hold [OK] and [USB/CD] for a minimum of 4 seconds.

“TEMP NG”

- The temperature protection circuit has been activated, and the system will turn off. Let the unit cool down before turning it on again.
- Check that the ventilation opening of the unit is not obstructed.
- Ensure this unit is well ventilated.

“USB OVER CURRENT ERROR”

- The USB device is using too much power. Disconnect the USB device, turn off the system and then turn on again.

“VBR-”

- The system cannot show the remaining play time for variable bit rate (VBR) tracks.

Remote control code

When other Panasonic equipment responds to the remote control of this system, change the remote control code for this system.

Preparation

Press [USB/CD] to select “CD”.

To set the code to “REMOTE 2”

- 1 Press and hold [USB/CD] on the main unit and [RADIO/AUX] on the remote control until “REMOTE 2” is shown.
- 2 Press and hold [OK] and [USB/CD] for a minimum of 4 seconds.

To set the code to “REMOTE 1”

- 1 Press and hold [USB/CD] on the main unit and [USB/CD] on the remote control until “REMOTE 1” is shown.
- 2 Press and hold [OK] and [8] for a minimum of 4 seconds.

System memory reset

Reset the memory when the following situations occur:

- There is no response when buttons are pressed.
- You want to clear and reset the memory contents.

- 1 Disconnect the AC power supply cord.
- 2 While you press and hold [ψ/∕] on the main unit, connect the AC power supply cord again. Continue to press and hold the button until “-----” is shown.
- 3 Release [ψ/∕].
All the settings are set back to the factory preset. It is necessary to set the memory items again.

Specifications

Amplifier section

RMS output power stereo mode
 Front Ch (both ch driven)
 175 W per channel (4 Ω, 1 kHz, 30% THD)
 Total RMS stereo mode power 350 W (30% THD)

FTC output power stereo mode
 Front Ch (both ch driven)
 80 W per channel (4 Ω), 50 Hz to 20 kHz, 1% THD
 Total FTC stereo mode power 160 W

Tuner, terminals section

Preset memory FM 30 stations
Frequency modulation (FM)
 Frequency range
 87.9 MHz to 107.9 MHz (200 kHz step)
 87.5 MHz to 108.0 MHz (100 kHz step)
 Antenna terminals 75 Ω (unbalanced)
Analog audio input Pin jack (1 system)

Disc section

Disc played [8 cm (3") or 12 cm (5")]
 CD, CD-R/RW (CD-DA, MP3*)
Pick up
 Wavelength 790 nm (CD)
 * MPEG-1 Layer 3

Bluetooth® section

Version Bluetooth® Ver. 2.1 + EDR
Class Class 2
Supported profiles A2DP, AVRCP, SPP
Operating frequency 2.4 GHz band, FH-SS
Operation distance 10 m (33 ft) line of sight

USB section

USB port
 USB standard USB 2.0 full speed
 Media file format support MP3 (*.mp3)
 USB device file system FAT12, FAT16, FAT32
 USB port power 500 mA (max)

Speaker section

Speaker unit(s)
 Woofer 16 cm (6 1/2") cone type
 Tweeter 6 cm (2 3/8") cone type
Impedance 4 Ω
Dimensions (W x H x D) 200 mm x 334 mm x 233 mm
 (7 3/4" x 13 1/4" x 9 1/4")
Mass (Weight) 3 kg (6.6 lbs)

General

Power supply AC 120 V, 60 Hz
Power consumption 50 W
Dimensions (W x H x D) 230 mm x 335 mm x 243 mm
 (9 1/4" x 13 1/4" x 9 3/4")
Mass (Weight) 2.7 kg (6 lbs)
Operating temperature range 0°C to +40°C
 (+32°F to +104°F)
Operating humidity range 35% to 80% RH (no condensation)

Power consumption in standby mode	0.4 W (approximate)
Power consumption in standby mode (With "BLUETOOTH STANDBY" set to "ON")	0.5 W (approximate)

- Note:**
- Specifications are subject to change without notice.
 - Mass (weight) and dimensions are approximate.
 - Total harmonic distortion is measured by the digital spectrum analyzer.

Spanish quick reference / Referencia rápida en español

Cómo realizar las conexiones

Conecte el cable de alimentación de CA sólo después de haber hecho todas las demás conexiones.

- 1 Conecte la antena interior de FM.
Coloque la antena donde la recepción sea la mejor.
- 2 Conecte las bocinas.
- 3 Conecte el cable de alimentación de CA.
No use un cable de alimentación de CA de otro equipo.

Reproducción de medios

Reproducción básica

CD USB BLUETOOTH

Reproducir	Pulse [▶/] .
Detener	Pulse [■] . USB Se memorizará la posición. Se visualiza "RESUME". Pulse nuevamente para detener totalmente.
Pausar	Pulse [▶/] . Pulse nuevamente para reanudar la reproducción.
Saltar	Pulse [◀◀/▶▶] o [▶▶/▶▶] para saltar pista. CD USB Pulse [▲, ▼] para saltar álbum MP3.
Buscar	Pulse y mantenga pulsado [◀◀/▶▶] o [▶▶/▶▶] .

Nota:
Dependiendo del dispositivo Bluetooth®, algunas operaciones pueden no funcionar.

Radio

Preparación
Pulse **[RADIO/AUX]** para seleccionar "FM".

Sintonización manual

- 1 Pulse **[PLAY MENU]** para seleccionar "TUNE MODE".
- 2 Pulse **[▲, ▼]** para seleccionar "MANUAL" y después pulse **[OK]**.
- 3 Pulse **[◀◀/▶▶]** o **[▶▶/▶▶]** para sintonizar la estación.
Para sintonizar automáticamente, pulse y mantenga pulsado el botón hasta que la frecuencia comience a cambiar rápidamente.
Cuando se esté recibiendo una emisión en estéreo se visualizará "STEREO".

Presintonización de la memoria

Puede presintonizar hasta 30 emisoras de radio FM.

Preconfiguración automática

- 1 Pulse **[PLAY MENU]** para seleccionar "A.PRESET".
- 2 Pulse **[▲, ▼]** para seleccionar "LOWEST" o "CURRENT" y después pulse **[OK]**.
El sintonizador presintonizará en los canales, en orden ascendente, todas las emisoras que pueda recibir.
Para cancelar, pulse **[■]**.

Preconfiguración manual

- 1 Pulse **[PLAY MENU]** para seleccionar "TUNE MODE".
- 2 Pulse **[▲, ▼]** para seleccionar "MANUAL" y después pulse **[OK]**.
- 3 Pulse **[◀◀/▶▶]** o **[▶▶/▶▶]** para sintonizar la estación.
- 4 Pulse **[OK]**.
- 5 Pulse **[▲, ▼]** para seleccionar un número preconfigurado y después pulse **[OK]**.
Realice los pasos 3 al 5 nuevamente para preconfigurar más estaciones.
La estación más reciente reemplazará cualquier estación que ocupe el mismo número preconfigurado.

Selección de una emisora preconfigurada

- 1 Pulse **[PLAY MENU]** para seleccionar "TUNE MODE".
- 2 Pulse **[▲, ▼]** para seleccionar "PRESET" y después pulse **[OK]**.
- 3 Pulse **[◀◀/▶▶]** o **[▶▶/▶▶]** para seleccionar una emisora preconfigurada.

ESPAÑOL

RQT9899

17

Limited Warranty (ONLY FOR U.S.A.)

Panasonic Products Limited Warranty

Limited Warranty Coverage (For USA Only)

If your product does not work properly because of a defect in materials or workmanship, Panasonic Corporation of North America (referred to as "the warrantor") will, for the length of the period indicated on the chart below, which starts with the date of original purchase ("warranty period"), at its option either (a) repair your product with new or refurbished parts, (b) replace it with a new or a refurbished equivalent value product, or (c) refund your purchase price. The decision to repair, replace or refund will be made by the warrantor.

Product or Part Name	Parts	Labor
CD Stereo System	1 Year	1 Year
All included Accessories (Except Non-Rechargeable Batteries)	90 Days	Not Applicable
Only Non-Rechargeable Batteries	10 Days	Not Applicable

During the "Labor" warranty period there will be no charge for labor. During the "Parts" warranty period, there will be no charge for parts. This Limited Warranty excludes both parts and labor for non-rechargeable batteries, antennas, and cosmetic parts (cabinet). This warranty only applies to products purchased and serviced in the United States. This warranty is extended only to the original purchaser of a new product which was not sold "as is".

Mail-In Service -- Online Repair Request

Online Repair Request

To submit a new repair request and for quick repair status visit our Web Site at www.panasonic.com/repair.

When shipping the unit, carefully pack, include all supplied accessories listed in the Owner's Manual, and send it prepaid, adequately insured and packed well in a carton box. When shipping Lithium Ion batteries please visit our Web Site at www.panasonic.com/BatteryHandling as Panasonic is committed to providing the most up to date information. Include a letter detailing the complaint, a return address and provide a daytime phone number where you can be reached. A valid registered receipt is required under the Limited Warranty.

IF REPAIR IS NEEDED DURING THE WARRANTY PERIOD, THE PURCHASER WILL BE REQUIRED TO FURNISH A SALES RECEIPT/PROOF OF PURCHASE INDICATING DATE OF PURCHASE, AMOUNT PAID AND PLACE OF PURCHASE. CUSTOMER WILL BE CHARGED FOR THE REPAIR OF ANY UNIT RECEIVED WITHOUT SUCH PROOF OF PURCHASE.

Limited Warranty Limits And Exclusions

This warranty ONLY COVERS failures due to defects in materials or workmanship, and DOES NOT COVER normal wear and tear or cosmetic damage. The warranty ALSO DOES NOT COVER damages which occurred in shipment, or failures which are caused by products not supplied by the warrantor, or failures which result from accidents, misuse, abuse, neglect, mishandling, misapplication, alteration, faulty installation, set-up adjustments, misadjustment of consumer controls, improper maintenance, power line surge, lightning damage, modification, introduction of sand, humidity or liquids, commercial use such as hotel, office, restaurant, or other business or rental use of the product, or service by anyone other than a Factory Service Center or other Authorized Servicer, or damage that is attributable to acts of God.

THERE ARE NO EXPRESS WARRANTIES EXCEPT AS LISTED UNDER "LIMITED WARRANTY COVERAGE". THE WARRANTOR IS NOT LIABLE FOR INCIDENTAL OR CONSEQUENTIAL DAMAGES RESULTING FROM THE USE OF THIS PRODUCT, OR ARISING OUT OF ANY BREACH OF THIS WARRANTY.

(As examples, this excludes damages for lost time, travel to and from the servicer, loss of or damage to media or images, data or other memory or recorded content. The items listed are not exclusive, but for illustration only.)

ALL EXPRESS AND IMPLIED WARRANTIES, INCLUDING THE WARRANTY OF MERCHANTABILITY, ARE LIMITED TO THE PERIOD OF THE LIMITED WARRANTY.

Some states do not allow the exclusion or limitation of incidental or consequential damages, or limitations on how long an implied warranty lasts, so the exclusions may not apply to you.

This warranty gives you specific legal rights and you may also have other rights which vary from state to state. If a problem with this product develops during or after the warranty period, you may contact your dealer or Service Center. If the problem is not handled to your satisfaction, then write to the warrantor's Consumer Affairs Department at the addresses listed for the warrantor.

PARTS AND SERVICE, WHICH ARE NOT COVERED BY THIS LIMITED WARRANTY, ARE YOUR RESPONSIBILITY.

Customer Services Directory (United States)

Obtain Product Information and Operating Assistance; locate your nearest Dealer or Service Center; purchase Parts and Accessories; or make Customer Service and Literature requests by visiting our Web Site at: <http://www.panasonic.com/support> or, contact us via the web at: <http://www.panasonic.com/contactinfo>

For hearing or speech impaired TTY users, TTY: 1-877-833-8855

Accessory Purchases (United States)

Purchase Parts, Accessories and Owner's Manual online for all Panasonic Products by visiting our Web Site at:

<http://www.pstc.panasonic.com>
or, send your request by E-mail to: npcparts@us.panasonic.com

You may also contact us directly at:

1-800-237-9080 (Fax Only)
(Monday-Friday 9am-9pm EST)
Panasonic National Parts Center
20421 84th Avenue South, Kent, WA 98032
(We accept Visa, MasterCard, Discover Card, and American Express.)

For hearing or speech impaired TTY users, TTY: 1-866-605-1277

As of April 2014

Panasonic Corporation of North America

En Sp

Two Riverfront Plaza, Newark,
New Jersey 07102-5490
<http://www.panasonic.com>

© Panasonic Corporation 2014
Printed in Malaysia

RQT9899-P
L0414LC0

Confidential
Until: 9 May 2014