



FCC/IC Radio Test Report

FCC ID: ACJ-B21-R10004

IC: 216A-B21R10004

This report concerns (check one) : Original Grant Class II Change

Issued Date : Jan. 18, 2011
Project No. : 1101C024
Equipment : Compact Stereo System
Model Name : SC-HC05
Applicant : Panasonic Corporation of North America
Address : One Panasonic Way, 4B-8Secaucus, NJ 07094
Applicant : PANASONIC CANADA INC
Address : 5770 AMBLER DRIVE MISSISSAUGA, ONTARIO
L4W 2T3 CANADA
Manufacturer : Panasonic Corporation (Networks Business Group)
Address : 1-15 Matsuo-cho, Kadoma-shi, Osaka 571-8504
Japan

Tested by:

Neutron Engineering Inc. EMC Laboratory

Date of Receipt: Jan. 05, 2011

Date of Test:

Jan. 05, 2011~ Jan. 17, 2011

Testing Engineer :

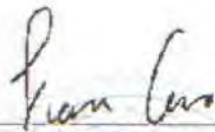

(Ivan Cao)

Technical Manager :

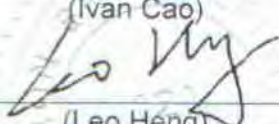

(Leo Heng)

Authorized Signatory :

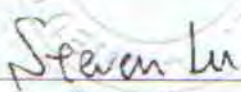

(Steven Lu)

Neutron Engineering Inc.

No.3, Jinshagang 1st Road, ShiXia, Dalang
Town, Dong Guan, China.

TEL : (0769) 8318-3000 FAX : (0769) 8319-6000



Declaration

Neutron represents to the client that testing is done in accordance with standard procedures as applicable and that test instruments used has been calibrated with the standards traceable to National Measurement Laboratory (**NML**) of **CHINA**, or National Institute of Standards and Technology (**NIST**) of **U.S.A.**

Neutron's reports apply only to the specific samples tested under conditions. It is manufacture's responsibility to ensure that additional production units of this model are manufactured with the identical electrical and mechanical components. **Neutron** shall have no liability for any declarations, inferences or generalizations drawn by the client or others from **Neutron** issued reports.

Neutron's reports must not be used by the client to claim product endorsement by the authorities or any agency of the Government.

This report is the confidential property of the client. As a mutual protection to the clients, the public and **Neutron-self**, extracts from the test report shall not be reproduced except in full with **Neutron's** authorized written approval.

Neutron's laboratory quality assurance procedures are in compliance with the **ISO Guide 17025** requirements, and accredited by the conformity assessment authorities listed in this test report.

Limitation

For the use of the authority's logo is limited unless the Test Standard(s)/Scope(s)/Item(s) mentioned in this test report is (are) included in the conformity assessment authorities acceptance respective.



Table of Contents	Page
1 . CERTIFICATION	6
2 . SUMMARY OF TEST RESULTS	7
2.1 TEST FACILITY	8
2.2 MEASUREMENT UNCERTAINTY	8
3 . GENERAL INFORMATION	9
3.1 GENERAL DESCRIPTION OF EUT	9
3.2 DESCRIPTION OF TEST MODES	11
3.3 TABLE OF PARAMETERS OF TEXT SOFTWARE SETTING	11
3.4 BLOCK DIGRAM SHOWING THE CONFIGURATION OF SYSTEM TESTED	12
3.5 DESCRIPTION OF SUPPORT UNITS	13
4 . EMC EMISSION TEST	14
4.1 CONDUCTED EMISSION MEASUREMENT	14
4.1.1 POWER LINE CONDUCTED EMISSION LIMITS	14
4.1.2 MEASUREMENT INSTRUMENTS LIST AND SETTING	14
4.1.3 TEST PROCEDURE	15
4.1.4 DEVIATION FROM TEST STANDARD	15
4.1.5 TEST SETUP	15
4.1.6 EUT OPERATING CONDITIONS	15
4.1.7 TEST RESULTS	16
4.2 RADIATED EMISSION MEASUREMENT	18
4.2.1 RADIATED EMISSION LIMITS	18
4.2.2 MEASUREMENT INSTRUMENTS LIST ANS SETTING	19
4.2.3 TEST PROCEDURE	20
4.2.4 DEVIATION FROM TEST STANDARD	20
4.2.5 TEST SETUP	21
4.2.6 EUT OPERATING CONDITIONS	22
4.2.7 TEST RESULTS (BELOW 30MHZ)	23
4.2.8 TEST RESULTS (BETWEEN30 – 1000 MHZ)	24
4.2.9 TEST RESULTS (ABOVE 1000 MHZ)	28
5 . NUMBER OF HOPPING CHANNEL	58
5.1 APPLIED PROCEDURES / LIMIT	58
5.1.1 MEASUREMENT INSTRUMENTS LIST AND SETTING	58
5.1.2 TEST PROCEDURE	58
5.1.3 DEVIATION FROM STANDARD	58
5.1.4 TEST SETUP	58
5.1.5 EUT OPERATION CONDITIONS	58



Table of Contents	Page
5.1.6 TEST RESULTS	59
6 . AVERAGE TIME OF OCCUPANCY	61
6.1 APPLIED PROCEDURES / LIMIT	61
6.1.1 MEASUREMENT INSTRUMENTS LIST	61
6.1.2 TEST PROCEDURE	61
6.1.3 DEVIATION FROM STANDARD	61
6.1.4 TEST SETUP	62
6.1.5 EUT OPERATION CONDITIONS	62
6.1.6 TEST RESULTS	63
7 . HOPPING CHANNEL SEPARATION MEASUREMENT	75
7.1 APPLIED PROCEDURES / LIMIT	75
7.1.1 MEASUREMENT INSTRUMENTS LIST AND SETTING	75
7.1.2 TEST PROCEDURE	75
7.1.3 DEVIATION FROM STANDARD	75
7.1.4 TEST SETUP	75
7.1.5 EUT OPERATION CONDITIONS	75
7.1.6 TEST RESULTS	76
8 . BANDWIDTH TEST	80
8.1 APPLIED PROCEDURES / LIMIT	80
8.1.1 MEASUREMENT INSTRUMENTS LIST AND SETTING	80
8.1.2 TEST PROCEDURE	80
8.1.3 DEVIATION FROM STANDARD	80
8.1.4 TEST SETUP	80
8.1.5 EUT OPERATION CONDITIONS	80
8.1.6 TEST RESULTS	81
9 . PEAK OUTPUT POWER TEST	85
9.1 APPLIED PROCEDURES / LIMIT	85
9.1.1 MEASUREMENT INSTRUMENTS LIST AND SETTING	85
9.1.2 TEST PROCEDURE	85
9.1.3 DEVIATION FROM STANDARD	85
9.1.4 TEST SETUP	85
9.1.5 EUT OPERATION CONDITIONS	85
9.1.6 TEST RESULTS	86
10 . ANTENNA CONDUCTED SPURIOUS EMISSION	90
10.1 APPLIED PROCEDURES / LIMIT	90
10.1.1 MEASUREMENT INSTRUMENTS LIST AND SETTING	90
10.1.2 TEST PROCEDURE	90
10.1.3 DEVIATION FROM STANDARD	90
10.1.4 TEST SETUP	90



Table of Contents	Page
10.1.5 EUT OPERATION CONDITIONS	90
10.1.6 TEST RESULTS	91
11 . RF EXPOSURE TEST	103
11.1 APPLIED PROCEDURES / LIMIT	103
11.1.1 MEASUREMENT INSTRUMENTS LIST	103
11.1.2 MPE CALCULATION METHOD	104
11.1.3 DEVIATION FROM STANDARD	104
11.1.4 TEST SETUP	104
11.1.5 EUT OPERATION CONDITIONS	104
11.1.6 TEST RESULTS	105
12 . EUT TEST PHOTO	106



1. CERTIFICATION

Equipment : Compact Stereo System
Brand Name : Panasonic
Model Name : SC-HC05
Applicant : Panasonic Corporation of North America
Applicant : PANASONIC CANADA INC
Factory : Solid Industrial (Shenzhen) Co., Ltd.
Address : 333 Bulong Highway, Buji, Longgang, Shenzhen, China
Date of Test : Jan. 05, 2011~ Jan. 17, 2011
Test Item : ENGINEERING SAMPLE
Standards : FCC Part15, Subpart C(15.247) / ANSI C63.4 : 2003 / Canada RSS-210:2010

The above equipment has been tested and found compliance with the requirement of the relative standards by Neutron Engineering Inc. EMC Laboratory.

The test data, data evaluation, and equipment configuration contained in our test report (Ref No. NEI-FICP-1-1101C024) were obtained utilizing the test procedures, test instruments, test sites that has been accredited by the Authority of NVLAP and TAF according to the ISO-17025 quality assessment standard and technical standard(s).



2. SUMMARY OF TEST RESULTS

Test procedures according to the technical standards:

APPLIED STANDARD: 47 CFR Part 15, Subpart C; Canada RSS-210:2010				
Standard Section		Test Item	Judgment	Remark
RSS-210	47 CFR Part 15			
RSS-GEN 7.2.2	15.207	Conducted Emission	PASS	
RSS-210 Annex 8 (A8.1d)	15.247(d)	Antenna conducted Spurious Emission	PASS	
RSS-210 Annex 8 (A8.1d)	15.247 (a)(1)	Hopping Channel Separation	PASS	
RSS-210 Annex 8 (A8.1b)	15.247 (b)(1)	Peak Output Power	PASS	
RSS-210 Annex 8 (A8.1a)	15.247(d) 15.209	Radiated Spurious Emission	PASS	
RSS-210 Annex 8 (A8.4(2))	15.247 (a)(1)(iii)	Number of Hopping Frequency	PASS	
RSS-210 Annex 8 (A8.5)	15.247 (a)(1)(iii)	Dwell Time	PASS	
RSS-Gen 7.2.3	15.205	Restricted Bands	PASS	
RSS-210 Annex 8 (A8.5)	15.203	Antenna Requirement	PASS	
	1.1307 1.1310 2.1091 2.1093	RF Exposure Compliance	PASS NOTE (2)	

NOTE:

- (1) "N/A" denotes test is not applicable in this Test Report
- (2) The EUT considered as a portable device because the antenna distance to end user is less than 20cm. Per KDB 447498, the average output power of the Bluetooth is less than the power threshold= 60/f(GHz), so it does not subject to stand-alone SAR evaluation. Based on above, this device is demonstrated to comply with FCC CFR 47 §1.1310 and 2.1093.



2.1 TEST FACILITY

The test facilities used to collect the test data in this report is **DG-C01/CB03** at the location of No.3,Jinshagang 1st Road, ShiXia, Dalang Town, Dong Guan, China.523792

Neutron's test firm number for FCC 319330

Neutron's test firm number for IC 4428B-1

2.2 MEASUREMENT UNCERTAINTY

Where relevant, the following measurement uncertainty levels have been estimated for tests performed on the EUT as specified in CISPR 16-4-2:

The reported uncertainty of measurement $y \pm U$, where expanded uncertainty **U** is based on a standard uncertainty multiplied by a coverage factor of **k=2**, providing a level of confidence of approximately **95 %**.

A. Conducted Measurement :

Test Site	Method	Measurement Frequency Range	U , (dB)	NOTE
DG-C01	CISPR	150 KHz ~ 30MHz	1.94	

B. Radiated Measurement :

Test Site	Method	Measurement Frequency Range	Ant. H / V	U , (dB)	NOTE
CB03	CISPR	30MHz ~ 200MHz	V	3.82	
		30MHz ~ 200MHz	H	3.60	
		200MHz ~ 1,000MHz	V	3.86	
		200MHz ~ 1,000MHz	H	3.94	



3. GENERAL INFORMATION

3.1 GENERAL DESCRIPTION OF EUT

Equipment	Compact Stereo System	
Brand Name	Panasonic	
Model Name	SC-HC05	
OEM Brand/Model Name	N/A	
Model Difference	N/A	
Product Description	The EUT is a Compact Stereo System	
	Operation Frequency:	2402~2480 MHz
	Modulation Type:	GFSK(1Mbps)
	Bit Rate of Transmitter	π /4-DQPSK(2Mbps)
		8-DPSK(3Mbps)
	Number of Channel	79 CH
	Antenna Designation:	Please see Note 3.
	Antenna Gain(Peak)	Please see Note 3.
	Output Power:	-1.49 dBm (1Mbps)
-3.37 dBm (3Mbps)		
Based on the application, features, or specification exhibited in User's Manual, the EUT is considered as an ITE/Computing Device. More details of EUT technical		
Power Source	AC Mains.	
Power Rating	AC 120V/60Hz	
Connecting I/O Port(s)	Please refer to the User's Manual	
Products Covered	N/A	
EUT Modification(s)	N/A	

Note:

1. For a more detailed features description, please refer to the manufacturer's specifications or the User's Manual.



2.

Channel List					
Channel	Frequency (MHz)	Channel	Frequency (MHz)	Channel	Frequency (MHz)
00	2402	27	2429	54	2456
01	2403	28	2430	55	2457
02	2404	29	2431	56	2458
03	2405	30	2432	57	2459
04	2406	31	2433	58	2460
05	2407	32	2434	59	2461
06	2408	33	2435	60	2462
07	2409	34	2436	61	2463
08	2410	35	2437	62	2464
09	2411	36	2438	63	2465
10	2412	37	2439	64	2466
11	2413	38	2440	65	2467
12	2414	39	2441	66	2468
13	2415	40	2442	67	2469
14	2416	41	2443	68	2470
15	2417	42	2444	69	2471
16	2418	43	2445	70	2472
17	2419	44	2446	71	2473
18	2420	45	2447	72	2474
19	2421	46	2448	73	2475
20	2422	47	2449	74	2476
21	2423	48	2450	75	2477
22	2424	49	2451	76	2478
23	2425	50	2452	77	2479
24	2426	51	2453	78	2480
25	2427	52	2454		
26	2428	53	2455		

3.

Table for Filed Antenna

Ant.	Brand	Model Name	Antenna Type	Connector	Gain (dBi)
1	-	-	Printed Antenna	N/A	1.78



3.2 DESCRIPTION OF TEST MODES

To investigate the maximum EMI emission characteristics generates from EUT, the test system was pre-scanning tested base on the consideration of following EUT operation mode or test configuration mode which possible have effect on EMI emission level. Each of these EUT operation mode(s) or test configuration mode(s) mentioned above was evaluated respectively.

Pretest Mode	Description
Mode 1	BT Link
Mode 2	TX Mode NOTE (1)
Mode 3	RX Mode NOTE (1)

The EUT system operated these modes were found to be the worst case during the pre-scanning test as Following:

For Conducted Emission	
Final Test Mode	Description
Mode 1	BT Link

For Radiated Emission	
Final Test Mode	Description
Mode 2	TX Mode NOTE (1)
Mode 3	RX Mode NOTE (1)

Note:

(1) The measurements are performed at the highest, middle, lowest available channels.

3.3 TABLE OF PARAMETERS OF TEXT SOFTWARE SETTING

During testing channel & power controlling software provided by the customer was used to control the operating channel as well as the output power level. The RF output power selection is for the setting of RF output power expected by the customer and is going to be fixed on the firmware of the final end product power parameters of FHSS

Test software Version	Test program: CSR BlueSuite		
Frequency	2402 MHz	2441 MHz	2480 MHz
Parameters-1Mbps	63	63	63
Parameters-3Mbps	100	100	100

3.4 BLOCK DIGRAM SHOWING THE CONFIGURATION OF SYSTEM TESTED

Conducted:

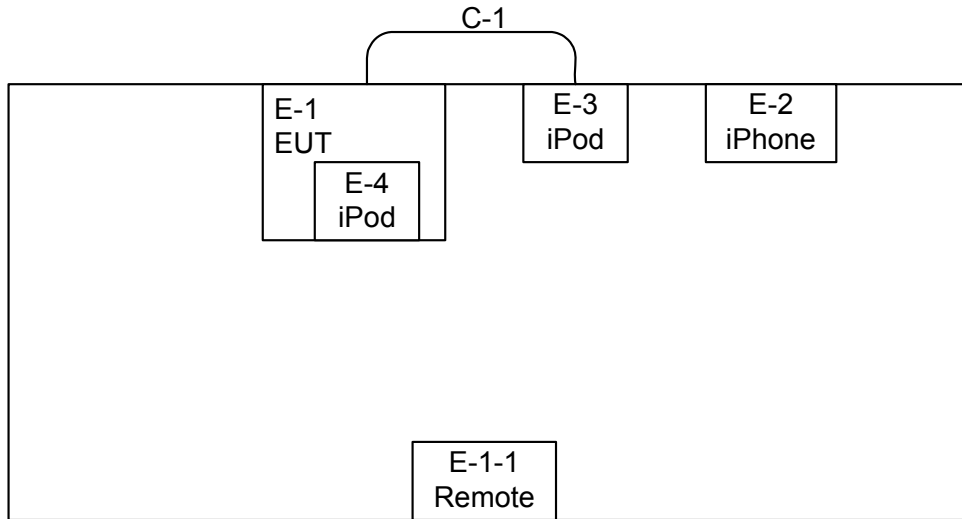

C-1: Audio Cable

Radiation TX Mode:

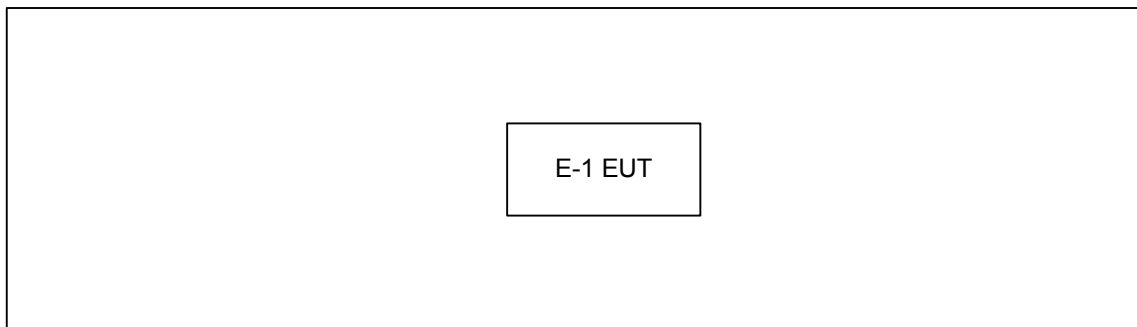



3.1 DESCRIPTION OF SUPPORT UNITS

The EUT has been tested as an independent unit together with other necessary accessories or support units. The following support units or accessories were used to form a representative test configuration during the tests.

Item	Equipment	Mfr/Brand	Model/Type No.	FCC ID/IC	Series No.	Note
E-1	Compact Stereo System	Panasonic	SC-HC05	ACJ-B21-R10004 216A-B21R10004	N/A	EUT
E-1-1	Remote	N/A	N/A	N/A	N/A	
E-2	iPhone	Apple	A1241	DOC	N/A	
E-3	iPod nano(8G)	Apple	A1320	DOC	YM945ZGJ72A	
E-4	iPod nano(8G)	Apple	A1366	DOC	C7RDRJSBDDVX	

Item	Shielded Type	Ferrite Core	Length	Note
C-1	YES	YES	1.8M	

Note:

- (1) The support equipment was authorized by Declaration of Confirmation.
- (2) For detachable type I/O cable should be specified the length in cm in 『Length』 column.



4. EMC EMISSION TEST

4.1 CONDUCTED EMISSION MEASUREMENT

4.1.1 POWER LINE CONDUCTED EMISSION Limits (Frequency Range 150KHz-30MHz)

FREQUENCY (MHz)	Class A (dBuV)		Class B (dBuV)		Standard
	Quasi-peak	Average	Quasi-peak	Average	
0.15 -0.5	79.00	66.00	66 - 56 *	56 - 46 *	CISPR
0.50 -5.0	73.00	60.00	56.00	46.00	CISPR
5.0 -30.0	73.00	60.00	60.00	50.00	CISPR

0.15 -0.5	79.00	66.00	66 - 56 *	56 - 46 *	FCC
0.50 -5.0	73.00	60.00	56.00	46.00	FCC
5.0 -30.0	73.00	60.00	60.00	50.00	FCC

Note:

- (1) The tighter limit applies at the band edges.
- (2) The limit of " * " marked band means the limitation decreases linearly with the logarithm of the frequency in the range.

4.1.2 MEASUREMENT INSTRUMENTS LIST AND SETTING

Item	Kind of Equipment	Manufacturer	Type No.	Serial No.	Calibrated until
1	LISN	EMCO	3816/2SH	00052766	May.26.2011
2	LISN	R&S	ENV216	100526	May.26.2011
3	Test Cable	N/A	C_19	N/A	Apr.26.2011
4	EMI TEST RECEIVER	R&S	ESCI	100895	May.27.2011
5	50Ω Terminator	SHX	TF2-3G-A	08122901	May.27.2011

Remark: " N/A" denotes No Model No. , Serial No. or No Calibration specified.

The following table is the setting of the receiver

Receiver Parameters	Setting
Attenuation	10 dB
Start Frequency	0.15 MHz
Stop Frequency	30 MHz
IF Bandwidth	9 kHz

4.1.3 TEST PROCEDURE

- The EUT was placed 0.8 meters from the horizontal ground plane with EUT being connected to the power mains through a line impedance stabilization network (LISN). All other support equipments powered from additional LISN(s). The LISN provide 50 Ohm/ 50uH of coupling impedance for the measuring instrument.
- Interconnecting cables that hang closer than 40 cm to the ground plane shall be folded back and forth in the center forming a bundle 30 to 40 cm long.
- I/O cables that are not connected to a peripheral shall be bundled in the center. The end of the cable may be terminated, if required, using the correct terminating impedance. The overall length shall not exceed 1 m.
- LISN at least 80 cm from nearest part of EUT chassis.
- For the actual test configuration, please refer to the related Item –EUT Test Photos.

4.1.4 DEVIATION FROM TEST STANDARD

No deviation

4.1.5 TEST SETUP

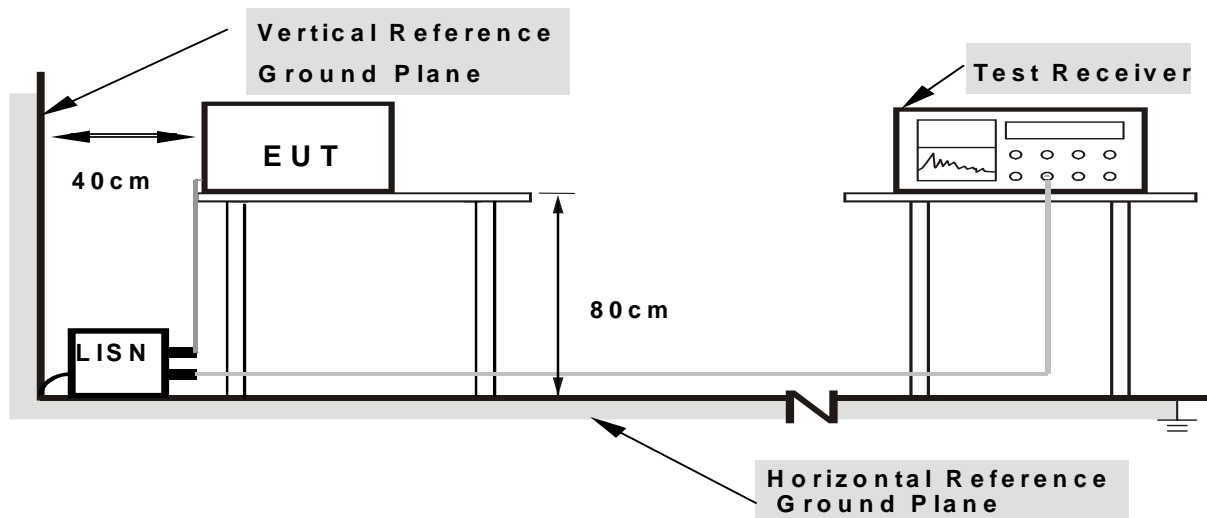

Note: 1. Support units were connected to second LISN.

2. Both of LISNs (AMN) are 80 cm from EUT and at least 80 cm from other units and other metal planes

4.1.6 EUT OPERATING CONDITIONS

The EUT was configured for testing in a typical fashion (as a customer would normally use it). The EUT has been programmed to continuously transmit during test. This operating condition was tested and used to collect the included data.



4.1.7 TEST RESULTS

EUT :	Compact Stereo System	Model Name :	SC-HC05
Temperature :	21 °C	Relative Humidity :	50 %
Pressure :	1010hPa	Test Power :	AC 120V/60Hz
Test Mode :	BT Link		

Freq. (MHz)	Terminal L/N	Measured(dBuV)		Limits(dBuV)		Margin (dB)	Note
		QP-Mode	AV-Mode	QP-Mode	AV-Mode		
0.15	Line	62.84	44.24	66.00	56.00	-3.16	(QP)
0.17	Line	62.16	38.92	64.80	54.80	-2.64	(QP)
0.20	Line	60.40	36.80	63.58	53.58	-3.18	(QP)
0.38	Line	44.30	*	58.19	48.19	-13.89	(QP)
0.74	Line	33.54	*	56.00	46.00	-22.46	(QP)
1.15	Line	31.50	*	56.00	46.00	-24.50	(QP)

Remark

- (1) All readings are QP Mode value unless otherwise stated AVG in column of 'Note'. If the QP Mode Measured value compliance with the QP Limits and lower than AVG Limits, the EUT shall be deemed to meet both QP & AVG Limits and then only QP Mode was measured, but AVG Mode didn't perform. In this case, a "*" marked in AVG Mode column of Interference Voltage Measured.
- (2) Measuring frequency range from 150KHz to 30MHz.

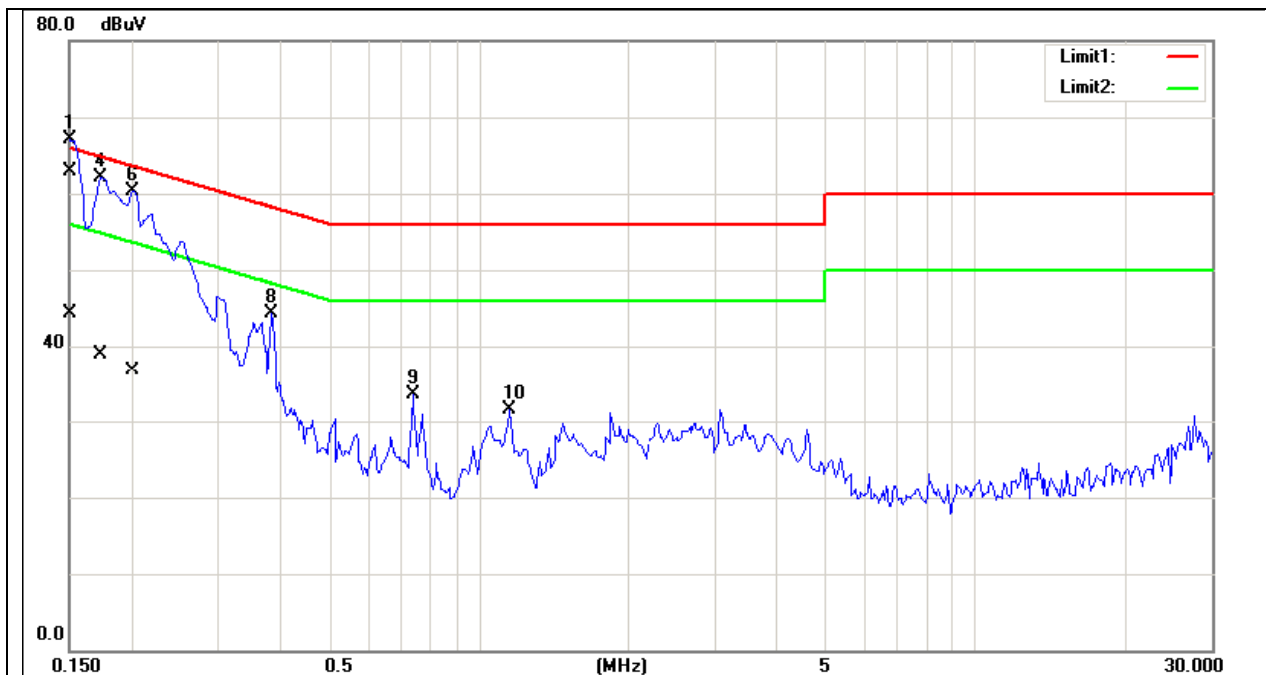



EUT :	Compact Stereo System	Model Name :	SC-HC05
Temperature :	21 °C	Relative Humidity :	50 %
Pressure :	1010hPa	Test Power :	AC 120V/60Hz
Test Mode :	BT Link		

Freq. (MHz)	Terminal L/N	Measured(dBuV)		Limits(dBuV)		Margin (dB)	Note
		QP-Mode	AV-Mode	QP-Mode	AV-Mode		
0.15	Neutral	63.08	43.48	66.00	56.00	-2.92	(QP)
0.17	Neutral	62.32	38.75	64.80	54.80	-2.48	(QP)
0.20	Neutral	59.95	36.19	63.58	53.58	-3.63	(QP)
0.25	Neutral	53.70	31.99	61.70	51.70	-8.00	(QP)
0.38	Neutral	45.03	*	58.18	48.18	-13.15	(QP)
0.74	Neutral	32.67	*	56.00	46.00	-23.33	(QP)

Remark

- (1) All readings are QP Mode value unless otherwise stated AVG in column of 'Note'. If the QP Mode Measured value compliance with the QP Limits and lower than AVG Limits, the EUT shall be deemed to meet both QP & AVG Limits and then only QP Mode was measured, but AVG Mode didn't perform. In this case, a "*" marked in AVG Mode column of Interference Voltage Measured.
- (2) Measuring frequency range from 150KHz to 30MHz.

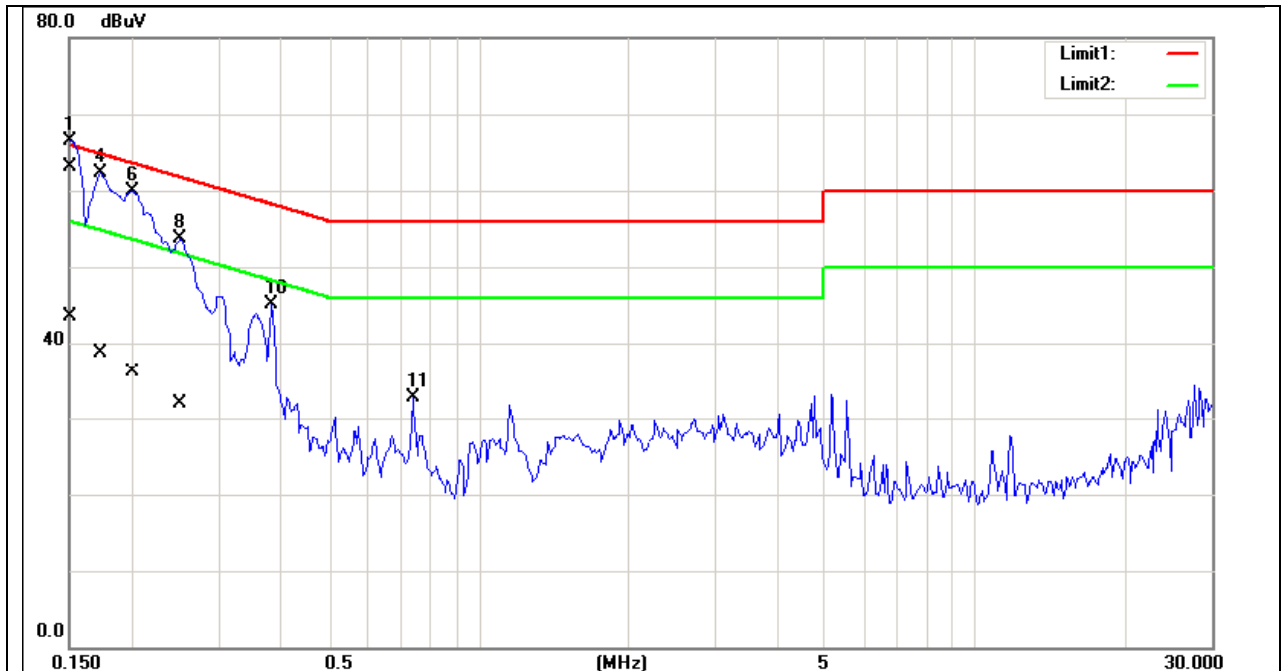



4.2 RADIATED EMISSION MEASUREMENT

4.2.1 RADIATED EMISSION LIMITS (Frequency Range 9kHz-1000MHz)

20dBc in any 100 kHz bandwidth outside the operating frequency band. In case the emission fall within the restricted band specified on 15.205(a), then the 15.209(a) limit in the table below has to be followed.

Frequencies (MHz)	Field Strength (micorvolts/meter)	Measurement Distance (meters)
0.009~0.490	2400/F(KHz)	300
0.490~1.705	24000/F(KHz)	30
1.705~30.0	30	30
30~88	100	3
88~216	150	3
216~960	200	3
Above 960	500	3

LIMITS OF RADIATED EMISSION MEASUREMENT (Above 1000MHz)

FREQUENCY (MHz)	(dBuV/m) (at 3M)	
	PEAK	AVERAGE
Above 1000	74	54

Notes:

- (1) The limit for radiated test was performed according to FCC PART 15C.
- (2) The tighter limit applies at the band edges.
- (3) Emission level (dBuV/m)=20log Emission level (uV/m).

FREQUENCY RANGE OF RADIATED MEASUREMENT (For unintentional radiators)

Highest frequency generated or Upper frequency of measurement used in the device or on which the device operates or tunes (MHz)	Range (MHz)
Below 1.705	30
1.705 – 108	1000
108 – 500	2000
500 – 1000	5000
Above 1000	5 th harmonic of the highest frequency or 40 GHz, whichever is lower



4.2.2 MEASUREMENT INSTRUMENTS LIST AND SETTING

Item	Kind of Equipment	Manufacturer	Type No.	Serial No.	Calibrated until
1	Horn Antenna	ETS	3115	00075789	May.12.2011
2	Amplifier	Agilent	8449B	3008A02274	May.26.2011
3	Spectrum	Agilent	E4408B	US39240143	Nov.15.2011
4	Test Cable	HUBER+SUHNER	CB03 High Fre	N/A	May.03.2011
5	Bi-log Antenna	Schwarbeck	VULB9160	9160-3232	May.26.2011
6	Amplifier	HP	8447D	2944A09673	May.26.2011
7	Test Receiver	R&S	ESCI	100895	May.26.2011
8	Test Cable	N/A	C-01_CB03	N/A	Jul.05.2011
9	Controller	CT	SC100	N/A	N/A
10	Triple Loop Antenna	R&S	HFH2-Z2	830749/020	May.27.2011
11	Broad-Band Horn Antenna	Schwarzbeck	BBHA 9170	9170319	May.12.2011

Remark: " N/A" denotes No Model Name / Serial No. and No Calibration specified.

Spectrum Parameter	Setting
Attenuation	Auto
Start Frequency	1000 MHz
Stop Frequency	10th carrier harmonic
RB / VB (emission in restricted band)	1 MHz / 1 MHz for Peak, 1 MHz / 10Hz for Average

Receiver Parameter	Setting
Attenuation	Auto
Start ~ Stop Frequency	9kHz~150kHz / RB 200Hz for QP
Start ~ Stop Frequency	150kHz~30MHz / RB 9kHz for QP
Start ~ Stop Frequency	30MHz~1000MHz / RB 120kHz for QP



4.2.3 TEST PROCEDURE

- a. The measuring distance of at 3 m shall be used for measurements at frequency up to 1GHz. For frequencies above 1GHz, any suitable measuring distance may be used.
- b. The EUT was placed on the top of a rotating table 0.8 meters above the ground at a 3 meter semi-anechoic chamber. The table was rotated 360 degrees to determine the position of the highest radiation.
- c. The height of the equipment or of the substitution antenna shall be 0.8 m; the height of the test antenna shall vary between 1 m to 4 m. Both horizontal and vertical polarizations of the antenna are set to make the measurement.
- d. The initial step in collecting conducted emission data is a spectrum analyzer peak detector mode pre-scanning the measurement frequency range. Significant peaks are then marked and then Quasi Peak detector mode re-measured.
- e. If the Peak Mode measured value compliance with and lower than Quasi Peak Mode Limit, the EUT shall be deemed to meet QP Limits and then no additional QP Mode measurement performed.
- f. For the actual test configuration, please refer to the related Item –EUT Test Photos.

4.2.4 DEVIATION FROM TEST STANDARD

No deviation

4.2.5 TEST SETUP

(A) Radiated Emission Test Set-Up Frequency Below 1 GHz

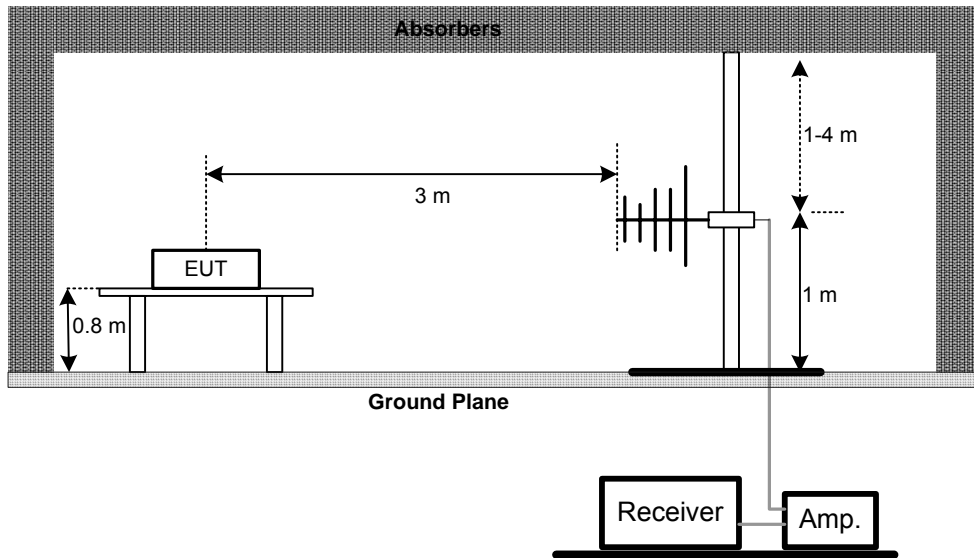

(B) Radiated Emission Test Set-Up Frequency Above 1 GHz

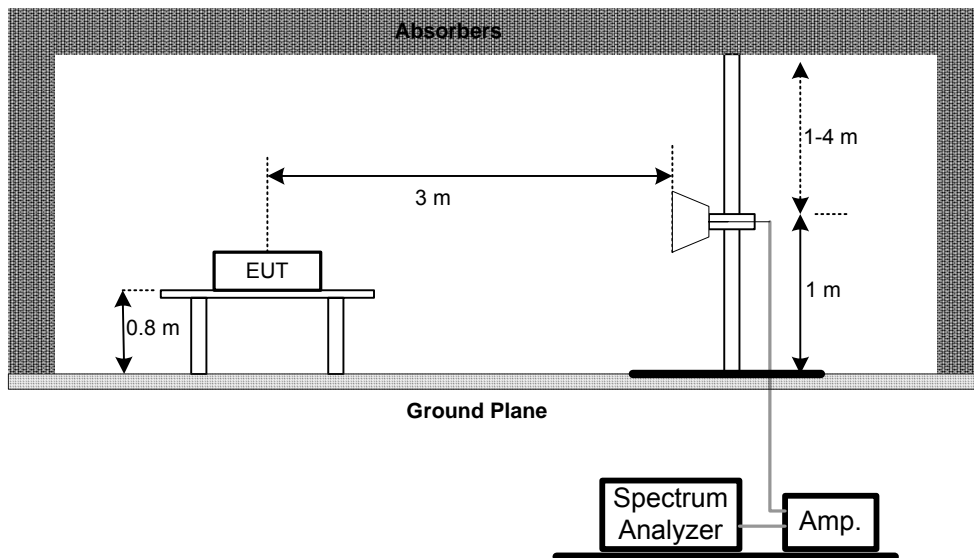

(C) For radiated emissions below 30MHz

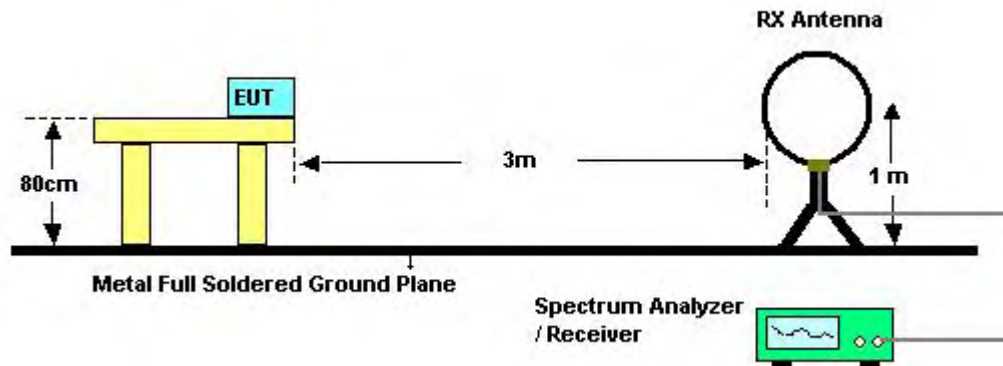

4.2.6 EUT OPERATING CONDITIONS

The EUT tested system was configured as the statements of 4.1.6 Unless otherwise a special operating condition is specified in the follows during the testing.



4.2.7 TEST RESULTS (BELOW 30MHZ)

EUT :	Compact Stereo System	Model Name :	SC-HC05
Temperature :	23 °C	Relative Humidity :	58 %
Pressure :	1010 Pa	Test Voltage :	AC 120V/60HZ
Test Mode :	TX 2402MHz –CH00-1Mbps		

Freq. (MHz)	Ant. 0°/90°	Reading(RA) (dBuV)	Corr.Factor(CF) (dB)	Measured(FS) (dBuV/m)	Limits(QP) (dBuV/m)	Margin (dB)	Note
0.03	0°	100.14	23.98	76.16	119.64	-43.48	PK
0.04	0°	86.31	23.29	63.02	116.48	-53.46	PK
0.22	0°	96.03	20.46	75.57	100.84	-25.27	PK
0.37	0°	89.71	20.12	69.59	96.31	-26.72	PK
1.03	0°	69.61	19.60	50.01	67.39	-17.38	PK
3.69	0°	39.69	18.97	20.72	69.54	-48.82	PK

Freq. (MHz)	Ant. 0°/90°	Reading(RA) (dBuV)	Corr.Factor(CF) (dB)	Measured(FS) (dBuV/m)	Limits(QP) (dBuV/m)	Margin (dB)	Note
0.01	90°	98.64	24.30	74.34	125.33	-50.99	PK
0.06	90°	91.32	22.12	69.20	111.48	-42.28	PK
0.09	90°	100.03	21.66	78.37	108.81	-30.44	PK
0.17	90°	89.26	20.57	68.69	103.15	-34.46	PK
0.94	90°	67.06	19.83	47.23	68.11	-20.88	PK
1.03	90°	59.31	19.60	39.71	67.39	-27.68	PK

Remark :

- (1) The amplitude of spurious emissions which are attenuated by more than 20 dB below the permissible value has no need to be reported ◦
- (2) Distance extrapolation factor = 40 log (specific distance / test distance) (dB); ◦
- (3) Limit line = specific limits (dBuV) + distance extrapolation factor. ◦



4.2.8 TEST RESULTS (BETWEEN 30 – 1000 MHZ)

EUT :	Compact Stereo System	Model Name :	SC-HC05
Temperature :	23 °C	Relative Humidity :	58 %
Pressure :	1010 hPa	Test Voltage :	AC 120V/60HZ
Test Mode :	TX 2402MHz –CH00-1Mbps		

Freq. (MHz)	Ant. H/V	Reading(RA) (dBuV)	Corr.Factor(CF) (dB)	Measured(FS) (dBuV/m)	Limits(QP) (dBuV/m)	Margin (dB)	Note
128.69	V	44.58	-13.15	31.43	43.50	- 12.07	
198.25	V	43.25	-12.63	30.62	43.50	- 12.88	
312.20	V	40.21	-9.91	30.30	46.00	- 15.70	
609.25	V	34.85	-4.03	30.82	46.00	- 15.18	
687.50	V	31.21	-3.26	27.95	46.00	- 18.05	
822.01	V	31.87	-2.09	29.78	46.00	- 16.22	

Remark :

- (1) Reading in which marked as QP or Peak means measurements by using are Quasi-Peak Mode or Peak Mode with Detector BW=120KHz ; SPA setting in RBW=120KHz, VBW =120KHz, Swp. Time = 0.3 sec./MHz ◦
- (2) All readings are Peak unless otherwise stated QP in column of 『Note』 . Peak denotes that the Peak reading compliance with the QP Limits and then QP Mode measurement didn't perform ◦
- (3) Measuring frequency range from 30MHz to 1000MHz ◦
- (4) If the peak scan value lower limit more than 20dB, then this signal data does not show in table ◦

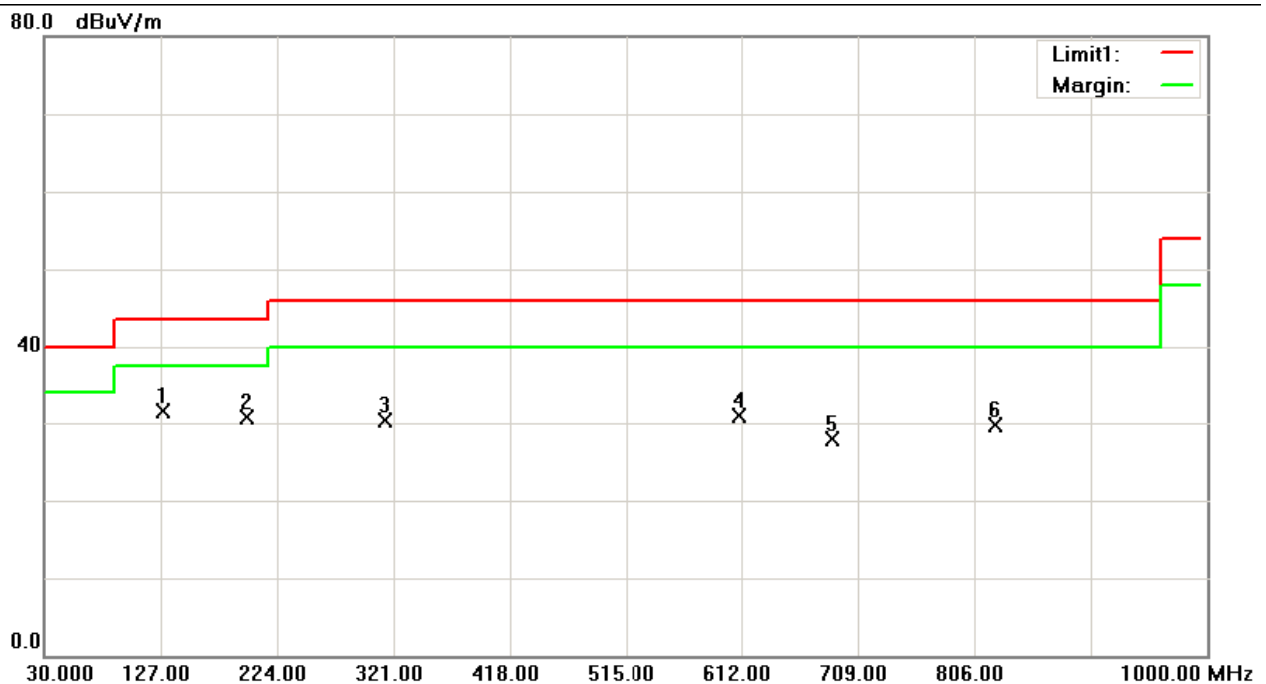



EUT :	Compact Stereo System	Model Name :	SC-HC05
Temperature :	23 °C	Relative Humidity :	58 %
Pressure :	1010 hPa	Test Voltage :	AC 120V/60HZ
Test Mode :	TX 2402MHz –CH00-1Mbps		

Freq. (MHz)	Ant. H/V	Reading(RA) (dBuV)	Corr.Factor(CF) (dB)	Measured(FS) (dBuV/m)	Limits(QP) (dBuV/m)	Margin (dB)	Note
225.36	H	42.36	-12.43	29.93	46.00	- 16.07	
318.97	H	41.87	-9.79	32.08	46.00	- 13.92	
426.81	H	38.99	-8.05	30.94	46.00	- 15.06	
569.87	H	32.52	-4.57	27.95	46.00	- 18.05	
687.66	H	34.10	-3.26	30.84	46.00	- 15.16	
812.03	H	34.38	-2.15	32.23	46.00	- 13.77	

Remark :

- (1) Reading in which marked as QP or Peak means measurements by using are Quasi-Peak Mode or Peak Mode with Detector BW=120KHz ; SPA setting in RBW=120KHz, VBW =120KHz, Swp. Time = 0.3 sec./MHz ◦
- (2) All readings are Peak unless otherwise stated QP in column of 『Note』 . Peak denotes that the Peak reading compliance with the QP Limits and then QP Mode measurement didn't perform ◦
- (3) Measuring frequency range from 30MHz to 1000MHz ◦
- (4) If the peak scan value lower limit more than 20dB, then this signal data does not show in table ◦

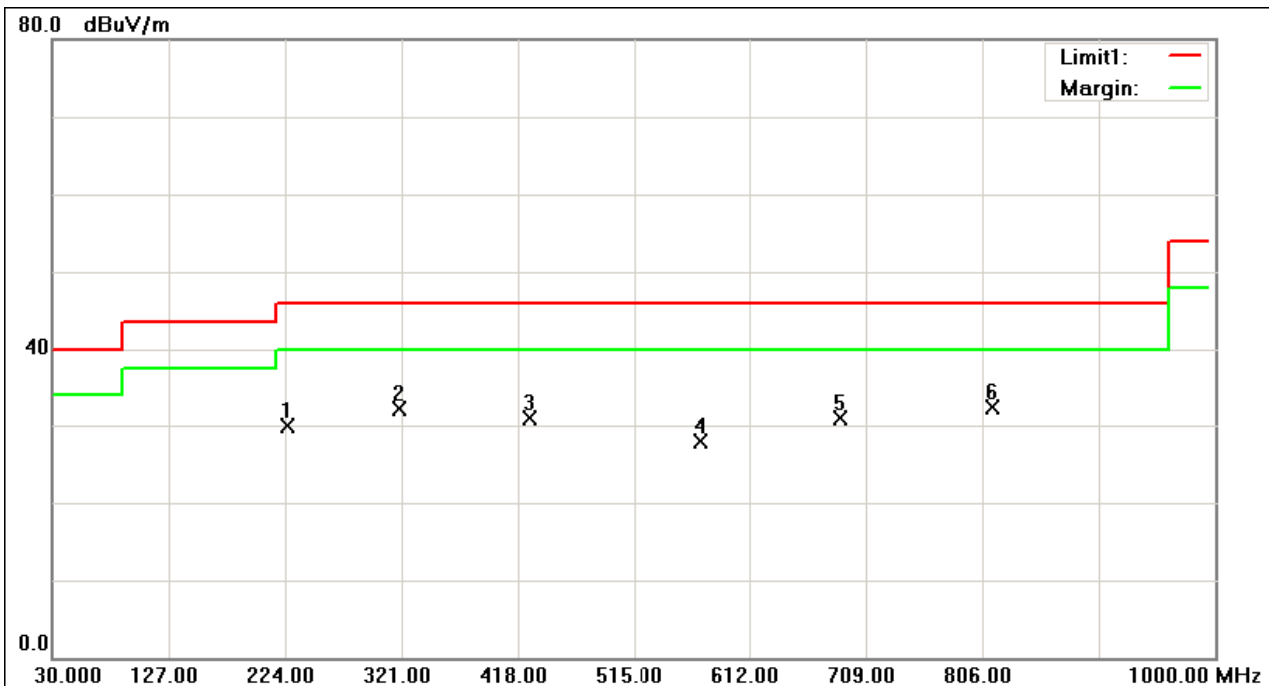



EUT :	Compact Stereo System	Model Name :	SC-HC05
Temperature :	23 °C	Relative Humidity :	58 %
Pressure :	1010 hPa	Test Voltage :	AC 120V/60HZ
Test Mode :	RX Mode 2402MHz-1Mbps		

Freq. (MHz)	Ant. H/V	Reading(RA) (dBuV)	Corr.Factor(CF) (dB)	Measured(FS) (dBuV/m)	Limits(QP) (dBuV/m)	Margin (dB)	Note
51.83	V	46.77	-17.51	29.26	40.00	- 10.74	
90.63	V	47.80	-19.00	28.80	43.50	- 14.70	
250.68	V	46.77	-14.51	32.26	46.00	- 13.74	
500.45	V	43.15	-7.34	35.81	46.00	- 10.19	
628.98	V	37.01	-3.73	33.28	46.00	- 12.72	
750.23	V	41.41	-2.56	38.85	46.00	- 7.15	

Remark :

- (1) Reading in which marked as QP or Peak means measurements by using are Quasi-Peak Mode or Peak Mode with Detector BW=120KHz ; SPA setting in RBW=120KHz, VBW =120KHz, Swp. Time = 0.3 sec./MHz ◦
- (2) All readings are Peak unless otherwise stated QP in column of 『Note』 . Peak denotes that the Peak reading compliance with the QP Limits and then QP Mode measurement didn't perform ◦
- (3) Measuring frequency range from 30MHz to 1000MHz ◦
- (4) If the peak scan value lower limit more than 20dB, then this signal data does not show in table ◦

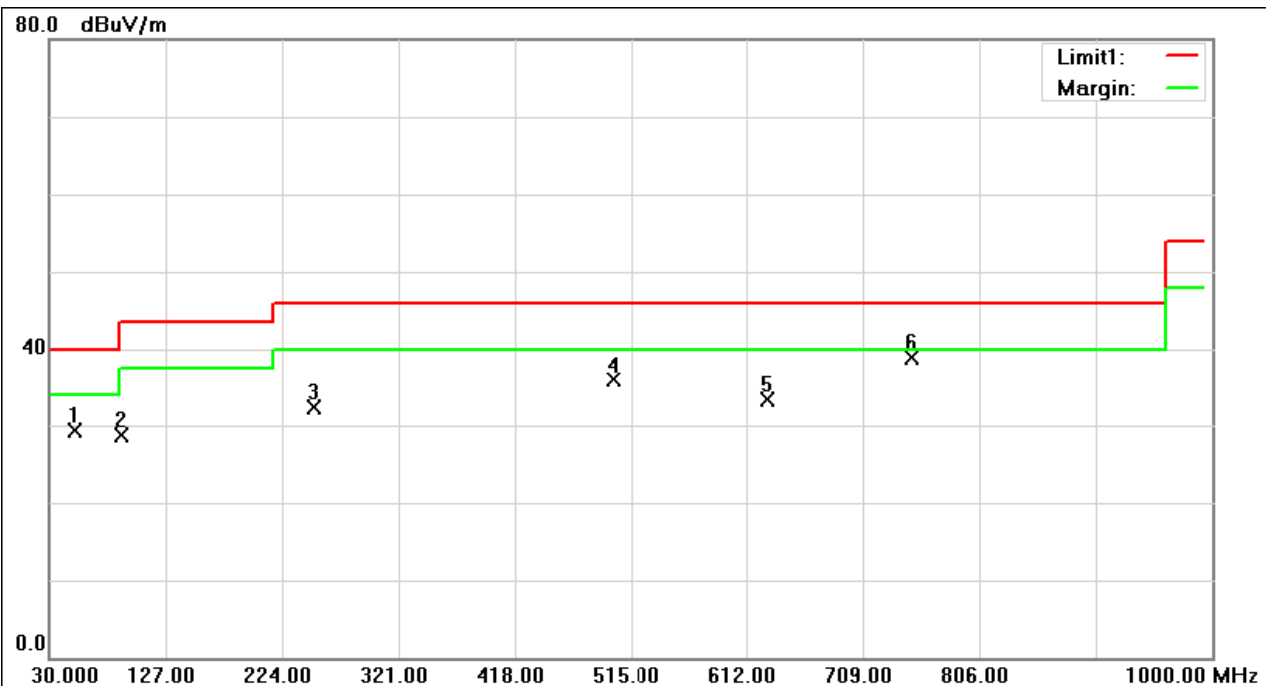



EUT :	Compact Stereo System	Model Name :	SC-HC05
Temperature :	23 °C	Relative Humidity :	58 %
Pressure :	1010 hPa	Test Voltage :	AC 120V/60HZ
Test Mode :	RX Mode 2402MHz-1Mbps		

Freq. (MHz)	Ant. H/V	Reading(RA) (dBuV)	Corr.Factor(CF) (dB)	Measured(FS) (dBuV/m)	Limits(QP) (dBuV/m)	Margin (dB)	Note
124.58	H	43.76	-18.20	25.56	43.50	- 17.94	
250.68	H	45.01	-14.51	30.50	46.00	- 15.50	
384.05	H	39.89	-9.60	30.29	46.00	- 15.71	
500.45	H	44.25	-7.34	36.91	46.00	- 9.09	
631.40	H	40.35	-3.68	36.67	46.00	- 9.33	
750.23	H	39.60	-2.56	37.04	46.00	- 8.96	

Remark :

- (1) Reading in which marked as QP or Peak means measurements by using are Quasi-Peak Mode or Peak Mode with Detector BW=120KHz ; SPA setting in RBW=120KHz, VBW =120KHz, Swp. Time = 0.3 sec./MHz ◦
- (2) All readings are Peak unless otherwise stated QP in column of 『Note』 . Peak denotes that the Peak reading compliance with the QP Limits and then QP Mode measurement didn't perform ◦
- (3) Measuring frequency range from 30MHz to 1000MHz ◦
- (4) If the peak scan value lower limit more than 20dB, then this signal data does not show in table ◦

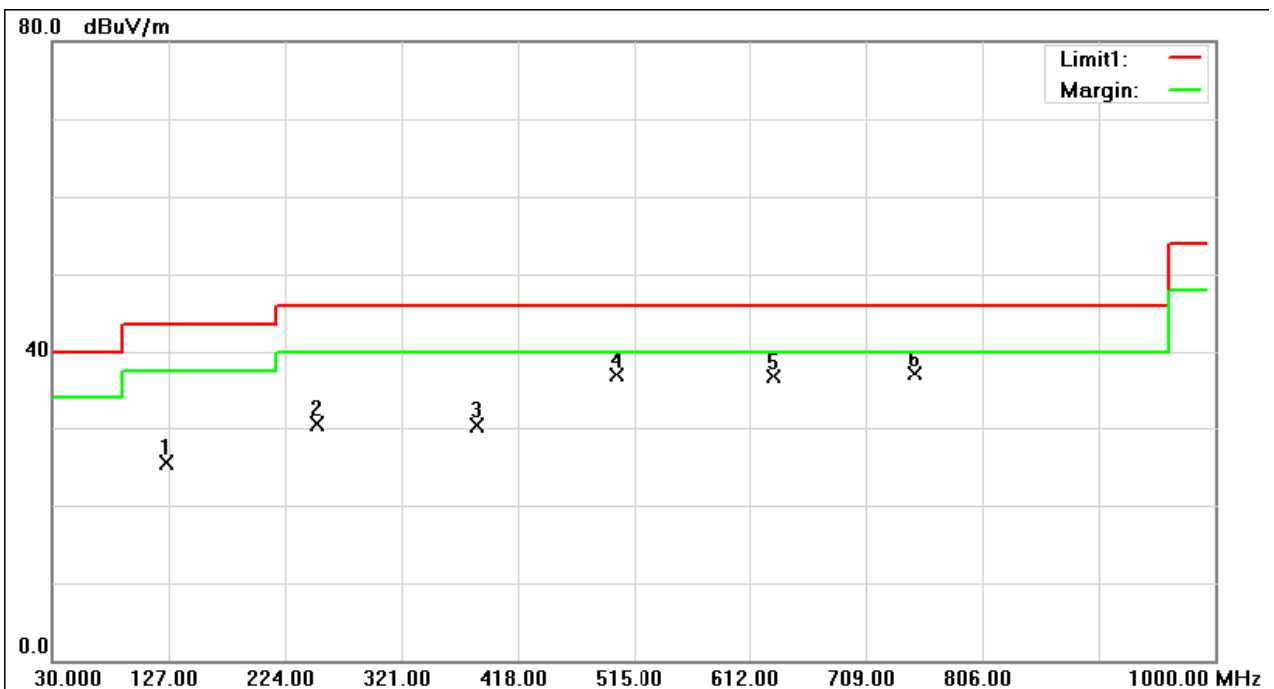



4.2.9 TEST RESULTS (ABOVE 1000 MHZ)

EUT :	Compact Stereo System	Model Name :	SC-HC05
Temperature :	23 °C	Relative Humidity :	58 %
Pressure :	1010 hPa	Test Voltage :	AC 120V/60HZ
Test Mode :	TX 2402MHz – CH 00-1Mbps		

Freq. (MHz)	Ant.Pol. H/V	Reading		Ant./CF CF(dB)	Act.		Limit		Note
		Peak (dBuV)	AV (dBuV)		Peak (dBuV/m)	AV (dBuV/m)	Peak (dBuV/m)	AV (dBuV/m)	
2390.00	V	20.90	10.44	31.91	52.81	42.35	74.00	54.00	X/E
2402.20	V	62.42	28.01	31.90	94.32	59.91			X/F
4804.45	V	41.26	32.50	6.17	47.43	38.67	74.00	54.00	X/H

Remark :

- (1) All readings are Peak unless otherwise stated QP in column of 『Note』 . Peak denotes that the Peak reading compliance with the QP Limits and then QP Mode measurement didn't perform ◦
- (2) Measuring frequency range from 30MHz to 1000MHz or the 10th harmonic of highest fundamental frequency ◦“F” denotes fundamental frequency; “H” denotes spurious frequency. “E” denotes band edge frequency. (This judgment method includes the Band Edge Requirement.)
- (3) Radiated emissions measured in frequency range above 1000MHz were made with an instrument using Peak detector mode and AV detector mode of the emission ◦
- (4) Data of measurement within this frequency range shown “ * ” in the table above means the reading of emissions are attenuated more than 20dB below the permissible limits or the field strength is too small to be measured.
- (5) A preamp and high pass filter were used for this test in order to provide sufficient measurement sensitivity.
- (6) EUT Orthogonal Axis :
“X” - denotes Laid on Table ; “Y” - denotes Vertical Stand ; “Z” - denotes Side Stand
- (7) During the measurements above 1 GHz it is taken care of that the EUT is always within the 3 dB cone of radiation BW of the used antenna



TX CH00(Above 1000 MHz, Vertical)

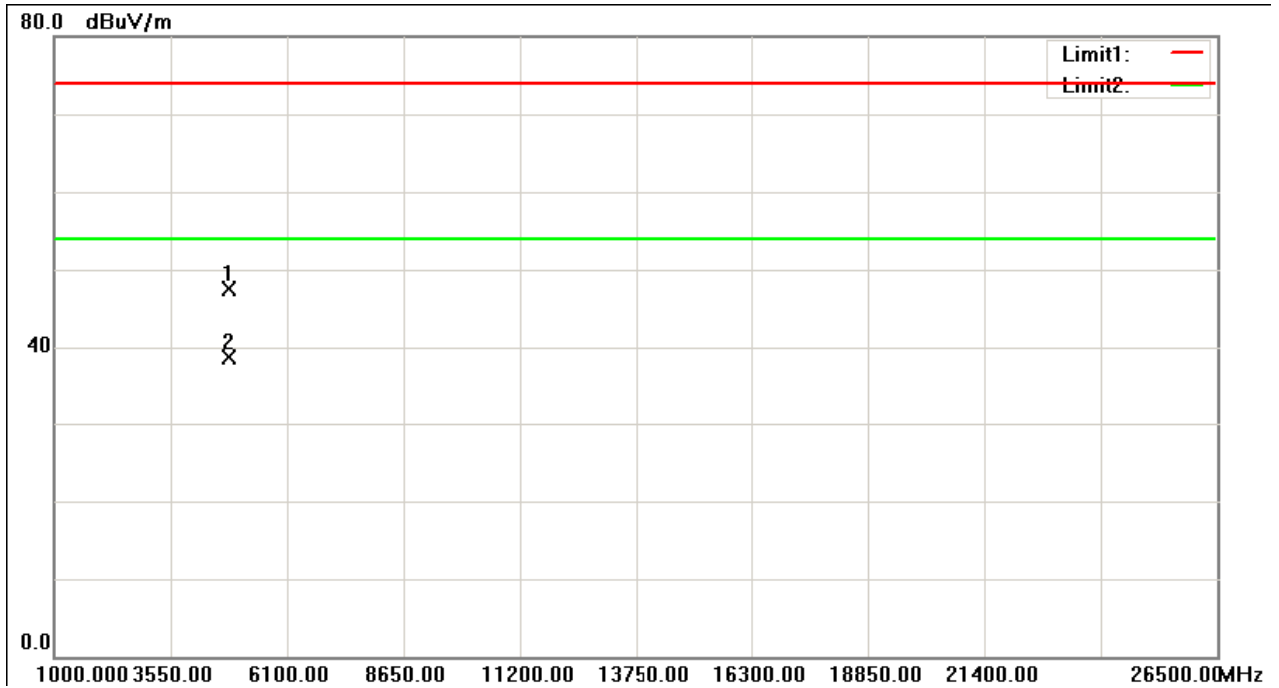
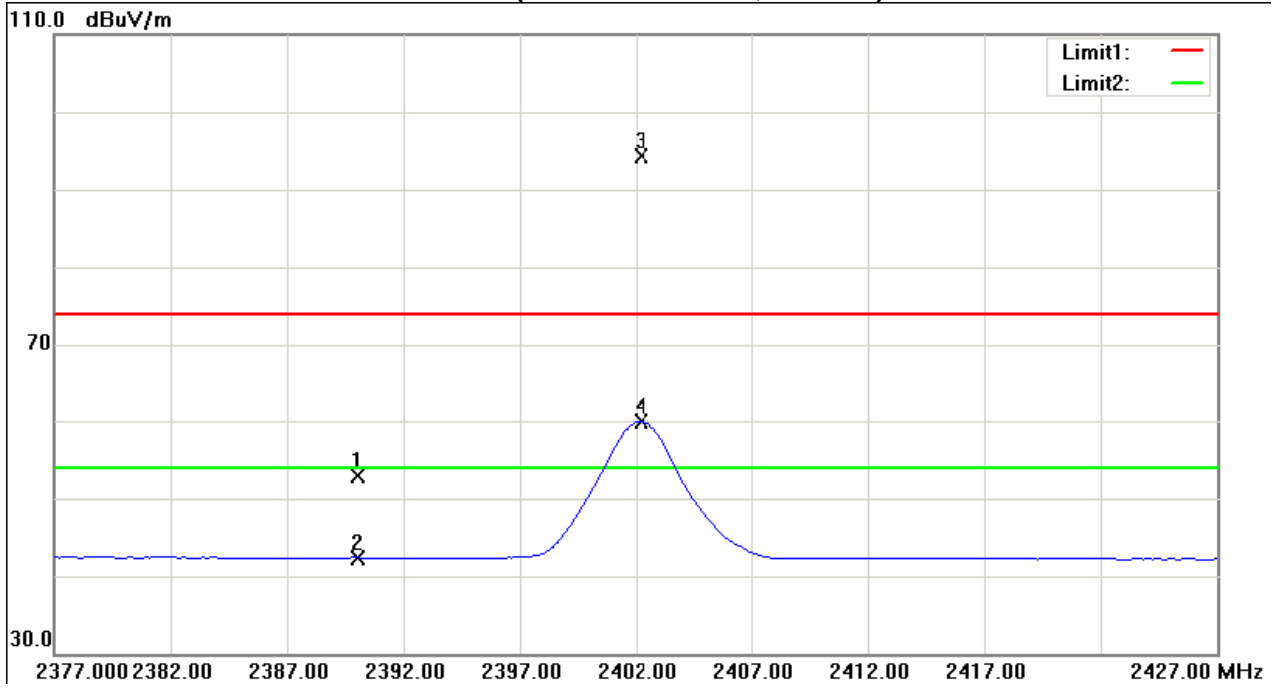



EUT :	Compact Stereo System	Model Name :	SC-HC05
Temperature :	23 °C	Relative Humidity :	58 %
Pressure :	1010hPa	Test Voltage :	AC 120V/60HZ
Test Mode :	TX 2402MHz – CH 00-1Mbps		

Freq. (MHz)	Ant.Pol. H/V	Reading		Ant./CF CF(dB)	Act.		Limit		Note
		Peak (dBuV)	AV (dBuV)		Peak (dBuV/m)	AV (dBuV/m)	Peak (dBuV/m)	AV (dBuV/m)	
2390.00	H	21.48	10.47	31.91	53.39	42.38	74.00	54.00	X/E
2402.10	H	68.43	30.75	31.90	100.33	62.65			X/F
4804.45	H	43.11	34.20	6.17	49.28	40.37	74.00	54.00	X/H

Remark :

- (1) All readings are Peak unless otherwise stated QP in column of 『Note』 . Peak denotes that the Peak reading compliance with the QP Limits and then QP Mode measurement didn't perform ◦
- (2) Measuring frequency range from 30MHz to 1000MHz or the 10th harmonic of highest fundamental frequency ◦ “F” denotes fundamental frequency; “H” denotes spurious frequency. “E” denotes band edge frequency. (This judgment method includes the Band Edge Requirement.)
- (3) Radiated emissions measured in frequency range above 1000MHz were made with an instrument using Peak detector mode and AV detector mode of the emission ◦
- (4) Data of measurement within this frequency range shown “ * ” in the table above means the reading of emissions are attenuated more than 20dB below the permissible limits or the field strength is too small to be measured.
- (5) A preamp and high pass filter were used for this test in order to provide sufficient measurement sensitivity.
- (6) EUT Orthogonal Axis :
“X” - denotes Laid on Table ; “Y” - denotes Vertical Stand ; “Z” - denotes Side Stand
- (7) During the measurements above 1 GHz it is taken care of that the EUT is always within the 3 dB cone of radiation BW of the used antenna



TX CH00(Above 1000 MHz, Horizontal)

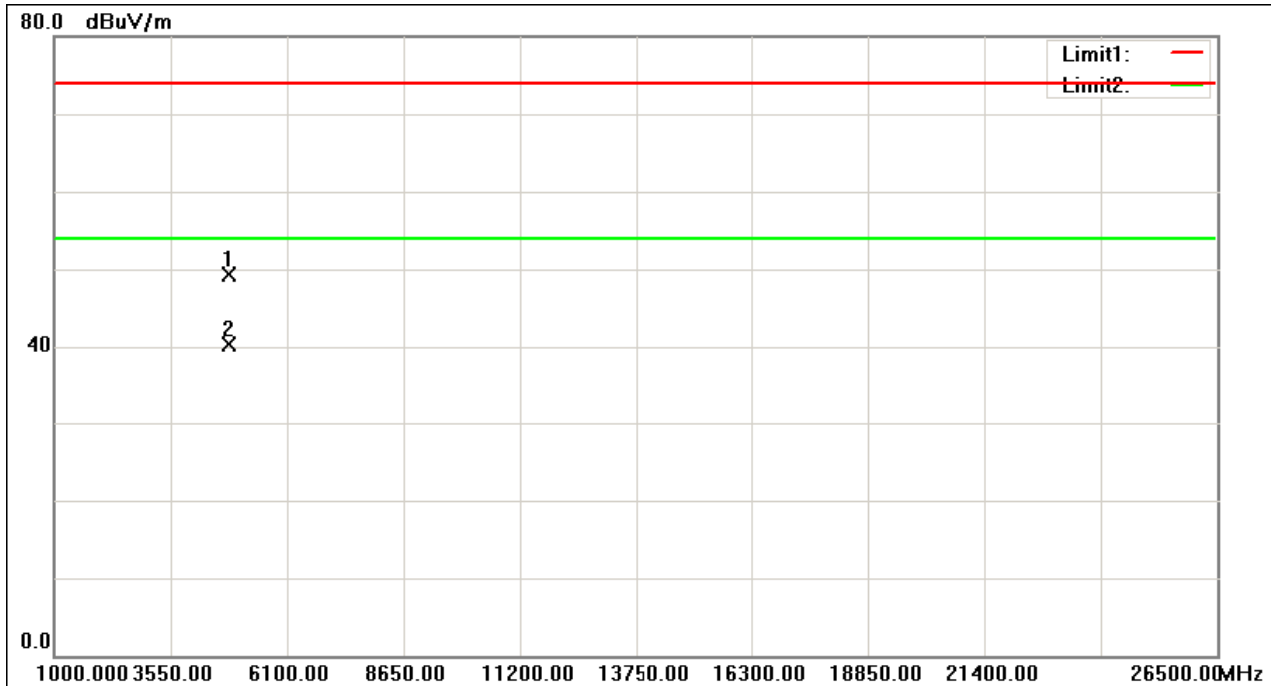
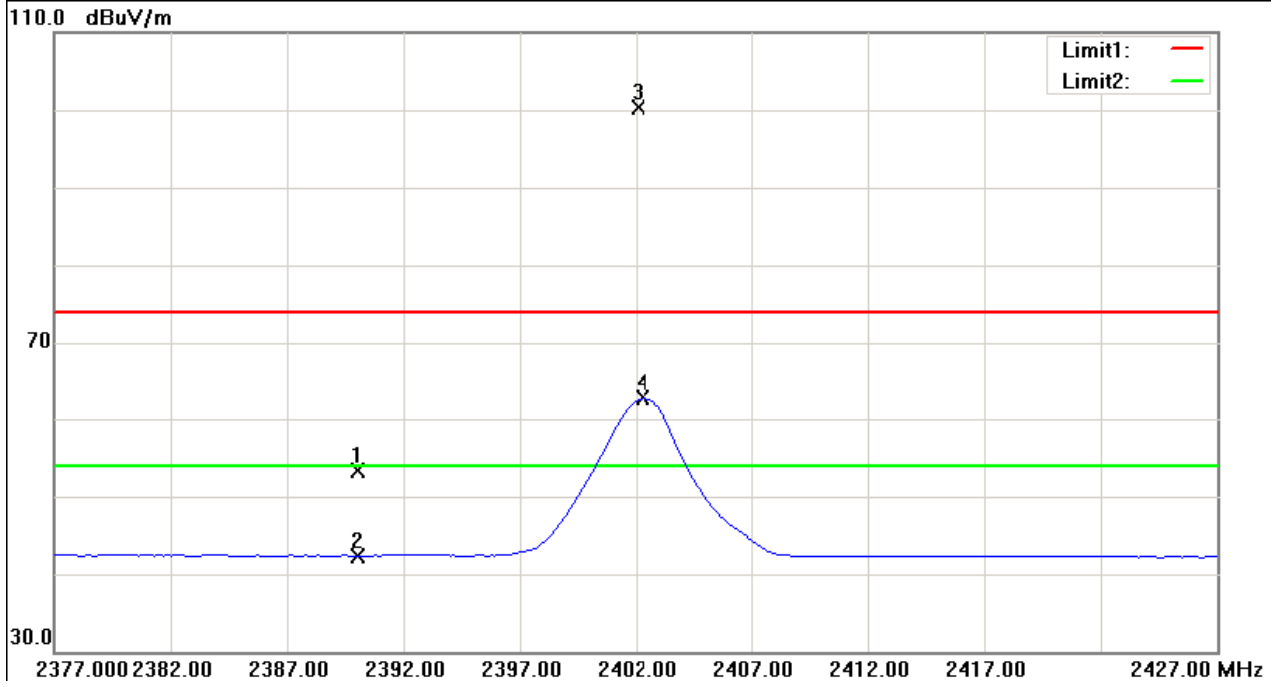



EUT :	Compact Stereo System	Model Name :	SC-HC05
Temperature :	23 °C	Relative Humidity :	58 %
Pressure :	1010 hPa	Test Voltage :	AC 120V/60HZ
Test Mode :	TX 2441MHz –CH39-1Mbps		

Freq.	Ant.Pol.	Reading		Ant./CF	Act.		Limit		Note
		Peak	AV		Peak	AV	Peak	AV	
(MHz)	H/V	(dBuV)	(dBuV)	CF(dB)	(dBuV/m)	(dBuV/m)	(dBuV/m)	(dBuV/m)	
2441.10	V	63.47	28.21	31.85	95.32	60.06			X/F
4882.53	V	38.98	30.02	6.46	45.44	36.48	74.00	54.00	X/H

Remark :

- (1) All readings are Peak unless otherwise stated QP in column of 『Note』 . Peak denotes that the Peak reading compliance with the QP Limits and then QP Mode measurement didn't perform ◦
- (2) Measuring frequency range from 30MHz to 1000MHz or the 10th harmonic of highest fundamental frequency ◦ “F” denotes fundamental frequency; “H” denotes spurious frequency. “E” denotes band edge frequency. (This judgment method includes the Band Edge Requirement.)
- (3) Radiated emissions measured in frequency range above 1000MHz were made with an instrument using Peak detector mode and AV detector mode of the emission ◦
- (4) Data of measurement within this frequency range shown “ * ” in the table above means the reading of emissions are attenuated more than 20dB below the permissible limits or the field strength is too small to be measured.
- (5) A preamp and high pass filter were used for this test in order to provide sufficient measurement sensitivity.
- (6) EUT Orthogonal Axis :
 “X” - denotes Laid on Table ; “Y” - denotes Vertical Stand ; “Z” - denotes Side Stand
- (7) During the measurements above 1 GHz it is taken care of that the EUT is always within the 3 dB cone of radiation BW of the used antenna



TX CH39 (Above 1000 MHz, Vertical)

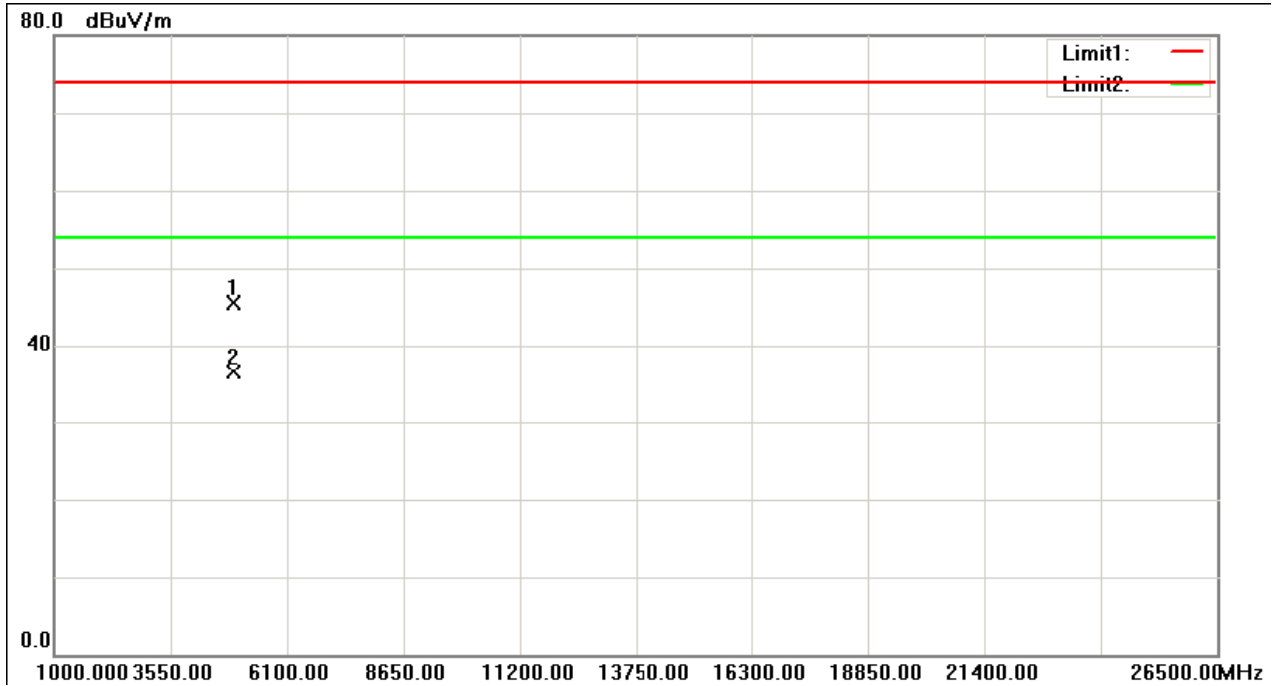
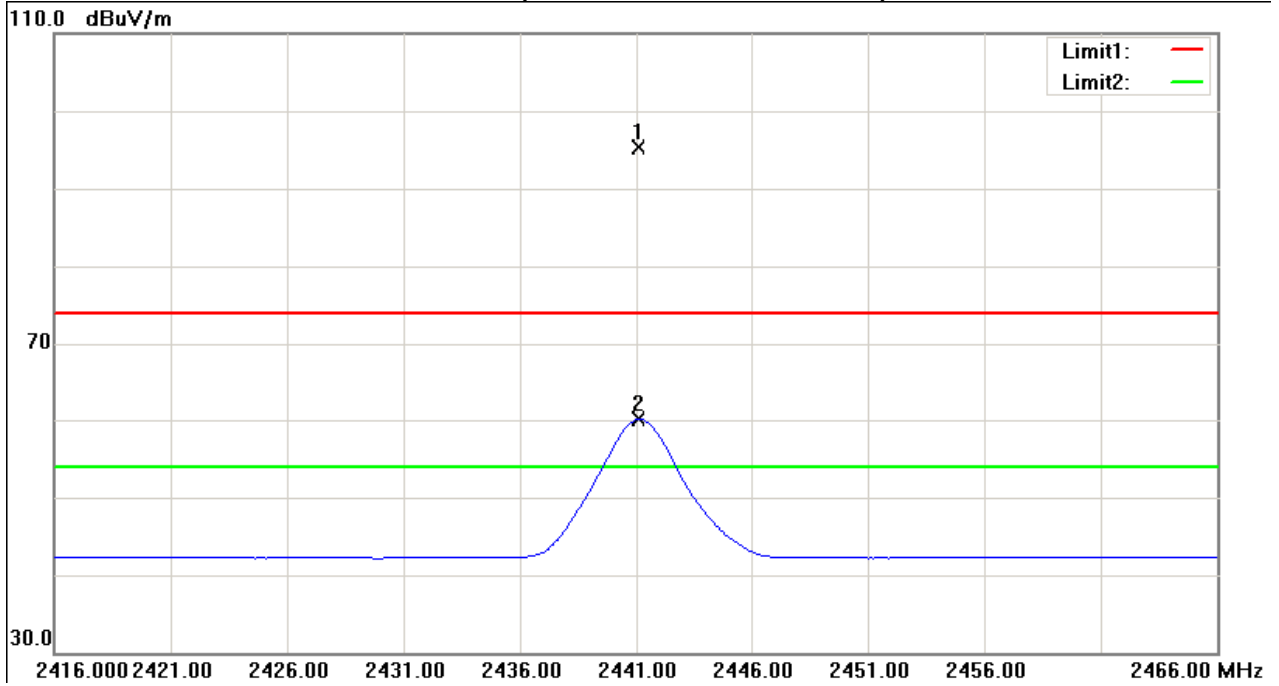



EUT :	Compact Stereo System	Model Name :	SC-HC05
Temperature :	23 °C	Relative Humidity :	58 %
Pressure :	1010 hPa	Test Voltage :	AC 120V/60HZ
Test Mode :	TX 2441MHz –CH39-1Mbps		

Freq.	Ant.Pol.	Reading		Ant./CF	Act.		Limit		Note
		Peak	AV		Peak	AV	Peak	AV	
(MHz)	H/V	(dBuV)	(dBuV)	CF(dB)	(dBuV/m)	(dBuV/m)	(dBuV/m)	(dBuV/m)	
2441.20	H	71.58	31.76	31.85	103.43	63.61			X/F
4882.53	H	41.82	33.54	6.46	48.28	40.00	74.00	54.00	X/H

Remark :

- (1) All readings are Peak unless otherwise stated QP in column of 『Note』 . Peak denotes that the Peak reading compliance with the QP Limits and then QP Mode measurement didn't perform ◦
- (2) Measuring frequency range from 30MHz to 1000MHz or the 10th harmonic of highest fundamental frequency ◦ "F" denotes fundamental frequency; "H" denotes spurious frequency. "E" denotes band edge frequency. (This judgment method includes the Band Edge Requirement.)
- (3) Radiated emissions measured in frequency range above 1000MHz were made with an instrument using Peak detector mode and AV detector mode of the emission ◦
- (4) Data of measurement within this frequency range shown " * " in the table above means the reading of emissions are attenuated more than 20dB below the permissible limits or the field strength is too small to be measured.
- (5) A preamp and high pass filter were used for this test in order to provide sufficient measurement sensitivity.
- (6) EUT Orthogonal Axis :
 "X" - denotes Laid on Table ; "Y" - denotes Vertical Stand ; "Z" - denotes Side Stand
- (7) During the measurements above 1 GHz it is taken care of that the EUT is always within the 3 dB cone of radiation BW of the used antenna



TX CH39 (Above 1000 MHz, Horizontal)

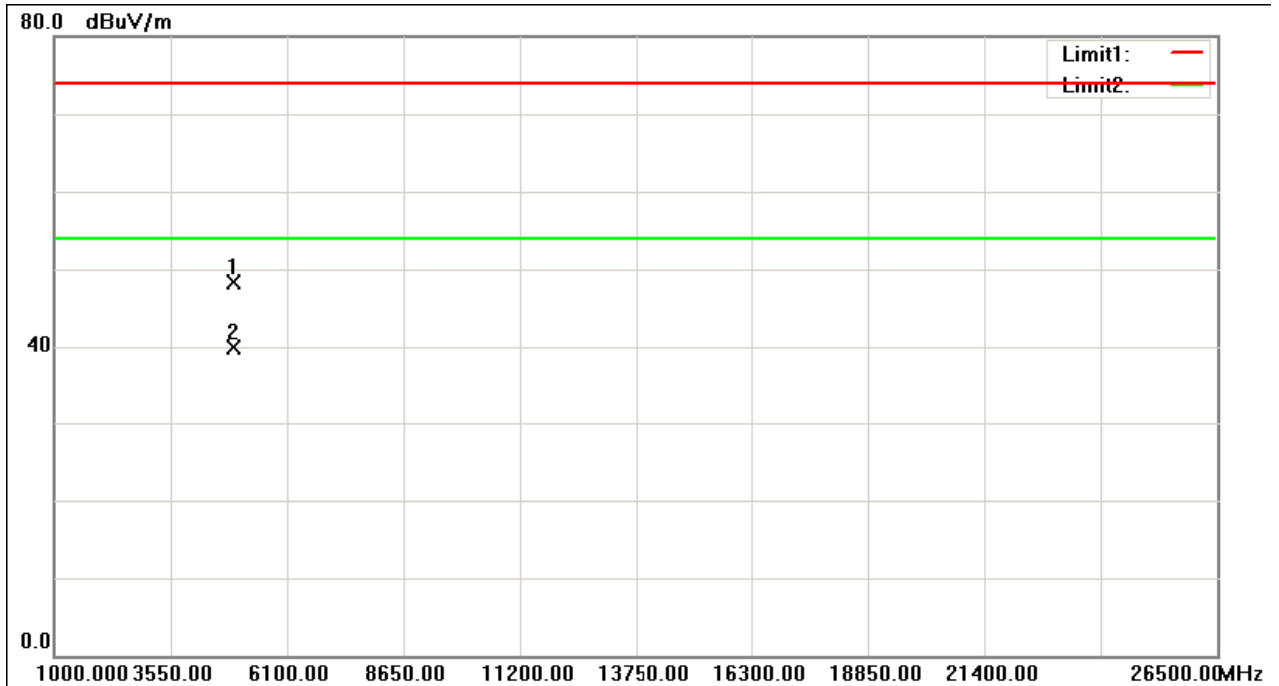
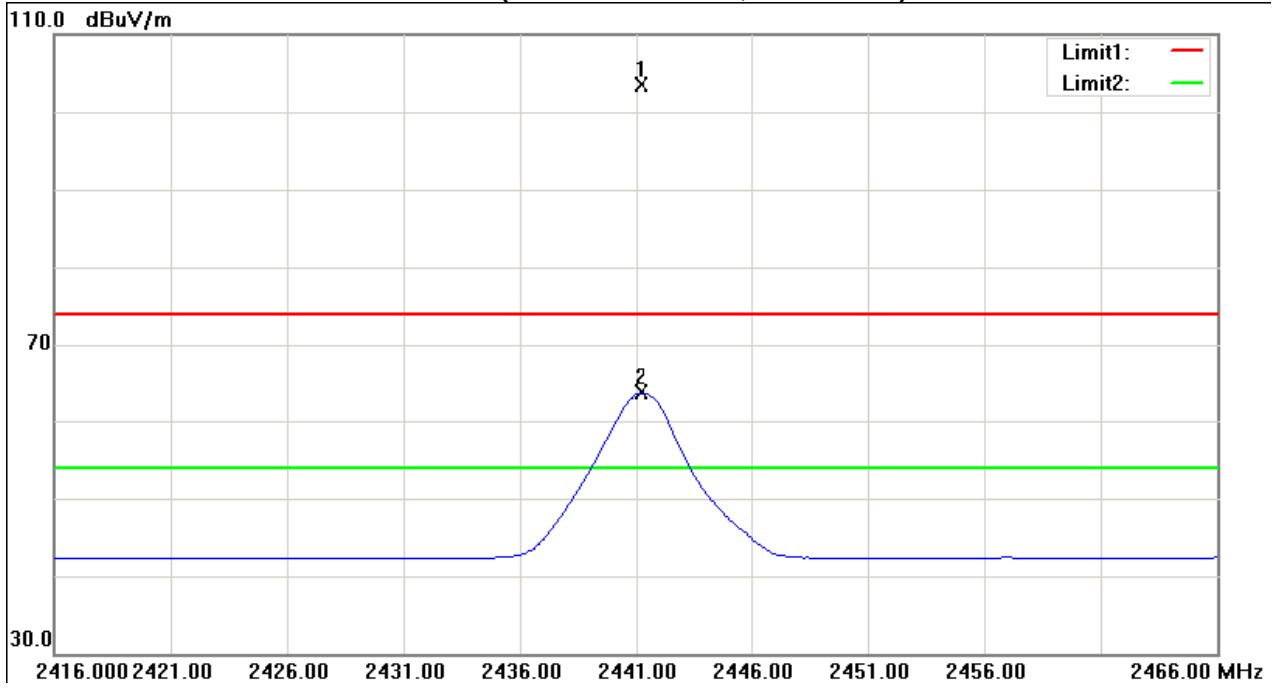



EUT :	Compact Stereo System	Model Name :	SC-HC05
Temperature :	23 °C	Relative Humidity :	58 %
Pressure :	1010hPa	Test Voltage :	AC 120V/60HZ
Test Mode :	TX 2480MHz –CH78-1Mbps		

Freq.	Ant.Pol.	Reading		Ant./CF	Act.		Limit		Note
		Peak	AV		Peak	AV	Peak	AV	
(MHz)	H/V	(dBuV)	(dBuV)	CF(dB)	(dBuV/m)	(dBuV/m)	(dBuV/m)	(dBuV/m)	
2480.20	V	65.28	28.78	31.80	97.08	60.58			X/F
2483.50	V	28.42	15.05	31.80	60.22	46.85	74.00	54.00	X/E
4960.36	V	41.09	32.26	6.73	47.82	38.99	74.00	54.00	X/H

Remark :

- (1) All readings are Peak unless otherwise stated QP in column of 『Note』 . Peak denotes that the Peak reading compliance with the QP Limits and then QP Mode measurement didn't perform ◦
- (2) Measuring frequency range from 30MHz to 1000MHz or the 10th harmonic of highest fundamental frequency ◦“F” denotes fundamental frequency; “H” denotes spurious frequency. “E” denotes band edge frequency. (This judgment method includes the Band Edge Requirement.)
- (3) Radiated emissions measured in frequency range above 1000MHz were made with an instrument using Peak detector mode and AV detector mode of the emission ◦
- (4) Data of measurement within this frequency range shown “ * ” in the table above means the reading of emissions are attenuated more than 20dB below the permissible limits or the field strength is too small to be measured.
- (5) A preamp and high pass filter were used for this test in order to provide sufficient measurement sensitivity.
- (6) EUT Orthogonal Axis :
“X” - denotes Laid on Table ; “Y” - denotes Vertical Stand ; “Z” - denotes Side Stand
- (7) During the measurements above 1 GHz it is taken care of that the EUT is always within the 3 dB cone of radiation BW of the used antenna



TX CH78 (Above 1000 MHz, Vertical)

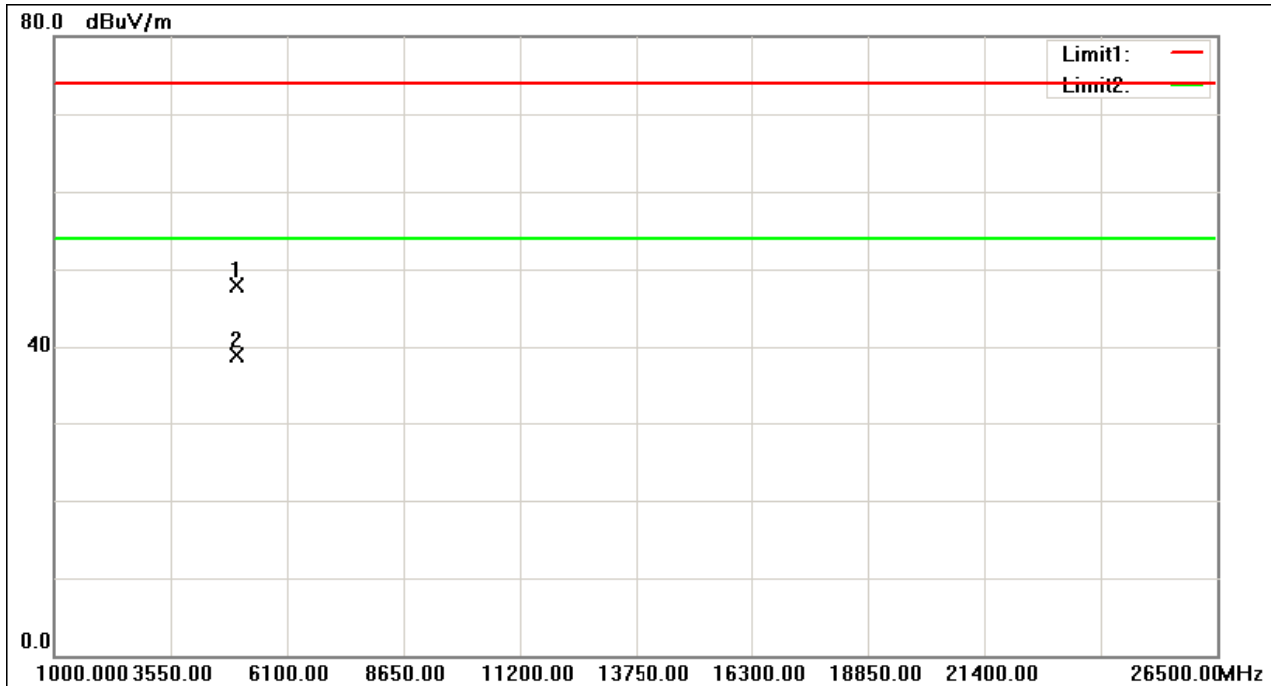
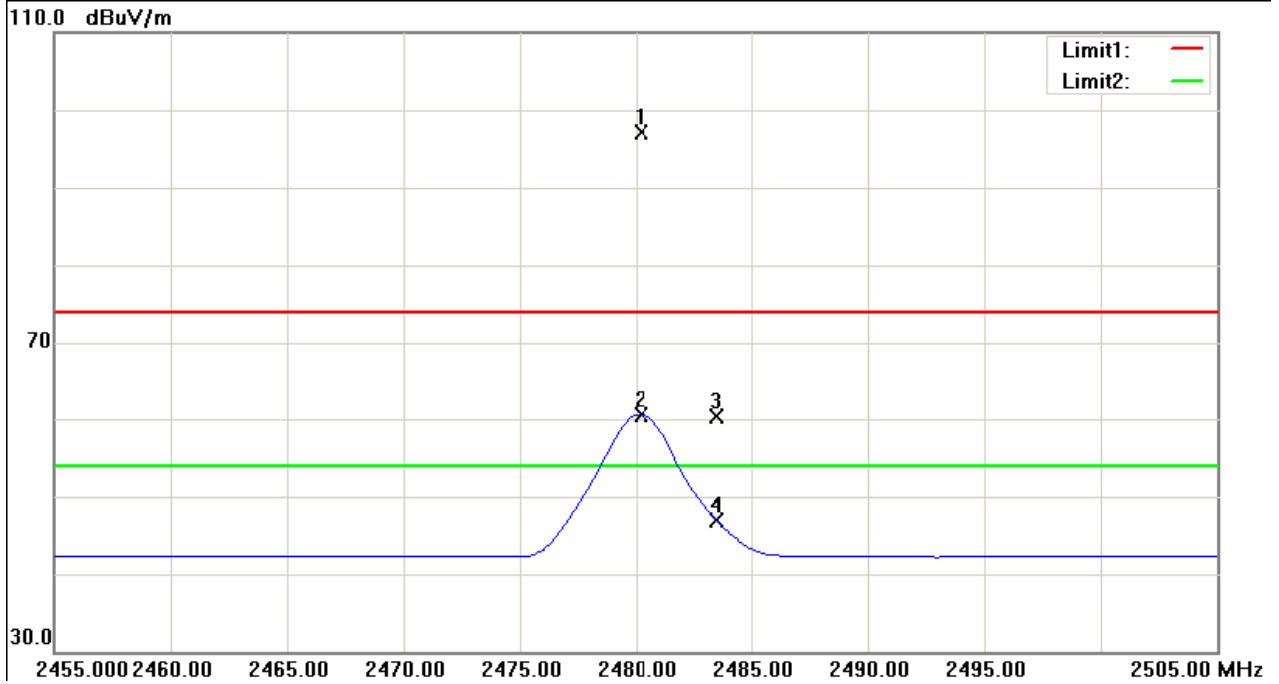



EUT :	Compact Stereo System	Model Name :	SC-HC05
Temperature :	23 °C	Relative Humidity :	58 %
Pressure :	1010 hPa	Test Voltage :	AC 120V/60HZ
Test Mode :	TX 2480MHz –CH78-1Mbps		

Freq.	Ant.Pol.	Reading		Ant./CF	Act.		Limit		Note
		Peak	AV		Peak	AV	Peak	AV	
(MHz)	H/V	(dBuV)	(dBuV)	CF(dB)	(dBuV/m)	(dBuV/m)	(dBuV/m)	(dBuV/m)	
2480.20	H	73.40	32.24	31.80	105.20	64.04			X/F
2483.50	H	36.34	17.86	31.80	64.14	49.66	74.00	54.00	X/E
4960.36	H	42.57	34.05	6.73	49.30	40.78	74.00	54.00	X/H

Remark :

- (1) All readings are Peak unless otherwise stated QP in column of 『Note』 . Peak denotes that the Peak reading compliance with the QP Limits and then QP Mode measurement didn't perform ◦
- (2) Measuring frequency range from 30MHz to 1000MHz or the 10th harmonic of highest fundamental frequency ◦“F” denotes fundamental frequency; “H” denotes spurious frequency. “E” denotes band edge frequency. (This judgment method includes the Band Edge Requirement.)
- (3) Radiated emissions measured in frequency range above 1000MHz were made with an instrument using Peak detector mode and AV detector mode of the emission ◦
- (4) Data of measurement within this frequency range shown “ * ” in the table above means the reading of emissions are attenuated more than 20dB below the permissible limits or the field strength is too small to be measured.
- (5) A preamp and high pass filter were used for this test in order to provide sufficient measurement sensitivity.
- (6) EUT Orthogonal Axis :
“X” - denotes Laid on Table ; “Y” - denotes Vertical Stand ; “Z” - denotes Side Stand
- (7) During the measurements above 1 GHz it is taken care of that the EUT is always within the 3 dB cone of radiation BW of the used antenna



TX CH78 (Above 1000 MHz, Horizontal)

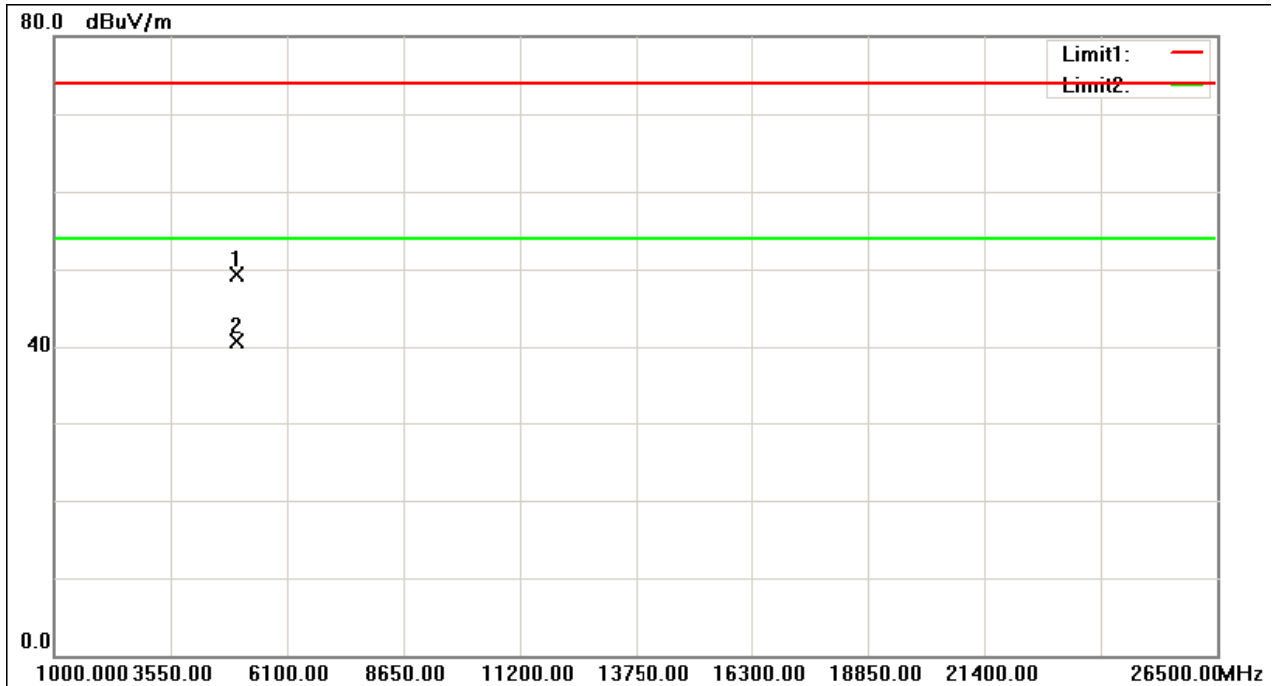
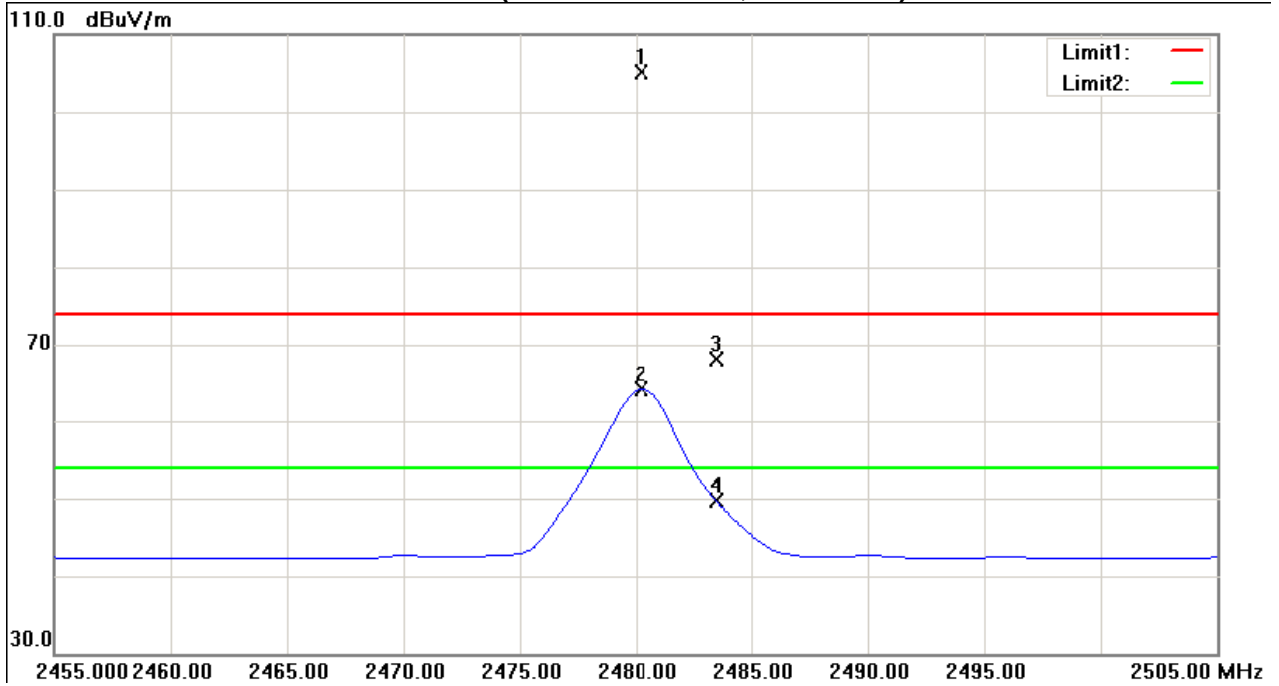



EUT :	Compact Stereo System	Model Name :	SC-HC05
Temperature :	23 °C	Relative Humidity :	58 %
Pressure :	1010 hPa	Test Voltage :	AC 120V/60HZ
Test Mode :	TX 2402MHz – CH 00-3Mbps		

Freq. (MHz)	Ant.Pol. H/V	Reading		Ant./CF CF(dB)	Act.		Limit		Note
		Peak (dBuV)	AV (dBuV)		Peak (dBuV/m)	AV (dBuV/m)	Peak (dBuV/m)	AV (dBuV/m)	
2390.00	V	21.76	10.48	31.91	53.67	42.39	74.00	54.00	X/E
2402.20	V	63.23	28.38	31.90	95.13	60.28			X/F
4804.85	V	40.22	31.87	6.17	46.39	38.04	74.00	54.00	X/H

Remark :

- (1) All readings are Peak unless otherwise stated QP in column of 『Note』 . Peak denotes that the Peak reading compliance with the QP Limits and then QP Mode measurement didn't perform ◦
- (2) Measuring frequency range from 30MHz to 1000MHz or the 10th harmonic of highest fundamental frequency ◦ “F” denotes fundamental frequency; “H” denotes spurious frequency. “E” denotes band edge frequency. (This judgment method includes the Band Edge Requirement.)
- (3) Radiated emissions measured in frequency range above 1000MHz were made with an instrument using Peak detector mode and AV detector mode of the emission ◦
- (4) Data of measurement within this frequency range shown “ * ” in the table above means the reading of emissions are attenuated more than 20dB below the permissible limits or the field strength is too small to be measured.
- (5) A preamp and high pass filter were used for this test in order to provide sufficient measurement sensitivity.
- (6) EUT Orthogonal Axis :
“X” - denotes Laid on Table ; ”Y” - denotes Vertical Stand ; ”Z” - denotes Side Stand
- (7) During the measurements above 1 GHz it is taken care of that the EUT is always within the 3 dB cone of radiation BW of the used antenna



TX CH00(Above 1000 MHz, Vertical)

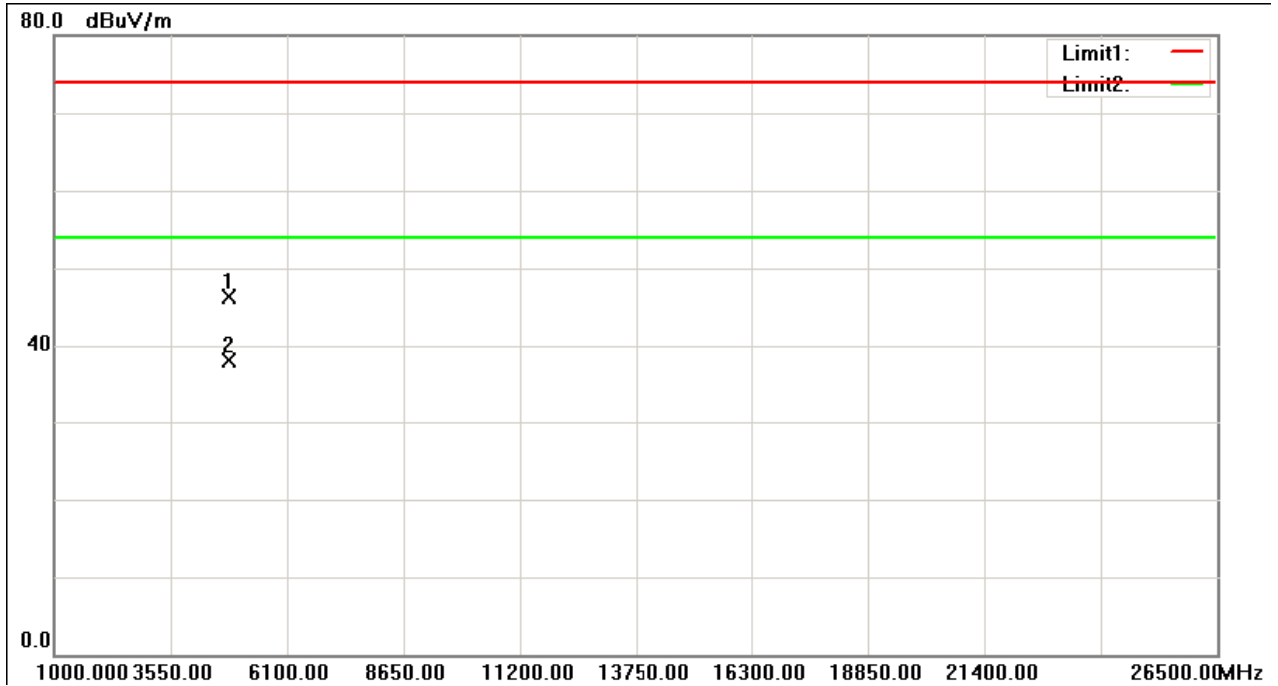
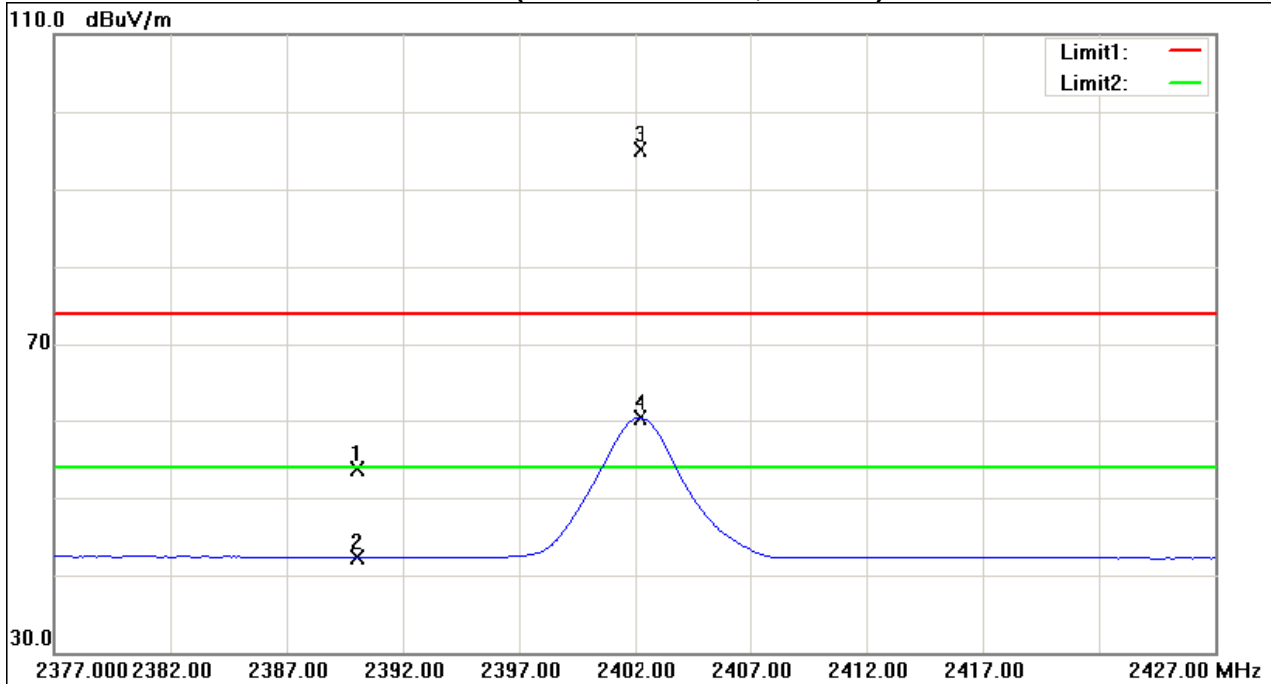



EUT :	Compact Stereo System	Model Name :	SC-HC05
Temperature :	23 °C	Relative Humidity :	58 %
Pressure :	1010hPa	Test Voltage :	AC 120V/60HZ
Test Mode :	TX 2402MHz – CH 00-3Mbps		

Freq. (MHz)	Ant.Pol. H/V	Reading		Ant./CF CF(dB)	Act.		Limit		Note
		Peak (dBuV)	AV (dBuV)		Peak (dBuV/m)	AV (dBuV/m)	Peak (dBuV/m)	AV (dBuV/m)	
2390.00	H	21.19	10.53	31.91	53.10	42.44	74.00	54.00	X/E
2402.00	H	71.38	32.14	31.90	103.28	64.04			X/F
4804.85	H	41.68	32.03	6.17	47.85	38.20	74.00	54.00	X/H

Remark :

- (1) All readings are Peak unless otherwise stated QP in column of 『Note』 . Peak denotes that the Peak reading compliance with the QP Limits and then QP Mode measurement didn't perform ◦
- (2) Measuring frequency range from 30MHz to 1000MHz or the 10th harmonic of highest fundamental frequency ◦ "F" denotes fundamental frequency; "H" denotes spurious frequency. "E" denotes band edge frequency. (This judgment method includes the Band Edge Requirement.)
- (3) Radiated emissions measured in frequency range above 1000MHz were made with an instrument using Peak detector mode and AV detector mode of the emission ◦
- (4) Data of measurement within this frequency range shown " * " in the table above means the reading of emissions are attenuated more than 20dB below the permissible limits or the field strength is too small to be measured.
- (5) A preamp and high pass filter were used for this test in order to provide sufficient measurement sensitivity.
- (6) EUT Orthogonal Axis :
"X" - denotes Laid on Table ; "Y" - denotes Vertical Stand ; "Z" - denotes Side Stand
- (7) During the measurements above 1 GHz it is taken care of that the EUT is always within the 3 dB cone of radiation BW of the used antenna



TX CH00(Above 1000 MHz, Horizontal)

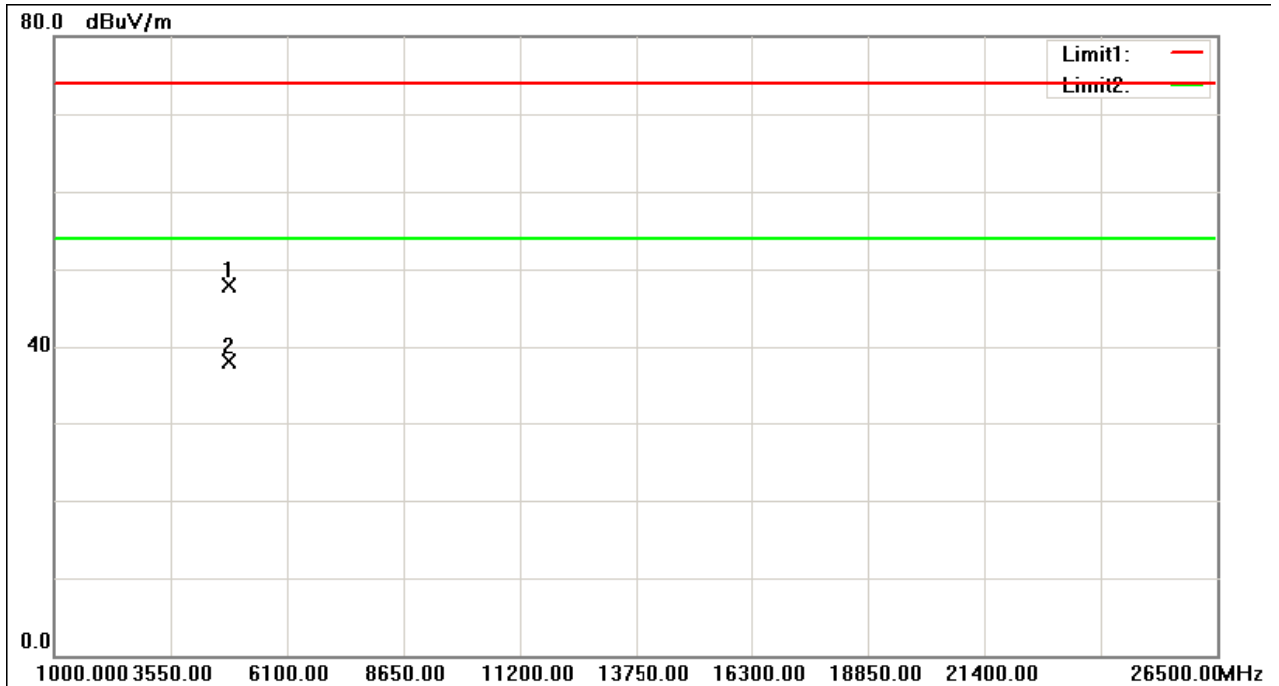
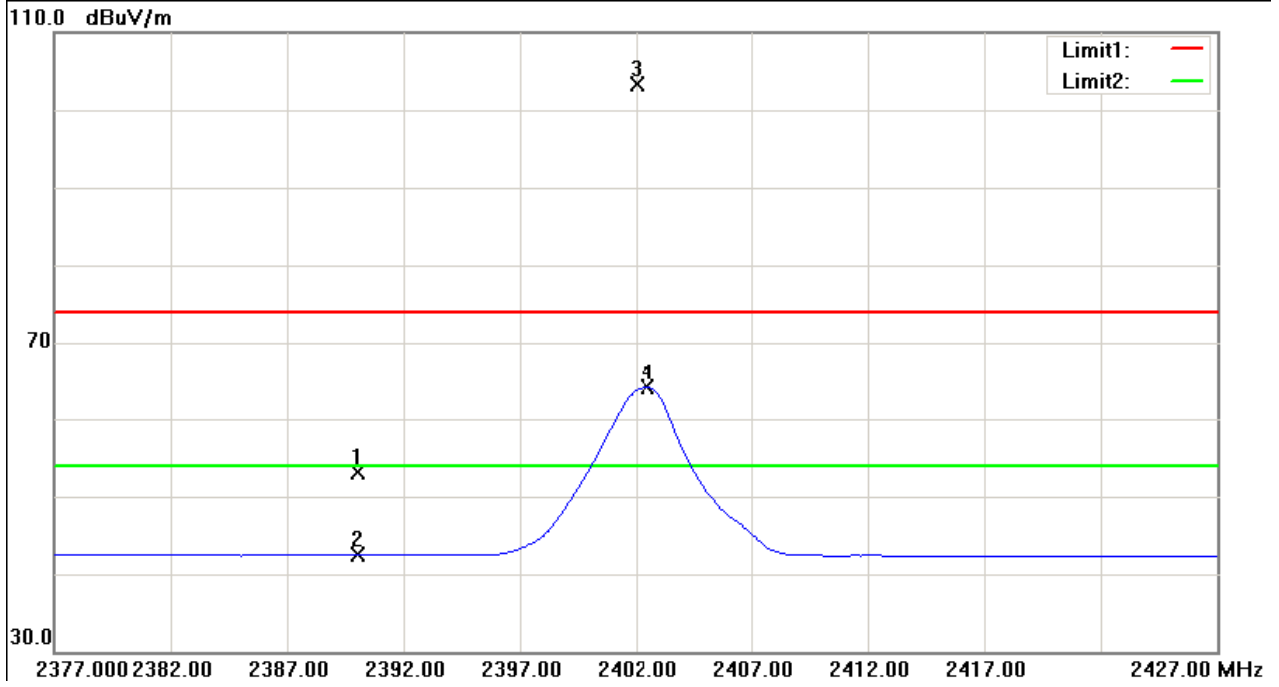



EUT :	Compact Stereo System	Model Name :	SC-HC05
Temperature :	23 °C	Relative Humidity :	58 %
Pressure :	1010 hPa	Test Voltage :	AC 120V/60HZ
Test Mode :	TX 2441MHz –CH39-3Mbps		

Freq.	Ant.Pol.	Reading		Ant./CF	Act.		Limit		Note
		Peak	AV		Peak	AV	Peak	AV	
(MHz)	H/V	(dBuV)	(dBuV)	CF(dB)	(dBuV/m)	(dBuV/m)	(dBuV/m)	(dBuV/m)	
2441.10	V	65.09	28.90	31.85	96.94	60.75			X/F
4882.54	V	41.23	32.09	6.46	47.69	38.55	74.00	54.00	X/H

Remark :

- (1) All readings are Peak unless otherwise stated QP in column of 『Note』 . Peak denotes that the Peak reading compliance with the QP Limits and then QP Mode measurement didn't perform ◦
- (2) Measuring frequency range from 30MHz to 1000MHz or the 10th harmonic of highest fundamental frequency ◦ “F” denotes fundamental frequency; “H” denotes spurious frequency. “E” denotes band edge frequency. (This judgment method includes the Band Edge Requirement.)
- (3) Radiated emissions measured in frequency range above 1000MHz were made with an instrument using Peak detector mode and AV detector mode of the emission ◦
- (4) Data of measurement within this frequency range shown “ * ” in the table above means the reading of emissions are attenuated more than 20dB below the permissible limits or the field strength is too small to be measured.
- (5) A preamp and high pass filter were used for this test in order to provide sufficient measurement sensitivity.
- (6) EUT Orthogonal Axis :
 “X” - denotes Laid on Table ; “Y” - denotes Vertical Stand ; “Z” - denotes Side Stand
- (7) During the measurements above 1 GHz it is taken care of that the EUT is always within the 3 dB cone of radiation BW of the used antenna



TX CH39 (Above 1000 MHz, Vertical)

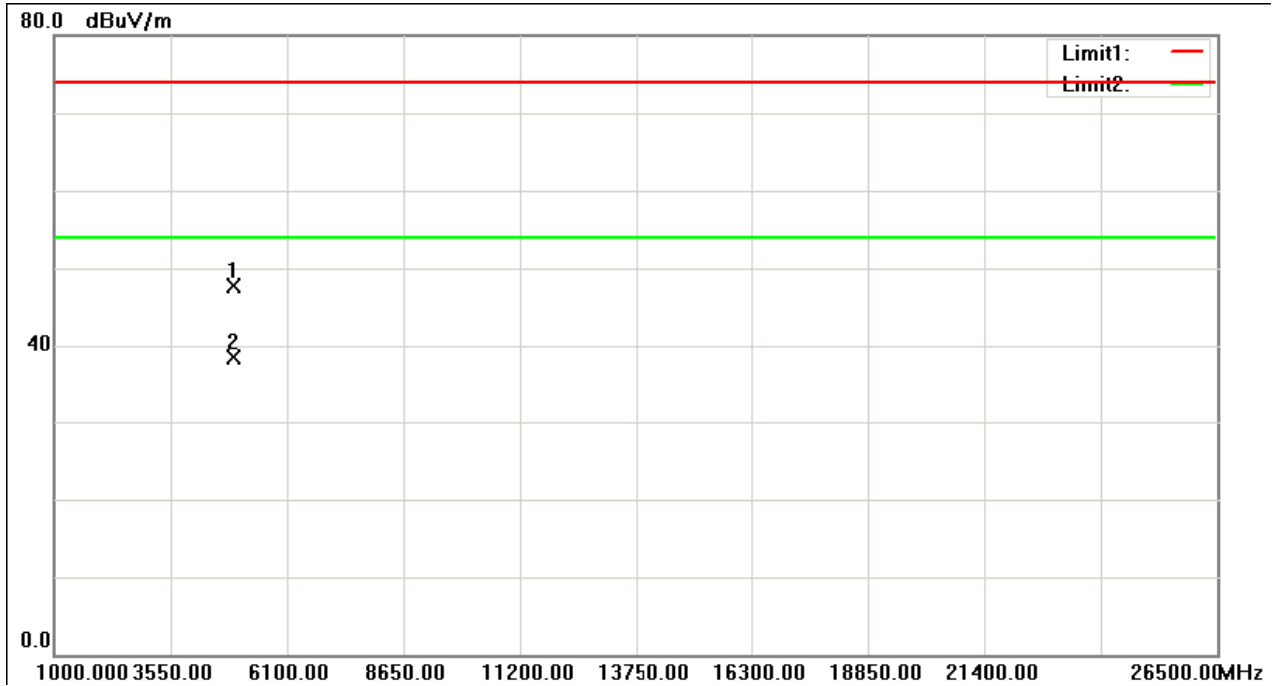
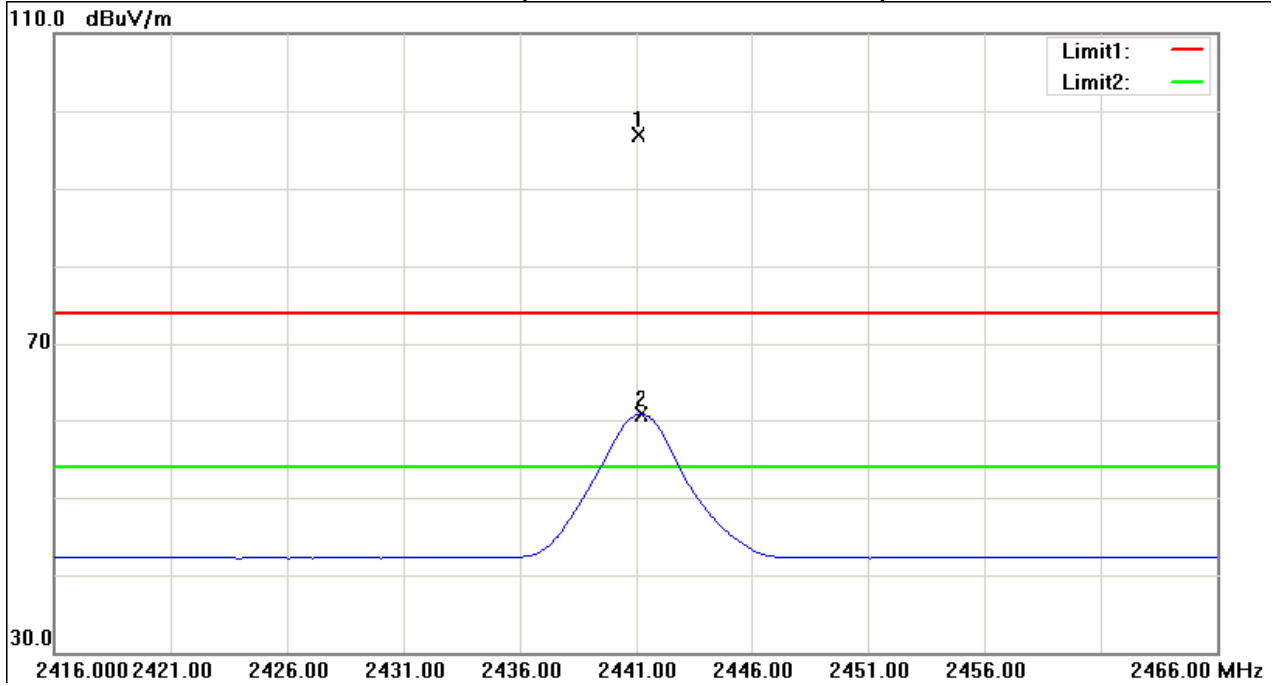



EUT :	Compact Stereo System	Model Name :	SC-HC05
Temperature :	23 °C	Relative Humidity :	58 %
Pressure :	1010 hPa	Test Voltage :	AC 120V/60HZ
Test Mode :	TX 2441MHz –CH39-3Mbps		

Freq.	Ant.Pol.	Reading		Ant./CF	Act.		Limit		Note
		Peak	AV		Peak	AV	Peak	AV	
(MHz)	H/V	(dBuV)	(dBuV)	CF(dB)	(dBuV/m)	(dBuV/m)	(dBuV/m)	(dBuV/m)	
2441.00	H	71.61	31.77	31.85	103.46	63.62			X/F
4882.54	H	44.02	32.51	6.46	50.48	38.97	74.00	54.00	X/H

Remark :

- (1) All readings are Peak unless otherwise stated QP in column of 『Note』 . Peak denotes that the Peak reading compliance with the QP Limits and then QP Mode measurement didn't perform ◦
- (2) Measuring frequency range from 30MHz to 1000MHz or the 10th harmonic of highest fundamental frequency ◦ "F" denotes fundamental frequency; "H" denotes spurious frequency. "E" denotes band edge frequency. (This judgment method includes the Band Edge Requirement.)
- (3) Radiated emissions measured in frequency range above 1000MHz were made with an instrument using Peak detector mode and AV detector mode of the emission ◦
- (4) Data of measurement within this frequency range shown " * " in the table above means the reading of emissions are attenuated more than 20dB below the permissible limits or the field strength is too small to be measured.
- (5) A preamp and high pass filter were used for this test in order to provide sufficient measurement sensitivity.
- (6) EUT Orthogonal Axis :
"X" - denotes Laid on Table ; "Y" - denotes Vertical Stand ; "Z" - denotes Side Stand
- (7) During the measurements above 1 GHz it is taken care of that the EUT is always within the 3 dB cone of radiation BW of the used antenna



TX CH39 (Above 1000 MHz, Horizontal)

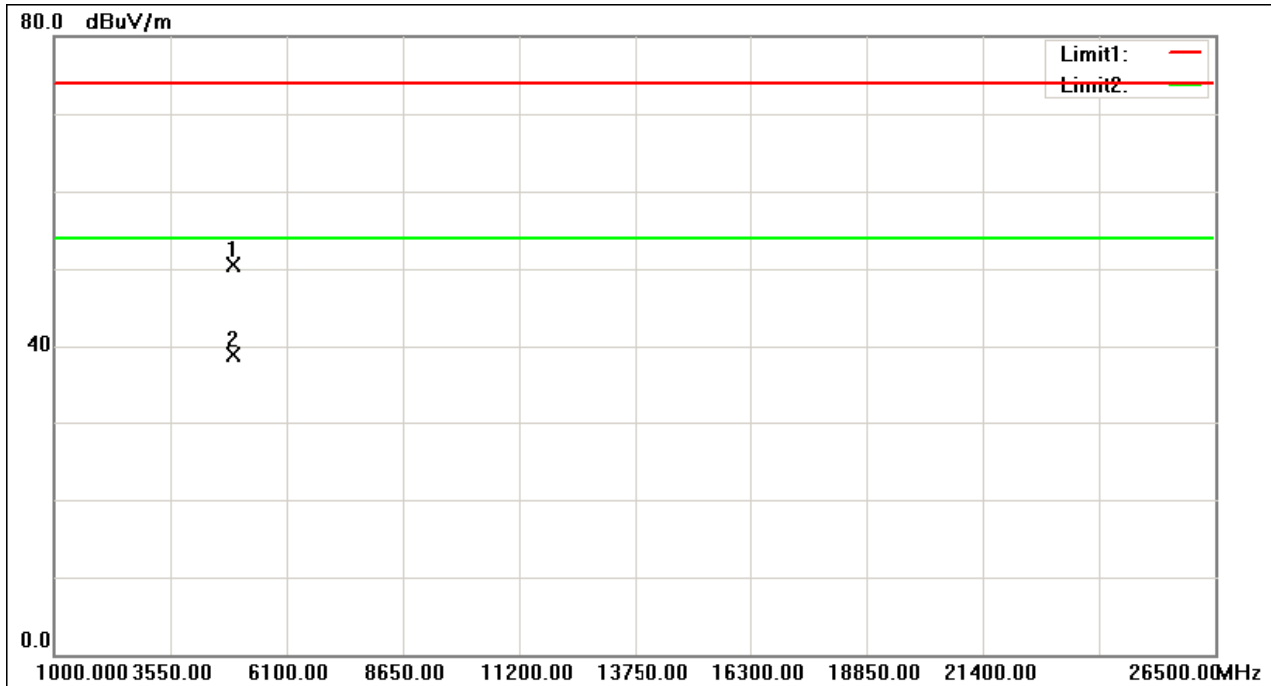
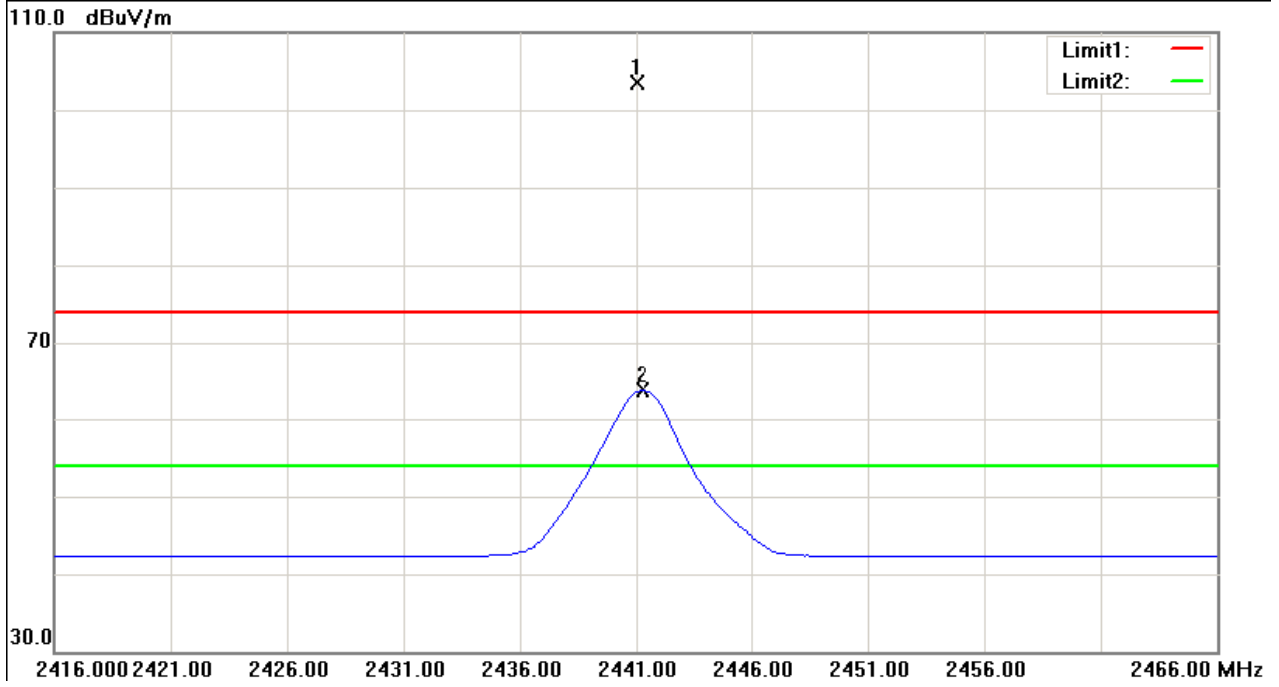



EUT :	Compact Stereo System	Model Name :	SC-HC05
Temperature :	23 °C	Relative Humidity :	58 %
Pressure :	1010hPa	Test Voltage :	AC 120V/60HZ
Test Mode :	TX 2480MHz –CH78-3Mbps		

Freq.	Ant.Pol.	Reading		Ant./CF	Act.		Limit		Note
		Peak	AV		Peak	AV	Peak	AV	
(MHz)	H/V	(dBuV)	(dBuV)	CF(dB)	(dBuV/m)	(dBuV/m)	(dBuV/m)	(dBuV/m)	
2480.00	V	66.32	29.22	31.80	98.12	61.02			X/F
2483.50	V	28.84	15.43	31.80	60.64	47.23	74.00	54.00	X/E
4960.09	V	44.17	35.62	6.73	50.90	42.35	74.00	54.00	X/H

Remark :

- (1) All readings are Peak unless otherwise stated QP in column of 『Note』 . Peak denotes that the Peak reading compliance with the QP Limits and then QP Mode measurement didn't perform ◦
- (2) Measuring frequency range from 30MHz to 1000MHz or the 10th harmonic of highest fundamental frequency ◦“F” denotes fundamental frequency; “H” denotes spurious frequency. “E” denotes band edge frequency. (This judgment method includes the Band Edge Requirement.)
- (3) Radiated emissions measured in frequency range above 1000MHz were made with an instrument using Peak detector mode and AV detector mode of the emission ◦
- (4) Data of measurement within this frequency range shown “ * ” in the table above means the reading of emissions are attenuated more than 20dB below the permissible limits or the field strength is too small to be measured.
- (5) A preamp and high pass filter were used for this test in order to provide sufficient measurement sensitivity.
- (6) EUT Orthogonal Axis :
“X” - denotes Laid on Table ; “Y” - denotes Vertical Stand ; “Z” - denotes Side Stand
- (7) During the measurements above 1 GHz it is taken care of that the EUT is always within the 3 dB cone of radiation BW of the used antenna



TX CH78 (Above 1000 MHz, Vertical)

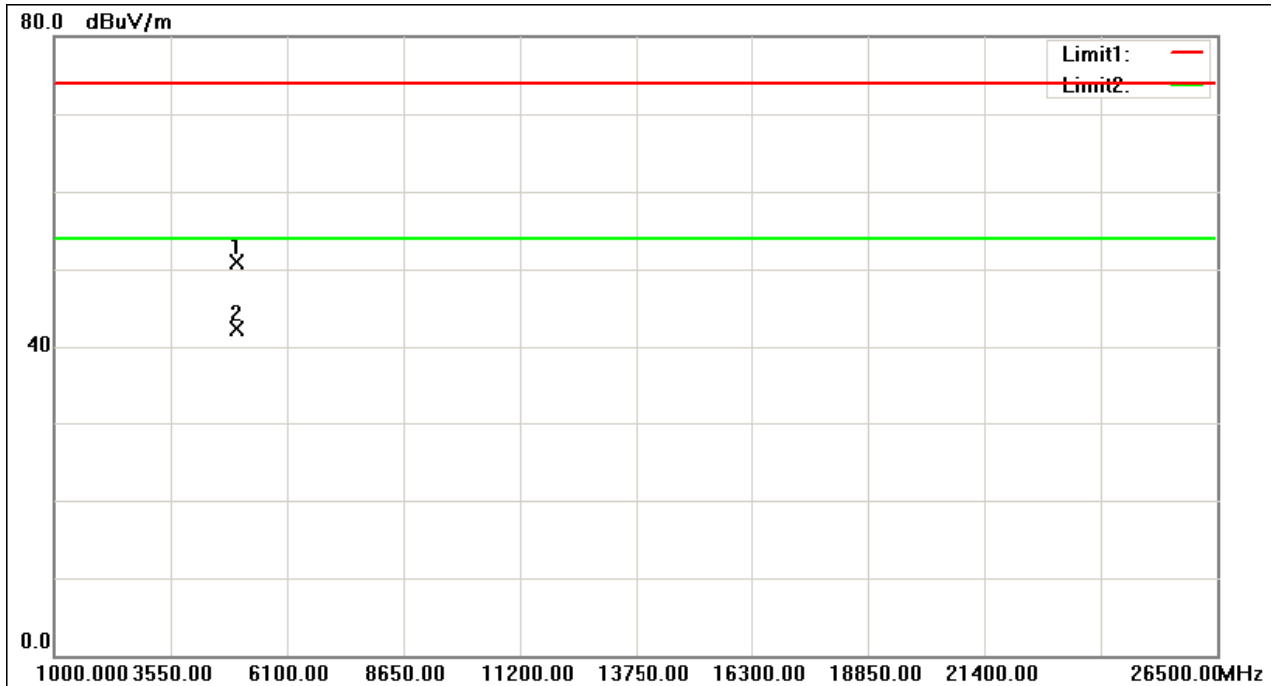
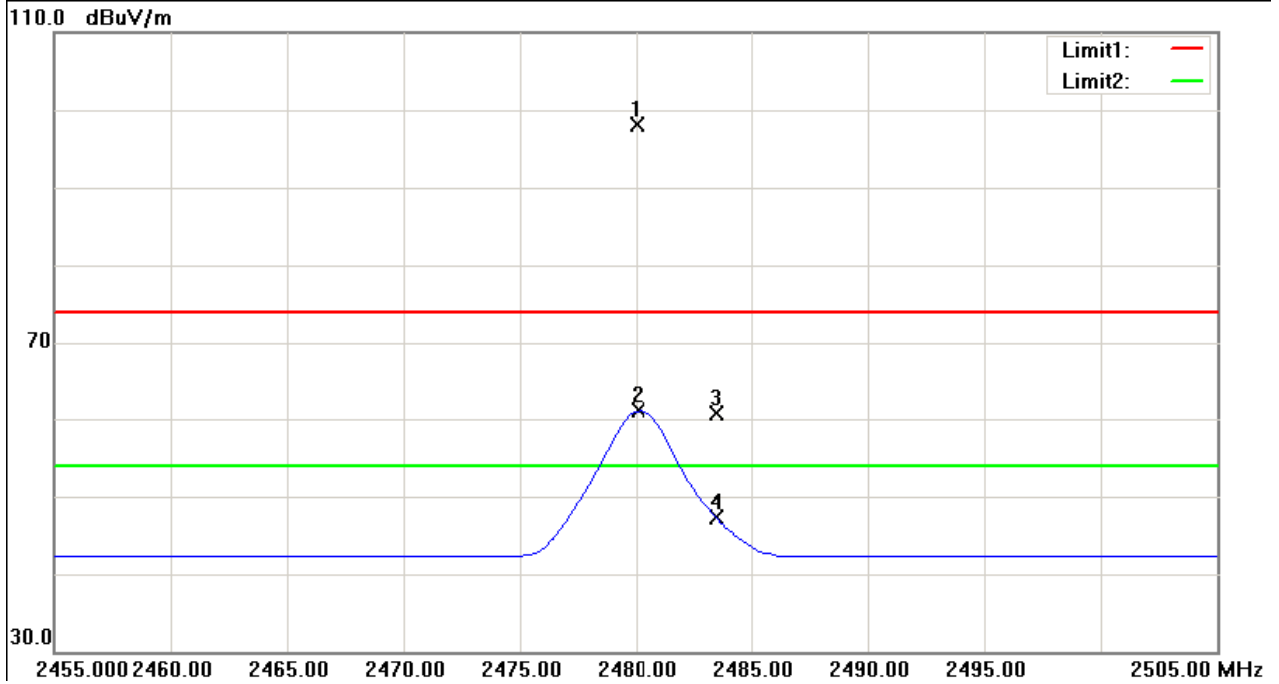



EUT :	Compact Stereo System	Model Name :	SC-HC05
Temperature :	23 °C	Relative Humidity :	58 %
Pressure :	1010 hPa	Test Voltage :	AC 120V/60HZ
Test Mode :	TX 2480MHz –CH78-3Mbps		

Freq.	Ant.Pol.	Reading		Ant./CF	Act.		Limit		Note
		Peak	AV		Peak	AV	Peak	AV	
(MHz)	H/V	(dBuV)	(dBuV)	CF(dB)	(dBuV/m)	(dBuV/m)	(dBuV/m)	(dBuV/m)	
2480.00	H	72.66	31.99	31.80	104.46	63.79			X/F
2483.50	H	35.00	17.55	31.80	66.80	49.35	74.00	54.00	X/E
4960.09	H	47.05	36.79	6.73	53.78	43.52	74.00	54.00	X/H

Remark :

- (1) All readings are Peak unless otherwise stated QP in column of 『Note』 . Peak denotes that the Peak reading compliance with the QP Limits and then QP Mode measurement didn't perform ◦
- (2) Measuring frequency range from 30MHz to 1000MHz or the 10th harmonic of highest fundamental frequency ◦“F” denotes fundamental frequency; “H” denotes spurious frequency. “E” denotes band edge frequency. (This judgment method includes the Band Edge Requirement.)
- (3) Radiated emissions measured in frequency range above 1000MHz were made with an instrument using Peak detector mode and AV detector mode of the emission ◦
- (4) Data of measurement within this frequency range shown “ * ” in the table above means the reading of emissions are attenuated more than 20dB below the permissible limits or the field strength is too small to be measured.
- (5) A preamp and high pass filter were used for this test in order to provide sufficient measurement sensitivity.
- (6) EUT Orthogonal Axis :
“X” - denotes Laid on Table ; “Y” - denotes Vertical Stand ; “Z” - denotes Side Stand
- (7) During the measurements above 1 GHz it is taken care of that the EUT is always within the 3 dB cone of radiation BW of the used antenna



TX CH78 (Above 1000 MHz, Horizontal)

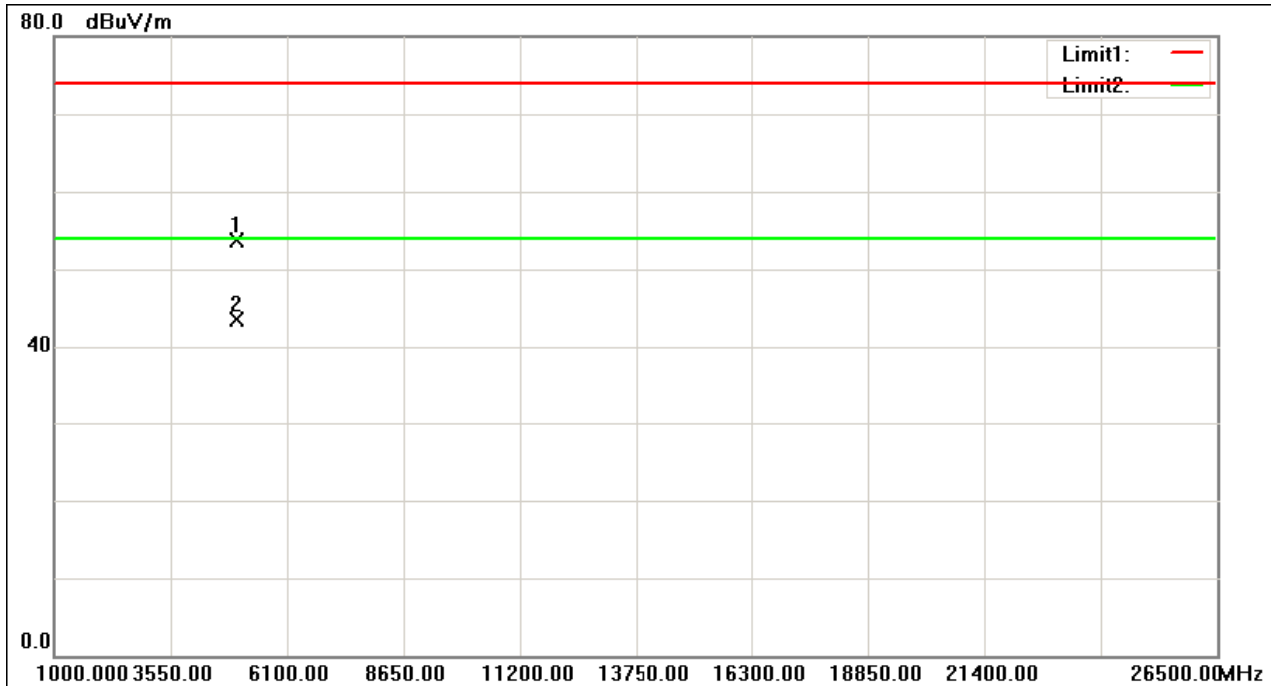
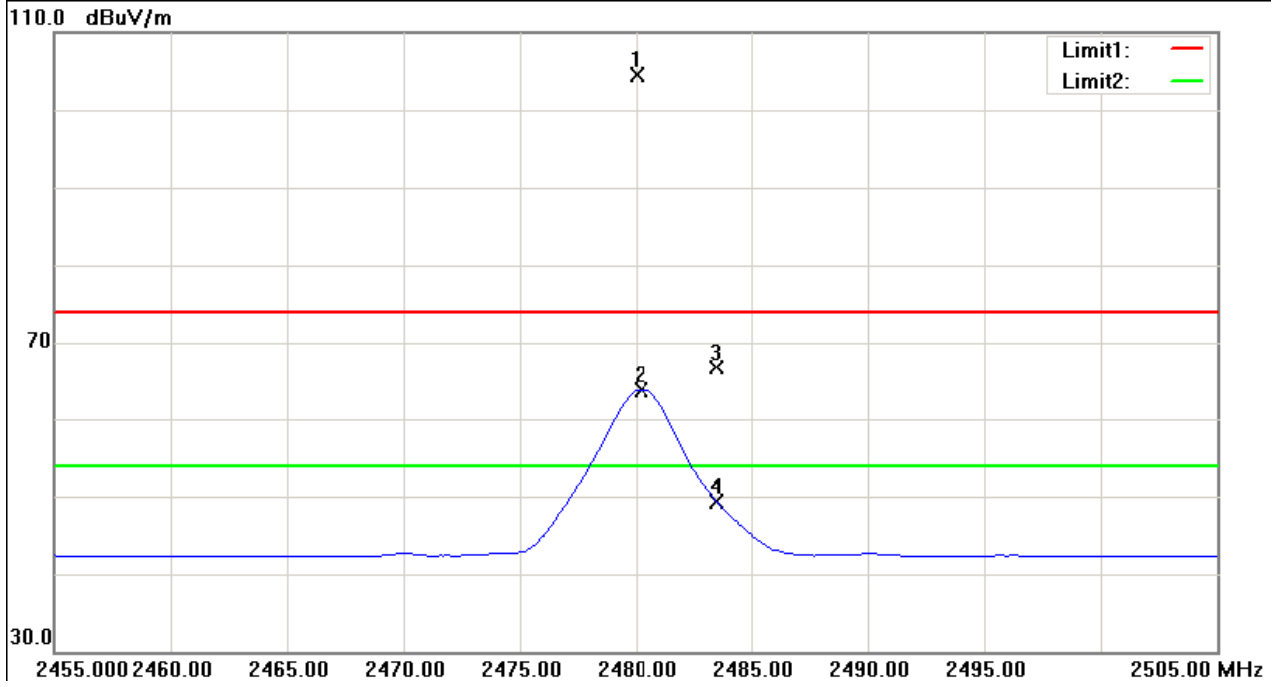



EUT :	Compact Stereo System	Model Name :	SC-HC05
Temperature :	23 °C	Relative Humidity :	58 %
Pressure :	1010 hPa	Test Voltage :	AC 120V/60HZ
Test Mode :	RX Mode 2402MHz-1Mbps		

Freq. (MHz)	Ant.Pol. H/V	Reading		Ant./CF CF(dB)	Act.		Limit		Note
		Peak (dBuV)	AV (dBuV)		Peak (dBuV/m)	AV (dBuV/m)	Peak (dBuV/m)	AV (dBuV/m)	
2820.00	V	43.88	31.25	-0.48	43.40	30.77	74.00	54.00	X/H

Remark :

- (1) All readings are Peak unless otherwise stated QP in column of 『Note』 . Peak denotes that the Peak reading compliance with the QP Limits and then QP Mode measurement didn't perform ◦
- (2) Measuring frequency range from 1000MHz to 6000MHz or the 10th harmonic of highest fundamental frequency ◦ "F" denotes fundamental frequency; "H" denotes spurious frequency. "E" denotes band edge frequency. (This judgment method includes the Band Edge Requirement.)
- (3) Radiated emissions measured in frequency range above 1000MHz were made with an instrument using Peak detector mode and AV detector mode of the emission ◦
- (4) Data of measurement within this frequency range shown " * " in the table above means the reading of emissions are attenuated more than 20dB below the permissible limits or the field strength is too small to be measured.
- (5) A preamp and high pass filter were used for this test in order to provide sufficient measurement sensitivity.
- (6) EUT Orthogonal Axis :
 "X" - denotes Laid on Table ; "Y" - denotes Vertical Stand ; "Z" - denotes Side Stand

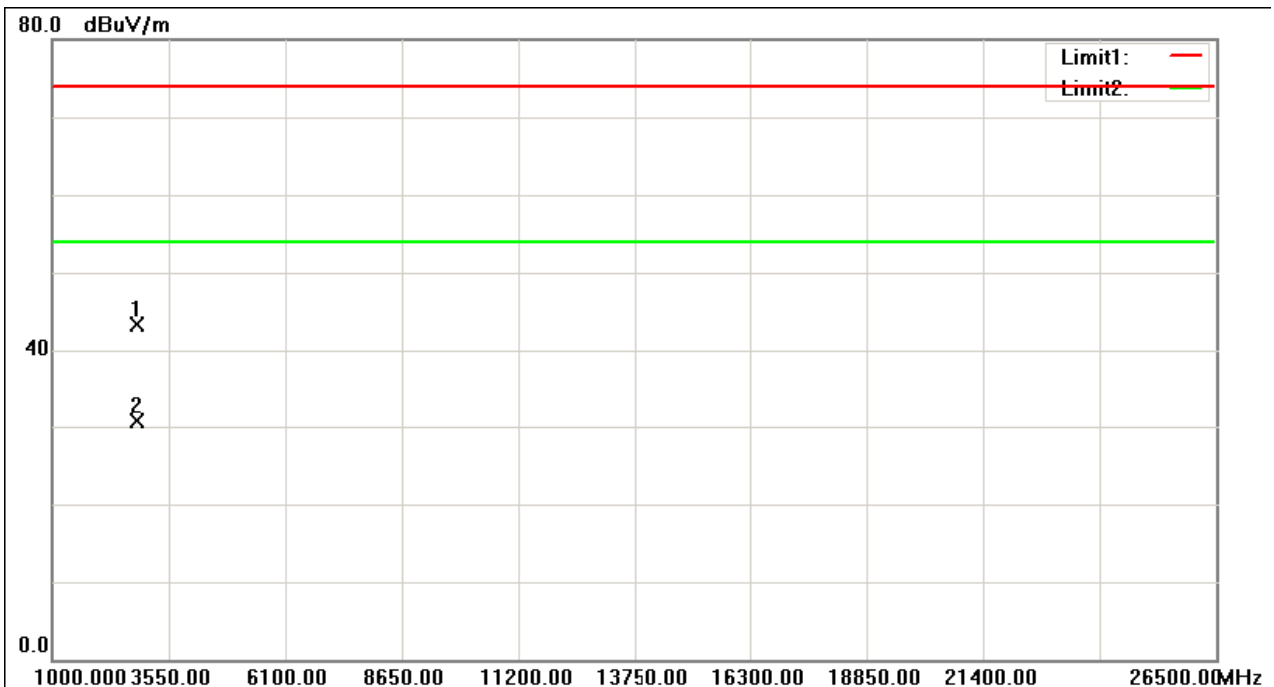



EUT :	Compact Stereo System	Model Name :	SC-HC05
Temperature :	23 °C	Relative Humidity :	58 %
Pressure :	1010 hPa	Test Voltage :	AC 120V/60HZ
Test Mode :	RX Mode 2402MHz-1Mbps		

Freq. (MHz)	Ant.Pol. H/V	Reading		Ant./CF CF(dB)	Act.		Limit		Note
		Peak (dBuV)	AV (dBuV)		Peak (dBuV/m)	AV (dBuV/m)	Peak (dBuV/m)	AV (dBuV/m)	
2820.00	H	44.15	31.09	-0.48	43.67	30.61	74.00	54.00	X/H

Remark :

- (1) All readings are Peak unless otherwise stated QP in column of 『Note』 . Peak denotes that the Peak reading compliance with the QP Limits and then QP Mode measurement didn't perform ◦
- (2) Measuring frequency range from 1000MHz to 6000MHz or the 10th harmonic of highest fundamental frequency ◦ "F" denotes fundamental frequency; "H" denotes spurious frequency. "E" denotes band edge frequency. (This judgment method includes the Band Edge Requirement.)
- (3) Radiated emissions measured in frequency range above 1000MHz were made with an instrument using Peak detector mode and AV detector mode of the emission ◦
- (4) Data of measurement within this frequency range shown " * " in the table above means the reading of emissions are attenuated more than 20dB below the permissible limits or the field strength is too small to be measured.
- (5) A preamp and high pass filter were used for this test in order to provide sufficient measurement sensitivity.
- (6) EUT Orthogonal Axis :
 "X" - denotes Laid on Table ; "Y" - denotes Vertical Stand ; "Z" - denotes Side Stand

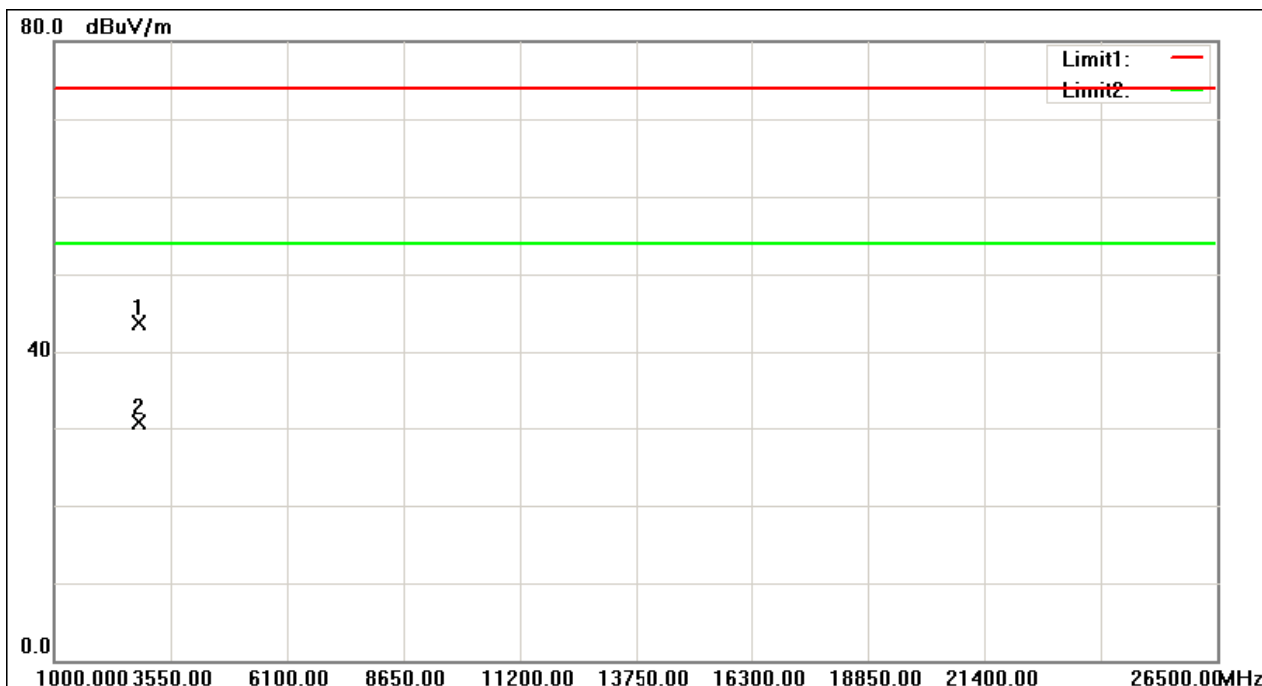



EUT :	Compact Stereo System	Model Name :	SC-HC05
Temperature :	23 °C	Relative Humidity :	58 %
Pressure :	1010 hPa	Test Voltage :	AC 120V/60HZ
Test Mode :	RX Mode 2441MHz-1Mbps		

Freq. (MHz)	Ant.Pol. H/V	Reading		Ant./CF CF(dB)	Act.		Limit		Note
		Peak (dBuV)	AV (dBuV)		Peak (dBuV/m)	AV (dBuV/m)	Peak (dBuV/m)	AV (dBuV/m)	
2815.50	V	42.09	31.54	-0.49	41.60	31.05	74.00	54.00	X/H

Remark :

- (1) All readings are Peak unless otherwise stated QP in column of 『Note』 . Peak denotes that the Peak reading compliance with the QP Limits and then QP Mode measurement didn't perform ◦
- (2) Measuring frequency range from 1000MHz to 6000MHz or the 10th harmonic of highest fundamental frequency ◦ "F" denotes fundamental frequency; "H" denotes spurious frequency. "E" denotes band edge frequency. (This judgment method includes the Band Edge Requirement.)
- (3) Radiated emissions measured in frequency range above 1000MHz were made with an instrument using Peak detector mode and AV detector mode of the emission ◦
- (4) Data of measurement within this frequency range shown " * " in the table above means the reading of emissions are attenuated more than 20dB below the permissible limits or the field strength is too small to be measured.
- (5) A preamp and high pass filter were used for this test in order to provide sufficient measurement sensitivity.
- (6) EUT Orthogonal Axis :
 "X" - denotes Laid on Table ; "Y" - denotes Vertical Stand ; "Z" - denotes Side Stand

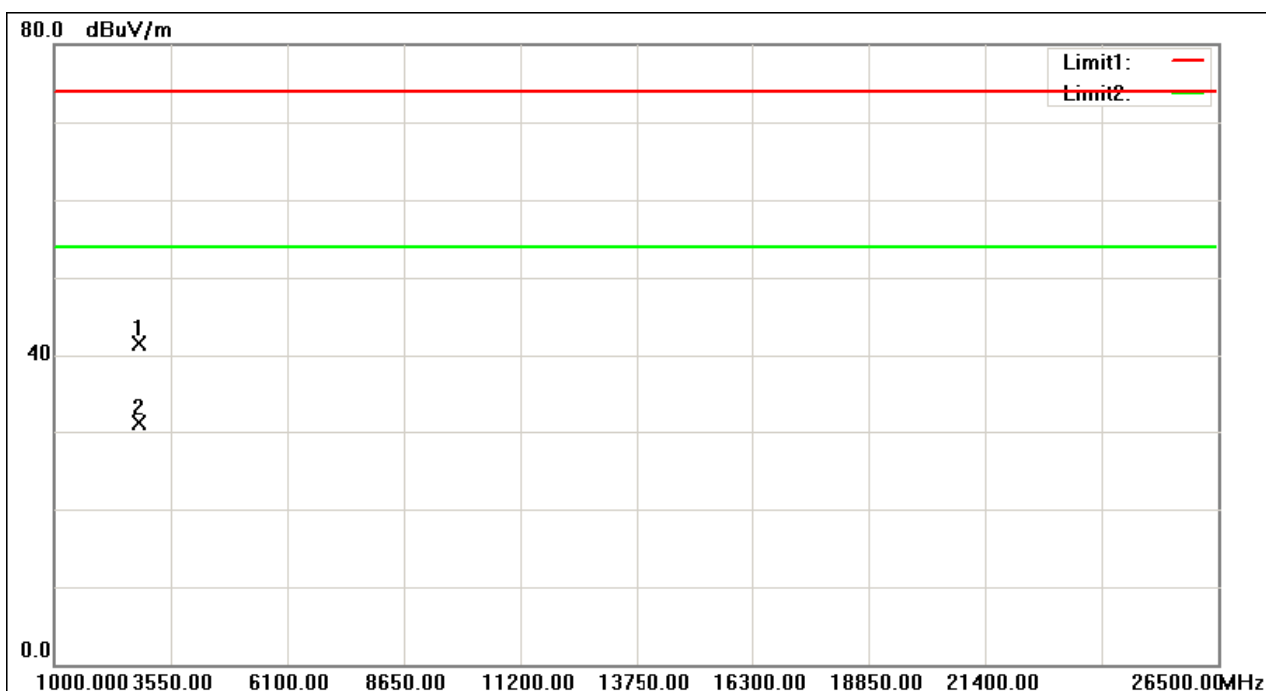



EUT :	Compact Stereo System	Model Name :	SC-HC05
Temperature :	23 °C	Relative Humidity :	58 %
Pressure :	1010 hPa	Test Voltage :	AC 120V/60HZ
Test Mode :	RX Mode 2441MHz-1Mbps		

Freq. (MHz)	Ant.Pol. H/V	Reading		Ant./CF CF(dB)	Act.		Limit		Note
		Peak (dBuV)	AV (dBuV)		Peak (dBuV/m)	AV (dBuV/m)	Peak (dBuV/m)	AV (dBuV/m)	
2815.50	H	44.87	32.51	-0.49	44.38	32.02	74.00	54.00	X/H

Remark :

- (1) All readings are Peak unless otherwise stated QP in column of 『Note』 . Peak denotes that the Peak reading compliance with the QP Limits and then QP Mode measurement didn't perform ◦
- (2) Measuring frequency range from 1000MHz to 6000MHz or the 10th harmonic of highest fundamental frequency ◦ "F" denotes fundamental frequency; "H" denotes spurious frequency. "E" denotes band edge frequency. (This judgment method includes the Band Edge Requirement.)
- (3) Radiated emissions measured in frequency range above 1000MHz were made with an instrument using Peak detector mode and AV detector mode of the emission ◦
- (4) Data of measurement within this frequency range shown " * " in the table above means the reading of emissions are attenuated more than 20dB below the permissible limits or the field strength is too small to be measured.
- (5) A preamp and high pass filter were used for this test in order to provide sufficient measurement sensitivity.
- (6) EUT Orthogonal Axis :
 "X" - denotes Laid on Table ; "Y" - denotes Vertical Stand ; "Z" - denotes Side Stand

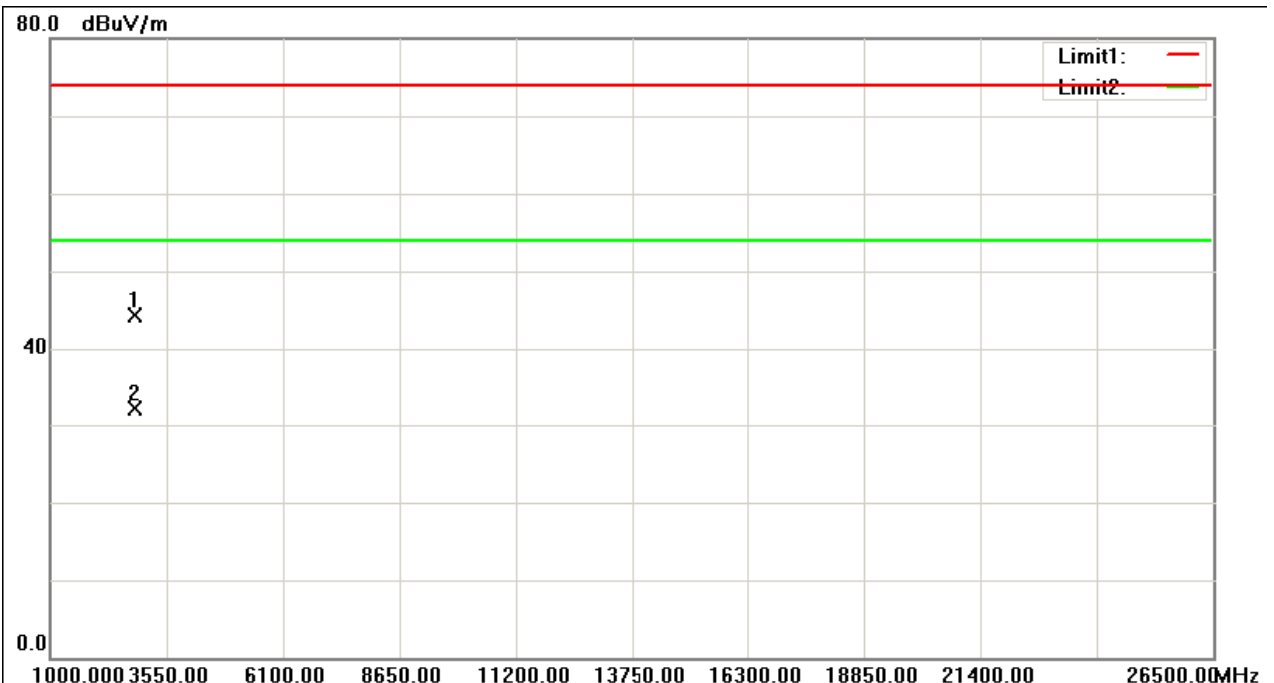



EUT :	Compact Stereo System	Model Name :	SC-HC05
Temperature :	23 °C	Relative Humidity :	58 %
Pressure :	1010 hPa	Test Voltage :	AC 120V/60HZ
Test Mode :	RX Mode 2480MHz-1Mbps		

Freq. (MHz)	Ant.Pol. H/V	Reading		Ant./CF CF(dB)	Act.		Limit		Note
		Peak (dBuV)	AV (dBuV)		Peak (dBuV/m)	AV (dBuV/m)	Peak (dBuV/m)	AV (dBuV/m)	
2964.50	V	43.51	31.58	0.06	43.57	31.64	74.00	54.00	X/H

Remark :

- (1) All readings are Peak unless otherwise stated QP in column of 『Note』 . Peak denotes that the Peak reading compliance with the QP Limits and then QP Mode measurement didn't perform ◦
- (2) Measuring frequency range from 1000MHz to 6000MHz or the 10th harmonic of highest fundamental frequency ◦ "F" denotes fundamental frequency; "H" denotes spurious frequency. "E" denotes band edge frequency. (This judgment method includes the Band Edge Requirement.)
- (3) Radiated emissions measured in frequency range above 1000MHz were made with an instrument using Peak detector mode and AV detector mode of the emission ◦
- (4) Data of measurement within this frequency range shown " * " in the table above means the reading of emissions are attenuated more than 20dB below the permissible limits or the field strength is too small to be measured.
- (5) A preamp and high pass filter were used for this test in order to provide sufficient measurement sensitivity.
- (6) EUT Orthogonal Axis :
 "X" - denotes Laid on Table ; "Y" - denotes Vertical Stand ; "Z" - denotes Side Stand

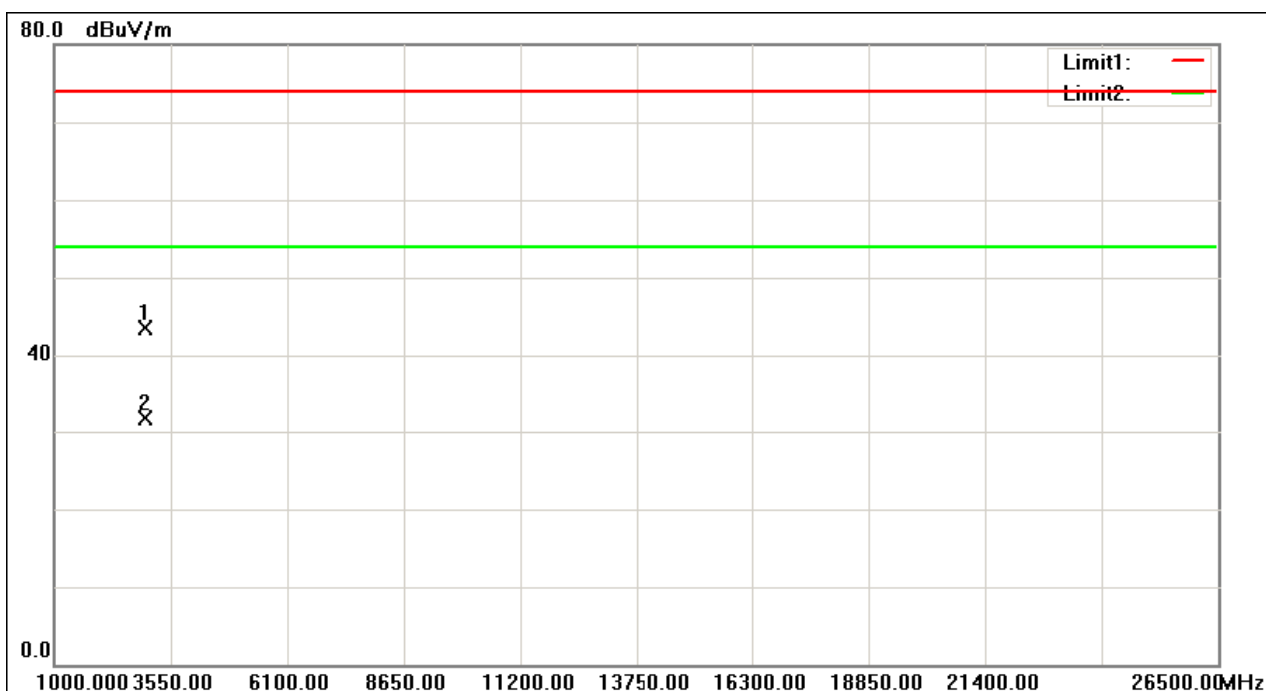



EUT :	Compact Stereo System	Model Name :	SC-HC05
Temperature :	23 °C	Relative Humidity :	58 %
Pressure :	1010 hPa	Test Voltage :	AC 120V/60HZ
Test Mode :	RX Mode 2480MHz-1Mbps		

Freq. (MHz)	Ant.Pol. H/V	Reading		Ant./CF CF(dB)	Act.		Limit		Note
		Peak (dBuV)	AV (dBuV)		Peak (dBuV/m)	AV (dBuV/m)	Peak (dBuV/m)	AV (dBuV/m)	
2964.50	H	44.87	33.02	0.06	44.93	33.08	74.00	54.00	X/H

Remark :

- (1) All readings are Peak unless otherwise stated QP in column of 『Note』 . Peak denotes that the Peak reading compliance with the QP Limits and then QP Mode measurement didn't perform ◦
- (2) Measuring frequency range from 1000MHz to 6000MHz or the 10th harmonic of highest fundamental frequency ◦ "F" denotes fundamental frequency; "H" denotes spurious frequency. "E" denotes band edge frequency. (This judgment method includes the Band Edge Requirement.)
- (3) Radiated emissions measured in frequency range above 1000MHz were made with an instrument using Peak detector mode and AV detector mode of the emission ◦
- (4) Data of measurement within this frequency range shown " * " in the table above means the reading of emissions are attenuated more than 20dB below the permissible limits or the field strength is too small to be measured.
- (5) A preamp and high pass filter were used for this test in order to provide sufficient measurement sensitivity.
- (6) EUT Orthogonal Axis :
 "X" - denotes Laid on Table ; "Y" - denotes Vertical Stand ; "Z" - denotes Side Stand

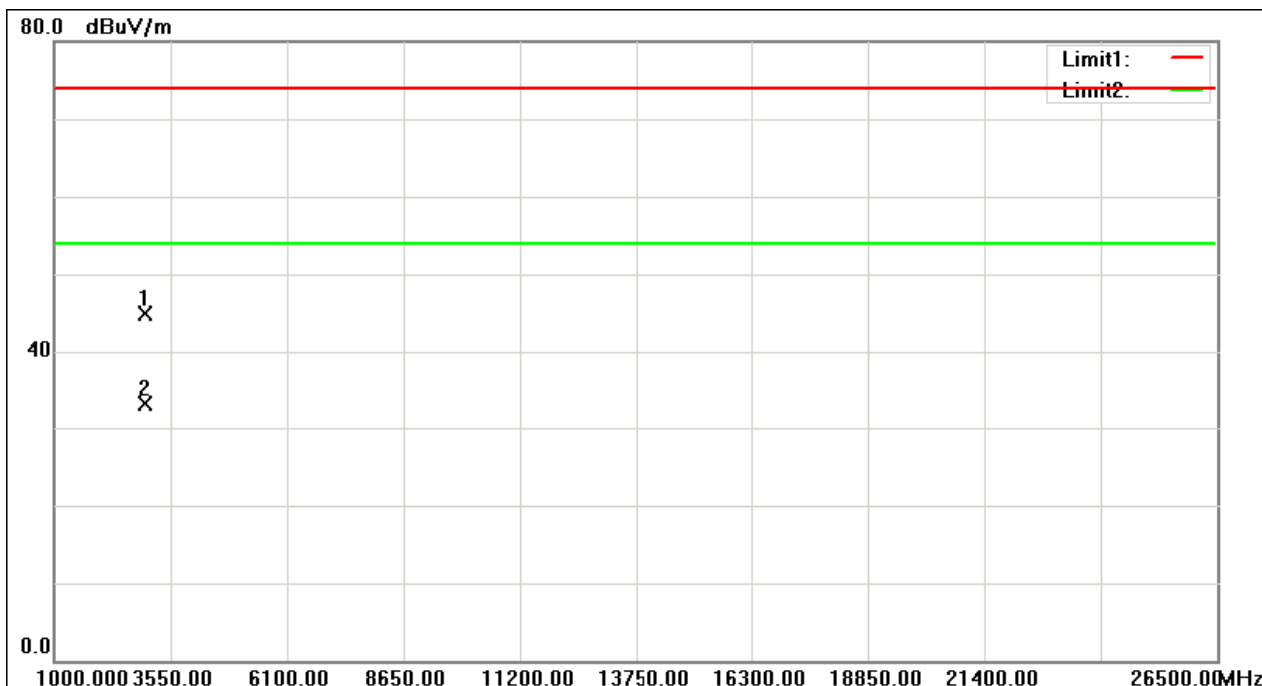



5. NUMBER OF HOPPING CHANNEL

5.1 APPLIED PROCEDURES / LIMIT

FCC Part15 (15.247) , Subpart C			
Section	Test Item	Frequency Range (MHz)	Result
15.247 (a)(1)(iii)	Number of Hopping Channel	2400-2483.5	PASS

5.1.1 MEASUREMENT INSTRUMENTS LIST AND SETTING

Item	Kind of Equipment	Manufacturer	Type No.	Serial No.	Calibrated until
1	Spectrum Analyzer	R&S	FSP 40	100185	Nov.26.2011

Remark: " N/A" denotes No Model Name , Serial No. or No Calibration specified.

Spectrum Parameters	Setting
Attenuation	Auto
Span Frequency	> Operating Frequency Range
RB	100 kHz
VB	100 kHz
Detector	Peak
Trace	Max Hold
Sweep Time	Auto

5.1.2 TEST PROCEDURE

- a. The EUT was directly connected to the spectrum analyzer and antenna output port as show in the block diagram below,
- b. Spectrum Setting : RBW= 100KHz, VBW=100KHz, Sweep time = Auto.

5.1.3 DEVIATION FROM STANDARD

No deviation.

5.1.4 TEST SETUP



5.1.5 EUT OPERATION CONDITIONS

The EUT tested system was configured as the statements of 4.1.6 Unless otherwise a special operating condition is specified in the follows during the testing.



5.1.6 TEST RESULTS

EUT :	Compact Stereo System	Model Name :	SC-HC05
Temperature :	23 °C	Relative Humidity :	58 %
Pressure :	1009 hPa	Test Voltage :	AC 120V/60Hz
Test Mode :	Hopping Mode -1Mbps		

Number of Hopping Channel	79
---------------------------	----

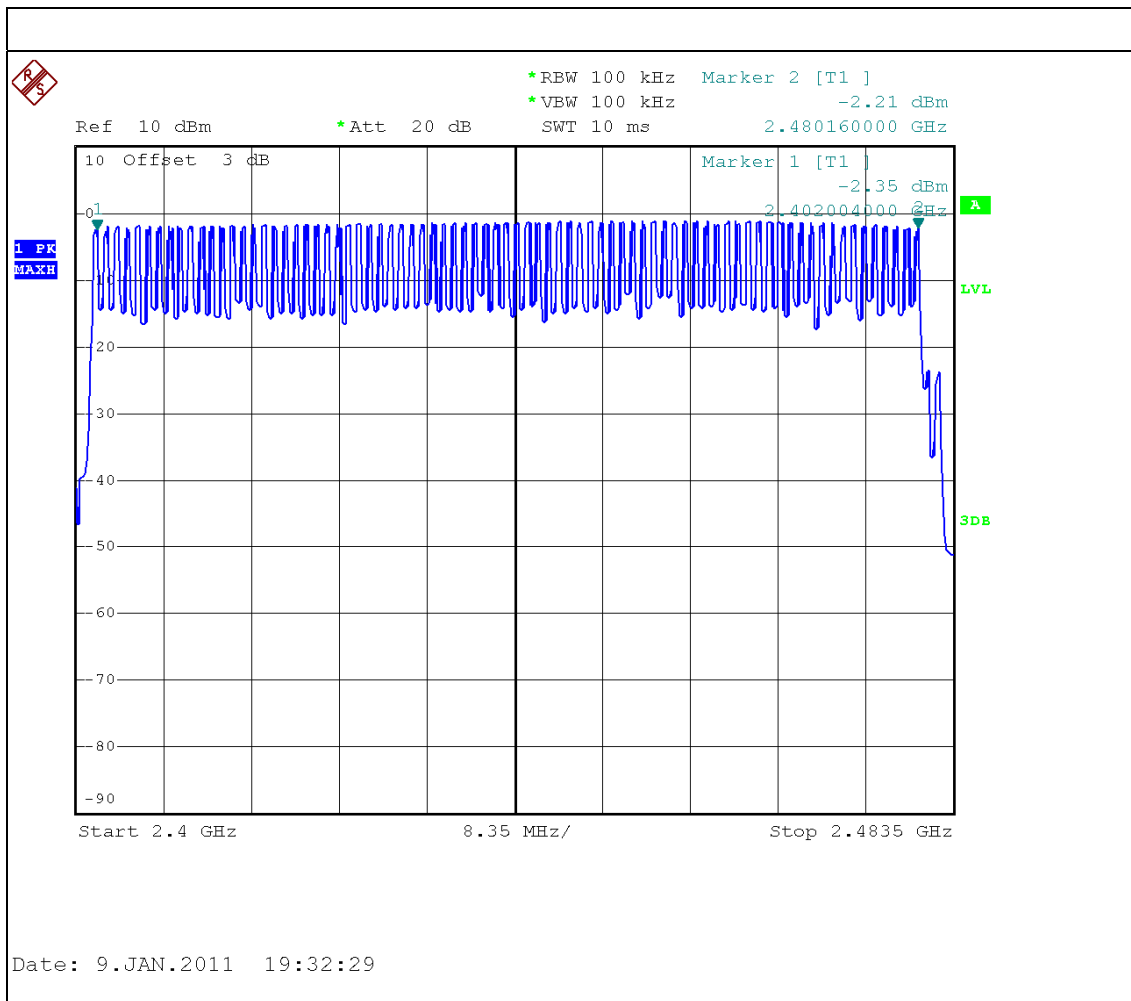



EUT :	Compact Stereo System	Model Name :	SC-HC05
Temperature :	23 °C	Relative Humidity :	58 %
Pressure :	1009 hPa	Test Voltage :	AC 120V/60Hz
Test Mode :	Hopping Mode -3Mbps		

Number of Hopping Channel	79
---------------------------	----

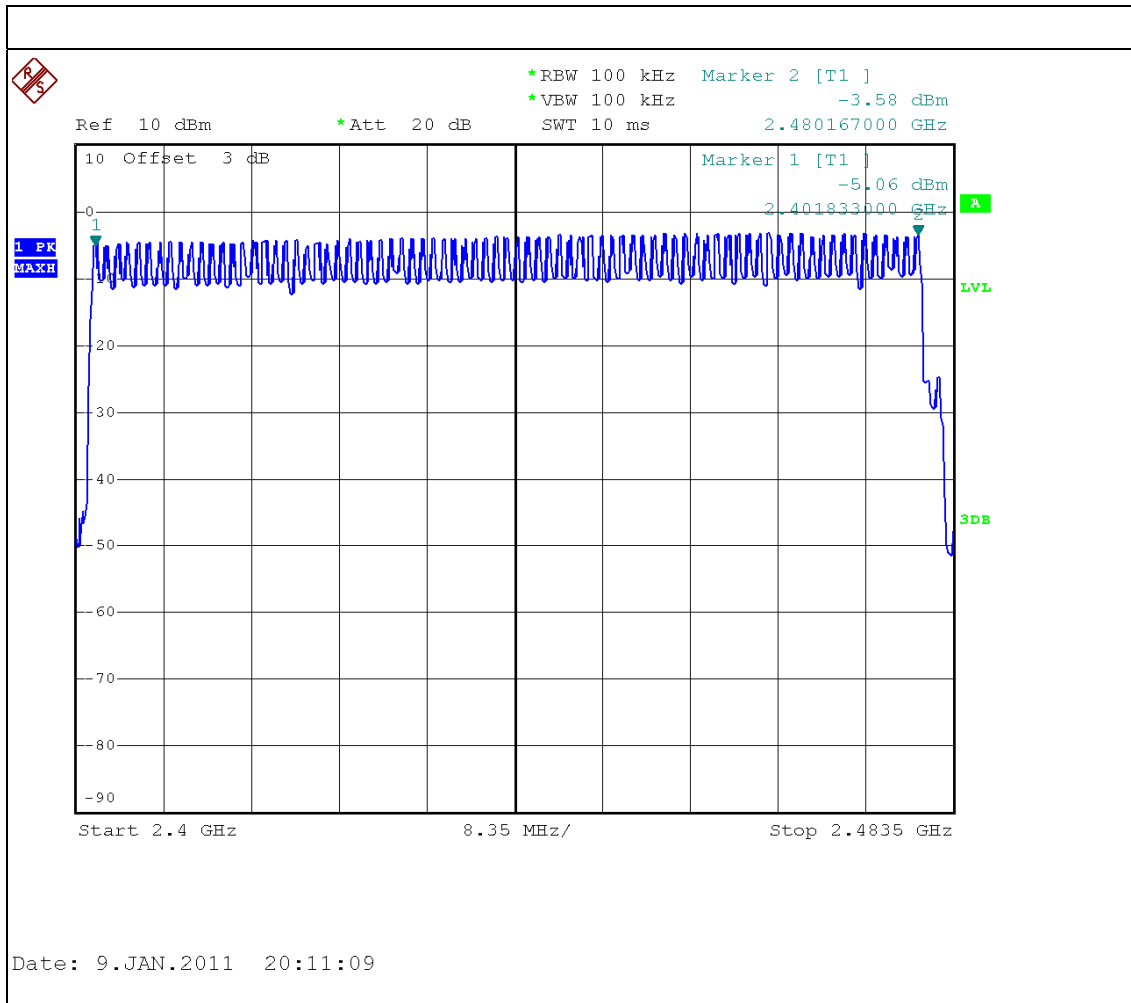



6. AVERAGE TIME OF OCCUPANCY

6.1 APPLIED PROCEDURES / LIMIT

FCC Part15 (15.247) , Subpart C				
Section	Test Item	Limit	Frequency Range (MHz)	Result
15.247 (a)(1)(iii)	Average Time of Occupancy	0.4sec	2400-2483.5	PASS

6.1.1 MEASUREMENT INSTRUMENTS LIST

Item	Kind of Equipment	Manufacturer	Type No.	Serial No.	Calibrated until
1	Spectrum Analyzer	R&S	FSP 40	100185	Nov.26.2011

Remark: " N/A" denotes No Model Name , Serial No. or No Calibration specified.

6.1.2 TEST PROCEDURE

- a. The transmitter output (antenna port) was connected to the spectrum analyzer
- b. Set RBW of spectrum analyzer to 1MHz and VBW to 1MHz.
- c. Use a video trigger with the trigger level set to enable triggering only on full pulses.
- d. Sweep Time is more than once pulse time.
- e. Set the center frequency on any frequency would be measure and set the frequency span to zero span.
- f. Measure the maximum time duration of one single pulse.
- g. Set the EUT for DH5, DH3 and DH1 packet transmitting.
- h. Measure the maximum time duration of one single pulse.
- i. DH5 Packet permit maximum $1600 / 79 / 6 = 3.37$ hops per second in each channel (5 time slots RX, 1 time slot TX). So, the dwell time is the time duration of the pulse times $3.37 \times 31.6 = 106.6$ within 31.6 seconds.
- j. DH3 Packet permit maximum $1600 / 79 / 4 = 5.06$ hops per second in each channel (3 time slots RX, 1 time slot TX). So, the dwell time is the time duration of the pulse times $5.06 \times 31.6 = 160$ within 31.6 seconds.
- k. DH1 Packet permit maximum $1600 / 79 / 2 = 10.12$ hops per second in each channel (1 time slot RX, 1 time slot TX). So, the dwell time is the time duration of the pulse times $10.12 \times 31.6 = 320$ within 31.6 seconds.

6.1.3 DEVIATION FROM STANDARD

No deviation.



6.1.4 TEST SETUP

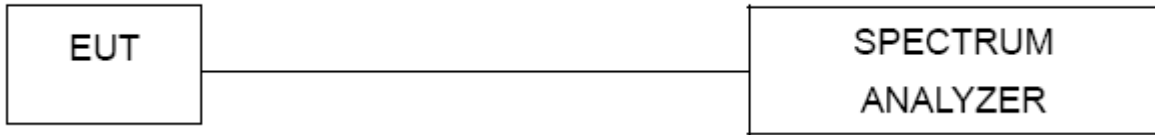

6.1.5 EUT OPERATION CONDITIONS

The EUT tested system was configured as the statements of 4.1.6 Unless otherwise a special operating condition is specified in the follows during the testing.



6.1.6 TEST RESULTS

EUT :	Compact Stereo System	Model Name :	SC-HC05
Temperature :	23 °C	Relative Humidity :	58 %
Pressure :	1009 hPa	Test Voltage :	AC 120V/60Hz
Test Mode :	CH00-DH1/DH3/DH5 -1Mbps		

Data Packet	Frequency	Pulse Duration (ms)	Dwell Time (s)	Limits (s)
DH5	2402 MHz	3.1440	0.3354	0.4000
DH3	2402 MHz	1.8360	0.2938	0.4000
DH1	2402 MHz	0.5360	0.1715	0.4000

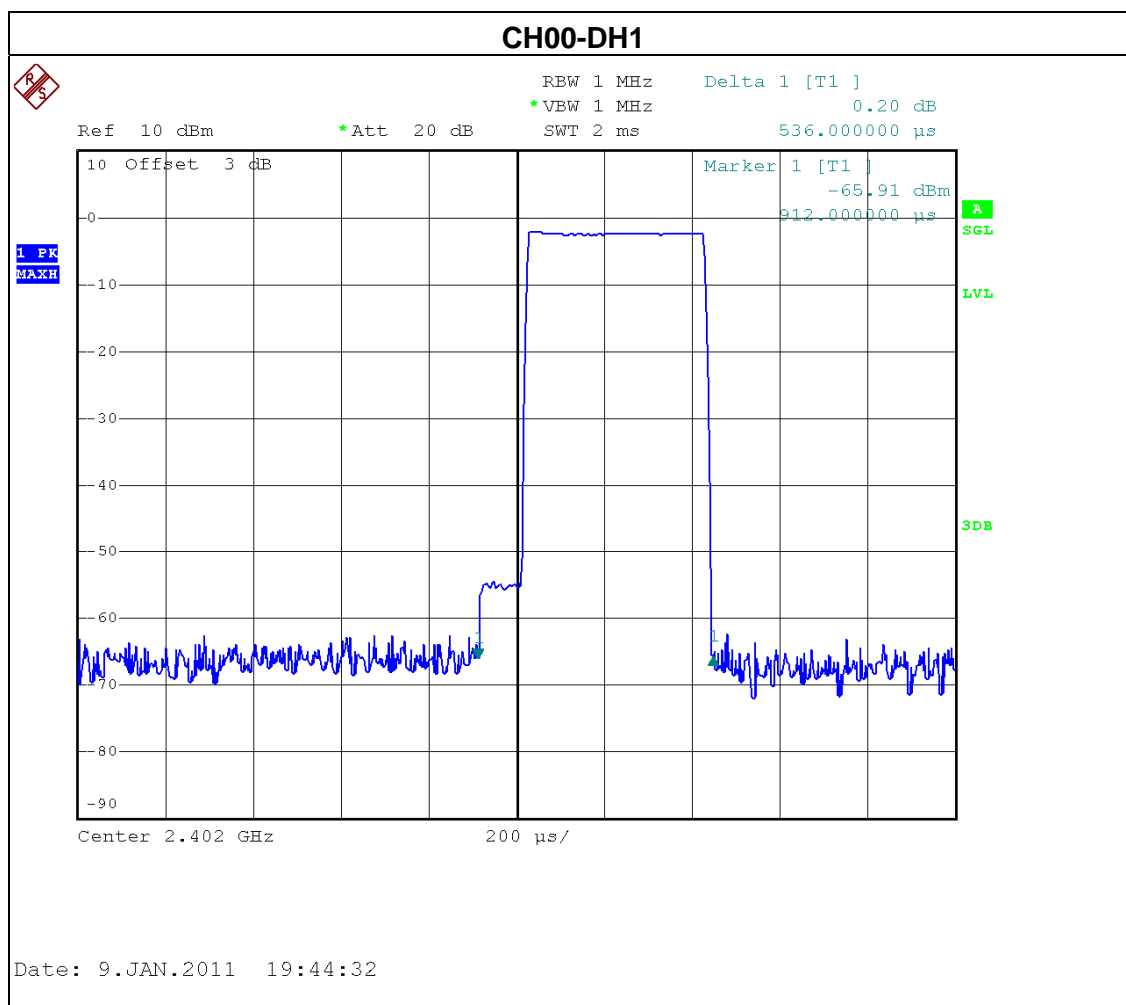

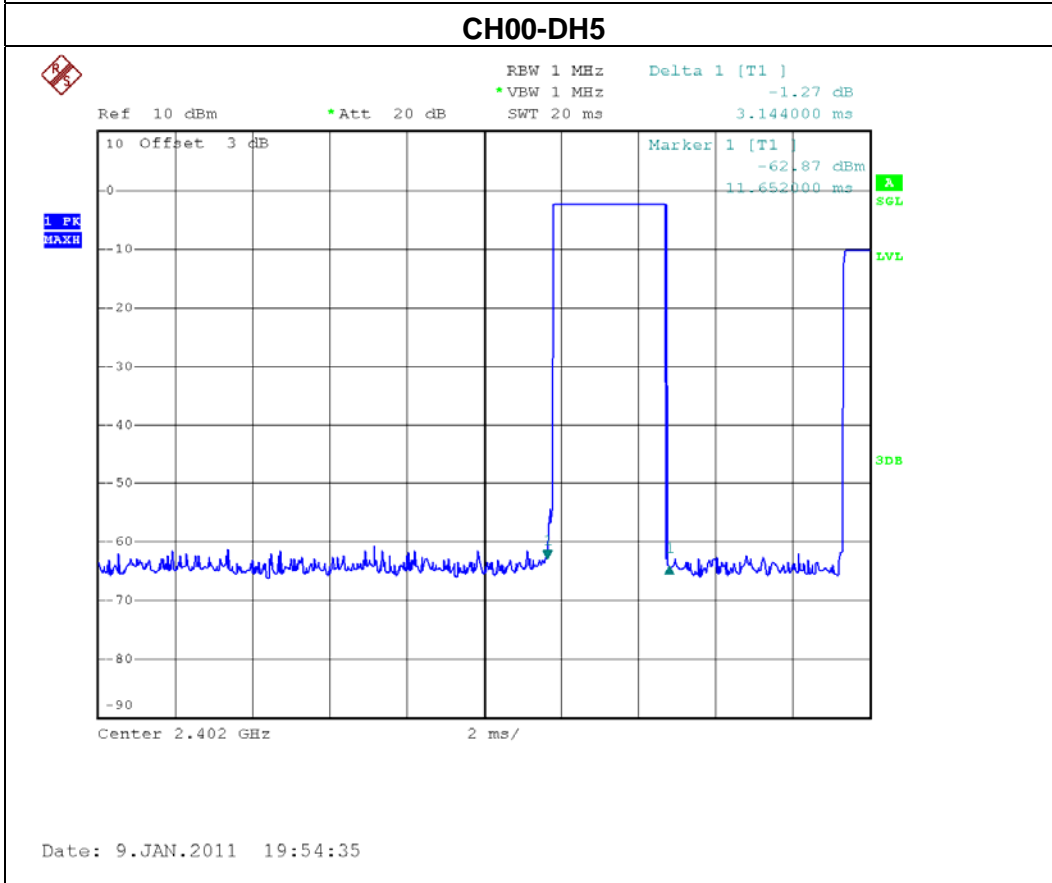
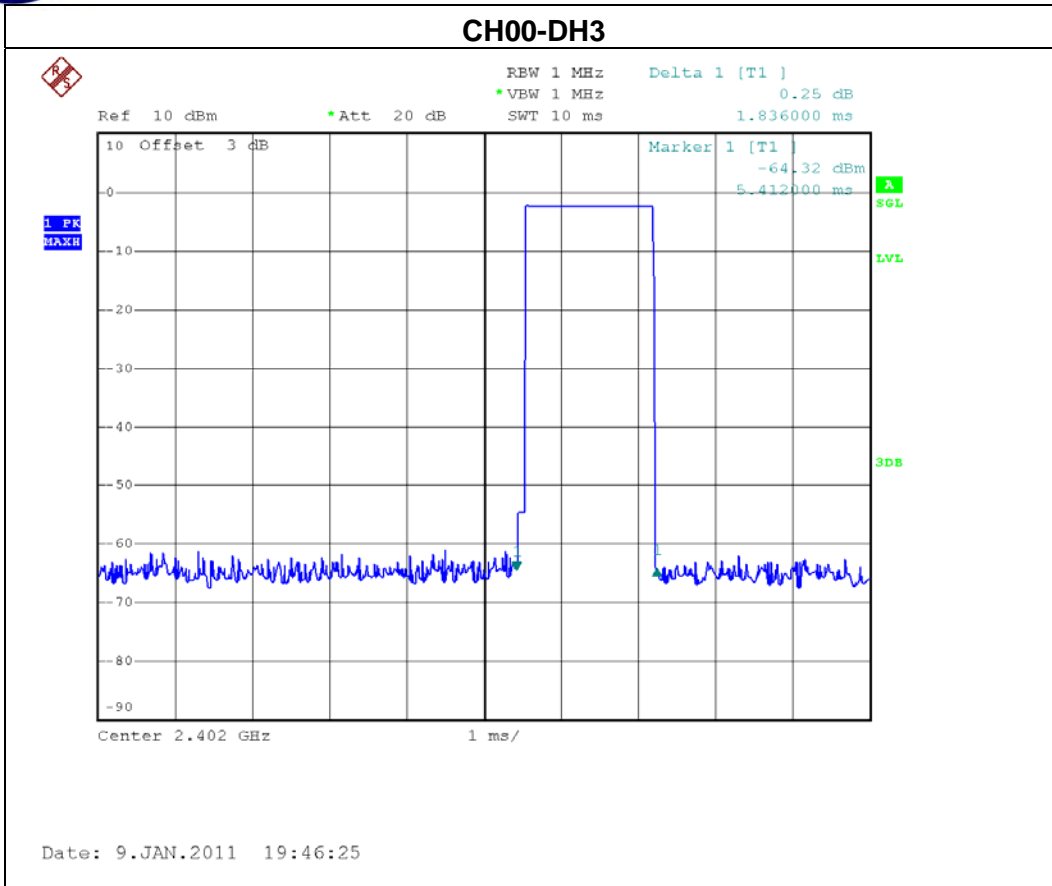



EUT :	Compact Stereo System	Model Name :	SC-HC05
Temperature :	23 °C	Relative Humidity :	58 %
Pressure :	1009 hPa	Test Voltage :	AC 120V/60Hz
Test Mode :	CH39 -DH1/DH3/DH5 -1Mbps		

Data Packet	Frequency	Pulse Duration (ms)	Dwell Time (s)	Limits (s)
DH5	2441 MHz	3.1440	0.3354	0.4000
DH3	2441 MHz	1.8560	0.2970	0.4000
DH1	2441 MHz	0.5440	0.1741	0.4000

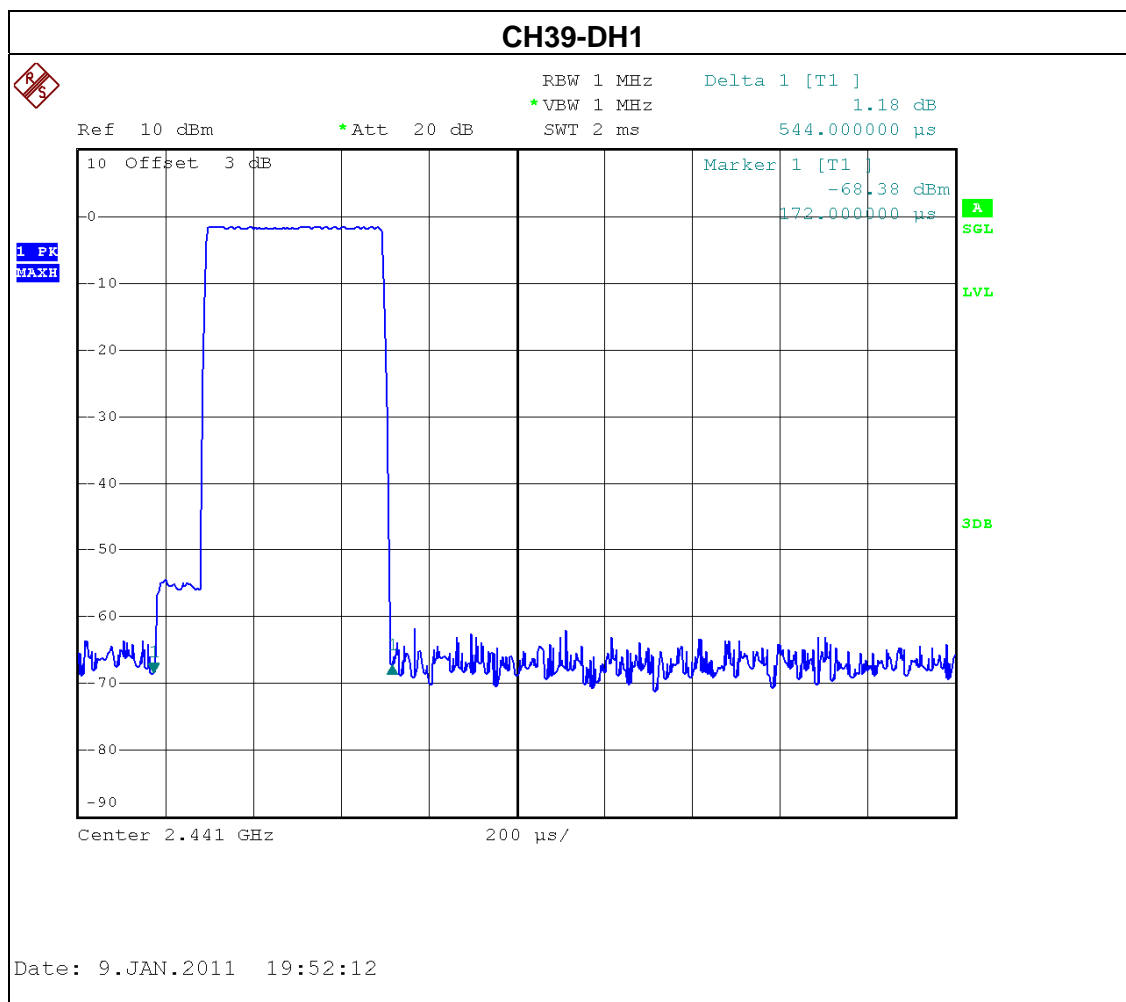



CH39-DH3

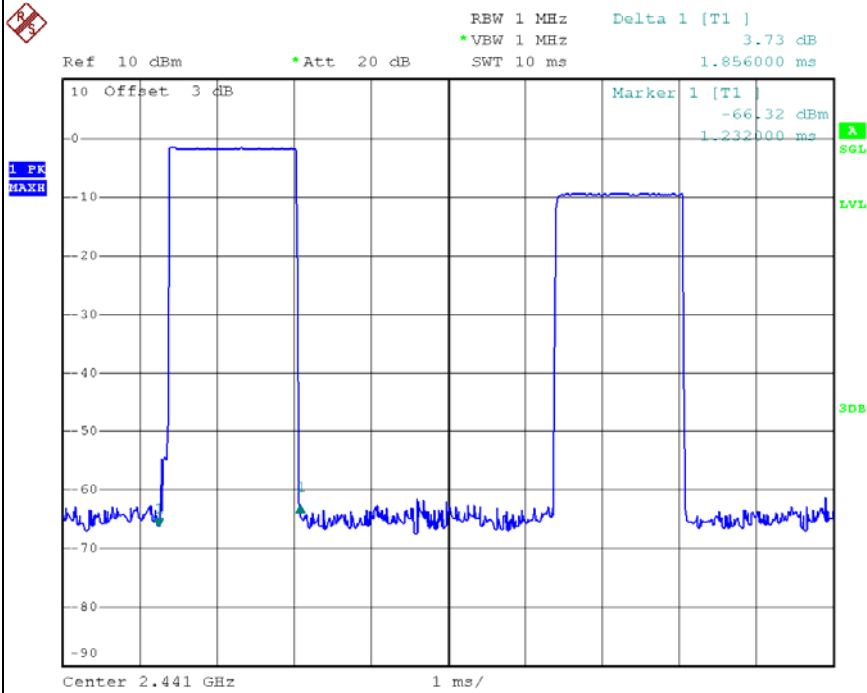

Date: 9.JAN.2011 19:47:07

CH39-DH5

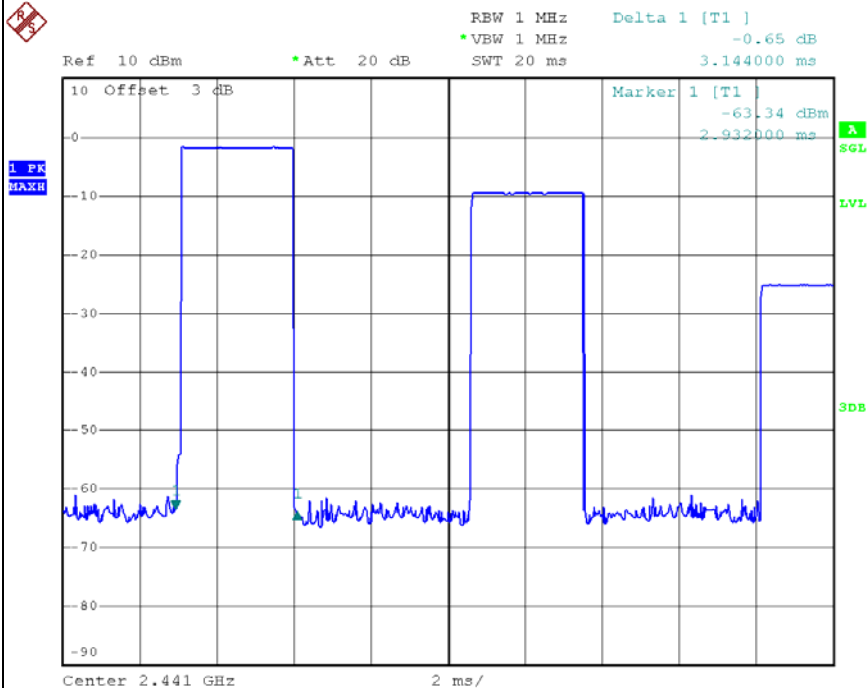

Date: 9.JAN.2011 19:53:43



EUT :	Compact Stereo System	Model Name :	SC-HC05
Temperature :	23 °C	Relative Humidity :	58 %
Pressure :	1009 hPa	Test Voltage :	AC 120V/60Hz
Test Mode :	CH78 -DH1/DH3/DH5-1Mbps		

Data Packet	Frequency	Pulse Duration (ms)	Dwell Time (s)	Limits (s)
DH5	2480 MHz	3.1040	0.3311	0.4000
DH3	2480 MHz	1.8560	0.2970	0.4000
DH1	2480 MHz	0.5400	0.1728	0.4000

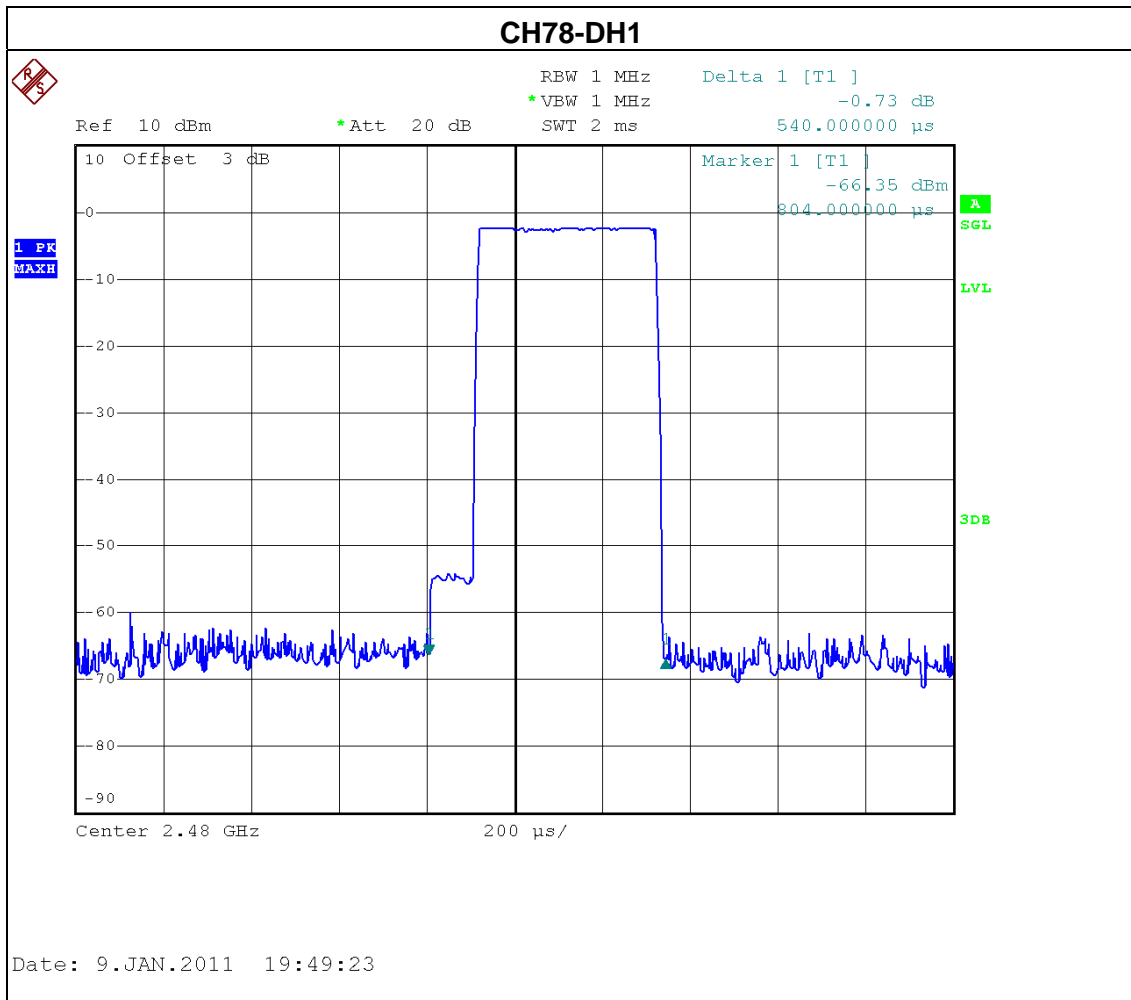

Date: 9.JAN.2011 19:49:23

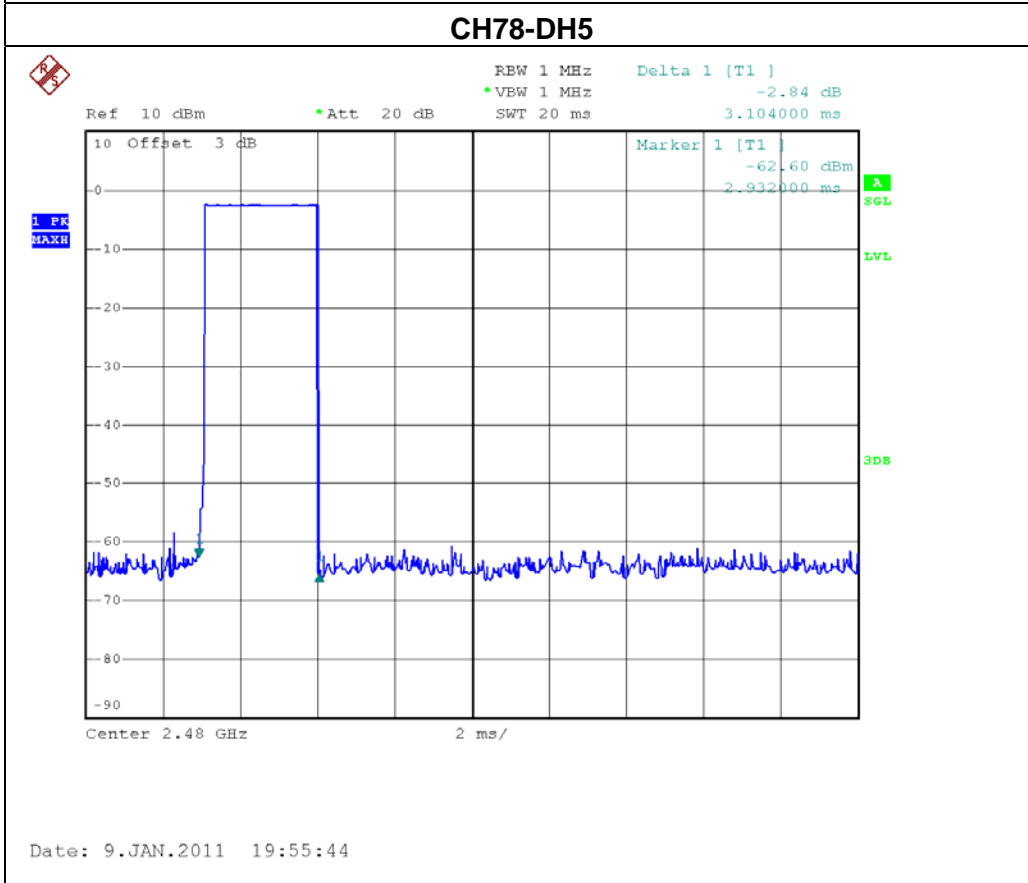
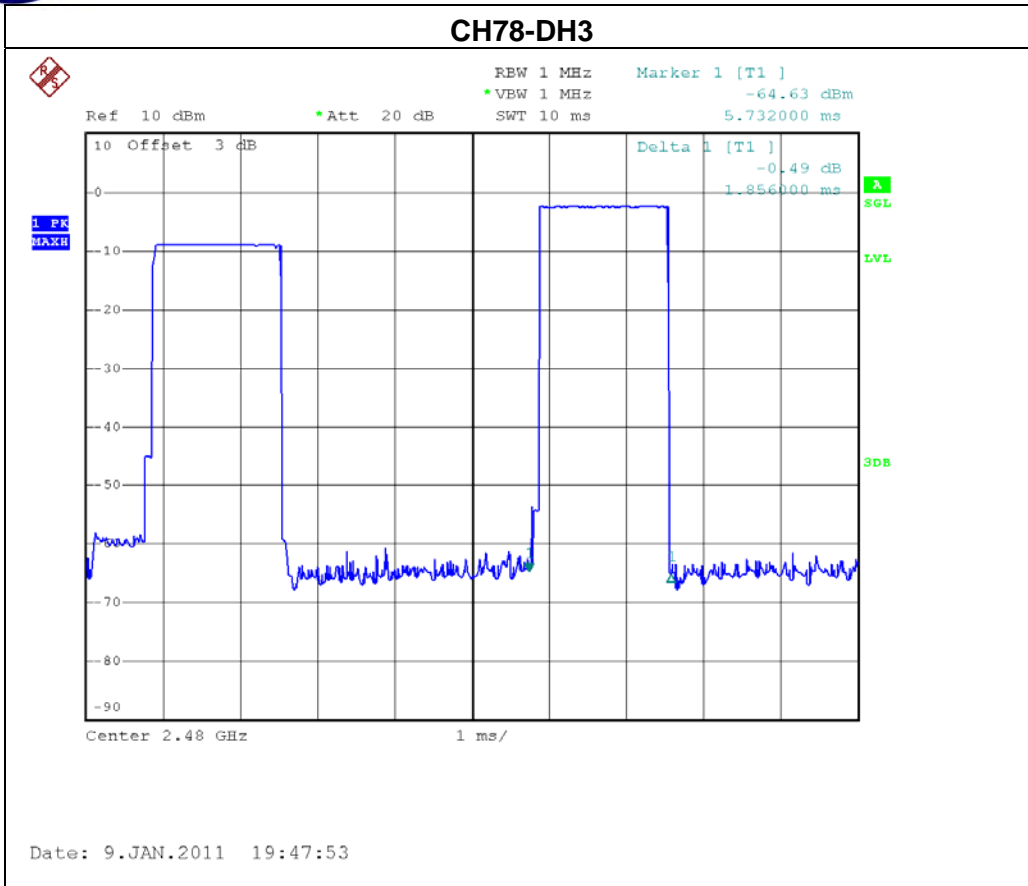



EUT :	Compact Stereo System	Model Name :	SC-HC05
Temperature :	23 °C	Relative Humidity :	58 %
Pressure :	1009 hPa	Test Voltage :	AC 120V/60Hz
Test Mode :	CH00-DH1/DH3/DH5 -3Mbps		

Data Packet	Frequency	Pulse Duration (ms)	Dwell Time (s)	Limits (s)
DH5	2402 MHz	3.1560	0.3366	0.4000
DH3	2402 MHz	1.8360	0.2938	0.4000
DH1	2402 MHz	0.5560	0.1779	0.4000

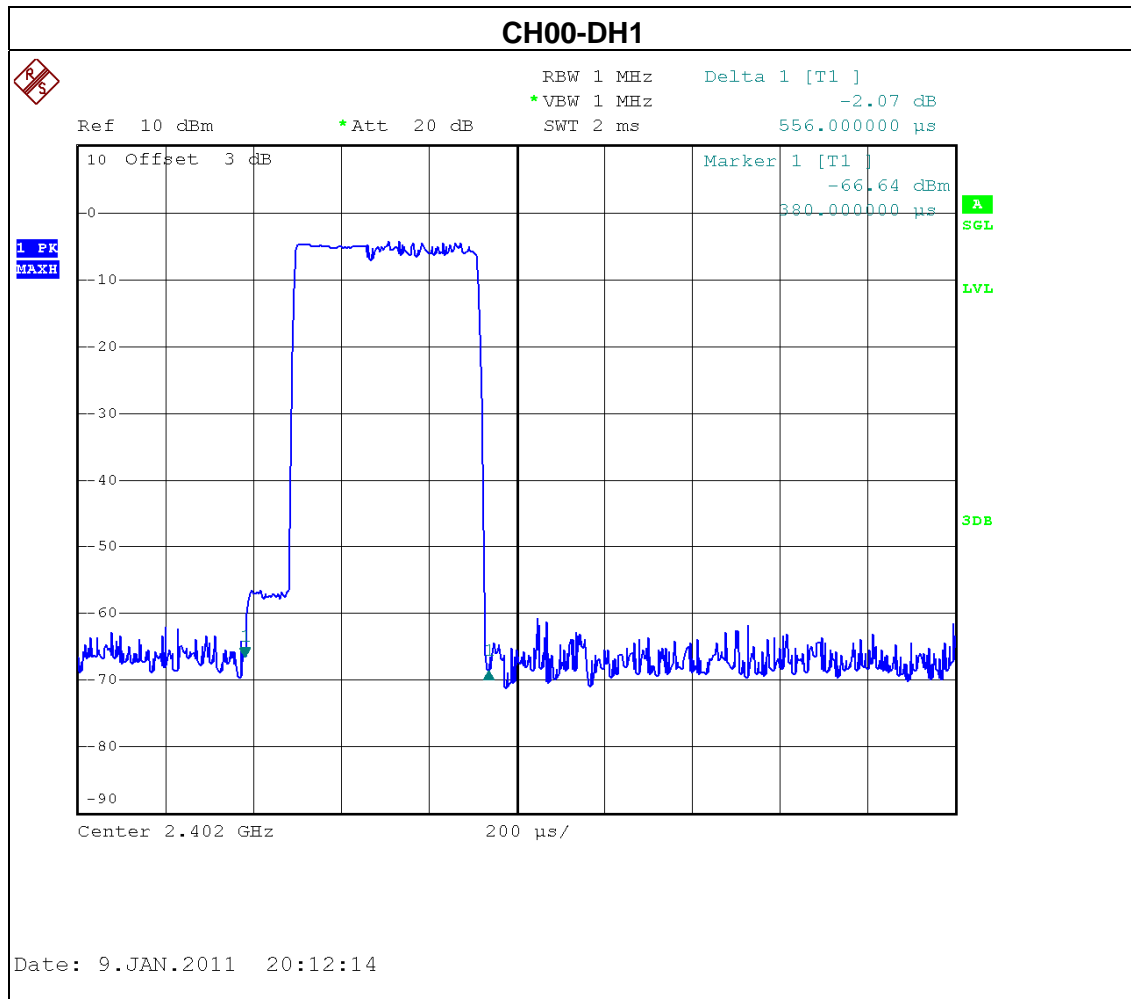



CH00-DH3

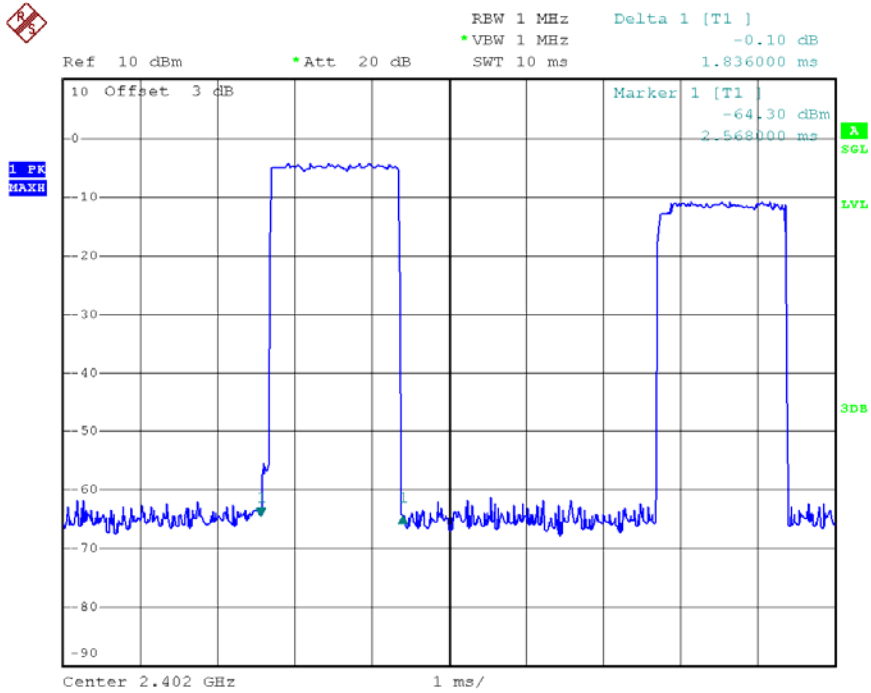

Date: 9.JAN.2011 20:15:55

CH00-DH5

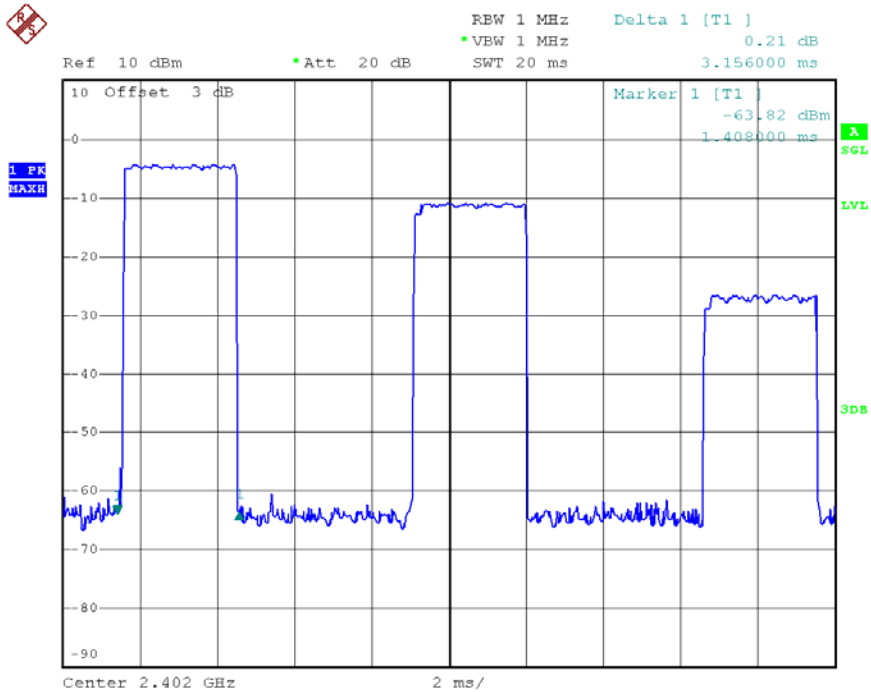

Date: 9.JAN.2011 20:17:01



EUT :	Compact Stereo System	Model Name :	SC-HC05
Temperature :	23 °C	Relative Humidity :	58 %
Pressure :	1009 hPa	Test Voltage :	AC 120V/60Hz
Test Mode :	CH39 -DH1/DH3/DH5 -3Mbps		

Data Packet	Frequency	Pulse Duration (ms)	Dwell Time (s)	Limits (s)
DH5	2441 MHz	3.1560	0.3366	0.4000
DH3	2441 MHz	1.8360	0.2938	0.4000
DH1	2441 MHz	0.5560	0.1779	0.4000

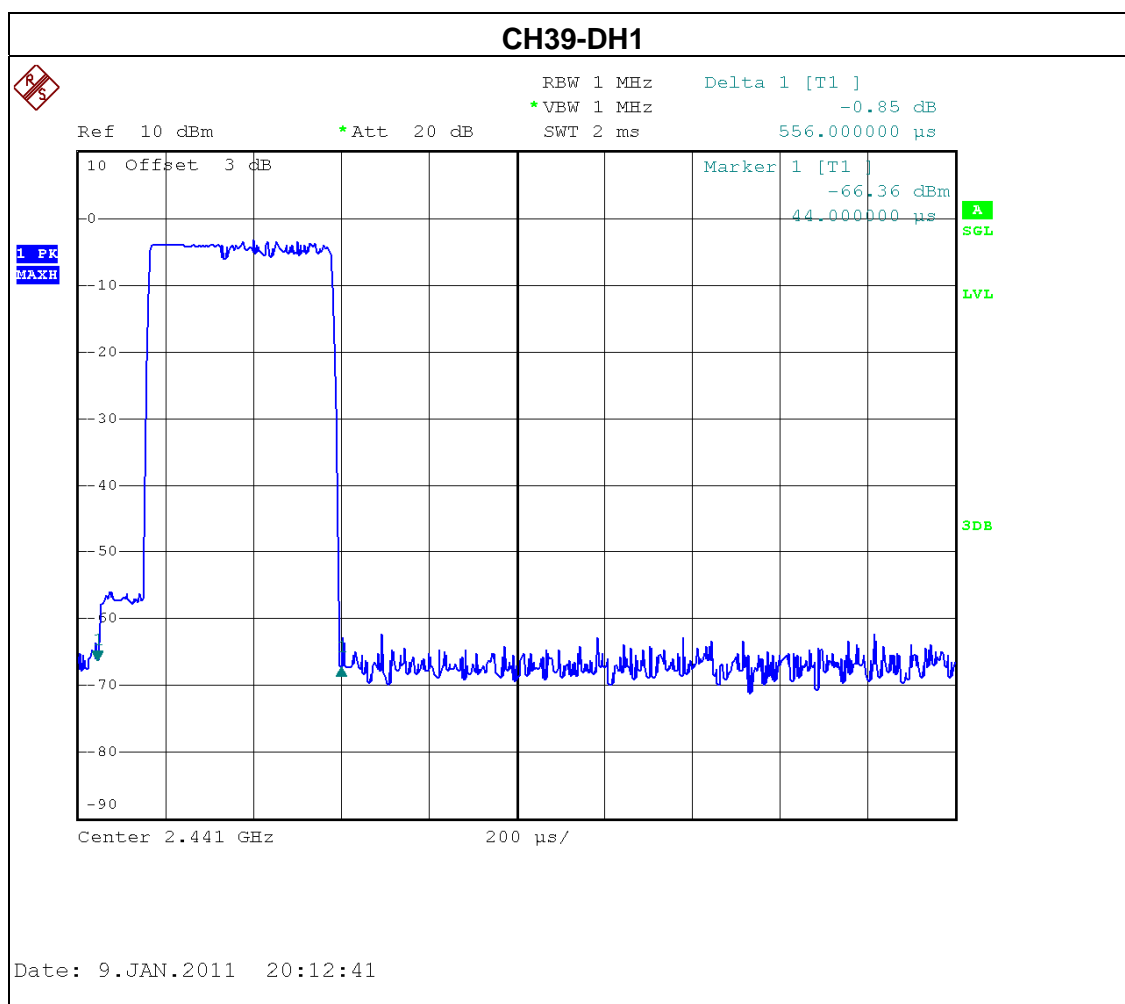

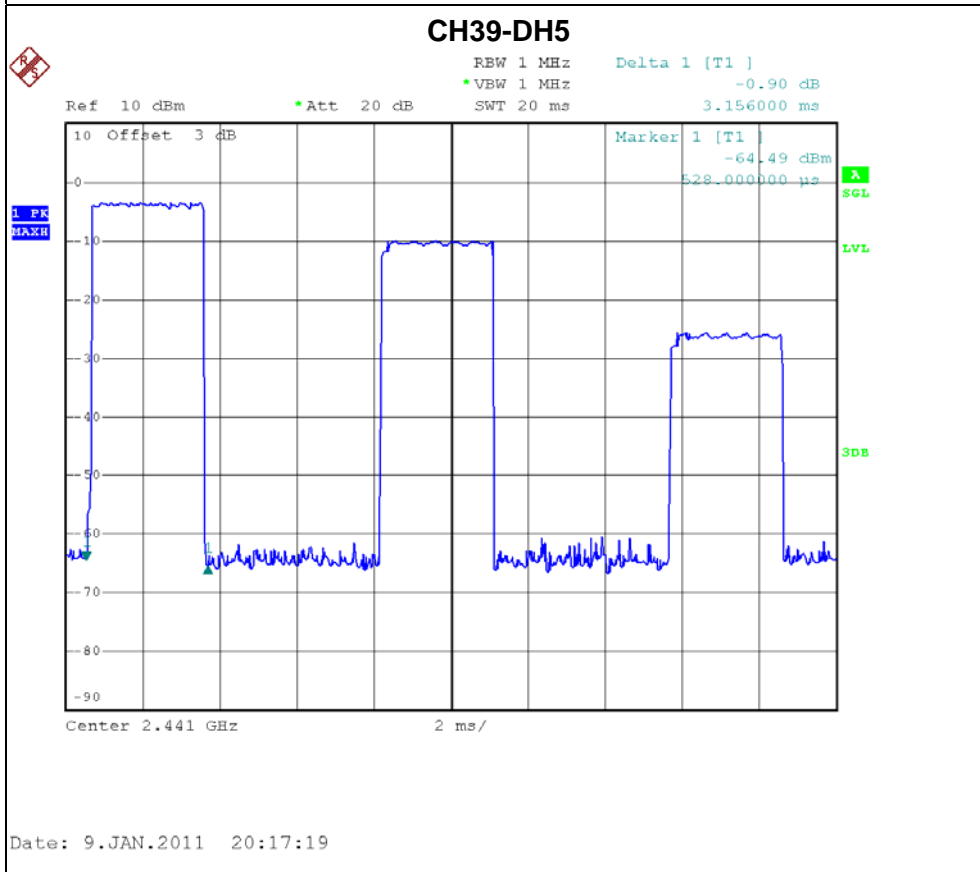
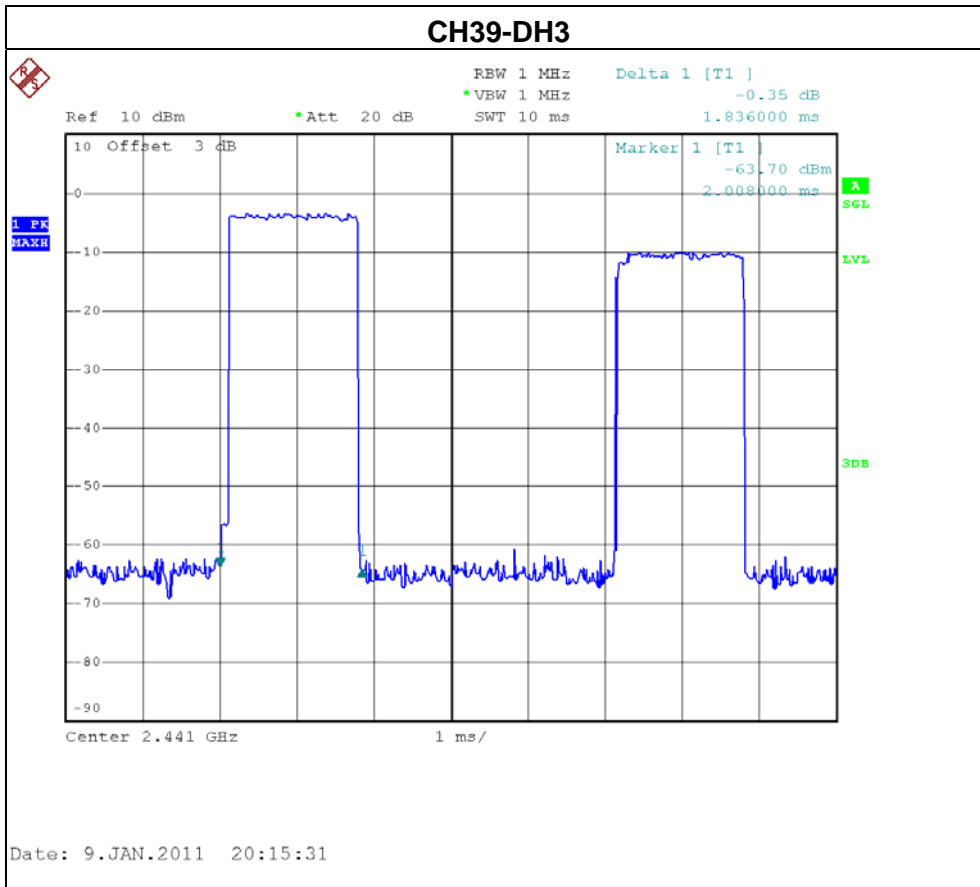



EUT :	Compact Stereo System	Model Name :	SC-HC05
Temperature :	23 °C	Relative Humidity :	58 %
Pressure :	1009 hPa	Test Voltage :	AC 120V/60Hz
Test Mode :	CH78 -DH1/DH3/DH5-3Mbps		

Data Packet	Frequency	Pulse Duration (ms)	Dwell Time (s)	Limits (s)
DH5	2480 MHz	3.1560	0.3366	0.4000
DH3	2480 MHz	1.8360	0.2938	0.4000
DH1	2480 MHz	0.5560	0.1779	0.4000

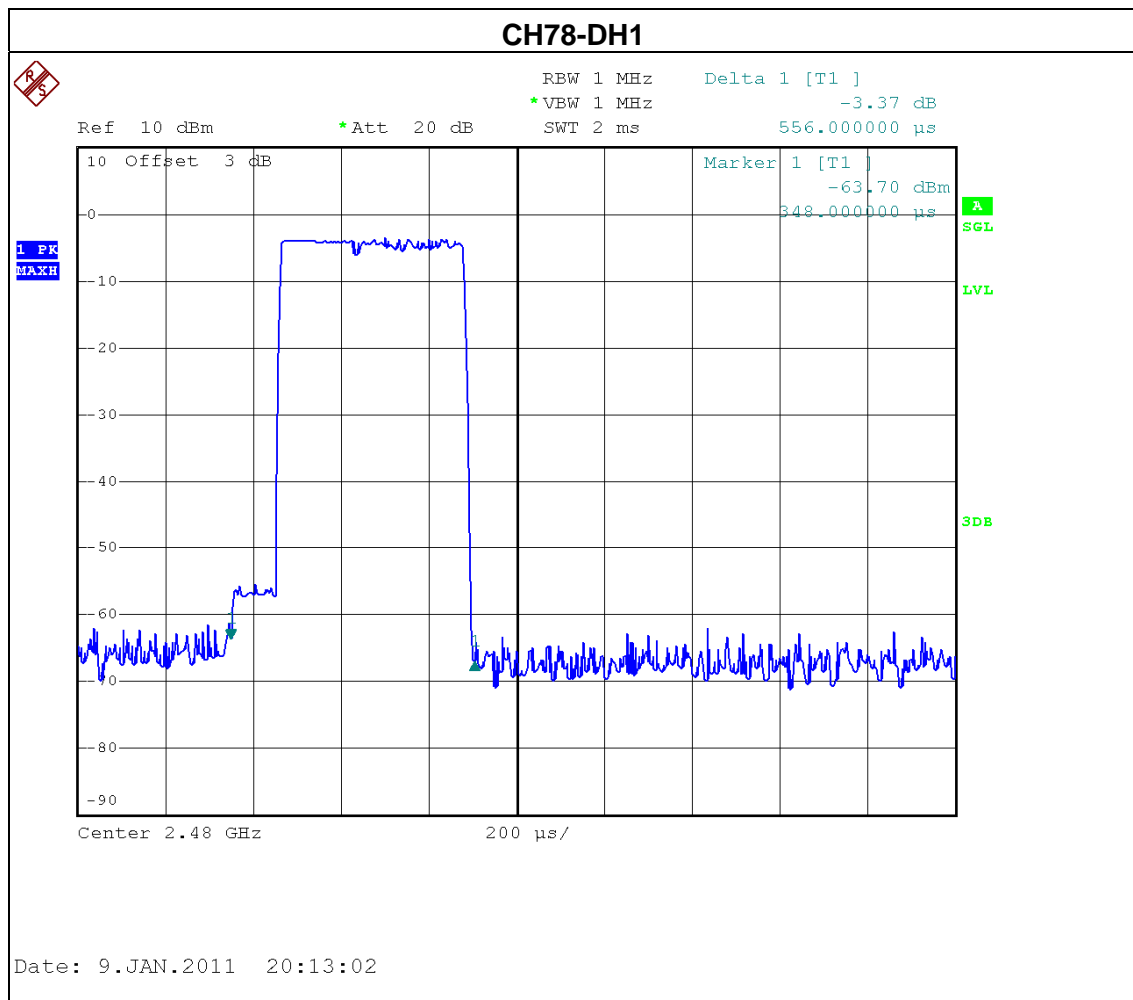

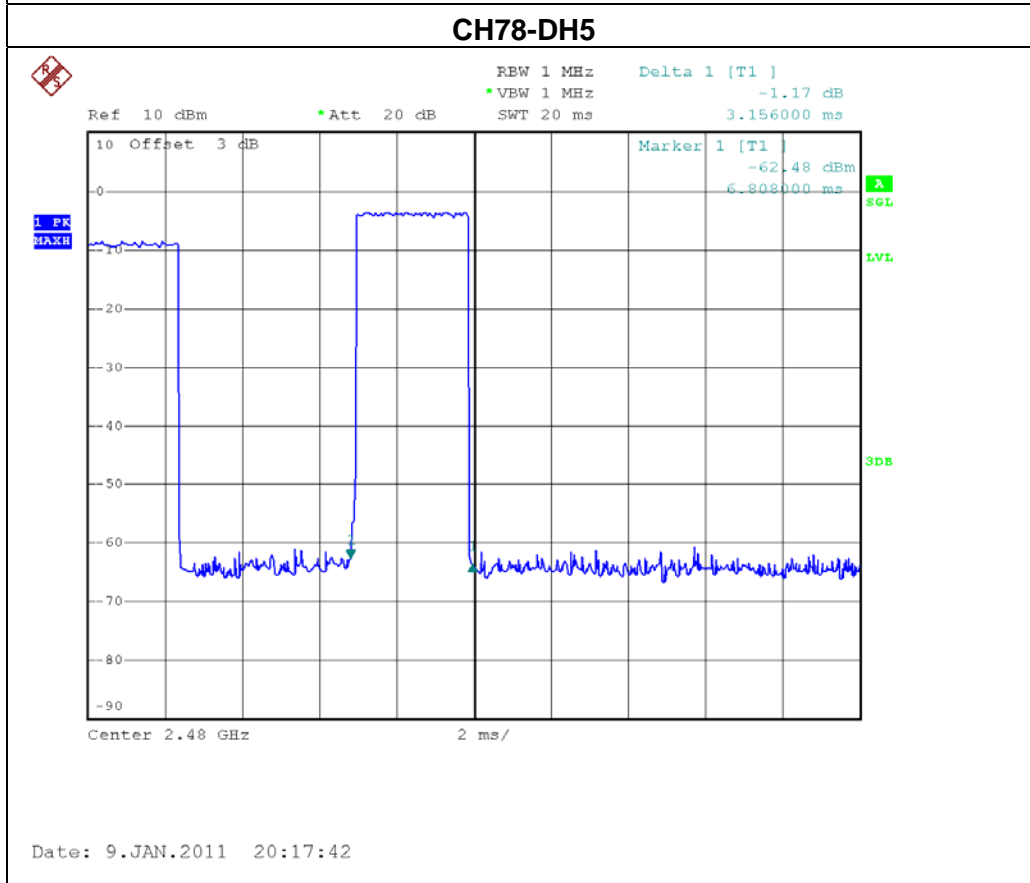
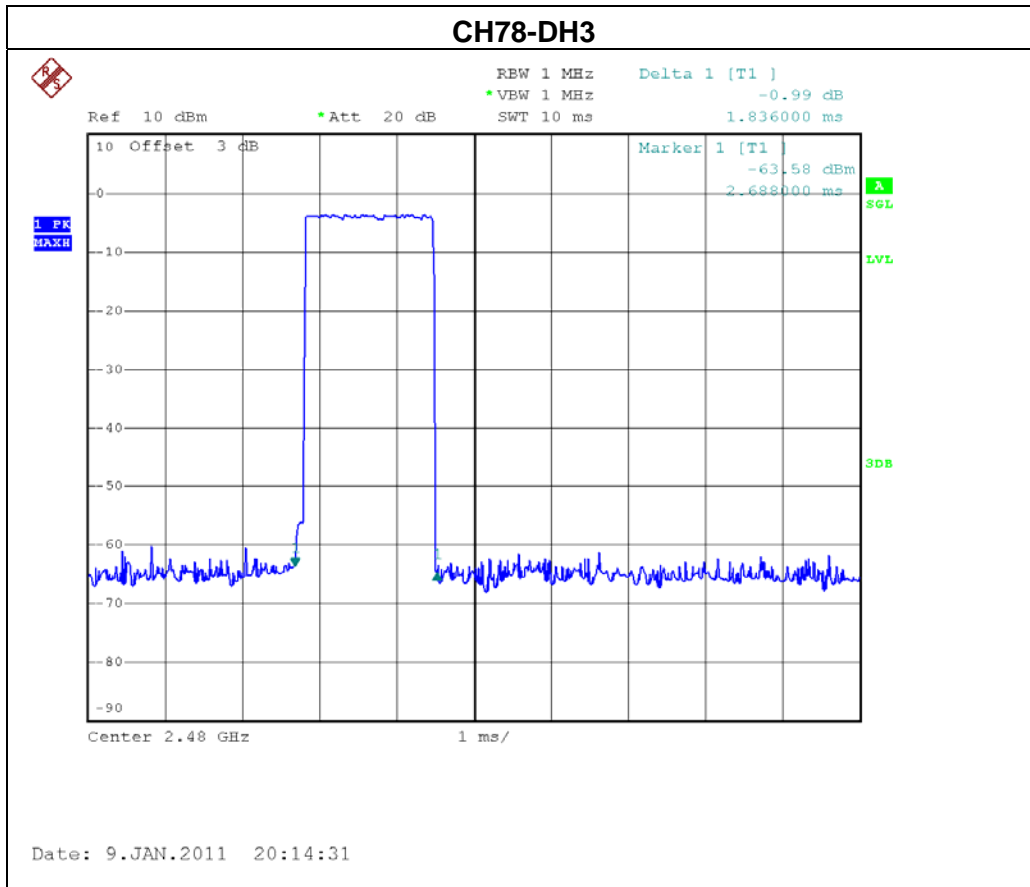

7. HOPPING CHANNEL SEPARATION MEASUREMENT

7.1 APPLIED PROCEDURES / LIMIT

Frequency hopping systems operating in the 2400-2483.5 MHz band may have hopping channel carrier frequencies that are separated by 25 kHz or two-thirds of the 20 dB bandwidth of the hopping channel, whichever is greater.

7.1.1 MEASUREMENT INSTRUMENTS LIST AND SETTING

Item	Kind of Equipment	Manufacturer	Type No.	Serial No.	Calibrated until
1	Spectrum Analyzer	R&S	FSP 40	100185	Nov.26.2011

Remark: " N/A" denotes No Model Name , Serial No. or No Calibration specified.

Spectrum Parameter	Setting
Attenuation	Auto
Span Frequency	> Measurement Bandwidth or Channel Separation
RB	30 kHz
VB	100 kHz
Detector	Peak
Trace	Max Hold
Sweep Time	Auto

7.1.2 TEST PROCEDURE

- a. The EUT must have its hopping function enabled
- b. Span = wide enough to capture the peaks of two adjacent channels
 Resolution (or IF) Bandwidth (RBW) \geq 1% of the span
 Video (or Average) Bandwidth (VBW) \geq RBW
 Sweep = auto
 Detector function = peak
 Trace = max hold

7.1.3 DEVIATION FROM STANDARD

No deviation.

7.1.4 TEST SETUP

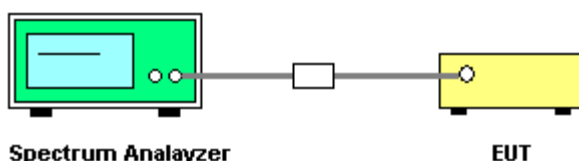

7.1.5 EUT OPERATION CONDITIONS

The EUT was programmed to be in hopping mode.



7.1.6 TEST RESULTS

EUT :	Compact Stereo System	Model Name :	SC-HC05
Temperature :	23 °C	Relative Humidity :	58 %
Pressure :	1009 hPa	Test Voltage :	AC 120V/60Hz
Test Mode :	CH00 / CH39 /CH78-1Mbps		

Frequency	Ch. Separation (MHz)	20dB Bandwidth (kHz)	Result
2402 MHz	1	910.00	Complies
2441 MHz	1	910.00	Complies
2480 MHz	1	910.00	Complies

Ch. Separation Limits: >20dB bandwidth or >2/3 of 20dB bandwidth

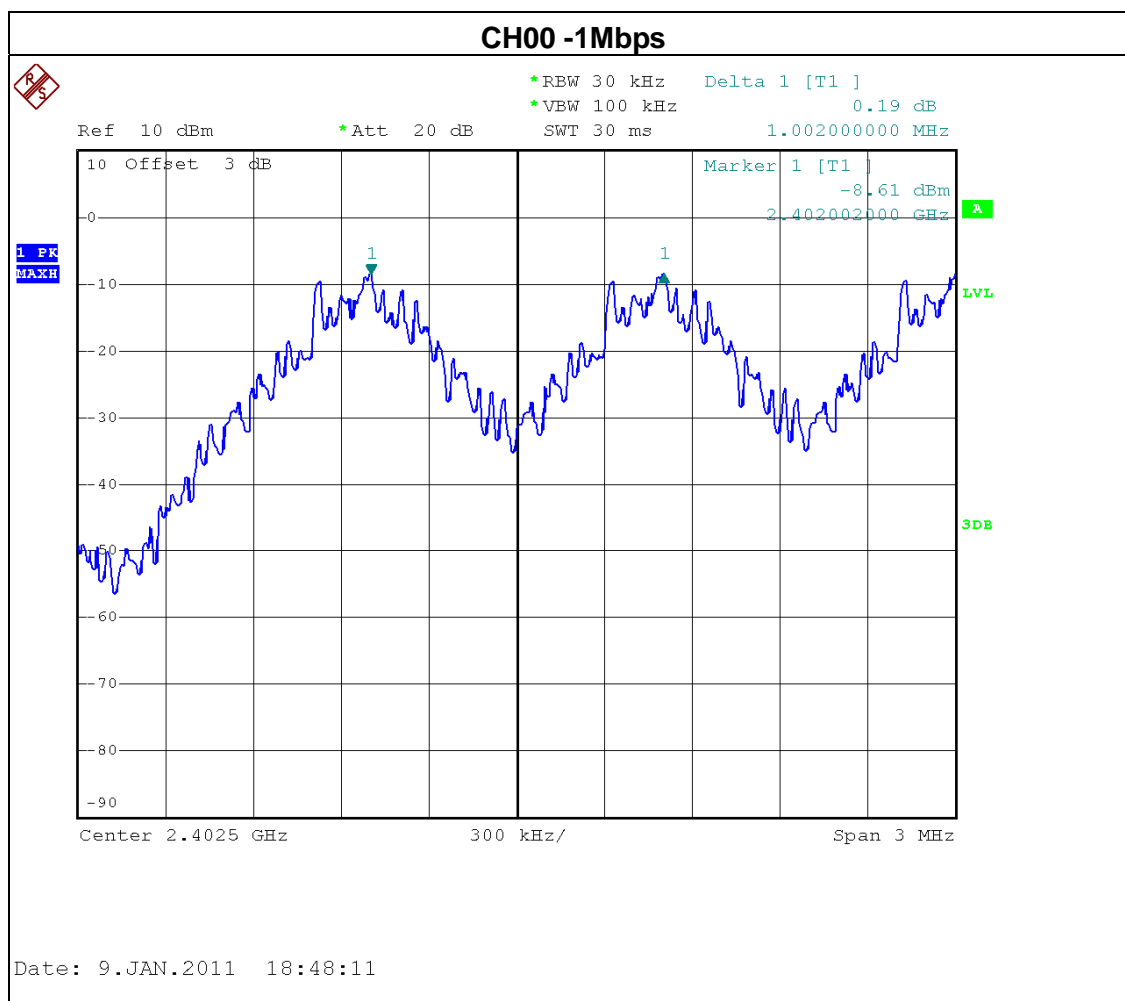



CH39 -1Mbps

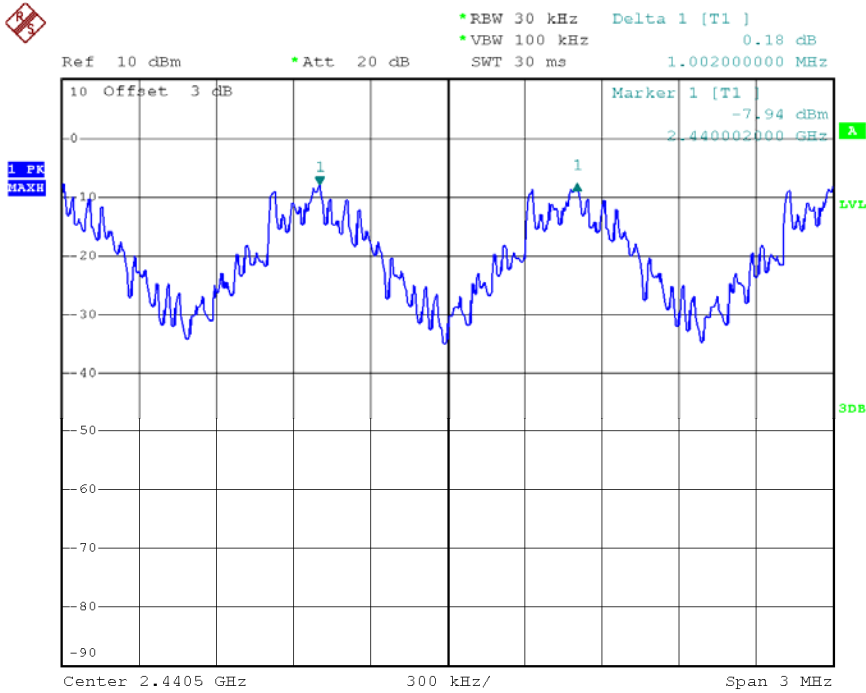

Date: 9.JAN.2011 18:47:04

CH78 -1Mbps

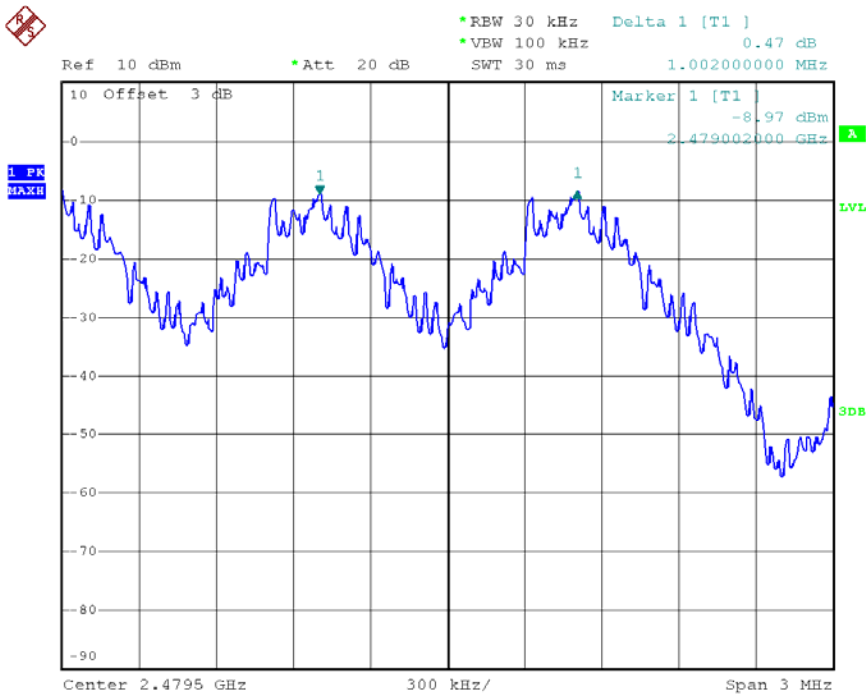

Date: 9.JAN.2011 18:45:54



EUT :	Compact Stereo System	Model Name :	SC-HC05
Temperature :	23 °C	Relative Humidity :	58 %
Pressure :	1009 hPa	Test Voltage :	AC 120V/60Hz
Test Mode :	CH00 / CH39 /CH78-3Mbps		

Frequency	Ch. Separation (MHz)	20dB Bandwidth (kHz)	Result
2402 MHz	1	1200.00	Complies
2441 MHz	1	1200.00	Complies
2480 MHz	1	1190.00	Complies

Ch. Separation Limits: >20dB bandwidth or >2/3 of 20dB bandwidth

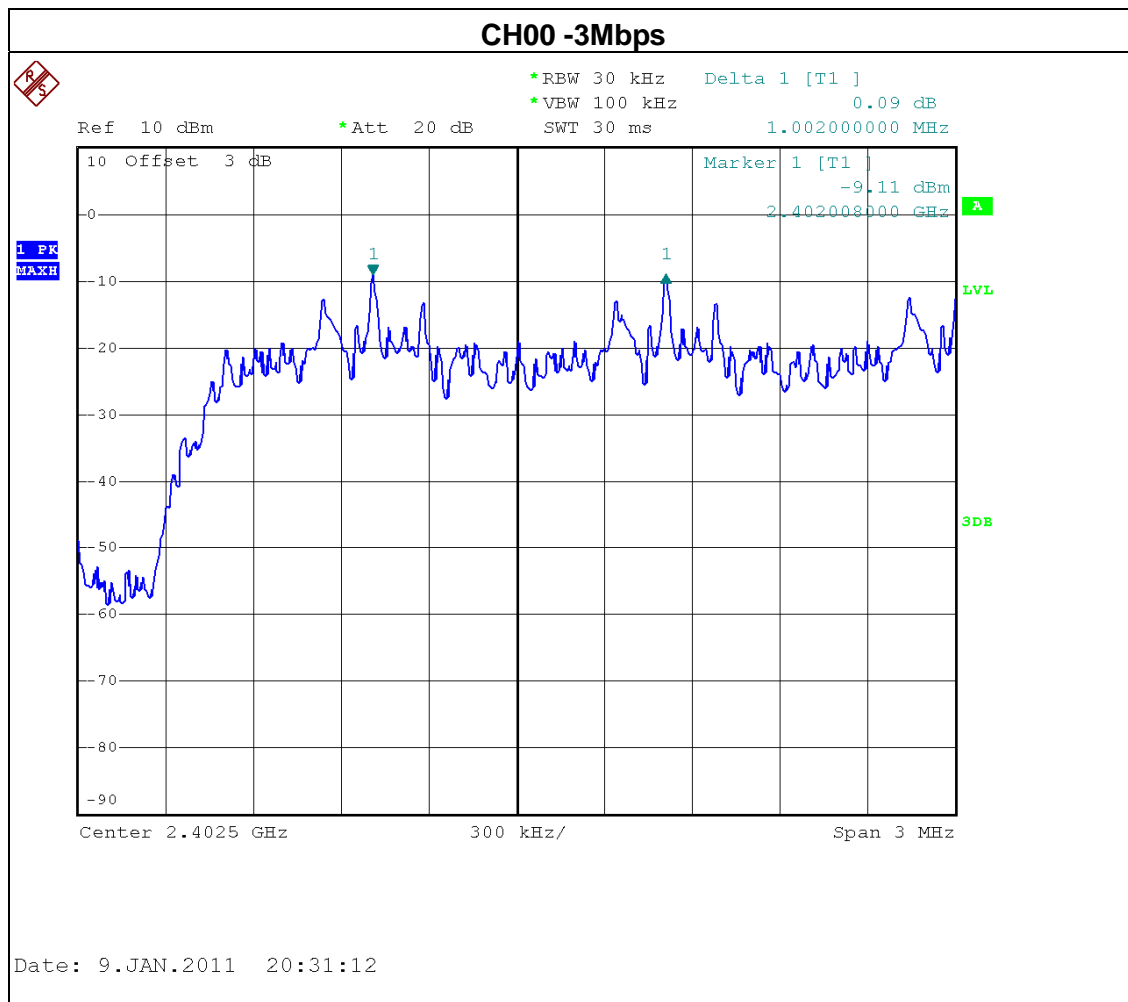

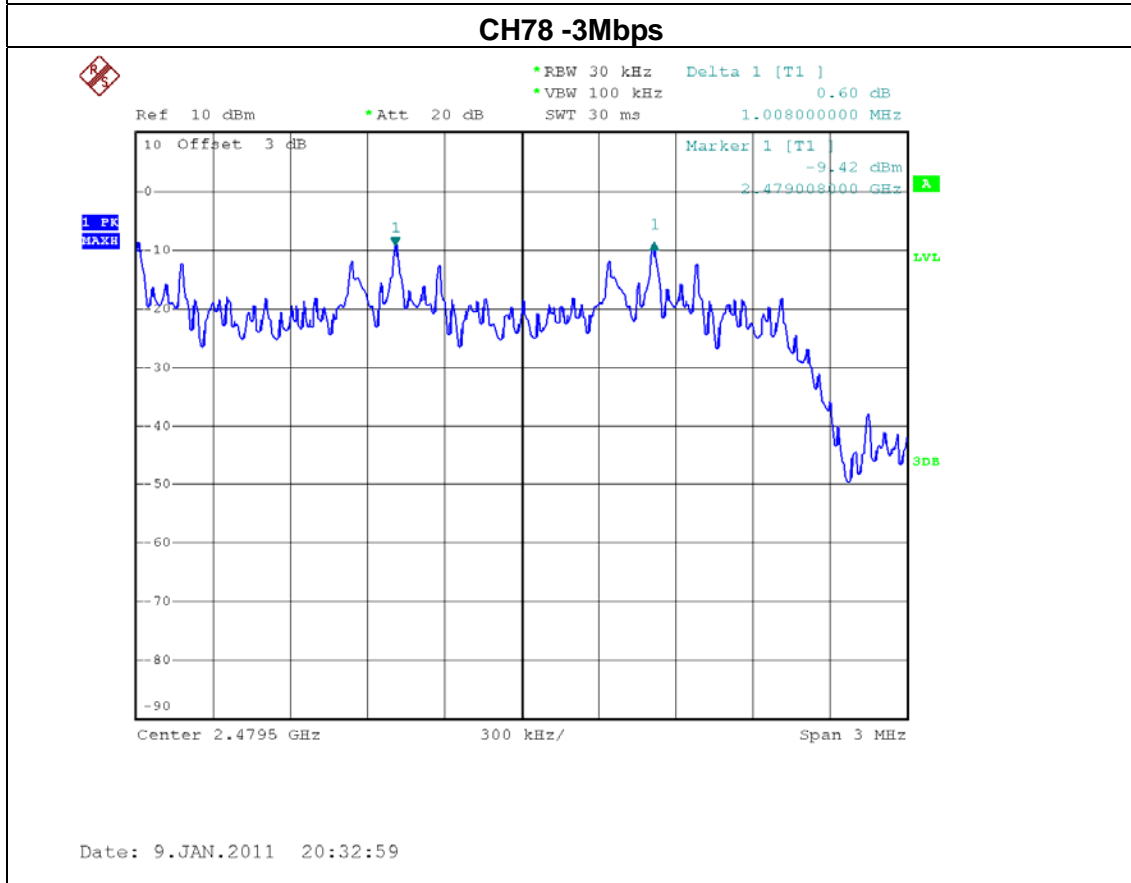
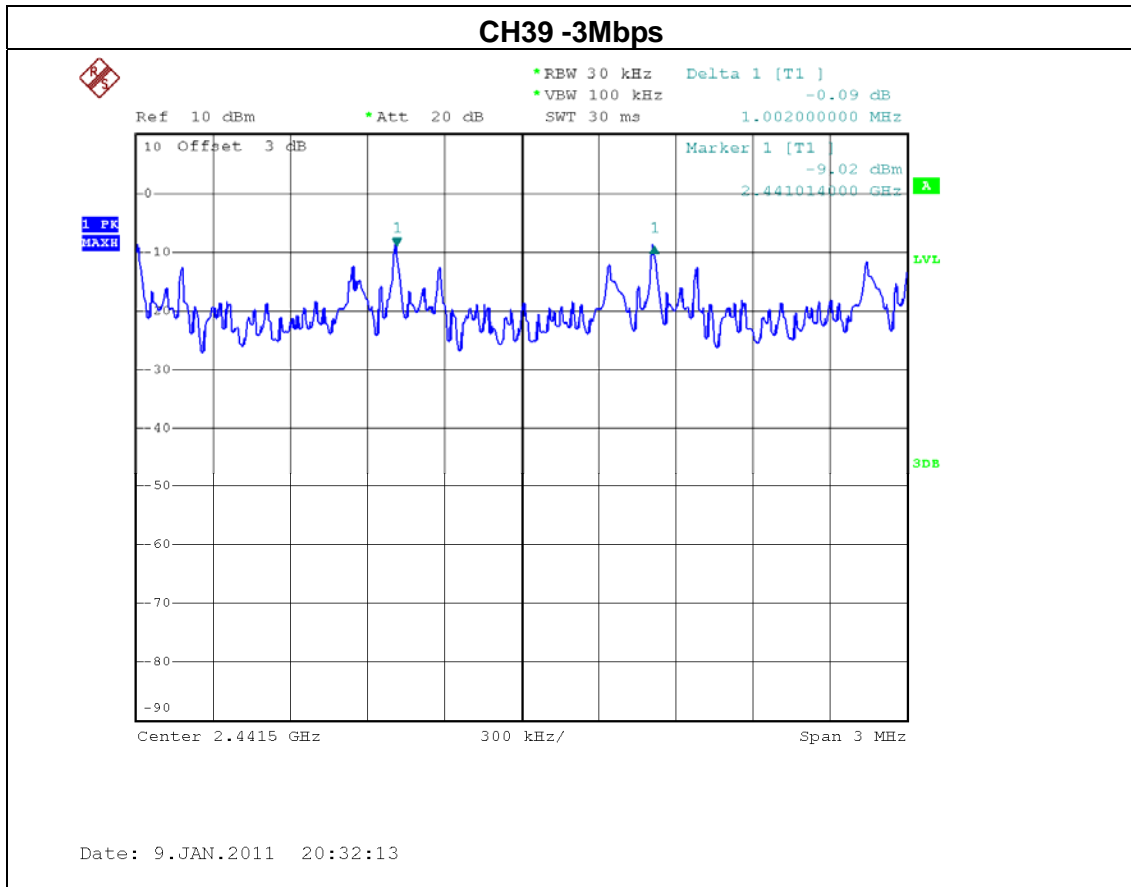



8. BANDWIDTH TEST

8.1 APPLIED PROCEDURES / LIMIT

FCC Part15 (15.247) , Subpart C				
Section	Test Item	Limit	Frequency Range (MHz)	Result
15.247 (a)(2)	Bandwidth	<= 1 MHz (20dB bandwidth)	2400-2483.5	PASS

8.1.1 MEASUREMENT INSTRUMENTS LIST AND SETTING

Item	Kind of Equipment	Manufacturer	Type No.	Serial No.	Calibrated until
1	Spectrum Analyzer	R&S	FSP 40	100185	Nov.26.2011

Remark: " N/A" denotes No Model Name , Serial No. or No Calibration specified.

Spectrum Parameter	Setting
Attenuation	Auto
Span Frequency	> Measurement Bandwidth or Channel Separation
RB	10 kHz (20dB Bandwidth) / 30 kHz (Channel Separation)
VB	100 kHz (20dB Bandwidth) / 100 kHz (Channel Separation)
Detector	Peak
Trace	Max Hold
Sweep Time	Auto

8.1.2 TEST PROCEDURE

- a. The EUT was directly connected to the spectrum analyzer and antenna output port as show in the block diagram below,
- b. Spectrum Setting : RBW= 10KHz, VBW=100KHz, Sweep time = Auto.

8.1.3 DEVIATION FROM STANDARD

No deviation.

8.1.4 TEST SETUP

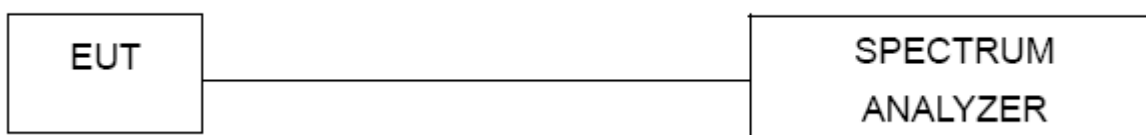

8.1.5 EUT OPERATION CONDITIONS

The EUT tested system was configured as the statements of 4.1.6 Unless otherwise a special operating condition is specified in the follows during the testing.



8.1.6 TEST RESULTS

EUT :	Compact Stereo System	Model Name :	SC-HC05
Temperature :	23 °C	Relative Humidity :	58 %
Pressure :	1009 hPa	Test Voltage :	AC 120V/60Hz
Test Mode :	CH00 / CH39 /CH78-1Mbps		

Frequency	20dB Bandwidth (KHz)	99% Occupied Bandwidth (KHz)	Channel Separation (MHz)	Result
2402 MHz	910.00	870.00	<= 1MHz	PASS
2441 MHz	910.00	870.00	<= 1MHz	PASS
2480 MHz	910.00	870.00	<= 1MHz	PASS

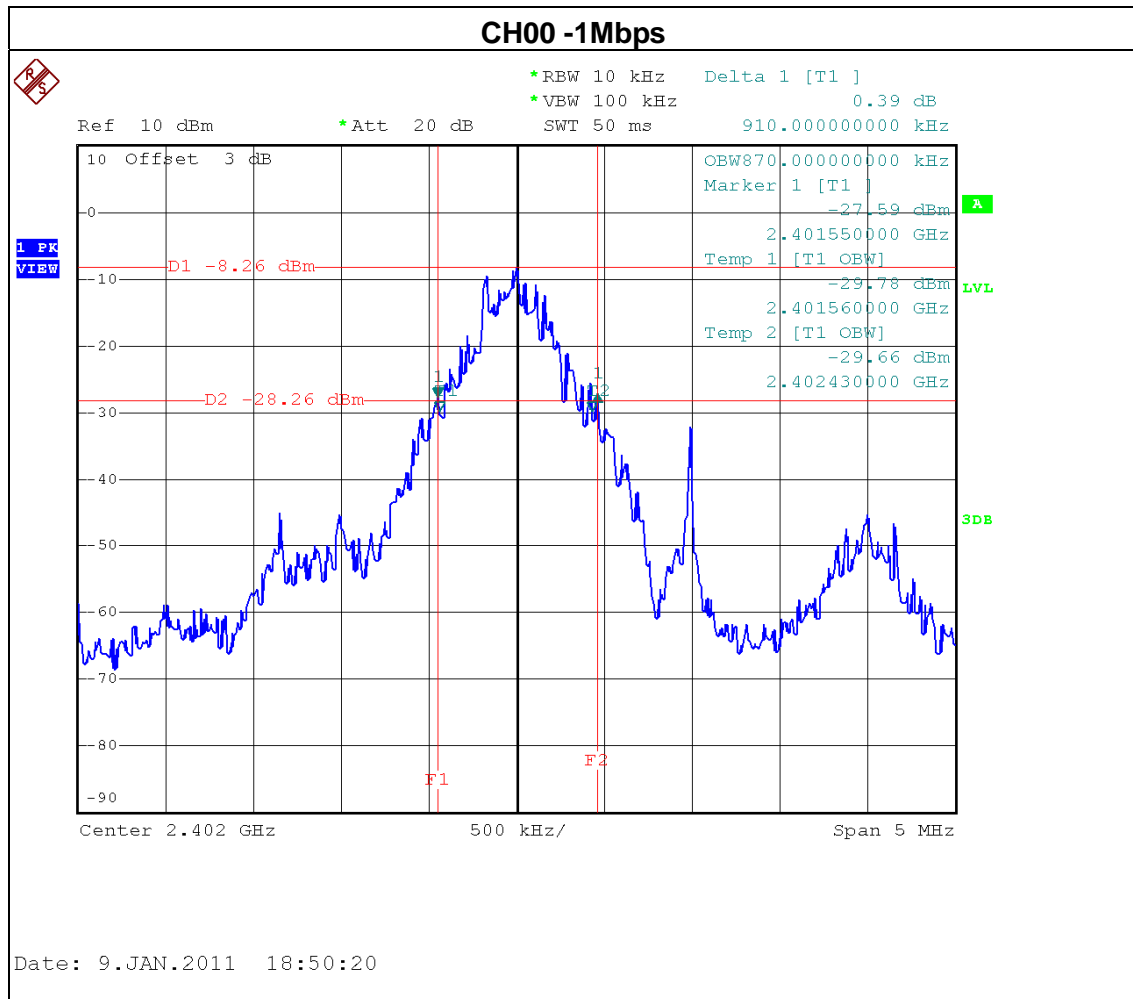



CH39 -1Mbps

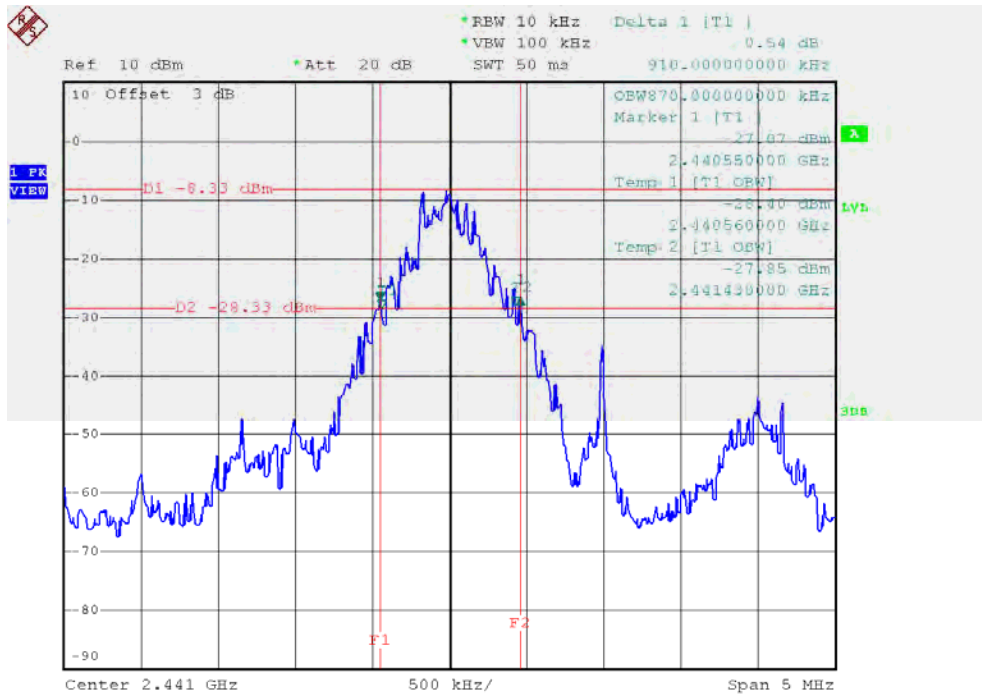

Date: 9.JAN.2011 19:10:56

CH78 -1Mbps

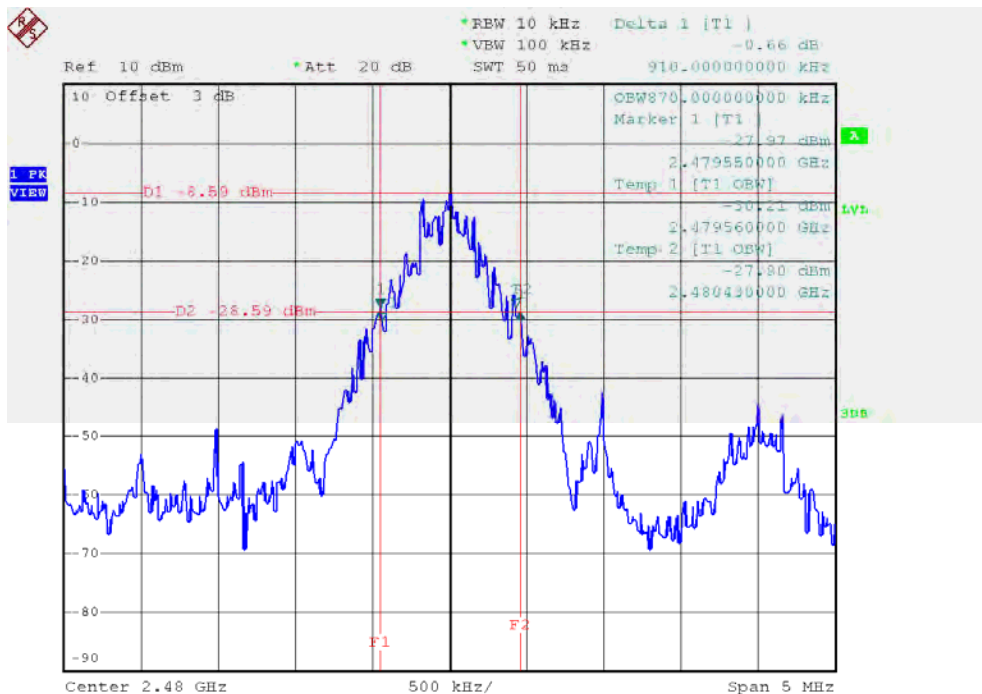

Date: 9.JAN.2011 19:13:01



EUT :	Compact Stereo System	Model Name :	SC-HC05
Temperature :	23 °C	Relative Humidity :	58 %
Pressure :	1009 hPa	Test Voltage :	AC 120V/60Hz
Test Mode :	CH00 / CH39 /CH78-3Mbps		

Frequency	20dB Bandwidth (KHz)	99% Occupied Bandwidth (KHz)	Channel Separation (MHz)	Result
2402 MHz	1200.00	1150.00	<= 1MHz	PASS
2441 MHz	1200.00	1160.00	<= 1MHz	PASS
2480 MHz	1190.00	1150.00	<= 1MHz	PASS

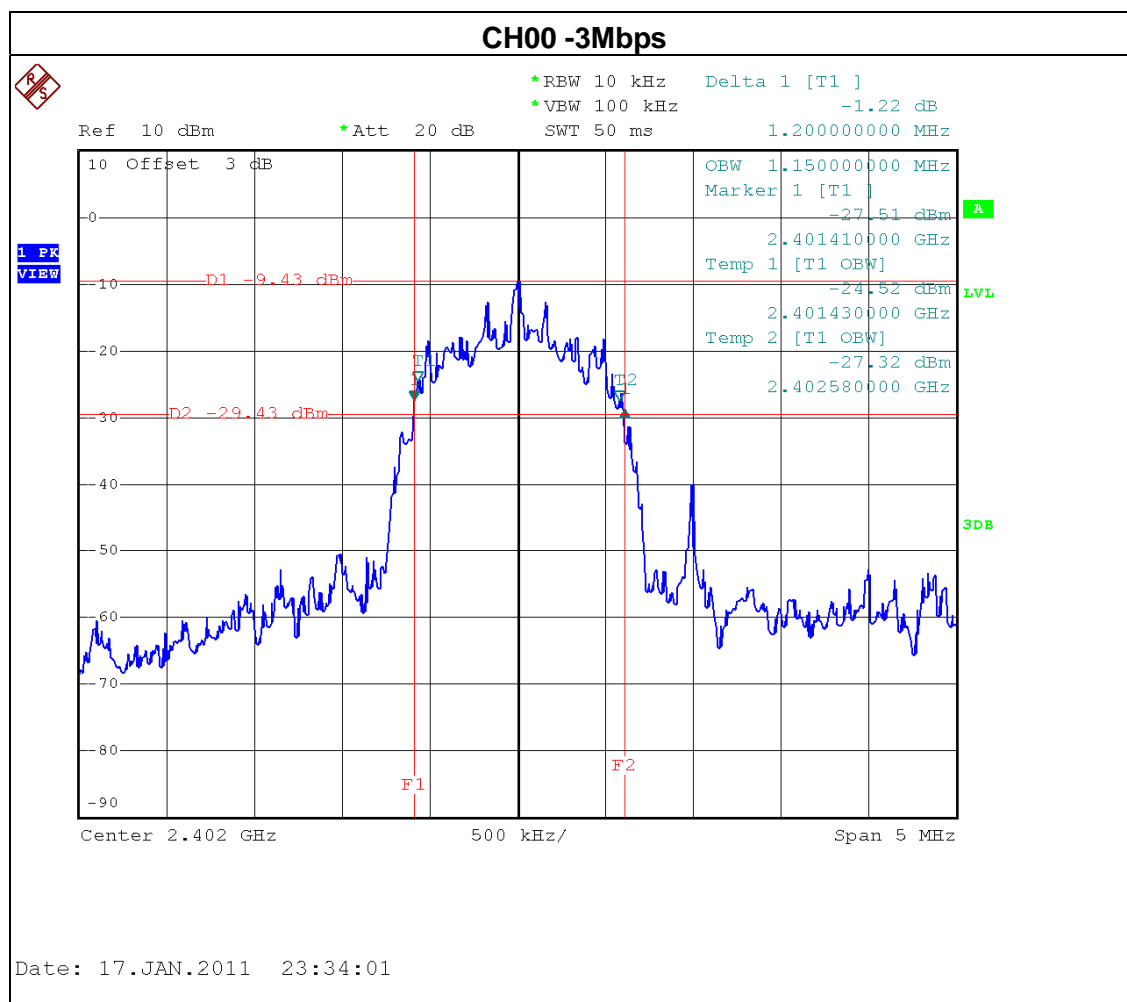



CH39 -3Mbps

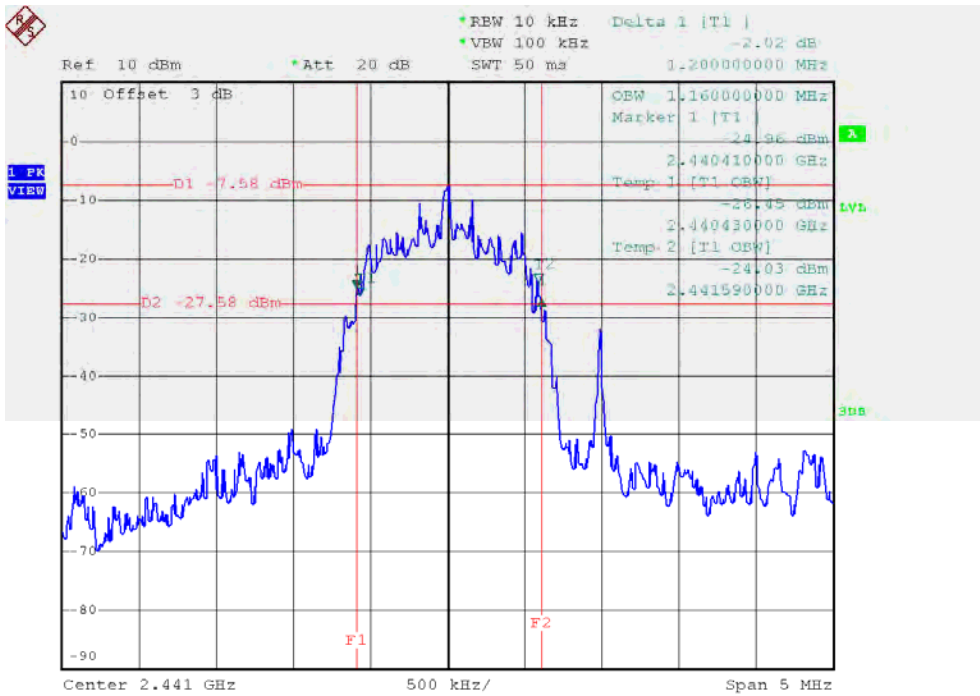

Date: 17.JAN.2011 23:35:15

CH78 -3Mbps

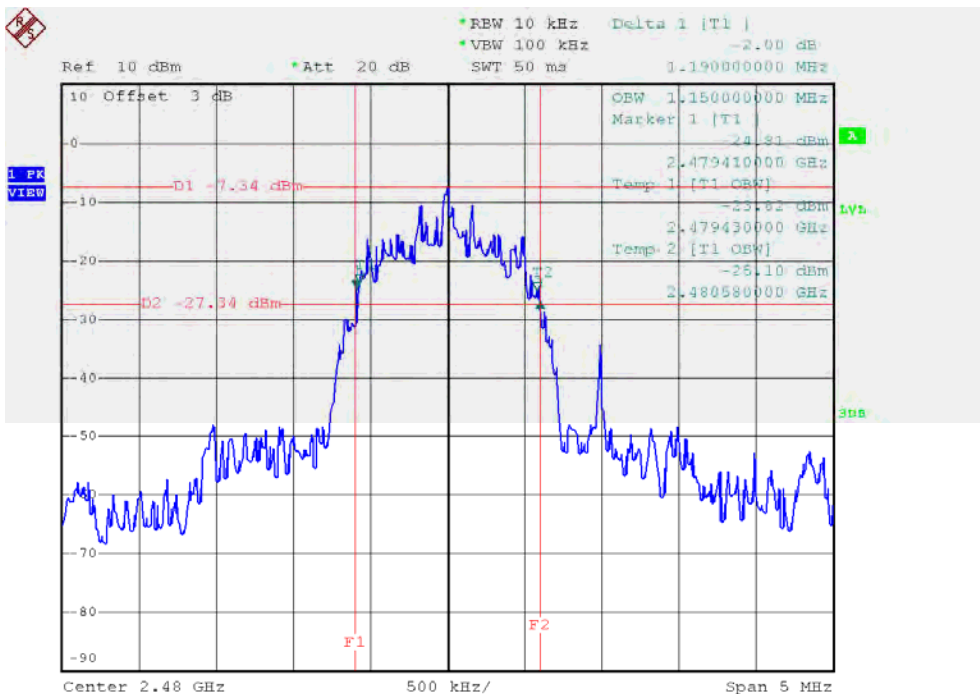

Date: 17.JAN.2011 23:36:19



9. PEAK OUTPUT POWER TEST

9.1 APPLIED PROCEDURES / LIMIT

FCC Part15 (15.247) , Subpart C				
Section	Test Item	Limit	Frequency Range (MHz)	Result
15.247 (b)(1)	Peak Output Power	0.125 watt or 21dBm	2400-2483.5	PASS

9.1.1 MEASUREMENT INSTRUMENTS LIST AND SETTING

Item	Kind of Equipment	Manufacturer	Type No.	Serial No.	Calibrated until
1	Spectrum Analyzer	R&S	FSP 40	100185	Nov.26.2011

Remark: " N/A" denotes No Model Name , Serial No. or No Calibration specified.

9.1.2 TEST PROCEDURE

- a. The EUT was directly connected to the spectrum analyzer and antenna output port as show in the block diagram below,
- b. Spectrum Setting : RBW= 3MHz, VBW= 3MHz, Sweep time = Auto.

9.1.3 DEVIATION FROM STANDARD

No deviation.

9.1.4 TEST SETUP

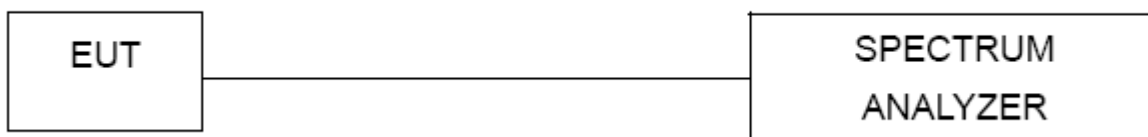

9.1.5 EUT OPERATION CONDITIONS

The EUT tested system was configured as the statements of 4.1.6 Unless otherwise a special operating condition is specified in the follows during the testing.



9.1.6 TEST RESULTS

EUT :	Compact Stereo System	Model Name :	SC-HC05
Temperature :	23 °C	Relative Humidity :	58 %
Pressure :	1009 hPa	Test Voltage :	AC 120V/60Hz
Test Mode :	CH00/ CH39 /CH78 -1Mbps		

Test Channel	Frequency (MHz)	Peak Output Power (dBm)	LIMIT (dBm)	LIMIT (W)
CH00	2402	-2.42	21	0.125
CH39	2441	-1.49	21	0.125
CH78	2480	-2.49	21	0.125

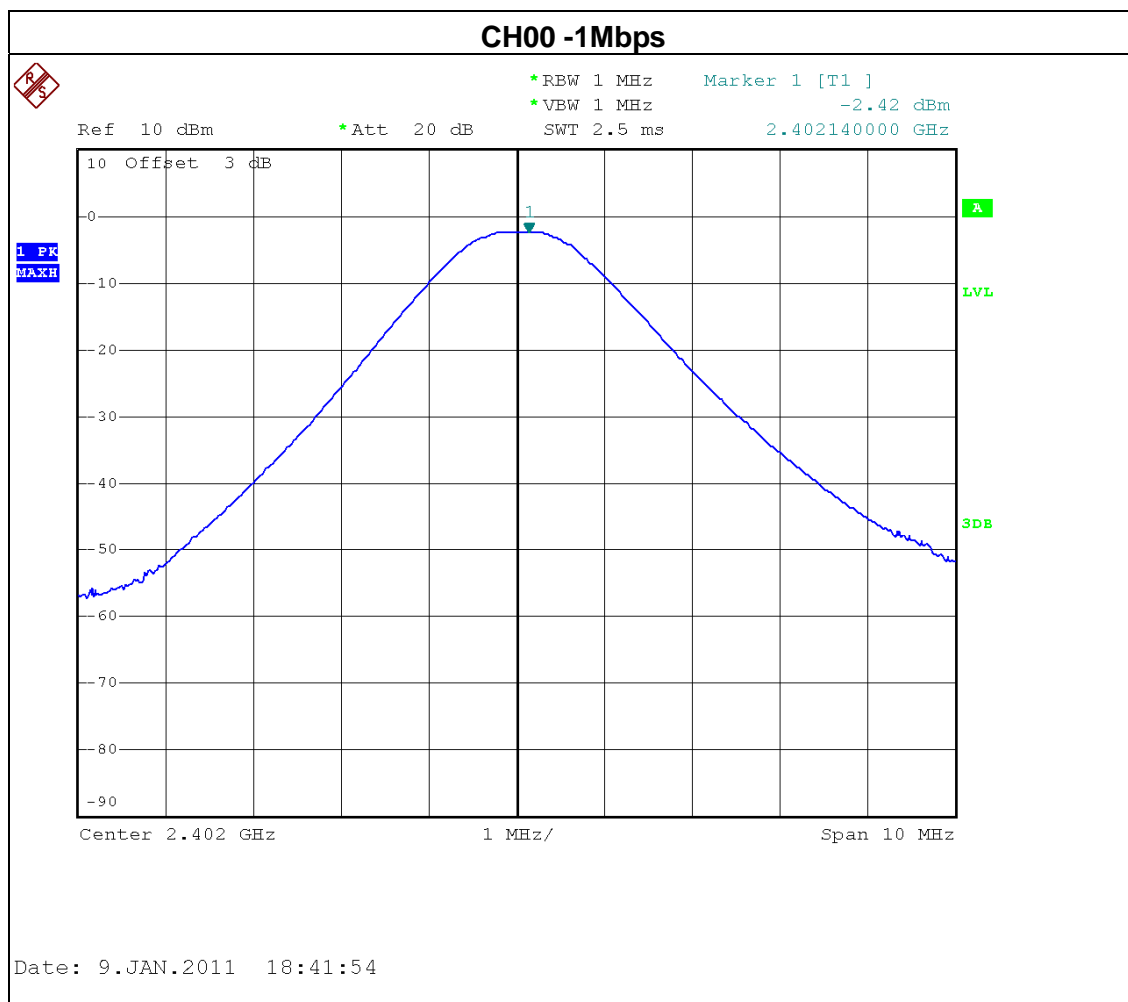



CH39 -1Mbps

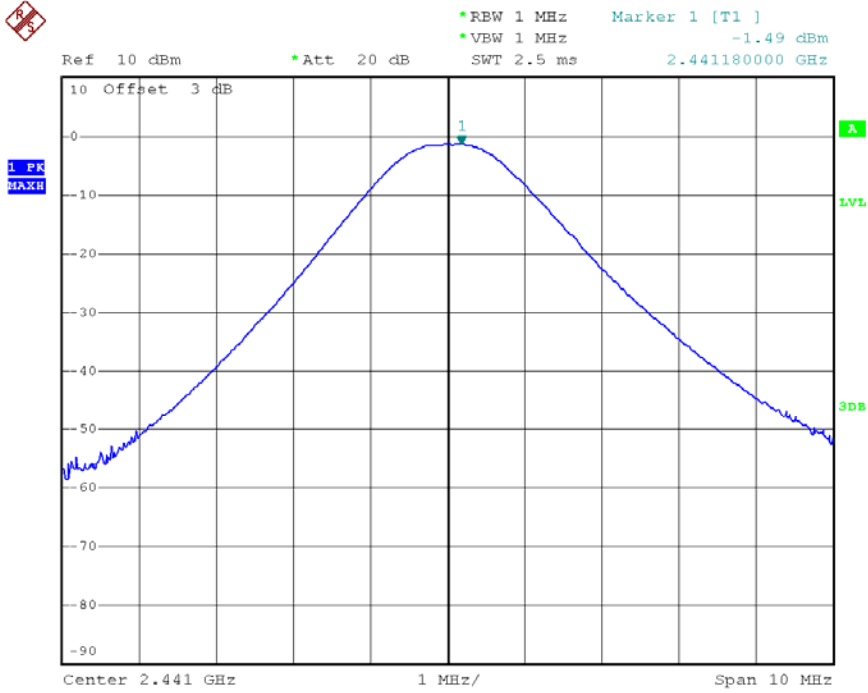

Date: 9.JAN.2011 18:42:16

CH78 -1Mbps

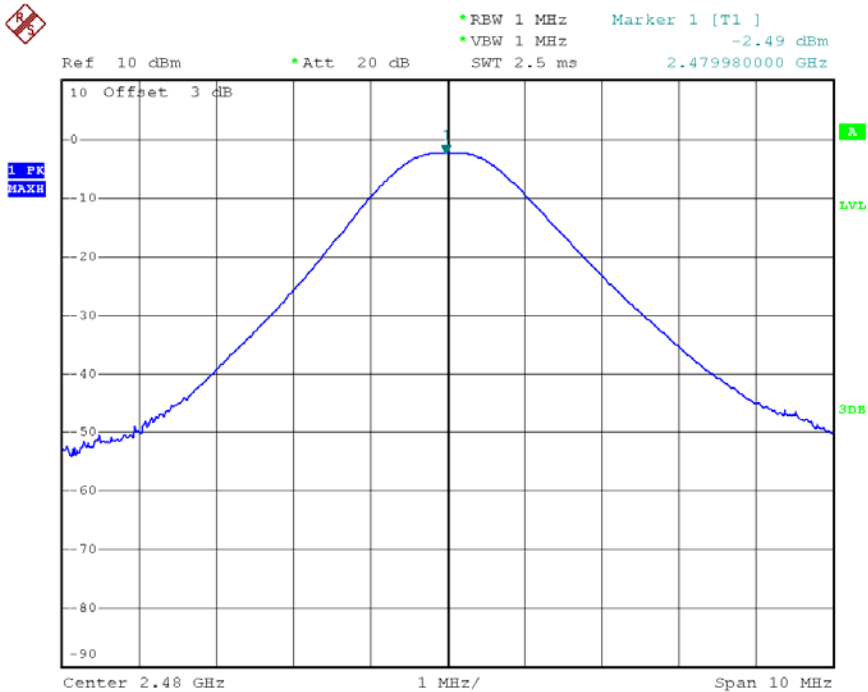

Date: 9.JAN.2011 18:42:37



EUT :	Compact Stereo System	Model Name :	SC-HC05
Temperature :	23 °C	Relative Humidity :	58 %
Pressure :	1009 hPa	Test Voltage :	AC 120V/60Hz
Test Mode :	CH00/ CH39 /CH78 -3Mbps		

Test Channel	Frequency (MHz)	Peak Output Power (dBm)	LIMIT (dBm)	LIMIT (W)
CH00	2402	-4.11	21	0.125
CH39	2441	-3.37	21	0.125
CH78	2480	-3.56	21	0.125

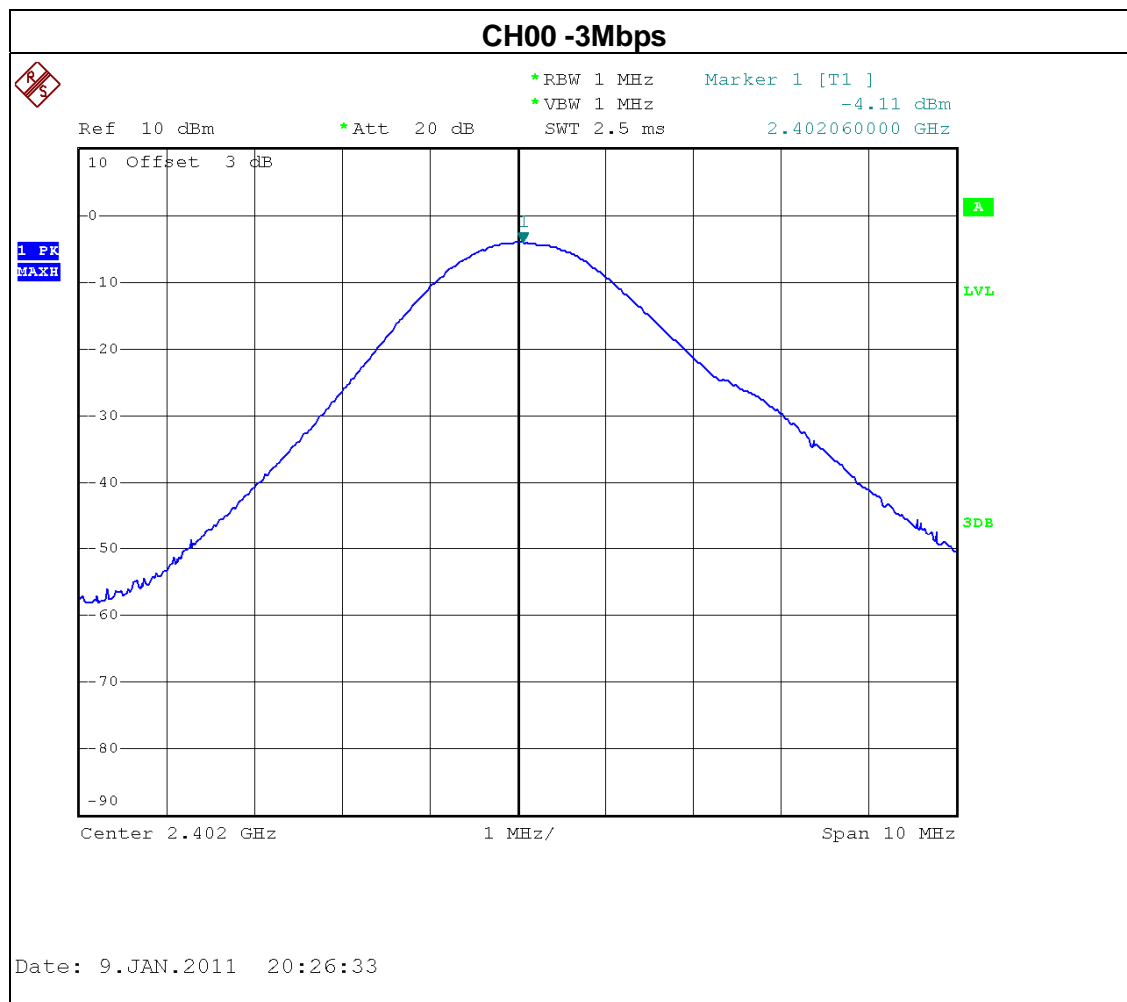



CH39 -3Mbps

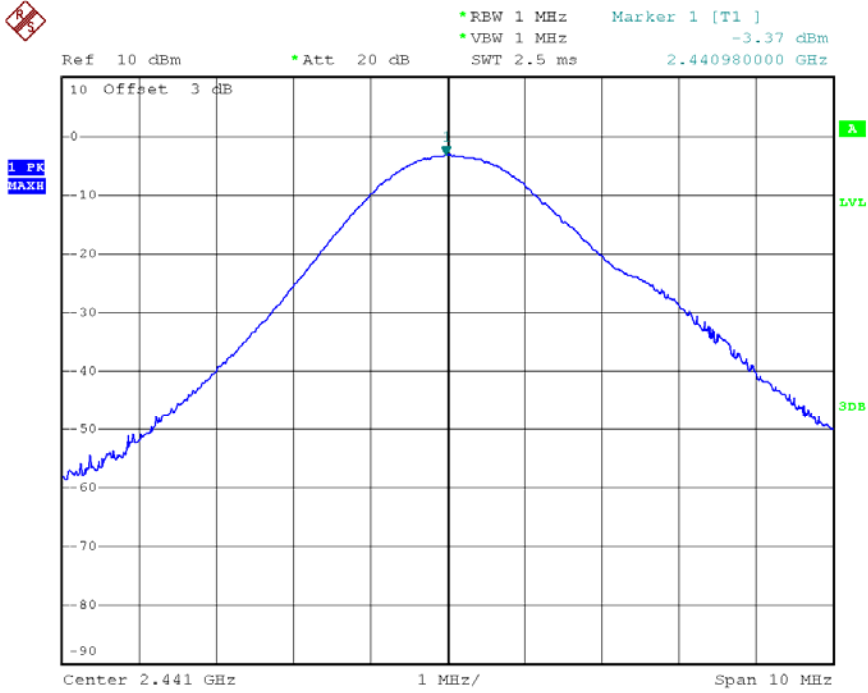

Date: 9.JAN.2011 20:25:34

CH78 -3Mbps

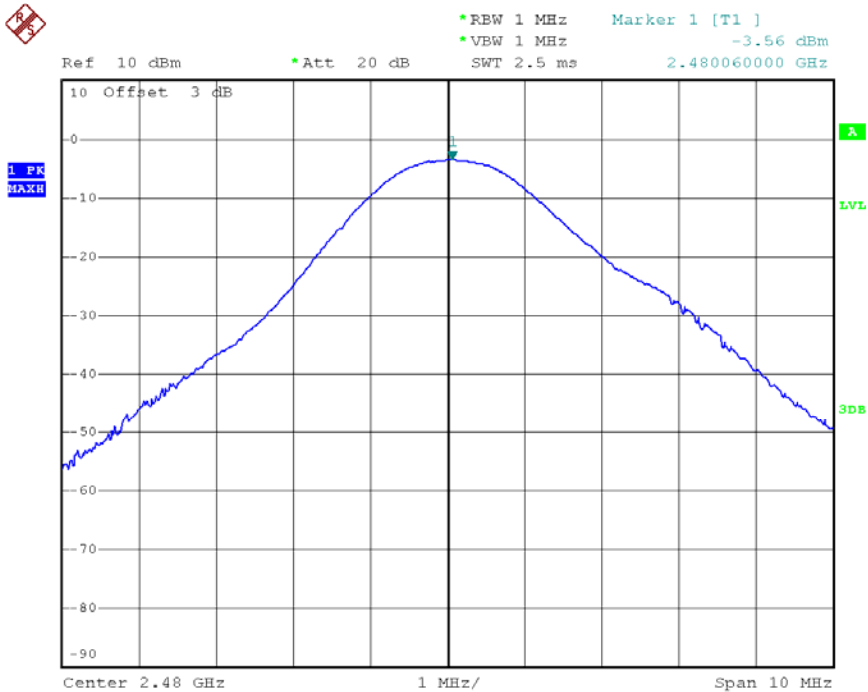

Date: 9.JAN.2011 20:22:08



10. ANTENNA CONDUCTED SPURIOUS EMISSION

10.1 APPLIED PROCEDURES / LIMIT

20dBc in any 100 kHz bandwidth outside the operating frequency band. In case the emission fall within the restricted band specified on 15.205(a), then the 15.209(a) limit in the table below has to be followed.

Frequencies (MHz)	Field Strength (micovolts/meter)	Measurement Distance (meters)
0.009~0.490	2400/F(KHz)	300
0.490~1.705	24000/F(KHz)	30
1.705~30.0	30	30
30~88	100	3
88~216	150	3
216~960	200	3
Above 960	500	3

10.1.1 MEASUREMENT INSTRUMENTS LIST AND SETTING

Item	Kind of Equipment	Manufacturer	Type No.	Serial No.	Calibrated until
1	Spectrum Analyzer	R&S	FSP 40	100185	Nov.26.2011

Remark: " N/A" denotes No Model Name , Serial No. or No Calibration specified.

10.1.2 TEST PROCEDURE

- a. The EUT was directly connected to the spectrum analyzer and antenna output port as show in the block diagram below,
- b. Spectrum Setting : RBW= 100KHz, VBW=100KHz, Sweep time = Auto.

10.1.3 DEVIATION FROM STANDARD

No deviation.

10.1.4 TEST SETUP



10.1.5 EUT OPERATION CONDITIONS

The EUT tested system was configured as the statements of 4.1.6 Unless otherwise a special operating condition is specified in the follows during the testing.



10.1.6 TEST RESULTS

EUT :	Compact Stereo System	Model Name :	SC-HC05
Temperature :	23 °C	Relative Humidity :	58 %
Pressure :	1009 hPa	Test Voltage :	AC 120V/60Hz
Test Mode :	CH00 / CH39/ CH78-1Mbps & Hopping on mode (1Mbps)		

The max. radio frequency power in any 100kHz bandwidth outside the frequency band		The max. radio frequency power in any 100 kHz bandwidth within the frequency band.	
FREQUENCY(MHz)	POWER(dBm)	FREQUENCY(MHz)	POWER(dBm)
2358.40	-57.87	2484.40	-49.35

Result

In any 100kHz bandwidth outside the frequency band, the radio frequency power is at least 20dB below that in the 100kHz bandwidth within the band that contains the highest level of the desired power.



CH00 (Lower) -1Mbps

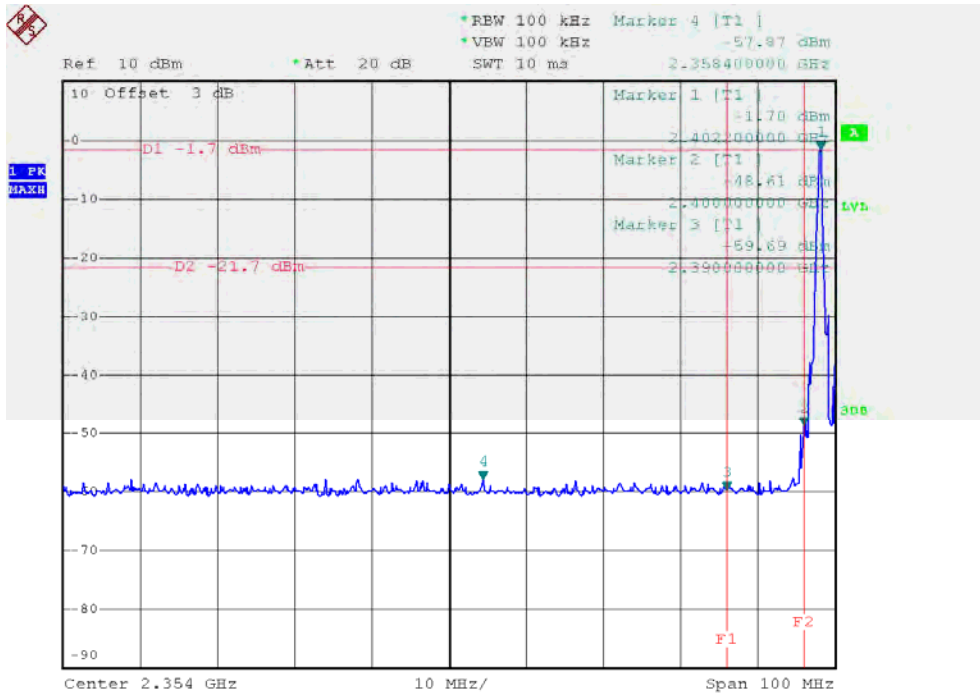

Date: 9.JAN.2011 18:53:15

CH78 (upper) -1Mbps

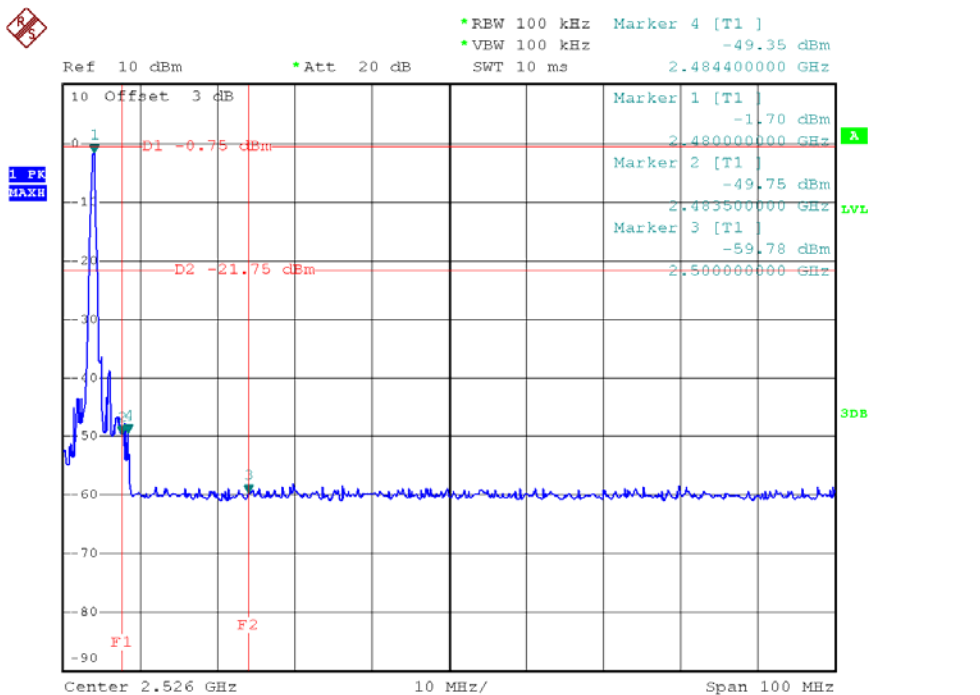

Date: 9.JAN.2011 19:14:45



Hopping on mode (1Mbps- Lower)

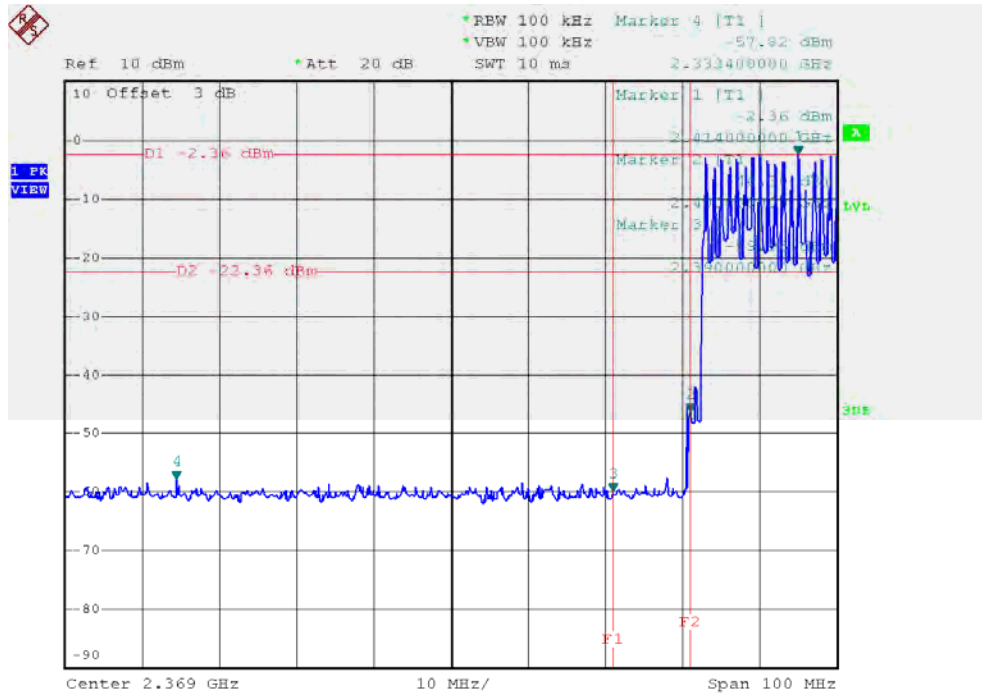

Date: 9.JAN.2011 19:58:25

Hopping on mode (1Mbps- upper)

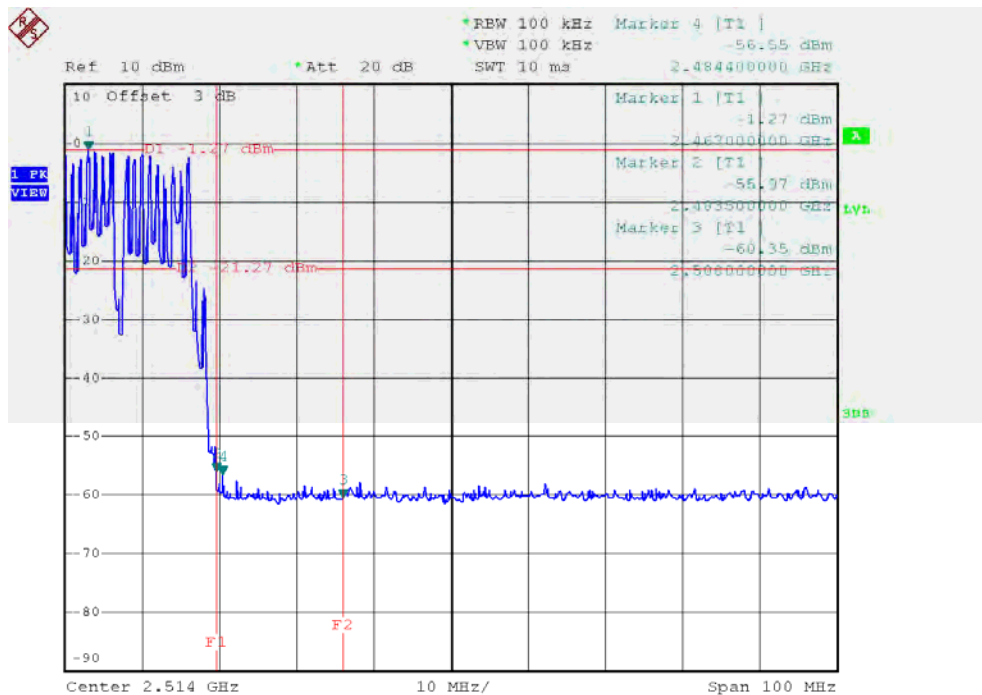

Date: 9.JAN.2011 20:00:34

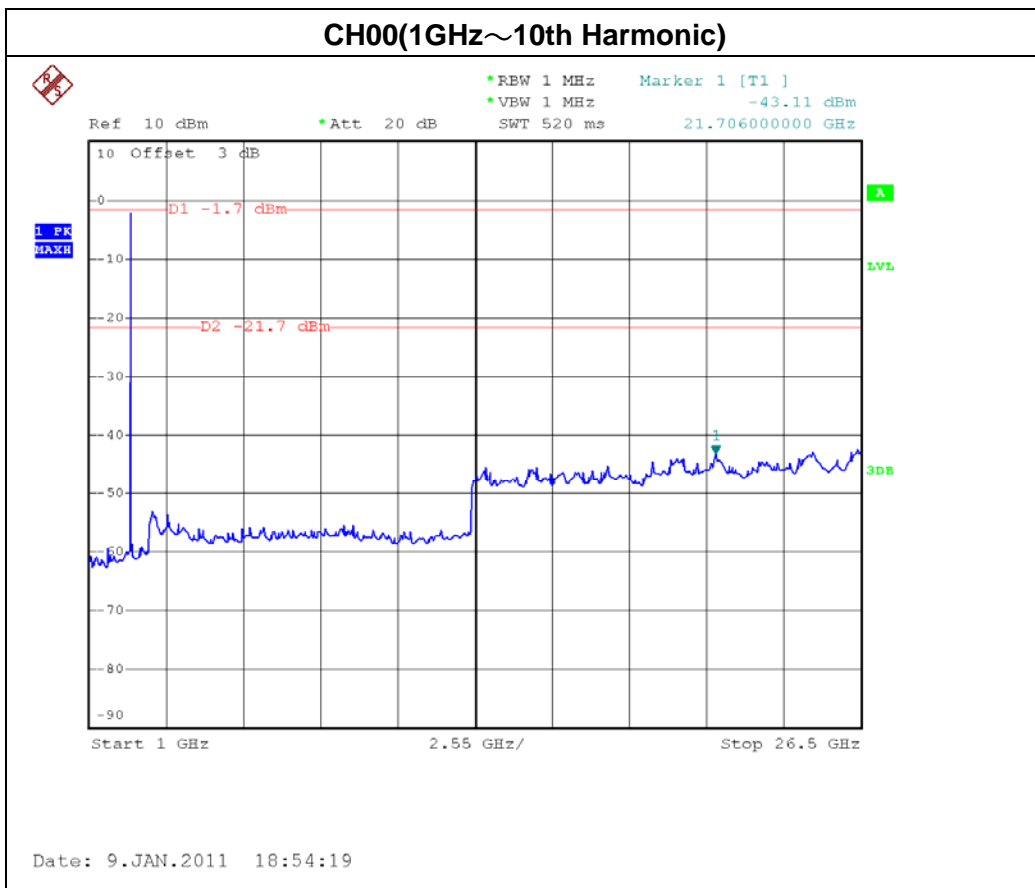
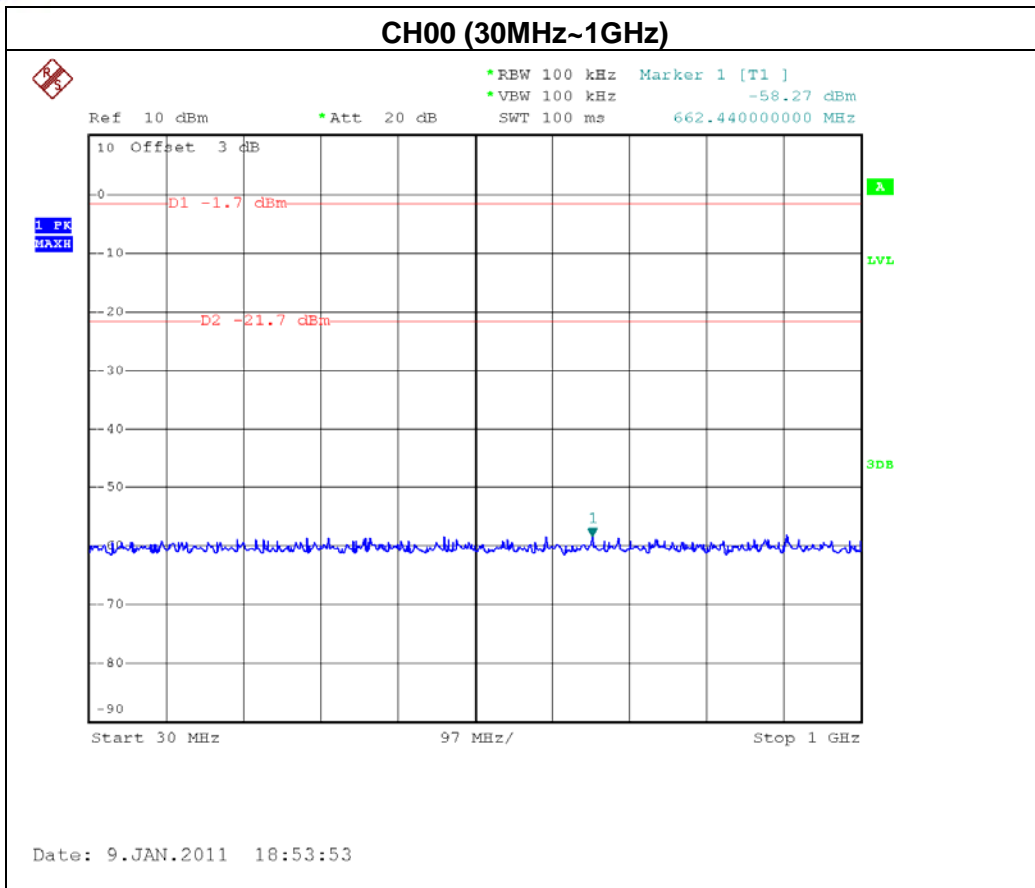



CH39 (30MHz~1GHz)

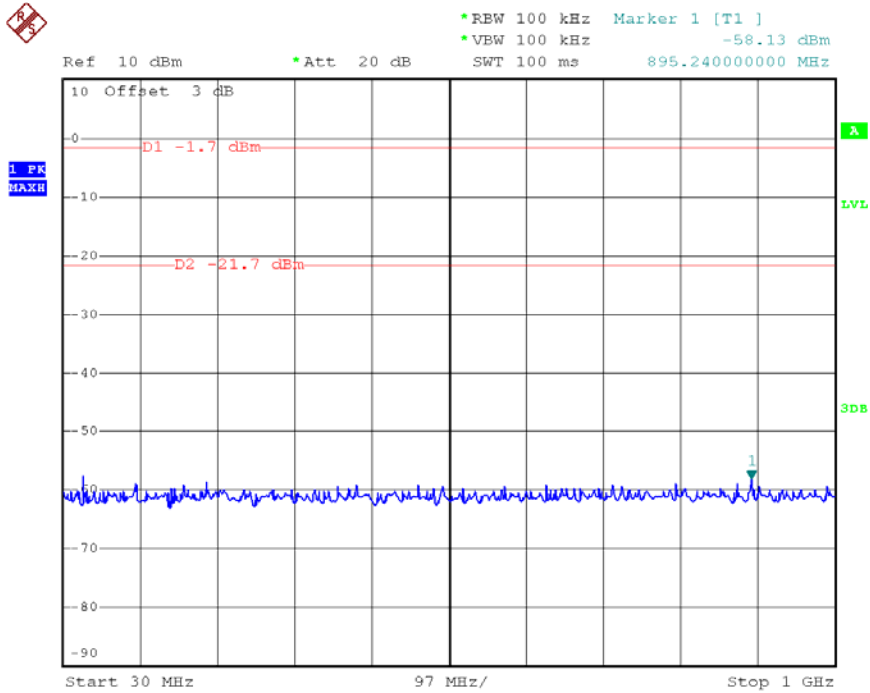

CH39(1GHz~10th Harmonic)

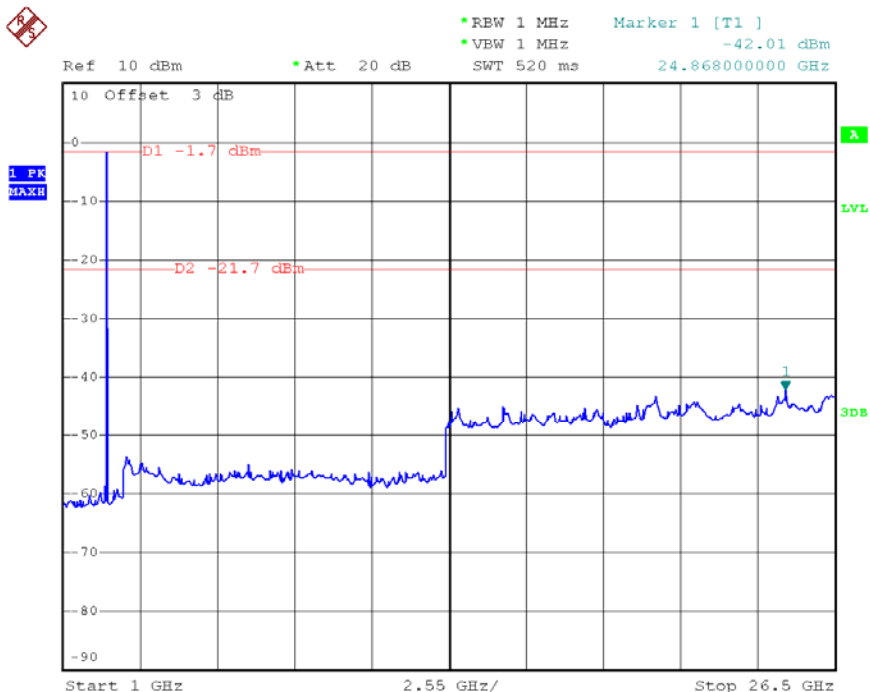

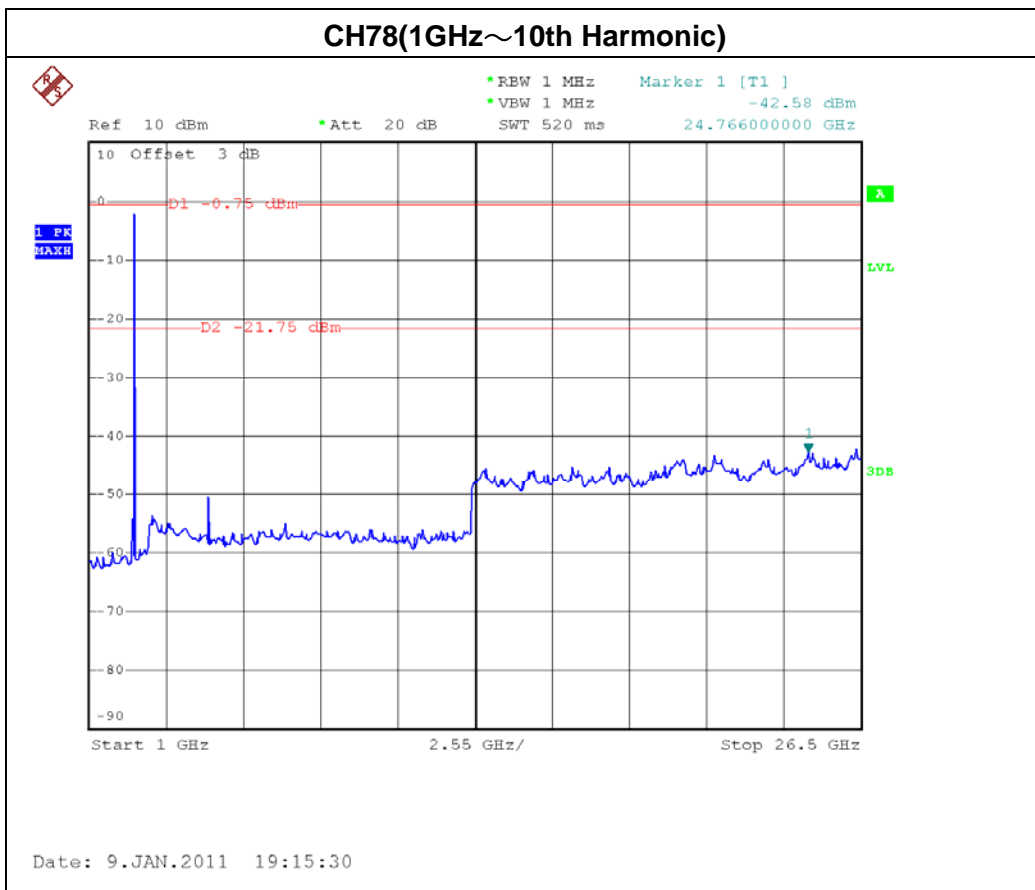
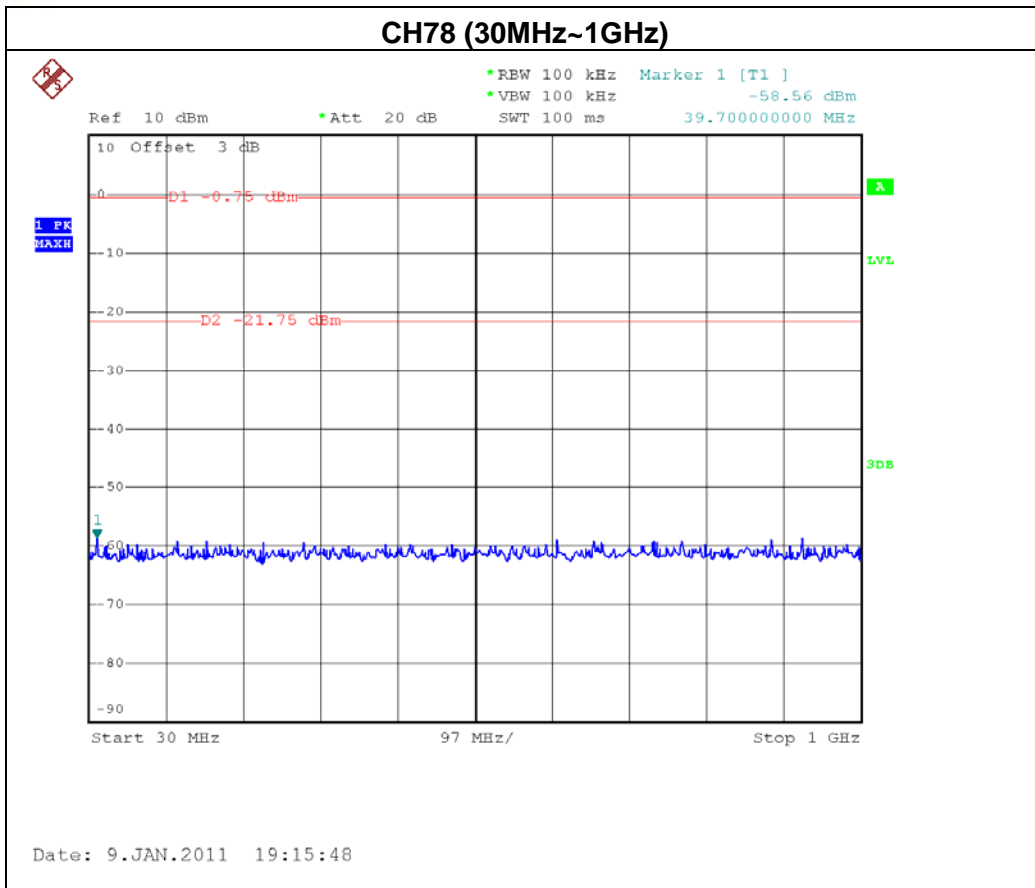



EUT :	Compact Stereo System	Model Name :	SC-HC05
Temperature :	23 °C	Relative Humidity :	58 %
Pressure :	1009 hPa	Test Voltage :	AC 120V/60Hz
Test Mode :	CH00 / CH39/ CH78 -3Mbps & Hopping on mode (3Mbps)		

The max. radio frequency power in any 100kHz bandwidth outside the frequency band		The max. radio frequency power in any 100 kHz bandwidth within the frequency band.	
FREQUENCY(MHz)	POWER(dBm)	FREQUENCY(MHz)	POWER(dBm)
2385.80	-57.92	2483.50	-49.61

Result

In any 100kHz bandwidth outside the frequency band, the radio frequency power is at least 20dB below that in the 100kHz bandwidth within the band that contains the highest level of the desired power.



CH00 (Lower) -3Mbps

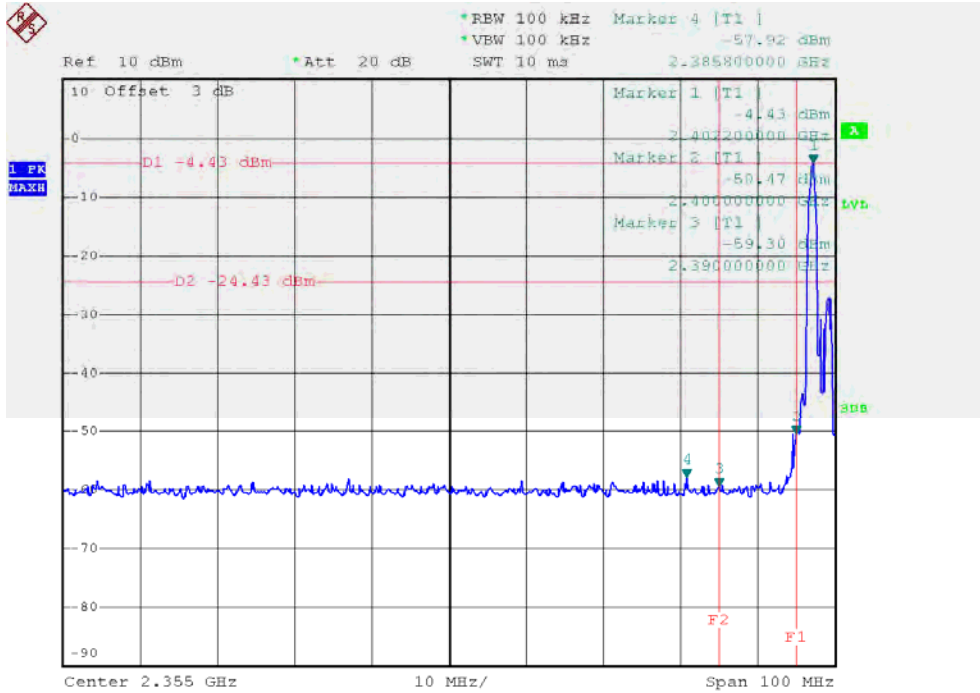

Date: 9.JAN.2011 20:28:49

CH 78 (Upper) -3Mbps

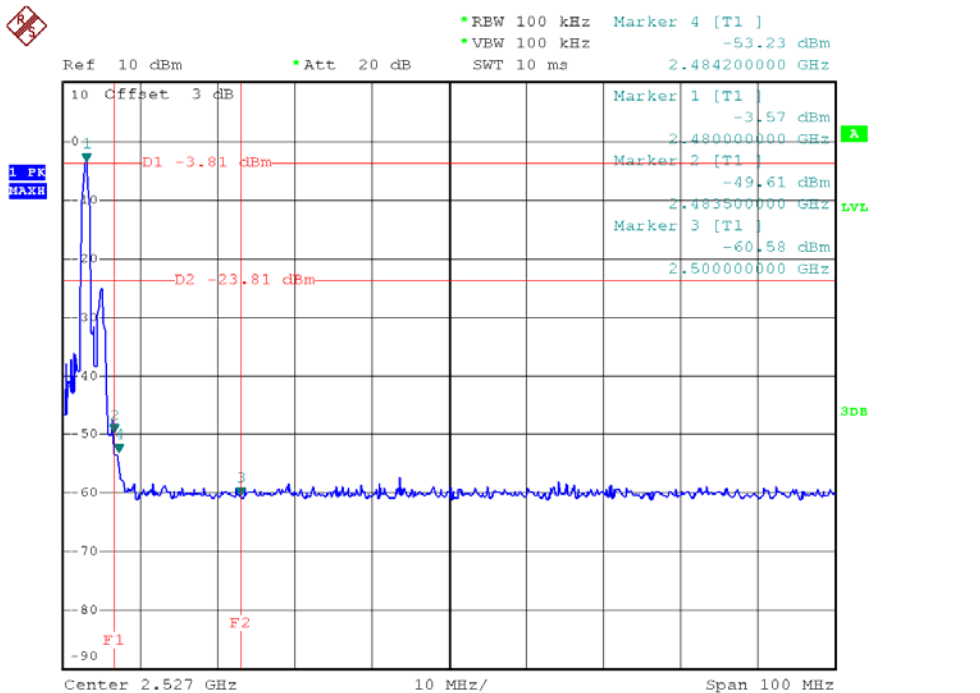

Date: 9.JAN.2011 20:19:48



Hopping on mode (3Mbps- Lower)

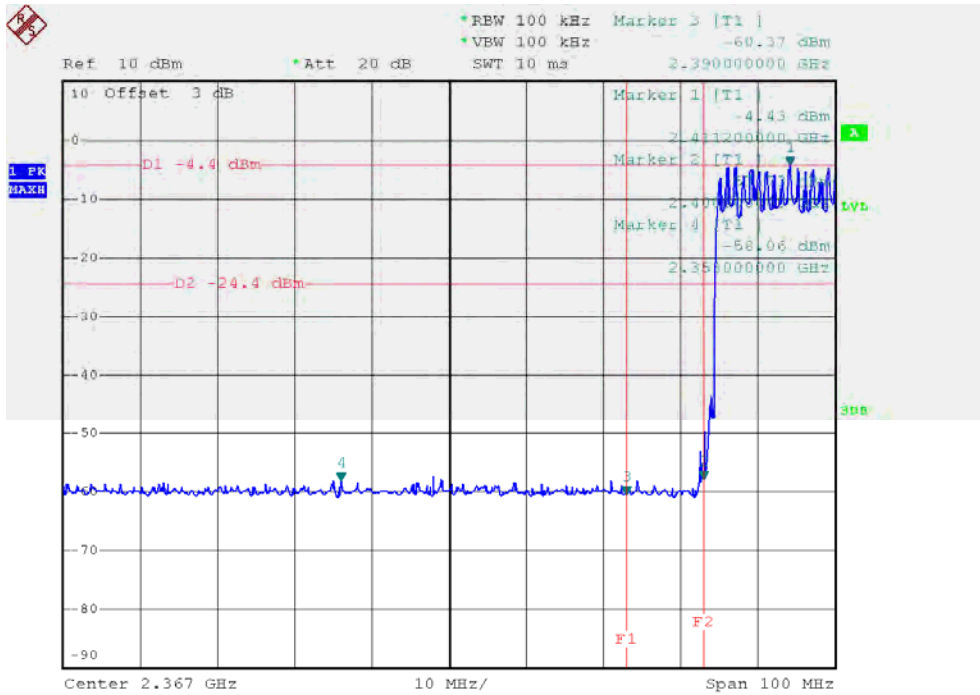

Date: 9.JAN.2011 20:05:47

Hopping on mode (3Mbps-upper)

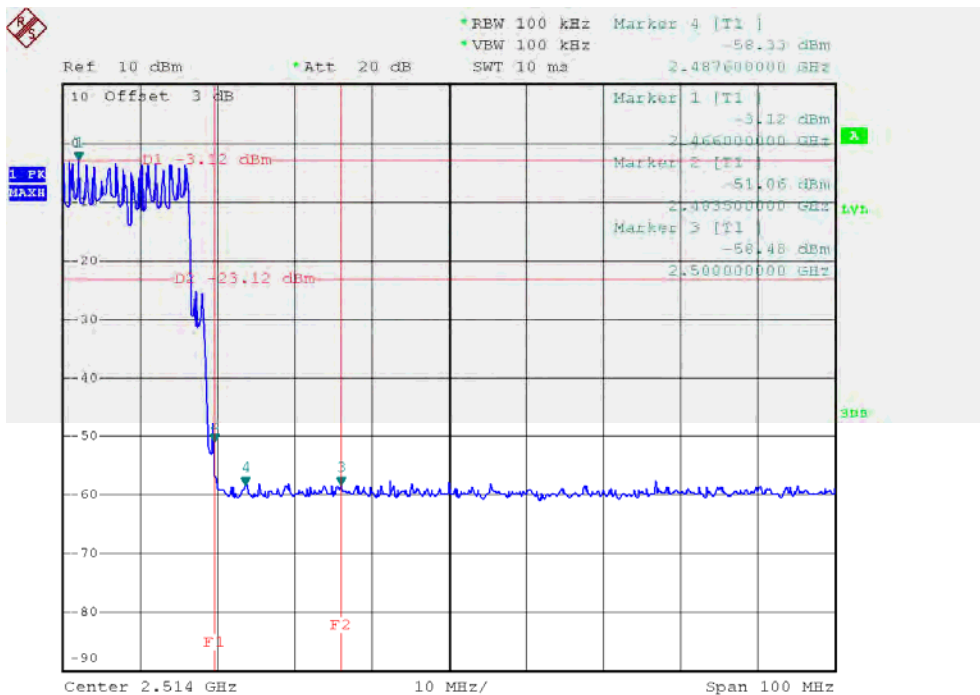

Date: 9.JAN.2011 20:04:07



CH00 (30MHz~1GHz)

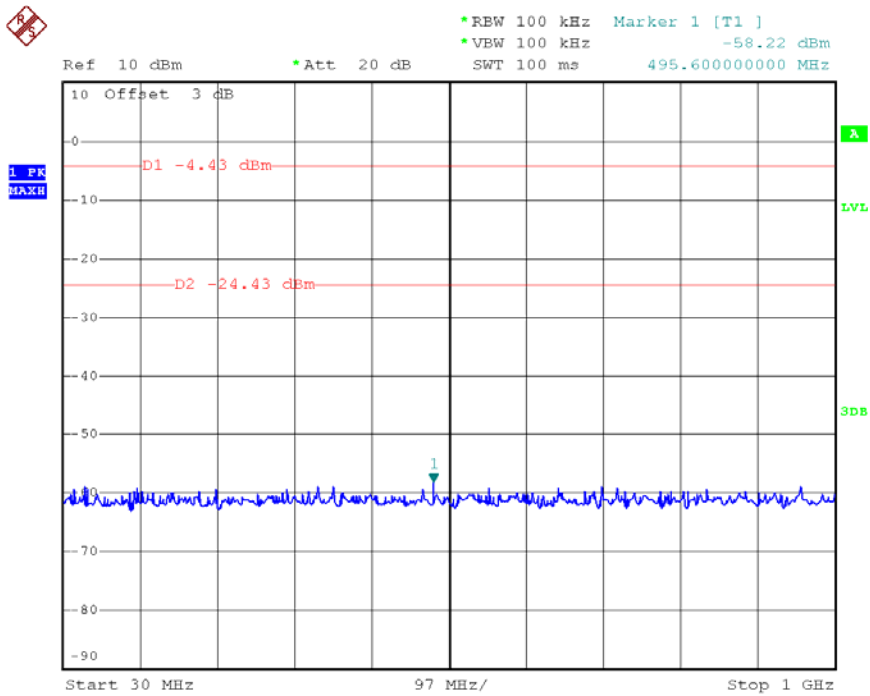

Date: 9.JAN.2011 20:29:05

CH00(1GHz~10th Harmonic)

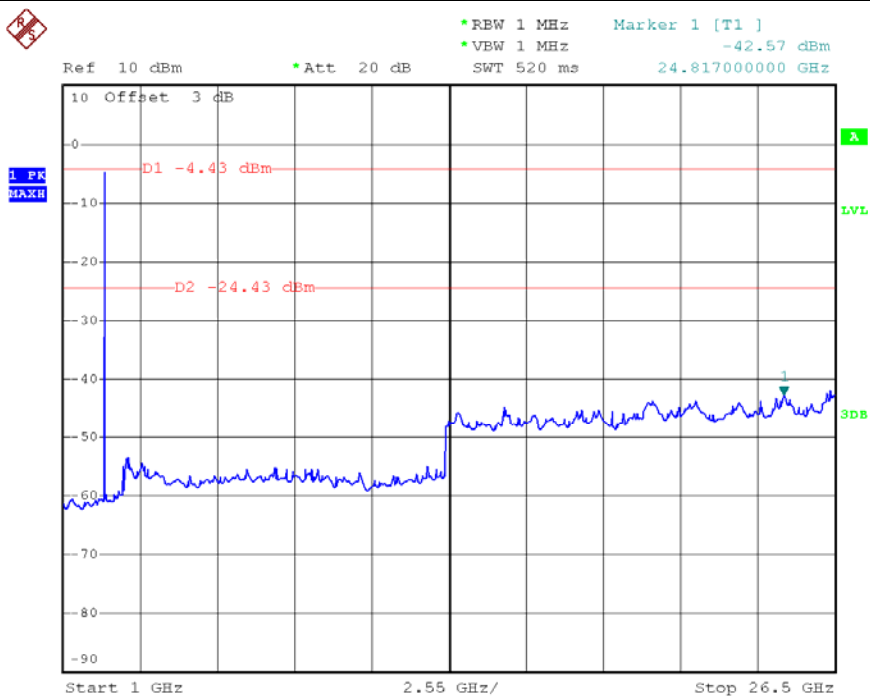

Date: 9.JAN.2011 20:29:28



CH39 (30MHz~1GHz)

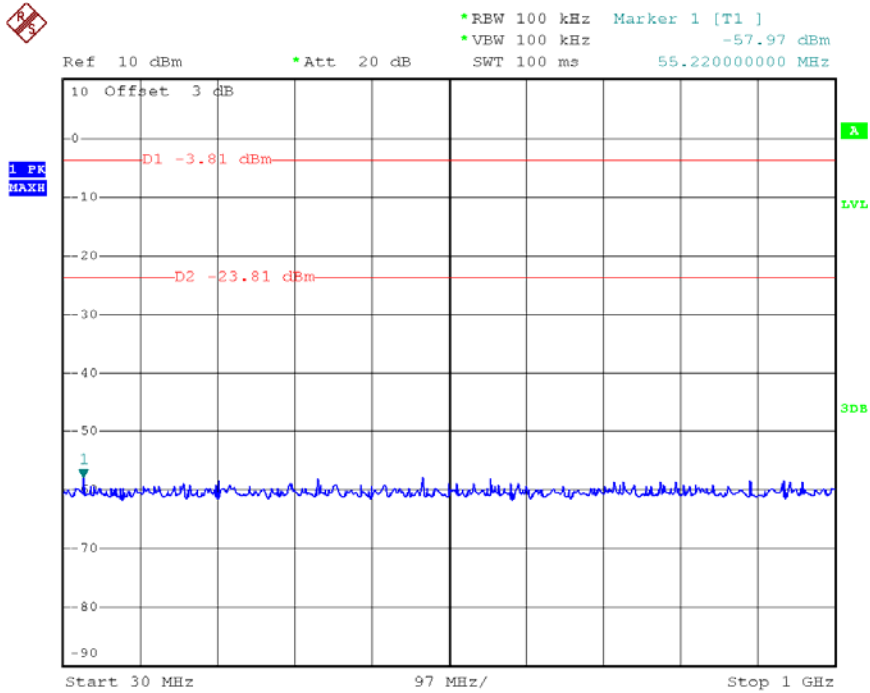

Date: 9.JAN.2011 20:20:18

CH39(1GHz~10th Harmonic)

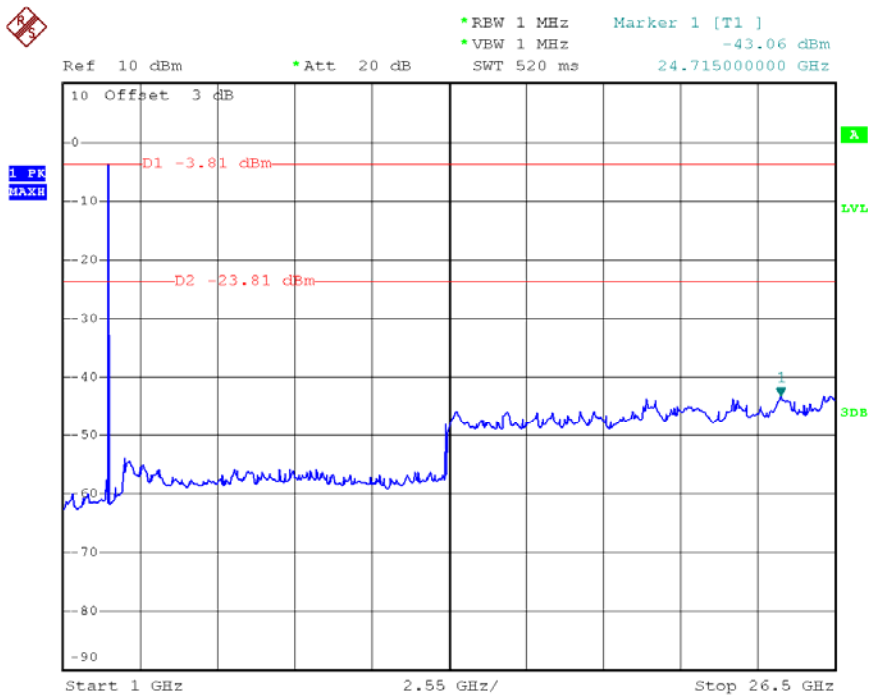

Date: 9.JAN.2011 20:21:04

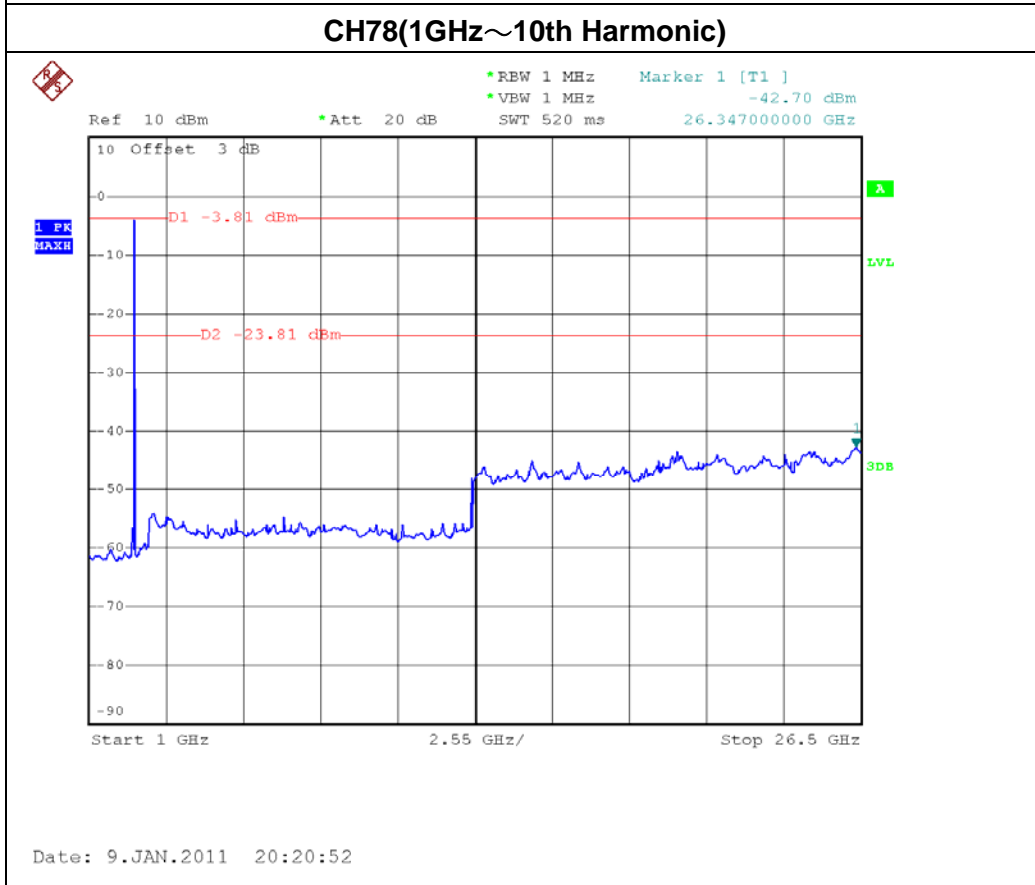
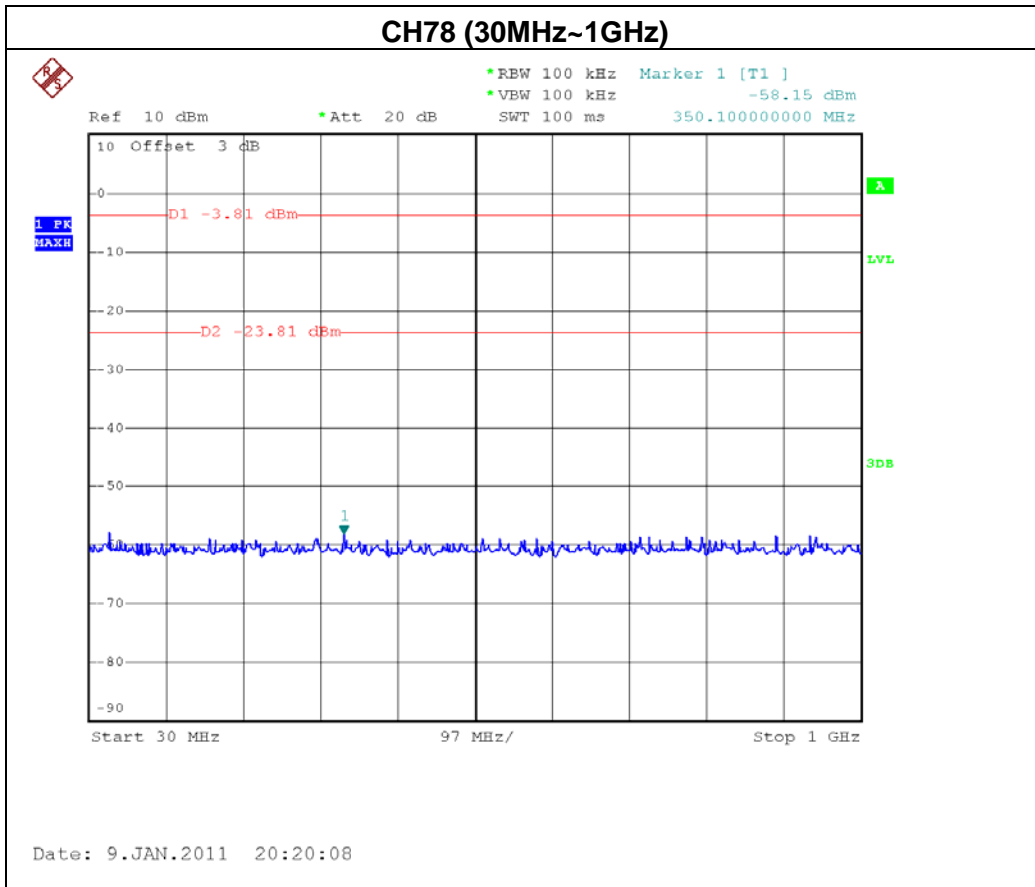



11. RF EXPOSURE TEST

11.1 APPLIED PROCEDURES / LIMIT

These devices are not exempted from compliance does not exceed the Commission’s RF exposure guidelines. Unless a device operates at substantially low power levels, with a low gain antenna(s), supporting information is generally needed to establish the various potential operating configurations and exposure conditions of a transmitter and its antenna(s) in order to determine compliance with the RF exposure guidelines.

In order to demonstrate compliance with MPE requirement (see Section 2.1091), the following information is typically needed:

Calculation that estimates the minimum separation distance (20 cm or more) between an antenna and persons required to satisfy power density limits defined for free space.

Antenna installation and device operating instructions for installers (professional/unskilled users), and the parties responsible for ensuring compliance with the RF exposure requirement. Any caution statements and/or warning labels that are necessary in order to comply with the exposure limits. Any other RF exposure related issues that may affect MPE compliance.

FCC 1.1310: The criteria listed in the following table shall be used to evaluate the environmental impact of human exposure to radio-frequency (RF) radiation as specified in 1.1307(b).

(A) Limits for Occupational / Controlled Exposure

Frequency Range (MHz)	Electric Field Strength (E) (V/m)	Magnetic Field Strength (H) (A/m)	Power Density (S) (mW/ cm ²)	Averaging Time E ² , H ² or S (minutes)
0.3-3.0	614	1.63	(100)*	6
3.0-30	1842 / f	4.89 / f	(900 / f)*	6
30-300	61.4	0.163	1.0	6
300-1500			F/300	6
1500-100,000			5	6

(B) Limits for General Population / Uncontrolled Exposure

Frequency Range (MHz)	Electric Field Strength (E) (V/m)	Magnetic Field Strength (H) (A/m)	Power Density (S) (mW/ cm ²)	Averaging Time E ² , H ² or S (minutes)
0.3-1.34	614	1.63	(100)*	30
1.34-30	824/f	2.19/f	(180/f)*	30
30-300	27.5	0.073	0.2	30
300-1500			F/1500	30
1500-100,000			1.0	30

Note: f = frequency in MHz ; *Plane-wave equivalent power density

11.1.1 MEASUREMENT INSTRUMENTS LIST

Item	Kind of Equipment	Manufacturer	Type No.	Serial No.	Calibrated until
1	Spectrum Analyzer	R&S	FSP 40	100185	Nov.26.2011

Remark: " N/A" denotes No Model Name , Serial No. or No Calibration specified.



11.1.2 MPE CALCULATION METHOD

Calculation Method of RF Safety Distance:

$$S = \frac{PG}{4\pi r^2} = \frac{EIRP}{4\pi r^2}$$

P :power input to the antenna in Mw

EIRP :Equivalent(effective) isotropic radiated power.

S :power density mW/ cm²

G :numeric gain of antenna relative to isotropic radiator

R :distance to centre of radiation in cm

FCC radio frequency exposure limits may be exceeded at distances closer than r cm from the antenna of this device

$$r = \sqrt{\frac{PG}{4\pi S}} = \sqrt{\frac{EIRP}{4\pi S}}$$

11.1.3 DEVIATION FROM STANDARD

No deviation.

11.1.4 TEST SETUP

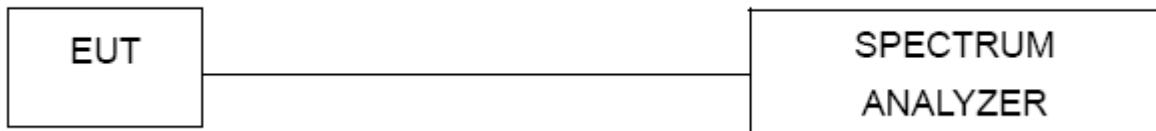

11.1.5 EUT OPERATION CONDITIONS

The EUT tested system was configured as the statements of 4.1.6 Unless otherwise a special operating condition is specified in the follows during the testing.



11.1.6 TEST RESULTS

EUT :	Compact Stereo System	Model Name :	SC-HC05
Temperature :	23 °C	Relative Humidity :	58 %
Pressure :	1009 hPa	Test Voltage :	AC 120V/60Hz
Test Mode :	CH00 (2402 MHz), CH39(2441 MHz) , CH78 (2480 MHz) -1Mbps		

Frequency (MHz)	Antenna Gain (dBi)	Peak Output Power (dBm)	Calculated EIRP (mW)	FCC Threshold (mW)	Test Result
2402	1.78	-2.4200	0.863	24.98	Complies
2441	1.78	-1.4900	1.069	24.58	Complies
2480	1.78	-2.4900	0.849	24.19	Complies

Note: Shown calculated EIRP is "worst case" scenario (peak power value) showing definite compliance with the threshold level.

EUT :	Compact Stereo System	Model Name :	SC-HC05
Temperature :	23 °C	Relative Humidity :	58 %
Pressure :	1009 hPa	Test Voltage :	AC 120V/60Hz
Test Mode :	CH00 (2402 MHz), CH39(2441 MHz) , CH78 (2480 MHz) -3Mbps		

Frequency (MHz)	Antenna Gain (dBi)	Peak Output Power (dBm)	Calculated EIRP (mW)	FCC Threshold (mW)	Test Result
2402	1.78	-4.1100	0.585	24.98	Complies
2441	1.78	-3.3700	0.693	24.58	Complies
2480	1.78	-3.5600	0.664	24.19	Complies

Note: Shown calculated EIRP is "worst case" scenario (peak power value) showing definite compliance with the threshold level.