



# FCC RADIO TEST REPORT

FCC ID : A4RGUL82  
Equipment : Phone  
Model Name : GUL82  
Applicant : Google LLC  
1600 Amphitheatre Parkway,  
Mountain View, CA, 94043 USA  
Standard : FCC Part 15 Subpart E §15.407

The product was received on Jan. 15, 2025 and testing was performed from Jan. 24, 2025 to Apr. 02, 2025. We, Sporton International Inc. Wensan Laboratory, would like to declare that the tested sample has been evaluated in accordance with the test procedures and has been in compliance with the applicable technical standards.

The test results in this report apply exclusively to the tested model / sample. Without written approval from Sporton International Inc. Wensan Laboratory, the test report shall not be reproduced except in full.

Approved by: Louis Wu

**Sporton International Inc. Wensan Laboratory**

No.58, Aly. 75, Ln. 564, Wenhua 3rd, Rd., Guishan Dist., Taoyuan City 333010, Taiwan (R.O.C.)



## Table of Contents

History of this test report.....	3
Summary of Test Result.....	4
<b>1 General Description .....</b>	<b>5</b>
1.1 Product Feature of Equipment Under Test.....	5
1.2 Modification of EUT .....	6
1.3 Testing Location .....	6
1.4 Applicable Standards.....	6
<b>2 Test Configuration of Equipment Under Test .....</b>	<b>7</b>
2.1 Carrier Frequency and Channel .....	7
2.2 Test Mode.....	9
2.3 Connection Diagram of Test System.....	11
2.4 Support Unit used in test configuration and system .....	12
2.5 EUT Operation Test Setup .....	12
2.6 Measurement Results Explanation Example.....	13
<b>3 Test Result .....</b>	<b>14</b>
3.1 26dB & 99% Occupied Bandwidth Measurement .....	14
3.2 Fundamental Maximum EIRP Measurement .....	15
3.3 Fundamental Power Spectral Density Measurement.....	16
3.4 In-Band Emissions (Channel Mask) .....	18
3.5 Proper Power Adjustment, Client Devices Connected to a Standard Power Access Point (APC) .....	20
3.6 Dual Client Test, Demonstration of Proper Power Adjustment based on Associated AP .....	25
3.7 Unwanted Emissions Measurement.....	28
3.8 AC Conducted Emission Measurement.....	32
3.9 Antenna Requirements.....	34
<b>4 List of Measuring Equipment.....</b>	<b>35</b>
<b>5 Measurement Uncertainty .....</b>	<b>37</b>
<b>Appendix A. Conducted Test Results</b>	
<b>Appendix B. AC Conducted Emission Test Result</b>	
<b>Appendix C. Radiated Spurious Emission Test Data</b>	
<b>Appendix D. Duty Cycle Plots</b>	
<b>Appendix E. Setup Photographs</b>	



### History of this test report

Report No.	Version	Description	Issue Date
FR4N0918H	01	Initial issue of report	Apr. 24, 2025
FR4N0918H	02	Revise appendix A This report is an updated version, replacing the report issued on Apr. 24, 2025.	May 05, 2025
FR4N0918H	03	Revise Appendix C This report is an updated version, replacing the report issued on May 05, 2025.	May 19, 2025



### Summary of Test Result

Report Clause	Ref Std. Clause	Test Items	Result (PASS/FAIL)	Remark
3.1	15.407(a)(10)	26dB Emission Bandwidth	Pass	-
3.1	2.1049	99% Occupied Bandwidth	Pass	-
3.2	15.407(a)(7)	Fundamental Maximum EIRP	Pass	-
3.3	15.407(a)(7)	Fundamental Power Spectral Density	Pass	-
3.4	15.407(b)(6)	In-Band Emissions (Channel Mask)	Pass	-
-	15.407(d)(6)	Contention Based Protocol	Pass	See Note
3.5	15.407 KDB 987594 D02 Section II. L.	Proper Power Adjustment, Client Devices Connected to a Standard Power Access Point(APC)	Pass	-
3.6	15.407 KDB 987594 D02 Section II. K.	Dual Client Test, Demonstration of Proper Power Adjustment based on Associated AP	Pass	-
3.7	15.407(b)	Unwanted Emissions	Pass	-
3.8	15.207	AC Conducted Emission	Pass	-
3.9	15.203 15.407(a)	Antenna Requirement	Pass	-

**Note:** The receiver circuitry is the same for the CBP mechanism so testing can be performed once based on LPI report to show compliance

<b>Conformity Assessment Condition:</b>
1. The test results (PASS/FAIL) with all measurement uncertainty excluded are presented against the regulation limits or in accordance with the requirements stipulated by the applicant/manufacturer who shall bear all the risks of non-compliance that may potentially occur if measurement uncertainty is taken into account.
2. The measurement uncertainty please refer to each test result in the section "Measurement Uncertainty".
<b>Disclaimer:</b>
The product specifications of the EUT presented in the test report that may affect the test assessments are declared by the manufacturer who shall take full responsibility for the authenticity.

**Reviewed by: William Chen**

**Report Producer: Lucy Wu**



# 1 General Description

## 1.1 Product Feature of Equipment Under Test

Product Feature
<p><b>General Specs</b> GSM/WCDMA/LTE/5G NR/NTN , Bluetooth, BLE, BLE channel sounding, Thread, Wi-Fi 802.11be, NFC, WPC Rx, UWB and GNSS Rx.</p> <p><b>Antenna Type</b> WLAN: &lt;Ant. 3&gt;: IFA Antenna &lt;Ant. 4&gt;: ILA Antenna</p>

**Remark:** The EUT's information above is declared by manufacturer.

EUT Information List	
S/N	Performed Test Item
4C241FDCQ00038	RF Conducted Measurement
51061FDCQ000MB	Radiated Spurious Emission
51061FDCQ000B2	Conducted Emission
4C241FDCQ0003A	Proper Power Adjustment, Client Devices Connected to a Standard Power Access Point(APC)
	Dual Client Test, Demonstration of Proper Power Adjustment based on Associated AP

Antenna information for Directional Gain		
5925 MHz ~ 6425 MHz	Peak Gain (dBi)	<6G_Ant3 + 6G_Ant4> Correlated: -3.33 Uncorrelated: -5.48
6525 MHz ~ 6875 MHz	Peak Gain (dBi)	<6G_Ant3 + 6G_Ant4> Correlated: -1.62 Uncorrelated: -3.85

**Remark:**

- The correlated antenna gain is provided by the MIMO antenna report using KDB 662911 D01 from manufacturer.
- The EUT's information above is declared by manufacturer. Please refer to Disclaimer in report summary.



### 1.2 Modification of EUT

No modifications made to the EUT during the testing.

### 1.3 Testing Location

<b>Test Site</b>	Sporton International Inc. EMC & Wireless Communications Laboratory
<b>Test Site Location</b>	No.52, Huaya 1st Rd., Guishan Dist., Taoyuan City 333, Taiwan (R.O.C.) TEL: +886-3-327-3456 FAX: +886-3-328-4978
<b>Test Site No.</b>	<b>Sporton Site No.</b> DF02-HY (TAF Code: 1190)
<b>Remark</b>	The Proper Power Adjustment, Client Devices Connected to a Standard Power Access Point(APC) and Dual Client Test, Demonstration of Proper Power Adjustment based on Associated AP test items subcontracted to Sporton International Inc. EMC & Wireless Communications Laboratory.

<b>Test Site</b>	Sporton International Inc. Wensan Laboratory
<b>Test Site Location</b>	No.58, Aly. 75, Ln. 564, Wenhua 3rd, Rd., Guishan Dist., Taoyuan City 333010, Taiwan (R.O.C.) TEL: +886-3-327-0868 FAX: +886-3-327-0855
<b>Test Site No.</b>	<b>Sporton Site No.</b> TH05-HY, CO07-HY, 03CH16-HY

**Note:** The test site complies with ANSI C63.4 2014 requirement.

FCC designation No.: TW1190 and TW3786

### 1.4 Applicable Standards

According to the specifications declared by the manufacturer, the EUT must comply with the requirements of the following standards:

- ♦ FCC Part 15 Subpart E
- ♦ FCC KDB 789033 D02 General UNII Test Procedures New Rules v02r01.
- ♦ FCC KDB 987594 D02 U-NII 6 GHz EMC Measurement v03
- ♦ FCC KDB 414788 D01 Radiated Test Site v01r01.
- ♦ FCC KDB 662911 D01 Multiple Transmitter Output v02r01.
- ♦ ANSI C63.10-2013

**Remark:**

1. All the test items were validated and recorded in accordance with the standards without any modification during the testing.
2. The TAF code is not including all the FCC KDB listed without accreditation.



## 2 Test Configuration of Equipment Under Test

- a. The EUT has been associated with peripherals and configuration operated in a manner tended to maximize its emission characteristics in a typical application. Frequency range investigated: conduction emission (150 kHz to 30 MHz), radiation emission (9 kHz to the 10th harmonic of the highest fundamental frequency or to 40 GHz, whichever is lower). For radiated measurement, the measured emission level of the EUT was maximized by rotating the EUT on a turntable, adjusting the orientation of the EUT antenna in three orthogonal axis (X: flat, Y: portrait, Z: landscape) and accessory (Adapter or Earphone), and adjusting the measurement antenna orientation, following C63.10 exploratory test procedures and find Y plane with Adapter as worst plane.
- b. AC power line Conducted Emission was tested under maximum output power.

### 2.1 Carrier Frequency and Channel

BW 20M	Channel	1	5	9	13	17	21	25	29
	Freq. (MHz)	5955	5975	5995	6015	6035	6055	6075	6095
BW 40M	Channel	3		11		19		27	
	Freq. (MHz)	5965		6005		6045		6085	
BW 80M	Channel	7				23			
	Freq. (MHz)	5985				6065			
BW 160M	Channel	15							
	Freq. (MHz)	6025							

BW 20M	Channel	33	37	41	45	49	53	57	61
	Freq. (MHz)	6115	6135	6155	6175	6195	6215	6235	6255
BW 40M	Channel	35		43		51		59	
	Freq. (MHz)	6125		6165		6205		6245	
BW 80M	Channel	39				55			
	Freq. (MHz)	6145				6225			
BW 160M	Channel	47							
	Freq. (MHz)	6185							



BW 20M	Channel	65	69	73	77	81	85	89	93
	Freq. (MHz)	6275	6295	6315	6335	6355	6375	6395	6415
BW 40M	Channel	67		75		83		91	
	Freq. (MHz)	6285		6325		6365		6405	
BW 80M	Channel	71				87			
	Freq. (MHz)	6305				6385			
BW 160M	Channel	79							
	Freq. (MHz)	6345							

BW 20M	Channel	117		121		125	
	Freq. (MHz)	6535		6555		6575	
BW 40M	Channel	-				123	
	Freq. (MHz)	-				6565	
BW 80M	Channel	-					
	Freq. (MHz)	-					

BW 20M	Channel	129	133	137	141	145	149	153	157
	Freq. (MHz)	6595	6615	6635	6655	6675	6695	6715	6735
BW 40M	Channel	131		139		147		155	
	Freq. (MHz)	6605		6645		6685		6725	
BW 80M	Channel	135				151			
	Freq. (MHz)	6625				6705			
BW 160M	Channel	143							
	Freq. (MHz)	6665							

BW 20M	Channel	161	165	169	173	177	181
	Freq. (MHz)	6755	6775	6795	6815	6835	6855
BW 40M	Channel	163		171		179	
	Freq. (MHz)	6765		6805		6845	
BW 80M	Channel	167				-	
	Freq. (MHz)	6785				-	
BW 160M	Channel	-					
	Freq. (MHz)	-					





## 2.2 Test Mode

This device supports WiFi 802.11be 20MHz bandwidth for 2.4GHz and 160MHz bandwidth for both 5GHz and 6GHz.

This device supports both CDD and SDM modes.

For bands other than LPI and VLP, SDM mode is covered by CDD mode due to identical power level.

This device supports 26/52/106/242/484/996 single tone RU modes for 802.11ax/be modes and the 242/484/996-tone RU modes are covered by 20/40/80MHz channels.

This device supports MRU 52T+26T/106T+26T (small RU) and punctured modes 484+242-tone, 996+484+242-tone, and 996+484-tone (large RU) for 802.11be mode.

The PSD of partial RU/MRU modes are reduced to be smaller than full RU according to TCB workshop interim guidance Oct. 2018 and Oct. 2022 for WiFi 7 device.

The 802.11ax/be modes are investigated among full RU, single RU and MRU modes for emission spot check and the 11ax modes are covered by 11be modes.

The PSD and power of partial RU and MRU are less than full RU configurations so the full RU is chosen as main test configuration.

The power for 802.11ax mode is smaller than 802.11be mode, so all other conducted and radiated test is covered by 802.11be mode.

The final test modes include the worst data rates for each modulation shown in the table below.

### MIMO Mode

Specification	MCS index /Data Rate
802.11a	6 Mbps
802.11ax HE20 (Covered by EHT20)	MCS0
802.11ax HE40 (Covered by EHT40)	MCS0
802.11ax HE80 (Covered by EHT80)	MCS0
802.11ax HE160 (Covered by EHT160)	MCS0
802.11be EHT20	MCS0
802.11be EHT40	MCS0
802.11be EHT80	MCS0
802.11be EHT160	MCS0



**Index of MRU and puncture mode mapping**

Small MRU

MRU	26T	52T	106T
52T+26T		70	72
		71	
106T+26T		82	
			83

Large MRU

484+242-tone MRU			
2	1	4	3
80MHz puncture 20			
8	4	2	1

996+484+242-tone MRU							
2	1	4	3	6	5	8	7
160MHz puncture 20							
128	64	32	16	8	4	2	1

996+484-tone MRU			
2	1	4	3
160MHz puncture 40			
192	48	12	3

Note: The RF waveform is identical for large MRU and puncture modes.

Test Cases	
AC Conducted Emission	Mode 1 : 802.11be EHT20 Channel 49 Tx + USB Cable 2 (Charging from AC Adapter)
<p><b>Remark:</b></p> <ol style="list-style-type: none"> <li>1. For Radiated Test Cases, the tests were performed with USB Cable 2.</li> <li>2. During the preliminary test, both charging modes (Adapter mode and WPC Rx mode) were verified. It is determined that the adaptor mode is the worst case for official test.</li> <li>3. Based on ANSI C63.10 clause 5.6.2.2, b) Spurious emissions, measure the mode with the highest output power and the mode with highest output power spectral density for each modulation family.</li> <li>4. The detailed Radiated test modes are shown in Appendix C.</li> </ol>	

## 2.3 Connection Diagram of Test System

### <AC Conducted Emission Mode>

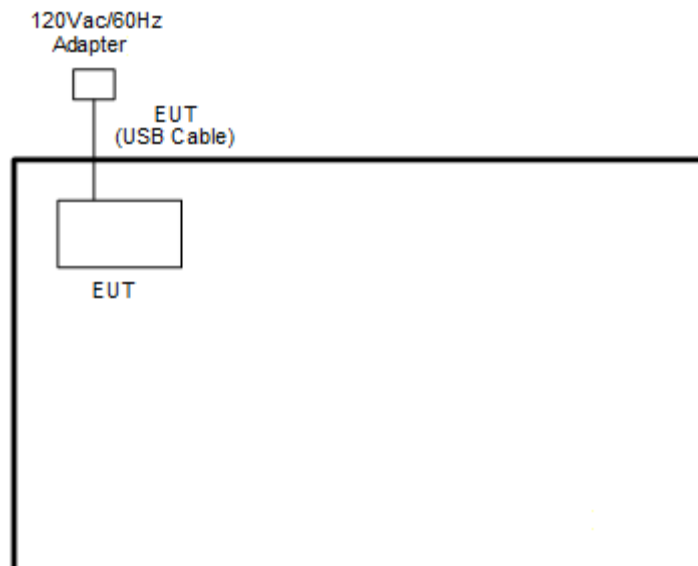

<WLAN Tx Mode>

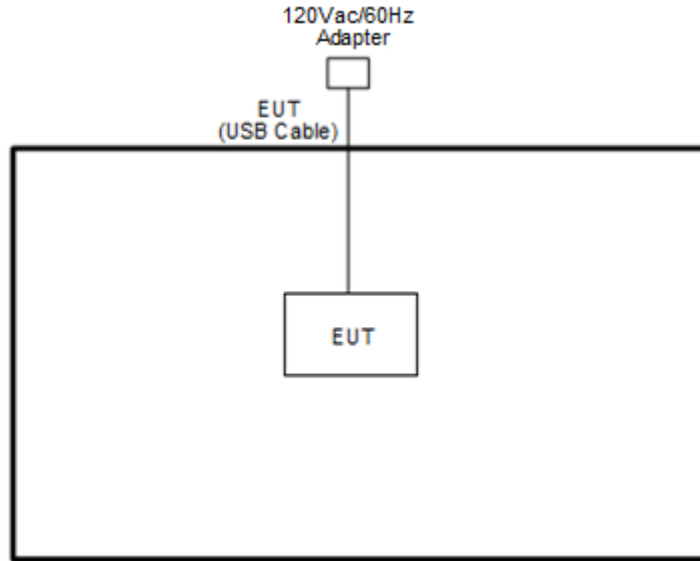

## 2.4 Support Unit used in test configuration and system

Item	Equipment	Brand Name	Model Name	FCC ID	Data Cable	Power Cord
1.	Adapter	N/A	G9BR1	N/A	N/A	N/A

## 2.5 EUT Operation Test Setup

The RF test items, utility "BTWIFI\_Final\_version\_240823" was installed in Notebook which was programmed in order to make the EUT get into the engineering modes to provide channel selection, power level, data rate and the application type and for continuous transmitting signals.



## 2.6 Measurement Results Explanation Example

### For all conducted test items:

The offset level is set in the spectrum analyzer to compensate the RF cable loss and attenuator factor between EUT conducted output port and spectrum analyzer. With the offset compensation, the spectrum analyzer reading level is exactly the EUT RF output level.

Example :

The spectrum analyzer offset is derived from RF cable loss and attenuator factor.

*Offset = RF cable loss + attenuator factor.*

Following shows an offset computation example with cable loss 4.2 dB and 10dB attenuator.

$$\begin{aligned} \text{Offset(dB)} &= \text{RF cable loss(dB)} + \text{attenuator factor(dB)}. \\ &= 4.2 + 10 = 14.2 \text{ (dB)} \end{aligned}$$

### For EIRP output power:

The EIRP output power result is derived from RF conducted power plus directional antenna gain.

*EIRP = RF conducted power + directional antenna gain.*

Following shows an offset computation example with conducted power 20.2 dBm and directional antenna gain 3dBi.

$$\begin{aligned} \text{EIRP(dBm)} &= \text{RF conducted power(dBm)} + \text{directional antenna gain(dBi)}. \\ &= 20.2 + 3 = 23.2 \text{ (dBm)} \end{aligned}$$

### 3 Test Result

#### 3.1 26dB & 99% Occupied Bandwidth Measurement

##### 3.1.1 Limit of 26dB & 99% Occupied Bandwidth

<FCC 14-30 CFR 15.407>

(a)(10) The maximum transmitter channel bandwidth for U-NII devices in the 5.925-7.125 GHz band is 320 megahertz.

##### 3.1.2 Measuring Instruments

Please refer to the measuring equipment list in this test report.

##### 3.1.3 Test Procedures

1. The testing follows FCC KDB 789033 D02 General UNII Test Procedures New Rules v02r01. Section C) Emission bandwidth
2. Set RBW = approximately 1% of the emission bandwidth.
3. Set the VBW > RBW.
4. Detector = Peak.
5. Trace mode = max hold
6. Measure the maximum width of the emission that is 26 dB down from the peak of the emission. Compare this with the RBW setting of the analyzer. Readjust RBW and repeat measurement as needed until the RBW/EBW ratio is approximately 1%.
7. For 99% Bandwidth Measurement, the spectrum analyzer's resolution bandwidth (RBW) is set 1-5% of the emission bandwidth and set the Video bandwidth (VBW)  $\geq 3 * RBW$ .
8. Measure and record the results in the test report.

##### 3.1.4 Test Setup

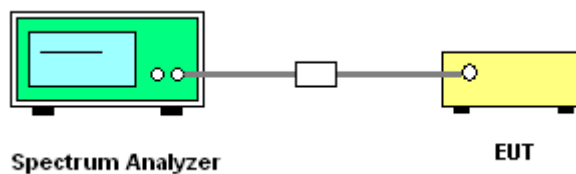

##### 3.1.5 Test Result of 26dB & 99% Occupied Bandwidth

Please refer to Appendix A.

Note: The EBW spectrum setting is as following table for different nominal bandwidth.

setting	20MHz	40MHz	80MHz	160MHz
RBW	300kHz	1MHz	1MHz	2MHz
VBW	1MHz	3MHz	3MHz	10MHz

## 3.2 Fundamental Maximum EIRP Measurement

### 3.2.1 Limit of Fundamental Maximum EIRP

<FCC 14-30 CFR 15.407>

(a)(7) For client devices, except for fixed client devices as defined in this subpart, operating under the control of a standard power access

point in 5.925-6.425 GHz and 6.525-6.875 GHz bands, the maximum power spectral density must not exceed 17 dBm e.i.r.p. in any 1-megahertz band, and the maximum e.i.r.p. over the frequency band of operation must not exceed 30 dBm and the device must limit its power to no more than 6 dB below its associated standard power access point's authorized transmit power.

### 3.2.2 Measuring Instruments

Please refer to the measuring equipment list in this test report.

### 3.2.3 Test Procedures

The testing follows Method PM-G of FCC KDB 789033 D02 General UNII Test Procedures New Rules v02r01.

Method PM-G (Measurement using a gated RF average power meter):

1. Measurement is performed using a wideband RF power meter.
2. The EUT is configured to transmit at its maximum power control level.
3. Measure the average power of the transmitter.
4. Since the measurement is made only during the ON time of the transmitter, no duty cycle correction factor is required.
5. For MIMO mode, calculation method follows FCC KDB 662911 D01 Multiple Transmitter Output v02r01.

### 3.2.4 Test Setup

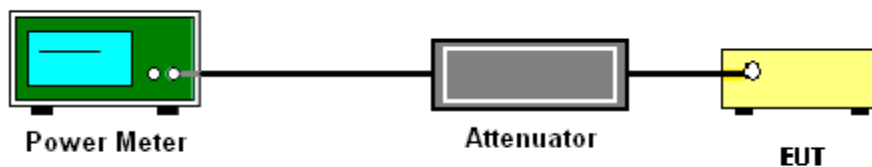

### 3.2.5 Test Result of Fundamental Maximum EIRP

Please refer to Appendix A.



### 3.3 Fundamental Power Spectral Density Measurement

#### 3.3.1 Limit of Fundamental Power Spectral Density

<FCC 14-30 CFR 15.407>

(a)(7) For client devices, except for fixed client devices as defined in this subpart, operating under the control of a standard power access point in 5.925-6.425 GHz and 6.525-6.875 GHz bands, the maximum power spectral density must not exceed 17 dBm e.i.r.p. in any 1-megahertz band.

#### 3.3.2 Measuring Instruments

Please refer to the measuring equipment list in this test report.

#### 3.3.3 Test Procedures

The testing follows FCC KDB 789033 D02 General UNII Test Procedures New Rules v02r01.

Section F) Maximum power spectral density.

**# Method SA-2 #**

(trace averaging across on and off times of the EUT transmissions, followed by duty cycle correction).

- Measure the duty cycle.
  - Set span to encompass the entire emission bandwidth (EBW) of the signal.
  - Set RBW = 1 MHz.
  - Set VBW  $\geq$  3 MHz.
  - Number of points in sweep  $\geq$  2 Span / RBW.
  - Sweep time = auto.
  - Detector = RMS
  - Trace average at least 100 traces in power averaging mode.
  - Add  $10 \log(1/x)$ , where  $x$  is the duty cycle, to the measured power in order to compute the average power during the actual transmission times. For example, add  $10 \log(1/0.25) = 6$  dB if the duty cycle is 25 percent.
1. The RF output of EUT was connected to the spectrum analyzer by a low loss cable.
  2. Each plot has already offset with cable loss, and attenuator loss. Measure the PPSD and record it.
  3. For MIMO mode, calculation method follows FCC KDB 662911 D01 Multiple Transmitter Output v02r01.

Method (a): Measure and sum the spectra across the outputs.

The total final Power Spectral Density is from a device with 2 transmitter outputs. The spectrum measurements of the individual outputs are all performed with the same span and number of points; the spectrum value in the first spectral bin of output 1 is summed with that in the first spectral bin of output 2 to obtain the value for the first frequency bin of the summed spectrum.



### 3.3.4 Test Setup

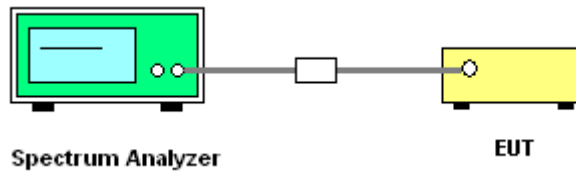

### 3.3.5 Test Result of Power Spectral Density

Please refer to Appendix A.



## **3.4 In-Band Emissions (Channel Mask)**

### **3.4.1 Limit of Unwanted Emissions**

**<FCC 14-30 CFR 15.407>**

(a)(6) For transmitters operating within the 5.925-7.125 GHz bands: Power spectral density must be suppressed by 20 dB at 1 MHz outside of channel edge, by 28 dB at one channel bandwidth from the channel center, and by 40 dB at one- and one-half times the channel bandwidth away from channel center. At frequencies between one megahertz outside an unlicensed device's channel edge and one channel bandwidth from the center of the channel, the limits must be linearly interpolated between 20 dB and 28 dB suppression, and at frequencies between one and one- and one-half times an unlicensed device's channel bandwidth, the limits must be linearly interpolated between 28 dB and 40 dB suppression. Emissions removed from the channel center by more than one- and one-half times the channel bandwidth must be suppressed by at least 40 dB.

### **3.4.2 Measuring Instruments**

Please refer to the measuring equipment list in this test report.

### 3.4.3 Test Procedures

The testing follows FCC KDB 987594 D02 U-NII 6GHz EMC Measurement v02r01.

Section J) In-Band Emissions.

1. Take nominal bandwidth as reference channel bandwidth provided that 26 dB emission bandwidth is always larger than nominal bandwidth
2. Measure the power spectral density (which will be used for emissions mask reference) using the following procedure:
  - a) Set the span to encompass the entire 26 dB EBW of the signal.
  - b) Set RBW = same RBW used for 26 dB EBW measurement.
  - c) Set VBW  $\geq 3 \times$  RBW
  - d) Number of points in sweep  $\geq [2 \times \text{span} / \text{RBW}]$ .
  - e) Sweep time = auto.
  - f) Detector = RMS (i.e., power averaging)
  - g) Trace average at least 100 traces in power averaging (rms) mode.
  - h) Use the peak search function on the instrument to find the peak of the spectrum.
3. Using the measuring equipment limit line function, develop the emissions mask based on the following requirements. The emissions power spectral density must be reduced below the peak power spectral density (in dB) as follows:
  - a. Suppressed by 20 dB at 1 MHz outside of the channel edge.
  - b. Suppressed by 28 dB at one channel bandwidth from the channel center.
  - c. Suppressed by 40 dB at one- and one-half times the channel bandwidth from the channel center.
4. Adjust the span to encompass the entire mask as necessary.
5. Clear trace.
6. Trace average at least 100 traces in power averaging (rms) mode.
7. Adjust the reference level as necessary so that the crest of the channel touches the top of the emission mask.

### 3.4.4 Test Setup

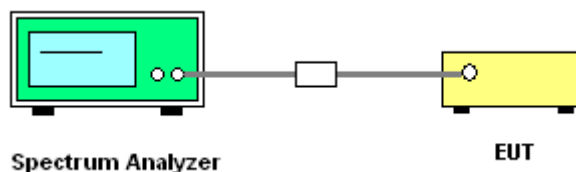

### 3.4.5 Test Result of In-Band Emissions (Channel Mask)

Please refer to Appendix A.



### 3.5 Proper Power Adjustment, Client Devices Connected to a Standard Power Access Point (APC)

#### 3.5.1 Limit of Standard Client Proper Power Adjustment

15.407 KDB 987594 D02 Section II. L. Power limits for standard client devices

c) The maximum power limits shall remain at least 6 dB below the power levels authorized for the associated standard-power access point

#### 3.5.2 Test Procedures of Standard Client Proper Power Adjustment

The testing follows FCC KDB 987594 D02 U-NII 6 GHz EMC Measurement v3.

Section L. Proper Power Adjustment

#### 3.5.3 Proper Power Adjustment, Client Devices Connected to a Standard Power Access Point

A client device that connects to a Standard Power AP must limit its power to a minimum of 6 dB lower than its associated Standard Power access point's authorized transmit power. The term "authorized" means the AFC-approved power level for the AP to use on a particular channel.

Test procedure to show that the client device can lower its power accordingly.

#### 3.5.4 Test Procedure:

1. Connect equipment as shown in Figure 7 below.
2. Adjust Atten 1 to Std Power AP so as to facilitate error free communication with the Client but protect the Client receiver from overload or damage.
3. Configure the Client and AP so that they associate and start sending data (stream data). The AP should be configured such that its registered power is 36 dBm EIRP.
4. Verify transmission between Client and Std Power AP. Additional attenuators may be required to protect measurement equipment. Measure the Client RF power using any of the methods in C63.10 for NII devices.
5. Use this power, along with its antenna gain, to calculate the Client EIRP.
6. The Client EIRP should be minimally 6 dB lower than that of the AP.
7. Repeat Steps 2 through 5 at two other selected measurement points – the first at the midpoint and the second at the lowest rated power of the client as declared by the manufacturer.

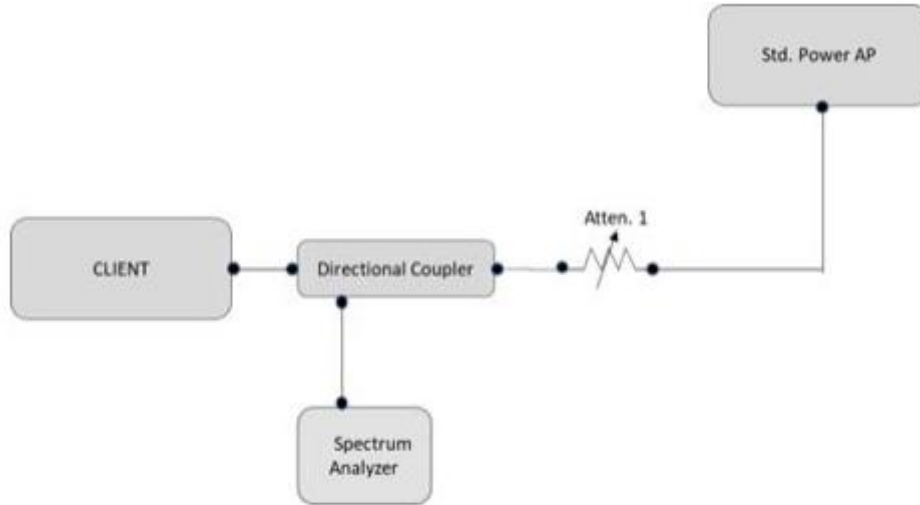

**Figure 7. Test setup for conducted testing**

**3.5.5 Test Result Summary**

Companion Standard Power AP: Brand name: Qualcomm, Model name: Wakiki  
 802.11be 20MHz bandwidth  
 Test channel 157

	Client Conducted Power (dBm)			Client EIRP (dBm)	AP EIRP (dBm)	AP to client EIRP Delta (dB)
	Ant3	Ant4	MIMO			
<b>Maximum EIRP</b>	17.64	16.71	20.21	16.36	34.60	18.24
<b>Midpoint EIRP</b>	15.00	14.04	17.56	13.71	25.60	11.89
<b>Lowest EIRP</b>	10.75	10.25	13.52	9.67	21.40	11.73
<b>Requirement</b>						At least 6 dB
<b>Result</b>						Pass

**Note:** Client EIRP = Client MIMO conducted power + antenna gain (-3.85dBi)



### 3.5.6 Test Result Plot

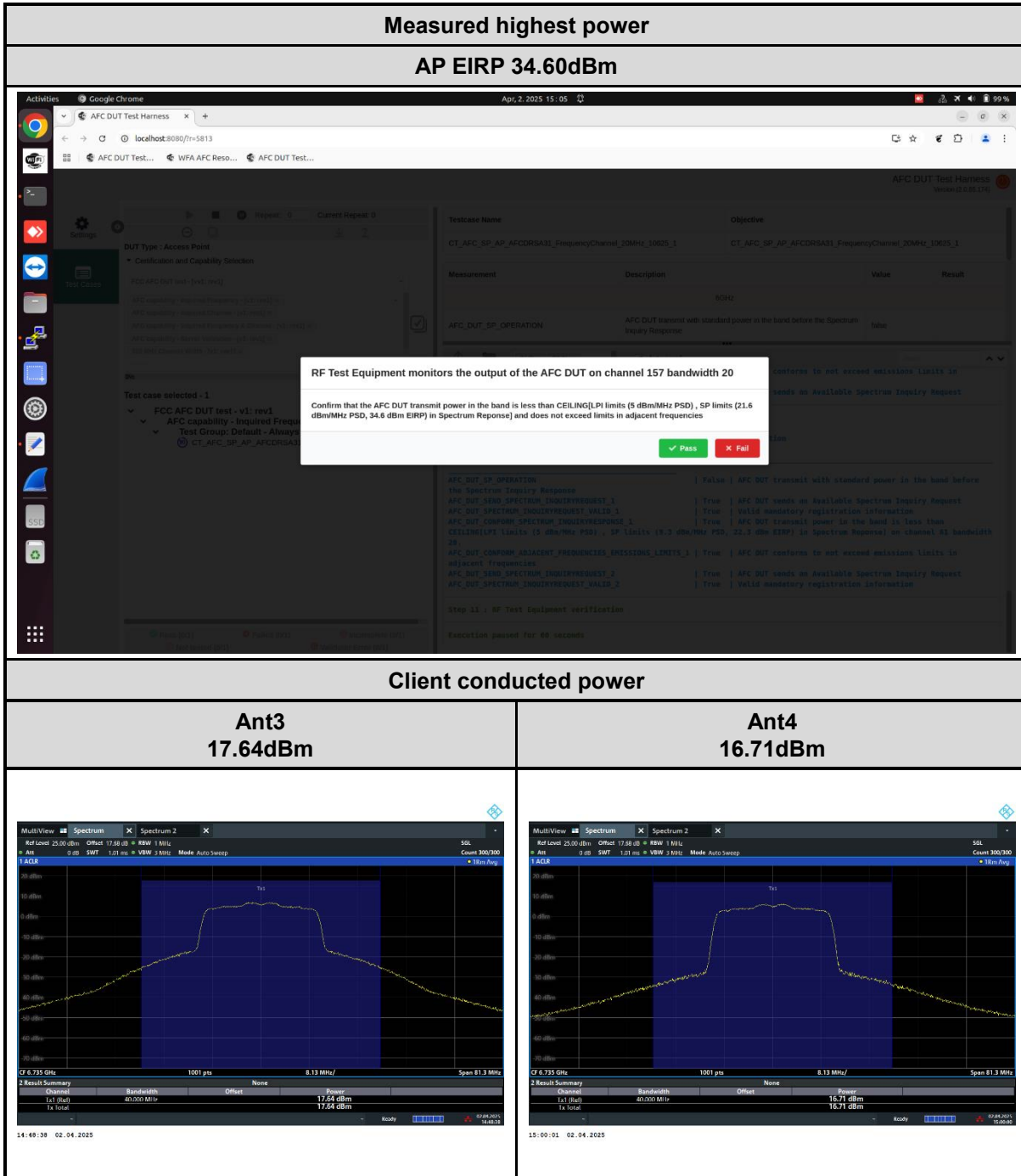

### Measured mid-point power

#### AP EIRP 25.60dBm

**RF Test Equipment monitors the output of the AFC DUT on channel 157 bandwidth 20**

Confirm that the AFC DUT transmit power in the band is less than CEILING/LPI limits (5 dBm/MHz PSD) , SP limits (12.6 dBm/MHz PSD, 25.6 dBm EIRP) in Spectrum Response] and does not exceed limits in adjacent frequencies

✔ Pass ✘ Fail

### Client conducted power

#### Ant3 15.00dBm

13:56:36 02.04.2025

#### Ant4 14.04dBm

13:52:24 02.04.2025

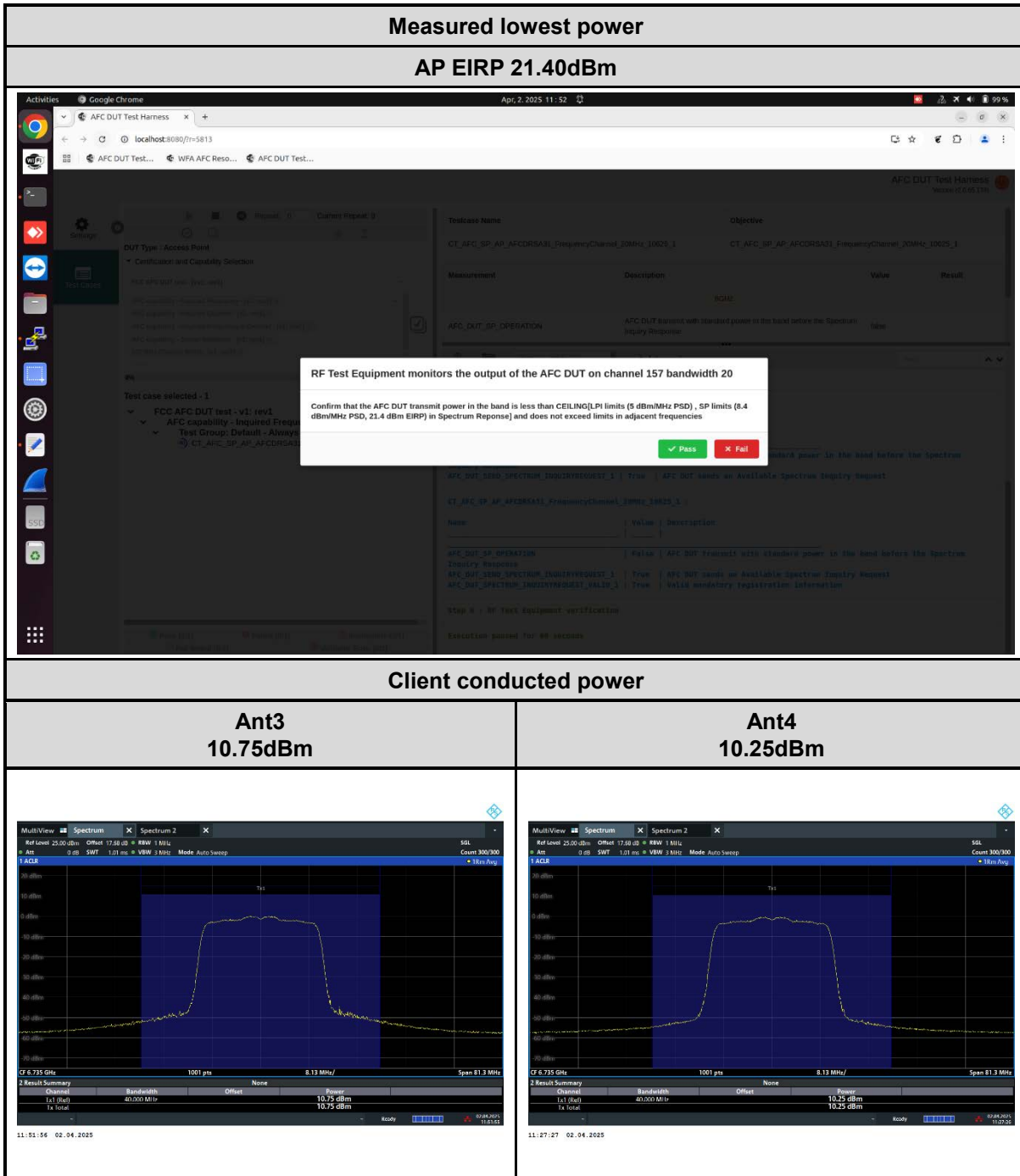





### **3.6 Dual Client Test, Demonstration of Proper Power Adjustment based on Associated AP**

#### **3.6.1 Limit of Proper Power Adjustment**

15.407 KDB 987594 D02 Section II. K. Power limits for standard client devices

A client device may connect to a Standard Power AP with a maximum power level of 30 dBm EIRP. A client may also connect to a Low Power indoor AP, but the power level is limited to a maximum of 24 dBm EIRP.

#### **3.6.2 Test Procedures of Standard Client Proper Power Adjustment**

The testing follows FCC KDB 987594 D02 U-NII 6 GHz EMC Measurement v03.

Section K. Dual Client Test, Demonstration of Proper Power Adjustment based on Associated AP

#### **3.6.3 Test Procedure:**

1. Connect equipment as shown in Figure 6 below..
2. Adjust Atten 2 to Std Power AP so as to facilitate error free communication with the Client (Atten 1 should be set to High on the RF path to the Low Power AP)
3. Configure the Client and APs so that they associate and start sending data (stream data). It is important that the client is configured to transmit at its highest power level. Initially, because the attenuation on Atten 1 is set high, the Client will only associate with the Std Power AP.
4. Verify transmission between Client and Std Power AP. Additional attenuators may be required to protect measurement equipment. Measure the Client RF power using any of the methods in C63.10 for NII devices.
5. Gradually increase Atten 2 while at the same time decreasing Atten 1. This simulates the Client moving from outdoors to indoors. At some level of attenuation the Client should associate with the Low Power indoor AP.
6. Verify transmission between Client and Low Power AP.
7. Measure the RF power of the Client device using the same method as in step 4. Verify the power is no more than 24 dBm EIRP

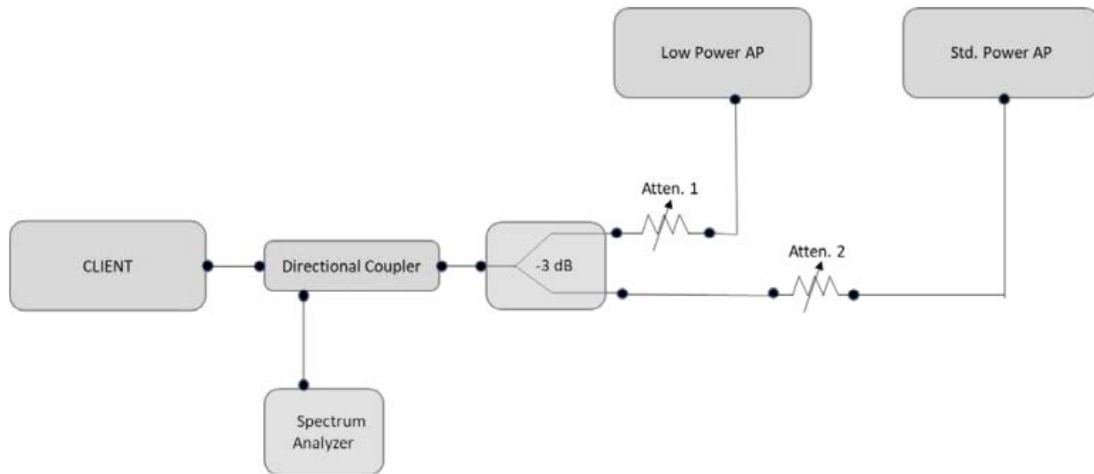

**Figure 6. Test setup for conducted testing**

### 3.6.4 Test Result Summary

Companion Standard Power AP: Brand name:Qualcomm, Model name:Wakiki

Companion Low Power indoor AP: Brand name: ASUS, Model name: RT-BE92U

802.11be 20MHz bandwidth

Test channel 157

	Client Conducted Power (dBm)			Client EIRP (dBm)	Limit EIRP (dBm)	Result
	Ant3	Ant4	MIMO			
<b>Indoor EIRP</b>	5.76	4.93	8.38	4.53	24	Pass
<b>Standard EIRP</b>	17.58	16.68	20.16	16.31	30	Pass

**Note:** Client EIRP = Client MIMO conducted power + antenna gain (-3.85dBi)



### 3.6.5 Test Result Plot

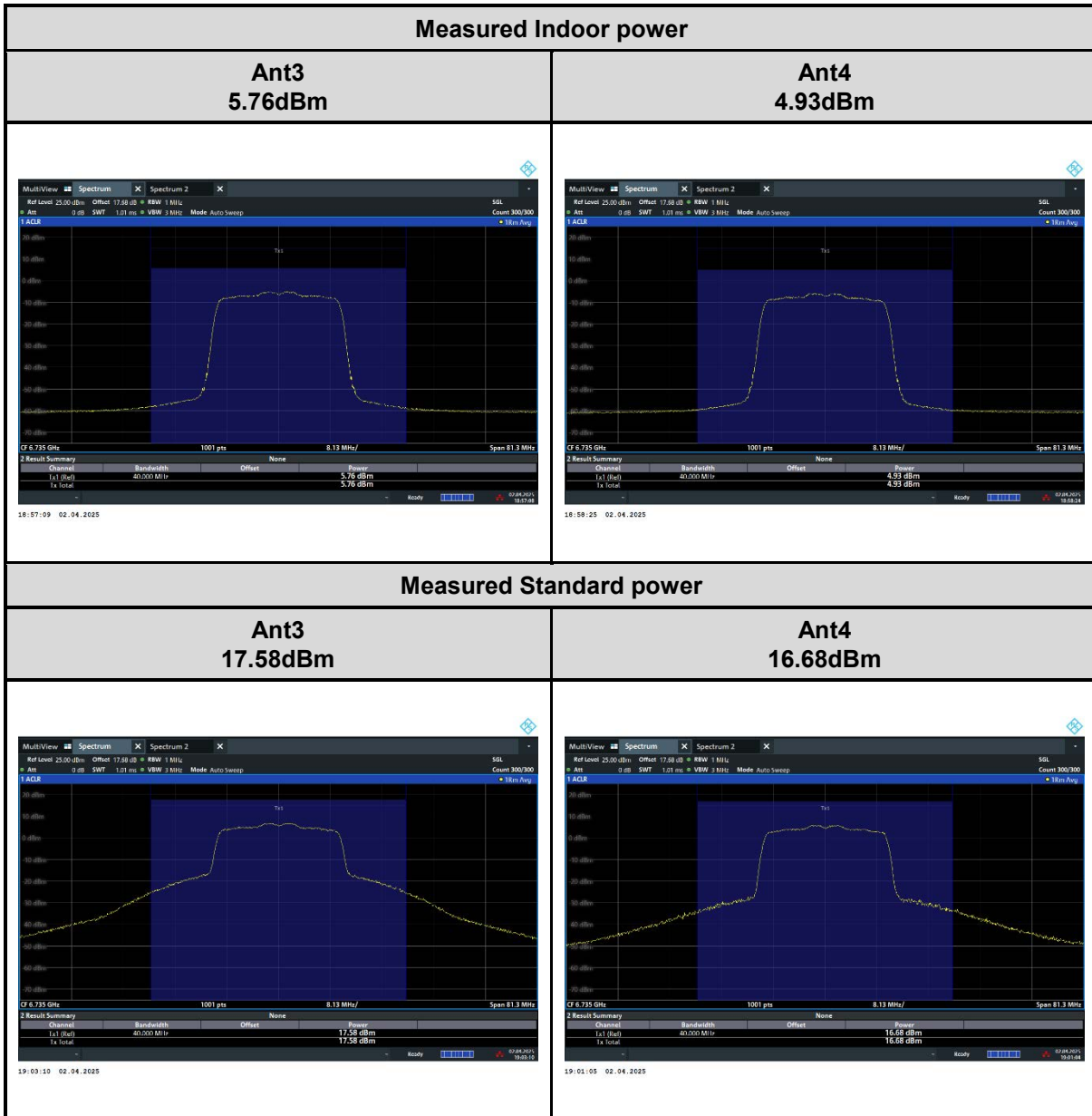



### 3.7 Unwanted Emissions Measurement

This section is to measure unwanted emissions through radiated measurement for band edge spurious emissions and out of band emissions measurement.

#### 3.7.1 Limit of Unwanted Emissions

- (1) For transmitters operating within the 5.925-7.125 GHz band: Any emissions outside of the 5.925-7.125 GHz band must not exceed an e.i.r.p. of -27 dBm/MHz.

EIRP (dBm)	Field Strength at 3m (dBµV/m)
- 27 (RMS)	68.3
- 7 (Peak)	88.3

According 987594 D02 U-NII 6GHz EMC Measurement v02r01 section G:

Unwanted emissions outside of restricted bands are measured with a RMS detector.

In addition, 15.35(b) applies where the peak emissions must be limited to no more than 20 dB above the average limit

- (2) Unwanted spurious emissions fallen in restricted bands shall comply with the general field strength limits as below table:

Frequency (MHz)	Field Strength (microvolts/meter)	Measurement Distance (meters)
0.009 – 0.490	2400/F(kHz)	300
0.490 – 1.705	24000/F(kHz)	30
1.705 – 30.0	30	30
30 – 88	100	3
88 – 216	150	3
216 - 960	200	3
Above 960	500	3

Note: The following formula is used to convert the EIRP to field strength.

$$E = \frac{1000000\sqrt{30P}}{3} \mu V/m, \text{ where } P \text{ is the eirp (Watts)}$$

#### 3.7.2 Measuring Instruments

Please refer to the measuring equipment list in this test report.



### 3.7.3 Test Procedures

1. The testing follows FCC KDB 789033 D02 General UNII Test Procedures New Rules v02r01. Section G) Unwanted emissions measurement.
  - (1) Procedure for Unwanted Emissions Measurements Below 1000MHz
    - RBW = 120 kHz
    - VBW = 300 kHz
    - Detector = Peak
    - Trace mode = max hold
  - (2) Procedure for Peak Unwanted Emissions Measurements Above 1000 MHz
    - RBW = 1 MHz
    - VBW  $\geq$  3 MHz
    - Detector = Peak
    - Sweep time = auto
    - Trace mode = max hold
  - (3) Procedures for Average Unwanted Emissions Measurements Above 1000MHz
    - RBW = 1 MHz
    - VBW = 10 Hz, when duty cycle is no less than 98 percent.
    - VBW  $\geq$  1/T, when duty cycle is less than 98 percent where T is the minimum transmission duration over which the transmitter is on and is transmitting at its maximum power control level for the tested mode of operation.
2. The EUT is placed on a turntable with 0.8 meter for frequency below 1 GHz and 1.5 meter for frequency above 1 GHz respectively above ground.
3. The EUT is set 3 meters away from the receiving antenna which is mounted on the top of a variable height antenna tower.
4. The antenna is a broadband antenna and its height is adjusted between one meter and four meters above ground to find the maximum value of the field strength for both horizontal polarization and vertical polarization of the antenna.
5. For each suspected emission, the EUT is arranged to its worst case and then adjust the antenna tower (from 1 m to 4 m) and turntable (from 0 degree to 360 degrees) to find the maximum reading.
6. Radiated testing below 1 GHz is performed by adjusting the antenna tower from 1 m to 4 m and by rotating the turn table from 0 degree to 360 degrees to find the peak maximum hold reading. When there is no suspected emission found and the emission level is with at least 6 dB margin against QP limit line, the position is marked as “-“.
7. Radiated testing above 1 GHz is performed by adjusting the antenna tower from 1 m to 4 m and by rotating the turn table from 0 degree to 360 degrees to find the peak maximum hold reading for scanning all frequencies. When there is no suspected emission found and the harmonic emission level is with at least 6 dB margin against average limit line, the position is marked as “-“..

### 3.7.4 Test Setup

For radiated emissions below 30MHz

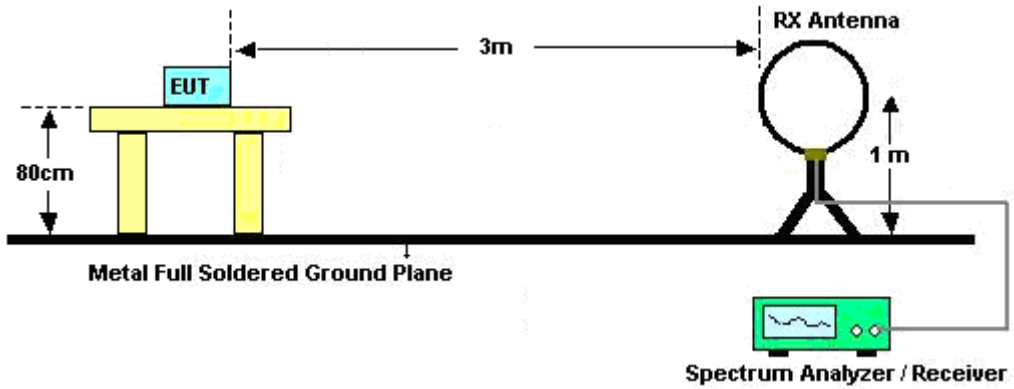

For radiated emissions from 30MHz to 1GHz

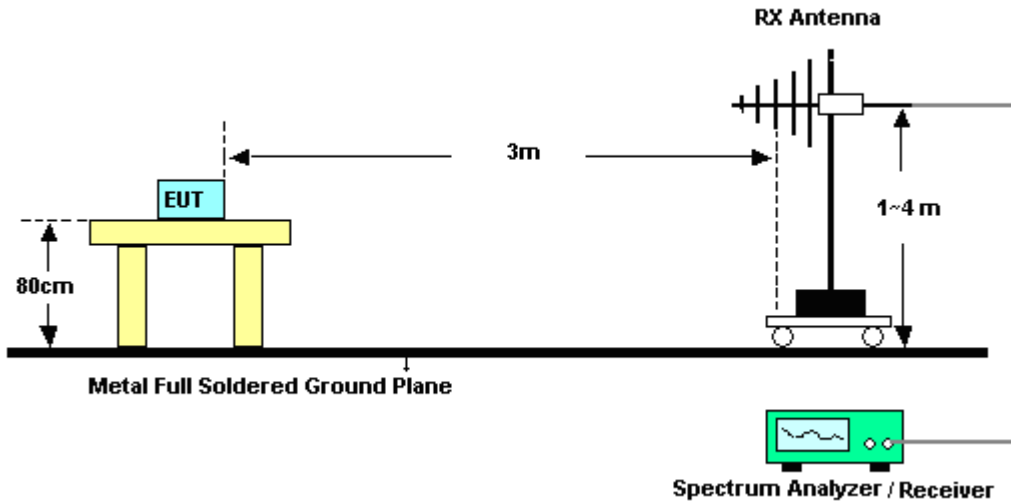

For radiated test from 1GHz to 18GHz

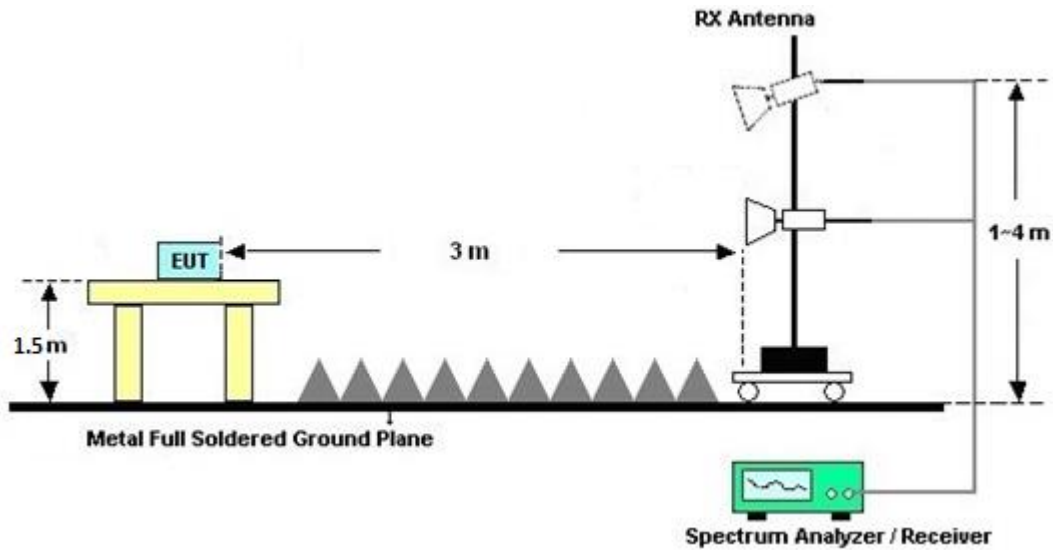

For radiated test above 18GHz

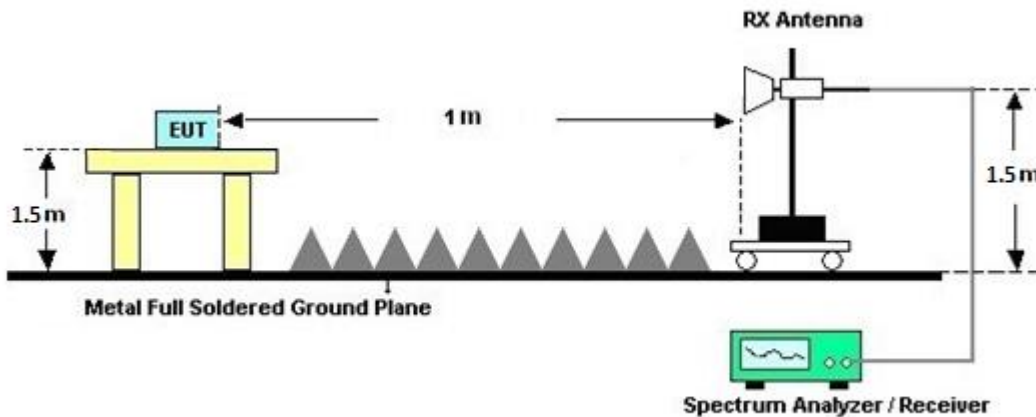

### 3.7.5 Test Results of Radiated Spurious Emissions (9 kHz ~ 30 MHz)

The low frequency, which starts from 9 kHz to 30 MHz, is pre-scanned and the result which is 20 dB lower than the limit line is not reported.

There is adequate comparison measurement of both open-field test site and alternative test site - semi-Anechoic chamber according to 414788 D01 Radiated Test Site v01r01, and the result came out very similar.

### 3.7.6 Test Result of Radiated Spurious at Band Edges

Please refer to Appendix C.

### 3.7.7 Duty Cycle

Please refer to Appendix D.

### 3.7.8 Test Result of Radiated Spurious Emissions (30MHz ~ 10th Harmonic)

Please refer to Appendix C.



### 3.8 AC Conducted Emission Measurement

#### 3.8.1 Limit of AC Conducted Emission

For equipment that is designed to be connected to the public utility (AC) power line, the radio frequency voltage that is conducted back onto the AC power line on any frequency or frequencies within the band 150 kHz to 30 MHz shall not exceed the limits in the following table.

Frequency of emission (MHz)	Conducted limit (dB $\mu$ V)	
	Quasi-peak	Average
0.15-0.5	66 to 56*	56 to 46*
0.5-5	56	46
5-30	60	50

\*Decreases with the logarithm of the frequency.

#### 3.8.2 Measuring Instruments

Please refer to the measuring equipment list in this test report.

#### 3.8.3 Test Procedures

1. The EUT is placed 0.4 meter away from the conducting wall of the shielding room, and is kept at least 80 centimeters from any other grounded conducting surface.
2. Connect EUT to the power mains through a line impedance stabilization network (LISN).
3. All the support units are connecting to the other LISN.
4. The LISN provides 50 ohm coupling impedance for the measuring instrument.
5. The FCC states that a 50 ohm, 50 microhenry LISN should be used.
6. Both Line and Neutral shall be tested in order to find out the maximum conducted emission.
7. The frequency range from 150 kHz to 30 MHz is scanned.
8. Set the test-receiver system to Peak Detect Function and specified bandwidth with Maximum Hold Mode.



### 3.8.4 Test Setup

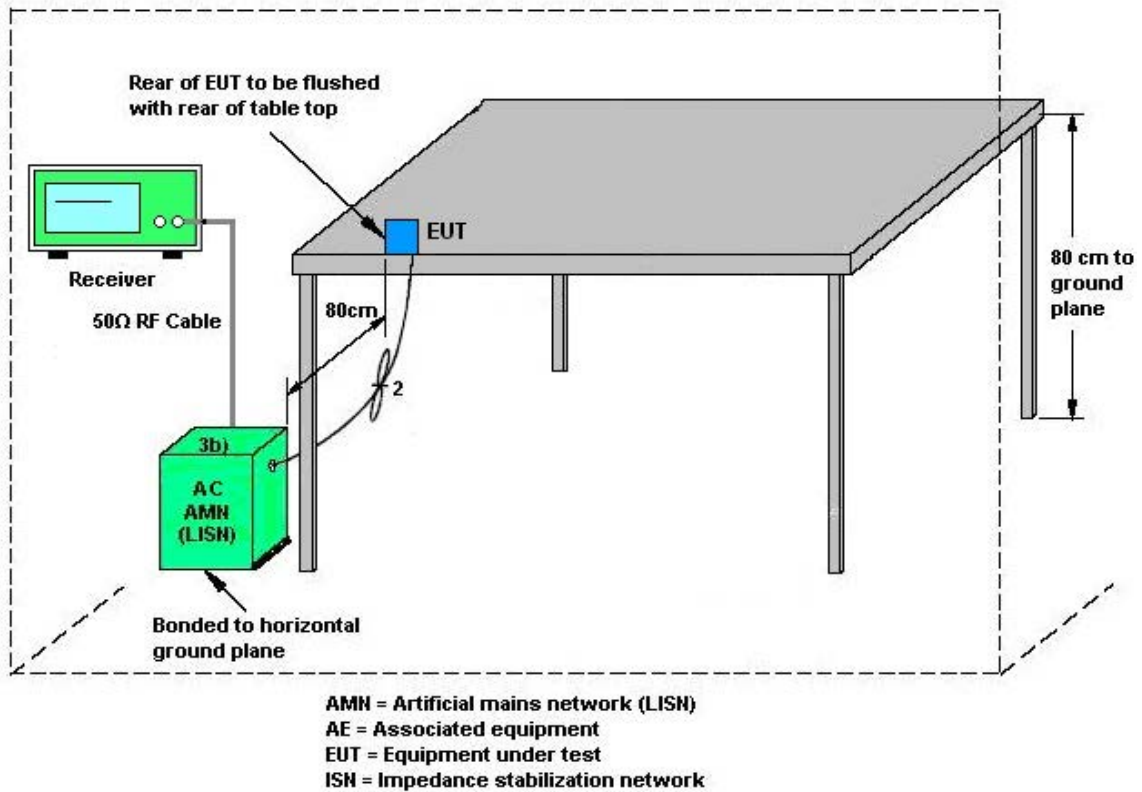

### 3.8.5 Test Result of AC Conducted Emission

Please refer to Appendix B.



## **3.9 Antenna Requirements**

### **3.9.1 Standard Applicable**

An intentional radiator shall be designed to ensure that no antenna other than that furnished by the responsible party shall be used with the device. The use of a permanently attached antenna or of an antenna that uses a unique coupling to the intentional radiator shall be considered sufficient to comply with the provisions of this section. The manufacturer may design the unit so that a broken antenna can be replaced by the user, but the use of a standard antenna jack or electrical connector is prohibited. This requirement does not apply to carrier current devices or to devices operated under the provisions of § 15.211, 15.213, 15.217, 15.219, 15.221, or § 15.236. Further, this requirement does not apply to intentional radiators that must be professionally installed, such as perimeter protection systems and some field disturbance sensors, or to other intentional radiators which, in accordance with § 15.31(d), must be measured at the installation site. However, the installer shall be responsible for ensuring that the proper antenna is employed so that the limits in this part are not exceeded.

### **3.9.2 Antenna Anti-Replacement Construction**

- b) Unique (non-standard) antenna connector.
- (3) Use of a standard connector is also allowed if the connector is within the transmitter enclosure and can only be accessed by disassembly of the transmitter, where such disassembly is not normally required. The user manual must not show that user has access to the connector.



## 4 List of Measuring Equipment

Instrument	Brand Name	Model No.	Serial No.	Characteristics	Calibration Date	Test Date	Due Date	Remark
Loop Antenna	Rohde & Schwarz	HFH2-Z2	100488	9 kHz~30 MHz	Aug. 29, 2024	Jan. 24, 2025~ Mar. 10, 2025	Aug. 28, 2025	Radiation (03CH16-HY)
SHF-EHF Horn Antenna	SCHWARZBECK	BBHA9170	1224	18GHz~40GHz	Oct. 25, 2024	Jan. 24, 2025~ Mar. 10, 2025	Oct. 24, 2025	Radiation (03CH16-HY)
EMI Test Receiver	Keysight	N9038A(MXE)	MY57290111	3Hz~26.5GHz	Nov. 22, 2024	Jan. 24, 2025~ Mar. 10, 2025	Nov. 21, 2025	Radiation (03CH16-HY)
Bilog Antenna	TESEQ	CBL 6111D & 00802N1D01N-06	47020 & 06	30MHz to 1GHz	Oct. 05, 2024	Jan. 24, 2025~ Mar. 10, 2025	Oct. 04, 2025	Radiation (03CH16-HY)
Horn Antenna	SCHWARZBECK	BBHA 9120 D	9120D-1522	1G~18GHz	Mar. 28, 2024	Jan. 24, 2025~ Mar. 10, 2025	Mar. 27, 2025	Radiation (03CH16-HY)
Amplifier	SONOMA	310N	371607	9kHz~1GHz	Jul. 02, 2024	Jan. 24, 2025~ Mar. 10, 2025	Jul. 01, 2025	Radiation (03CH16-HY)
Preamplifier	Keysight	83017A	MY53270264	1GHz~26.5GHz	Dec. 05, 2024	Jan. 24, 2025~ Mar. 10, 2025	Dec. 04, 2025	Radiation (03CH16-HY)
Preamplifier	EMEC	EM1G18G	060812	1GHz~18GHz	Dec. 24, 2024	Jan. 24, 2025~ Mar. 10, 2025	Dec. 23, 2025	Radiation (03CH16-HY)
Preamplifier	EMEC	EM18G40G	060801	18GHz~40GHz	May 27, 2024	Jan. 24, 2025~ Mar. 10, 2025	May 26, 2025	Radiation (03CH16-HY)
Filter	Wainwright	WLK4-1000-153 0-8000-40SS	SN17	1.53GHz Low Pass Filter	Jan. 14, 2025	Jan. 24, 2025~ Mar. 10, 2025	Jan. 13, 2026	Radiation (03CH16-HY)
Filter	Wainwright	WHKX12-2700- 3000-18000-60 ST	SN3	3GHz High Pass Filter	Jun. 28, 2024	Jan. 24, 2025~ Mar. 10, 2025	Jun. 27, 2025	Radiation (03CH16-HY)
Notch Filter	ST1	STI15_9935_51 50-5850	NA	N/A	Apr. 05, 2024	Jan. 24, 2025~ Mar. 10, 2025	Apr. 04, 2025	Radiation (03CH16-HY)
Notch Filter	Wainwright	WRCQV14-542 5-5825-6525-69 25-60SS	SN1	N/A	Jan. 03, 2025	Jan. 24, 2025~ Mar. 10, 2025	Jan. 02, 2026	Radiation (03CH16-HY)
Filter	Wainwright	WHKX6-7268-9 200-26500-40C D	SN2	9GHz High Pass Filter	May 22, 2024	Jan. 24, 2025~ Mar. 10, 2025	May 21, 2025	Radiation (03CH16-HY)
RF Cable	HUBER + SUHNER	SUCOFLEX 102	801606/2	9KHz ~ 40GHz	Apr. 22, 2024	Jan. 24, 2025~ Mar. 10, 2025	Apr. 21, 2025	Radiation (03CH16-HY)
RF Cable	HUBER + SUHNER	SUCOFLEX 102/SUCOFLEX X 104	EC-A5-300-5757, 805935/4,802434/ 4	30MHz~18GHz	Aug. 07, 2024	Jan. 24, 2025~ Mar. 10, 2025	Aug. 06, 2025	Radiation (03CH16-HY)
RF Cable	HUBER + SUHNER	SUCOFLEX 102	804011/2,804012/ 2	18-40GHz	Dec. 31, 2024	Jan. 24, 2025~ Mar. 10, 2025	Dec. 30, 2025	Radiation (03CH16-HY)
Software	Audix	E3 230621 V9	RK-002393	N/A	N/A	Jan. 24, 2025~ Mar. 10, 2025	N/A	Radiation (03CH16-HY)
Controller	ChainTek	3000-1	N/A	Control Turn table & Ant Mast	N/A	Jan. 24, 2025~ Mar. 10, 2025	N/A	Radiation (03CH16-HY)
Antenna Mast	ChainTek	MBS-520-1	N/A	1m~4m	N/A	Jan. 24, 2025~ Mar. 10, 2025	N/A	Radiation (03CH16-HY)
Turn Table	ChainTek	T-200-S-1	N/A	0~360 Degree	N/A	Jan. 24, 2025~ Mar. 10, 2025	N/A	Radiation (03CH16-HY)



Instrument	Brand Name	Model No.	Serial No.	Characteristics	Calibration Date	Test Date	Due Date	Remark
Hygrometer	TECEPEL	DTM-303A	TP201996	N/A	Nov. 01, 2024	Feb. 18, 2025~ Mar. 03, 2025	Oct. 31, 2025	Conducted (TH05-HY)
USB Power Sensor	DARE	RPR3008W	RPR8W-2301001 3 (NO:100)	10MHz~8GHz	Jul. 26, 2024	Feb. 18, 2025~ Mar. 03, 2025	Jul. 25, 2025	Conducted (TH05-HY)
Signal Analyzer	Rohde & Schwarz	FSV3044	101467	10Hz~44GHz	Jan. 14, 2025	Feb. 18, 2025~ Mar. 03, 2025	Jan. 13, 2026	Conducted (TH05-HY)
Switch Control Mainframe	Burgeon	ETF-058	EC1300484 (BOX3)	N/A	May 20, 2024	Feb. 18, 2025~ Mar. 03, 2025	May 19, 2025	Conducted (TH05-HY)
Software	Sporton	BTWiFi_Final_v ersion_240513	N/A	Conducted Other Test Item	N/A	Feb. 18, 2025~ Mar. 03, 2025	N/A	Conducted (TH05-HY)
AC Power Source	ACPOWER	AFC-11003G	F317040033	N/A	N/A	Mar. 19, 2025~ Mar. 21, 2025	N/A	Conduction (CO07-HY)
Software	Rohde & Schwarz	EMC32 V10.30	N/A	N/A	N/A	Mar. 19, 2025~ Mar. 21, 2025	N/A	Conduction (CO07-HY)
Pulse Limiter	SCHWARZBE CK	VTSD 9561-F N	9561-F N00373	9kHz-200MHz	Oct. 23, 2024	Mar. 19, 2025~ Mar. 21, 2025	Oct. 22, 2025	Conduction (CO07-HY)
RF Cable	HUBER + SUHNER	RG 214/U	1358175	9kHz~30MHz	Mar. 03, 2025	Mar. 19, 2025~ Mar. 21, 2025	Mar. 02, 2026	Conduction (CO07-HY)
Lisn	Rohde & Schwarz	ENV216	100080	9kHz~30MHz	Dec. 12, 2024	Mar. 19, 2025~ Mar. 21, 2025	Dec. 11, 2025	Conduction (CO07-HY)
EMI Test Receiver	Rohde & Schwarz	ESR3	102317	9kHz~3.6GHz	Sep. 23, 2024	Mar. 19, 2025~ Mar. 21, 2025	Sep. 22, 2025	Conduction (CO07-HY)
Spectrum Analyzer	Rohde & Schwarz	FSV3013	101550	10Hz~13.6GHz	Jan. 13, 2025	Apr. 02, 2025	Jan. 12, 2026	APC (DF02-HY)
Coupler	MVE	MVE4816	A800044	0.5-18GHz	Calibration from System	Apr. 02, 2025	Calibration from System	APC (DF02-HY)
Power Divider	MTJ	SMA 2Way Power Divider	MD10003	0.5GHz-6GHz	Calibration from System	Apr. 02, 2025	Calibration from System	APC (DF02-HY)
Power Divider	MTJ	SMA 2Way Power Divider	MD10007	0.5GHz-6GHz	Calibration from System	Apr. 02, 2025	Calibration from System	APC (DF02-HY)
Power Divider	MTJ	SMA 2Way Power Divider	MD10011	0.5GHz-6GHz	Calibration from System	Apr. 02, 2025	Calibration from System	APC (DF02-HY)
RF Cable	EM	SFL402	30cm-#6	30 kHz~18GHz	Calibration from System	Apr. 02, 2025	Calibration from System	APC (DF02-HY)
RF Cable	MTJ	SBF405	30cm-01	30 kHz~18GHz	Calibration from System	Apr. 02, 2025	Calibration from System	APC (DF02-HY)
RF Cable	MTJ	SBF405	30cm-09	30 kHz~18GHz	Calibration from System	Apr. 02, 2025	Calibration from System	APC (DF02-HY)
RF Cable	EC	SS405	100cm-01	30 kHz~18GHz	Calibration from System	Apr. 02, 2025	Calibration from System	APC (DF02-HY)
RF Cable	EC	SS405	100cm-03	30 kHz~18GHz	Calibration from System	Apr. 02, 2025	Calibration from System	APC (DF02-HY)
RF Cable	EC	SS405	100cm-05	30 kHz~18GHz	Calibration from System	Apr. 02, 2025	Calibration from System	APC (DF02-HY)
RF Cable	EC	SS405	100cm-10	30 kHz~18GHz	Calibration from System	Apr. 02, 2025	Calibration from System	APC (DF02-HY)
RF Cable	EC	SS405	100cm-11	30 kHz~18GHz	Calibration from System	Apr. 02, 2025	Calibration from System	APC (DF02-HY)
RF Cable	EC	SS405	150cm-#11	30 kHz~18GHz	Calibration from System	Apr. 02, 2025	Calibration from System	APC (DF02-HY)
RF Cable	EC	SS405	150cm-#15	30 kHz~18GHz	Calibration from System	Apr. 02, 2025	Calibration from System	APC (DF02-HY)



## 5 Measurement Uncertainty

### Uncertainty of Conducted Emission Measurement (150 kHz ~ 30 MHz)

Measuring Uncertainty for a Level of Confidence of 95% ( $U = 2Uc(y)$ )	3.7 dB
---	--------

### Uncertainty of Radiated Emission Measurement (30 MHz ~ 1000 MHz)

Measuring Uncertainty for a Level of Confidence of 95% ( $U = 2Uc(y)$ )	6.5 dB
---	--------

### Uncertainty of Radiated Emission Measurement (1000 MHz ~ 6000 MHz)

Measuring Uncertainty for a Level of Confidence of 95% ( $U = 2Uc(y)$ )	4.9 dB
---	--------

### Uncertainty of Radiated Emission Measurement (6000 MHz ~ 18000 MHz)

Measuring Uncertainty for a Level of Confidence of 95% ( $U = 2Uc(y)$ )	5.1 dB
---	--------

### Uncertainty of Radiated Emission Measurement (18000 MHz ~ 40000 MHz)

Measuring Uncertainty for a Level of Confidence of 95% ( $U = 2Uc(y)$ )	5.3 dB
---	--------



### Appendix A. Test Result of Conducted Test Items

Test Engineer:	Howard Tsai and Mina Liu	Temperature:	21~25	°C
Test Date:	2025/02/18~2025/03/03	Relative Humidity:	51~54	%

#### Test Result

#### 26dB and 99% OBW

U-NII-5 MIMO (CDD)										
Mod.	Data Rate	NTX	CH.	Freq. (MHz)	99% Bandwidth (MHz)		26dB Bandwidth (MHz)		Emission Bandwidth Limit (MHz)	Pass /Fail
					Ant3	Ant4	Ant3	Ant4		
					11a	6M	2	1		
11a	6M	2	49	6195	19.49	18.36	32.21	30.02	320	Pass
11a	6M	2	93	6415	21.99	19.39	34.69	33.08	320	Pass



**Average Output Power**

U-NII-5 MIMO (CDD)													
Mod.	Data Rate	NTX	CH.	Freq. (MHz)	Conducted Power (dBm)			DG (dBi)		E.I.R.P Power (dBm)		EIRP Power Limit (dBm)	Pass /Fail
					Ant3	Ant4	SUM	Ant3	Ant4	Ant3	Ant4		
11a	6M	2Tx	1	5955	19.19	20.65	22.99	-5.48		17.51		30	Pass
11a	6M	2Tx	49	6195	19.12	20.21	22.71	-5.48		17.23		30	Pass
11a	6M	2Tx	93	6415	19.21	20.36	22.83	-5.48		17.35		30	Pass



**EIRP Power Spectral Density**

U-NII-5 MIMO (CDD)														
Mod.	Data Rate	NTX	CH.	Freq. (MHz)	Duty Factor (dB)		Conducted Power Density with Duty Factor (dBm/MHz)			DG (dBi)		EIRP Power Density (dBm/MHz)	EIRP Power Density Limit (dBm/MHz)	Pass /Fail
					Ant3	Ant4	Ant3	Ant4	SUM	Ant3	Ant4	SUM		
11a	6M	2	1	5955	0.02	0.02			12.26	-3.33		8.93	17	Pass
11a	6M	2	49	6195	0.02	0.02			11.61	-3.33		8.28	17	Pass
11a	6M	2	93	6415	0.02	0.02			11.88	-3.33		8.55	17	Pass





**26dB and 99% OBW**

U-NII-7 MIMO (CDD)										
Mod.	Data Rate	NTX	CH.	Freq. (MHz)	99% Bandwidth (MHz)		26dB Bandwidth (MHz)		Emission Bandwidth Limit (MHz)	Pass Fail
					Ant3	Ant4	Ant3	Ant4		
					11a	6M	2	117		
11a	6M	2	149	6695	23.85	20.46	36.95	34.35	320	Pass
11a	6M	2	181	6855	23.85	22.81	36.88	36.88	320	Pass



**Average Output Power**

U-NII-7 MIMO (CDD)													
Mod.	Data Rate	NTX	CH.	Freq. (MHz)	Conducted Power (dBm)			DG (dBi)		E.I.R.P Power (dBm)		EIRP Power Limit (dBm)	Pass /Fail
					Ant3	Ant4	SUM	Ant3	Ant4	Ant3	Ant4		
11a	6M	2Tx	117	6535	19.38	20.78	23.15	-3.85		19.3		30	Pass
11a	6M	2Tx	149	6695	19.14	20.20	22.71	-3.85		18.86		30	Pass
11a	6M	2Tx	181	6855	19.07	20.56	22.89	-3.85		19.04		30	Pass



**EIRP Power Spectral Density**

U-NII-7 MIMO (CDD)														
Mod.	Data Rate	NTX	CH.	Freq. (MHz)	Duty Factor (dB)		Conducted Power Density with Duty Factor (dBm/MHz)			DG (dBi)		EIRP Power Density (dBm/MHz)	EIRP Power Density Limit (dBm/MHz)	Pass /Fail
					Ant3	Ant4	Ant3	Ant4	SUM	Ant3	Ant4	SUM		
11a	6M	2	117	6535	0.02	0.02			12.33	-1.62		10.71	17	Pass
11a	6M	2	149	6695	0.02	0.02			11.67	-1.62		10.05	17	Pass
11a	6M	2	181	6855	0.02	0.02			11.55	-1.62		9.93	17	Pass



**Average Output Power**

U-NII-5 MIMO (CDD)														
Mod.	Data Rate	NTX	CH.	Freq. (MHz)	RU Config.	Conducted Power (dBm)			DG (dBi)		E.I.R.P Power (dBm)		EIRP Power Limit (dBm)	Pass /Fail
						Ant3	Ant4	SUM	Ant3	Ant4	Ant3	Ant4		
11ax20	MCS0	2Tx	1	5955	Full/RU	19.21	20.11	22.69	-5.48		17.21		30	Pass
11ax20	MCS0	2Tx	49	6195	Full/RU	19.34	19.84	22.61	-5.48		17.13		30	Pass
11ax20	MCS0	2Tx	93	6415	Full/RU	19.18	20.31	22.79	-5.48		17.31		30	Pass
11ax40	MCS0	2Tx	3	5965	Full/RU	17.59	19.01	21.37	-5.48		15.89		30	Pass
11ax40	MCS0	2Tx	51	6205	Full/RU	18.36	19.61	22.04	-5.48		16.56		30	Pass
11ax40	MCS0	2Tx	91	6405	Full/RU	18.08	19.54	21.88	-5.48		16.4		30	Pass
11ax80	MCS0	2Tx	7	5985	Full/RU	17.12	18.76	21.03	-5.48		15.55		30	Pass
11ax80	MCS0	2Tx	55	6225	Full/RU	18.02	19.44	21.80	-5.48		16.32		30	Pass
11ax80	MCS0	2Tx	87	6385	Full/RU	18.20	19.52	21.92	-5.48		16.44		30	Pass
11ax160	MCS0	2Tx	15	6025	Full/RU	16.00	17.83	20.02	-5.48		14.54		30	Pass
11ax160	MCS0	2Tx	47	6185	Full/RU	18.25	19.91	22.17	-5.48		16.69		30	Pass
11ax160	MCS0	2Tx	79	6345	Full/RU	18.01	19.42	21.78	-5.48		16.3		30	Pass



**Average Output Power**

U-NII-7 MIMO (CDD)														
Mod.	Data Rate	NTX	CH.	Freq. (MHz)	RU Config.	Conducted Power (dBm)			DG (dBi)		E.I.R.P Power (dBm)		EIRP Power Limit (dBm)	Pass /Fail
						Ant3	Ant4	SUM	Ant3	Ant4	Ant3	Ant4		
11ax20	MCS0	2Tx	117	6535	Full/RU	19.36	20.55	23.01	-3.85		19.16		30	Pass
11ax20	MCS0	2Tx	149	6695	Full/RU	19.08	20.11	22.64	-3.85		18.79		30	Pass
11ax20	MCS0	2Tx	181	6855	Full/RU	19.06	20.49	22.84	-3.85		18.99		30	Pass
11ax40	MCS0	2Tx	123	6565	Full/RU	18.05	19.56	21.88	-3.85		18.03		30	Pass
11ax40	MCS0	2Tx	147	6685	Full/RU	18.18	19.34	21.81	-3.85		17.96		30	Pass
11ax40	MCS0	2Tx	179	6845	Full/RU	18.02	19.63	21.91	-3.85		18.06		30	Pass
11ax80	MCS0	2Tx	135	6625	Full/RU	18.19	19.37	21.83	-3.85		17.98		30	Pass
11ax80	MCS0	2Tx	151	6705	Full/RU	18.05	19.49	21.84	-3.85		17.99		30	Pass
11ax80	MCS0	2Tx	167	6785	Full/RU	18.14	19.78	22.05	-3.85		18.2		30	Pass
11ax160	MCS0	2Tx	143	6665	Full/RU	18.05	19.74	21.99	-3.85		18.14		30	Pass



**26dB and 99% OBW**

U-NII-5 MIMO (CDD)											
Mod.	Data Rate	NTX	CH.	Freq. (MHz)	RU Config.	99% Bandwidth (MHz)		26dB Bandwidth (MHz)		Emission Bandwidth Limit (MHz)	Pass Fail
						Ant3	Ant4	Ant3	Ant4		
						EHT20	MCS0	2	1		
EHT20	MCS0	2	49	6195	Full	19.74	19.54	36.14	34.96	320	Pass
EHT20	MCS0	2	93	6415	Full	21.62	19.93	36.96	37.45	320	Pass
EHT40	MCS0	2	3	5965	Full	38.21	38.14	59.18	54.67	320	Pass
EHT40	MCS0	2	51	6205	Full	38.47	38.36	54.94	65.76	320	Pass
EHT40	MCS0	2	91	6405	Full	39.08	38.49	72.21	61.07	320	Pass
EHT80	MCS0	2	7	5985	Full	77.15	77.13	88.19	86.37	320	Pass
EHT80	MCS0	2	55	6225	Full	77.42	77.34	122.4	102.08	320	Pass
EHT80	MCS0	2	87	6385	Full	77.45	77.23	122.05	122.88	320	Pass
EHT160	MCS0	2	15	6025	Full	157.8	157.51	312.0	304.75	320	Pass
EHT160	MCS0	2	47	6185	Full	158.54	158.08	316.7	316.75	320	Pass
EHT160	MCS0	2	79	6345	Full	158.31	157.76	316.46	315.6	320	Pass



**Average Output Power**

U-NII-5 MIMO (CDD)														
Mod.	Data Rate	NTX	CH.	Freq. (MHz)	RU Config.	Conducted Power (dBm)			DG (dBi)		E.I.R.P Power (dBm)		EIRP Power Limit (dBm)	Pass /Fail
						Ant3	Ant4	SUM	Ant3	Ant4	Ant3	Ant4		
11be20	MCS0	2Tx	1	5955	Full/RU	19.47	20.38	22.96	-5.48		17.48	30	Pass	
11be20	MCS0	2Tx	1	5955	26RU/0	9.91	11.88	14.02	-5.48		8.54	30	Pass	
11be20	MCS0	2Tx	1	5955	52RU/37	12.92	14.91	17.04	-5.48		11.56	30	Pass	
11be20	MCS0	2Tx	1	5955	106RU/53	16.1	18.02	20.18	-5.48		14.7	30	Pass	
11be20	MCS0	2Tx	1	5955	52T+26T/70	14.83	16.95	19.03	-5.48		13.55	30	Pass	
11be20	MCS0	2Tx	1	5955	106T+26T/82	17.08	18.82	21.05	-5.48		15.57	30	Pass	
11be20	MCS0	2Tx	49	6195	Full/RU	19.28	20.26	22.81	-5.48		17.33	30	Pass	
11be20	MCS0	2Tx	49	6195	26RU/4	10.76	12.53	14.74	-5.48		9.26	30	Pass	
11be20	MCS0	2Tx	49	6195	52RU/38	12.86	14.69	16.88	-5.48		11.4	30	Pass	
11be20	MCS0	2Tx	49	6195	106RU/53	16.11	17.91	20.11	-5.48		14.63	30	Pass	
11be20	MCS0	2Tx	49	6195	52T+26T/71	14.75	16.58	18.77	-5.48		13.29	30	Pass	
11be20	MCS0	2Tx	49	6195	106T+26T/83	16.92	18.66	20.89	-5.48		15.41	30	Pass	
11be20	MCS0	2Tx	93	6415	Full/RU	19.07	20.71	22.98	-5.48		17.5	30	Pass	
11be20	MCS0	2Tx	93	6415	26RU/8	9.79	12.03	14.06	-5.48		8.58	30	Pass	
11be20	MCS0	2Tx	93	6415	52RU/40	12.73	15.04	17.05	-5.48		11.57	30	Pass	
11be20	MCS0	2Tx	93	6415	106RU/54	16.2	18.22	20.34	-5.48		14.86	30	Pass	
11be20	MCS0	2Tx	93	6415	52T+26T/72	14.9	17.02	19.1	-5.48		13.62	30	Pass	
11be20	MCS0	2Tx	93	6415	106T+26T/83	17.02	19.18	21.24	-5.48		15.76	30	Pass	
11be40	MCS0	2Tx	3	5965	Full/RU	18.1	19.36	21.79	-5.48		16.31	30	Pass	
11be40	MCS0	2Tx	51	6205	Full/RU	18.10	19.83	22.06	-5.48		16.58	30	Pass	
11be40	MCS0	2Tx	91	6405	Full/RU	18.42	19.91	22.24	-5.48		16.76	30	Pass	
11be80	MCS0	2Tx	7	5985	Full/RU	17.28	18.73	21.08	-5.48		15.6	30	Pass	
11be80	MCS0	2Tx	7	5985	Puncture20 /8	16.55	18.2	20.46	-5.48		14.98	30	Pass	
11be80	MCS0	2Tx	55	6225	Full/RU	18.25	19.81	22.11	-5.48		16.63	30	Pass	
11be80	MCS0	2Tx	55	6225	Puncture20 /2	16.58	18.47	20.64	-5.48		15.16	30	Pass	
11be80	MCS0	2Tx	55	6225	Puncture20 /4	16.21	18.39	20.45	-5.48		14.97	30	Pass	
11be80	MCS0	2Tx	87	6385	Full/RU	18.08	19.87	22.08	-5.48		16.6	30	Pass	
11be80	MCS0	2Tx	87	6385	Puncture20 /1	16.93	19.04	21.12	-5.48		15.64	30	Pass	



U-NII-5 MIMO (CDD)														
Mod.	Data Rate	NTX	CH.	Freq. (MHz)	RU Config.	Conducted Power (dBm)			DG (dBi)		E.I.R.P Power (dBm)		EIRP Power Limit (dBm)	Pass /Fail
						Ant3	Ant4	SUM	Ant3	Ant4	Ant3	Ant4		
11be160	MCS0	2Tx	15	6025	Full/RU	16.17	17.84	20.1	-5.48		14.62		30	Pass
11be160	MCS0	2Tx	15	6025	Puncture20 /128	15.65	17.57	19.73	-5.48		14.25		30	Pass
11be160	MCS0	2Tx	15	6025	Puncture40 /192	15.56	17.16	19.44	-5.48		13.96		30	Pass
11be160	MCS0	2Tx	47	6185	Full/RU	18.19	19.99	22.19	-5.48		16.71		30	Pass
11be160	MCS0	2Tx	47	6185	Puncture20 /16	17.22	19.46	21.49	-5.48		16.01		30	Pass
11be160	MCS0	2Tx	47	6185	Puncture40 /48	16.48	18.5	20.62	-5.48		15.14		30	Pass
11be160	MCS0	2Tx	79	6345	Full/RU	18.12	19.78	22.04	-5.48		16.56		30	Pass
11be160	MCS0	2Tx	79	6345	Puncture20 /1	17.82	19.51	21.76	-5.48		16.28		30	Pass
11be160	MCS0	2Tx	79	6345	Puncture40 /3	16.87	19.23	21.22	-5.48		15.74		30	Pass





**EIRP Power Spectral Density**

U-NII-5 MIMO (CDD)															
Mod.	Data Rate	NTX	CH.	Freq. (MHz)	RU Config.	Duty Factor (dB)		Conducted Power Density with Duty Factor (dBm/MHz)			DG (dBi)		EIRP Power Density (dBm/MHz)	EIRP Power Density Limit (dBm/MHz)	Pass /Fail
						Ant3	Ant4	Ant3	Ant4	SUM	Ant3	Ant4	SUM		
EHT20	MCS0	2	1	5955	Full	0.03	0.03			11.31	-3.33	7.98	17	Pass	
EHT20	MCS0	2	1	5955	26/0	0.03	0.03			11.27	-3.33	7.94	17	Pass	
EHT20	MCS0	2	1	5955	52/37	0.03	0.03			11.2	-3.33	7.87	17	Pass	
EHT20	MCS0	2	1	5955	106/53	0.04	0.04			11.21	-3.33	7.88	17	Pass	
EHT20	MCS0	2	1	5955	52T+26T/70	0.05	0.05			11.3	-3.33	7.97	17	Pass	
EHT20	MCS0	2	1	5955	106T+26T/82	0.08	0.08			11.16	-3.33	7.83	17	Pass	
EHT20	MCS0	2	49	6195	Full	0.03	0.03			11.17	-3.33	7.84	17	Pass	
EHT20	MCS0	2	49	6195	26/4	0.03	0.03			10.93	-3.33	7.6	17	Pass	
EHT20	MCS0	2	49	6195	52/38	0.03	0.03			11.05	-3.33	7.72	17	Pass	
EHT20	MCS0	2	49	6195	106/53	0.04	0.04			11.15	-3.33	7.82	17	Pass	
EHT20	MCS0	2	49	6195	52T+26T/71	0.05	0.05			11.13	-3.33	7.8	17	Pass	
EHT20	MCS0	2	49	6195	106T+26T/83	0.08	0.08			11.01	-3.33	7.68	17	Pass	
EHT20	MCS0	2	93	6415	Full	0.03	0.03			11.49	-3.33	8.16	17	Pass	
EHT20	MCS0	2	93	6415	26/8	0.03	0.03			11.26	-3.33	7.93	17	Pass	
EHT20	MCS0	2	93	6415	52/40	0.03	0.03			11.3	-3.33	7.97	17	Pass	
EHT20	MCS0	2	93	6415	106/54	0.04	0.04			11.45	-3.33	8.12	17	Pass	
EHT20	MCS0	2	93	6415	52T+26T/72	0.05	0.05			11.4	-3.33	8.07	17	Pass	
EHT20	MCS0	2	93	6415	106T+26T/83	0.08	0.08			11.35	-3.33	8.02	17	Pass	
EHT40	MCS0	2	3	5965	Full	0.06	0.06			7.75	-3.33	4.42	17	Pass	
EHT40	MCS0	2	51	6205	Full	0.06	0.06			7.98	-3.33	4.65	17	Pass	
EHT40	MCS0	2	91	6405	Full	0.06	0.06			7.93	-3.33	4.6	17	Pass	
EHT80	MCS0	2	7	5985	Full	0.12	0.12			4.31	-3.33	0.98	17	Pass	
EHT80	MCS0	2	7	5985	Puncture20 /8	0.09	0.09			4.13	-3.33	0.8	17	Pass	
EHT80	MCS0	2	55	6225	Full	0.13	0.12			5.02	-3.33	1.69	17	Pass	
EHT80	MCS0	2	55	6225	Puncture20 /2	0.09	0.09			4.94	-3.33	1.61	17	Pass	
EHT80	MCS0	2	55	6225	Puncture20 /4	0.09	0.09			4.77	-3.33	1.44	17	Pass	



U-NII-5 MIMO (CDD)															
Mod.	Data Rate	NTX	CH.	Freq. (MHz)	RU Config.	Duty Factor (dB)		Conducted Power Density with Duty Factor (dBm/MHz)			DG (dBi)		EIRP Power Density (dBm/MHz)	EIRP Power Density Limit (dBm/MHz)	Pass /Fail
						Ant3	Ant4	Ant3	Ant4	SUM	Ant3	Ant4	SUM		
EHT80	MCS0	2	87	6385	Full	0.12	0.12			4.97	-3.33	1.64	17	Pass	
EHT80	MCS0	2	87	6385	Puncture20 /1	0.09	0.09			4.95	-3.33	1.62	17	Pass	
EHT160	MCS0	2	15	6025	Full	0.22	0.21			0.38	-3.33	-2.95	17	Pass	
EHT160	MCS0	2	15	6025	Puncture20 /128	0.19	0.19			-0.04	-3.33	-3.37	17	Pass	
EHT160	MCS0	2	15	6025	Puncture40 /192	0.18	0.16			0.24	-3.33	-3.09	17	Pass	
EHT160	MCS0	2	47	6185	Full	0.22	0.22			2.22	-3.33	-1.11	17	Pass	
EHT160	MCS0	2	47	6185	Puncture20 /16	0.19	0.19			1.96	-3.33	-1.37	17	Pass	
EHT160	MCS0	2	47	6185	Puncture40 /48	0.18	0.16			2.15	-3.33	-1.18	17	Pass	
EHT160	MCS0	2	79	6345	Full	0.21	0.21			2.16	-3.33	-1.17	17	Pass	
EHT160	MCS0	2	79	6345	Puncture20 /1	0.19	0.19			2.03	-3.33	-1.3	17	Pass	
EHT160	MCS0	2	79	6345	Puncture40 /3	0.18	0.16			2.07	-3.33	-1.26	17	Pass	



**26dB and 99% OBW**

U-NII-7 MIMO (CDD)											
Mod.	Data Rate	NTX	CH.	Freq. (MHz)	RU Config.	99% Bandwidth (MHz)		26dB Bandwidth (MHz)		Emission Bandwidth Limit (MHz)	Pass Fail
						Ant3	Ant4	Ant3	Ant4		
						EHT20	MCS0	2	117		
EHT20	MCS0	2	149	6695	Full	23.24	20.45	42.83	38.5	320	Pass
EHT20	MCS0	2	181	6855	Full	23.3	23.54	40.34	42.65	320	Pass
EHT40	MCS0	2	123	6565	Full	38.66	38.46	65.95	58.48	320	Pass
EHT40	MCS0	2	147	6685	Full	39.21	38.76	78.62	69.01	320	Pass
EHT40	MCS0	2	179	6845	Full	38.68	38.76	61.5	79.38	320	Pass
EHT80	MCS0	2	135	6625	Full	77.35	77.35	121.34	113.31	320	Pass
EHT80	MCS0	2	151	6705	Full	77.7	77.44	151.1	130.82	320	Pass
EHT80	MCS0	2	167	6785	Full	77.46	77.41	102.4	121.15	320	Pass
EHT160	MCS0	2	143	6665	Full	159.01	158.49	318.86	317.95	320	Pass



**Average Output Power**

U-NII-7 MIMO (CDD)														
Mod.	Data Rate	NTX	CH.	Freq. (MHz)	RU Config.	Conducted Power (dBm)			DG (dBi)		E.I.R.P Power (dBm)		EIRP Power Limit (dBm)	Pass /Fail
						Ant3	Ant4	SUM	Ant3	Ant4	Ant3	Ant4		
11be20	MCS0	2Tx	117	6535	Full/RU	19.42	20.86	23.21	-3.85		19.36	30	Pass	
11be20	MCS0	2Tx	117	6535	26RU/0	10.22	11.98	14.2	-3.85		10.35	30	Pass	
11be20	MCS0	2Tx	117	6535	52RU/37	13.27	14.89	17.17	-3.85		13.32	30	Pass	
11be20	MCS0	2Tx	117	6535	106RU/53	16.49	18.48	20.61	-3.85		16.76	30	Pass	
11be20	MCS0	2Tx	117	6535	52T+26T/70	14.72	16.76	18.87	-3.85		15.02	30	Pass	
11be20	MCS0	2Tx	117	6535	106T+26T/82	17.4	19.22	21.41	-3.85		17.56	30	Pass	
11be20	MCS0	2Tx	149	6695	Full/RU	19.23	20.51	22.93	-3.85		19.08	30	Pass	
11be20	MCS0	2Tx	149	6695	26RU/4	10.75	12.79	14.9	-3.85		11.05	30	Pass	
11be20	MCS0	2Tx	149	6695	52RU/38	12.46	14.78	16.78	-3.85		12.93	30	Pass	
11be20	MCS0	2Tx	149	6695	106RU/53	15.77	17.81	19.92	-3.85		16.07	30	Pass	
11be20	MCS0	2Tx	149	6695	52T+26T/71	14.31	16.38	18.48	-3.85		14.63	30	Pass	
11be20	MCS0	2Tx	149	6695	106T+26T/83	16.81	18.68	20.86	-3.85		17.01	30	Pass	
11be20	MCS0	2Tx	181	6855	Full/RU	19.04	20.82	23.03	-3.85		19.18	30	Pass	
11be20	MCS0	2Tx	181	6855	26RU/8	8.49	12.23	13.76	-3.85		9.91	30	Pass	
11be20	MCS0	2Tx	181	6855	52RU/40	11.87	15.34	16.95	-3.85		13.1	30	Pass	
11be20	MCS0	2Tx	181	6855	106RU/54	14.77	18.27	19.87	-3.85		16.02	30	Pass	
11be20	MCS0	2Tx	181	6855	52T+26T/72	13.68	17	18.66	-3.85		14.81	30	Pass	
11be20	MCS0	2Tx	181	6855	106T+26T/83	16.15	19.53	21.17	-3.85		17.32	30	Pass	
11be40	MCS0	2Tx	123	6565	Full/RU	18.23	19.94	22.18	-3.85		18.33	30	Pass	
11be40	MCS0	2Tx	147	6685	Full/RU	18.45	19.88	22.23	-3.85		18.38	30	Pass	
11be40	MCS0	2Tx	179	6845	Full/RU	18.06	19.98	22.14	-3.85		18.29	30	Pass	
11be80	MCS0	2Tx	135	6625	Full/RU	18.04	19.77	22.00	-3.85		18.15	30	Pass	
11be80	MCS0	2Tx	135	6625	Puncture20 /8	16.84	18.9	21	-3.85		17.15	30	Pass	
11be80	MCS0	2Tx	151	6705	Full/RU	18.12	19.86	22.09	-3.85		18.24	30	Pass	
11be80	MCS0	2Tx	151	6705	Puncture20 /2	15.91	18.54	20.43	-3.85		16.58	30	Pass	
11be80	MCS0	2Tx	151	6705	Puncture20 /4	16.05	18.5	20.46	-3.85		16.61	30	Pass	
11be80	MCS0	2Tx	167	6785	Full/RU	18.04	19.89	22.07	-3.85		18.22	30	Pass	
11be80	MCS0	2Tx	167	6785	Puncture20 /1	15.3	19.33	20.78	-3.85		16.93	30	Pass	



U-NII-7 MIMO (CDD)														
Mod.	Data Rate	NTX	CH.	Freq. (MHz)	RU Config.	Conducted Power (dBm)			DG (dBi)		E.I.R.P Power (dBm)		EIRP Power Limit (dBm)	Pass /Fail
						Ant3	Ant4	SUM	Ant3	Ant4	Ant3	Ant4		
11be160	MCS0	2Tx	143	6665	Full/RU	18.28	19.91	22.18	-3.85		18.33		30	Pass
11be160	MCS0	2Tx	143	6665	Puncture20 /128	17.83	19.89	21.99	-3.85		18.14		30	Pass
11be160	MCS0	2Tx	143	6665	Puncture40 /192	17.25	19.8	21.72	-3.85		17.87		30	Pass



**EIRP Power Spectral Density**

U-NII-7 MIMO (CDD)															
Mod.	Data Rate	NTX	CH.	Freq. (MHz)	RU Config.	Duty Factor (dB)		Conducted Power Density with Duty Factor (dBm/MHz)			DG (dBi)		EIRP Power Density (dBm/MHz)	EIRP Power Density Limit (dBm/MHz)	Pass /Fail
						Ant3	Ant4	Ant3	Ant4	SUM	Ant3	Ant4	SUM		
EHT20	MCS0	2	117	6535	Full	0.03	0.03			11.71	-1.62	10.09	17	Pass	
EHT20	MCS0	2	117	6535	26/0	0.03	0.03			11.32	-1.62	9.7	17	Pass	
EHT20	MCS0	2	117	6535	52/37	0.03	0.03			11.42	-1.62	9.8	17	Pass	
EHT20	MCS0	2	117	6535	106/53	0.04	0.04			11.63	-1.62	10.01	17	Pass	
EHT20	MCS0	2	117	6535	52T+26T/70	0.05	0.05			11.33	-1.62	9.71	17	Pass	
EHT20	MCS0	2	117	6535	106T+26T/82	0.08	0.08			11.48	-1.62	9.86	17	Pass	
EHT20	MCS0	2	149	6695	Full	0.02	0.03			11.21	-1.62	9.59	17	Pass	
EHT20	MCS0	2	149	6695	26/4	0.03	0.03			11.02	-1.62	9.4	17	Pass	
EHT20	MCS0	2	149	6695	52/38	0.03	0.03			11.03	-1.62	9.41	17	Pass	
EHT20	MCS0	2	149	6695	106/53	0.04	0.04			11.0	-1.62	9.38	17	Pass	
EHT20	MCS0	2	149	6695	52T+26T/71	0.05	0.05			10.96	-1.62	9.34	17	Pass	
EHT20	MCS0	2	149	6695	106T+26T/83	0.08	0.08			11.1	-1.62	9.48	17	Pass	
EHT20	MCS0	2	181	6855	Full	0.03	0.03			11.24	-1.62	9.62	17	Pass	
EHT20	MCS0	2	181	6855	26/8	0.03	0.03			10.91	-1.62	9.29	17	Pass	
EHT20	MCS0	2	181	6855	52/40	0.03	0.03			11.21	-1.62	9.59	17	Pass	
EHT20	MCS0	2	181	6855	106/54	0.04	0.04			10.99	-1.62	9.37	17	Pass	
EHT20	MCS0	2	181	6855	52T+26T/72	0.05	0.05			10.95	-1.62	9.33	17	Pass	
EHT20	MCS0	2	181	6855	106T+26T/83	0.08	0.08			11.11	-1.62	9.49	17	Pass	
EHT40	MCS0	2	123	6565	Full	0.06	0.06			7.81	-1.62	6.19	17	Pass	
EHT40	MCS0	2	147	6685	Full	0.06	0.06			7.76	-1.62	6.14	17	Pass	
EHT40	MCS0	2	179	6845	Full	0.06	0.06			7.29	-1.62	5.67	17	Pass	
EHT80	MCS0	2	135	6625	Full	0.12	0.12			4.69	-1.62	3.07	17	Pass	
EHT80	MCS0	2	135	6625	Puncture20 /8	0.09	0.09			4.59	-1.62	2.97	17	Pass	
EHT80	MCS0	2	151	6705	Full	0.12	0.12			4.91	-1.62	3.29	17	Pass	
EHT80	MCS0	2	151	6705	Puncture20 /2	0.09	0.09			4.89	-1.62	3.27	17	Pass	
EHT80	MCS0	2	151	6705	Puncture20 /4	0.09	0.09			4.75	-1.62	3.13	17	Pass	



U-NII-7 MIMO (CDD)															
Mod.	Data Rate	NTX	CH.	Freq. (MHz)	RU Config.	Duty Factor (dB)		Conducted Power Density with Duty Factor (dBm/MHz)			DG (dBi)		EIRP Power Density (dBm/MHz)	EIRP Power Density Limit (dBm/MHz)	Pass /Fail
						Ant3	Ant4	Ant3	Ant4	SUM	Ant3	Ant4	SUM		
EHT80	MCS0	2	167	6785	Full	0.12	0.12			4.54	-1.62	2.92	17	Pass	
EHT80	MCS0	2	167	6785	Puncture20 /1	0.09	0.09			4.49	-1.62	2.87	17	Pass	
EHT160	MCS0	2	143	6665	Full	0.22	0.21			2.24	-1.62	0.62	17	Pass	
EHT160	MCS0	2	143	6665	Puncture20 /128	0.19	0.19			2.16	-1.62	0.54	17	Pass	
EHT160	MCS0	2	143	6665	Puncture40 /192	0.18	0.16			2.18	-1.62	0.56	17	Pass	



Test Result of 26dB & 99% Occupied Bandwidth

MIMO <Ant. 3+4>

<802.11a>

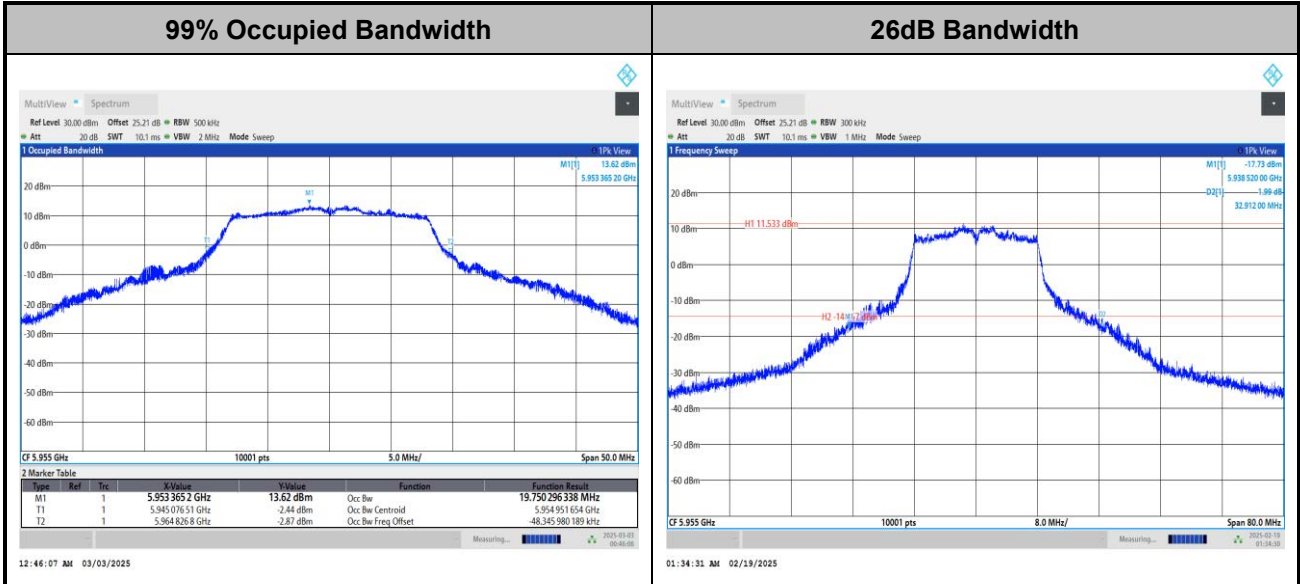

Note: The occupied channel bandwidth is maintained within the band of operation for all of the modulations.

<802.11be EHT20>

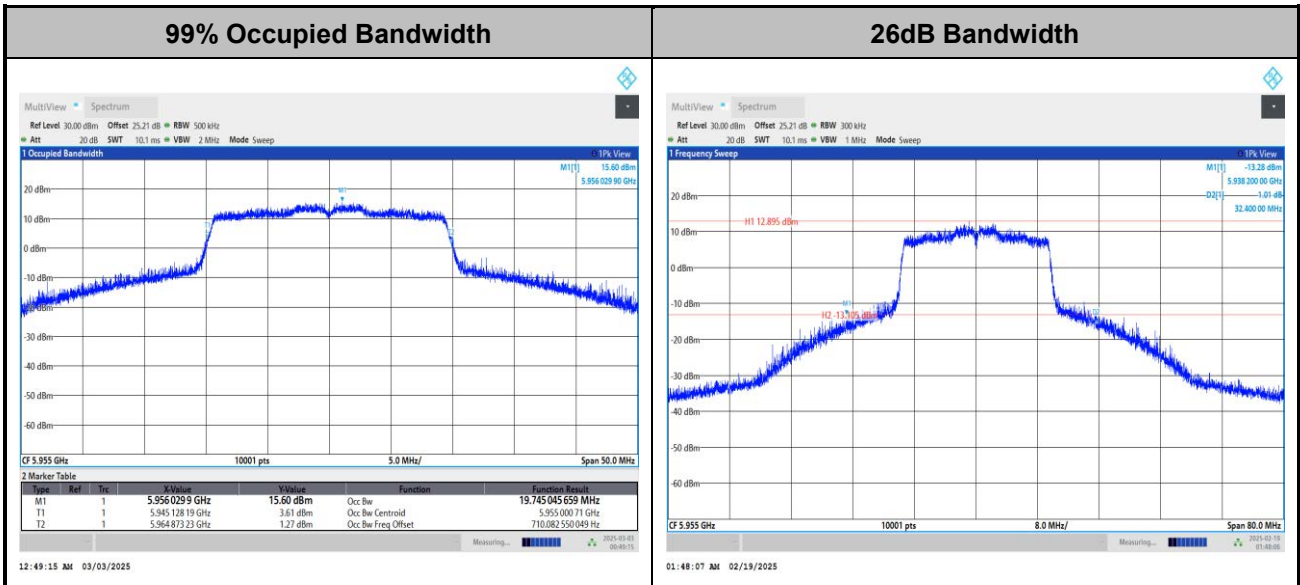

Note: The occupied channel bandwidth is maintained within the band of operation for all of the modulations.





<802.11be EHT40>

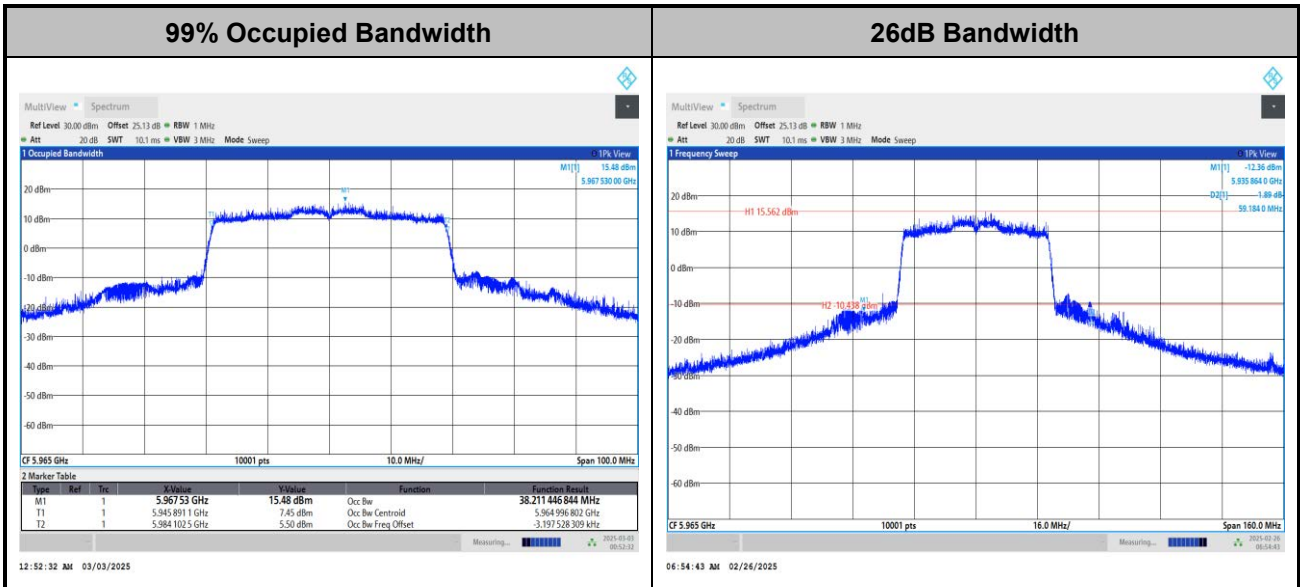

Note: The occupied channel bandwidth is maintained within the band of operation for all of the modulations.

<802.11be EHT80>

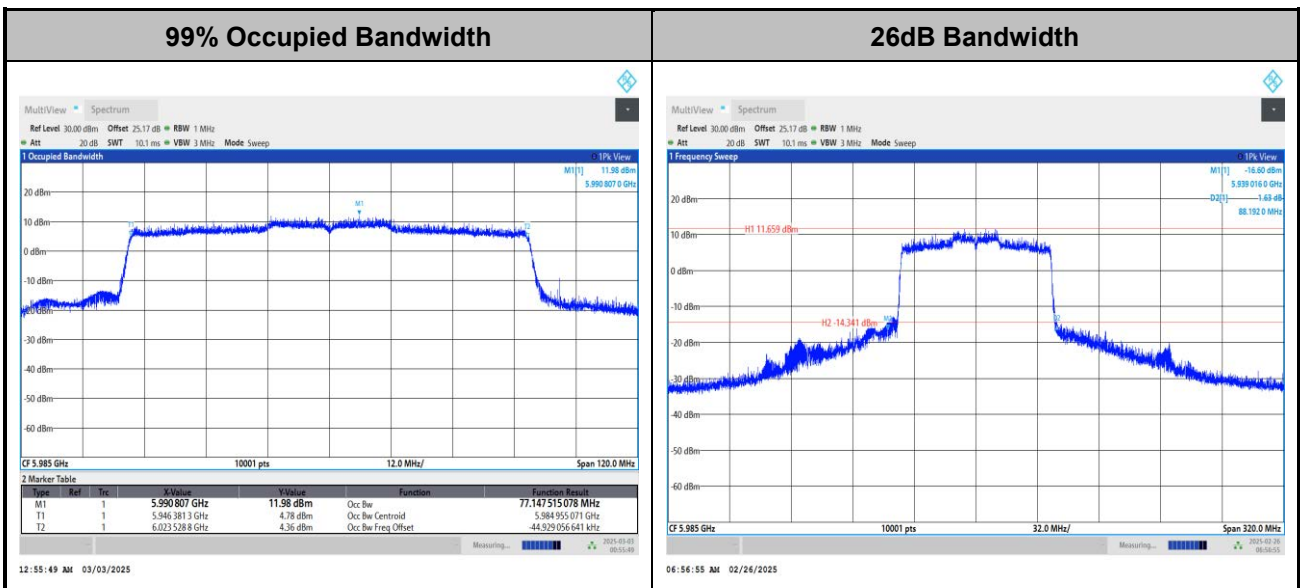

Note: The occupied channel bandwidth is maintained within the band of operation for all of the modulations.



<802.11be EHT160>

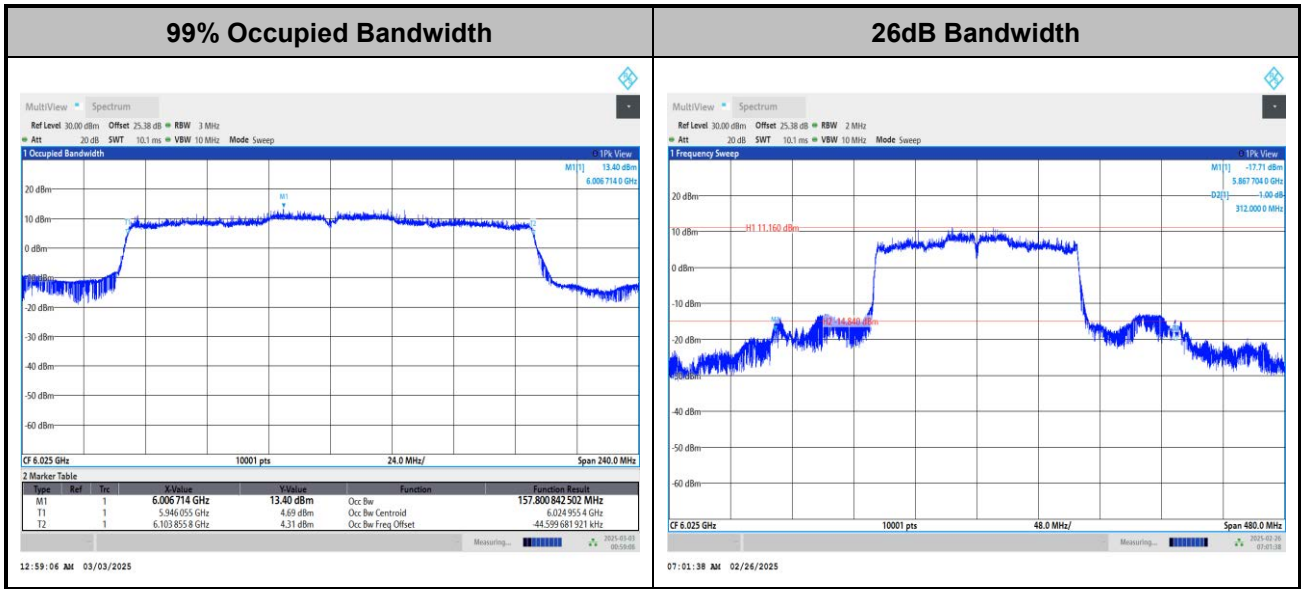

Note: The occupied channel bandwidth is maintained within the band of operation for all of the modulations.



Test Result of Power Spectral Density

<802.11a>

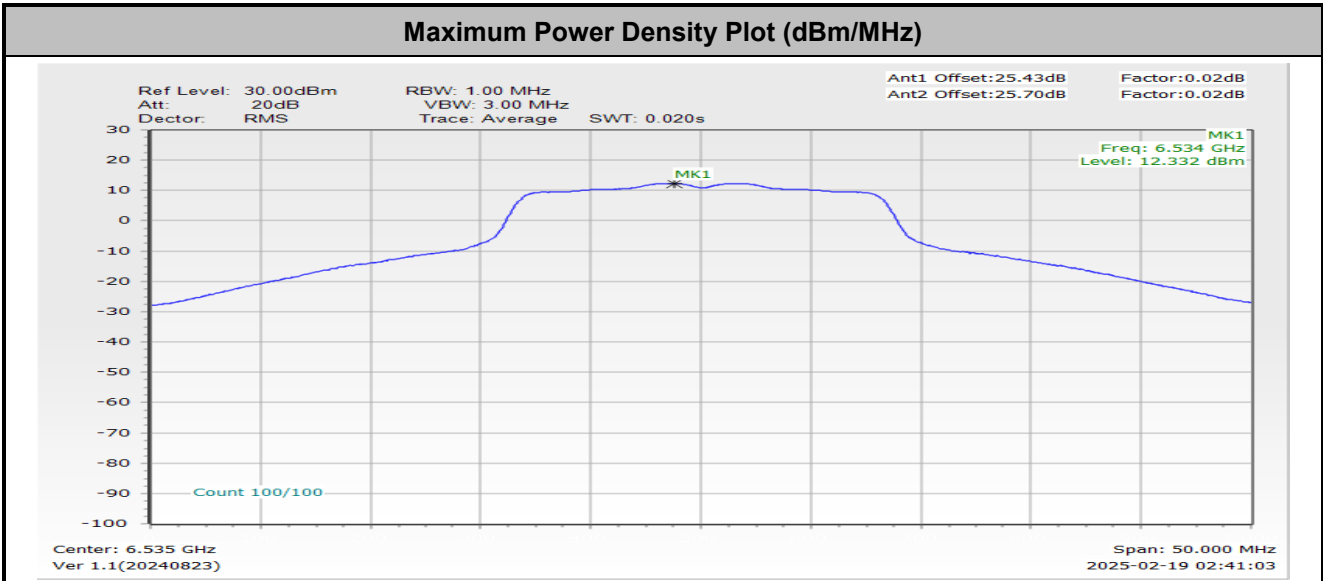

Note:

1. EIRP Power Density (dBm/MHz) = Measured value+ Duty Factor + Directional Gain
2. The test plot is showing a bin by bin combined result mathematically adds two traces.

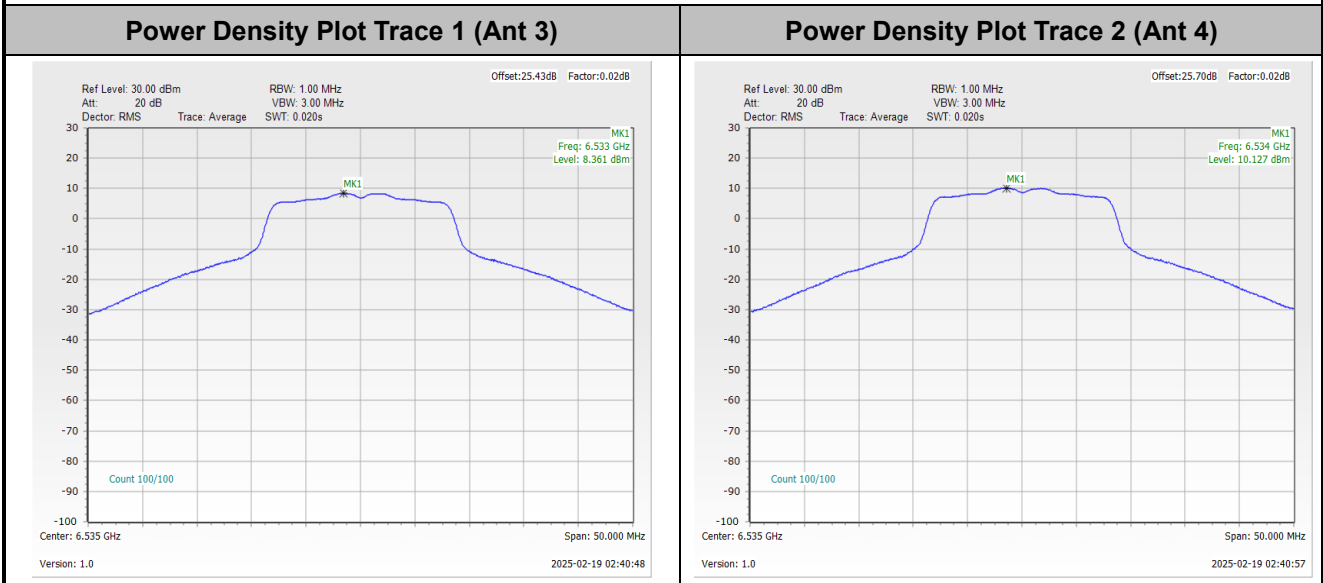



<802.11be EHT20>

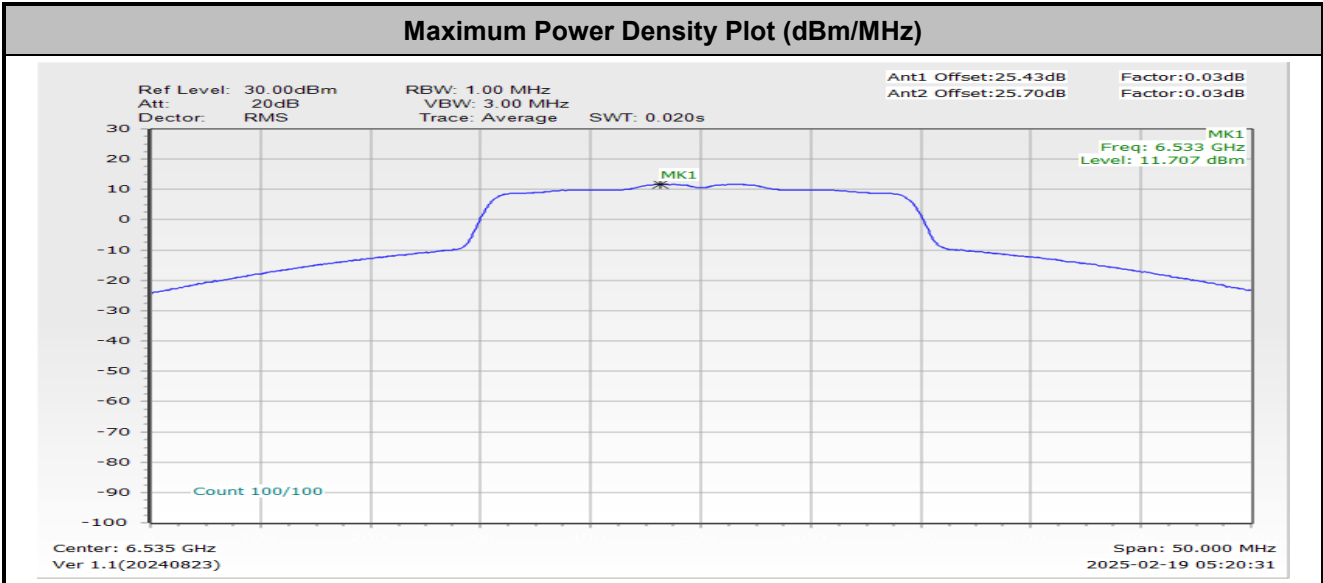

Note:

1. EIRP Power Density (dBm/MHz) = Measured value+ Duty Factor + Directional Gain
2. The test plot is showing a bin by bin combined result mathematically adds two traces.

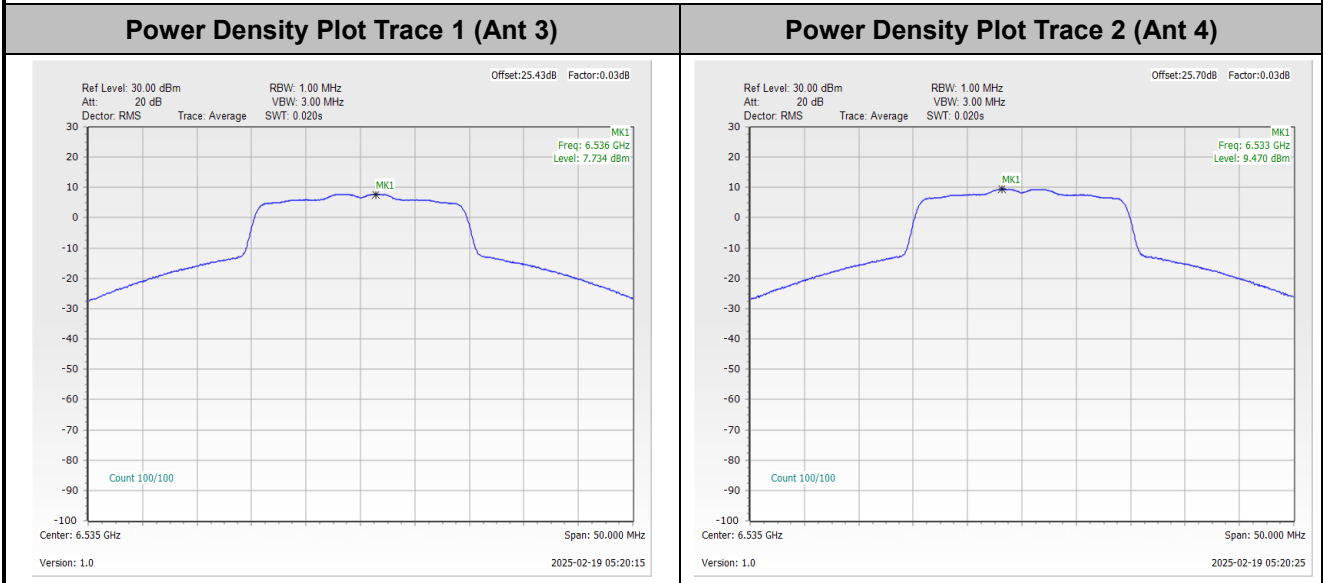



<802.11be EHT40>

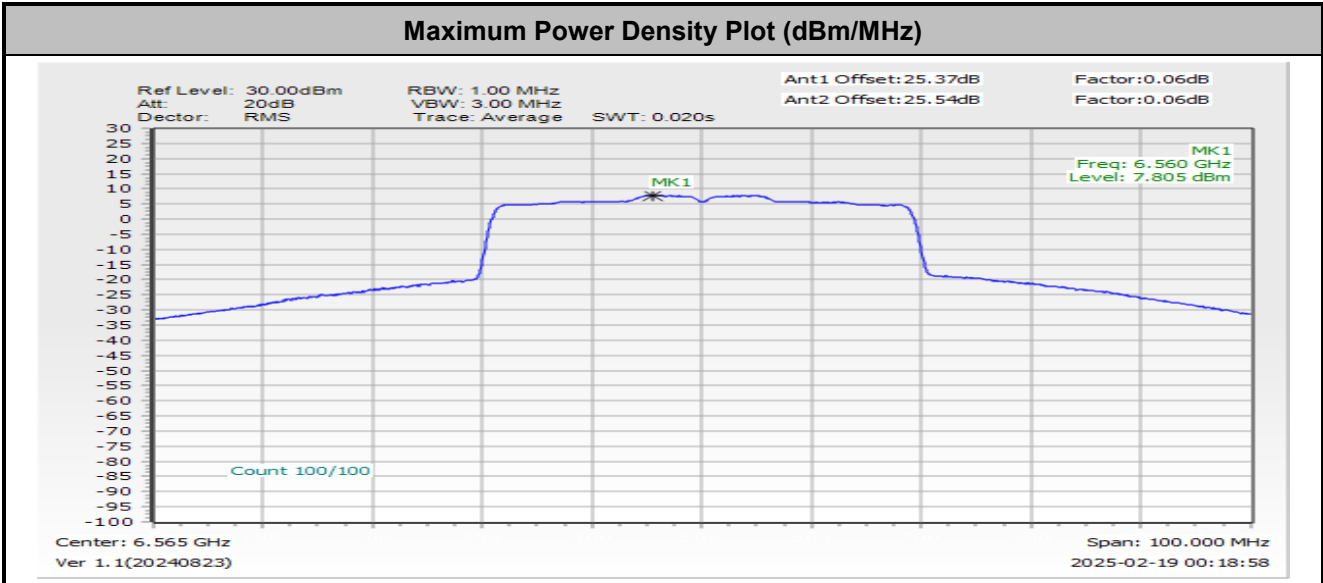

Note:

1. EIRP Power Density (dBm/MHz) = Measured value+ Duty Factor + Directional Gain
2. The test plot is showing a bin by bin combined result mathematically adds two traces.

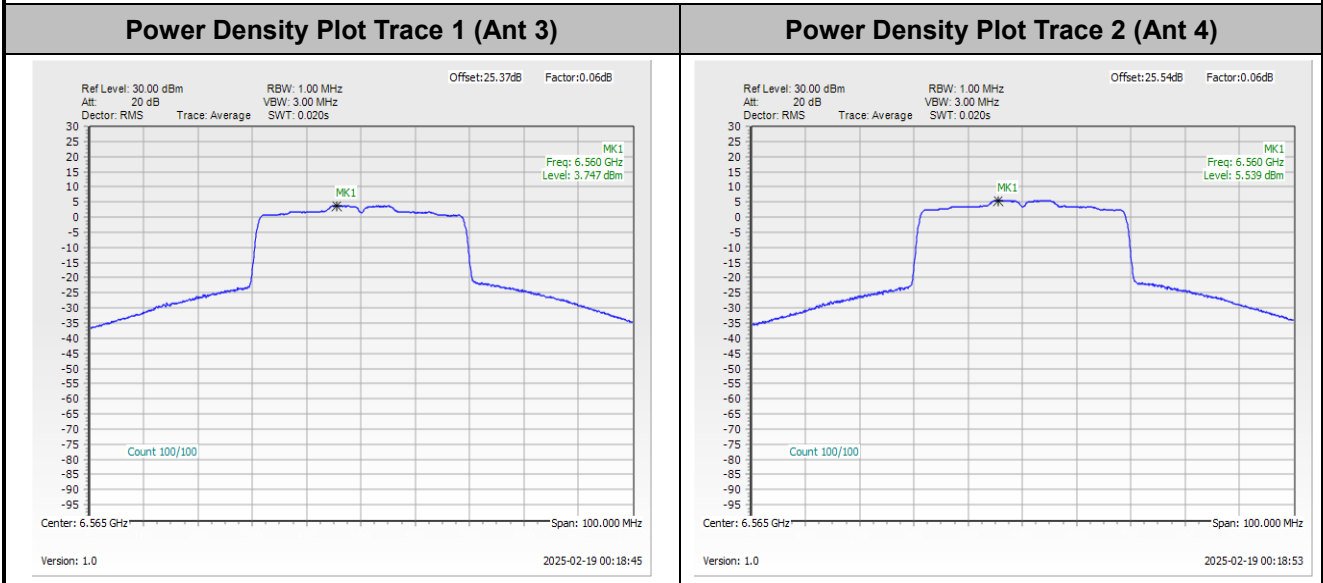



<802.11be EHT80>

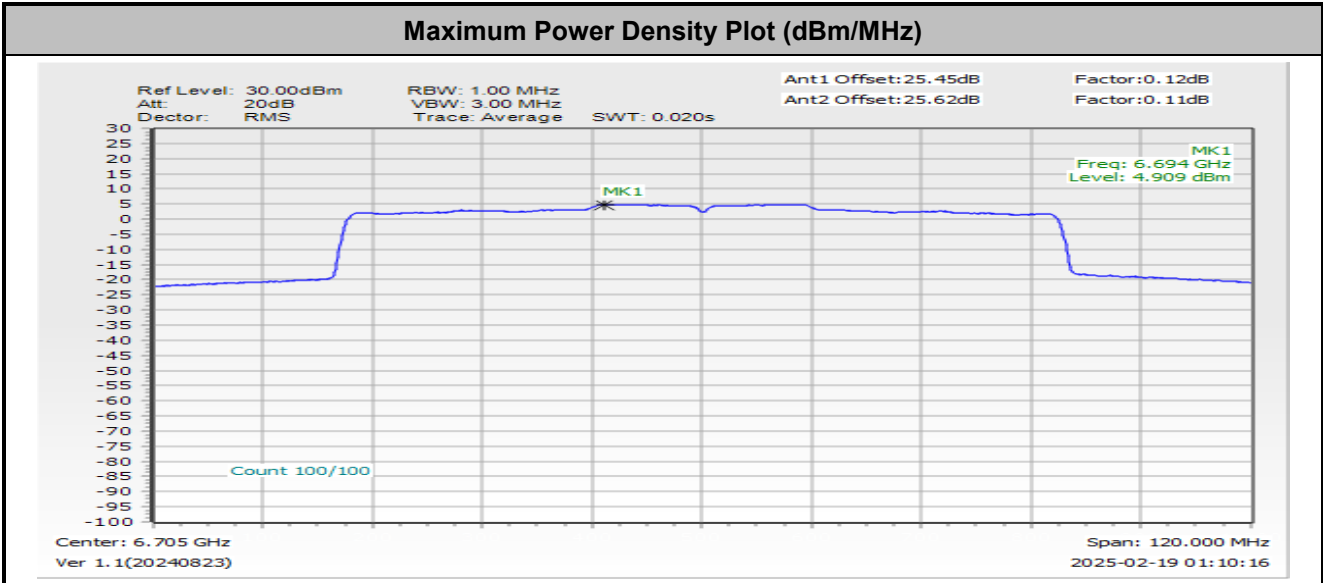

Note:

1. EIRP Power Density (dBm/MHz) = Measured value+ Duty Factor + Directional Gain
2. The test plot is showing a bin by bin combined result mathematically adds two traces.

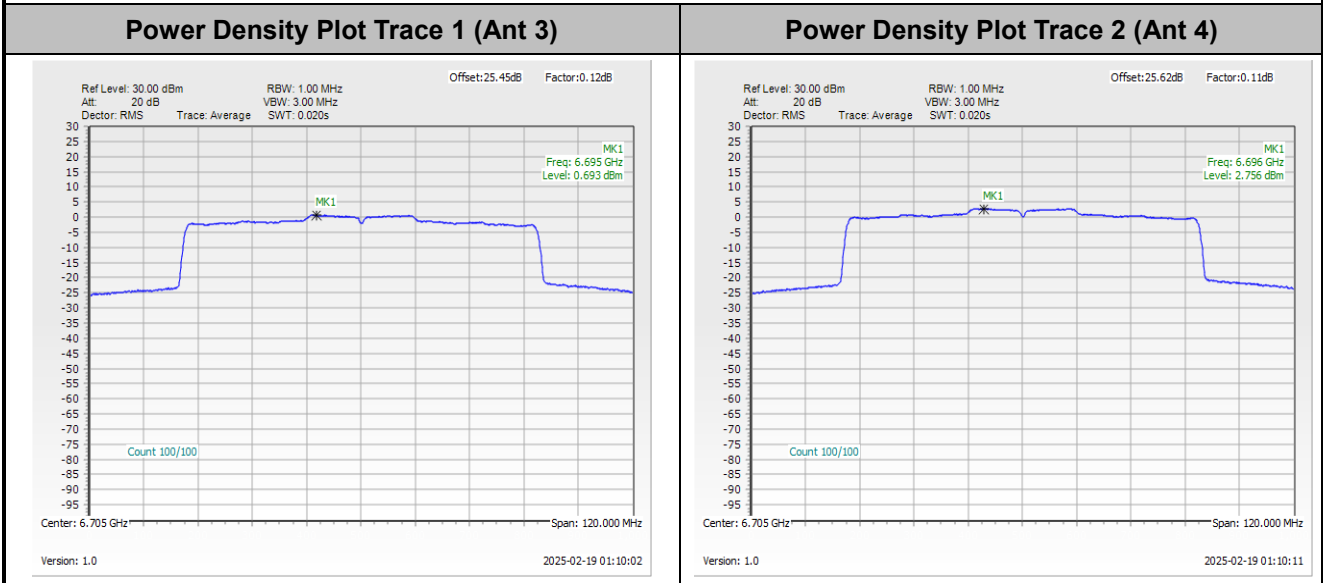



<802.11be EHT160>

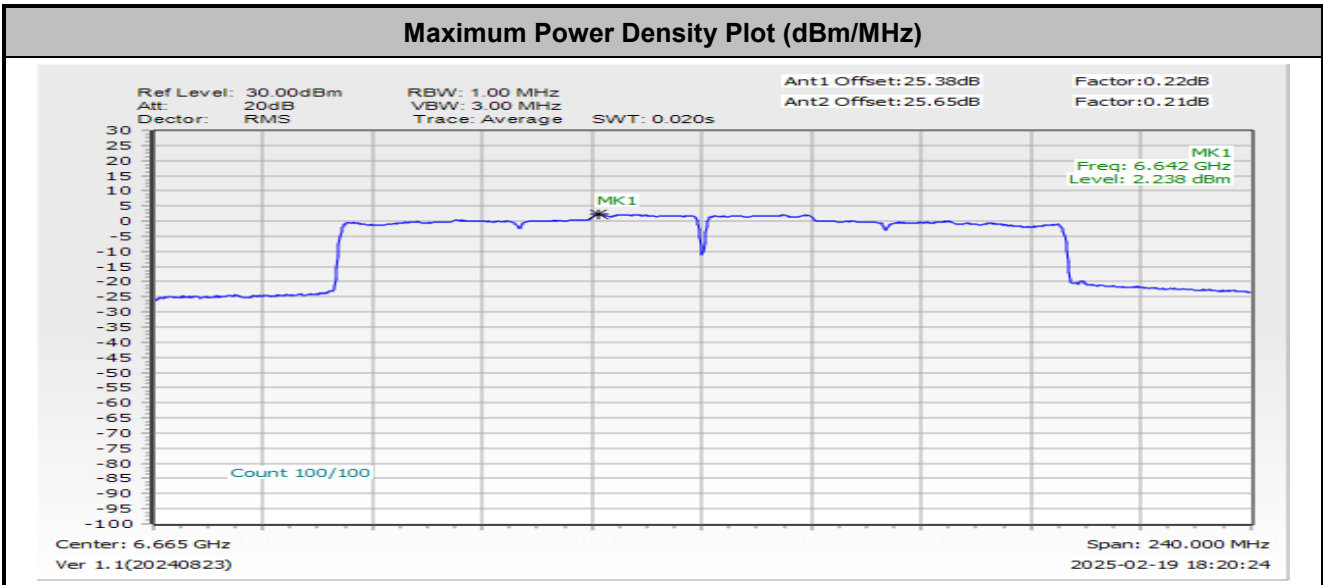

Note:

1. EIRP Power Density (dBm/MHz) = Measured value+ Duty Factor + Directional Gain
2. The test plot is showing a bin by bin combined result mathematically adds two traces.

