



FCC RADIO TEST REPORT

FCC ID : A4RGD1YQ
Equipment : Phone
Model Name : GD1YQ
Applicant : Google LLC
1600 Amphitheatre Parkway,
Mountain View, California, 94043 USA
Standard : FCC Part 15 Subpart C §15.247

The product was received on Apr. 16, 2020 and testing was started from Apr. 28, 2020 and completed on Jul. 04, 2020. We, SPORTON INTERNATIONAL INC., EMC & Wireless Communications Laboratory, would like to declare that the tested sample has been evaluated in accordance with the test procedures and has been in compliance with the applicable technical standards.

The test results in this report apply exclusively to the tested model / sample. Without written approval of SPORTON INTERNATIONAL INC. EMC & Wireless Communications Laboratory, the test report shall not be reproduced except in full.

Louis Wu

Reviewed by: Louis Wu

SPORTON INTERNATIONAL INC. EMC & Wireless Communications Laboratory

No. 52, Huaya 1st Rd., Guishan Dist., Taoyuan City, Taiwan (R.O.C.)



Table of Contents

History of this test report..... 3

Summary of Test Result..... 4

1 General Description..... 5

 1.1 Product Feature of Equipment Under Test..... 5

 1.2 Modification of EUT 5

 1.3 Testing Location 6

 1.4 Applicable Standards..... 6

2 Test Configuration of Equipment Under Test 7

 2.1 Carrier Frequency Channel 7

 2.2 Test Mode..... 8

 2.3 Connection Diagram of Test System..... 9

 2.4 Support Unit used in test configuration and system 10

 2.5 EUT Operation Test Setup 11

 2.6 Measurement Results Explanation Example..... 11

3 Test Result..... 12

 3.1 Number of Channel Measurement 12

 3.2 Hopping Channel Separation Measurement 14

 3.3 Dwell Time Measurement..... 20

 3.4 20dB and 99% Bandwidth Measurement 22

 3.5 Output Power Measurement..... 33

 3.6 Conducted Band Edges Measurement..... 34

 3.7 Conducted Spurious Emission Measurement 41

 3.8 Radiated Band Edges and Spurious Emission Measurement 51

 3.9 AC Conducted Emission Measurement..... 56

 3.10 Antenna Requirements 58

4 List of Measuring Equipment 59

5 Uncertainty of Evaluation..... 61

Appendix A. Conducted Test Results

Appendix B. AC Conducted Emission Test Result

Appendix C. Radiated Spurious Emission

Appendix D. Radiated Spurious Emission Plots

Appendix E. Duty Cycle Plots



History of this test report

Report No.	Version	Description	Issued Date
FR011718-01A	01	Initial issue of report	Jul. 10, 2020



Summary of Test Result

Report Clause	Ref Std. Clause	Test Items	Result (PASS/FAIL)	Remark
3.1	15.247(a)(1)	Number of Channels	Pass	-
3.2	15.247(a)(1)	Hopping Channel Separation	Pass	-
3.3	15.247(a)(1)	Dwell Time of Each Channel	Pass	-
3.4	15.247(a)(1)	20dB Bandwidth	Pass	-
3.4	2.1049	99% Occupied Bandwidth	Reporting only	-
3.5	15.247(b)(1)	Peak Output Power	Pass	-
3.6	15.247(d)	Conducted Band Edges	Pass	-
3.7	15.247(d)	Conducted Spurious Emission	Pass	-
3.8	15.247(d)	Radiated Band Edges and Radiated Spurious Emission	Pass	Under limit 7.62 dB at 39.700 MHz
3.9	15.207	AC Conducted Emission	Pass	Under limit 8.75 dB at 0.204 MHz
3.10	15.203 & 15.247(b)	Antenna Requirement	Pass	-

Declaration of Conformity:

The test results with all measurement uncertainty excluded are presented in accordance with the regulation limits or requirements declared by manufacturers.

Comments and Explanations:

The declared of product specification for EUT presented in the report are provided by the manufacturer, and the manufacturer takes all the responsibilities for the accuracy of product specification.

Reviewed by: Wii Chang

Report Producer: Celery Wei



1 General Description

1.1 Product Feature of Equipment Under Test

Product Feature	
Equipment	Phone
Model Name	GD1YQ
FCC ID	A4RGD1YQ
EUT supports Radios application	CDMA/EV-DO/GSM/EGPRS/WCDMA/HSPA/LTE/5G NR/ NFC/GNSS/WPC/WPT WLAN 11b/g/n HT20 WLAN 11a/n HT20/HT40 WLAN 11ac VHT20/VHT40/VHT80 Bluetooth BR/EDR/LE

Remark: The above EUT's information was declared by manufacturer.

EUT Information List	
S/N	Performed Test Item
06021FDD40012C	Conducted Measurement
03281FDD4000BB	Radiated Spurious Emission
03311FDD40001W	Conducted Emission

1.2 Product Specification of Equipment Under Test

Standards-related Product Specification	
Tx/Rx Frequency Range	2402 MHz ~ 2480 MHz
Number of Channels	79
Carrier Frequency of Each Channel	2402+n*1 MHz; n=0~78
Maximum Output Power to Antenna	Bluetooth BR (1Mbps) : 19.06 dBm (0.0805 W) Bluetooth EDR (2Mbps) : 20.93 dBm (0.1239 W) Bluetooth EDR (3Mbps) : 20.93 dBm (0.1239 W)
99% Occupied Bandwidth	Bluetooth BR (1Mbps) : 0.824 MHz Bluetooth EDR (2Mbps) : 1.168 MHz Bluetooth EDR (3Mbps) : 1.148 MHz
Antenna Type	ILA Antenna type with gain -2.2 dBi
Type of Modulation	Bluetooth BR (1Mbps) : GFSK Bluetooth EDR (2Mbps) : π /4-DQPSK Bluetooth EDR (3Mbps) : 8-DPSK

1.3 Modification of EUT

No modifications are made to the EUT during all test items.



1.4 Testing Location

Test Site	SPORTON INTERNATIONAL INC. EMC & Wireless Communications Laboratory	
Test Site Location	No.52, Huaya 1st Rd., Guishan Dist., Taoyuan City, Taiwan (R.O.C.) TEL: +886-3-327-3456 FAX: +886-3-328-4978	
Test Site No.	Sporton Site No.	
	TH05-HY	CO05-HY

Note: The test site complies with ANSI C63.4 2014 requirement.

Test Site	SPORTON INTERNATIONAL INC. EMC & Wireless Communications Laboratory	
Test Site Location	No.58, Aly. 75, Ln. 564, Wenhua 3rd, Rd., Guishan Dist., Taoyuan City, Taiwan (R.O.C.) TEL: +886-3-327-0868 FAX: +886-3-327-0855	
Test Site No.	Sporton Site No.	
	03CH11-HY	

Note: The test site complies with ANSI C63.4 2014 requirement.

FCC designation No.: TW1190 and TW0007

1.5 Applicable Standards

According to the specifications of the manufacturer, the EUT must comply with the requirements of the following standards:

- ♦ FCC Part 15 Subpart C §15.247
- ♦ FCC KDB Publication No. 558074 D01 DTS Meas. Guidance v05r02
- ♦ FCC KDB 414788 D01 Radiated Test Site v01r01
- ♦ ANSI C63.10-2013

Remark:

1. All test items were verified and recorded according to the standards and without any deviation during the test.
2. The TAF code is not including all the FCC KDB listed without accreditation.



2 Test Configuration of Equipment Under Test

2.1 Carrier Frequency Channel

Frequency Band	Channel	Freq. (MHz)	Channel	Freq. (MHz)	Channel	Freq. (MHz)
2400-2483.5 MHz	0	2402	27	2429	54	2456
	1	2403	28	2430	55	2457
	2	2404	29	2431	56	2458
	3	2405	30	2432	57	2459
	4	2406	31	2433	58	2460
	5	2407	32	2434	59	2461
	6	2408	33	2435	60	2462
	7	2409	34	2436	61	2463
	8	2410	35	2437	62	2464
	9	2411	36	2438	63	2465
	10	2412	37	2439	64	2466
	11	2413	38	2440	65	2467
	12	2414	39	2441	66	2468
	13	2415	40	2442	67	2469
	14	2416	41	2443	68	2470
	15	2417	42	2444	69	2471
	16	2418	43	2445	70	2472
	17	2419	44	2446	71	2473
	18	2420	45	2447	72	2474
	19	2421	46	2448	73	2475
	20	2422	47	2449	74	2476
	21	2423	48	2450	75	2477
	22	2424	49	2451	76	2478
	23	2425	50	2452	77	2479
	24	2426	51	2453	78	2480
	25	2427	52	2454	-	-
	26	2428	53	2455	-	-



2.2 Test Mode

- a. The EUT has been associated with peripherals and configuration operated in a manner tended to maximize its emission characteristics in a typical application. Frequency range investigated: conduction emission (150 kHz to 30 MHz), radiation emission (9 kHz to the 10th harmonic of the highest fundamental frequency or to 40 GHz, whichever is lower). For radiated measurement, pre-scanned in three orthogonal panels, X, Y, Z and Accessory (Adapter or Earphone). The worst cases (Z plane with Adapter) were recorded in this report, and the worst mode of radiated spurious emissions is Bluetooth 3Mbps mode, and recorded in this report.
- b. AC power line Conducted Emission was tested under maximum output power.

The following summary table is showing all test modes to demonstrate in compliance with the standard.

Summary table of Test Cases			
Test Item	Data Rate / Modulation		
	Bluetooth BR 1Mbps GFSK	Bluetooth EDR 2Mbps $\pi/4$ -DQPSK	Bluetooth EDR 3Mbps 8-DPSK
Conducted Test Cases	Mode 1: CH00_2402 MHz Mode 2: CH39_2441 MHz Mode 3: CH78_2480 MHz	Mode 4: CH00_2402 MHz Mode 5: CH39_2441 MHz Mode 6: CH78_2480 MHz	Mode 7: CH00_2402 MHz Mode 8: CH39_2441 MHz Mode 9: CH78_2480 MHz
Radiated Test Cases	Bluetooth EDR 3Mbps 8-DPSK Mode 1: CH00_2402 MHz Mode 2: CH39_2441 MHz Mode 3: CH78_2480 MHz		
AC Conducted Emission	Mode 1 :GSM850 Idle + WLAN (2.4GHz) Link + Bluetooth Link + USB Cable (Charging from Adapter 2)		
Remark: 1. For radiated test cases, the worst mode data rate 3Mbps was reported only since the highest RF output power in the preliminary tests. The conducted spurious emissions and conducted band edge measurement for other data rates were not worse than 3Mbps, and no other significantly frequencies found in conducted spurious emission. 2. For Radiated Test Cases, the tests were performed with Adapter 2.			

2.3 Connection Diagram of Test System

<AC Conducted Emission Mode>

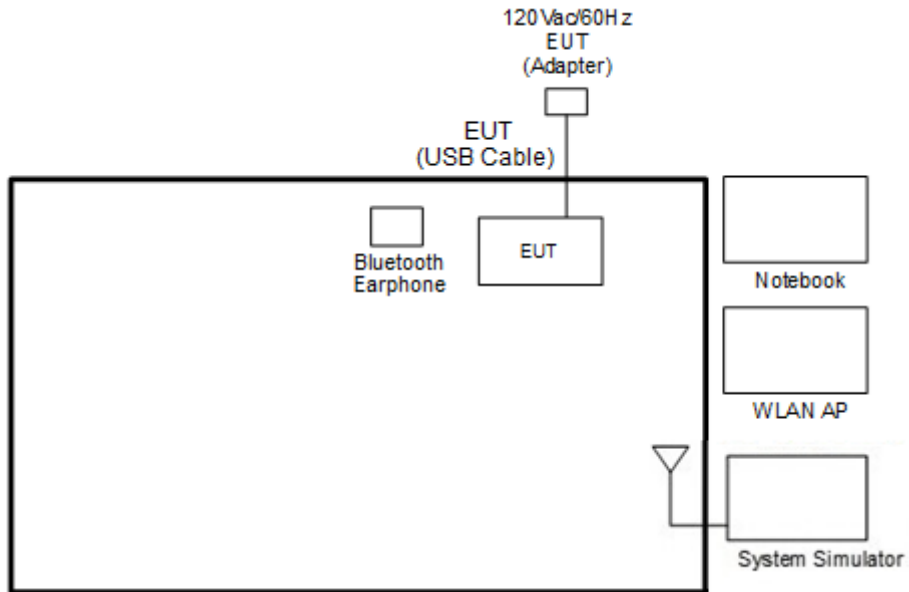

<Bluetooth Tx Mode>

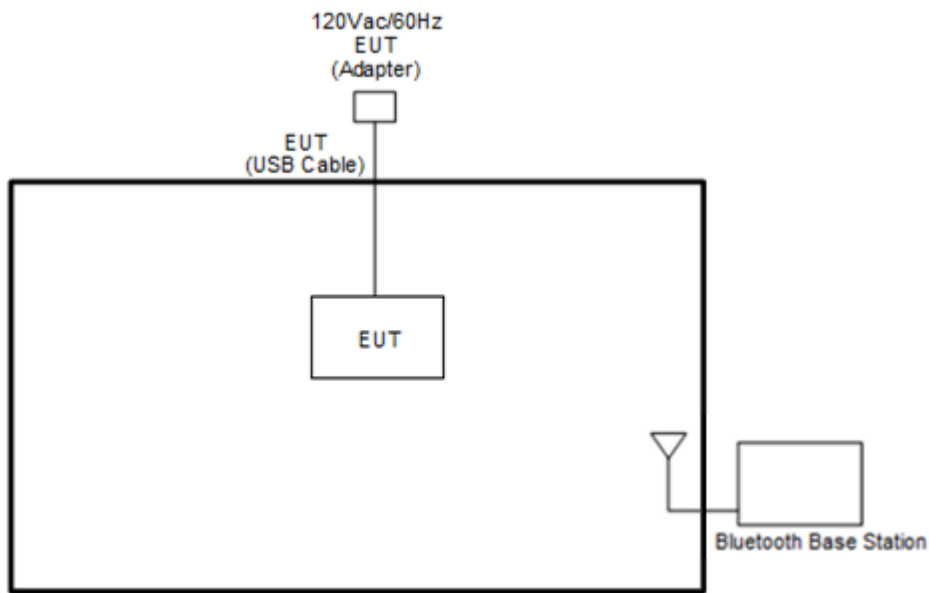

<WPC Mode>

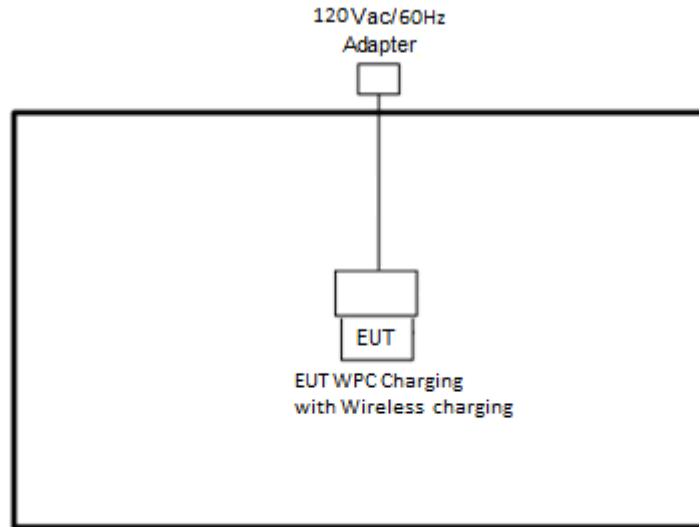

2.4 Support Unit used in test configuration and system

Item	Equipment	Trade Name	Model Name	FCC ID	Data Cable	Power Cord
1.	System Simulator	Anritsu	MT8820C	N/A	N/A	Unshielded, 1.8 m
2.	Bluetooth Earphone	Google	G1007/ G1008	A4RG1007	N/A	N/A
3.	WLAN AP	ASUS	RT-AC66U	MSQ-RTAC66U	N/A	Unshielded, 1.8 m
4.	Notebook	DELL	Latitude 3400	FCC DoC	N/A	AC I/P: Unshielded, 1.2 m DC O/P: Shielded, 1.8 m
5.	Wireless charging	YU-live	K8	N/A	N/A	N/A
6.	Bluetooth Base Station	R&S	CBT32	N/A	N/A	Unshielded, 1.8 m



2.5 EUT Operation Test Setup

The RF test items, utility “QRCT V4.0.00153.0” was installed in Notebook which was programmed in order to make the EUT get into the engineering modes to contact with base station to provide channel selection, power level, data rate and the application type and for continuous transmitting signals.

2.6 Measurement Results Explanation Example

For all conducted test items:

The offset level is set in the spectrum analyzer to compensate the RF cable loss and attenuator factor between EUT conducted output port and spectrum analyzer. With the offset compensation, the spectrum analyzer reading level is exactly the EUT RF output level.

Example:

The spectrum analyzer offset is derived from RF cable loss and attenuator factor.

Offset = RF cable loss + attenuator factor.

Following shows an offset computation example with cable loss 4.2 dB and 10dB attenuator.

$$\begin{aligned} \text{Offset(dB)} &= \text{RF cable loss(dB)} + \text{attenuator factor(dB)}. \\ &= 4.2 + 10 = 14.2 \text{ (dB)} \end{aligned}$$

3 Test Result

3.1 Number of Channel Measurement

3.1.1 Limits of Number of Hopping Frequency

Frequency hopping systems in the 2400-2483.5 MHz band shall use at least 15 channels.

3.1.2 Measuring Instruments

See list of measuring equipment of this test report.

3.1.3 Test Procedure

1. The testing follows ANSI C63.10-2013 clause 7.8.3.
2. The RF output of EUT was connected to the spectrum analyzer by RF cable and attenuator. The path loss was compensated to the results for each measurement.
3. Set to the maximum power setting and enable the EUT transmit continuously.
4. Enable the EUT hopping function.
5. Use the following spectrum analyzer settings: Span = the frequency band of operation; RBW = 300kHz; VBW \geq RBW; Sweep = auto; Detector function = peak; Trace = max hold.
6. The number of hopping frequency used is defined as the number of total channel.
7. Record the measurement data derived from spectrum analyzer.

3.1.4 Test Setup

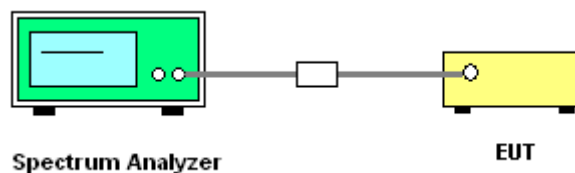

3.1.5 Test Result of Number of Hopping Frequency

Please refer to Appendix A.

Number of Hopping Channel Plot on Channel 00 - 78

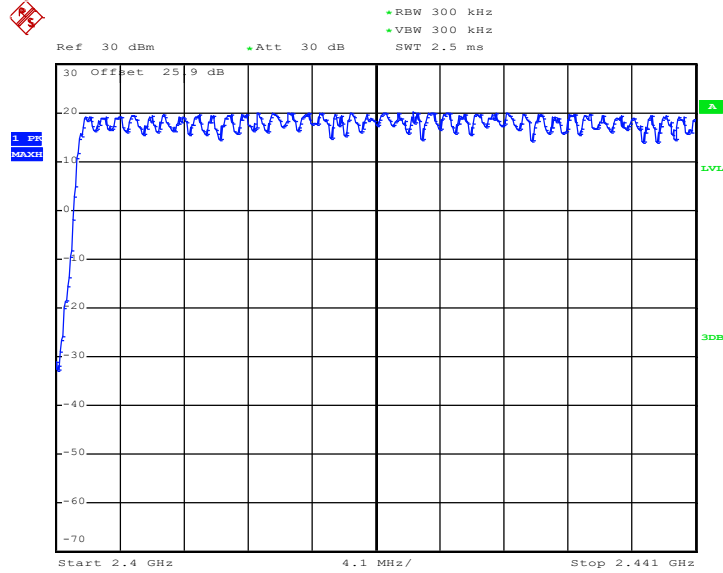

Date: 24.MAY.2020 23:06:22

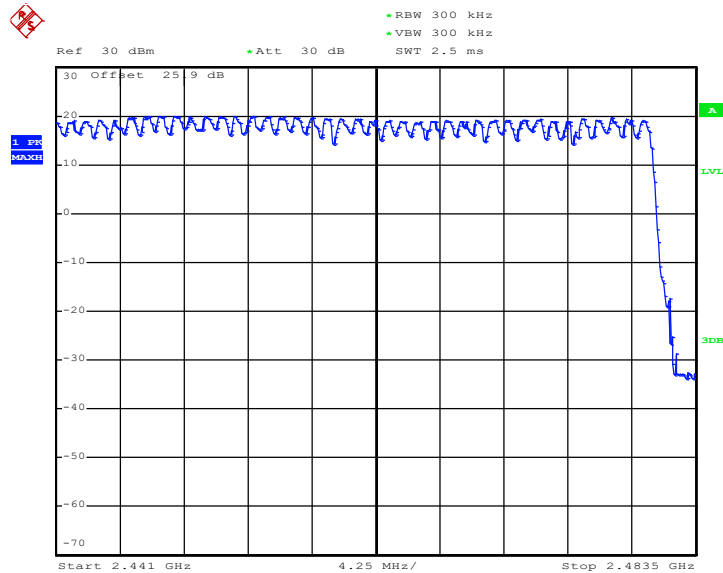

Date: 24.MAY.2020 23:07:41

3.2 Hopping Channel Separation Measurement

3.2.1 Limit of Hopping Channel Separation

Frequency hopping systems operating in the 2400-2483.5 MHz band may have hopping channel carrier frequencies that are separated by 25 kHz or two-thirds of the 20 dB bandwidth of the hopping channel, whichever is greater.

3.2.2 Measuring Instruments

See list of measuring equipment of this test report.

3.2.3 Test Procedures

1. The testing follows ANSI C63.10-2013 clause 7.8.2.
2. The RF output of EUT was connected to the spectrum analyzer by RF cable and attenuator. The path loss was compensated to the results for each measurement.
3. Set to the maximum power setting and enable the EUT transmit continuously.
4. Enable the EUT hopping function.
5. Use the following spectrum analyzer settings:
Span = wide enough to capture the peaks of two adjacent channels;
RBW = 300kHz; VBW \geq RBW; Sweep = auto; Detector function = peak; Trace = max hold.
6. Measure and record the results in the test report.

3.2.4 Test Setup

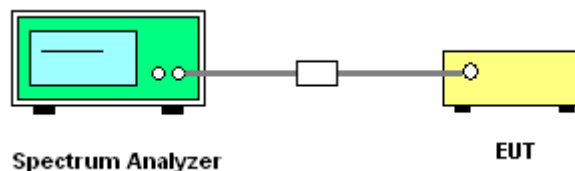

3.2.5 Test Result of Hopping Channel Separation

Please refer to Appendix A.



<1Mbps>

Channel Separation Plot on Channel 00 - 01

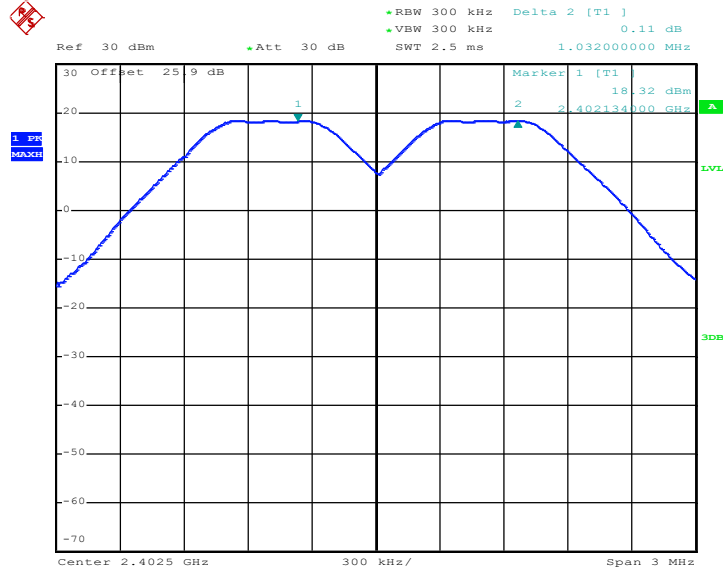

Date: 14.MAY.2020 00:40:14

Channel Separation Plot on Channel 39 - 40

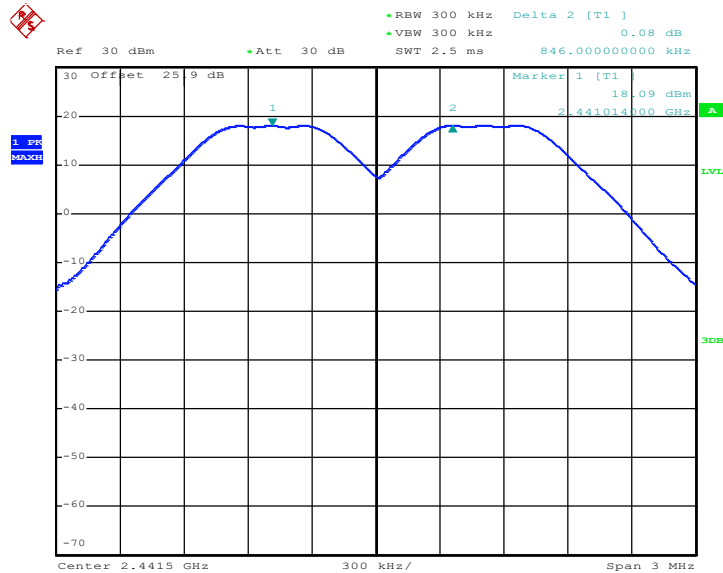

Date: 14.MAY.2020 00:41:38



Channel Separation Plot on Channel 77 - 78

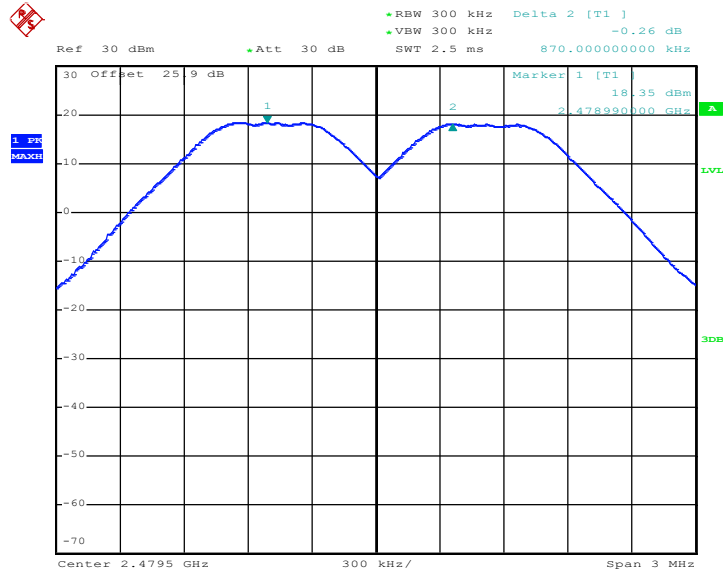

Date: 14.MAY.2020 00:42:45

<2Mbps>

Channel Separation Plot on Channel 00 - 01

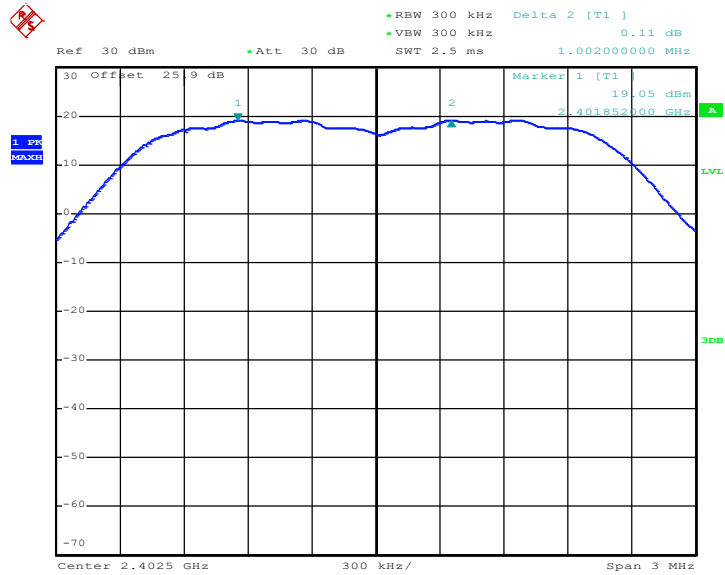

Date: 14.MAY.2020 00:43:58



Channel Separation Plot on Channel 39 - 40

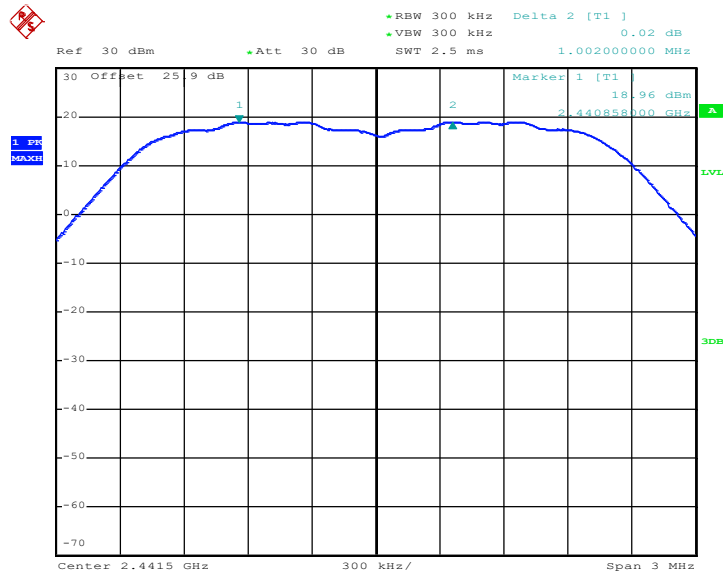

Date: 14.MAY.2020 00:44:58

Channel Separation Plot on Channel 77 - 78

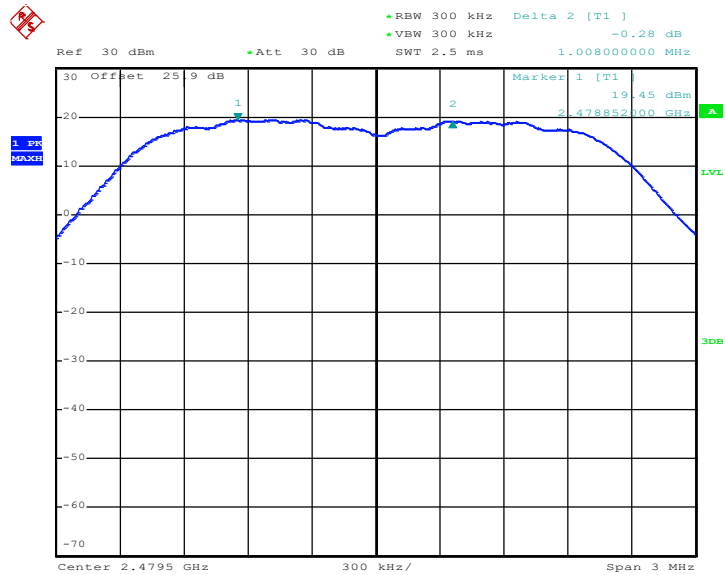

Date: 14.MAY.2020 00:46:06



<3Mbps>

Channel Separation Plot on Channel 00 - 01

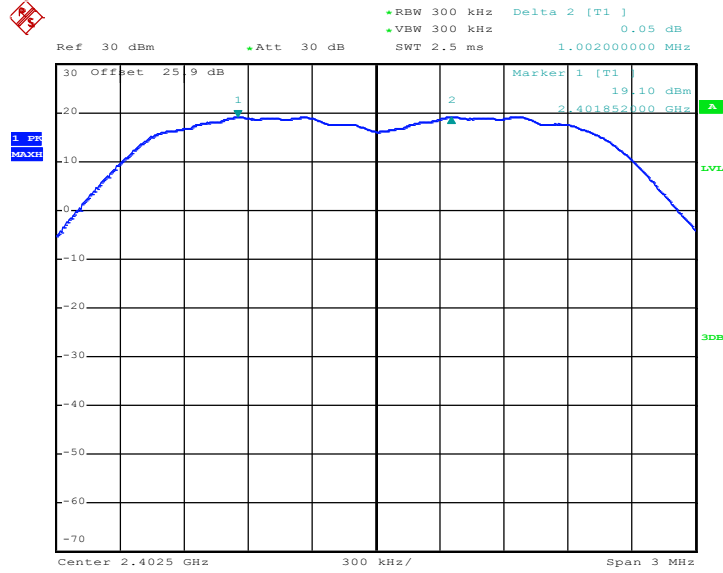

Date: 14.MAY.2020 00:47:22

Channel Separation Plot on Channel 39 - 40

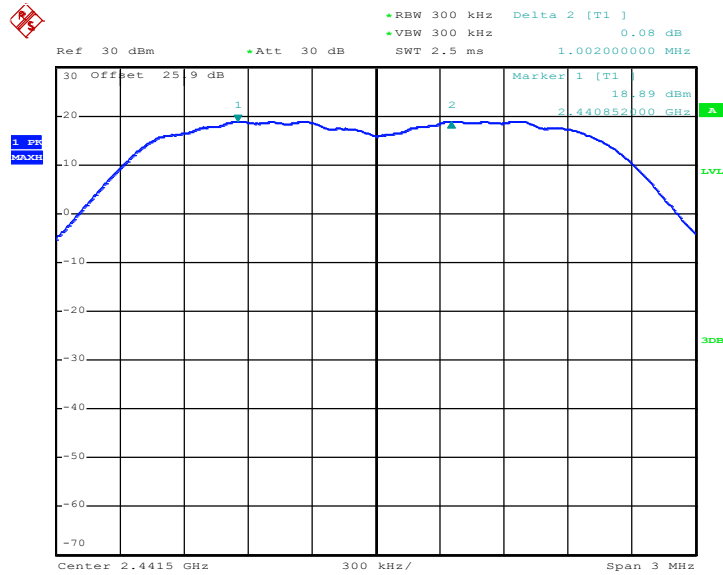

Date: 14.MAY.2020 00:48:22



Channel Separation Plot on Channel 77 - 78

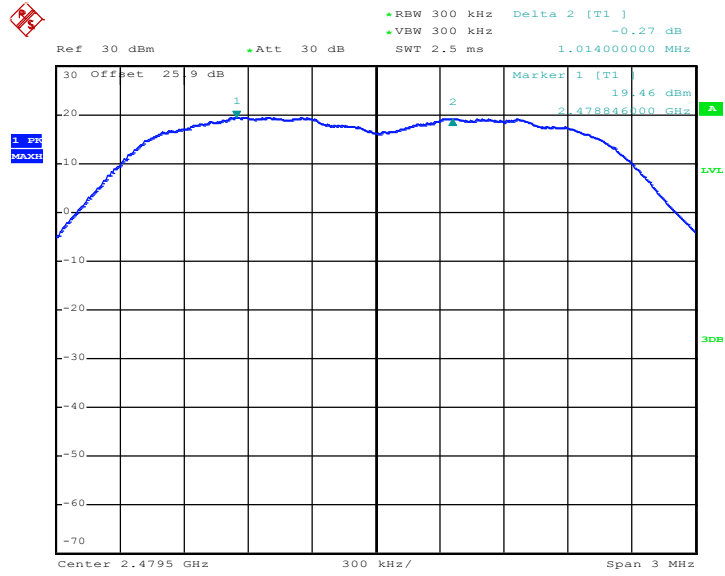

Date: 14.MAY.2020 00:49:35

3.3 Dwell Time Measurement

3.3.1 Limit of Dwell Time

The average time of occupancy on any channel shall not be greater than 0.4 seconds within a period of 0.4 seconds multiplied by the number of hopping channels employed.

3.3.2 Measuring Instruments

See list of measuring equipment of this test report.

3.3.3 Test Procedures

1. The testing follows ANSI C63.10-2013 clause 7.8.4.
2. The RF output of EUT was connected to the spectrum analyzer by RF cable and attenuator. The path loss was compensated to the results for each measurement.
3. Set to the maximum power setting and enable the EUT transmit continuously.
4. Enable the EUT hopping function.
5. Use the following spectrum analyzer settings: Span = zero span, centered on a hopping channel; RBW = 1 MHz; VBW \geq RBW; Sweep = as necessary to capture the entire dwell time per hopping channel; Detector function = peak; Trace = max hold.
6. Measure and record the results in the test report.

3.3.4 Test Setup

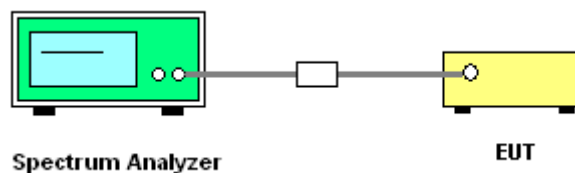

3.3.5 Test Result of Dwell Time

Please refer to Appendix A.

Package Transfer Time Plot

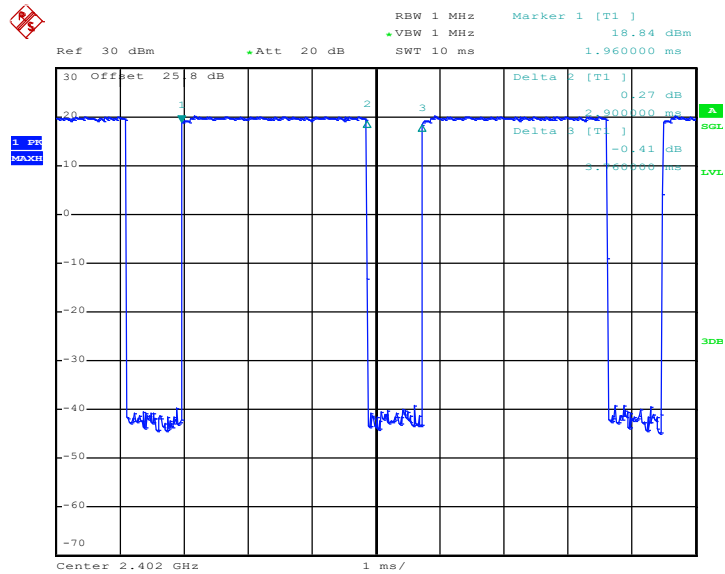

Date: 28.APR.2020 21:59:05

Remark:

1. In normal mode, hopping rate is 1600 hops/s with 6 slots in 79 hopping channels. With channel hopping rate (1600 / 6 / 79) in Occupancy Time Limit (0.4 x 79) (s), Hops Over Occupancy Time comes to (1600 / 6 / 79) x (0.4 x 79) = 106.67 hops.
2. In AFH mode, hopping rate is 800 hops/s with 6 slots in 20 hopping channels. With channel hopping rate (800 / 6 / 20) in Occupancy Time Limit (0.4 x 20) (s), Hops Over Occupancy Time comes to (800 / 6 / 20) x (0.4 x 20) = 53.33 hops.
3. Dwell Time(s) = Hops Over Occupancy Time (hops) x Package Transfer Time

3.4 20dB and 99% Bandwidth Measurement

3.4.1 Limit of 20dB and 99% Bandwidth

Reporting only

3.4.2 Measuring Instruments

See list of measuring equipment of this test report.

3.4.3 Test Procedures

1. The testing follows ANSI C63.10-2013 clause 6.9.2 and 6.9.3.
2. The RF output of EUT was connected to the spectrum analyzer by RF cable and attenuator. The path loss was compensated to the results for each measurement.
3. Set to the maximum power setting and enable the EUT transmit continuously.
4. Use the following spectrum analyzer settings for 20dB Bandwidth measurement.
Span = approximately 2 to 5 times the 20 dB bandwidth, centered on a hopping channel;
RBW \geq 1% of the 20 dB bandwidth; VBW \geq RBW; Sweep = auto; Detector function = peak;
Trace = max hold.
5. Use the following spectrum analyzer settings for 99 % Bandwidth measurement.
Span = approximately 1.5 to 5 times the 99% bandwidth, centered on a hopping channel;
RBW \geq 1-5% of the 99% bandwidth; VBW \geq 3 * RBW; Sweep = auto; Detector function = peak;
Trace = max hold.
6. Measure and record the results in the test report.

3.4.4 Test Setup

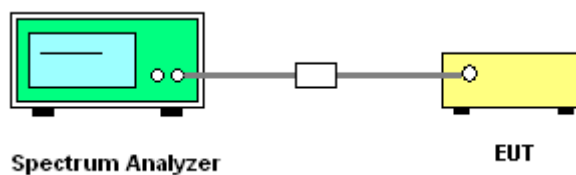

3.4.5 Test Result of 20dB Bandwidth

Please refer to Appendix A.



<1Mbps>

20 dB Bandwidth Plot on Channel 00

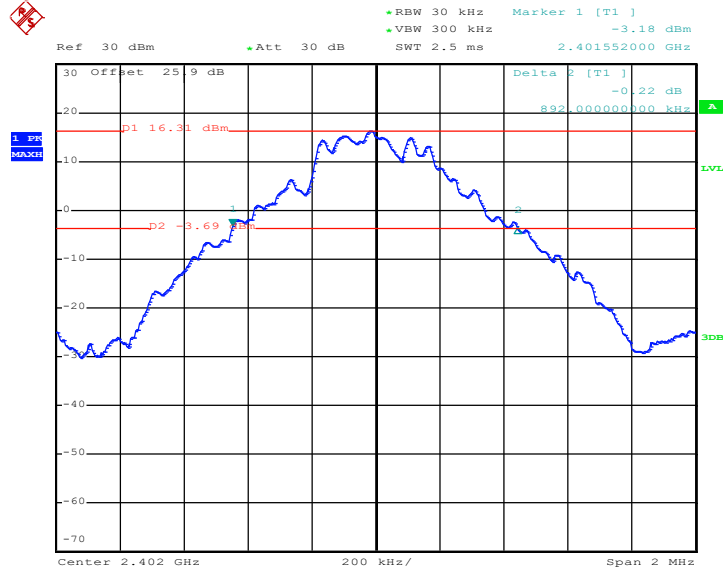

Date: 24.MAY.2020 22:08:30

20 dB Bandwidth Plot on Channel 39

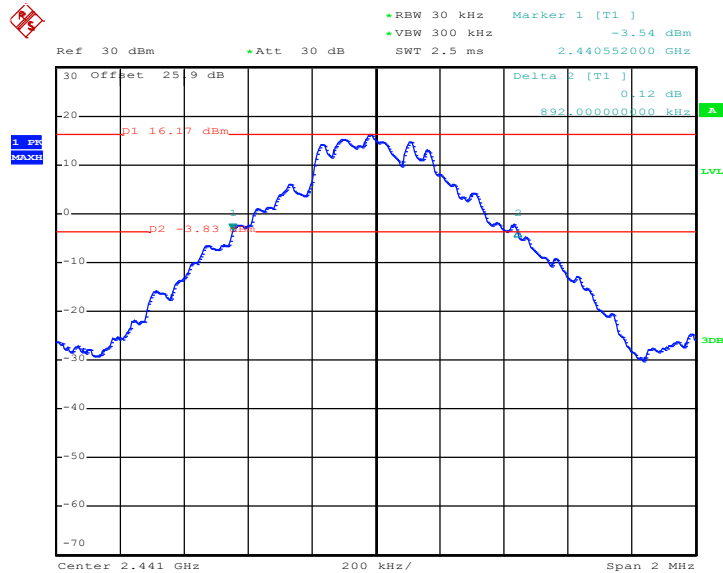

Date: 24.MAY.2020 22:27:25



20 dB Bandwidth Plot on Channel 78

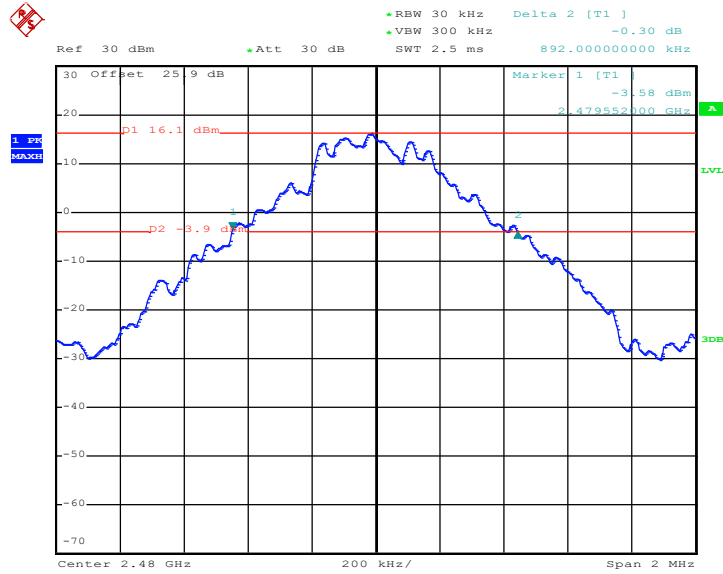

Date: 24.MAY.2020 22:38:47

<2Mbps>

20 dB Bandwidth Plot on Channel 00

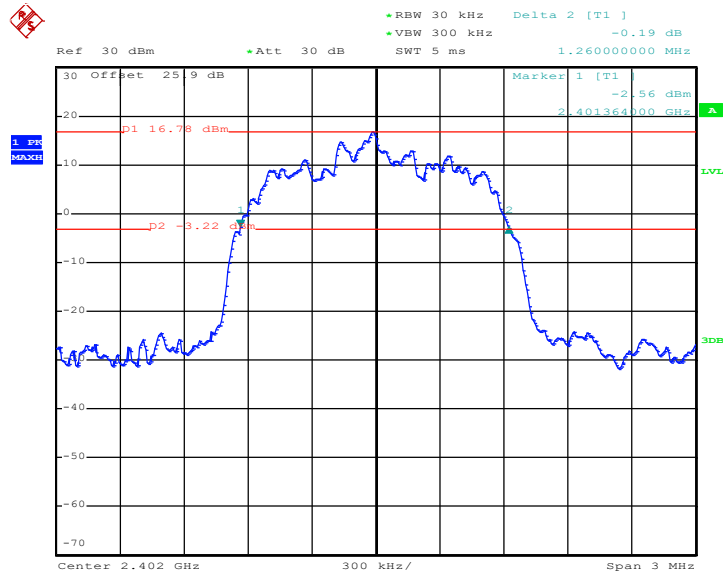

Date: 24.MAY.2020 22:14:44



20 dB Bandwidth Plot on Channel 39

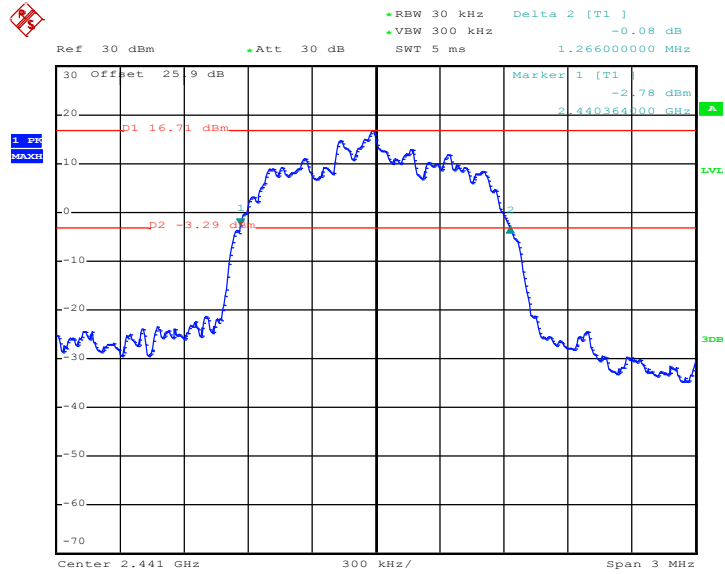

Date: 24.MAY.2020 22:29:54

20 dB Bandwidth Plot on Channel 78

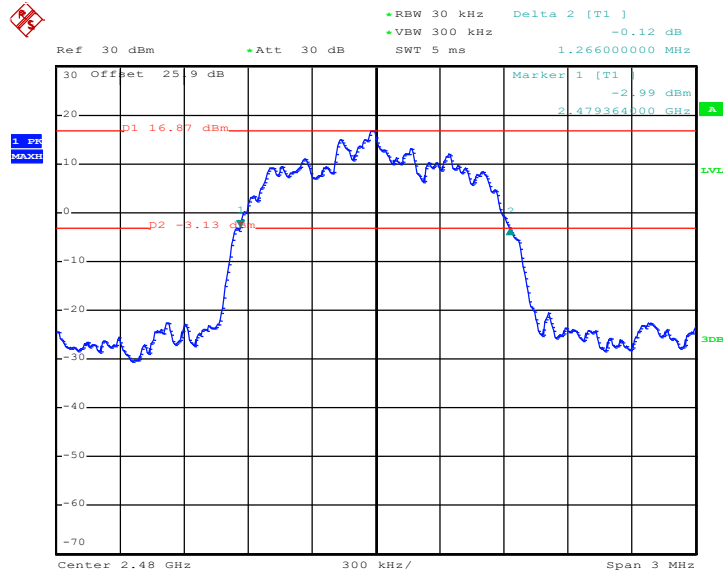

Date: 24.MAY.2020 22:39:58



<3Mbps>

20 dB Bandwidth Plot on Channel 00

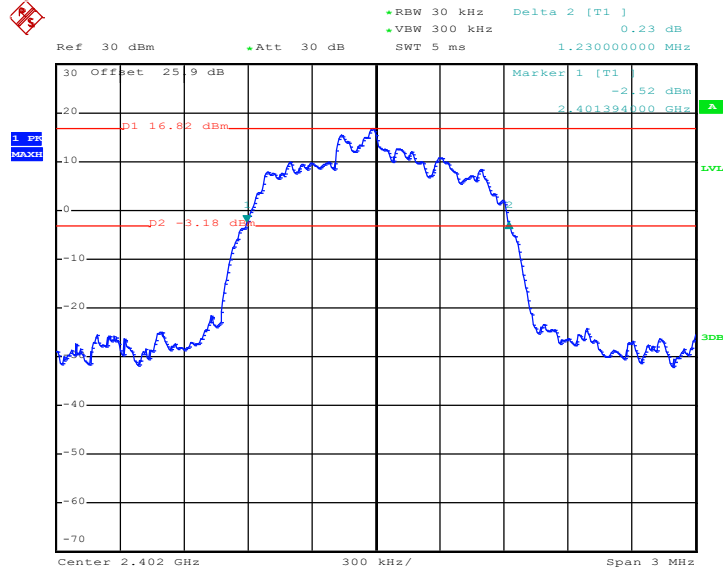

Date: 24.MAY.2020 22:24:33

20 dB Bandwidth Plot on Channel 39

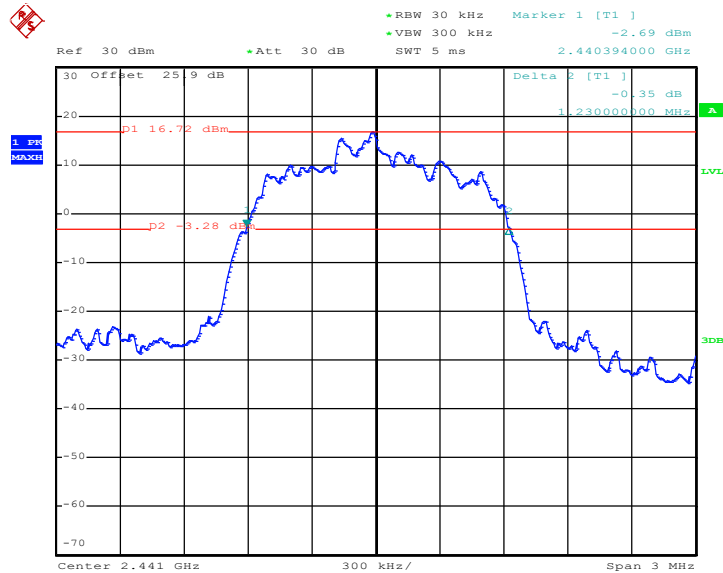

Date: 24.MAY.2020 22:35:23



20 dB Bandwidth Plot on Channel 78

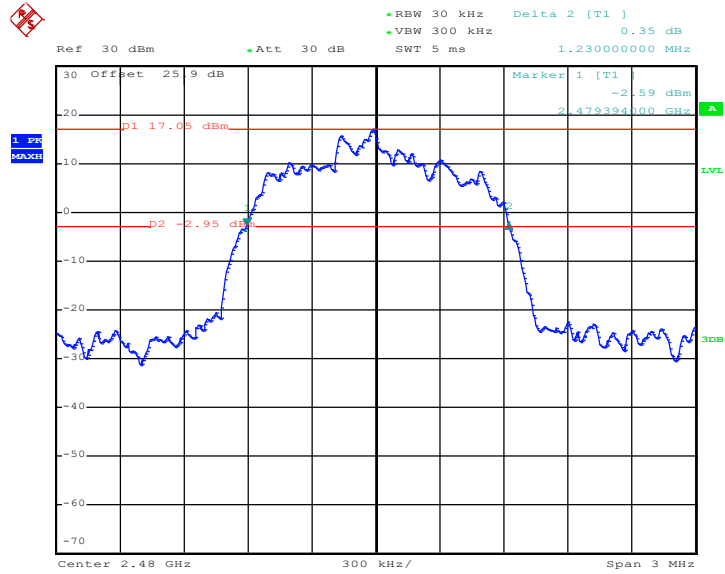

Date: 24.MAY.2020 22:41:25



3.4.6 Test Result of 99% Occupied Bandwidth

Please refer to Appendix A.

<1Mbps>

99% Occupied Bandwidth Plot on Channel 00

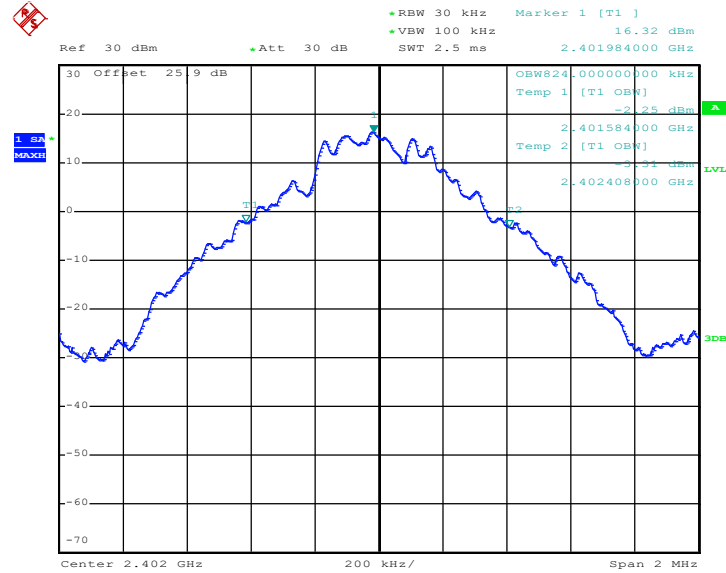

Date: 14.MAY.2020 01:15:41



99% Occupied Bandwidth Plot on Channel 39

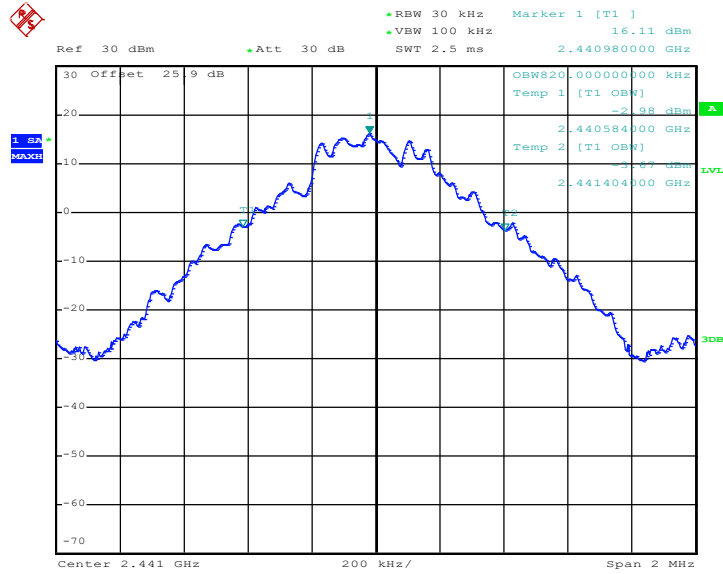

Date: 14.MAY.2020 01:16:29

99% Occupied Bandwidth Plot on Channel 78

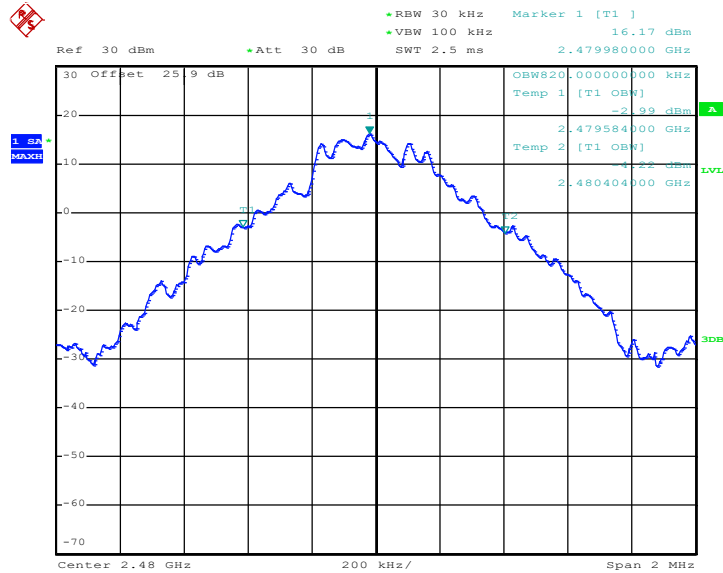

Date: 14.MAY.2020 01:17:14



<2Mbps>

99% Occupied Bandwidth Plot on Channel 00

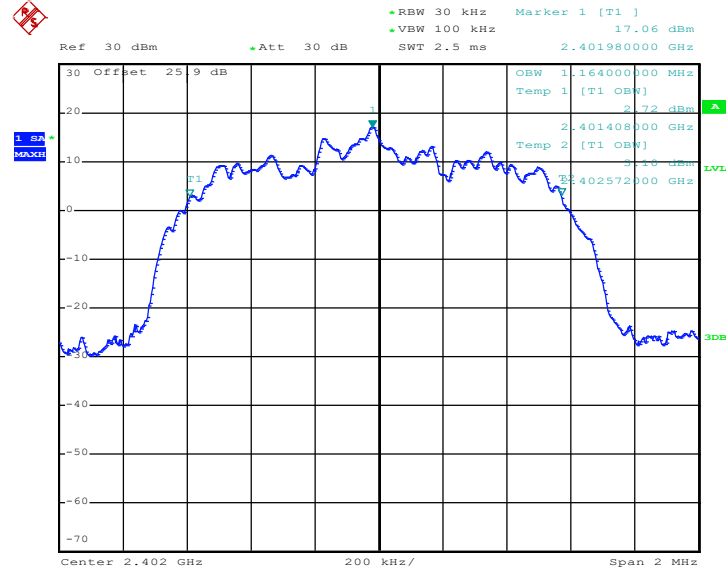

Date: 14.MAY.2020 01:21:06

99% Occupied Bandwidth Plot on Channel 39

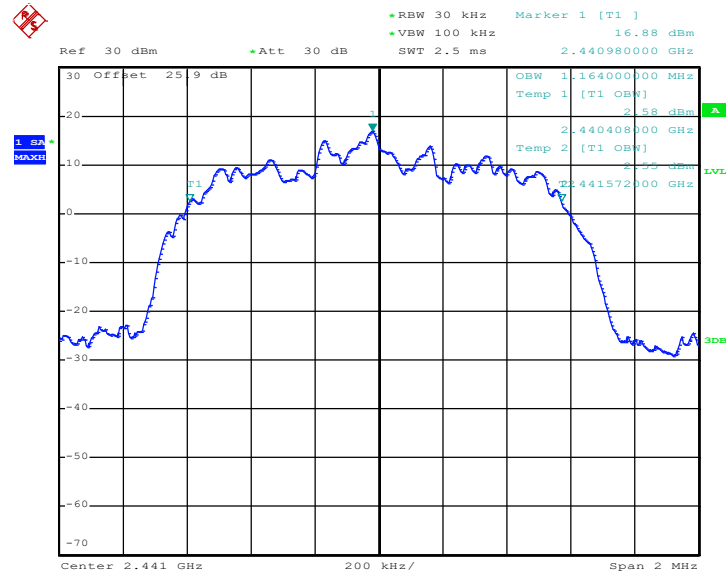

Date: 14.MAY.2020 01:22:08



99% Occupied Bandwidth Plot on Channel 78

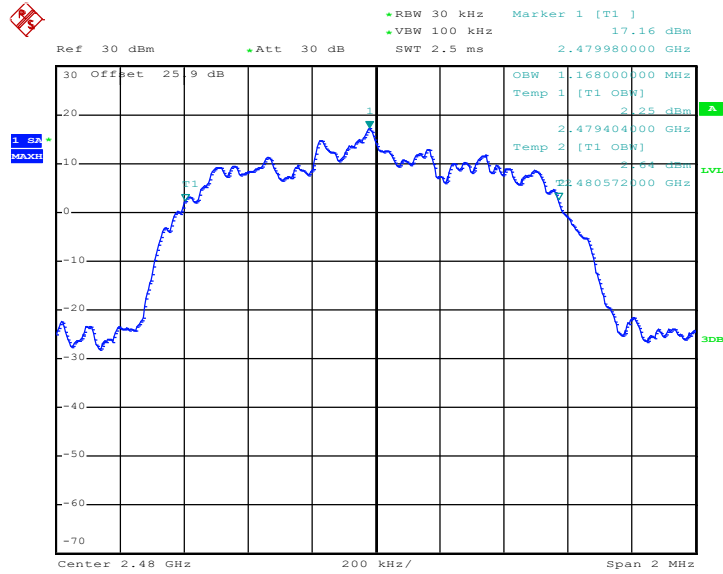

Date: 14.MAY.2020 01:24:40

<3Mbps>

99% Occupied Bandwidth Plot on Channel 00

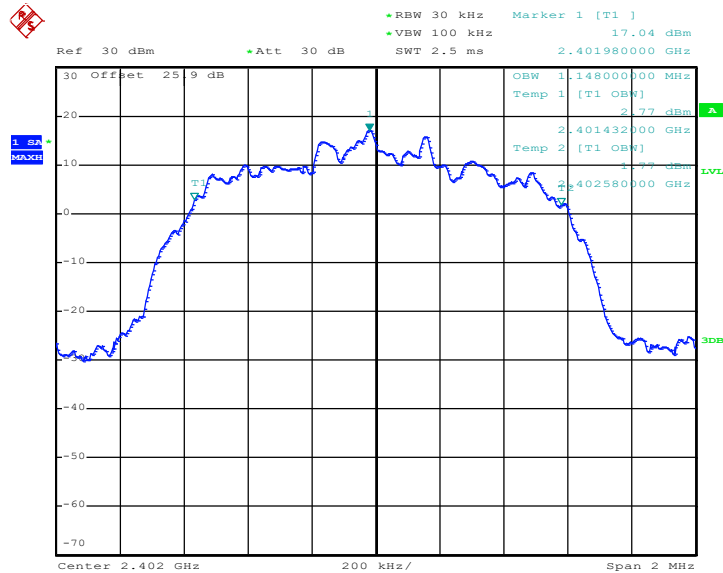

Date: 14.MAY.2020 01:26:25



99% Occupied Bandwidth Plot on Channel 39

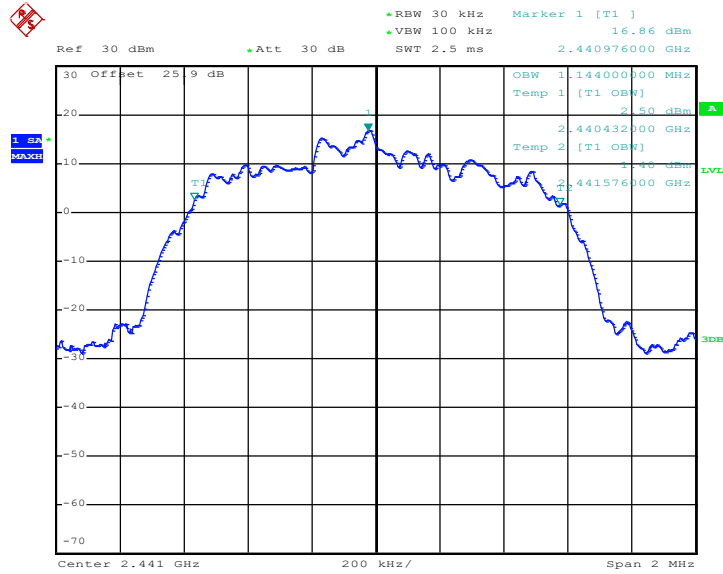

Date: 14.MAY.2020 01:27:52

99% Occupied Bandwidth Plot on Channel 78

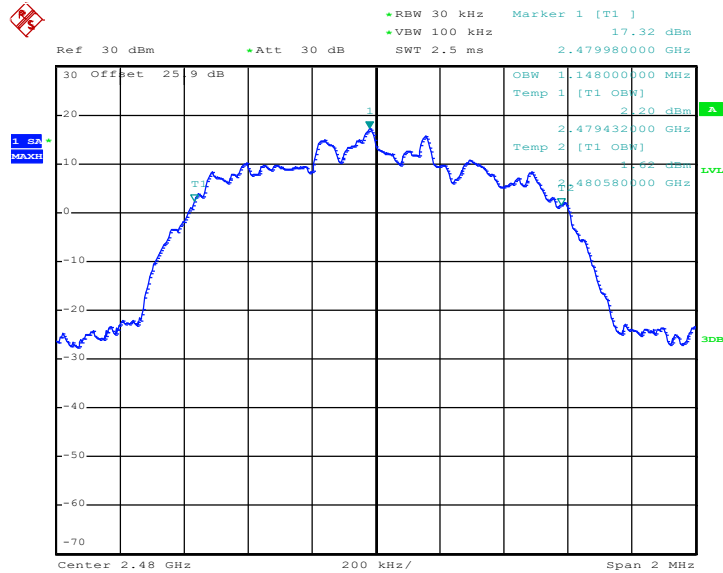

Date: 14.MAY.2020 01:28:57

Note: The occupied channel bandwidth is maintained within the band of operation for all of the modulations.

3.5 Output Power Measurement

3.5.1 Limit of Output Power

The maximum peak conducted output power of the intentional radiator shall not exceed the following:
For frequency hopping systems operating in the 2400-2483.5 MHz band employing at least 75 non-overlapping hopping channels, and all frequency hopping systems in the 5725-5850 MHz band: 1 watt. For all other frequency hopping systems in the 2400-2483.5 MHz band 0.125 watts.

3.5.2 Measuring Instruments

See list of measuring equipment of this test report.

3.5.3 Test Procedures

1. The testing follows ANSI C63.10-2013 clause 7.8.5.
2. The RF output of EUT was connected to the power meter by RF cable and attenuator. The path loss was compensated to the results for each measurement.
3. Set to the maximum power setting and enable the EUT transmit continuously.
4. Measure the conducted output power with cable loss and record the results in the test report.
5. Measure and record the results in the test report.

3.5.4 Test Setup

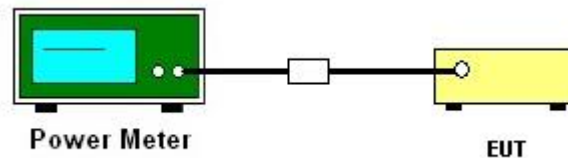

3.5.5 Test Result of Peak Output Power

Please refer to Appendix A.

3.5.6 Test Result of Average Output Power (Reporting Only)

Please refer to Appendix A.

3.6 Conducted Band Edges Measurement

3.6.1 Limit of Band Edges

In any 100 kHz bandwidth outside the intentional radiation frequency band, the radio frequency power shall be at least 20 dB below the highest level of the radiated power. In addition, radiated emissions which fall in the restricted bands must also comply with the radiated emission limits.

3.6.2 Measuring Instruments

See list of measuring equipment of this test report.

3.6.3 Test Procedures

1. The testing follows ANSI C63.10-2013 clause 7.8.6.
2. Set to the maximum power setting and enable the EUT transmit continuously.
3. Set RBW = 100kHz, VBW = 300kHz. Band edge emissions must be at least 20 dB down from the highest emission level within the authorized band as measured with a 100kHz RBW. The attenuation shall be 30 dB instead of 20 dB when RMS conducted output power procedure is used.
4. Enable hopping function of the EUT and then repeat step 2. and 3.
5. Measure and record the results in the test report.

3.6.4 Test Setup

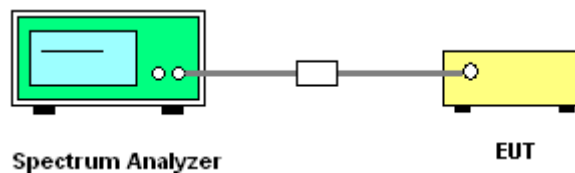



3.6.5 Test Result of Conducted Band Edges

<1Mbps>

Low Band Edge Plot on Channel 00

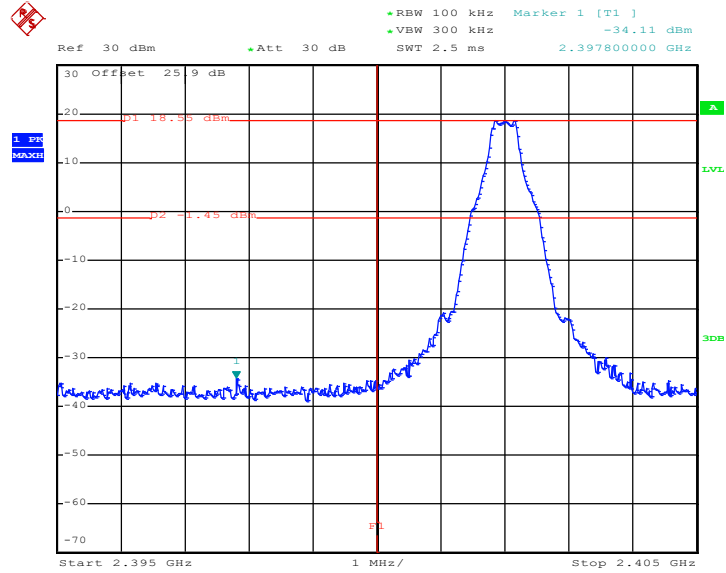

Date: 14.MAY.2020 01:02:35

High Band Edge Plot on Channel 78

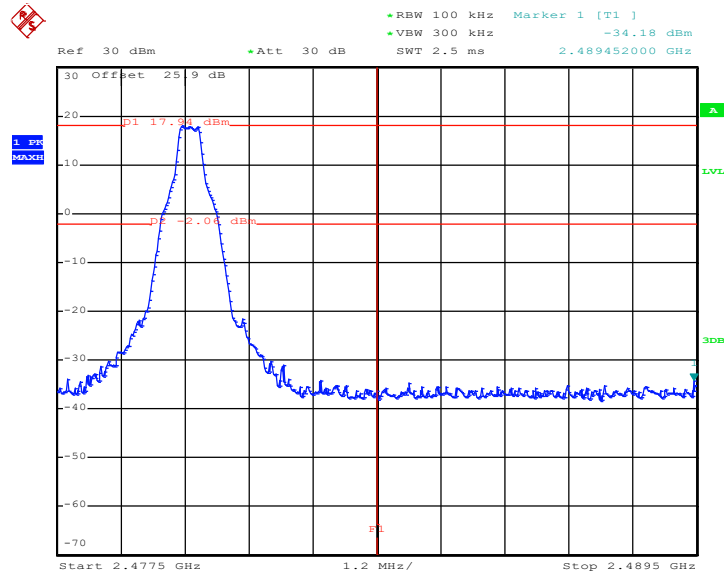

Date: 14.MAY.2020 01:03:40



<2Mbps>

Low Band Edge Plot on Channel 00

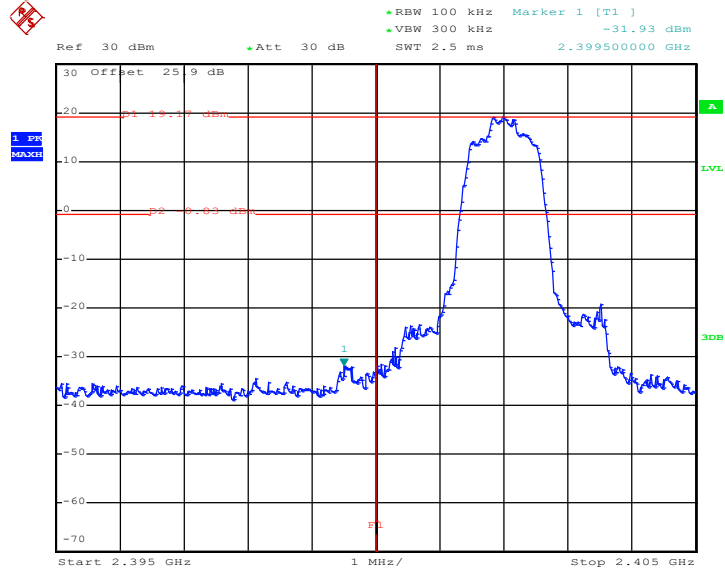

Date: 14.MAY.2020 01:04:35

High Band Edge Plot on Channel 78

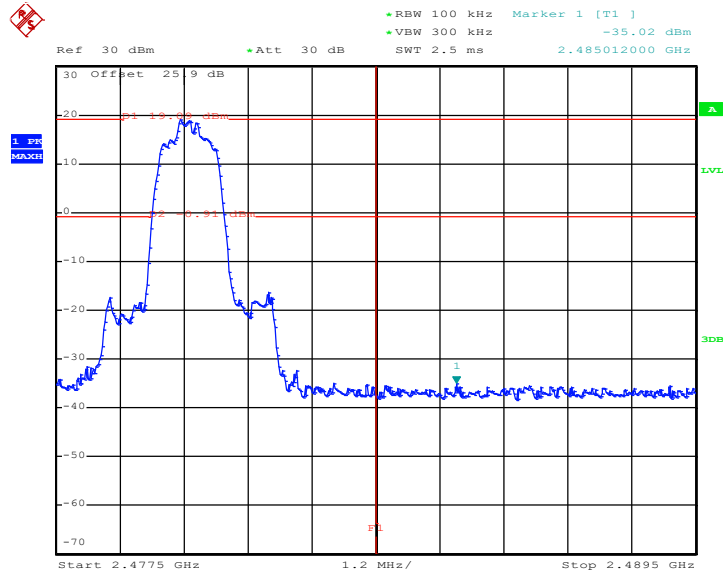

Date: 14.MAY.2020 01:08:28



<3Mbps>

Low Band Edge Plot on Channel 00

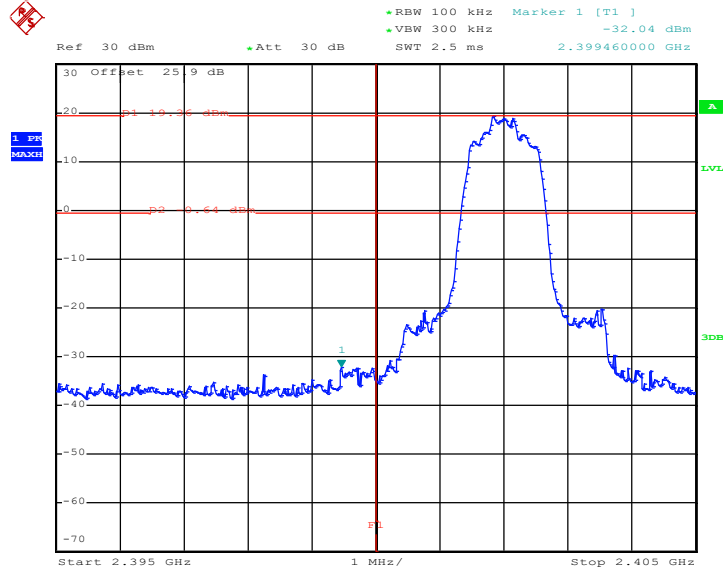

Date: 14.MAY.2020 01:10:32

High Band Edge Plot on Channel 78

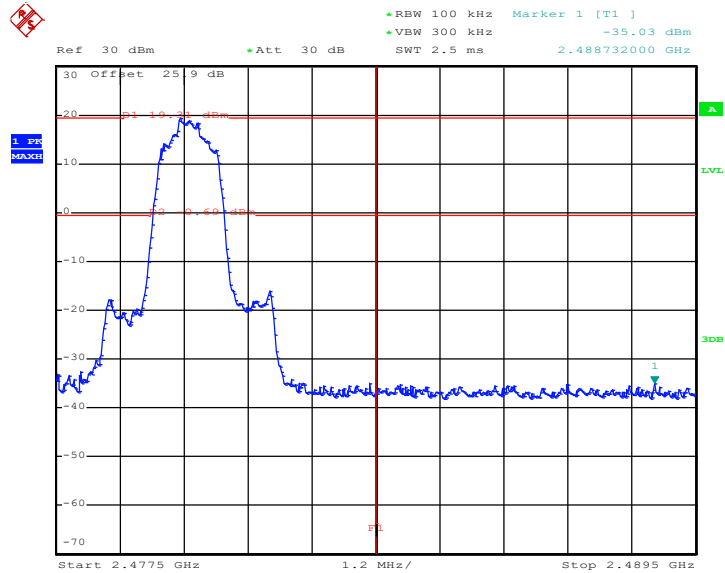

Date: 14.MAY.2020 01:12:14

3.6.6 Test Result of Conducted Hopping Mode Band Edges

<1Mbps>

Hopping Mode Low Band Edge Plot

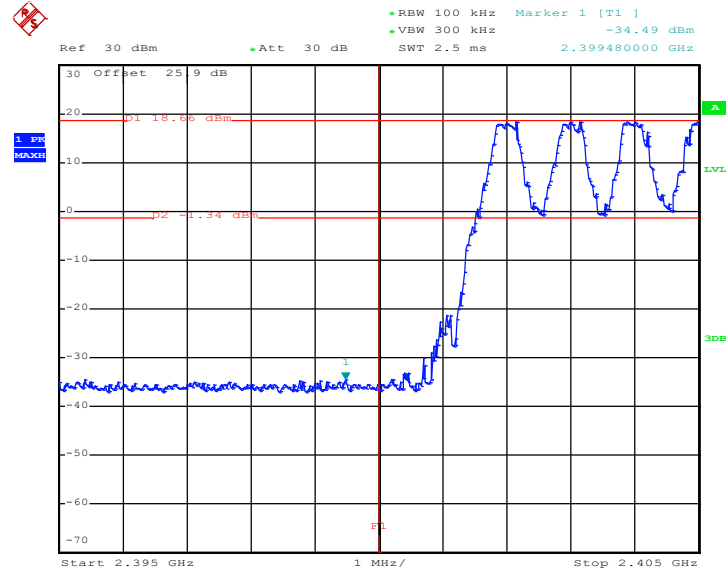

Date: 24.MAY.2020 23:13:19

Hopping Mode High Band Edge Plot

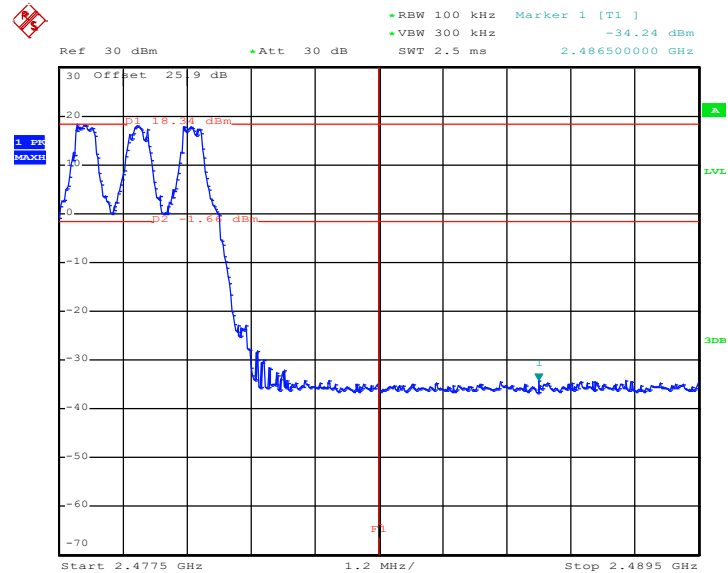

Date: 24.MAY.2020 23:15:47



<2Mbps>

Hopping Mode Low Band Edge Plot

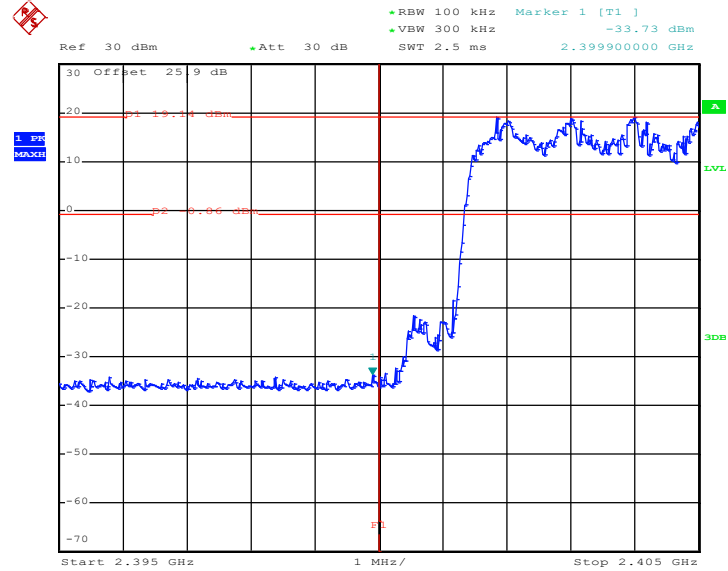

Date: 24.MAY.2020 23:18:45

Hopping Mode High Band Edge Plot

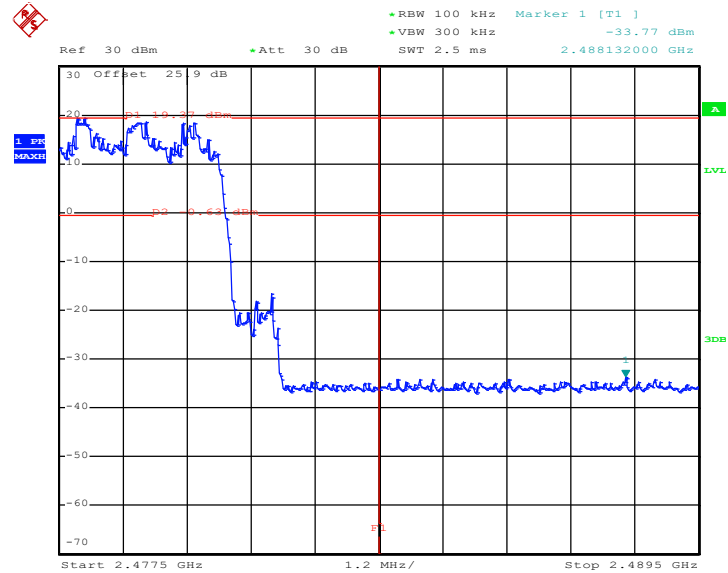

Date: 24.MAY.2020 23:20:33



<3Mbps>

Hopping Mode Low Band Edge Plot

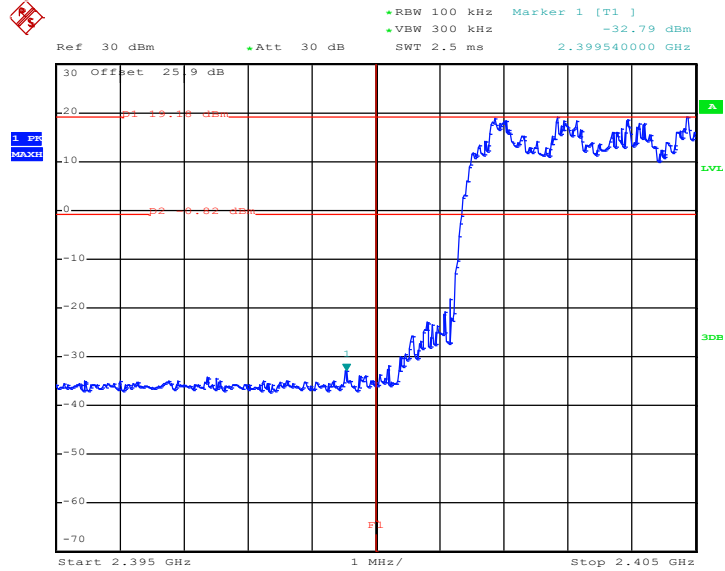

Date: 24.MAY.2020 23:22:38

Hopping Mode High Band Edge Plot

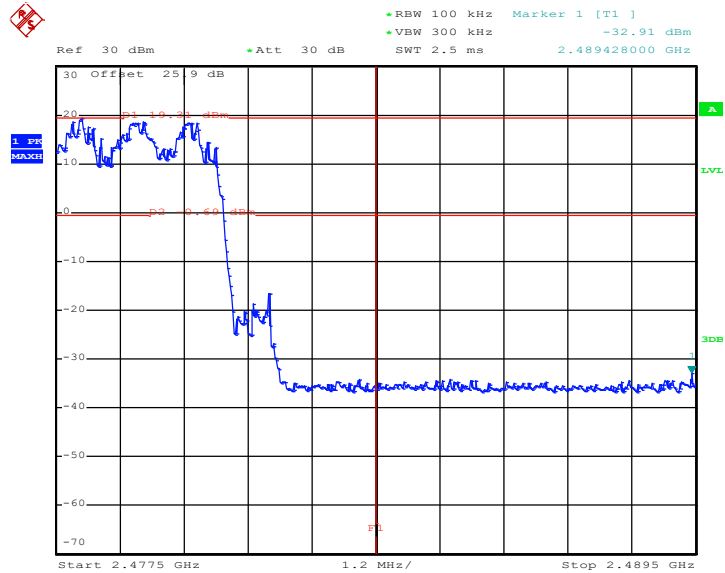

Date: 24.MAY.2020 23:24:12

3.7 Conducted Spurious Emission Measurement

3.7.1 Limit of Spurious Emission Measurement

In any 100 kHz bandwidth outside the intentional radiation frequency band, the radio frequency power shall be at least 20 dB below the highest level of the radiated power. In addition, radiated emissions which fall in the restricted bands must also comply with the radiated emission limits.

3.7.2 Measuring Instruments

See list of measuring equipment of this test report.

3.7.3 Test Procedure

1. The testing follows ANSI C63.10-2013 clause 7.8.8.
2. The RF output of EUT was connected to the spectrum analyzer by RF cable and attenuator. The path loss was compensated to the results for each measurement.
3. Set to the maximum power setting and enable the EUT transmit continuously.
4. Set RBW = 100 kHz, VBW = 300kHz, scan up through 10th harmonic. All harmonics / spurs must be at least 20 dB down from the highest emission level within the authorized band as measured with a 100 kHz RBW.
5. Measure and record the results in the test report.
6. The RF fundamental frequency should be excluded against the limit line in the operating frequency band.

3.7.4 Test Setup

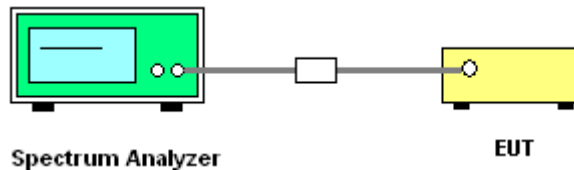



3.7.5 Test Result of Conducted Spurious Emission

<1Mbps>

CSE Plot on Ch 00 between 30MHz ~ 3 GHz

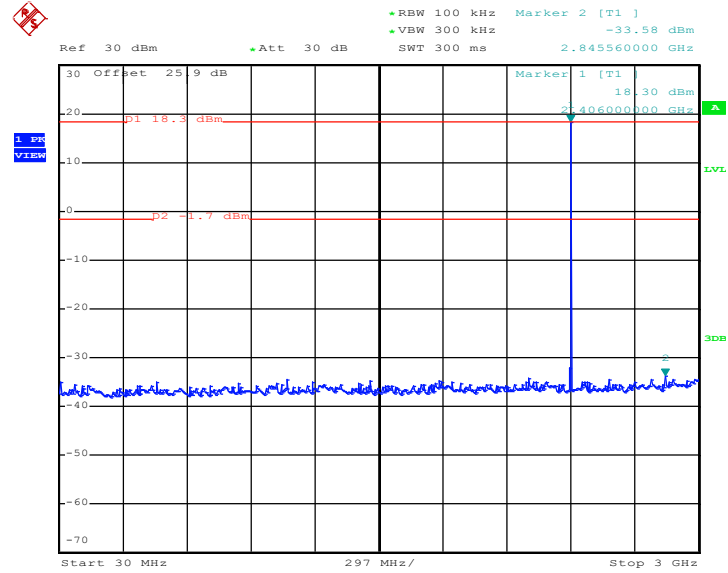

Date: 24.MAY.2020 22:43:49

1Mbps CSE Plot on Ch 00 between 2 GHz ~ 25 GHz

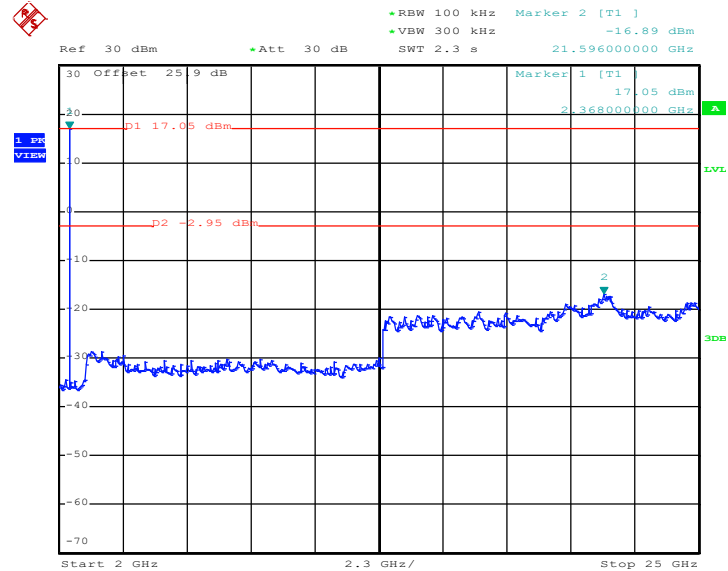

Date: 24.MAY.2020 22:44:19



CSE Plot on Ch 39 between 30MHz ~ 3 GHz

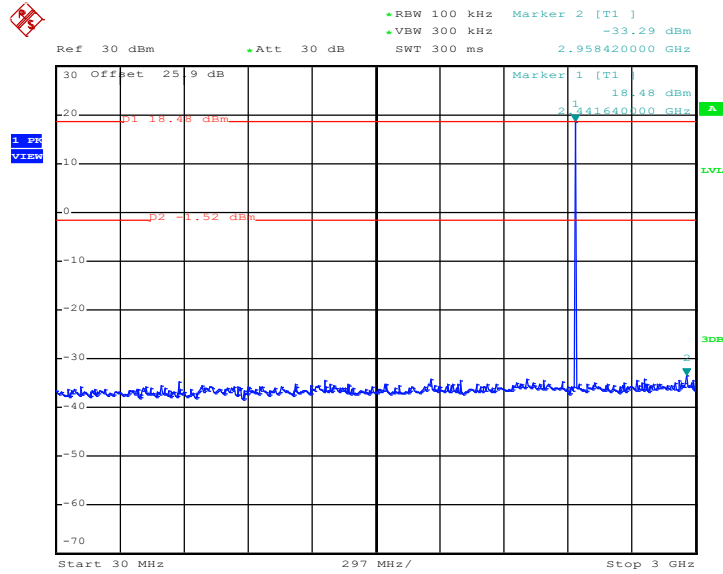

Date: 24.MAY.2020 22:52:48

CSE Plot on Ch 39 between 2 GHz ~ 25 GHz

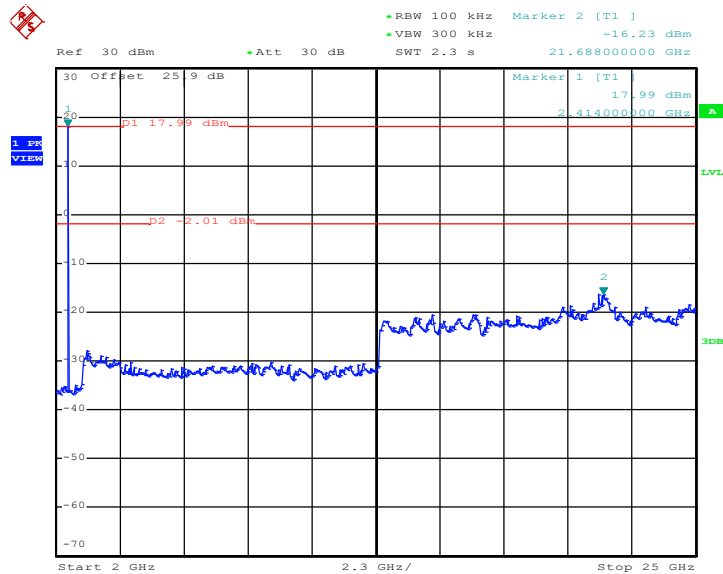

Date: 24.MAY.2020 22:53:23



CSE Plot on Ch 78 between 30MHz ~ 3 GHz

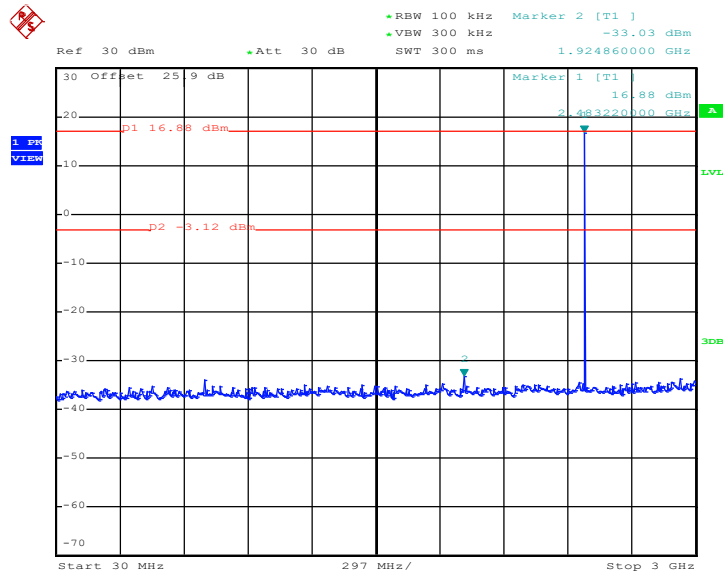

Date: 24.MAY.2020 22:59:38

CSE Plot on Ch 78 between 2 GHz ~ 25 GHz

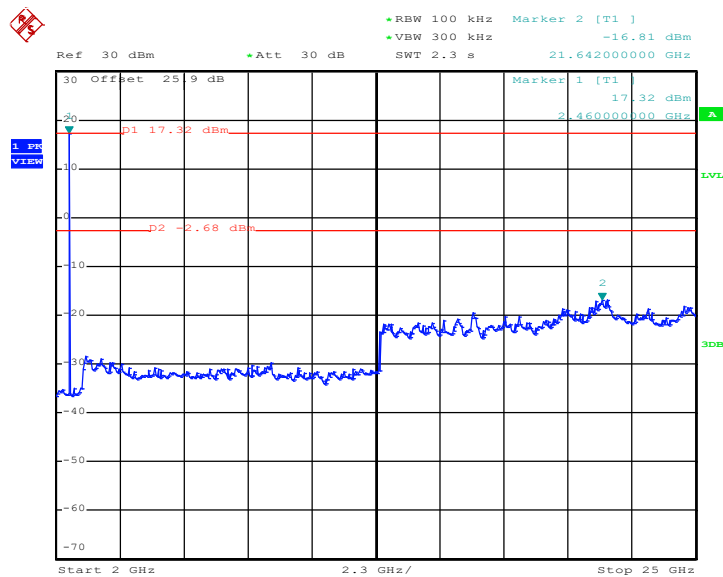

Date: 24.MAY.2020 23:00:30



<2Mbps>

CSE Plot on Ch 00 between 30MHz ~ 3 GHz

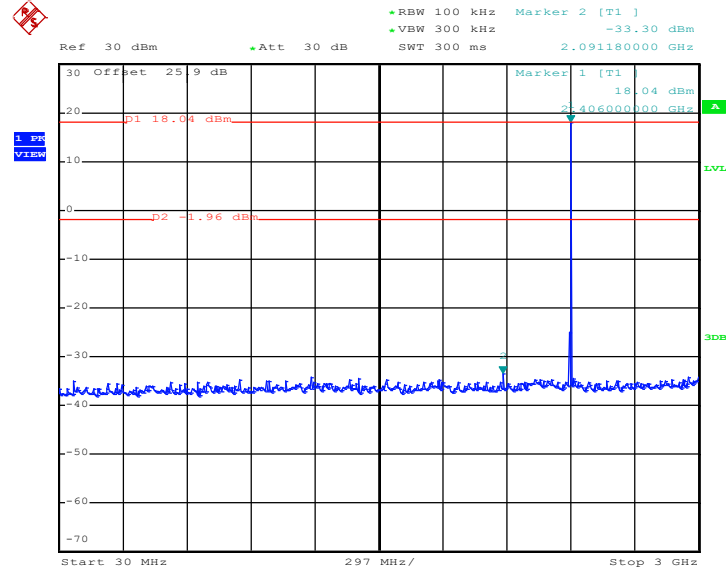

Date: 24.MAY.2020 22:49:50

CSE Plot on Ch 00 between 2 GHz ~ 25 GHz

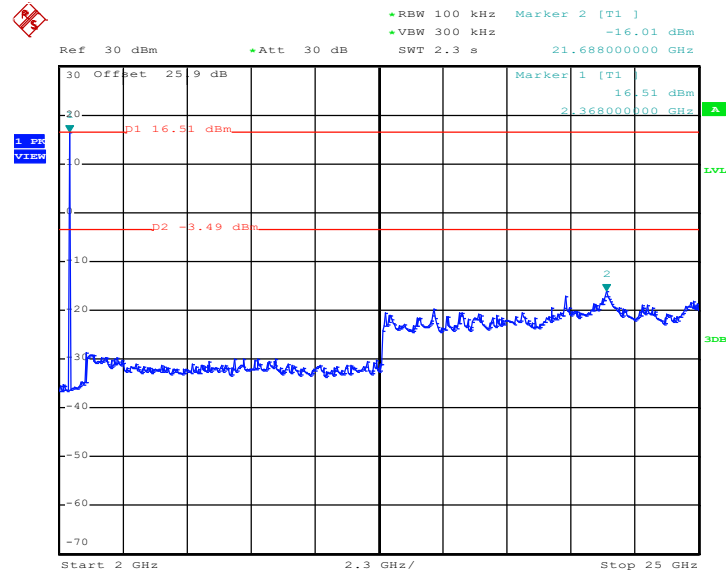

Date: 24.MAY.2020 22:50:20



CSE Plot on Ch 39 between 30MHz ~ 3 GHz

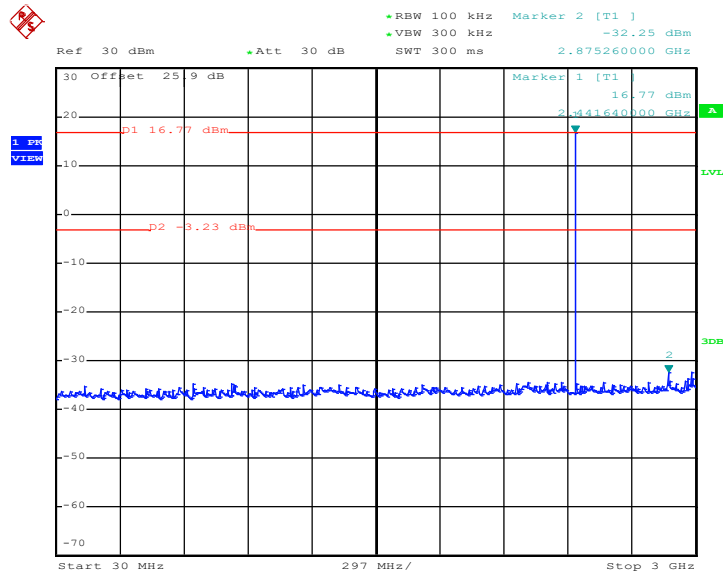

Date: 24.MAY.2020 22:55:33

CSE Plot on Ch 39 between 2 GHz ~ 25 GHz

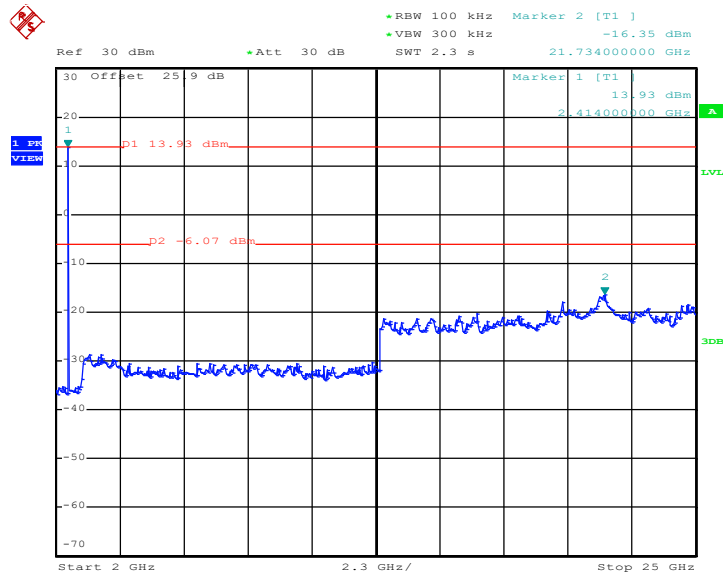

Date: 24.MAY.2020 22:56:08



CSE Plot on Ch 78 between 30MHz ~ 3 GHz

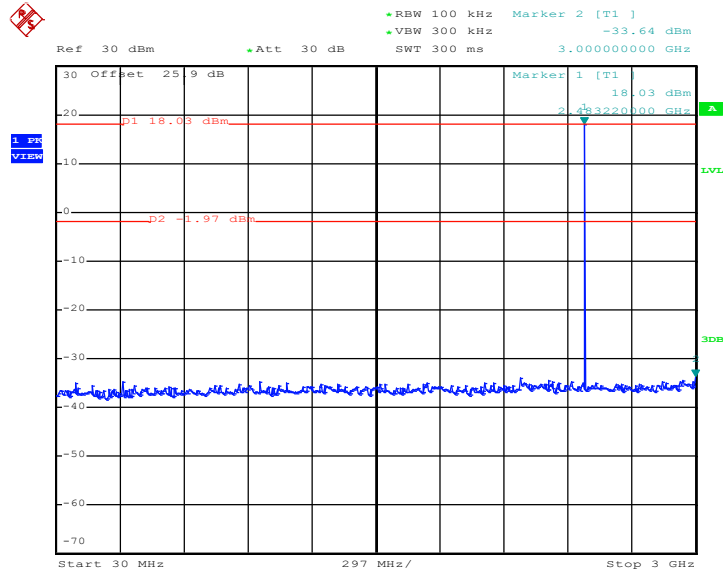

Date: 24.MAY.2020 23:01:23

CSE Plot on Ch 78 between 2 GHz ~ 25 GHz

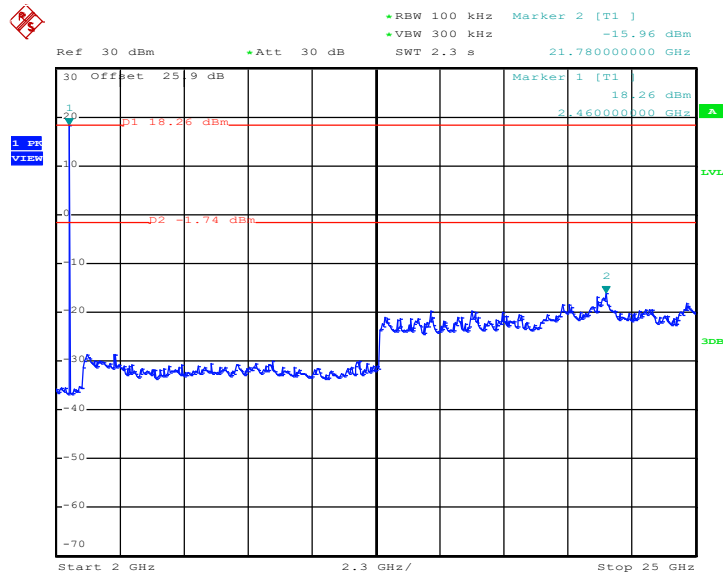

Date: 24.MAY.2020 23:01:57



<3Mbps>

CSE Plot on Ch 00 between 30MHz ~ 3 GHz

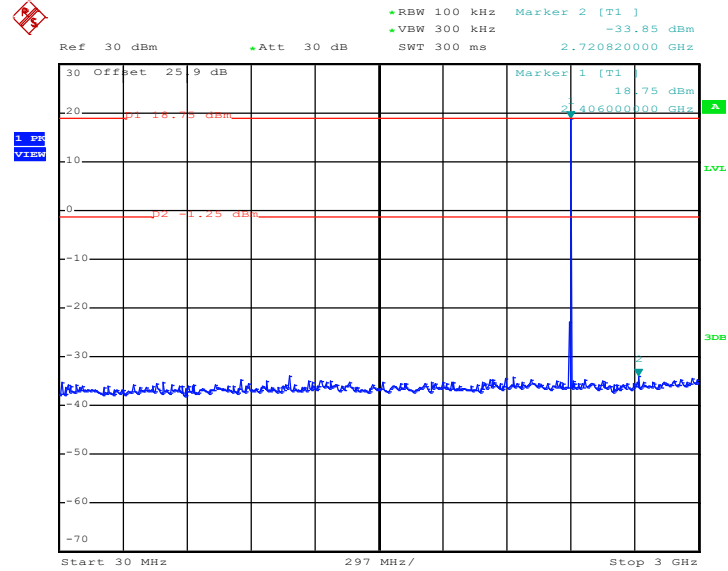

Date: 24.MAY.2020 22:51:11

CSE Plot on Ch 00 between 2 GHz ~ 25 GHz

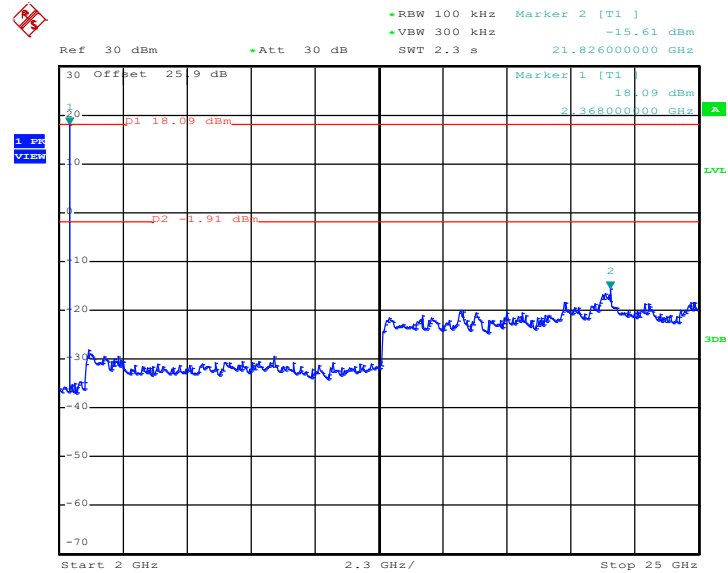

Date: 24.MAY.2020 22:51:40



CSE Plot on Ch 39 between 30MHz ~ 3 GHz

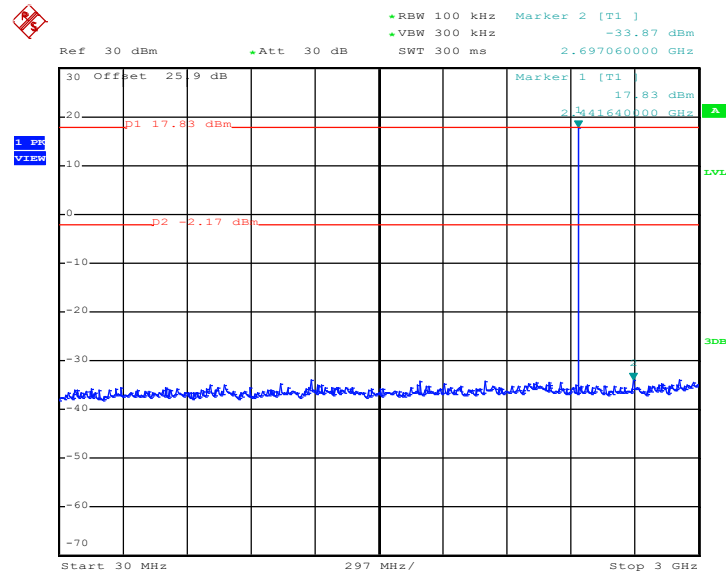

Date: 24.MAY.2020 22:58:05

CSE Plot on Ch 39 between 2 GHz ~ 25 GHz

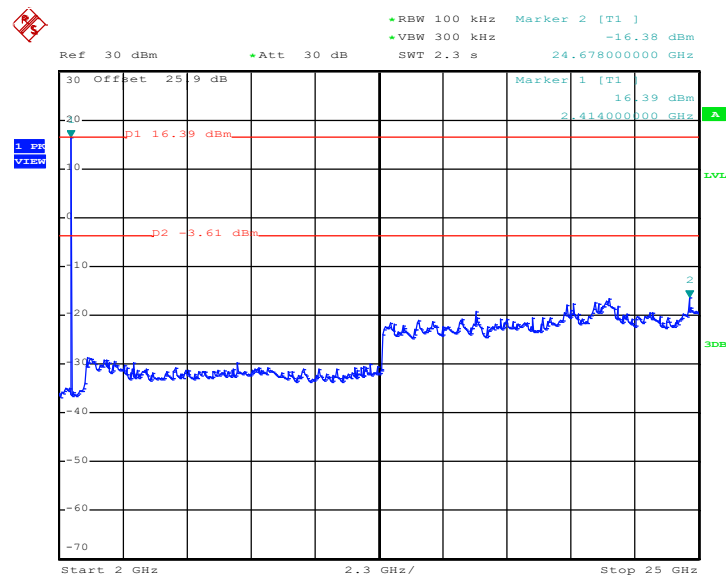

Date: 24.MAY.2020 22:58:37



CSE Plot on Ch 78 between 30MHz ~ 3 GHz

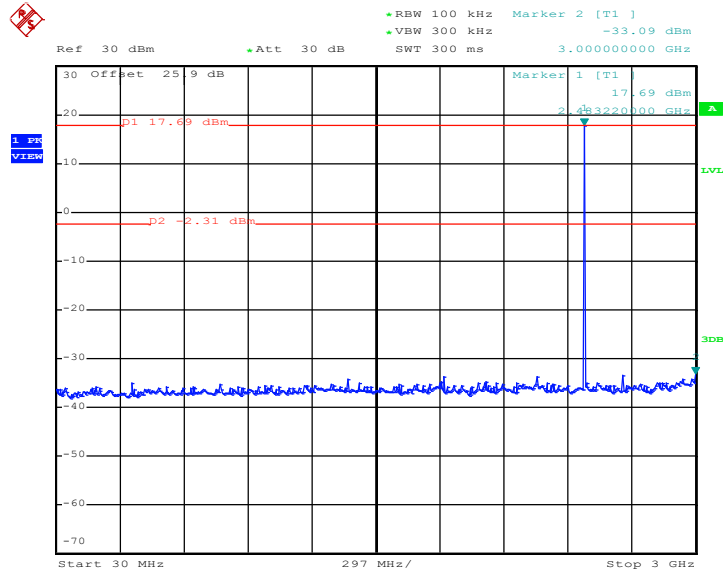

Date: 24.MAY.2020 23:03:54

CSE Plot on Ch 78 between 2 GHz ~ 25 GHz

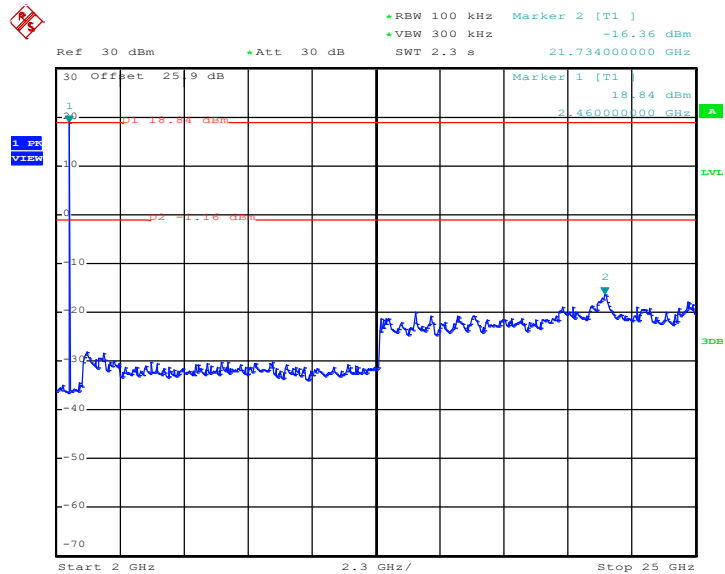

Date: 24.MAY.2020 23:04:34



3.8 Radiated Band Edges and Spurious Emission Measurement

3.8.1 Limit of Radiated Band Edges and Spurious Emission

In any 100 kHz bandwidth outside the intentional radiator frequency band, all harmonics/spurious must be at least 20 dB below the highest emission level within the authorized band. In addition, radiated emissions which fall in the restricted bands must also comply with the limits as below.

Frequency (MHz)	Field Strength (microvolts/meter)	Measurement Distance (meters)
0.009 – 0.490	2400/F(kHz)	300
0.490 – 1.705	24000/F(kHz)	30
1.705 – 30.0	30	30
30 – 88	100	3
88 – 216	150	3
216 - 960	200	3
Above 960	500	3

3.8.2 Measuring Instruments

See list of measuring equipment of this test report.



3.8.3 Test Procedures

1. The EUT was placed on a turntable with 0.8 meter for frequency below 1GHz and 1.5 meter for frequency above 1GHz respectively above ground.
2. The EUT was set 3 meters from the interference receiving antenna, which was mounted on the top of a variable height antenna tower.
3. For each suspected emission, the EUT was arranged to its worst case and then tune the Antenna tower (from 1 m to 4 m) and turntable (from 0 degree to 360 degrees) to find the maximum reading. A pre-amp and a high pass filter are used for the test in order to get better signal level to comply with the guidelines.
4. Set to the maximum power setting and enable the EUT transmit continuously.
5. Use the following spectrum analyzer settings:
 - (1) Span shall wide enough to fully capture the emission being measured;
 - (2) Set RBW=100 kHz for $f < 1$ GHz, RBW=1MHz for $f > 1$ GHz ; VBW \geq RBW; Sweep = auto; Detector function = peak; Trace = max hold for peak
 - (3) For average measurement: use duty cycle correction factor method per 15.35(c).
Duty cycle = On time/100 milliseconds
On time = $N_1 * L_1 + N_2 * L_2 + \dots + N_{n-1} * L_{n-1} + N_n * L_n$
Where N_1 is number of type 1 pulses, L_1 is length of type 1 pulses, etc.
Average Emission Level = Peak Emission Level + $20 * \log(\text{Duty cycle})$
6. Corrected Reading: Antenna Factor + Cable Loss + Read Level - Preamp Factor = Level
7. For testing below 1GHz, if the emission level of the EUT in peak mode was 3 dB lower than the limit specified, then peak values of EUT will be reported, otherwise, the emissions will be repeated one by one using the CISPR quasi-peak method and reported.
8. For testing above 1GHz, the emission level of the EUT in peak mode was 20dB lower than average limit (that means the emission level in average mode also complies with the limit in average mode), then peak values of EUT will be reported, otherwise, the emissions will be measured in average mode again and reported.

Note: The average levels were calculated from the peak level corrected with duty cycle correction factor (-24.76dB) derived from $20 \log(\text{dwell time}/100\text{ms})$. This correction is only for signals that hop with the fundamental signal, such as band-edge and harmonic. Other spurious signals that are independent of the hopping signal would not use this correction.

3.8.4 Test Setup

For radiated emissions below 30MHz

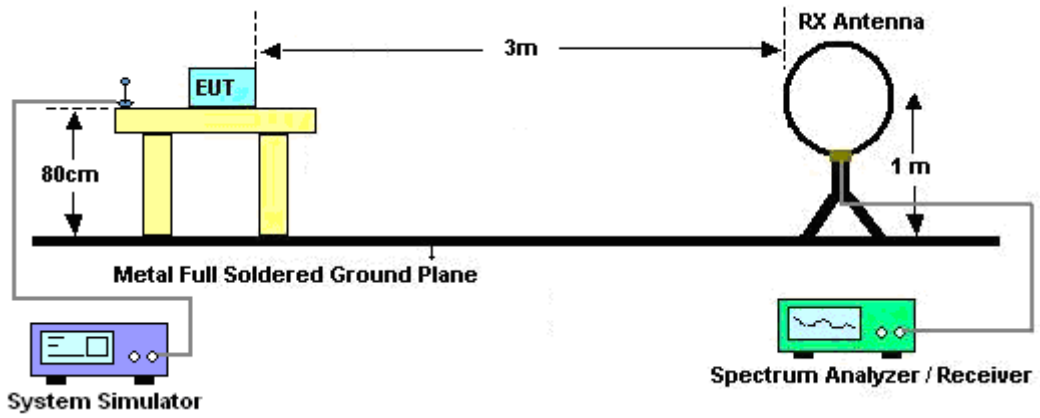

For radiated emissions from 30MHz to 1GHz

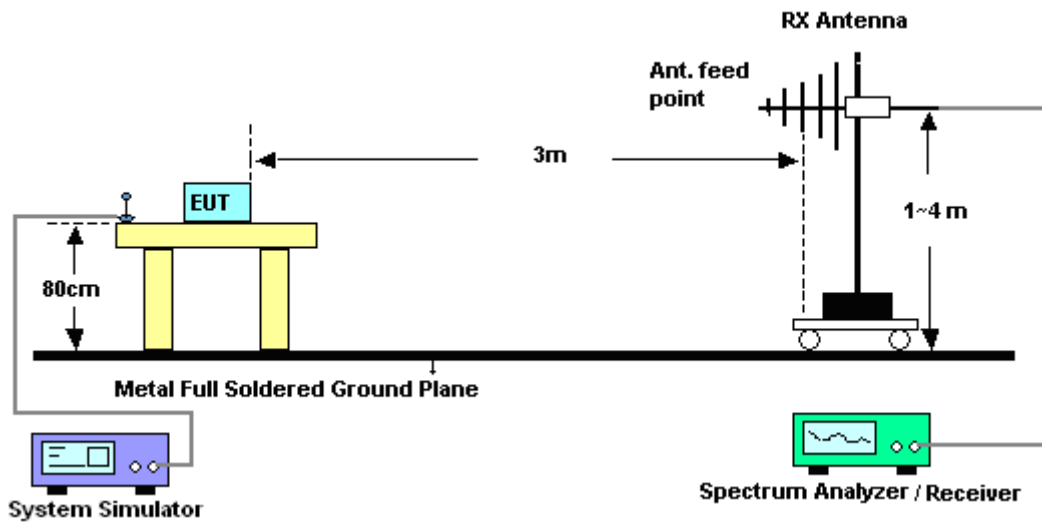

For radiated emissions above 1GHz

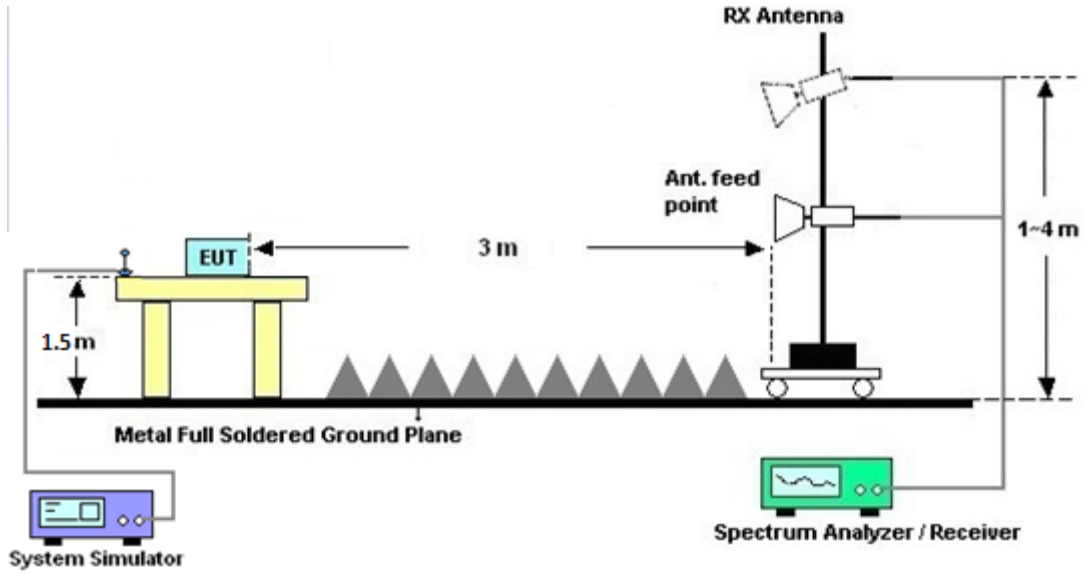

For radiated emissions above 18GHz

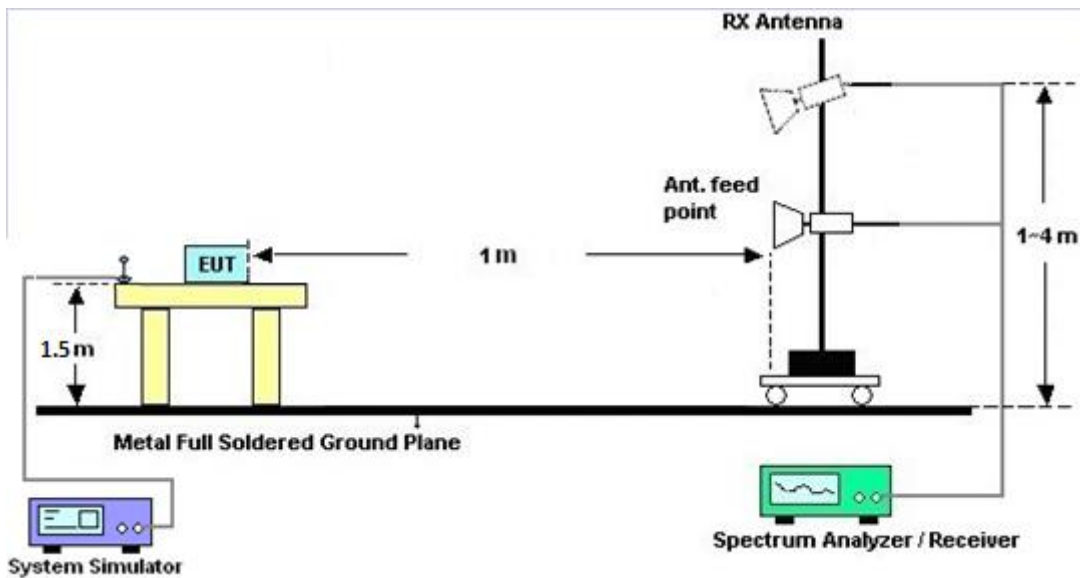



3.8.5 Test Results of Radiated Spurious Emissions (9 kHz ~ 30 MHz)

The low frequency, which started from 9 kHz to 30MHz, was pre-scanned and the result which was 20dB lower than the limit line was not reported.

There is a comparison data of both open-field test site and alternative test site - semi-Anechoic chamber according to 414788 D01 Radiated Test Site v01r01, and the result came out very similar.

3.8.6 Test Result of Radiated Spurious at Band Edges

Please refer to Appendix C and D.

3.8.7 Duty Cycle

Please refer to Appendix E.

3.8.8 Test Result of Radiated Spurious Emission (30MHz ~ 10th Harmonic)

Please refer to Appendix C and D.



3.9 AC Conducted Emission Measurement

3.9.1 Limit of AC Conducted Emission

For equipment that is designed to be connected to the public utility (AC) power line, the radio frequency voltage that is conducted back onto the AC power line on any frequency or frequencies within the band 150 kHz to 30 MHz shall not exceed the limits in the following table.

Frequency of emission (MHz)	Conducted limit (dB μ V)	
	Quasi-peak	Average
0.15-0.5	66 to 56*	56 to 46*
0.5-5	56	46
5-30	60	50

*Decreases with the logarithm of the frequency.

3.9.2 Measuring Instruments

See list of measuring equipment of this test report.

3.9.3 Test Procedures

1. The EUT was placed 0.4 meter from the conducting wall of the shielding room was kept at least 80 centimeters from any other grounded conducting surface.
2. Connect EUT to the power mains through a line impedance stabilization network (LISN).
3. All the support units are connecting to the other LISN.
4. The LISN provides 50 ohm coupling impedance for the measuring instrument.
5. The FCC states that a 50 ohm, 50 microhenry LISN should be used.
6. Both sides of AC line were checked for maximum conducted interference.
7. The frequency range from 150 kHz to 30 MHz was searched.
8. Set the test-receiver system to Peak Detect Function and specified bandwidth (IF Bandwidth = 9kHz) with Maximum Hold Mode. Then measurement is also conducted by Average Detector and Quasi-Peak Detector Function respectively.

3.9.4 Test Setup

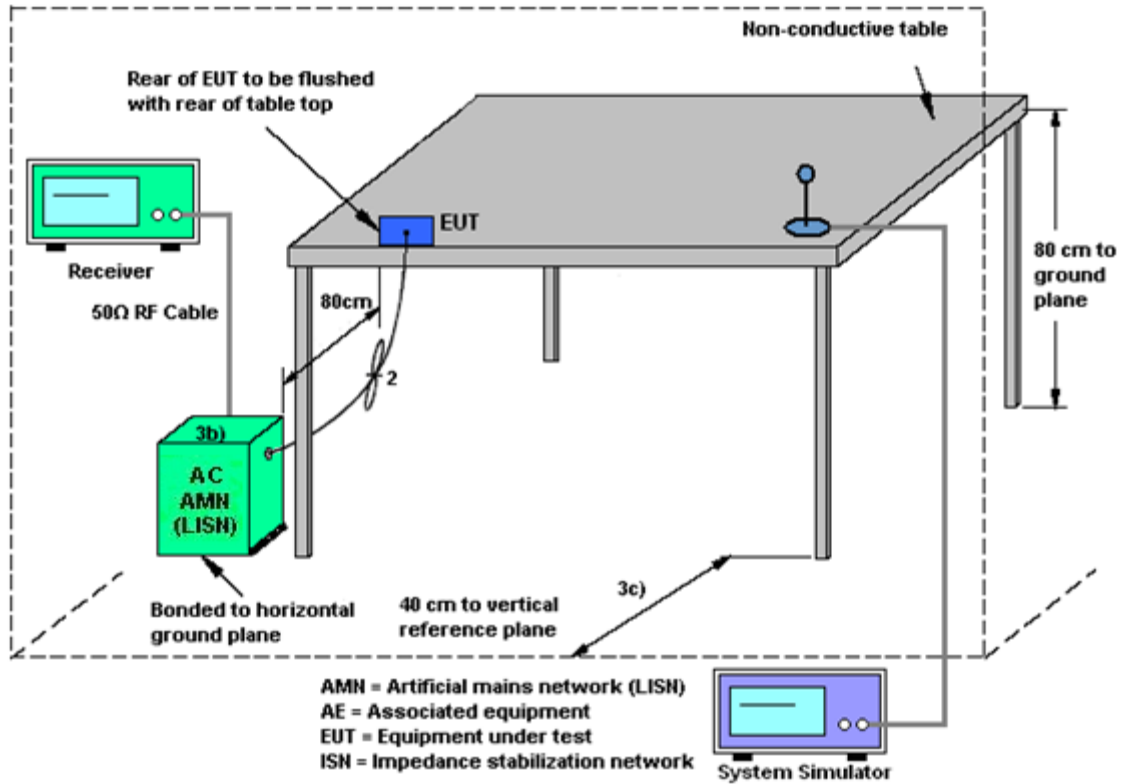

3.9.5 Test Result of AC Conducted Emission

Please refer to Appendix B.



3.10 Antenna Requirements

3.10.1 Standard Applicable

If directional gain of transmitting antennas is greater than 6dBi, the power shall be reduced by the same level in dB comparing to gain minus 6dBi. The use of a permanently attached antenna or of an antenna that uses a unique coupling to the intentional radiator shall be considered sufficient to comply with the rule.

3.10.2 Antenna Anti-Replacement Construction

An embedded-in antenna design is used.

3.10.3 Antenna Gain

The antenna peak gain of EUT is less than 6 dBi. Therefore, it is not necessary to reduce maximum peak output power limit.



4 List of Measuring Equipment

Instrument	Manufacturer	Model No.	Serial No.	Characteristics	Calibration Date	Test Date	Due Date	Remark
Amplifier	SONOMA	310N	187312	9kHz~1GHz	Dec. 03, 2019	May 06, 2020~ Jul. 04, 2020	Dec. 02, 2020	Radiation (03CH11-HY)
Bilog Antenna	TESEQ	CBL 6111D & N-6-06	35414 & AT-N0602	30MHz~1GHz	Oct. 12, 2019	May 06, 2020~ Jul. 04, 2020	Oct. 11, 2020	Radiation (03CH11-HY)
Horn Antenna	SCHWARZBE CK	BBHA 9120 D	9120D-132 6	1GHz~18GHz	Nov. 04, 2019	May 06, 2020~ Jul. 04, 2020	Nov. 03, 2020	Radiation (03CH11-HY)
Hygrometer	TECPEL	DTN-303B	TP140325	N/A	Nov. 07, 2019	May 06, 2020~ Jul. 04, 2020	Nov. 06, 2020	Radiation (03CH11-HY)
Loop Antenna	Rohde & Schwarz	HFH2-Z2	100488	9 kHz~30 MHz	Jan. 09, 2020	May 06, 2020~ Jul. 04, 2020	Jan. 08, 2021	Radiation (03CH11-HY)
Preamplifier	Keysight	83017A	MY532700 80	1GHz~26.5GHz	Nov. 14, 2018	May 06, 2020~ Jul. 04, 2020	Nov. 13, 2020	Radiation (03CH11-HY)
Spectrum Analyzer	Keysight	N9010A	MY542004 86	10Hz~44GHz	Oct. 28, 2019	May 06, 2020~ Jul. 04, 2020	Oct. 27, 2020	Radiation (03CH11-HY)
Filter	Wainwright	WHKX12-270 0-3000-18000 -60SS	SN3	3GHz High Pass Filter	Sep. 15, 2019	May 06, 2020~ Jul. 04, 2020	Sep. 14, 2020	Radiation (03CH11-HY)
Filter	Wainwright	WLK4-1000-1 530-8000-40S S	SN11	1.53GHz Low Pass Filter	Sep. 15, 2019	May 06, 2020~ Jul. 04, 2020	Sep. 14, 2020	Radiation (03CH11-HY)
RF Cable	HUBER + SUHNER	SUCOFLEX 104	MY9837/4 PE	9kHz~30MHz	Mar. 12, 2020	May 06, 2020~ Jul. 04, 2020	Mar. 11, 2021	Radiation (03CH11-HY)
RF Cable	HUBER + SUHNER	SUCOFLEX 102	MY2859/2	30MHz~40GHz	Mar. 12, 2020	May 06, 2020~ Jul. 04, 2020	Mar. 11, 2021	Radiation (03CH11-HY)
RF Cable	HUBER + SUHNER	SUCOFLEX 104	MY9837/4 PE	30MHz~18GHz	Mar. 12, 2020	May 06, 2020~ Jul. 04, 2020	Mar. 11, 2021	Radiation (03CH11-HY)
RF Cable	HUBER + SUHNER	SUCOFLEX 102	MY4274/2	30MHz~40GHz	Mar. 12, 2020	May 06, 2020~ Jul. 04, 2020	Mar. 11, 2021	Radiation (03CH11-HY)
RF Cable	HUBER + SUHNER	SUCOFLEX 104	MY11681/ 4PE	30MHz~18GHz	Mar. 12, 2020	May 06, 2020~ Jul. 04, 2020	Mar. 11, 2021	Radiation (03CH11-HY)
Controller	EMEC	EM 1000	N/A	Control Turn table & Ant Mast	N/A	May 06, 2020~ Jul. 04, 2020	N/A	Radiation (03CH11-HY)
Antenna Mast	EMEC	AM-BS-4500- B	N/A	1~4m	N/A	May 06, 2020~ Jul. 04, 2020	N/A	Radiation (03CH11-HY)
Turn Table	EMEC	TT 2000	N/A	0~360 Degree	N/A	May 06, 2020~ Jul. 04, 2020	N/A	Radiation (03CH11-HY)
Preamplifier	Jet-Power	JPA0118-55-3 03K	171000180 0054002	1GHz~18GHz	Aug. 06, 2019	May 06, 2020~ Jul. 04, 2020	Aug. 05, 2020	Radiation (03CH11-HY)
Preamplifier	EMEC	EM18G40G	060715	18GHz~40GHz	Dec. 13, 2019	May 06, 2020~ Jul. 04, 2020	Dec. 12, 2020	Radiation (03CH11-HY)
SHF-EHF Horn Antenna	SCHWARZBE CK	BBHA9170	BBHA9170 980	18GHz-40GHz	N/A	May 06, 2020~ Jul. 04, 2020	N/A	Radiation (03CH11-HY)



Instrument	Manufacturer	Model No.	Serial No.	Characteristics	Calibration Date	Test Date	Due Date	Remark
Hygrometer	Testo	608-H2	41410069	N/A	Jun. 17, 2019	Apr. 28, 2020~ May 24, 2020	Jun. 16, 2020	Conducted (TH05-HY)
Power Meter	Agilent	E4416A	GB412923 44	N/A	Dec. 27, 2019	Apr. 28, 2020~ May 24, 2020	Dec. 26, 2020	Conducted (TH05-HY)
Power Sensor	Agilent	E9327A	US404415 48	50MHz~18GHz	Dec. 27, 2019	Apr. 28, 2020~ May 24, 2020	Dec. 26, 2020	Conducted (TH05-HY)
Spectrum Analyzer	Rohde & Schwarz	FSP40	100055	9kHz-40GHz	Aug. 14, 2019	Apr. 28, 2020~ May 24, 2020	Aug. 13, 2020	Conducted (TH05-HY)
Switch Box & RF Cable	Burgeon	ETF-058	EC130048 4	N/A	Aug. 22, 2019	Apr. 28, 2020~ May 24, 2020	Aug. 21, 2020	Conducted (TH05-HY)
AC Power Source	ChainTek	APC-1000W	N/A	N/A	N/A	Jun. 24, 2020	N/A	Conduction (CO05-HY)
EMI Test Receiver	Rohde & Schwarz	ESR3	102388	9kHz~3.6GHz	Nov. 15, 2019	Jun. 24, 2020	Nov. 14, 2020	Conduction (CO05-HY)
Hygrometer	Testo	608-H1	34913912	N/A	Nov. 07, 2019	Jun. 24, 2020	Nov. 06, 2020	Conduction (CO05-HY)
LISN	Rohde & Schwarz	ENV216	100080	9kHz~30MHz	Nov. 20, 2019	Jun. 24, 2020	Nov. 19, 2020	Conduction (CO05-HY)
LISN	Rohde & Schwarz	ENV216	100081	9kHz~30MHz	Nov. 15, 2019	Jun. 24, 2020	Nov. 14, 2020	Conduction (CO05-HY)
Software	Rohde & Schwarz	EMC32 V10.30	N/A	N/A	N/A	Jun. 24, 2020	N/A	Conduction (CO05-HY)
LF Cable	HUBER + SUHNER	RG-214/U	LF01	N/A	Jan. 02, 2020	Jun. 24, 2020	Jan. 01, 2021	Conduction (CO05-HY)
Pulse Limiter	Rohde & Schwarz	ESH3-Z2	100851	N/A	Jan. 02, 2020	Jun. 24, 2020	Jan. 01, 2021	Conduction (CO05-HY)



5 Uncertainty of Evaluation

Uncertainty of Conducted Emission Measurement (150 kHz ~ 30 MHz)

Measuring Uncertainty for a Level of Confidence of 95% ($U = 2Uc(y)$)	2.3
-------------------------------------------------------------------------	-----

Uncertainty of Radiated Emission Measurement (30 MHz ~ 1000 MHz)

Measuring Uncertainty for a Level of Confidence of 95% ($U = 2Uc(y)$)	5.2
-------------------------------------------------------------------------	-----

Uncertainty of Radiated Emission Measurement (1000 MHz ~ 18000 MHz)

Measuring Uncertainty for a Level of Confidence of 95% ($U = 2Uc(y)$)	5.2
-------------------------------------------------------------------------	-----

Uncertainty of Radiated Emission Measurement (18000 MHz ~ 40000 MHz)

Measuring Uncertainty for a Level of Confidence of 95% ($U = 2Uc(y)$)	5.3
-------------------------------------------------------------------------	-----

Appendix A. Test Result of Conducted Test Items

Test Engineer:	Hank Hsu	Temperature:	21~25	°C
Test Date:	2020/4/28~5/24	Relative Humidity:	51~54	%

TEST RESULTS DATA									
20dB and 99% Occupied Bandwidth and Hopping Channel Separation									
Mod.	Data Rate	NTX	CH.	Freq. (MHz)	20db BW (MHz)	99% Bandwidth (MHz)	Hopping Channel Separation Measurement (MHz)	Hopping Channel Separation Limit (MHz)	Pass/Fail
DH	1Mbps	1	0	2402	0.892	0.824	1.032	0.5947	Pass
DH	1Mbps	1	39	2441	0.892	0.820	0.846	0.5947	Pass
DH	1Mbps	1	78	2480	0.892	0.820	0.870	0.5947	Pass
2DH	2Mbps	1	0	2402	1.260	1.164	1.002	0.8400	Pass
2DH	2Mbps	1	39	2441	1.266	1.164	1.002	0.8440	Pass
2DH	2Mbps	1	78	2480	1.266	1.168	1.008	0.8440	Pass
3DH	3Mbps	1	0	2402	1.230	1.148	1.002	0.8200	Pass
3DH	3Mbps	1	39	2441	1.230	1.144	1.002	0.8200	Pass
3DH	3Mbps	1	78	2480	1.230	1.148	1.014	0.8200	Pass

TEST RESULTS DATA						
Dwell Time						
Mod.	Hopping Channel Number Rate	Hops Over Occupancy Time(hops)	Package Transfer Time (msec)	Dwell Time (sec)	Limits (sec)	Pass/Fail
Nomal	79	106.67	2.90	0.31	0.4	Pass
AFH	20	53.33	2.90	0.15	0.4	Pass

TEST RESULTS DATA					
Peak Power Table					
DH	CH.	NTX	Peak Power (dBm)	Power Limit (dBm)	Test Result
DH1	0	1	19.06	20.97	Pass
	39	1	18.96	20.97	Pass
	78	1	18.73	20.97	Pass
2DH1	0	1	20.92	20.97	Pass
	39	1	20.47	20.97	Pass
	78	1	20.93	20.97	Pass
3DH1	0	1	20.87	20.97	Pass
	39	1	20.64	20.97	Pass
	78	1	20.93	20.97	Pass

TEST RESULTS DATA				
Average Power Table				
(Reporting Only)				
DH	CH.	NTX	Average Power (dBm)	Duty Factor (dB)
DH1	0	1	18.74	5.21
	39	1	18.63	5.21
	78	1	18.18	5.21
2DH1	0	1	18.97	5.16
	39	1	19.06	5.16
	78	1	18.90	5.16
3DH1	0	1	19.01	5.16
	39	1	19.14	5.16
	78	1	18.94	5.16

TEST RESULTS DATA			
Number of Hopping Frequency			
Number of Hopping (Channel)	Adaptive Frequency Hopping (Channel)	Limits (Channel)	Pass/Fail
79	20	> 15	Pass



Appendix B. AC Conducted Emission Test Results

Test Engineer :	Tom Lee	Temperature :	23~25°C
		Relative Humidity :	42~50%

EUT Information

Test Mode : Mode 1
 Test Voltage : 120Vac/60Hz
 Phase : Line

Full Spectrum

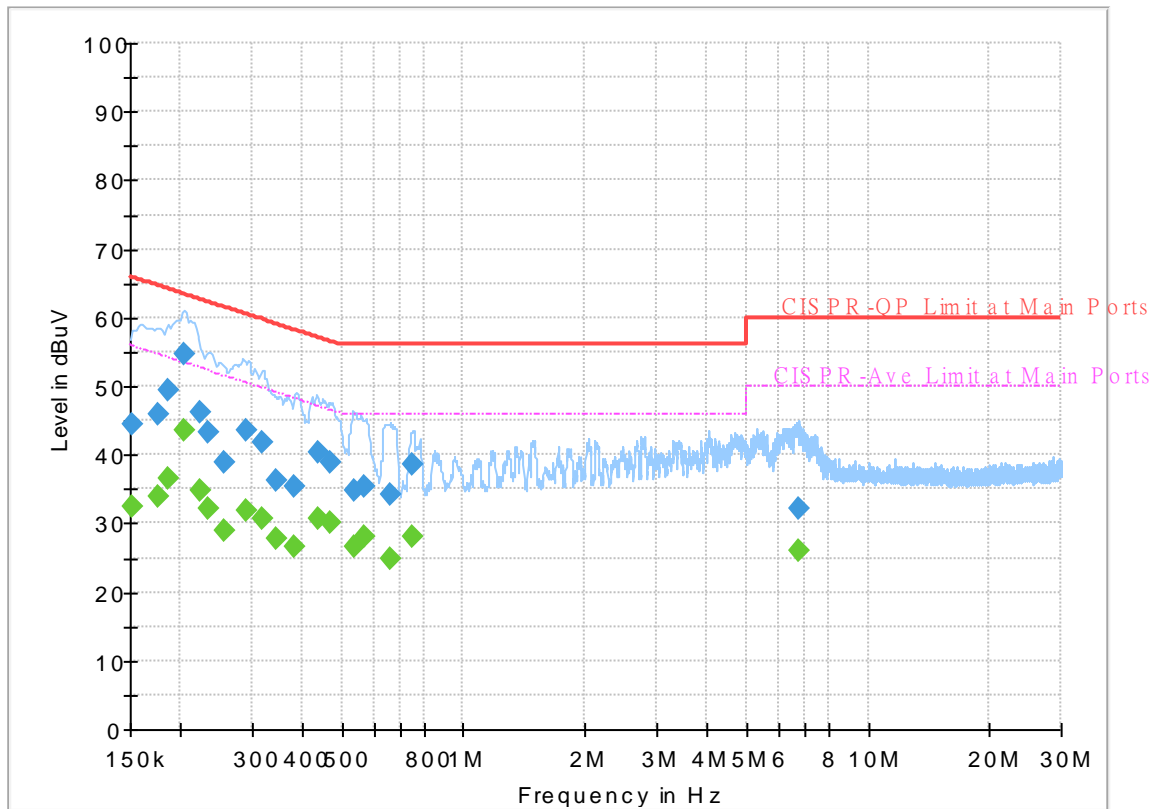

Final_Result

Frequency (MHz)	QuasiPeak (dBuV)	CAverage (dBuV)	Limit (dBuV)	Margin (dB)	Line	Filter	Corr. (dB)
0.152250	---	32.36	55.88	23.52	L1	OFF	19.6
0.152250	44.48	---	65.88	21.40	L1	OFF	19.6
0.175110	---	33.80	54.71	20.91	L1	OFF	19.6
0.175110	45.84	---	64.71	18.87	L1	OFF	19.6
0.186000	---	36.60	54.21	17.61	L1	OFF	19.6
0.186000	49.42	---	64.21	14.79	L1	OFF	19.6
0.203910	---	43.63	53.45	9.82	L1	OFF	19.6
0.203910	54.70	---	63.45	8.75	L1	OFF	19.6
0.224250	---	34.90	52.66	17.76	L1	OFF	19.6
0.224250	46.26	---	62.66	16.40	L1	OFF	19.6
0.234960	---	32.19	52.27	20.08	L1	OFF	19.6
0.234960	43.20	---	62.27	19.07	L1	OFF	19.6
0.255300	---	28.98	51.58	22.60	L1	OFF	19.6
0.255300	38.80	---	61.58	22.78	L1	OFF	19.6
0.289500	---	31.80	50.54	18.74	L1	OFF	19.6
0.289500	43.52	---	60.54	17.02	L1	OFF	19.6
0.319290	---	30.74	49.73	18.99	L1	OFF	19.6
0.319290	41.92	---	59.73	17.81	L1	OFF	19.6
0.344670	---	27.67	49.09	21.42	L1	OFF	19.6
0.344670	36.30	---	59.09	22.79	L1	OFF	19.6
0.381750	---	26.64	48.24	21.60	L1	OFF	19.6

0.381750	35.28	---	58.24	22.96	L1	OFF	19.6
0.435570	---	30.66	47.15	16.49	L1	OFF	19.6
0.435570	40.37	---	57.15	16.78	L1	OFF	19.6
0.470310	---	30.11	46.51	16.40	L1	OFF	19.6
0.470310	38.86	---	56.51	17.65	L1	OFF	19.6
0.537000	---	26.62	46.00	19.38	L1	OFF	19.6
0.537000	34.72	---	56.00	21.28	L1	OFF	19.6
0.571110	---	27.94	46.00	18.06	L1	OFF	19.6
0.571110	35.46	---	56.00	20.54	L1	OFF	19.6
0.662910	---	24.83	46.00	21.17	L1	OFF	19.6
0.662910	34.19	---	56.00	21.81	L1	OFF	19.6
0.750210	---	27.95	46.00	18.05	L1	OFF	19.6
0.750210	38.68	---	56.00	17.32	L1	OFF	19.6
6.726660	---	25.95	50.00	24.05	L1	OFF	19.9
6.726660	32.20	---	60.00	27.80	L1	OFF	19.9

EUT Information

Test Mode : Mode 1
 Test Voltage : 120Vac/60Hz
 Phase : Neutral

Full Spectrum

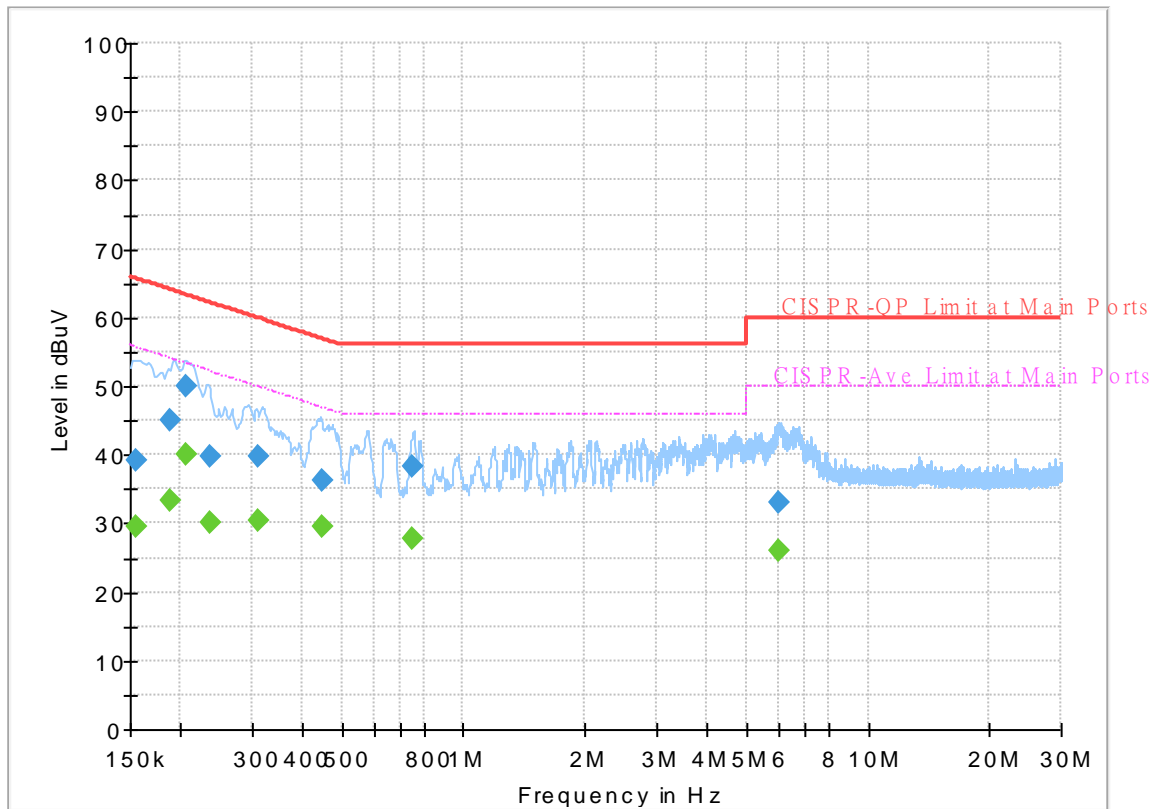

Final_Result

Frequency (MHz)	QuasiPeak (dBuV)	CAverage (dBuV)	Limit (dBuV)	Margin (dB)	Line	Filter	Corr. (dB)
0.154500	39.22	---	65.75	26.53	N	OFF	19.5
0.154500	---	29.55	55.75	26.20	N	OFF	19.5
0.189330	44.92	---	64.07	19.15	N	OFF	19.5
0.189330	---	33.35	54.07	20.72	N	OFF	19.5
0.206070	49.94	---	63.36	13.42	N	OFF	19.5
0.206070	---	40.08	53.36	13.28	N	OFF	19.5
0.235410	39.71	---	62.26	22.55	N	OFF	19.5
0.235410	---	30.11	52.26	22.15	N	OFF	19.5
0.312000	39.72	---	59.92	20.20	N	OFF	19.5
0.312000	---	30.29	49.92	19.63	N	OFF	19.5
0.449250	36.25	---	56.89	20.64	N	OFF	19.5
0.449250	---	29.50	46.89	17.39	N	OFF	19.5
0.750750	38.44	---	56.00	17.56	N	OFF	19.5
0.750750	---	27.90	46.00	18.10	N	OFF	19.5
6.047340	33.16	---	60.00	26.84	N	OFF	19.7
6.047340	---	26.01	50.00	23.99	N	OFF	19.7



Appendix C. Radiated Spurious Emission

Test Engineer :	Cookie Ku, Fu Chen and Troye Hsieh	Temperature :	19.6~21.6°C
		Relative Humidity :	64.1~69.1%

2.4GHz 2400~2483.5MHz

BT (Band Edge @ 3m)

BT	Note	Frequency	Level	Over	Limit	Read	Antenna	Path	Preamp	Ant	Table	Peak	Pol.
		(MHz)	(dBμV/m)	(dB)	Limit	Level	Factor	Loss	Factor	Pos	Pos	Avg.	
					Line	(dBμV)	(dB/m)	(dB)	(dB)	(cm)	(deg)	(P/A)	(H/V)
BT CH00 2402MHz		2311.26	43.87	-30.13	74	42.83	27.68	6.61	33.25	365	146	P	H
		2311.26	19.11	-34.89	54	-	-	-	-	-	-	A	H
	*	2402	106	-	-	105.03	27.5	6.7	33.23	365	146	P	H
		2402	81.24	27.24	54	-	-	-	-	-	-	A	H
													H
		2386.965	43.66	-30.34	74	42.67	27.53	6.69	33.23	106	61	P	V
		2386.965	18.9	-35.1	54	-	-	-	-	-	-	A	V
	*	2402	109.94	-	-	108.97	27.5	6.7	33.23	106	61	P	V
		2402	85.18	31.18	54	-	-	-	-	-	-	A	V
BT CH 39 2441MHz		2339.68	44.23	-29.77	74	43.22	27.62	6.64	33.25	385	131	P	H
		2339.68	19.47	-34.53	54	-	-	-	-	-	-	A	H
	*	2441	106.69	-	-	105.74	27.42	6.75	33.22	385	131	P	H
		2441	81.93	27.93	54	-	-	-	-	-	-	A	H
		2483.83	42.74	-31.26	74	41.9	27.26	6.79	33.21	385	131	P	H
		2483.83	17.98	-36.02	54	-	-	-	-	-	-	A	H
		2341.5	44.13	-29.87	74	43.11	27.62	6.64	33.24	106	60	P	V
		2341.5	19.37	-34.63	54	-	-	-	-	-	-	A	V
	*	2441	110.51	-	-	109.56	27.42	6.75	33.22	106	60	P	V
		2441	85.75	31.75	54	-	-	-	-	-	-	A	V
		2488.1	43.34	-30.66	74	42.5	27.25	6.8	33.21	106	60	P	V
		2488.1	18.58	-35.42	54	-	-	-	-	-	-	A	V



BT CH 78 2480MHz	*	2480	104.05	-	-	103.19	27.28	6.79	33.21	268	143	P	H
		2480	79.29	25.29	54	-	-	-	-	-	-	A	H
		2483.56	51.58	-22.42	74	50.73	27.27	6.79	33.21	268	143	P	H
		2483.56	26.82	-27.18	54	-	-	-	-	-	-	A	H
													H
													H
	*	2480	110.04	-	-	109.18	27.28	6.79	33.21	117	58	P	V
		2480	85.28	31.28	54	-	-	-	-	-	-	A	V
		2483.52	57.15	-16.85	74	56.3	27.27	6.79	33.21	117	58	P	V
		2483.52	32.39	-21.61	54	-	-	-	-	-	-	A	V
													V
													V
Remark	<ol style="list-style-type: none"> 1. No other spurious found. 2. All results are PASS against Peak and Average limit line. 												



2.4GHz 2400~2483.5MHz

BT (Harmonic @ 3m)

BT	Note	Frequency	Level	Over	Limit	Read	Antenna	Path	Preamp	Ant	Table	Peak	Pol.	
		(MHz)	(dBμV/m)	(dB)	Limit	Level	Factor	Loss	Factor	Pos	Pos	Avg.		
		(MHz)	(dBμV/m)	(dB)	(dBμV/m)	(dBμV)	(dB/m)	(dB)	(dB)	(cm)	(deg)	(P/A)	(H/V)	
BT CH 00 2402MHz		4804	44.92	-29.08	74	63.45	31	10.93	60.46	100	0	P	H	
		4804	20.16	-33.84	54	-	-	-	-	-	-	A	H	
													H	
													H	
		4804	44.61	-29.39	74	63.14	31	10.93	60.46	100	0	P	V	
		4804	19.85	-34.15	54	-	-	-	-	-	-	-	A	V
														V
														V
BT CH 39 2441MHz		4882	45.68	-28.32	74	64.1	31	10.97	60.39	100	0	P	H	
		4882	20.92	-33.08	54	-	-	-	-	-	-	A	H	
		7323	53.4	-20.6	74	62.66	36.5	13.35	59.11	100	0	P	H	
		7323	28.64	-25.36	54	-	-	-	-	-	-	A	H	
		4882	44.64	-29.36	74	63.06	31	10.97	60.39	100	0	P	V	
		4882	19.88	-34.12	54	-	-	-	-	-	-	A	V	
		7323	53.81	-20.19	74	63.07	36.5	13.35	59.11	100	0	P	V	
		7323	29.05	-24.95	54	-	-	-	-	-	-	-	A	V
BT CH 78 2480MHz		4960	43.88	-30.12	74	62.06	31.14	11.01	60.33	100	0	P	H	
		4960	19.12	-34.88	54	-	-	-	-	-	-	A	H	
		7440	50.43	-23.57	74	59.88	36.38	13.21	59.04	100	0	P	H	
		7440	25.67	-28.33	54	-	-	-	-	-	-	A	H	
		4960	43.54	-30.46	74	61.72	31.14	11.01	60.33	100	0	P	V	
		4960	18.78	-35.22	54	-	-	-	-	-	-	A	V	
		7440	49.45	-24.55	74	58.9	36.38	13.21	59.04	100	0	P	V	
		7440	24.69	-29.31	54	-	-	-	-	-	-	A	V	
Remark	1. No other spurious found. 2. All results are PASS against Peak and Average limit line.													



Emission above 18GHz

2.4GHz BT (SHF)

BT	Note	Frequency	Level	Over	Limit	Read	Antenna	Path	Preamp	Ant	Table	Peak	Pol.
		(MHz)	(dBμV/m)	(dB)	Line (dBμV/m)	Level (dBμV)	Factor (dB/m)	Loss (dB)	Factor (dB)	Pos (cm)	Pos (deg)	Avg. (P/A)	(H/V)
2.4GHz BT SHF		22536	41.34	-32.66	74	47.12	38.63	9.1	53.51	150	0	P	H
													H
													H
													H
													H
													H
													H
													H
													H
													H
													H
													H
													H
													H
													H
													H
													H
													H
													H
			18049	43.24	-30.76	74	52.68	37.62	6.99	54.05	150	0	P
													V
													V
													V
													V
													V
													V
													V
													V
													V
													V
													V
													V
													V
													V
Remark	1. No other spurious found. 2. All results are PASS against limit line.												



Emission below 1GHz

2.4GHz BT (LF)

BT	Note	Frequency	Level	Over	Limit	Read	Antenna	Path	Preamp	Ant	Table	Peak	Pol.	
		(MHz)	(dBμV/m)	(dB)	Limit Line (dBμV/m)	Level (dBμV)	Factor (dB/m)	Loss (dB)	Factor (dB)	Pos (cm)	Pos (deg)	Avg. (P/A)	(H/V)	
2.4GHz BT LF		30	25.7	-14.3	40	33.21	24.15	0.76	32.42	100	0	P	H	
		80.44	24.67	-15.33	40	42.61	13.2	1.3	32.44	-	-	P	H	
		160.95	27.05	-16.45	43.5	41.52	16.16	1.88	32.51	-	-	P	H	
		922.4	29.61	-16.39	46	27.67	29.01	4.36	31.43	-	-	P	H	
		944.71	30.18	-15.82	46	27.09	29.8	4.43	31.14	-	-	P	H	
		957.32	30.68	-15.32	46	26.69	30.51	4.45	30.97	-	-	P	H	
														H
														H
														H
														H
														H
														H
			33.88	29.01	-10.99	40	38.13	22.5	0.82	32.44	-	-	P	V
			39.7	32.38	-7.62	40	44.55	19.4	0.91	32.48	100	0	P	V
			205.57	28.27	-15.23	43.5	43.94	14.81	2.09	32.57	-	-	P	V
			719.67	30.3	-15.7	46	31.85	26.54	3.84	31.93	-	-	P	V
			909.79	30.24	-15.76	46	28.66	28.85	4.33	31.6	-	-	P	V
			950.53	30.75	-15.25	46	27.28	30.09	4.44	31.06	-	-	P	V
														V
													V	
													V	
													V	
													V	
													V	
Remark	3. No other spurious found. 4. All results are PASS against limit line.													



Note symbol

*	Fundamental Frequency which can be ignored. However, the level of any unwanted emissions shall not exceed the level of the fundamental frequency.
!	Test result is over limit line.
P/A	Peak or Average
H/V	Horizontal or Vertical



A calculation example for radiated spurious emission is shown as below:

BT	Note	Frequency (MHz)	Level (dBμV/m)	Over Limit (dB)	Limit Line (dBμV/m)	Read Level (dBμV)	Antenna Factor (dB/m)	Path Loss (dB)	Preamp Factor (dB)	Ant Pos (cm)	Table Pos (deg)	Peak Avg. (P/A)	Pol. (H/V)
BT CH 00 2402MHz		2390	55.45	-18.55	74	54.51	32.22	4.58	35.86	103	308	P	H
		2390	43.54	-10.46	54	42.6	32.22	4.58	35.86	103	308	A	H

1. Path Loss(dB) = Cable loss(dB) + Filter loss(dB) + Attenuator loss(dB)
2. Level(dBμV/m) =
Antenna Factor(dB/m) + Path Loss(dB) + Read Level(dBμV) - Preamp Factor(dB)
3. Over Limit(dB) = Level(dBμV/m) – Limit Line(dBμV/m)

For Peak Limit @ 2390MHz:

1. Level(dBμV/m)
= Antenna Factor(dB/m) + Path Loss(dB) + Read Level(dBμV) - Preamp Factor(dB)
= 32.22(dB/m) + 4.58(dB) + 54.51(dBμV) – 35.86 (dB)
= 55.45 (dBμV/m)
2. Over Limit(dB)
= Level(dBμV/m) – Limit Line(dBμV/m)
= 55.45(dBμV/m) – 74(dBμV/m)
= -18.55(dB)

For Average Limit @ 2390MHz:

1. Level(dBμV/m)
= Antenna Factor(dB/m) + Path Loss(dB) + Read Level(dBμV) - Preamp Factor(dB)
= 32.22(dB/m) + 4.58(dB) + 42.6(dBμV) – 35.86 (dB)
= 43.54 (dBμV/m)
2. Over Limit(dB)
= Level(dBμV/m) – Limit Line(dBμV/m)
= 43.54(dBμV/m) – 54(dBμV/m)
= -10.46(dB)

Both peak and average measured complies with the limit line, so test result is “PASS”.



Appendix D. Radiated Spurious Emission Plots

Test Engineer :	Cookie Ku, Fu Chen and Troye Hsieh	Temperature :	19.6~21.6°C
		Relative Humidity :	64.1~69.1%

2.4GHz 2400~2483.5MHz

BT (Band Edge @ 3m)

BT	2.4GHz 2400~2483.5MHz Band Edge @ 3m	
	BT CH00 2402MHz	
	Horizontal	Fundamental
Peak	<p> Site : 03CH11-1HY Condition : PEAK_BC_74 3m HORN 91200-HF HORIZONTAL : RBW:1000.000KHz VBW:3000.000KHz SWT:Auto Detector : Peak </p>	<p> Site : 03CH11-1HY Condition : PEAK_74 3m HORN 91200-HF HORIZONTAL : RBW:1000.000KHz VBW:3000.000KHz SWT:Auto Detector : Peak </p>

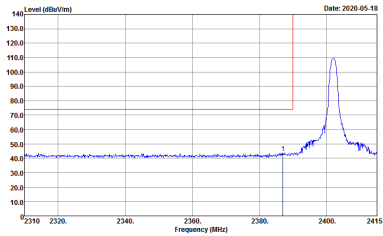
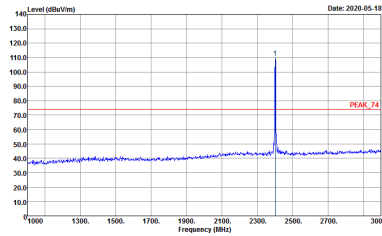

BT	2.4GHz 2400~2483.5MHz Band Edge @ 3m	
	BT CH00 2402MHz	
	Vertical	Fundamental
Peak	 <p>Site : 03CH11-HY Condition : PEAK_BC_74 3m HORN 91200-HF VERTICAL RBW:1000.000KHz VBW:3000.000KHz SWF:Auto Detector : Peak</p>	 <p>Site : 03CH11-HY Condition : PEAK_74 3m HORN 91200-HF VERTICAL RBW:1000.000KHz VBW:3000.000KHz SWT:Auto Detector : Peak</p>

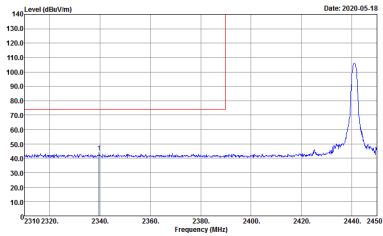
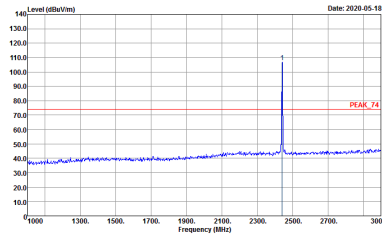
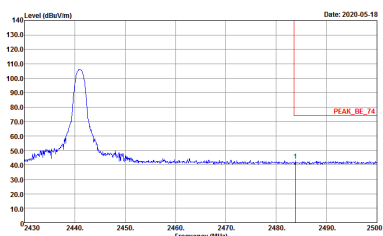

BT	2.4GHz 2400~2483.5MHz Band Edge @ 3m	
	BT CH39 2441MHz	
	Horizontal	Fundamental
Peak	 <p>Site : 03CH11-HY Condition : PEAK_BE_74 3m HORN 91200-HF HORIZONTAL : RBW:1000.000KHz VBW:3000.000KHz SWT:Auto Detector : Peak</p>	 <p>Site : 03CH11-HY Condition : PEAK_74 3m HORN 91200-HF HORIZONTAL : RBW:1000.000KHz VBW:3000.000KHz SWT:Auto Detector : Peak</p>
Peak	 <p>Site : 03CH11-HY Condition : PEAK_BE_74 3m HORN 91200-HF HORIZONTAL : RBW:1000.000KHz VBW:3000.000KHz SWT:Auto Detector : Peak</p>	Left blank



BT	2.4GHz 2400~2483.5MHz Band Edge @ 3m	
	BT CH39 2441MHz	
	Vertical	Fundamental
Peak	<p>Site : 03CH11-HY Condition : PEAK_BE_74 3m HORN 91200-HF VERTICAL : RBW:1000.000KHz VBW:3000.000KHz SWT:Auto Detector : Peak</p>	<p>Site : 03CH11-HY Condition : PEAK_74 3m HORN 91200-HF VERTICAL : RBW:1000.000KHz VBW:3000.000KHz SWT:Auto Detector : Peak</p>
Peak	<p>Site : 03CH11-HY Condition : PEAK_BE_74 3m HORN 91200-HF VERTICAL : RBW:1000.000KHz VBW:3000.000KHz SWT:Auto Detector : Peak</p>	Left blank

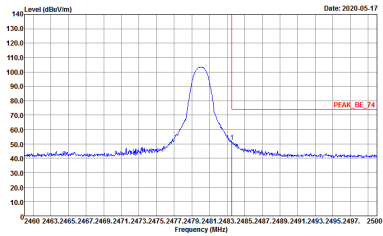
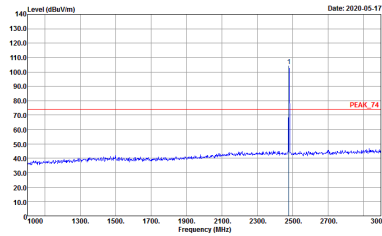

BT	2.4GHz 2400~2483.5MHz Band Edge @ 3m	
	BT CH78 2480MHz	
	Horizontal	Fundamental
Peak	 <p>Date: 2020-05-17</p> <p>Site : 03CH11-HY Condition : PEAK_BE_74 3m HORN 91200-HF HORIZONTAL RBW:1000.000kHz VBW:3000.000kHz SWT:Auto Detector : Peak</p>	 <p>Date: 2020-05-17</p> <p>Site : 03CH11-HY Condition : PEAK_74 3m HORN 91200-HF HORIZONTAL RBW:1000.000kHz VBW:3000.000kHz SWT:Auto Detector : Peak</p>



BT	2.4GHz 2400~2483.5MHz Band Edge @ 3m	
	BT CH78 2480MHz	
	Vertical	Fundamental
Peak	<p>Site : 03CH11-HY Condition : PEAK_BE_74 3m HORN 91200-HF VERTICAL RBW:1000.000KHz VBW:3000.000KHz SWF:Auto Detector : Peak</p>	<p>Site : 03CH11-HY Condition : PEAK_74 3m HORN 91200-HF VERTICAL RBW:1000.000KHz VBW:3000.000KHz SWT:Auto Detector : Peak</p>



2.4GHz 2400~2483.5MHz

BT (Harmonic @ 3m)

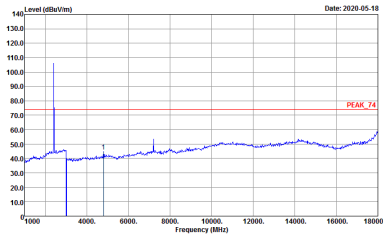
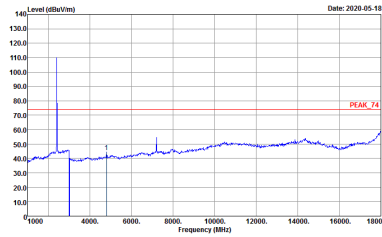
BT	2.4GHz 2400~2483.5MHz Harmonic @ 3m	
	BT CH00 2402MHz	
	Horizontal	Vertical
<p>Peak Avg.</p>	 <p>Site : 03CH11-1FY Condition : PEAK_74 3m HORN 91200-HF HORIZONTAL Detector : Peak</p>	 <p>Site : 03CH11-1FY Condition : PEAK_74 3m HORN 91200-HF VERTICAL Detector : Peak</p>

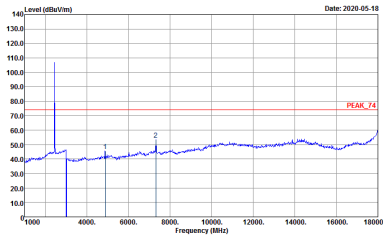
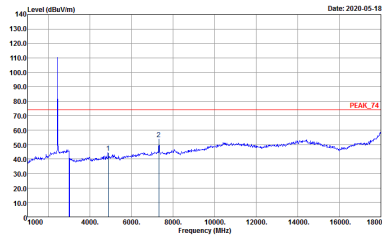

BT	2.4GHz 2400~2483.5MHz Harmonic @ 3m	
	BT CH39 2441MHz	
	Horizontal	Vertical
Peak Avg.	 <p>Site : 03CH11-HY Condition : PEAK_74 3m HORN 91200-HF HORIZONTAL Detector : Peak</p>	 <p>Site : 03CH11-HY Condition : PEAK_74 3m HORN 91200-HF VERTICAL Detector : Peak</p>

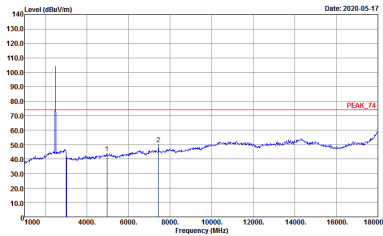
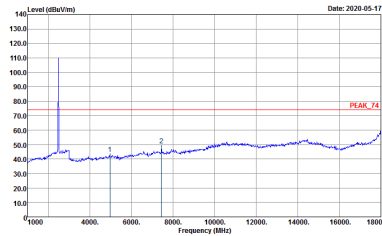

BT	2.4GHz 2400~2483.5MHz Harmonic @ 3m	
BT CH78 2480MHz		
	Horizontal	Vertical
Peak Avg.	 <p>Site : 03CH11-HY Condition : PEAK_74 3m HORN 91200-HF HORIZONTAL Detector : Peak</p>	 <p>Site : 03CH11-HY Condition : PEAK_74 3m HORN 91200-HF VERTICAL Detector : Peak</p>

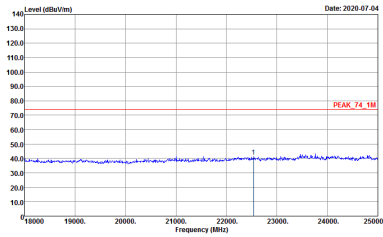
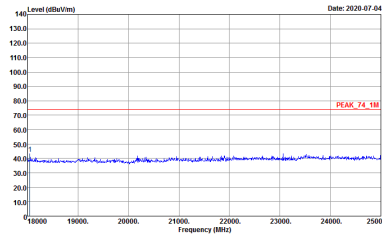

Emission above 18GHz
2.4GHz BT (SHF)

BT	2.4GHz 2400~2483.5MHz	
	BT SHF	
	Horizontal	Vertical
Peak Avg.	 <p>Site : 03CH11-4Y Condition : PEAK_74_1M 1m SHF HORN 88HA9170576 HORIZONTAL Detector : Peak</p>	 <p>Site : 03CH11-4Y Condition : PEAK_74_1M 1m SHF HORN 88HA9170576 VERTICAL Detector : Peak</p>

**Emission below 1GHz
2.4GHz BT (LF)**

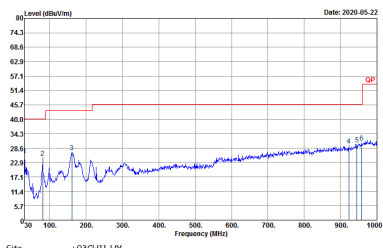
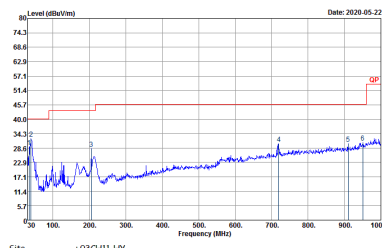
BT	2.4GHz 2400~2483.5MHz	
	BT LF	
	Horizontal	Vertical
QP / Peak	 <p>Site : 03CH11-HY Condition : QP 3m BT-LO6 6111D-LF_ETC HORIZONTAL Detector : Peak</p>	 <p>Site : 03CH11-HY Condition : QP 3m BT-LO6 6111D-LF_ETC VERTICAL Detector : Peak</p>



Appendix E. Duty Cycle Plots

3DH5 on time (One Pulse) Plot on Channel 39

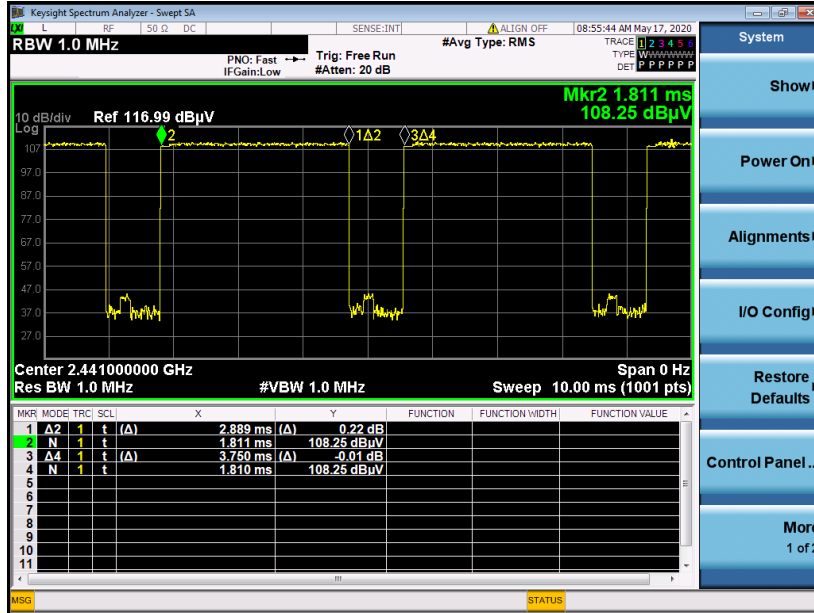

on time (Count Pulses) Plot on Channel 39

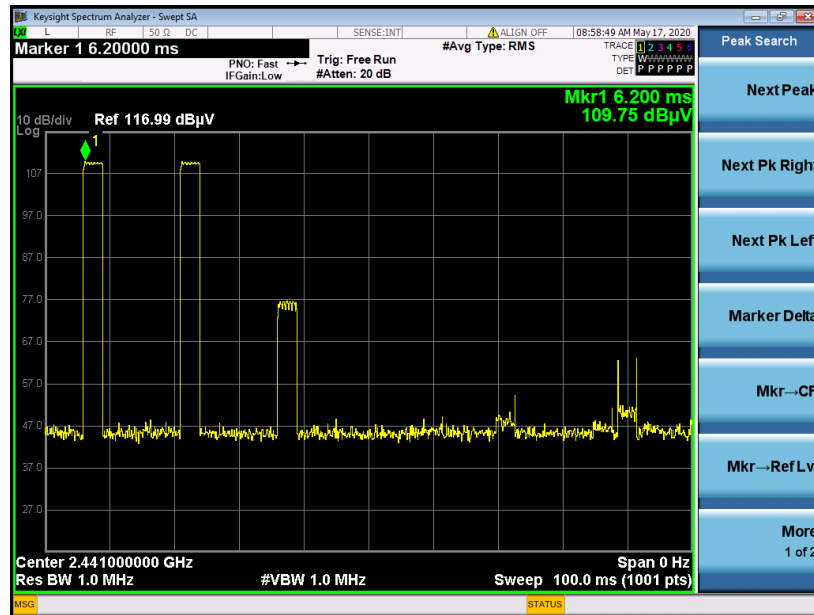

Note:

1. Worst case Duty cycle = on time/100 milliseconds = $2 * 2.89 / 100 = 5.78 \%$
2. Worst case Duty cycle correction factor = $20 * \log(\text{Duty cycle}) = -24.76 \text{ dB}$
3. 3DH5 has the highest duty cycle worst case and is reported.



Duty Cycle Correction Factor Consideration for AFH mode:

Bluetooth normal hopping rate is 1600Hz and reduced to 800Hz in AFH mode; due to the reduced number of hopping frequencies, with the same packet configuration the dwell time in each channel frequency within 100msec period is longer in AFH mode than normal mode.

In AFH mode, the minimum hopping frequencies are 20, to get the longest dwell time DH5 packet is observed; the period to have DH5 packet completing one hopping sequence is

$$2.89 \text{ ms} \times 20 \text{ channels} = 57.8 \text{ ms}$$

There cannot be 2 complete hopping sequences within 100ms period, considering the random hopping behavior, maximum 2 hops can be possibly observed within the period. $[100 \text{ ms} / 57.8 \text{ ms}] = 2 \text{ hops}$

Thus, the maximum possible ON time:

$$2.89 \text{ ms} \times 2 = 5.78 \text{ ms}$$

Worst case Duty Cycle Correction factor, which is derived from the maximum possible ON time,

$$20 \times \log(5.78 \text{ ms}/100 \text{ ms}) = -24.76 \text{ dB}$$

—————THE END—————