



# FCC CO-LOCATION RADIO TEST REPORT

**FCC ID** : A4RGX7AS  
**Equipment** : Phone  
**Model Name** : GX7AS, GB17L  
**Applicant** : Google LLC  
1600 Amphitheatre Parkway,  
Mountain View, California, 94043 USA  
**Standard** : FCC Part 15 Subpart E §15.407

The product was received on Nov. 11, 2021 and testing was started from Nov. 25, 2021 to Dec. 18, 2021. We, Sporton International Inc. Wensan Laboratory, would like to declare that the tested sample has been evaluated in accordance with the test procedures and has been in compliance with the applicable technical standards.

The test results in this report apply exclusively to the tested model / sample. Without written approval of Sporton International Inc. Wensan Laboratory, the test report shall not be reproduced except in full.

*Louis Wu*

Approved by: Louis Wu

**Sporton International Inc. Wensan Laboratory**

No.58, Aly. 75, Ln. 564, Wenhua 3rd, Rd., Guishan Dist., Taoyuan City 333010, Taiwan (R.O.C.)



## Table of Contents

History of this test report.....	3
Summary of Test Result.....	4
<b>1 General Description .....</b>	<b>5</b>
1.1 Product Feature of Equipment Under Test.....	5
1.2 Product Specification of Equipment Under Test.....	6
1.3 Modification of EUT .....	7
1.4 Testing Location .....	7
1.5 Applicable Standards.....	7
<b>2 Test Configuration of Equipment Under Test .....</b>	<b>8</b>
2.1 Carrier Frequency and Channel .....	8
2.2 Test Mode.....	9
2.3 Connection Diagram of Test System.....	10
2.4 EUT Operation Test Setup .....	10
<b>3 Test Result .....</b>	<b>11</b>
3.1 Unwanted Emissions Measurement.....	11
3.2 Antenna Requirements.....	16
<b>4 List of Measuring Equipment.....</b>	<b>17</b>
<b>5 Uncertainty of Evaluation.....</b>	<b>18</b>
<b>Appendix A. Radiated Spurious Emission</b>	
<b>Appendix B. Radiated Spurious Emission Plots</b>	
<b>Appendix C. Duty Cycle Plots</b>	



### History of this test report

Report No.	Version	Description	Issue Date
FR161608-05H	01	Initial issue of report	Jan. 25, 2022
FR161608-05H	02	Revise Test Configuration of Equipment Under Test and Appendix A	Feb. 17, 2022



### Summary of Test Result

Report Clause	Ref Std. Clause	Test Items	Result (PASS/FAIL)	Remark
3.1	15.407(b)	Unwanted Emissions	Pass	Under limit 8.96 dB at 32.910 MHz
3.2	15.203 15.407(a)	Antenna Requirement	Pass	-

**Declaration of Conformity:**

1. The test results (PASS/FAIL) with all measurement uncertainty excluded are presented in accordance with the regulation limits or requirements declared by manufacturers.  
It's means measurement values may risk exceeding the limit of regulation standards, if measurement uncertainty is include in test results.
2. The measurement uncertainty please refer to this report "Uncertainty Evaluation".

**Comments and Explanations:**

The product specifications of the EUT presented in the report are declared by the manufacturer who shall take full responsibility for the authenticity.

**Reviewed by: William Chen**  
**Report Producer: Celery Wei**



# 1 General Description

## 1.1 Product Feature of Equipment Under Test

Product Feature	
Equipment	Phone
Model Name	GX7AS, GB17L
FCC ID	A4RGX7AS
EUT supports Radios application	GSM/EGPRS/WCDMA/HSPA/LTE/5G NR/NFC/GNSS WLAN 11b/g/n HT20 WLAN 11a/n HT20/HT40 WLAN 11ac VHT20/VHT40/VHT80/VHT160 WLAN 11ax HE20/HE40/HE80/HE160 Bluetooth BR/EDR/LE

**Remark:**

1. The above EUT's information was declared by manufacturer.
2. All the tests were performed with GX7AS.

EUT Information List	
S/N	Performed Test Item
1A291FQGR00028	Radiated Spurious Emission



### 1.2 Product Specification of Equipment Under Test

Product Specification subjective to this standard										
<b>Tx/Rx Channel Frequency Range</b>	2400 MHz ~ 2483.5 MHz 5500 MHz ~ 5720 MHz 5925 MHz ~ 6425 MHz									
<b>Antenna Type / Gain</b>	<p><b>&lt;2400 MHz ~ 2483.5 MHz&gt;</b>  <b>&lt;Ant. 4&gt;</b>: IFA Antenna with gain -0.2 dBi  <b>&lt;Ant. 3&gt;</b>: IFA Antenna with gain -0.4 dBi</p> <p><b>&lt;5500 MHz ~ 5720 MHz&gt;</b>  <b>&lt;Ant. 4&gt;</b>: IFA Antenna with gain -2.1 dBi  <b>&lt;Ant. 3&gt;</b>: IFA Antenna with gain -1.8 dBi</p> <p><b>&lt;5925 MHz ~ 6425 MHz&gt;</b>  <b>&lt;Ant. 4&gt;</b>: IFA Antenna with gain -0.90 dBi  <b>&lt;Ant. 3&gt;</b>: IFA Antenna with gain -0.90 dBi</p>									
<b>Type of Modulation</b>	Bluetooth BR (1Mbps) : GFSK Bluetooth LE : GFSK 802.11g : OFDM (BPSK / QPSK / 16QAM / 64QAM) 802.11ax : OFDMA (BPSK / QPSK / 16QAM / 64QAM / 256QAM / 1024QAM)									
<b>Antenna Function for Transmitter</b>	<table border="1"> <thead> <tr> <th></th> <th>Ant. 4</th> <th>Ant. 3</th> </tr> </thead> <tbody> <tr> <td>Bluetooth-LE</td> <td>V</td> <td>-</td> </tr> <tr> <td>802.11 g/ax Bluetooth MIMO</td> <td>V</td> <td>V</td> </tr> </tbody> </table>		Ant. 4	Ant. 3	Bluetooth-LE	V	-	802.11 g/ax Bluetooth MIMO	V	V
	Ant. 4	Ant. 3								
Bluetooth-LE	V	-								
802.11 g/ax Bluetooth MIMO	V	V								

**Remark:**

1. MIMO Ant. 4+3 is a calculated result from sum of the power MIMO Ant. 4 and MIMO Ant. 3.
2. The above EUT's information was declared by manufacturer. Please refer to Comments and Explanations in report summary.



### 1.3 Modification of EUT

No modifications are made to the EUT during all test items.

### 1.4 Testing Location

<b>Test Site</b>	Sporton International Inc. Wensan Laboratory
<b>Test Site Location</b>	No.58, Aly. 75, Ln. 564, Wenhua 3rd, Rd., Guishan Dist., Taoyuan City 333010, Taiwan (R.O.C.) TEL: +886-3-327-0868 FAX: +886-3-327-0855
<b>Test Site No.</b>	<b>Sporton Site No.</b> 03CH15-HY

FCC designation No.: TW3786

### 1.5 Applicable Standards

According to the specifications of the manufacturer, the EUT must comply with the requirements of the following standards:

- ♦ FCC Part 15 Subpart E
- ♦ FCC Part 15 Subpart C §15.247
- ♦ FCC KDB Publication No. 558074 D01 DTS Meas. Guidance v05r02
- ♦ FCC KDB 789033 D02 General UNII Test Procedures New Rules v02r01.
- ♦ FCC KDB 987594 D02 U-NII 6 GHz EMC Measurement v01
- ♦ FCC KDB 414788 D01 Radiated Test Site v01r01.
- ♦ FCC KDB 662911 D01 Multiple Transmitter Output v02r01.
- ♦ ANSI C63.10-2013

**Remark:**

1. All test items were verified and recorded according to the standards and without any deviation during the test.
2. The TAF code is not including all the FCC KDB listed without accreditation.
3. This EUT has also been tested and complied with the requirements of FCC Part 15, Subpart B, recorded in a separate test report.



## 2 Test Configuration of Equipment Under Test

- a. The EUT has been associated with peripherals and configuration operated in a manner tended to maximize its emission characteristics in a typical application. Frequency range investigated: radiation emission (9 kHz to the 10th harmonic of the highest fundamental frequency or to 40 GHz, whichever is lower). The measured emission level of the EUT was maximized by rotating the EUT on a turntable, adjusting the orientation of the EUT and EUT antenna in three orthogonal axis (X: flat, Y: portrait, Z: landscape) and accessory (Adapter or Earphone), and adjusting the measurement antenna orientation, following C63.10 exploratory test procedures and find X plane with Adapter as worst plane.

### 2.1 Carrier Frequency and Channel

2400-2483.5 MHz Bluetooth EDR		2400-2483.5 MHz Bluetooth – LE	
Channel	Freq. (MHz)	Channel	Freq. (MHz)
39	2441	39	2480

2400-2483.5 MHz 802.11g		5470-5725 MHz 802.11ax HE160	
Channel	Freq. (MHz)	Channel	Freq. (MHz)
13	2472	114	5570

5925-6425MHz 802.11ax HE160	
Channel	Freq. (MHz)
15	6025





## 2.2 Test Mode

Final test modes are considering the modulation and worse data rates as below table.

<Co-Location>

Modulation	Data Rate
Bluetooth for MIMO <Ant. 4+3> + WLAN 5GHz 802.11ax HE160 for MIMO <Ant. 4+3>	3Mbps + MCS0
Bluetooth-LE for Ant. 4 + WLAN 5GHz 802.11ax HE160 for MIMO <Ant. 4+3>	1Mbps + MCS0
WLAN 2.4GHz 802.11g for MIMO <Ant. 4+3> + WLAN 5GHz 802.11ax HE160 for MIMO <Ant. 4+3>	6Mbps + MCS0
Bluetooth for MIMO <Ant. 4+3> + WLAN 6GHz 802.11ax HE160 for MIMO <Ant. 4+3>	3Mbps + MCS0
Bluetooth LE for Ant. 4 + WLAN 6GHz 802.11ax HE160 for MIMO <Ant. 4+3>	1Mbps + MCS0
WLAN 2.4GHz 802.11g for MIMO <Ant. 4+3> + WLAN 6GHz 802.11ax HE160 for MIMO <Ant. 4+3>	6Mbps + MCS0

**Remark:** For Radiated Test Cases, the tests were performed with Adapter 1 and USB Cable 2.

## 2.3 Connection Diagram of Test System

<Co-Location Tx Mode>

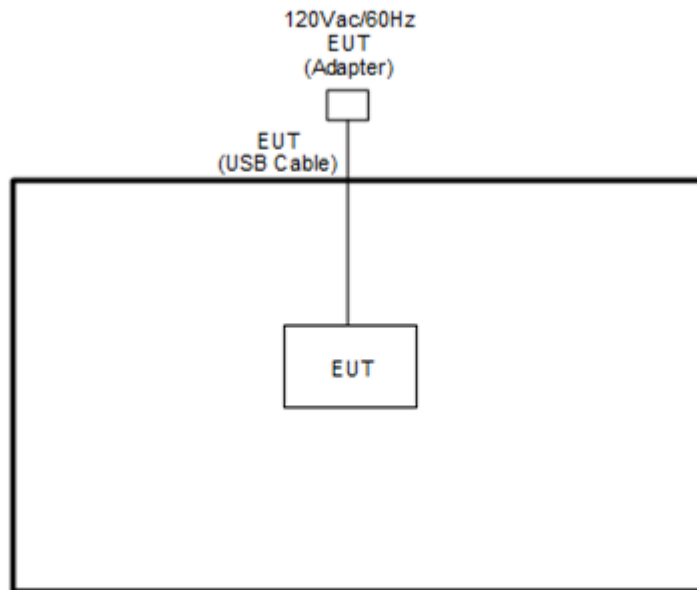

## 2.4 EUT Operation Test Setup

The RF test items, utility “Command v10.0.17134.134” was installed in Notebook which was programmed in order to make the EUT get into the engineering modes to provide channel selection, power level, data rate and the application type and for continuous transmitting signals.



### 3 Test Result

#### 3.1 Unwanted Emissions Measurement

This section is to measure unwanted emissions through radiated measurement for band edge spurious emissions and out of band emissions measurement.

##### <Limit of Unwanted Emissions>

(1) Unwanted spurious emissions fallen in restricted bands shall comply with the general field strength limits as below table:

Frequency (MHz)	Field Strength (microvolts/meter)	Measurement Distance (meters)
0.009 – 0.490	2400/F(kHz)	300
0.490 – 1.705	24000/F(kHz)	30
1.705 – 30.0	30	30
30 – 88	100	3
88 – 216	150	3
216 - 960	200	3
Above 960	500	3

**Note:** The following formula is used to convert the EIRP to field strength.

$$E = \frac{1000000\sqrt{30P}}{3} \mu\text{V/m, where P is the eirp (Watts)}$$

EIRP (dBm)	Field Strength at 3m (dBμV/m)
- 27	68.3

(2) KDB789033 D02 v02r01 G)2)c)

(i) Sections 15.407(b)(1-3) specifies the unwanted emissions limit for the U-NII-1 and U-NII-2 bands. As specified, emissions above 1000 MHz that are outside of the restricted bands are subject to a peak emission limit of -27 dBm/MHz.

(ii) Section 15.407(b)(4) specifies the unwanted emissions limit for the U-NII-3 band. A band emissions mask is specified in Section 15.407(b)(4)(i). The emission limits are based on the use of a peak detector.



- (3) For transmitters operating within the 5.925-7.125 GHz band: Any emissions outside of the 5.925-7.125 GHz band must not exceed an e.i.r.p. of -27 dBm/MHz.

EIRP (dBm)	Field Strength at 3m (dBμV/m)
- 27 (RMS)	68.3
- 7 (Peak)	88.3

According 987594 D02 U-NII 6GHz EMC Measurement v01 section G:

Unwanted emissions outside of restricted bands are measured with a RMS detector.

In addition, 15.35(b) applies where the peak emissions must be limited to no more than 20 dB above the average limit

### 3.1.1 Measuring Instruments

See list of measuring equipment of this test report.

### 3.1.2 Test Procedures

- 1. The testing follows FCC KDB 789033 D02 General UNII Test Procedures New Rules v02r01.

Section G) Unwanted emissions measurement.

(1) Procedure for Unwanted Emissions Measurements Below 1000MHz

- RBW = 120 kHz
- VBW = 300 kHz
- Detector = Peak
- Trace mode = max hold

(2) Procedure for Peak Unwanted Emissions Measurements Above 1000 MHz

- RBW = 1 MHz
- VBW ≥ 3 MHz
- Detector = Peak
- Sweep time = auto
- Trace mode = max hold

(3) Procedures for Average Unwanted Emissions Measurements Above 1000MHz

- RBW = 1 MHz
- VBW = 10 Hz, when duty cycle is no less than 98 percent.
- VBW ≥ 1/T, when duty cycle is less than 98 percent where T is the minimum transmission duration over which the transmitter is on and is transmitting at its maximum power control level for the tested mode of operation.



2. The EUT was placed on a turntable with 0.8 meter for frequency below 1GHz and 1.5 meter for frequency above 1GHz respectively above ground.
3. The EUT was set 3 meters from the interference receiving antenna which was mounted on the top of a variable height antenna tower.
4. The antenna is a broadband antenna and its height is adjusted between one meter and four meters above ground to find the maximum value of the field strength for both horizontal polarization and vertical polarization of the antenna.
5. For each suspected emission, the EUT was arranged to its worst case and then adjust the antenna tower (from 1 m to 4 m) and turntable (from 0 degree to 360 degrees) to find the maximum reading.
6. Radiated testing below 1 GHz is performed by adjusting the antenna tower from 1 m to 4 m and by rotating the turn table from 0 degree to 360 degrees to find the peak maximum hold reading. When there is no suspected emission found and the emission level is with at least 6 dB margin against QP limit line, the position is marked as “-“.
7. Radiated testing above 1 GHz is performed by adjusting the antenna tower from 1 m to 4 m and by rotating the turn table from 0 degree to 360 degrees to find the peak maximum hold reading for scanning all frequencies. When there is no suspected emission found and the harmonic emission level is with at least 6 dB margin against average limit line, the position is marked as “-“..

### 3.1.3 Test Setup

For radiated emissions below 30MHz

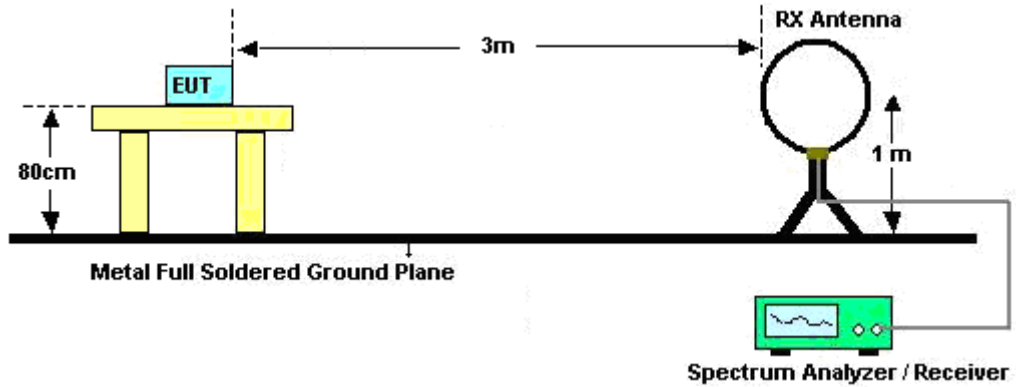

For radiated emissions from 30MHz to 1GHz

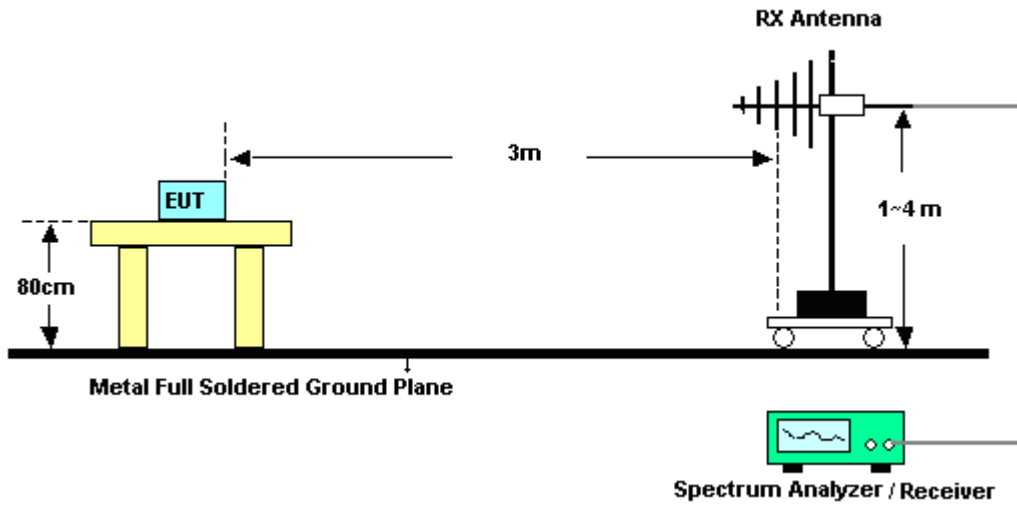

For radiated test from 1GHz to 18GHz

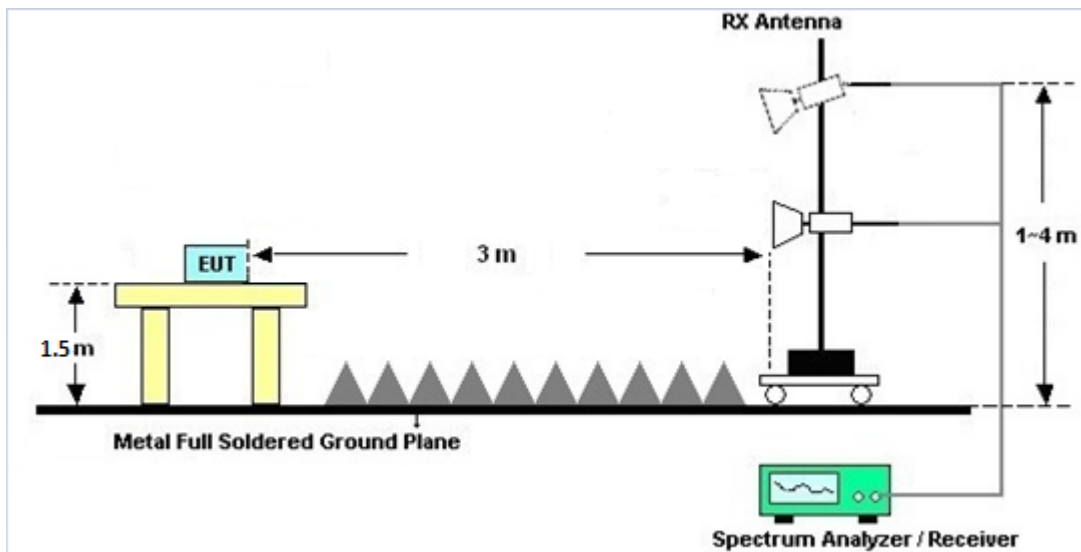

For radiated test above 18GHz

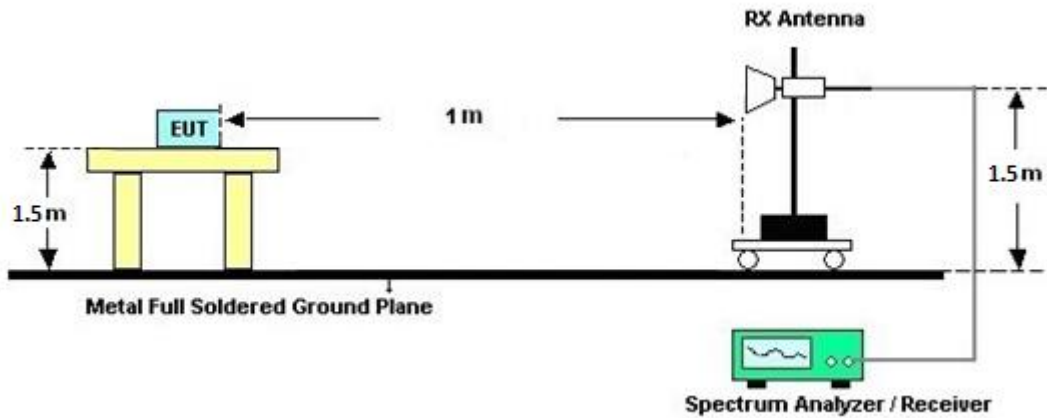

### 3.1.4 Test Results of Radiated Spurious Emissions (9 kHz ~ 30 MHz)

The low frequency, which started from 9 kHz to 30MHz, was pre-scanned and the result which was 20dB lower than the limit line was not reported.

There is adequate comparison measurement of both open-field test site and alternative test site - semi-Anechoic chamber according to 414788 D01 Radiated Test Site v01r01, and the result came out very similar.

### 3.1.5 Test Result of Radiated Spurious at Band Edges

Please refer to Appendix A and B.

### 3.1.6 Duty Cycle

Please refer to Appendix C.

### 3.1.7 Test Result of Radiated Spurious Emissions (30MHz ~ 10th Harmonic)

Please refer to Appendix A and B.



## **3.2 Antenna Requirements**

### **3.2.1 Standard Applicable**

#### **<Bluetooth, Bluetooth-LE, WLAN 2.4GHz and WLAN 5GHz>**

If directional gain of transmitting antennas is greater than 6dBi, the power and the peak power spectral density shall be reduced by the same level in dB comparing to gain minus 6dBi. The use of a permanently attached antenna or of an antenna that uses a unique coupling to the intentional radiator shall be considered sufficient to comply with the rule.

#### **<WLAN 6GHz>**

The use of a permanently attached antenna or of an antenna that uses a unique coupling to the intentional radiator shall be considered sufficient to comply with the rule.

### **3.2.2 Antenna Anti-Replacement Construction**

An embedded-in antenna design is used.





## 4 List of Measuring Equipment

Instrument	Brand Name	Model No.	Serial No.	Characteristics	Calibration Date	Test Date	Due Date	Remark
Loop Antenna	Rohde & Schwarz	HFH2-Z2	100315	9 kHz~30 MHz	Jan. 04, 2021	Nov. 25, 2021~ Dec. 18, 2021	Jan. 03, 2022	Radiation (03CH15-HY)
Bilog Antenna	TESEQ	CBL 6111D & 00800N1D01N-06	41912 & 05	30MHz~1GHz	Feb. 08, 2021	Nov. 25, 2021~ Dec. 18, 2021	Feb. 07, 2022	Radiation (03CH15-HY)
Amplifier	SONOMA	310N	363440	9kHz~1GHz	Dec. 28, 2020	Nov. 25, 2021~ Dec. 18, 2021	Dec. 27, 2021	Radiation (03CH15-HY)
Horn Antenna	SCHWARZB ECK	BBHA 9120 D	9120D-01620	1GHz~18GHz	Oct. 25, 2021	Nov. 25, 2021~ Dec. 18, 2021	Oct. 24, 2022	Radiation (03CH15-HY)
SHF-EHF Horn Antenna	SCHWARZB ECK	BBHA 9170	00991	18GHz~40GHz	May 12, 2021	Nov. 25, 2021~ Dec. 18, 2021	May 11, 2022	Radiation (03CH15-HY)
Preamplifier	Jet-Power	JPA0118-55-303	17100018000 55006	1GHz~18GHz	May 06, 2021	Nov. 25, 2021~ Dec. 18, 2021	May 05, 2022	Radiation (03CH15-HY)
Preamplifier	EM Electronics	EM01G18G	060802	1GHz-18GHz	Jul. 26, 2021	Nov. 25, 2021~ Dec. 18, 2021	Jul. 25, 2022	Radiation (03CH15-HY)
Preamplifier	EMEC	EM18G40G	060801	18-40GHz	Jun. 22, 2021	Nov. 25, 2021~ Dec. 18, 2021	Jun. 21, 2022	Radiation (03CH15-HY)
EMI Test Receiver	Keysight	N9038A(MXE)	MY55420170	20MHz~8.4GHz	Jul. 15, 2021	Nov. 25, 2021~ Dec. 18, 2021	Jul. 14, 2022	Radiation (03CH15-HY)
Spectrum Analyzer	Agilent	E4446A	MY50180136	3Hz~44GHz	May 07, 2021	Nov. 25, 2021~ Dec. 18, 2021	May 06, 2022	Radiation (03CH15-HY)
Antenna Mast	ChainTek	MBS-520-1	N/A	1m~4m	N/A	Nov. 25, 2021~ Dec. 18, 2021	N/A	Radiation (03CH15-HY)
Turn Table	ChainTek	T-200-S-1	N/A	0~360 Degree	N/A	Nov. 25, 2021~ Dec. 18, 2021	N/A	Radiation (03CH15-HY)
Software	Audix	E3 6.2009-8-24 (k5)	RK-000451	N/A	N/A	Nov. 25, 2021~ Dec. 18, 2021	N/A	Radiation (03CH15-HY)
RF Cable	HUBER + SUHNER	SUCOFLEX 104, 102E	MY36980/4, MY9838/4PE, 508405/2E	30MHz~18G	Nov. 15, 2021	Nov. 25, 2021~ Dec. 18, 2021	Nov. 14, 2022	Radiation (03CH15-HY)
RF Cable	HUBER + SUHNER	SUCOFLEX 102	505134/2	30MHz-40GHz	Feb. 22, 2021	Nov. 25, 2021~ Dec. 18, 2021	Feb. 21, 2022	Radiation (03CH15-HY)
RF Cable	HUBER + SUHNER	SUCOFLEX 102	800740/2	30MHz-40GHz	Feb. 22, 2021	Nov. 25, 2021~ Dec. 18, 2021	Feb. 21, 2022	Radiation (03CH15-HY)
RF Cable	HUBER + SUHNER	SUCOFLEX 104	MY9837/4PE	9kHz~30MHz	Mar. 11, 2021	Nov. 25, 2021~ Dec. 18, 2021	Mar. 10, 2022	Radiation (03CH15-HY)
Filter	Wainwright	WLJ4-1000-1530-6 000-40ST	SN4	1.53GHz Low Pass Filter	Jul. 02, 2021	Nov. 25, 2021~ Dec. 18, 2021	Jul. 01, 2022	Radiation (03CH15-HY)
Filter	Wainwright	WHKX8-5872.5-67 50-18000-40ST	SN6	6.75GHz High Pass Filter	Jun. 30, 2021	Nov. 25, 2021~ Dec. 18, 2021	Jun. 29, 2022	Radiation (03CH15-HY)



## 5 Uncertainty of Evaluation

### Uncertainty of Radiated Emission Measurement (30 MHz ~ 1000 MHz)

Measuring Uncertainty for a Level of Confidence of 95% ( $U = 2Uc(y)$ )	5.8 dB
---	--------

### Uncertainty of Radiated Emission Measurement (1000 MHz ~ 18000 MHz)

Measuring Uncertainty for a Level of Confidence of 95% ( $U = 2Uc(y)$ )	5.3 dB
---	--------

### Uncertainty of Radiated Emission Measurement (18000 MHz ~ 40000 MHz)

Measuring Uncertainty for a Level of Confidence of 95% ( $U = 2Uc(y)$ )	5.6 dB
---	--------



## Appendix A. Radiated Spurious Emission

<b>Test Engineer :</b>	Leo Lee, Mancy Chou and Bigshow Wang	<b>Temperature :</b>	22.1~23.1°C
		<b>Relative Humidity :</b>	55~60%



2.4GHz 2400~2483.5MHz + Band 3 5470~5725MHz

MIMO <Ant. 4+3>\_BT\_Tx\_CH39 + MIMO <Ant. 4+3>\_802.11ax HE160\_Tx\_CH114 Full  
(Harmonic @ 3m)

WIFI Ant. Simultaneously	Note	Frequency ( MHz )	Level ( dBμV/m )	Over Limit ( dB )	Limit Line ( dBμV/m )	Read Level ( dBμV )	Antenna Factor ( dB/m )	Path Loss ( dB )	Preamp Factor ( dB )	Ant Pos ( cm )	Table Pos ( deg )	Peak Avg. (P/A)	Pol. (H/V)
BT CH39 2441MHz + 802.11ax HE160 CH114 5570MHz		4882	47.63	-26.37	74	40.68	31.33	10.74	35.12	-	-	P	H
		4882	22.84	-31.16	54	-	-	-	-	-	-	A	H
		7323	41.22	-32.78	74	50.56	36.35	12.72	58.41	-	-	P	H
		7323	16.43	-37.57	54	-	-	-	-	-	-	A	H
		10949	51.06	-22.94	74	56.58	40.5	14.85	60.87	-	-	P	H
		10949	41	-13	54	46.52	40.5	14.85	60.87	-	-	A	H
		11140	47.56	-26.44	74	53.29	40.18	14.95	60.86	-	-	P	H
		14480	50.76	-23.24	74	56.13	41.34	16.47	63.18	-	-	P	H
		14480	40.75	-13.25	54	46.12	41.34	16.47	63.18	-	-	A	H
		16710	48.15	-20.05	68.2	49.36	39.56	17.85	58.62	-	-	P	H
		18000	58.55	-15.45	74	48.45	48.4	18.94	57.24	-	-	P	H
		18000	48.56	-5.44	54	38.46	48.4	18.94	57.24	-	-	A	H
		4882	47.84	-26.16	74	40.89	31.33	10.74	35.12	-	-	P	V
		4882	23.05	-30.95	54	-	-	-	-	-	-	A	V
		7323	42.07	-31.93	74	51.41	36.35	12.72	58.41	-	-	P	V
		7323	17.28	-36.72	54	-	-	-	-	-	-	A	V
		11004	50.74	-23.26	74	56.13	40.59	14.88	60.86	-	-	P	V
		11004	40.72	-13.28	54	46.11	40.59	14.88	60.86	-	-	A	V
		11140	48.15	-25.85	74	53.88	40.18	14.95	60.86	-	-	P	V
		14491	50.22	-23.78	74	55.54	41.37	16.48	63.17	-	-	P	V
	14491	40.23	-13.77	54	45.55	41.37	16.48	63.17	-	-	A	V	
	16710	47.95	-20.25	68.2	49.16	39.56	17.85	58.62	-	-	P	V	
	17989	59.28	-14.72	74	49.44	48.18	18.93	57.27	-	-	P	V	
	17989	49.23	-4.77	54	39.39	48.18	18.93	57.27	-	-	A	V	
<b>Remark</b>	<ol style="list-style-type: none"> <li>No other spurious found.</li> <li>All results are PASS against Peak and Average limit line.</li> <li>The emission position marked as "-" means no suspected emission found with sufficient margin against limit line or noise floor only.</li> <li>The emission level close to 18GHz is checked that the average emission level is noise floor only.</li> </ol>												



Ant. 4\_BLE\_Tx\_CH39 + MIMO <Ant. 4+3>\_802.11ax HE160\_Tx\_CH114 Full  
(Harmonic @ 3m)

WIFI	Note	Frequency	Level	Over	Limit	Read	Antenna	Path	Preamp	Ant	Table	Peak	Pol.	
Ant.				Limit	Line	Level	Factor	Loss	Factor	Pos	Pos	Avg.		
Simultaneously		( MHz )	( dBμV/m )	( dB )	( dBμV/m )	( dBμV )	( dB/m )	( dB )	( dB )	( cm )	( deg )	(P/A)	(H/V)	
BLE CH39 2480MHz + 802.11ax HE160 CH114 5570MHz		4960	48.79	-25.21	74	41.73	31.44	10.79	35.17	-	-	P	H	
		7440	44.3	-29.7	74	53.4	36.36	12.74	58.2	-	-	P	H	
		10795	49.75	-24.25	74	55.69	40.18	14.77	60.89	-	-	P	H	
		10795	39.97	-14.03	54	45.91	40.18	14.77	60.89	-	-	A	H	
		11140	47.76	-26.24	74	53.49	40.18	14.95	60.86	-	-	P	H	
		14480	49.8	-24.2	74	55.17	41.34	16.47	63.18	-	-	P	H	
		14480	41.02	-12.98	54	46.39	41.34	16.47	63.18	-	-	A	H	
		16710	48.7	-19.5	68.2	49.91	39.56	17.85	58.62	-	-	P	H	
		18000	57.38	-16.62	74	47.28	48.4	18.94	57.24	-	-	P	H	
		18000	47.6	-6.4	54	37.5	48.4	18.94	57.24	-	-	A	H	
			4960	49.23	-24.77	74	42.17	31.44	10.79	35.17	-	-	P	V
			7440	46.43	-27.57	74	55.53	36.36	12.74	58.2	-	-	P	V
			10905	50.19	-23.81	74	55.82	40.41	14.83	60.87	-	-	P	V
			10905	40.41	-13.59	54	46.04	40.41	14.83	60.87	-	-	A	V
			11140	49.16	-24.84	74	54.89	40.18	14.95	60.86	-	-	P	V
			14469	49.71	-18.49	68.2	55.11	41.31	16.47	63.18	-	-	P	V
			14469	40.94	-13.06	54	46.34	41.31	16.47	63.18	-	-	A	V
			16710	48.32	-19.88	68.2	49.53	39.56	17.85	58.62	-	-	P	V
			18000	57.6	-16.4	74	47.5	48.4	18.94	57.24	-	-	P	V
		18000	47.82	-6.18	54	37.72	48.4	18.94	57.24	-	-	A	V	

<b>Remark</b>	<ol style="list-style-type: none"> <li>1. No other spurious found.</li> <li>2. All results are PASS against Peak and Average limit line.</li> <li>3. The emission position marked as "-" means no suspected emission found with sufficient margin against limit line or noise floor only.</li> <li>4. The emission level close to 18GHz is checked that the average emission level is noise floor only.</li> </ol>
---------------	--



MIMO <Ant. 4+3>\_802.11g\_Tx\_CH13 + MIMO <Ant. 4+3>\_802.11ax HE160\_Tx\_CH114  
(Harmonic @ 3m)

WIFI	Note	Frequency	Level	Over	Limit	Read	Antenna	Path	Preamp	Ant	Table	Peak	Pol.	
Ant.				Limit	Line	Level	Factor	Loss	Factor	Pos	Pos	Avg.		
Simultaneously		( MHz )	( dBμV/m )	( dB )	( dBμV/m )	( dBμV )	( dB/m )	( dB )	( dB )	( cm )	( deg )	(P/A)	(H/V)	
802.11g CH13 2472MHz + 802.11ax HE160 CH114 5570MHz		4904	47.97	-26.03	74	40.51	31.4	11.2	35.14	-	-	P	H	
		7414	43.6	-30.4	74	52.83	36.26	12.75	58.24	-	-	P	H	
		10806	50.92	-23.08	74	56.82	40.21	14.78	60.89	-	-	P	H	
		10806	40.91	-13.09	54	46.81	40.21	14.78	60.89	-	-	A	H	
		11140	48.32	-25.68	74	54.05	40.18	14.95	60.86	-	-	P	H	
		14500	50.53	-23.47	74	55.82	41.4	16.48	63.17	-	-	P	H	
		14500	40.52	-13.48	54	45.81	41.4	16.48	63.17	-	-	A	H	
		16710	48.81	-19.39	68.2	50.02	39.56	17.85	58.62	-	-	P	H	
		18000	57.89	-16.11	74	47.79	48.4	18.94	57.24	-	-	P	H	
		18000	47.82	-6.18	54	37.72	48.4	18.94	57.24	-	-	A	H	
			4904	47.68	-26.32	74	40.22	31.4	11.2	35.14	-	-	P	V
			7414	46.05	-27.95	74	55.28	36.26	12.75	58.24	-	-	P	V
			10993	50.98	-23.02	74	56.38	40.59	14.87	60.86	-	-	P	V
			10993	40.92	-13.08	54	46.32	40.59	14.87	60.86	-	-	A	V
			11140	48.18	-25.82	74	53.91	40.18	14.95	60.86	-	-	P	V
			14480	50.92	-23.08	74	56.29	41.34	16.47	63.18	-	-	P	V
			14480	40.91	-13.09	54	46.28	41.34	16.47	63.18	-	-	A	V
			16710	48.61	-19.59	68.2	49.82	39.56	17.85	58.62	-	-	P	V
			18000	58.23	-15.77	74	48.13	48.4	18.94	57.24	-	-	P	V
		18000	48.22	-5.78	54	38.12	48.4	18.94	57.24	-	-	A	V	
<b>Remark</b>	<ol style="list-style-type: none"> <li>No other spurious found.</li> <li>All results are PASS against Peak and Average limit line.</li> <li>The emission position marked as "-" means no suspected emission found with sufficient margin against limit line or noise floor only.</li> <li>The emission level close to 18GHz is checked that the average emission level is noise floor only.</li> </ol>													



Emission below 1GHz

MIMO <Ant. 4+3>\_802.11g\_Tx\_CH13 + MIMO <Ant. 4+3>\_802.11ax\_HE160\_Tx\_CH114 Full  
(LF @ 3m)

WIFI Ant.	Note	Frequency	Level	Over Limit	Limit Line	Read Level	Antenna Factor	Path Loss	Preamp Factor	Ant Pos	Table Pos	Peak Avg.	Pol.
Simultaneously		( MHz )	( dBµV/m )	( dB )	( dBµV/m )	( dBµV )	( dB/m )	( dB )	( dB )	( cm )	( deg )	(P/A)	(H/V)
802.11g CH13 2472MHz + 802.11ax HE160 CH114 5570MHz LF		31.94	22.11	-17.89	40	30.34	23.65	0.63	32.51	-	-	P	H
		88.2	28.48	-15.02	43.5	45.37	14.36	1.25	32.5	-	-	P	H
		99.84	31.93	-11.57	43.5	47.2	15.91	1.32	32.5	-	-	P	H
		168.71	27.82	-15.68	43.5	42.79	15.7	1.82	32.49	-	-	P	H
		186.17	26.42	-17.08	43.5	42.28	14.76	1.85	32.47	-	-	P	H
		932.1	32.17	-13.83	46	29.65	29.73	4.21	31.42	-	-	P	H
													H
													H
													H
													H
													H
													H
													H
													H
													H
													H
													H
													H
													H
	Remark	1. No other spurious found.											
2. All results are PASS against Peak and Average limit line.													
3. The emission level is with at least 6 dB margin against limit line, the position is marked as "-".													



2.4GHz 2400~2483.5MHz + Band 5 5925~6425MHz

MIMO <Ant. 4+3>\_BT\_Tx\_CH39 + MIMO <Ant. 4+3>\_802.11ax HE160\_Tx\_CH15  
(Harmonic @ 3m)

WIFI	Note	Frequency	Level	Over	Limit	Read	Antenna	Path	Preamp	Ant	Table	Peak	Pol.
Ant.				Limit	Line	Level	Factor	Loss	Factor	Pos	Pos	Avg.	
Simultaneously		( MHz )	( dBμV/m )	( dB )	( dBμV/m )	( dBμV )	( dB/m )	( dB )	( dB )	( cm )	( deg )	(P/A)	(H/V)
BT CH39 2441MHz + 802.11ax HE160 CH15 6025MHz		4882	40.76	-33.24	74	57.16	31.33	11.18	58.91	-	-	P	H
		4882	15.97	-38.03	54	-	-	-	-	-	-	A	H
		7323	48.95	-25.05	74	57.31	36.35	13.7	58.41	-	-	P	H
		7323	24.16	-29.84	54	-	-	-	-	-	-	A	H
		10952	49.68	-24.32	74	55.77	40.5	14.28	60.87	-	-	P	H
		10952	39.64	-14.36	54	45.73	40.5	14.28	60.87	-	-	A	H
		12050	45.87	-28.13	74	53.56	39	14.8	61.49	-	-	P	H
		14488	50.14	-23.86	74	55.47	41.36	16.49	63.18	-	-	P	H
		14488	40.16	-13.84	54	45.49	41.36	16.49	63.18	-	-	A	H
		18000	57.21	-16.79	74	47.62	48.4	18.43	57.24	-	-	P	H
		18000	47.2	-6.8	54	37.61	48.4	18.43	57.24	-	-	A	H
		18075	35.86	-38.14	74	58.02	37.39	-3.72	55.83	-	-	P	H
		4882	39.98	-34.02	74	56.38	31.33	11.18	58.91	-	-	P	V
		4882	15.19	-38.81	54	-	-	-	-	-	-	A	V
		7323	47.31	-26.69	74	55.67	36.35	13.7	58.41	-	-	P	V
		7323	22.52	-31.48	54	-	-	-	-	-	-	A	V
		10944	50.03	-23.97	74	56.13	40.49	14.28	60.87	-	-	P	V
		10944	40.02	-13.98	54	46.12	40.49	14.28	60.87	-	-	A	V
		12050	46.12	-27.88	74	53.81	39	14.8	61.49	-	-	P	V
		14480	50.93	-23.07	74	56.28	41.34	16.49	63.18	-	-	P	V
	14480	40.92	-13.08	54	46.27	41.34	16.49	63.18	-	-	A	V	
	17992	57.3	-16.7	74	47.9	48.24	18.42	57.26	-	-	P	V	
	17992	47.29	-6.71	54	37.89	48.24	18.42	57.26	-	-	A	V	
	18075	36.13	-37.87	74	58.29	37.39	-3.72	55.83	-	-	P	V	
Remark	<ol style="list-style-type: none"> <li>No other spurious found.</li> <li>All results are PASS against Peak and Average limit line.</li> <li>The emission position marked as "-" means no suspected emission found with sufficient margin against limit line or noise floor only.</li> <li>The emission level close to 18GHz is checked that the average emission level is noise floor only.</li> </ol>												





Ant. 4\_BLE\_Tx\_CH39 + MIMO <Ant. 4+3>\_802.11ax HE160\_Tx\_CH15 (Harmonic @ 3m)

WIFI Ant. Simultaneously	Note	Frequency ( MHz )	Level ( dBμV/m )	Over Limit ( dB )	Limit Line ( dBμV/m )	Read Level ( dBμV )	Antenna Factor ( dB/m )	Path Loss ( dB )	Preamp Factor ( dB )	Ant Pos ( cm )	Table Pos ( deg )	Peak Avg. (P/A)	Pol. (H/V)
		4960	39.21	-34.79	74	55.47	31.44	11.28	58.98	-	-	P	H
		7440	50.87	-23.13	74	59.07	36.36	13.64	58.2	100	231	P	H
		7440	41.6	-12.4	54	49.8	36.36	13.64	58.2	100	231	A	H
		10896	49.95	-24.05	74	56.18	40.39	14.25	60.87	-	-	P	H
		10896	39.89	-14.11	54	46.12	40.39	14.25	60.87	-	-	A	H
		12050	45.88	-28.12	74	53.57	39	14.8	61.49	-	-	P	H
		14496	49.87	-24.13	74	55.15	41.39	16.5	63.17	-	-	P	H
		14496	39.9	-14.1	54	45.18	41.39	16.5	63.17	-	-	A	H
		17976	57.59	-16.41	74	48.56	47.92	18.41	57.3	-	-	P	H
		17976	47.91	-6.09	54	38.88	47.92	18.41	57.3	-	-	A	H
		18075	36.43	-37.57	74	58.59	37.39	-3.72	55.83	-	-	P	H
		4960	40.24	-33.76	74	56.5	31.44	11.28	58.98	-	-	P	V
		7440	51.88	-22.12	74	60.08	36.36	13.64	58.2	100	93	P	V
		7440	43.93	-10.07	54	52.13	36.36	13.64	58.2	100	93	A	V
		10928	49.98	-24.02	74	56.12	40.46	14.27	60.87	-	-	P	V
		10928	40.02	-13.98	54	46.16	40.46	14.27	60.87	-	-	A	V
		12050	46.06	-27.94	74	53.75	39	14.8	61.49	-	-	P	V
		14488	50.43	-23.57	74	55.76	41.36	16.49	63.18	-	-	P	V
		14488	40.42	-13.58	54	45.75	41.36	16.49	63.18	-	-	A	V
		17976	58.17	-15.83	74	49.14	47.92	18.41	57.3	-	-	P	V
		17976	48	-6	54	38.97	47.92	18.41	57.3	-	-	A	V
		18075	36.68	-37.32	74	58.84	37.39	-3.72	55.83	-	-	P	V

<b>Remark</b>	<ol style="list-style-type: none"> <li>1. No other spurious found.</li> <li>2. All results are PASS against Peak and Average limit line.</li> <li>3. The emission position marked as "-" means no suspected emission found with sufficient margin against limit line or noise floor only.</li> <li>4. The emission level close to 18GHz is checked that the average emission level is noise floor only.</li> </ol>
---------------	--



MIMO <Ant. 4+3>\_802.11g\_Tx\_CH13 + 802.11ax HE160\_Tx\_CH15 (Harmonic @ 3m)

WIFI Ant. Simultaneously	Note	Frequency ( MHz )	Level ( dBμV/m )	Over Limit ( dB )	Limit Line ( dBμV/m )	Read Level ( dBμV )	Antenna Factor ( dB/m )	Path Loss ( dB )	Preamp Factor ( dB )	Ant Pos ( cm )	Table Pos ( deg )	Peak Avg. (P/A)	Pol. (H/V)	
802.11g CH13 2472MHz + 802.11ax HE160 CH15 6025MHz		4944	40.14	-33.86	74	56.45	31.4	11.25	58.96	-	-	P	H	
		7416	45.05	-28.95	74	53.45	36.26	13.58	58.24	-	-	P	H	
		10896	50.69	-23.31	74	56.92	40.39	14.25	60.87	-	-	P	H	
		10896	40.68	-13.32	54	46.91	40.39	14.25	60.87	-	-	A	H	
		12050	46.34	-27.66	74	54.03	39	14.8	61.49	-	-	P	H	
		14472	50.6	-23.4	74	55.97	41.32	16.49	63.18	-	-	P	H	
		14472	40.54	-13.46	54	45.91	41.32	16.49	63.18	-	-	A	H	
		17992	58.27	-15.73	74	48.87	48.24	18.42	57.26	-	-	P	H	
		17992	48.23	-5.77	54	38.83	48.24	18.42	57.26	-	-	A	H	
		18075	36.38	-37.62	74	58.54	37.39	-3.72	55.83	-	-	P	H	
			4944	39.99	-34.01	74	56.3	31.4	11.25	58.96	-	-	P	V
			7416	50.48	-23.52	74	58.88	36.26	13.58	58.24	100	247	P	V
			7416	39.3	-14.7	54	47.7	36.26	13.58	58.24	100	247	A	V
			10880	49.69	-24.31	74	55.97	40.36	14.24	60.88	-	-	P	V
			10880	39.67	-14.33	54	45.95	40.36	14.24	60.88	-	-	A	V
			12050	46.38	-27.62	74	54.07	39	14.8	61.49	-	-	P	V
			14496	50.83	-23.17	74	56.11	41.39	16.5	63.17	-	-	P	V
			14496	40.82	-13.18	54	46.1	41.39	16.5	63.17	-	-	A	V
			17984	57.97	-16.03	74	48.75	48.08	18.42	57.28	-	-	P	V
		17984	47.95	-6.05	54	38.73	48.08	18.42	57.28	-	-	A	V	
		18075	37.61	-36.39	74	59.77	37.39	-3.72	55.83	-	-	P	V	
Remark	<ol style="list-style-type: none"> <li>No other spurious found.</li> <li>All results are PASS against Peak and Average limit line.</li> <li>The emission position marked as "-" means no suspected emission found with sufficient margin against limit line or noise floor only.</li> <li>The emission level close to 18GHz is checked that the average emission level is noise floor only.</li> </ol>													



Emission below 1GHz

MIMO <Ant. 4+3>\_802.11g\_Tx\_CH13 + 802.11ax HE160\_Tx\_CH15 (LF @ 3m)

WIFI	Note	Frequency	Level	Over	Limit	Read	Antenna	Path	Preampl	Ant	Table	Peak	Pol.	
Ant.				Limit	Line	Level	Factor	Loss	Factor	Pos	Pos	Avg.		
Simultaneously		( MHz )	( dBµV/m )	( dB )	( dBµV/m )	( dBµV )	( dB/m )	( dB )	( dB )	( cm )	( deg )	(P/A)	(H/V)	
802.11g CH13 2472MHz + 802.11ax HE160 CH15 6025MHz LF		30	22.59	-17.41	40	29.88	24.59	0.61	32.49	-	-	P	H	
		97.9	32.31	-11.19	43.5	47.93	15.57	1.3	32.49	-	-	P	H	
		131.85	24.58	-18.92	43.5	37.93	17.55	1.62	32.52	-	-	P	H	
		170.65	26.62	-16.88	43.5	41.72	15.57	1.82	32.49	-	-	P	H	
		188.11	25.25	-18.25	43.5	41.15	14.7	1.86	32.46	-	-	P	H	
		919.49	32.1	-13.9	46	30.11	29.33	4.16	31.5	-	-	P	H	
													H	
													H	
													H	
													H	
													H	
													H	
			34.85	29.77	-10.23	40	39.43	22.21	0.67	32.54	-	-	P	V
			65.89	24.25	-15.75	40	43.78	11.92	1.09	32.54	-	-	P	V
			94.02	26.31	-17.19	43.5	42.41	15.11	1.27	32.48	-	-	P	V
			127	20.54	-22.96	43.5	34.05	17.46	1.56	32.53	-	-	P	V
			170.65	24.14	-19.36	43.5	39.24	15.57	1.82	32.49	-	-	P	V
			824.43	35.57	-10.43	46	35.63	28.05	3.91	32.02	-	-	P	V
														V
														V
													V	
													V	
													V	
													V	
<b>Remark</b>	1. No other spurious found. 2. All results are PASS against Peak and Average limit line. 3. The emission level is with at least 6 dB margin against limit line, the position is marked as "-".													



**Note symbol**

*	<b>Fundamental Frequency</b> which can be ignored. However, the level of any unwanted emissions shall not exceed the level of the fundamental frequency.
!	Test result is <b>over limit</b> line.
P/A	<b>Peak</b> or <b>Average</b>
H/V	<b>Horizontal</b> or <b>Vertical</b>



A calculation example for radiated spurious emission is shown as below:

BLE	Note	Frequency	Level	Over	Limit	Read	Antenna	Path	Preamp	Ant	Table	Peak	Pol.
		( MHz )	( dBμV/m )	( dB )	( dBμV/m )	( dBμV )	( dB/m )	( dB )	( dB )	( cm )	( deg )	( P/A )	( H/V )
BLE CH 00 2402MHz		2390	55.45	-18.55	74	54.51	32.22	4.58	35.86	103	308	P	H
		2390	43.54	-10.46	54	42.6	32.22	4.58	35.86	103	308	A	H

1. Path Loss(dB) = Cable loss(dB) + Filter loss(dB) + Attenuator loss(dB)
2. Level(dBμV/m) =  
Antenna Factor(dB/m) + Path Loss(dB) + Read Level(dBμV) - Preamp Factor(dB)
3. Over Limit(dB) = Level(dBμV/m) – Limit Line(dBμV/m)

**For Peak Limit @ 2390MHz:**

1. Level(dBμV/m)  
= Antenna Factor(dB/m) + Path Loss(dB) + Read Level(dBμV) - Preamp Factor(dB)  
= 32.22(dB/m) + 4.58(dB) + 54.51(dBμV) – 35.86 (dB)  
= 55.45 (dBμV/m)
2. Over Limit(dB)  
= Level(dBμV/m) – Limit Line(dBμV/m)  
= 55.45(dBμV/m) – 74(dBμV/m)  
= -18.55(dB)

**For Average Limit @ 2390MHz:**

1. Level(dBμV/m)  
= Antenna Factor(dB/m) + Path Loss(dB) + Read Level(dBμV) - Preamp Factor(dB)  
= 32.22(dB/m) + 4.58(dB) + 42.6(dBμV) – 35.86 (dB)  
= 43.54 (dBμV/m)
2. Over Limit(dB)  
= Level(dBμV/m) – Limit Line(dBμV/m)  
= 43.54(dBμV/m) – 54(dBμV/m)  
= -10.46(dB)

**Both peak and average measured complies with the limit line, so test result is “PASS”.**



## Appendix B. Radiated Spurious Emission Plots

Test Engineer :	Leo Lee, Mancy Chou and Bigshow Wang	Temperature :	22.1~23.1°C
		Relative Humidity :	55~60%

### Note symbol

-L	Low channel location
-R	High channel location

### 2.4GHz 2400~2483.5MHz + Band 3 5470~5725MHz

MIMO <Ant. 4+3>\_BT\_Tx\_CH39 + MIMO <Ant. 4+3>\_802.11ax HE160\_Tx\_CH114 Full  
(Harmonic @ 3m)

BT +WIFI	2.4GHz 2400~2483.5MHz + Band 3 5470~5725MHz Harmonic @ 3m	
ANT	BT CH39 2441MHz + 802.11ax HE160 CH114 5570MHz	
Simultaneously	Horizontal	Vertical
<p><b>Peak</b></p> <p><b>Avg.</b></p>		



**Ant. 4\_BLE\_Tx\_CH39 + MIMO <Ant. 4+3>\_802.11ax HE160\_Tx\_CH114 Full  
(Harmonic @ 3m)**

<b>BT +WIFI</b>	<b>2.4GHz 2400~2483.5MHz + Band 3 5470~5725MHz Harmonic @ 3m</b>	
<b>ANT</b>	<b>BLE CH39 2480MHz + 802.11ax HE160 Full CH114 5570MHz</b>	
<b>Simultaneously</b>	<b>Horizontal</b>	<b>Vertical</b>
<b>Peak</b> <b>Avg.</b>	<p>Site : 03CH15-HY Condition : PEAK(UNIT) 3m 91200_1620_20211025 HORIZONTAL</p>	<p>Site : 03CH15-HY Condition : PEAK(UNIT) 3m 91200_1620_20211025 VERTICAL</p>

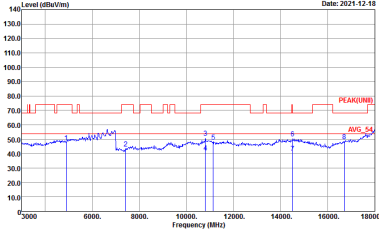
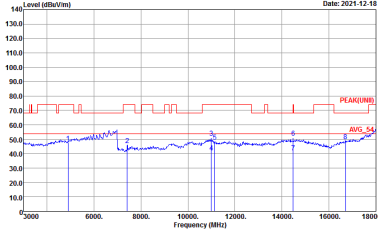

MIMO <Ant. 4+3>\_802.11g\_Tx\_CH13 + MIMO <Ant. 4+3>\_802.11ax HE160\_Tx\_CH114  
(Harmonic @ 3m)

WIFI	2.4GHz 2400~2483.5MHz + Band 3 5470~5725MHz Harmonic @ 3m	
ANT	802.11g CH13 2472MHz + 802.11ax HE160 Full CH114 5570MHz	
Simultaneously	Horizontal	Vertical
Peak Avg.	 <p>Site : 03CH15-HY Condition : PEAK[UNIT] 3m 91200_1620_20211025 HORIZONTAL</p>	 <p>Site : 03CH15-HY Condition : PEAK[UNIT] 3m 91200_1620_20211025 VERTICAL</p>





Emission below 1GHz

MIMO <Ant. 4+3>\_802.11g\_Tx\_CH13 + MIMO<Ant. 4+3>\_802.11ax HE160\_Tx\_CH114  
(LF @ 3m)

<b>WIFI</b>	<b>2.4GHz 2400~2483.5MHz + Band 3 5470~5725MHz</b>	
<b>ANT</b>	<b>802.11g LF + 802.11ax HE160 LF</b>	
<b>Simultaneously</b>	<b>Horizontal</b>	<b>Vertical</b>
<b>QP / Peak</b>	<p>Site : 03CH15-HY Condition : QP 3m B1LO6_41912_20210208 HORIZONTAL</p>	<p>Site : 03CH15-HY Condition : QP 3m B1LO6_41912_20210208 VERTICAL</p>



2.4GHz 2400~2483.5MHz + Band 5 5925~6425MHz

MIMO <Ant. 4+3>\_BT\_Tx\_CH39 + MIMO <Ant. 4+3>\_802.11ax HE160\_Tx\_CH15

(Harmonic @ 3m)

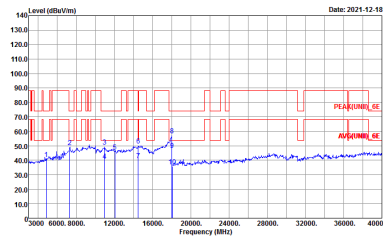
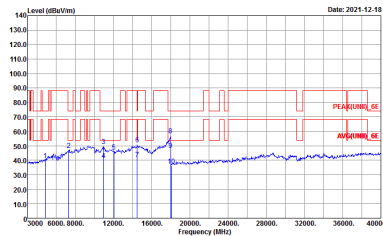
BT+ WIFI	2.4GHz 2400~2483.5MHz + Band 5 5925~6425MHz Harmonic @ 3m	
ANT	BT CH39 2441MHz + 802.11ax HE160 CH15 6025MHz	
Simultaneously	Horizontal	Vertical
<p style="text-align: center;"><b>Peak</b> <b>Avg.</b></p>	 <p style="font-size: small;">Site : 03CH15-HY Condition : PEAK(UNIT)_6E 3m 9120d_1620_20211025 HORIZONTAL</p>	 <p style="font-size: small;">Site : 03CH15-HY Condition : PEAK(UNIT)_6E 3m 9120d_1620_20211025 VERTICAL</p>

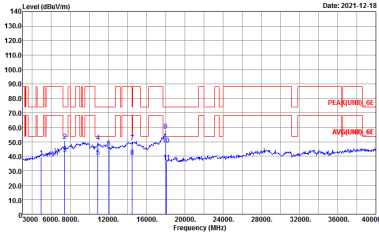
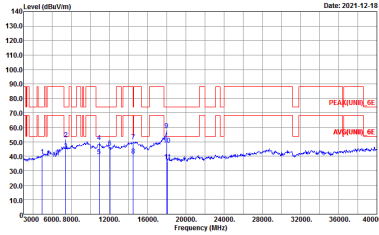

Ant. 4\_BLE\_Tx\_CH39 + MIMO<Ant. 4+3>\_802.11ax HE160\_Tx\_CH15 (Harmonic @ 3m)

BLE+WIFI	2.4GHz 2400~2483.5MHz + Band 5 5925~6425MHz Harmonic @ 3m	
ANT	BLE CH39 2480MHz + 802.11ax HE160 CH15 6025MHz	
Simultaneously	Horizontal	Vertical
<p style="text-align: center;"><b>Peak Avg.</b></p>	 <p>Site : 03CH15-HY Condition : PEA(UNII)_6E 3m 9120D_1620_20211025 HORIZONTAL</p>	 <p>Site : 03CH15-HY Condition : PEA(UNII)_6E 3m 9120D_1620_20211025 VERTICAL</p>

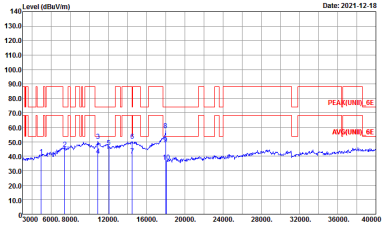
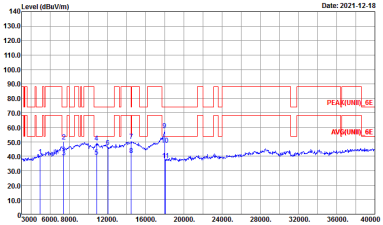

MIMO<Ant. 4+3>\_802.11g\_Tx\_CH13 + 802.11ax HE160\_Tx\_CH15 (Harmonic @ 3m)

<b>WIFI</b>	<b>2.4GHz 2400~2483.5MHz + Band 5 5925~6425MHz Harmonic @ 3m</b>	
<b>ANT</b>	<b>802.11g CH13 2472MHz + 802.11ax HE160 CH15 6025MHz</b>	
<b>Simultaneously</b>	<b>Horizontal</b>	<b>Vertical</b>
<p><b>Peak</b></p> <p><b>Avg.</b></p>	 <p>Site : 03CH15-HY Condition : PEAK(UNIT)_6E 3m 9120d_1620_20211025 HORIZONTAL</p>	 <p>Site : 03CH15-HY Condition : PEAK(UNIT)_6E 3m 9120d_1620_20211025 VERTICAL</p>



Emission below 1GHz

MIMO <Ant. 4+3>\_802.11g\_Tx\_CH13 + 802.11ax HE160\_Tx\_CH15 (LF @ 3m)

WIFI	2.4GHz 2400~2483.5MHz + Band 5 5925~6425MHz Harmonic @ 3m	
ANT	802.11g LF + 802.11ax HE160 LF	
Simultaneously	Horizontal	Vertical
QP / Peak		



# Appendix C. Duty Cycle Plots

MIMO <Ant. 4+3>

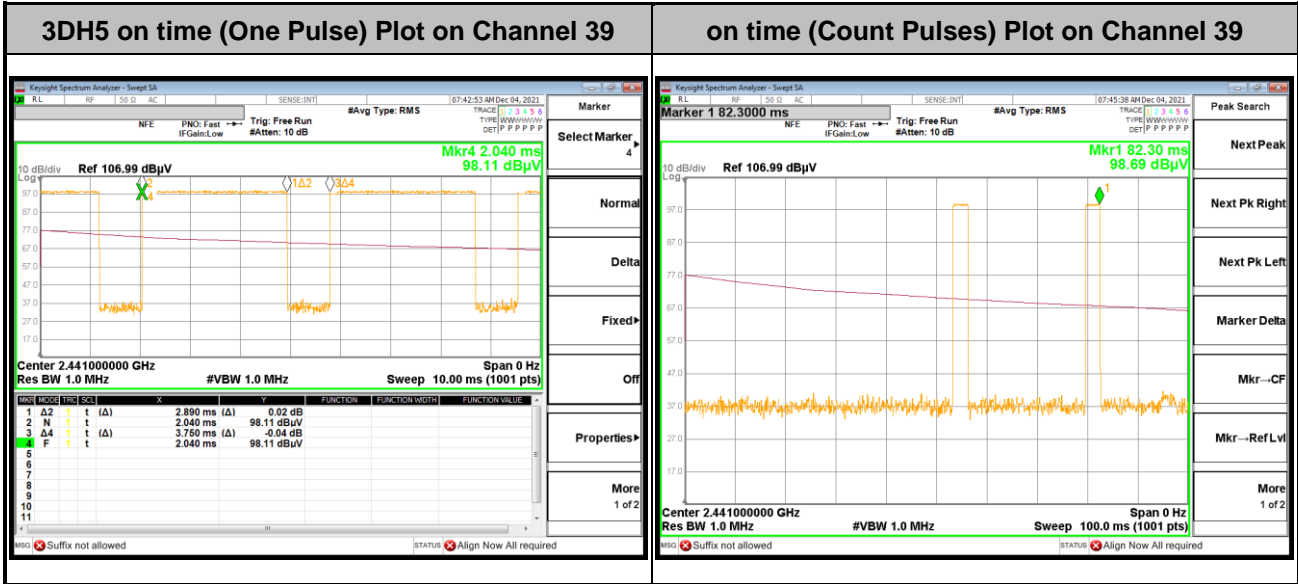

**Note:**

1. Worst case Duty cycle = on time/100 milliseconds =  $2 * 2.89 / 100 = 5.78 \%$
2. Worst case Duty cycle correction factor =  $20 * \log(\text{Duty cycle}) = -24.76 \text{ dB}$
3. 3DH5 has the highest duty cycle worst case and is reported.

### Duty Cycle Correction Factor Consideration for AFH mode:

Bluetooth normal hopping rate is 1600Hz and reduced to 800Hz in AFH mode; due to the reduced number of hopping frequencies, with the same packet configuration the dwell time in each channel frequency within 100msec period is longer in AFH mode than normal mode.

In AFH mode, the minimum hopping frequencies are 20, to get the longest dwell time DH5 packet is observed; the on time period to have DH5 packet completing one hopping sequence is

$$2.89 \text{ ms} \times 20 \text{ channels} = 57.8 \text{ ms}$$

There cannot be 2 complete hopping sequences within 100ms period, considering the random hopping behavior, maximum 2 hops can be possibly observed within the period.  $[100 \text{ ms} / 57.8 \text{ ms}] = 2 \text{ hops}$

Thus, the maximum possible ON time:

$$2.89 \text{ ms} \times 2 = 5.78 \text{ ms}$$

Worst case Duty Cycle Correction factor, which is derived from the maximum possible ON time,

$$20 \times \log(5.78\text{ms}/100 \text{ ms}) = -24.76 \text{ dB}$$



Antenna	Band	Duty Cycle(%)	T(us)	1/T(kHz)	VBW Setting
4	Bluetooth – LE for 1Mbps	60.58	378	2.65	3kHz
4+3	802.11g	93.46	0.70	1kHz	
4+3	5GHz 802.11ax HE160 Full RU	74.36	290	3.45	10kHz
4+3	6GHz 802.11ax HE160 Full RU	84.83	615	1.63	3kHz

<Ant. 4>

Bluetooth – LE for 1Mbps

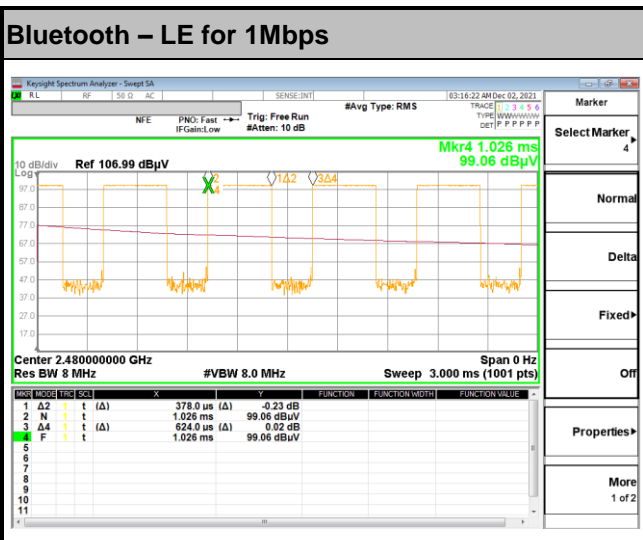

MIMO <Ant. 4+3>

802.11g

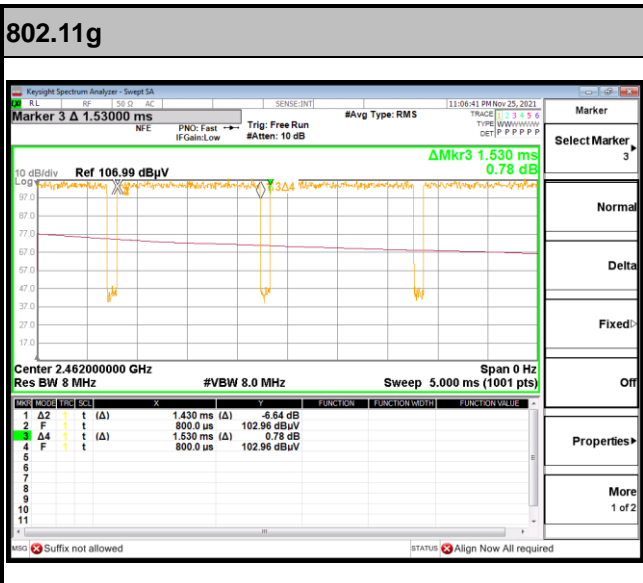

5GHz 802.11ax HE160 Full RU

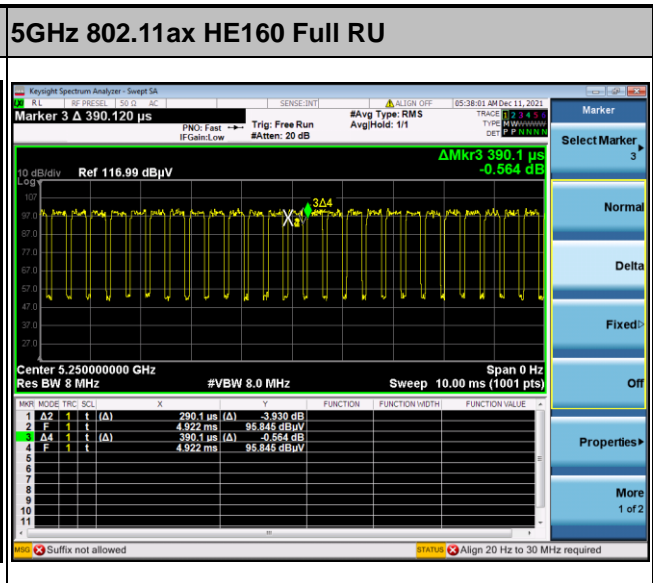

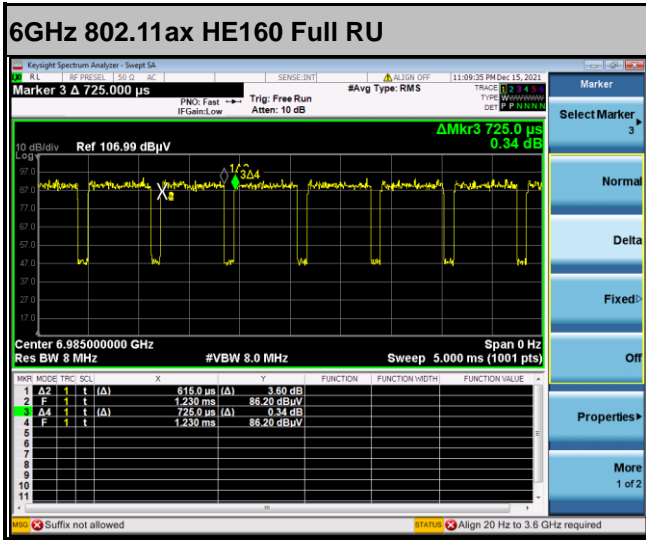

—THE END—