

FCC Test Report

(PART 90)

Report No.: RF181001C06-11

FCC ID: A4RG020A

Model Name: G020A

Received Date: Oct. 01, 2018

Test Date: Oct. 17, 2018 ~ Oct. 19, 2018

Issued Date: Dec. 27, 2018

Applicant: Google LLC

Address: 1600 Amphitheatre Parkway, Mountain View, CA 94043, USA

Issued By: Bureau Veritas Consumer Products Services (H.K.) Ltd., Taoyuan Branch

Lab Address: No. 47-2, 14th Ling, Chia Pau Vil., Lin Kou Dist., New Taipei City, Taiwan
(R.O.C)

Test Location (1): No. 19, Hwa Ya 2nd Rd, Wen Hwa Vil, Kwei Shan Dist., Taoyuan City
33383, Taiwan (R.O.C)

**FCC Registration /
Designation Number:** 788550 / TW0003



This report is for your exclusive use. Any copying or replication of this report to or for any other person or entity, or use of our name or trademark, is permitted only with our prior written permission. This report sets forth our findings solely with respect to the test samples identified herein. The results set forth in this report are not indicative or representative of the quality or characteristics of the lot from which a test sample was taken or any similar or identical product unless specifically and expressly noted. Our report includes all of the tests requested by you and the results thereof based upon the information that you provided to us. You have 60 days from date of issuance of this report to notify us of any material error or omission caused by our negligence, provided, however, that such notice shall be in writing and shall specifically address the issue you wish to raise. A failure to raise such issue within the prescribed time shall constitute your unqualified acceptance of the completeness of this report, the tests conducted and the correctness of the report contents. Unless specific mention, the uncertainty of measurement has been explicitly taken into account to declare the compliance or non-compliance to the specification. The report must not be used by the client to claim product certification, approval, or endorsement by TAF or any government agencies

Table of Contents

Release Control Record	3
1 Certificate of Conformity	4
2 Summary of Test Results	5
2.1 Measurement Uncertainty	6
2.2 Test Site and Instruments	7
3 General Information	9
3.1 General Description of EUT	9
3.2 Configuration of System under Test	10
3.2.1 Description of Support Units	10
3.3 Test Mode Applicability and Tested Channel Detail	11
3.4 EUT Operating Conditions	13
3.5 General Description of Applied Standards	13
4 Test Types and Results	14
4.1 Output Power Measurement	14
4.1.1 Limits of Output Power Measurement	14
4.1.2 Test Procedures	14
4.1.3 Test Setup	15
4.1.4 Test Results	16
4.2 Modulation Characteristics Measurement	22
4.2.1 Limits of Modulation Characteristics	22
4.2.2 Test Setup	22
4.2.3 Test Procedure	22
4.2.4 Test Results	23
4.3 Frequency Stability Measurement	24
4.3.1 Limits of Frequency Stability Measurement	24
4.3.2 Test Procedure	24
4.3.3 Test Setup	24
4.3.4 Test Results	25
4.4 Occupied Bandwidth Measurement	30
4.4.1 Limits of Occupied Bandwidth Measurement	30
4.4.2 Test Procedure	30
4.4.3 Test Setup	30
4.4.4 Test Results	31
4.5 Emission Mask Measurement	37
4.5.1 Limits of Emission Mask Measurement	37
4.5.2 Test Setup	37
4.5.3 Test Procedures	37
4.5.4 Test Results	38
4.6 Conducted Spurious Emissions	51
4.6.1 Limits of Conducted Spurious Emissions Measurement	51
4.6.2 Test Setup	51
4.6.3 Test Procedure	51
4.6.4 Test Results	52
4.7 Radiated Emission Measurement	57
4.7.1 Limits of Radiated Emission Measurement	57
4.7.2 Test Procedure	57
4.7.3 Deviation from Test Standard	57
4.7.4 Test Setup	58
4.7.5 Test Results	59
5 Pictures of Test Arrangements	79
Appendix – Information on the Testing Laboratories	80

Release Control Record

Issue No.	Description	Date Issued
RF181001C06-11	Original Release	Dec. 27, 2018

1 Certificate of Conformity

Product: Smartphone

Model Name: G020A

Sample Status: Identical Prototype

Applicant: Google LLC

Test Date: Oct. 17, 2018 ~ Oct. 19, 2018

Standards: FCC Part 90, Subpart I, S
FCC Part 2

The above equipment has been tested by **Bureau Veritas Consumer Products Services (H.K.) Ltd., Taoyuan Branch**, and found compliance with the requirement of the above standards. The test record, data evaluation & Equipment Under Test (EUT) configurations represented herein are true and accurate accounts of the measurements of the sample's RF characteristics under the conditions specified in this report.

Prepared by : , **Date:** Dec. 27, 2018
Ivonne Wu / Supervisor

Approved by : , **Date:** Dec. 27, 2018
Dylan Chiou / Project Engineer

2 Summary of Test Results

Applied Standard: FCC Part 90 & Part 2 (CDMA)			
FCC Clause	Test Item	Result	Remarks
2.1046 90.635 (b)	Effective Radiated Power	Pass	Meet the requirement of limit.
2.1047	Modulation Characteristics	Pass	Meet the requirement.
2.1055 90.213	Frequency Stability	Pass	Meet the requirement of limit.
2.1049 90.209	Occupied Bandwidth	Pass	Meet the requirement of limit.
2.1051 90.210	Emission Masks	Pass	Meet the requirement of limit.
2.1051 90.691	Conducted Spurious Emissions	Pass	Meet the requirement of limit.
2.1053 90.691	Radiated Spurious Emissions	Pass	Meet the requirement of limit. Minimum passing margin is -29.55 dB at 30.00 MHz.

Applied Standard: FCC Part 90 & Part 2 (LTE 26)			
FCC Clause	Test Item	Result	Remarks
2.1046 90.635 (b)	Effective Radiated Power	Pass	Meet the requirement of limit.
2.1047	Modulation Characteristics	Pass	Meet the requirement.
2.1055 90.213	Frequency Stability	Pass	Meet the requirement of limit.
2.1049 90.209	Occupied Bandwidth	Pass	Meet the requirement of limit.
2.1051 90.210	Emission Masks	Pass	Meet the requirement of limit.
2.1051 90.691	Conducted Spurious Emissions	Pass	Meet the requirement of limit.
2.1053 90.691	Radiated Spurious Emissions	Pass	Meet the requirement of limit. Minimum passing margin is -28.43 dB at 2457.00 MHz.

2.1 Measurement Uncertainty

Where relevant, the following measurement uncertainty levels have been estimated for tests performed on the EUT as specified in CISPR 16-4-2:

Measurement	Frequency	Expanded Uncertainty (k=2) (\pm)
Radiated Emissions up to 1 GHz	30 MHz ~ 200 MHz	2.93 dB
	200 MHz ~ 1000 MHz	2.95 dB
Radiated Emissions above 1 GHz	1 GHz ~ 18 GHz	2.26 dB
	18 GHz ~ 40 GHz	1.94 dB

2.2 Test Site and Instruments

Description & Manufacturer	Model No.	Serial No.	Date of Calibration	Due Date of Calibration
Test Receiver Agilent	N9038A	MY51210203	Mar. 16, 2018	Mar. 15, 2019
Spectrum Analyzer Keysight	N9010A	MY56070348	Sep. 06, 2018	Sep. 05, 2019
Spectrum Analyzer ROHDE & SCHWARZ	FSU43	101261	Jan. 11, 2018	Jan. 10, 2019
Spectrum Analyzer ROHDE & SCHWARZ	FSW26	102023	Oct. 11, 2018	Oct. 10, 2019
HORN Antenna SCHWARZBECK	BBHA 9120D	9120D-969	Dec. 12, 2017	Dec. 11, 2018
BILOG Antenna SCHWARZBECK	VULB 9168	9168-472	Dec. 06, 2017	Dec. 05, 2018
Fixed Attenuator Mini-Circuits	MDCS18N-10	MDCS18N-10-01	Apr. 16, 2018	Apr. 15, 2019
MXG Vector signal generator Agilent	N5182B	MY53052658	May 24, 2018	May 23, 2019
Preamplifier EMCI	EMC 012645	980115	Oct. 12, 2018	Oct. 11, 2019
Preamplifier EMCI	EMC 330H	980112	Oct. 12, 2018	Oct. 11, 2019
RF Coaxial Cable HUBER+SUHNNER	EMC104-SM-SM-800 0&3000	140811+170717	Oct. 12, 2018	Oct. 11, 2019
RF Coaxial Cable HUBER+SUHNNER	SUCOFLEX 104	EMC104-SM-SM-1 000(140807)	Oct. 12, 2018	Oct. 11, 2019
RF Coaxial Cable WOKEN	8D-FB	Cable-Ch10-01	Oct. 12, 2018	Oct. 11, 2019
Boresight Antenna Fixture	FBA-01	FBA-SIP01	NA	NA
Software BV ADT	E3 6.120103	NA	NA	NA
Antenna Tower MF	MFA-440H	NA	NA	NA
Turn Table MF	MFT-201SS	NA	NA	NA
Antenna Tower & Turn Table Controller MF	MF-7802	NA	NA	NA
Universal Radio Communication Tester R&S	CMU200	123112	Dec. 28, 2017	Dec. 27, 2018
Radio Communication Analyzer Anritsu	MT8820C	6201300640	Aug. 16, 2017	Aug. 15, 2019
Temperature & Humidity Chamber	GTH-120-40-CP-AR	MAA1306-019	Sep. 05, 2018	Sep. 04, 2019
DC Power Supply Topward	33010D	807748	NA	NA

- Note:
1. The calibration interval of the above test instruments is 12 / 24 months and the calibrations are traceable to NML/ROC and NIST/USA.
 2. The test was performed in HwaYa Chamber 10.
 3. The horn antenna and preamplifier (model: EMC 184045) are used only for the measurement of emission frequency above 1 GHz if tested.
 4. The IC Site Registration No. is 7450F-10.

3 General Information

3.1 General Description of EUT

Product	Smartphone	
Model Name	G020A	
Status of EUT	Identical Prototype	
Power Supply Rating	3.85 Vdc (Li-ion battery) 5.0 Vdc or 9 Vdc (adapter) 5.0 Vdc (host equipment)	
Modulation Type	CDMA	QPSK, OQPSK, HPSK
	LTE	QPSK, 16QAM, 64QAM
Frequency Range	CDMA BC10	817.9 ~ 823.1 MHz
	LTE Band 26 (Channel Bandwidth: 1.4 MHz)	814.7 ~ 823.3 MHz
	LTE Band 26 (Channel Bandwidth: 3 MHz)	815.5 ~ 822.5 MHz
	LTE Band 26 (Channel Bandwidth: 5 MHz)	816.5 ~ 821.5 MHz
	LTE Band 26 (Channel Bandwidth: 10 MHz)	819 MHz
Emission Designator	CDMA BC10	1M27F9W
	LTE Band 26 (Channel Bandwidth: 1.4 MHz)	1M09W7D
	LTE Band 26 (Channel Bandwidth: 3 MHz)	2M70W7D
	LTE Band 26 (Channel Bandwidth: 5 MHz)	4M50W7D
	LTE Band 26 (Channel Bandwidth: 10 MHz)	8M78W7D
Max. ERP Power	CDMA BC10	69.02 mW
	LTE Band 26 (Channel Bandwidth: 1.4 MHz)	68.08 mW
	LTE Band 26 (Channel Bandwidth: 3 MHz)	71.94 mW
	LTE Band 26 (Channel Bandwidth: 5 MHz)	75.86 mW
	LTE Band 26 (Channel Bandwidth: 10 MHz)	93.11 mW
Antenna Type	PIFA Antenna	
Antenna Gain	CDMA BC10	-5 dBi gain
	LTE Band 26	-4.7 dBi gain
Accessory Device	Refer to Note as below	
Data Cable Supplied	Refer to Note as below	

Note:

1. There're 2 configurations for the EUT listed as below.

Main Sample: EUT + Battery 1

2nd Sample: EUT + Battery 2

✧ After pre-tested with the EUT, only the worst configuration (main sample) was chosen for the final test.

2. The EUT's accessories list refers to Ext. Pho.

3. The above EUT information is declared by manufacturer and for more detailed features description, please refers to the manufacturer's specifications or user's manual.

3.2 Configuration of System under Test

<Radiated Emission Test>

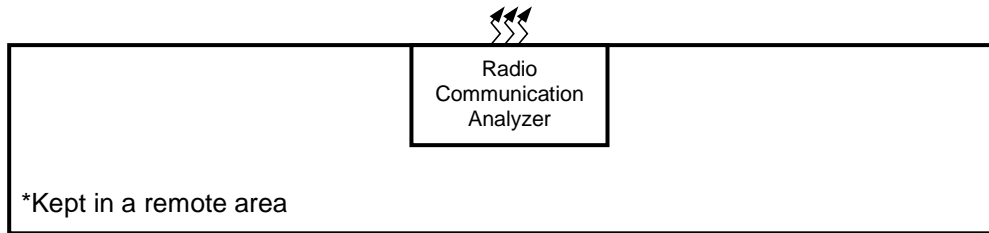
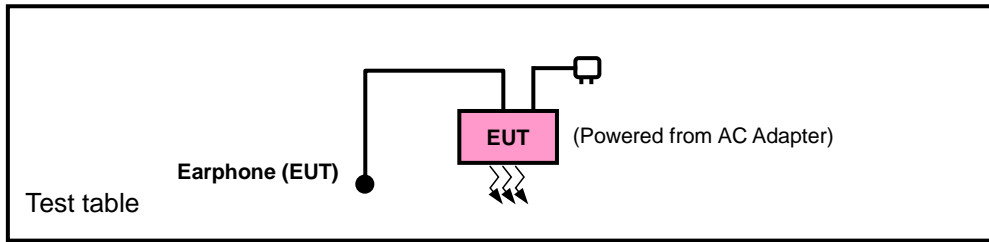

<E.R.P. Test>

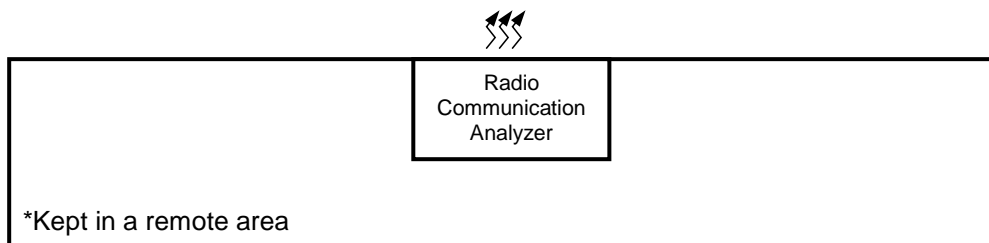
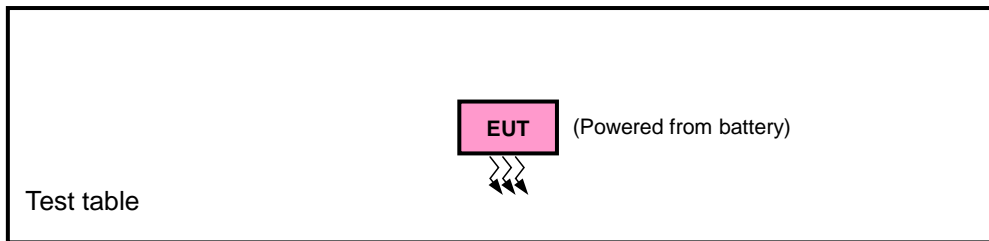

3.2.1 Description of Support Units

The EUT has been tested as an independent unit together with other necessary accessories or support units.

3.3 Test Mode Applicability and Tested Channel Detail

Pre-Scan has been conducted to determine the worst-case mode from all possible combinations between available modulations, data rates, XYZ axis, and antenna ports

The worst case was found when positioned as the table below. Following channel(s) was (were) selected for the final test as listed below:

Band	ERP	Radiated Emission
CDMA	Y-plane	Y-axis
LTE Band 26	Y-plane	Z-axis

CDMA

EUT Configure Mode	Test Item	Available Channel	Tested Channel	Mode
-	ERP	476 to 684	476, 580, 684	1xRTT
-	Modulation Characteristics	476 to 684	580	1xRTT
-	Frequency Stability	476 to 684	476, 684	1xRTT
-	Occupied Bandwidth	476 to 684	476, 580, 684	1xRTT
-	Emission Mask	476 to 684	476, 580, 684	1xRTT
-	Conducted Emission	476 to 684	476, 580, 684	1xRTT
-	Radiated Emission	476 to 684	476, 580, 684	1xRTT

LTE Band 26

EUT Configure Mode	Test Item	Available Channel	Tested Channel	Channel Bandwidth	Modulation	Mode		
-	ERP	26697 to 26783	26697, 26740, 26783	1.4 MHz	QPSK, 16QAM, 64QAM	1 RB / 0 RB Offset		
		26705 to 26775	26705, 26740, 26775	3 MHz	QPSK, 16QAM, 64QAM	1 RB / 0 RB Offset		
		26715 to 26765	26715, 26740, 26765	5 MHz	QPSK, 16QAM, 64QAM	1 RB / 0 RB Offset		
		26740	26740	10 MHz	QPSK, 16QAM, 64QAM	1 RB / 0 RB Offset		
-	Modulation Characteristics	26715 to 26765	26740	5 MHz	QPSK, 16QAM, 64QAM	25 RB / 0 RB Offset		
-	Frequency Stability	26697 to 26783	26697, 26783	1.4 MHz	QPSK	1 RB / 0 RB Offset		
		26705 to 26775	26705, 26775	3 MHz	QPSK	1 RB / 0 RB Offset		
		26715 to 26765	26715, 26765	5 MHz	QPSK	1 RB / 0 RB Offset		
		26740	26740	10 MHz	QPSK	1 RB / 0 RB Offset		
-	Occupied Bandwidth	26697 to 26783	26697, 26740, 26783	1.4 MHz	QPSK, 16QAM, 64QAM	6 RB / 0 RB Offset		
		26705 to 26775	26705, 26740, 26775	3 MHz	QPSK, 16QAM, 64QAM	15 RB / 0 RB Offset		
		26715 to 26765	26715, 26740, 26765	5 MHz	QPSK, 16QAM, 64QAM	25 RB / 0 RB Offset		
		26740	26740	10 MHz	QPSK, 16QAM, 64QAM	50 RB / 0 RB Offset		
-	Emission Mask	26697 to 26783	26697	1.4 MHz	QPSK, 16QAM, 64QAM	1 RB / 0 RB Offset 6 RB / 0 RB Offset		
			26783	1.4 MHz	QPSK, 16QAM, 64QAM	1 RB / 5 RB Offset 6 RB / 0 RB Offset		
		26705 to 26775	26705	3 MHz	QPSK, 16QAM, 64QAM	1 RB / 0 RB Offset 15 RB / 0 RB Offset		
			26775	3 MHz	QPSK, 16QAM, 64QAM	1 RB / 14 RB Offset 15 RB / 0 RB Offset		
		26715 to 26765	26715	5 MHz	QPSK, 16QAM, 64QAM	1 RB / 0 RB Offset 25 RB / 0 RB Offset		
			26765	5 MHz	QPSK, 16QAM, 64QAM	1 RB / 24 RB Offset 25 RB / 0 RB Offset		
		26740	26740	10 MHz	QPSK, 16QAM, 64QAM	1 RB / 0 RB Offset 1 RB / 49 RB Offset 50 RB / 0 RB Offset		
		-	Conducted Emission	26697 to 26783	26697, 26740, 26783	1.4 MHz	QPSK	1 RB / 0 RB Offset
				26705 to 26775	26705, 26740, 26775	3 MHz	QPSK	1 RB / 0 RB Offset
				26715 to 26765	26715, 26740, 26765	5 MHz	QPSK	1 RB / 0 RB Offset
				26740	26740	10 MHz	QPSK	1 RB / 0 RB Offset
-	Radiated Emission	26697 to 26783	26697, 26740, 26783	1.4 MHz	QPSK	1 RB / 0 RB Offset		
		26715 to 26765	26715, 26740, 26765	5 MHz	QPSK	1 RB / 0 RB Offset		
		26740	26740	10 MHz	QPSK	1 RB / 0 RB Offset		

Note: This device was tested under all bandwidths, RB configurations and modulations. The worst case was found in QPSK modulation.

Test Condition:

Test Item	Environmental Conditions	Input Power	Tested By
ERP	25 deg. C, 65 % RH	3.85 Vdc	Thomas Wei
Frequency Stability	25 deg. C, 65 % RH	3.85 Vdc	Wayne Lin
Occupied Bandwidth	25 deg. C, 65 % RH	3.85 Vdc	Wayne Lin
Peak to Average Ratio	25 deg. C, 65 % RH	3.85 Vdc	Wayne Lin
Emission Mask	25 deg. C, 65 % RH	3.85 Vdc	Wayne Lin
Band Edge	25 deg. C, 65 % RH	3.85 Vdc	Wayne Lin
Conducted Emission	25 deg. C, 65 % RH	3.85 Vdc	Wayne Lin
Radiated Emission	25 deg. C, 65 % RH	120 Vac, 60 Hz	Thomas Wei

3.4 EUT Operating Conditions

The EUT makes a call to the communication simulator. The communication simulator station system controlled a EUT to export maximum output power under transmission mode and specific channel frequency

3.5 General Description of Applied Standards

The EUT is a RF Product. According to the specifications of the manufacturer, it must comply with the requirements of the following standards:

FCC 47 CFR Part 2

FCC 47 CFR Part 90

KDB 971168 D01 Power Meas License Digital Systems v03r01

KDB 971168 D02 Misc Rev Approv License Devices v02r01

ANSI/TIA/EIA-603-E 2016

ANSI 63.26-2015

Note: All test items have been performed and recorded as per the above standards.

4 Test Types and Results

4.1 Output Power Measurement

4.1.1 Limits of Output Power Measurement

The maximum output power of the transmitter for mobile stations is 100 watts (20 dBw).

4.1.2 Test Procedures

EIRP / ERP Measurement:

- a. All measurements were done at low, middle and high operational frequency range. RBW and VBW is 5 MHz for CDMA and 10 MHz for LTE mode.
- b. Substitution method is used for E.I.R.P measurement. In the semi-anechoic chamber, EUT placed on the 0.8 m (below or equal 1 GHz) and/or 1.5 m (above 1 GHz) height of Turn Table, rotated the table around 360 degrees to search the maximum radiation power and receiver antenna shall be rotated vertical and horizontal polarization and moved height from 1 m to 4 m to find the maximum polar radiated power. The "Read Value" is the spectrum reading the maximum power value.
- c. The substitution horn antenna is substituted for EUT at the same position and signals generator export the CW signal to the substitution antenna via a tx cable. Rotated the Turn Table and moved receiving antenna to find the maximum radiation power. Adjust output power level of S.G to get a Value of spectrum reading equal to "Read Value" of step b. Record the power level of S.G.
- d. $EIRP = \text{Output power level of S.G} - \text{TX cable loss} + \text{Antenna gain of substitution horn}$. E.R.P power can be calculated form E.I.R.P power by subtracting the gain of dipole, $E.R.P \text{ power} = E.I.P.R \text{ power} - 2.15 \text{ dB}$.

Conducted Power Measurement:

- a. The EUT was set up for the maximum power with CDMA and LTE link data modulation and link up with simulator.
- b. Set the EUT to transmit under low, middle and high channel and record the power level shown on simulator.

4.1.3 Test Setup

EIRP / ERP Measurement:

<Radiated Emission below or equal 1 GHz>

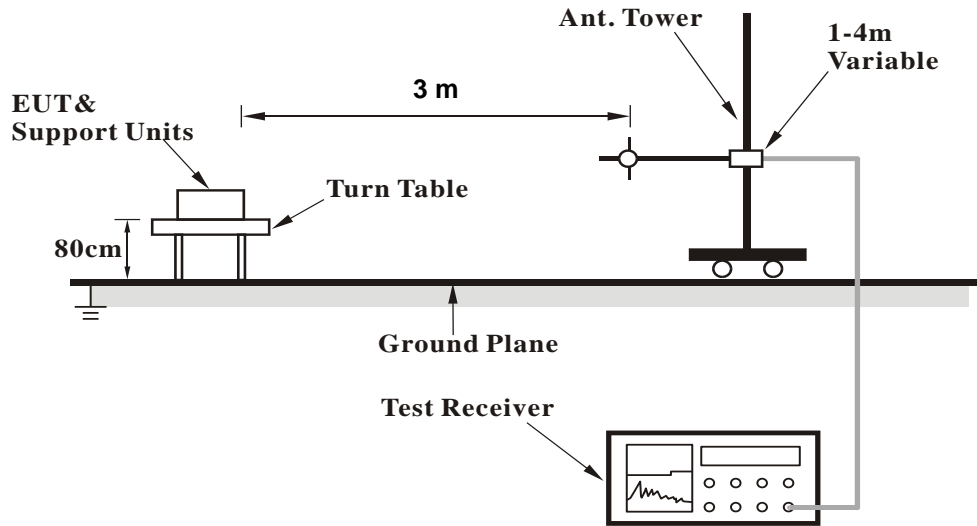

<Radiated Emission above 1 GHz>

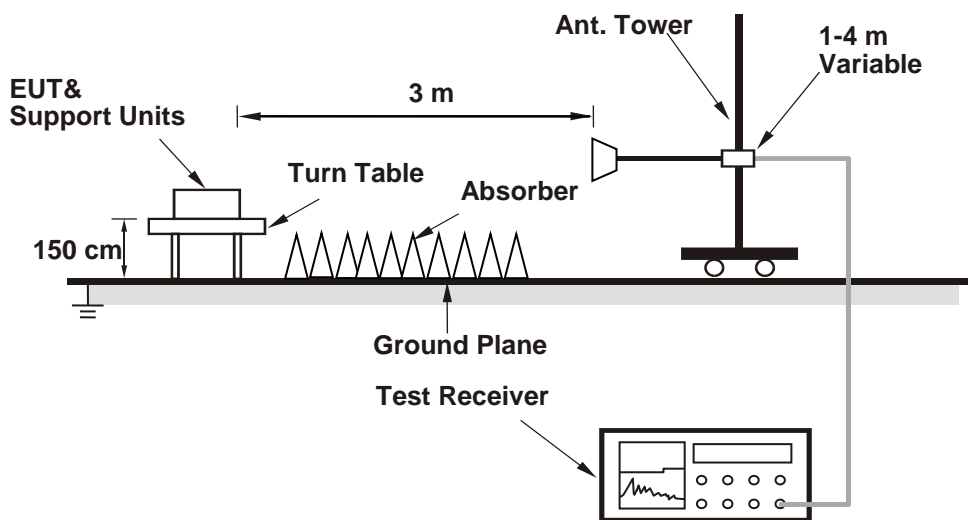

For the actual test configuration, please refer to the attached file (Test Setup Photo).

Conducted Power Measurement:

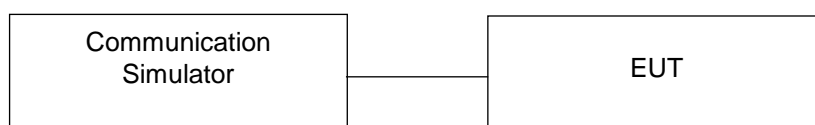

4.1.4 Test Results

The worst configuration mode is presented in the report as below. Please refer to SAR test report for more detail test mode.

Band		TX Antenna	WLAN Function	Body-Worn/Hotspot
CDMA	BC10	Ant 0	WLAN-Off	Body-Worn/Hotspot
LTE	B26	Ant 0	WLAN-Off	Body-Worn/Hotspot

Conducted Output Power (dBm)

Band	CDMA BC10		
Mode	Body-Worn / Hotspot		
Tx Antenna	Ant-0		
Channel	476	580	684
Frequency (MHz)	817.9	820.5	823.1
RC1+SO55	24.33	24.57	24.44
RC3+SO55	24.32	24.57	24.42
RC3+SO32(+ F-SCH)	24.33	24.57	24.43
RC3+SO32(+SCH)	24.33	24.56	24.44
RTAP 153.6	24.34	24.58	24.45
RETAP 4096	24.33	24.57	24.43

LTE Band 26
Body-Worn / Hotspot
Ant-0

BW	MCS Index	RB Size	RB Offset	Mid			3GPP MPR (dB)	BW	MCS Index	RB Size	RB Offset	Low	Mid	High	3GPP MPR (dB)		
				Channel	26740							26715	26740	26765			
				Frequency (MHz)	819.0							816.5	819.0	821.5			
10M	QPSK	1	0	24.40		0	5M	QPSK	1	0	24.34	24.39	24.50	0			
		1	24	24.45		0			1	12	24.30	24.43	24.45	0			
		1	49	24.24		0			1	24	24.09	24.21	24.31	0			
		25	0	23.54		1			12	0	23.53	23.53	23.56	1			
		25	12	23.42		1			12	6	23.28	23.40	23.47	1			
		25	25	23.39		1			12	13	23.32	23.36	23.45	1			
	16QAM	50	0	23.46		1		25	0	23.52	23.45	23.55	1				
		1	0	23.38		1		16QAM	1	0	23.40	23.37	23.44	1			
		1	24	23.30		1			1	12	23.20	23.28	23.45	1			
		1	49	23.27		1			1	24	23.15	23.24	23.24	1			
		25	0	22.47		2			12	0	22.42	22.46	22.50	2			
		25	12	22.39		2			12	6	22.27	22.37	22.40	2			
	25	25	22.39		2	12			13	22.23	22.36	22.45	2				
	64QAM	50	0	22.42		2		25	0	22.50	22.41	22.48	2				
		1	0	22.40		2		64QAM	1	0	22.34	22.39	22.41	2			
		1	24	22.36		2			1	12	22.33	22.34	22.37	2			
		1	49	22.22		2			1	24	22.21	22.19	22.31	2			
		25	0	21.48		3			12	0	21.37	21.47	21.50	3			
		25	12	21.41		3			12	6	21.39	21.39	21.43	3			
	25	25	21.36		3	12			13	21.27	21.33	21.41	3				
	3M	QPSK	50	0	21.44			3	25	0	21.34	21.43	21.51	3			
			1	0	24.35	24.37		24.44	0	1.4M	QPSK	1	0	24.35	24.33	24.47	0
			1	7	24.35	24.42		24.39	0			1	2	24.27	24.44	24.35	0
			1	14	24.27	24.12		24.21	0			1	5	24.08	24.22	24.25	0
8			0	23.34	23.52	23.53	1	3	0			24.37	24.42	24.51	0		
8			3	23.36	23.34	23.33	1	3	1			24.32	24.30	24.47	0		
8		7	23.30	23.28	23.34	1	3	3	24.26			24.36	24.42	0			
16QAM		15	0	23.44	23.36	23.44	1	6	0		23.45	23.42	23.54	1			
		1	0	23.42	23.24	23.32	1	16QAM	1		0	23.33	23.32	23.36	1		
		1	7	23.23	23.26	23.30	1		1		2	23.24	23.20	23.35	1		
		1	14	23.26	23.19	23.21	1		1		5	23.12	23.23	23.17	1		
		8	0	22.31	22.34	22.38	2		3		0	23.33	23.43	23.43	1		
		8	3	22.40	22.38	22.37	2		3		1	23.36	23.24	23.25	1		
8		7	22.24	22.31	22.45	2	3		3		23.40	23.34	23.31	1			
64QAM		15	0	22.44	22.32	22.34	2	6	0		22.23	22.30	22.44	2			
		1	0	22.32	22.33	22.38	2	64QAM	1		0	22.41	22.29	22.29	2		
		1	7	22.36	22.35	22.37	2		1		2	22.28	22.34	22.30	2		
		1	14	22.13	22.09	22.26	2		1		5	22.28	22.22	22.28	2		
		8	0	21.41	21.37	21.42	3		3		0	22.28	22.34	22.48	2		
		8	3	21.32	21.41	21.40	3		3		1	22.33	22.41	22.40	2		
8		7	21.34	21.21	21.26	3	3		3		22.22	22.30	22.27	2			
3M		64QAM	15	0	21.32	21.34	21.42	3	6		0	21.30	21.34	21.42	3		

ERP Power (dBm)

CDMA							
Plane	Channel	Frequency (MHz)	Reading (dBm)	Correction Factor (dB)	ERP (dBm)	ERP (mW)	Polarization (H/V)
Y	476	817.9	-10.89	31.208	18.17	65.61	H
	580	820.5	-10.63	31.3	18.52	71.12	
	684	823.1	-10.68	31.222	18.39	69.02	
	476	817.9	-18.96	31.504	10.39	10.94	V
	580	820.5	-18.28	31.117	10.69	11.72	
	684	823.1	-19.32	31.922	10.45	11.09	

Note: ERP (dBm) = Reading (dBm) + Correction Factor (dB) – 2.15

LTE Band 26							
Channel Bandwidth: 1.4 MHz / QPSK							
Plane	Channel	Frequency (MHz)	Reading (dBm)	Correction Factor (dB)	ERP (dBm)	ERP (mW)	Polarization (H/V)
Y	26697	814.7	-11.90	32.01	17.96	62.52	H
	26740	819.0	-11.63	32.11	18.33	68.08	
	26783	823.3	-12.02	32.32	18.15	65.31	
	26697	814.7	-19.88	32.54	10.51	11.25	V
	26740	819.0	-19.43	32.51	10.93	12.39	
	26783	823.3	-19.65	32.51	10.71	11.78	
Channel Bandwidth: 1.4 MHz / 16QAM							
Y	26697	814.7	-12.95	32.01	16.91	49.09	H
	26740	819.0	-12.68	32.11	17.28	53.46	
	26783	823.3	-13.07	32.32	17.10	51.29	
	26697	814.7	-20.93	32.54	9.46	8.83	V
	26740	819.0	-20.48	32.51	9.88	9.73	
	26783	823.3	-20.70	32.51	9.66	9.25	
Channel Bandwidth: 1.4 MHz / 64QAM							
Y	26697	814.7	-13.93	32.01	15.93	39.17	H
	26740	819.0	-13.66	32.11	16.30	42.66	
	26783	823.3	-14.05	32.32	16.12	40.93	
	26697	814.7	-21.91	32.54	8.48	7.05	V
	26740	819.0	-21.46	32.51	8.90	7.76	
	26783	823.3	-21.68	32.51	8.68	7.38	

Note: ERP (dBm) = Reading (dBm) + Correction Factor (dB) – 2.15

LTE Band 26							
Channel Bandwidth: 3 MHz / QPSK							
Plane	Channel	Frequency (MHz)	Reading (dBm)	Correction Factor (dB)	ERP (dBm)	ERP (mW)	Polarization (H/V)
Y	26705	815.5	-11.67	32.02	18.20	66.07	H
	26740	819.0	-11.39	32.11	18.57	71.94	
	26775	822.5	-11.64	32.18	18.39	69.02	
	26705	815.5	-19.60	32.5	10.75	11.89	V
	26740	819.0	-19.19	32.51	11.17	13.09	
	26775	822.5	-19.37	32.47	10.95	12.45	
Channel Bandwidth: 3 MHz / 16QAM							
Y	26705	815.5	-12.70	32.02	17.17	52.12	H
	26740	819.0	-12.42	32.11	17.54	56.75	
	26775	822.5	-12.67	32.18	17.36	54.45	
	26705	815.5	-20.63	32.5	9.72	9.38	V
	26740	819.0	-20.22	32.51	10.14	10.33	
	26775	822.5	-20.40	32.47	9.92	9.82	
Channel Bandwidth: 3 MHz / 64QAM							
Y	26705	815.5	-13.72	32.02	16.15	41.21	H
	26740	819.0	-13.44	32.11	16.52	44.87	
	26775	822.5	-13.69	32.18	16.34	43.05	
	26705	815.5	-21.65	32.5	8.70	7.41	V
	26740	819.0	-21.24	32.51	9.12	8.17	
	26775	822.5	-21.42	32.47	8.90	7.76	

Note: ERP (dBm) = Reading (dBm) + Correction Factor (dB) – 2.15

LTE Band 26							
Channel Bandwidth: 5 MHz / QPSK							
Plane	Channel	Frequency (MHz)	Reading (dBm)	Correction Factor (dB)	ERP (dBm)	ERP (mW)	Polarization (H/V)
Y	26715	816.5	-11.46	32.04	18.43	69.66	H
	26740	819.0	-11.16	32.11	18.80	75.86	
	26765	821.5	-11.02	31.79	18.62	72.78	
	26715	816.5	-19.39	32.52	10.98	12.53	V
	26740	819.0	-18.96	32.51	11.40	13.80	
	26765	821.5	-18.84	32.17	11.18	13.12	
Channel Bandwidth: 5 MHz / 16QAM							
Y	26715	816.5	-12.49	32.04	17.40	54.95	H
	26740	819.0	-12.19	32.11	17.77	59.84	
	26765	821.5	-12.05	31.79	17.59	57.41	
	26715	816.5	-20.42	32.52	9.95	9.89	V
	26740	819.0	-19.99	32.51	10.37	10.89	
	26765	821.5	-19.87	32.17	10.15	10.35	
Channel Bandwidth: 5 MHz / 64QAM							
Y	26715	816.5	-13.51	32.04	16.38	43.45	H
	26740	819.0	-13.21	32.11	16.75	47.32	
	26765	821.5	-13.07	31.79	16.57	45.39	
	26715	816.5	-21.44	32.52	8.93	7.82	V
	26740	819.0	-21.01	32.51	9.35	8.61	
	26765	821.5	-20.89	32.17	9.13	8.18	

Note: ERP (dBm) = Reading (dBm) + Correction Factor (dB) – 2.15

LTE Band 26							
Channel Bandwidth: 10 MHz / QPSK							
Plane	Channel	Frequency (MHz)	Reading (dBm)	Correction Factor (dB)	ERP (dBm)	ERP (mW)	Polarization (H/V)
Y	26740	819.0	-10.27	32.11	19.69	93.11	H
	26740	819.0	-18.04	32.51	12.32	17.06	V
Channel Bandwidth: 10 MHz / 16QAM							
Y	26740	819.0	-11.28	32.11	18.68	73.79	H
	26740	819.0	-19.05	32.51	11.31	13.52	V
Channel Bandwidth: 10 MHz / 64QAM							
Y	26740	819.0	-12.31	32.11	17.65	58.21	H
	26740	819.0	-20.08	32.51	10.28	10.67	V

Note: ERP (dBm) = Reading (dBm) + Correction Factor (dB) – 2.15

4.2 Modulation Characteristics Measurement

4.2.1 Limits of Modulation Characteristics

N/A

4.2.2 Test Setup

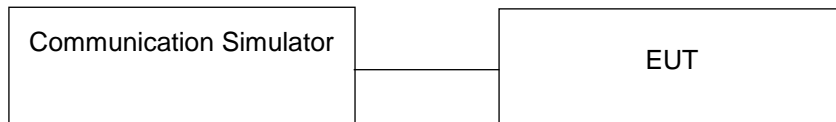

4.2.3 Test Procedure

Connect the EUT to Communication Simulator via the antenna connector. The frequency band is set as EUT supported Modulation and Channels, the EUT output is matched with 50 ohm load, the waveform quality and constellation of the EUT was tested.

4.2.4 Test Results

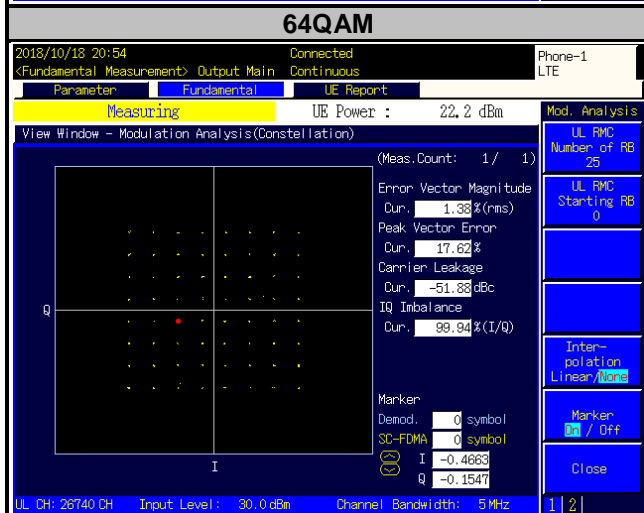
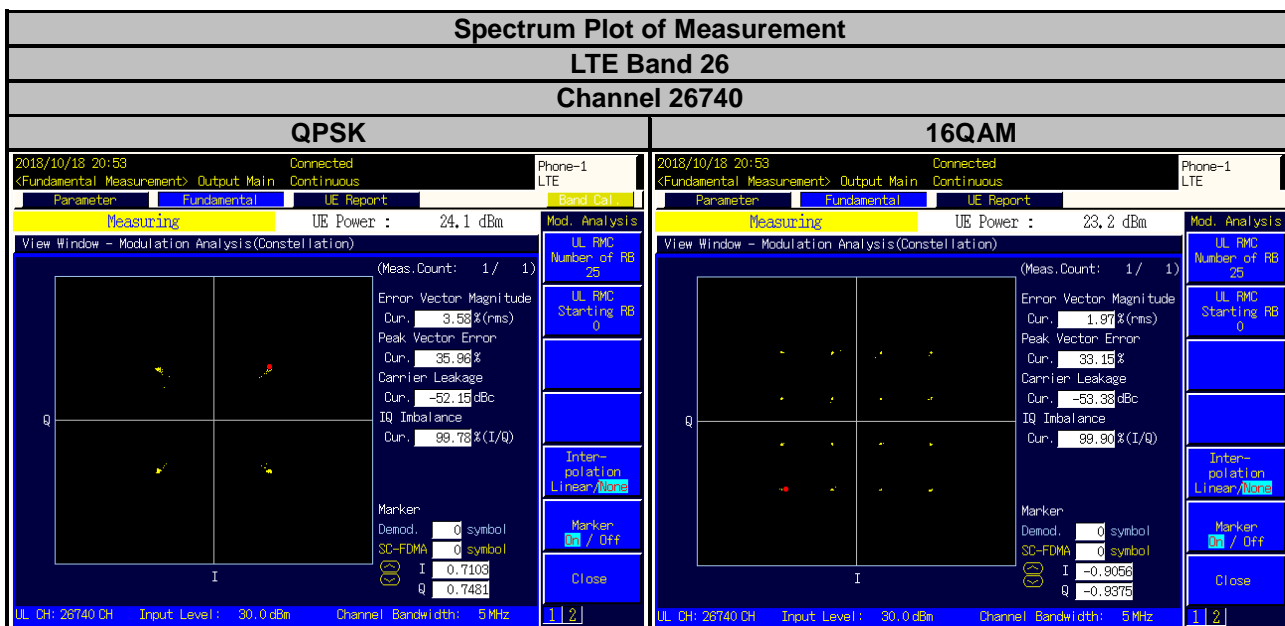
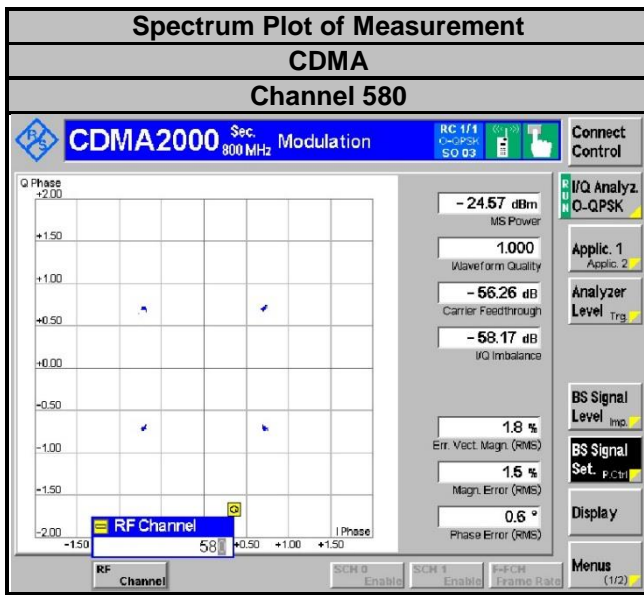

4.3 Frequency Stability Measurement

4.3.1 Limits of Frequency Stability Measurement

1.5 ppm is for base and fixed station. 2.5 ppm is for mobile station.

4.3.2 Test Procedure

- a. Device is placed at the oven room. The oven room could control the temperatures and humidity. Power warm up is at least 15 min and power applied should perform before recording frequency error.
- b. EUT is connected the external power supply to control the DC input power. The test voltage range is from minimum to maximum working voltage. Each step shall be record the frequency error rate.
- c. The temperature range step is 10 degrees in this test items. All temperature levels shall be hold the ± 0.5 °C during the measurement testing. The each temperature step shall be at least 0.5 hours, consider the EUT could be test under the stability condition.

NOTE: The frequency error was recorded frequency error from the communication simulator.

4.3.3 Test Setup

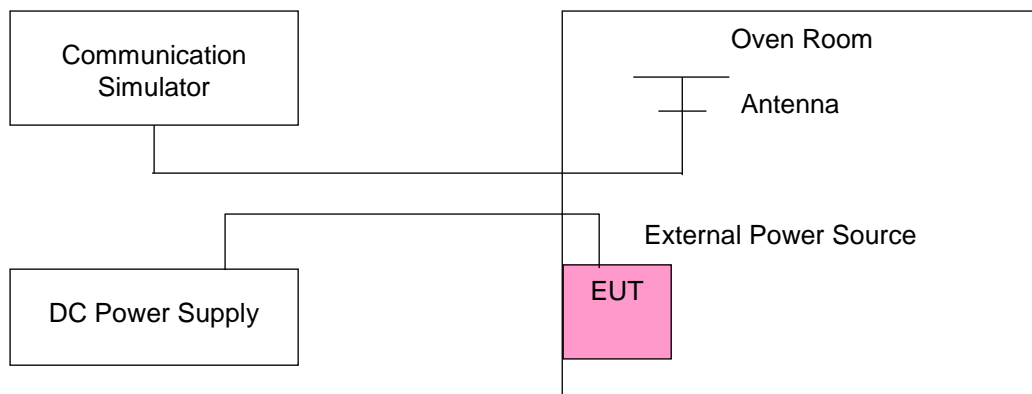

4.3.4 Test Results

Frequency Error vs. Voltage

Voltage (Volts)	CDMA				Limit (ppm)
	Low Channel		High Channel		
	Frequency (MHz)	Frequency Error (ppm)	Frequency (MHz)	Frequency Error (ppm)	
3.85	817.900001	0.002	823.100003	0.003	2.5
3.6	817.900004	0.005	823.100004	0.005	2.5
4.4	817.900003	0.003	823.100002	0.002	2.5

Note: The applicant defined the normal working voltage of the battery is from 3.6 Vdc to 4.4 Vdc.

Frequency Error vs. Temperature

Temp. (°C)	CDMA				Limit (ppm)
	Low Channel		High Channel		
	Frequency (MHz)	Frequency Error (ppm)	Frequency (MHz)	Frequency Error (ppm)	
-30	817.900004	0.005	823.100002	0.002	2.5
-20	817.900003	0.003	823.100004	0.005	2.5
-10	817.900004	0.004	823.100002	0.003	2.5
0	817.900003	0.004	823.100003	0.003	2.5
10	817.900001	0.001	823.100004	0.004	2.5
20	817.899997	-0.003	823.099997	-0.004	2.5
30	817.899998	-0.002	823.099997	-0.003	2.5
40	817.899999	-0.002	823.099999	-0.001	2.5
50	817.899998	-0.003	823.099998	-0.002	2.5
55	817.899997	-0.003	823.099997	-0.004	2.5

Frequency Error vs. Voltage

Voltage (Volts)	LTE Band 26				Limit (ppm)
	Channel Bandwidth: 1.4 MHz				
	Low Channel		High Channel		
	Frequency (MHz)	Frequency Error (ppm)	Frequency (MHz)	Frequency Error (ppm)	
3.85	814.700003	0.004	823.300000	0.004	2.5
3.6	814.700004	0.005	823.300000	0.003	2.5
4.4	814.700003	0.004	823.300000	0.002	2.5

Note: The applicant defined the normal working voltage of the battery is from 3.6 Vdc to 4.4 Vdc.

Frequency Error vs. Temperature

Temp. (°C)	LTE Band 26				Limit (ppm)
	Channel Bandwidth: 1.4 MHz				
	Low Channel		High Channel		
	Frequency (MHz)	Frequency Error (ppm)	Frequency (MHz)	Frequency Error (ppm)	
-30	814.700004	0.005	823.300000	0.004	2.5
-20	814.700002	0.002	823.300000	0.004	2.5
-10	814.700002	0.002	823.300000	0.002	2.5
0	814.700004	0.005	823.300000	0.002	2.5
10	814.700003	0.003	823.300000	0.004	2.5
20	814.699997	-0.004	823.300000	-0.004	2.5
30	814.699997	-0.003	823.300000	-0.004	2.5
40	814.699997	-0.004	823.300000	-0.002	2.5
50	814.699999	-0.001	823.300000	-0.002	2.5
55	814.699997	-0.004	823.300000	-0.002	2.5

Frequency Error vs. Voltage

Voltage (Volts)	LTE Band 26				Limit (ppm)
	Channel Bandwidth: 3 MHz				
	Low Channel		High Channel		
	Frequency (MHz)	Frequency Error (ppm)	Frequency (MHz)	Frequency Error (ppm)	
3.85	815.500002	0.002	822.500000	0.003	2.5
3.6	815.500004	0.005	822.500000	0.002	2.5
4.4	815.500001	0.001	822.500000	0.003	2.5

Note: The applicant defined the normal working voltage of the battery is from 3.6 Vdc to 4.4 Vdc.

Frequency Error vs. Temperature

Temp. (°C)	LTE Band 26				Limit (ppm)
	Channel Bandwidth: 3 MHz				
	Low Channel		High Channel		
	Frequency (MHz)	Frequency Error (ppm)	Frequency (MHz)	Frequency Error (ppm)	
-30	815.500003	0.003	822.500000	0.005	2.5
-20	815.500001	0.001	822.500000	0.004	2.5
-10	815.500002	0.003	822.500000	0.003	2.5
0	815.500004	0.005	822.500000	0.002	2.5
10	815.500003	0.003	822.500000	0.005	2.5
20	815.499996	-0.004	822.500000	-0.005	2.5
30	815.499998	-0.002	822.500000	-0.003	2.5
40	815.499996	-0.005	822.500000	-0.002	2.5
50	815.499997	-0.004	822.500000	-0.003	2.5
55	815.499996	-0.005	822.500000	-0.002	2.5

Frequency Error vs. Voltage

Voltage (Volts)	LTE Band 26				Limit (ppm)
	Channel Bandwidth: 5 MHz				
	Low Channel		High Channel		
	Frequency (MHz)	Frequency Error (ppm)	Frequency (MHz)	Frequency Error (ppm)	
3.85	816.500003	0.003	821.500000	0.002	2.5
3.6	816.500002	0.003	821.500000	0.003	2.5
4.4	816.500004	0.004	821.500000	0.004	2.5

Note: The applicant defined the normal working voltage of the battery is from 3.6 Vdc to 4.4 Vdc.

Frequency Error vs. Temperature

Temp. (°C)	LTE Band 26				Limit (ppm)
	Channel Bandwidth: 5 MHz				
	Low Channel		High Channel		
	Frequency (MHz)	Frequency Error (ppm)	Frequency (MHz)	Frequency Error (ppm)	
-30	816.500002	0.003	821.500000	0.002	2.5
-20	816.500003	0.004	821.500000	0.004	2.5
-10	816.500003	0.004	821.500000	0.003	2.5
0	816.500003	0.004	821.500000	0.003	2.5
10	816.500003	0.003	821.500000	0.002	2.5
20	816.499998	-0.003	821.500000	-0.005	2.5
30	816.499998	-0.002	821.500000	-0.003	2.5
40	816.499997	-0.003	821.500000	-0.004	2.5
50	816.499999	-0.002	821.500000	-0.003	2.5
55	816.499999	-0.002	821.500000	-0.002	2.5

Frequency Error vs. Voltage

Voltage (Volts)	LTE Band 26		Limit (ppm)
	Channel Bandwidth: 10 MHz		
	Frequency (MHz)	Frequency Error (ppm)	
3.85	819.000003	0.003	2.5
3.6	819.000004	0.005	2.5
4.4	819.000002	0.003	2.5

Note: The applicant defined the normal working voltage of the battery is from 3.6 Vdc to 4.4 Vdc.

Frequency Error vs. Temperature

Temp. (°C)	LTE Band 26		Limit (ppm)
	Channel Bandwidth: 10 MHz		
	Frequency (MHz)	Frequency Error (ppm)	
-30	819.000004	0.004	2.5
-20	819.000002	0.003	2.5
-10	819.000003	0.004	2.5
0	819.000003	0.004	2.5
10	819.000003	0.004	2.5
20	818.999997	-0.004	2.5
30	818.999996	-0.005	2.5
40	818.999997	-0.004	2.5
50	818.999996	-0.005	2.5
55	818.999998	-0.002	2.5

4.4 Occupied Bandwidth Measurement

4.4.1 Limits of Occupied Bandwidth Measurement

The width of a frequency band such that, below the lower and above the upper frequency limits, the mean powers emitted are each equal to a specified percentage 0.5 % of the total mean power of a given emission.

4.4.2 Test Procedure

The EUT makes a call to the communication simulator. All measurements were done at low, middle and high operational frequency range. The communication simulator station system controlled a EUT to export maximum output power under transmission mode and specific channel frequency. Use OBW measurement function of Spectrum analyzer to measure 99 % occupied bandwidth.

4.4.3 Test Setup

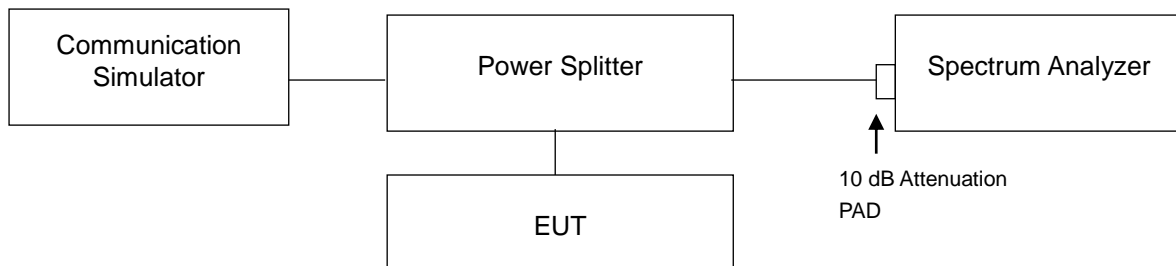

4.4.4 Test Results

<99 % Occupied Bandwidth>

CDMA		
Channel	Frequency (MHz)	99 % Occupied Bandwidth (MHz)
476	817.9	1.2729
580	820.5	1.2746
684	823.1	1.2747

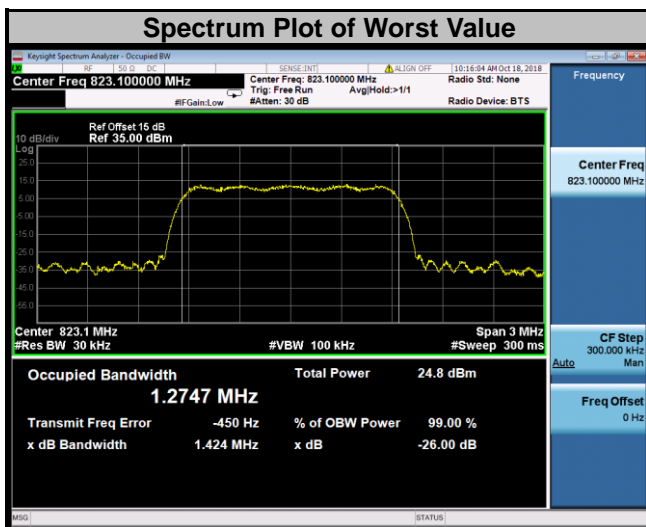

LTE Band 26									
Channel Bandwidth: 1.4 MHz					Channel Bandwidth: 3 MHz				
Channel	Frequency (MHz)	99 % Occupied Bandwidth (MHz)			Channel	Frequency (MHz)	99 % Occupied Bandwidth (MHz)		
		QPSK	16QAM	64QAM			QPSK	16QAM	64QAM
26697	814.7	1.0857	1.0896	1.0901	26705	815.5	2.6996	2.6970	2.6953
26740	819.0	1.0869	1.0901	1.0894	26740	819.0	2.6995	2.6975	2.6958
26783	823.3	1.0885	1.0890	1.0890	26775	822.5	2.6987	2.6974	2.6977

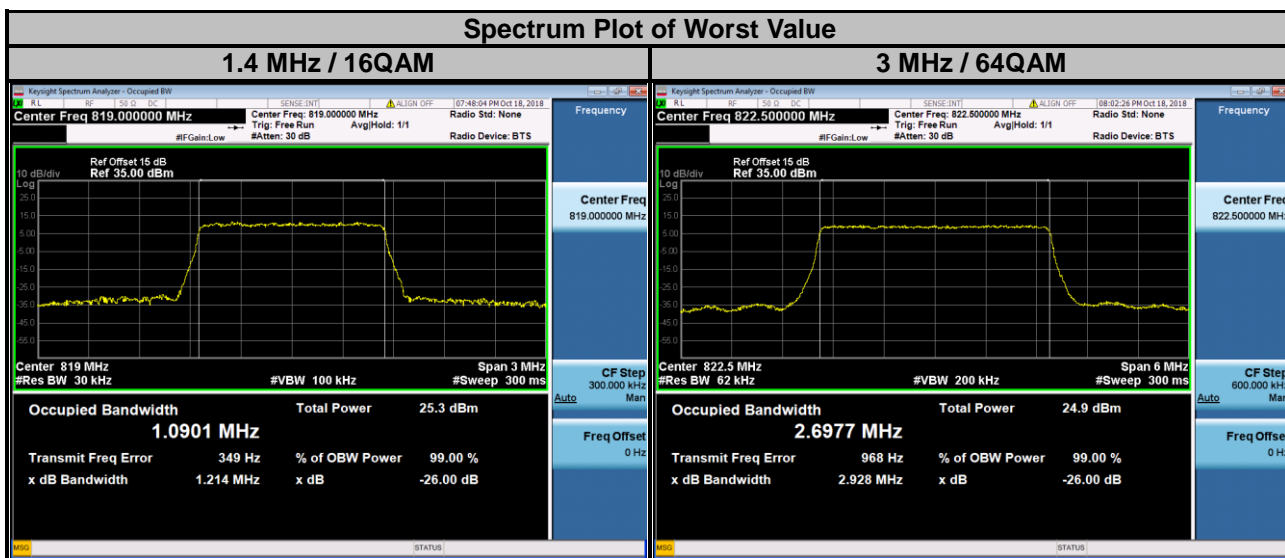

LTE Band 26									
Channel Bandwidth: 5 MHz					Channel Bandwidth: 10 MHz				
Channel	Frequency (MHz)	99 % Occupied Bandwidth (MHz)			Channel	Frequency (MHz)	99 % Occupied Bandwidth (MHz)		
		QPSK	16QAM	64QAM			QPSK	16QAM	64QAM
26715	816.5	4.4885	4.4907	4.4940	26740	819.0	8.9713	8.9775	8.9746
26740	819.0	4.4929	4.4964	4.4942					
26765	821.5	4.4890	4.4938	4.4928					

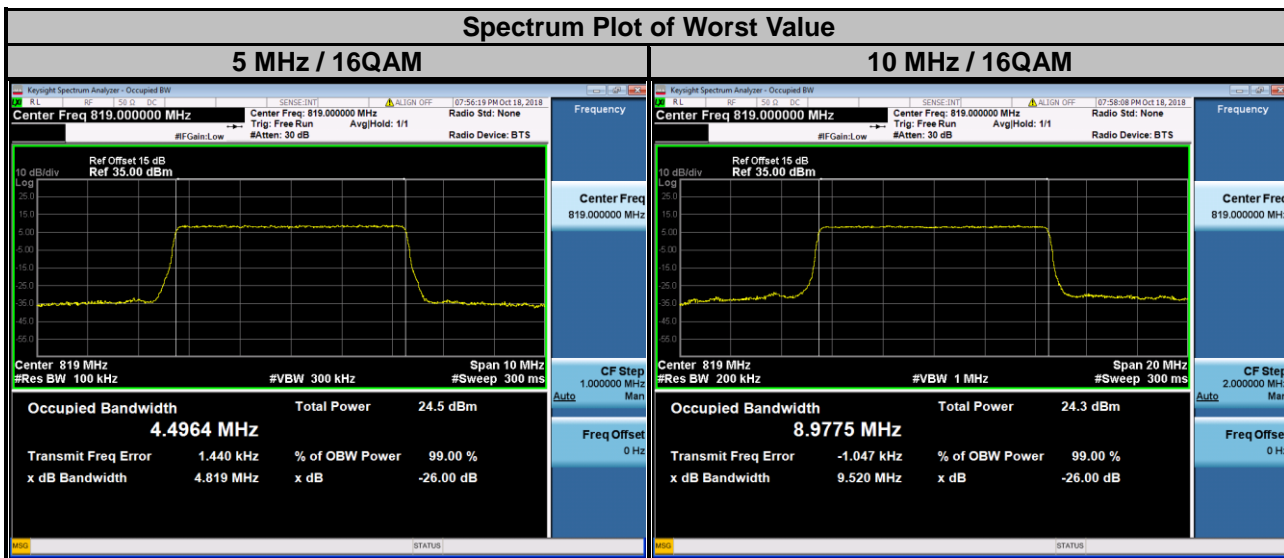

<26 dB Bandwidth>

CDMA		
Channel	Frequency (MHz)	26 dB Bandwidth (MHz)
476	817.9	1.426
580	820.5	1.425
684	823.1	1.424

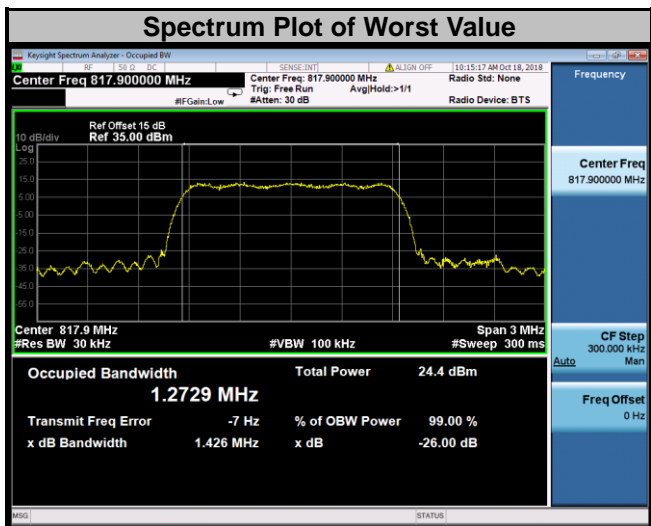

LTE Band 26									
Channel Bandwidth: 1.4 MHz					Channel Bandwidth: 3 MHz				
Channel	Frequency (MHz)	26 dB Bandwidth (MHz)			Channel	Frequency (MHz)	26 dB Bandwidth (MHz)		
		QPSK	16QAM	64QAM			QPSK	16QAM	64QAM
26697	814.7	1.219	1.215	1.211	26705	815.5	2.929	2.933	2.928
26740	819.0	1.220	1.214	1.211	26740	819.0	2.939	2.931	2.922
26783	823.3	1.220	1.214	1.213	26775	822.5	2.940	2.918	2.928

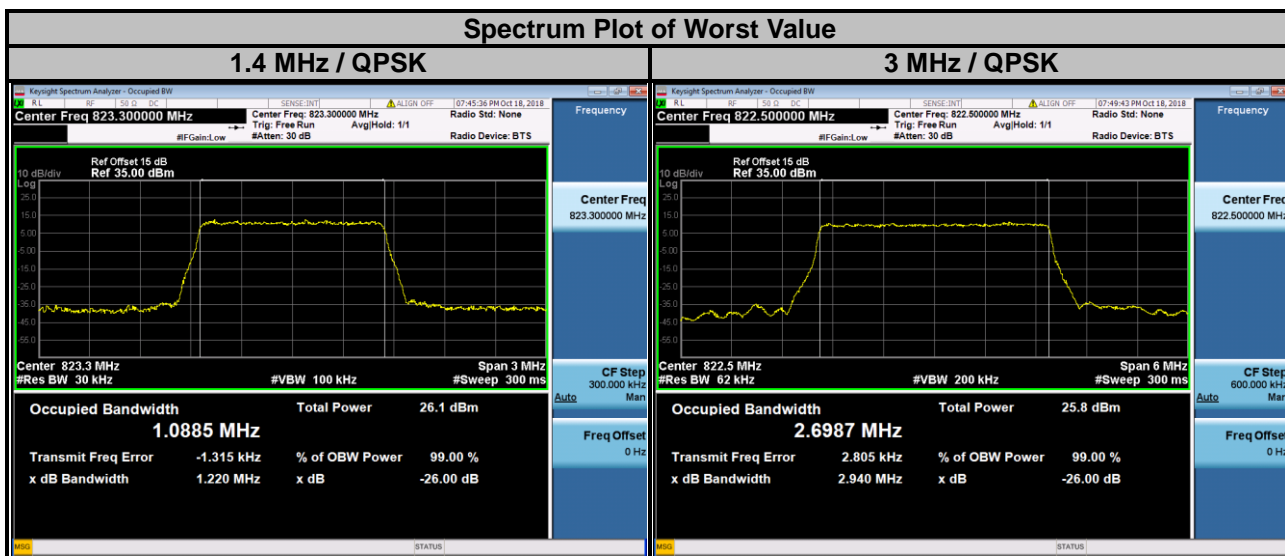

LTE Band 26									
Channel Bandwidth: 5 MHz					Channel Bandwidth: 10 MHz				
Channel	Frequency (MHz)	26 dB Bandwidth (MHz)			Channel	Frequency (MHz)	26 dB Bandwidth (MHz)		
		QPSK	16QAM	64QAM			QPSK	16QAM	64QAM
26715	816.5	4.823	4.809	4.804	26740	819.0	9.532	9.520	9.526
26740	819.0	4.822	4.819	4.806					
26765	821.5	4.819	4.794	4.810					

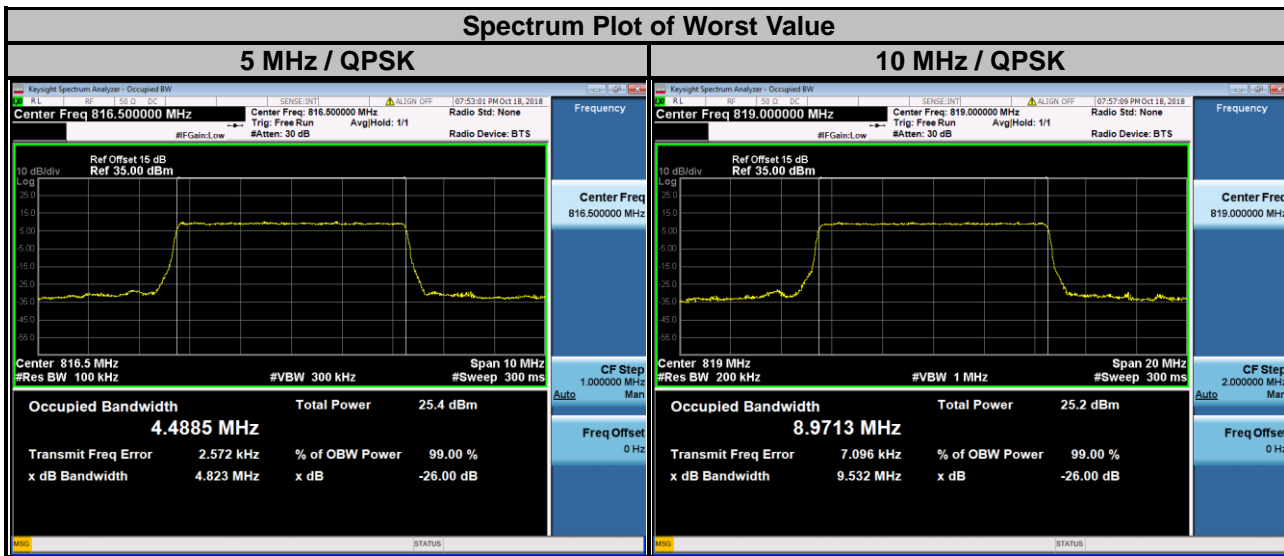

4.5 Emission Mask Measurement

4.5.1 Limits of Emission Mask Measurement

CDMA / LTE Band 26

According to FCC part 90.691 shall be tested the emission mask. For any frequency removed from the EA licensee's frequency block by up to and including 37.5 kHz, the power of any emission shall be attenuated below the transmitter power (P) in watts by at least $116 \text{ Log}_{10}(f/6.1)$ decibels or $50 + 10\text{Log}_{10}(P)$ decibels or 80 decibels, whichever is the lesser attenuation, where f is the frequency removed from the center of the outer channel in the block in kilohertz and where f is greater than 12.5 kHz.

For any frequency removed from the EA licensee's frequency block greater than 37.5 kHz, the power of any emission shall be attenuated below the transmitter power (P) in watts by at least $43 + 10\text{Log}_{10}(P)$ decibels or 80 decibels, whichever is the lesser attenuation, where f is the frequency removed from the center of the outer channel in the block in kilohertz and where f is greater than 37.5 kHz.

For §90.691(a), RBW=300 Hz for offset less than 37.5 kHz from channel edge and RBW=100 kHz for offsets greater than 37.5 kHz is allowed.

4.5.2 Test Setup

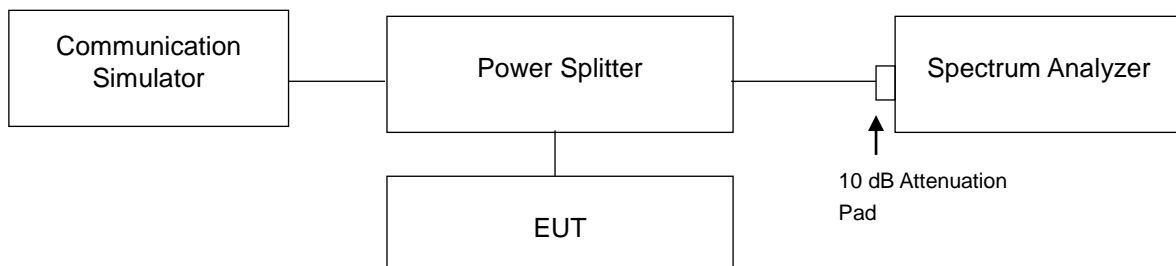

4.5.3 Test Procedures

- The measurement used the power splitter via EUT RF power connector between simulation base station and spectrum analyzer.
- Record the test plot.

4.5.4 Test Results

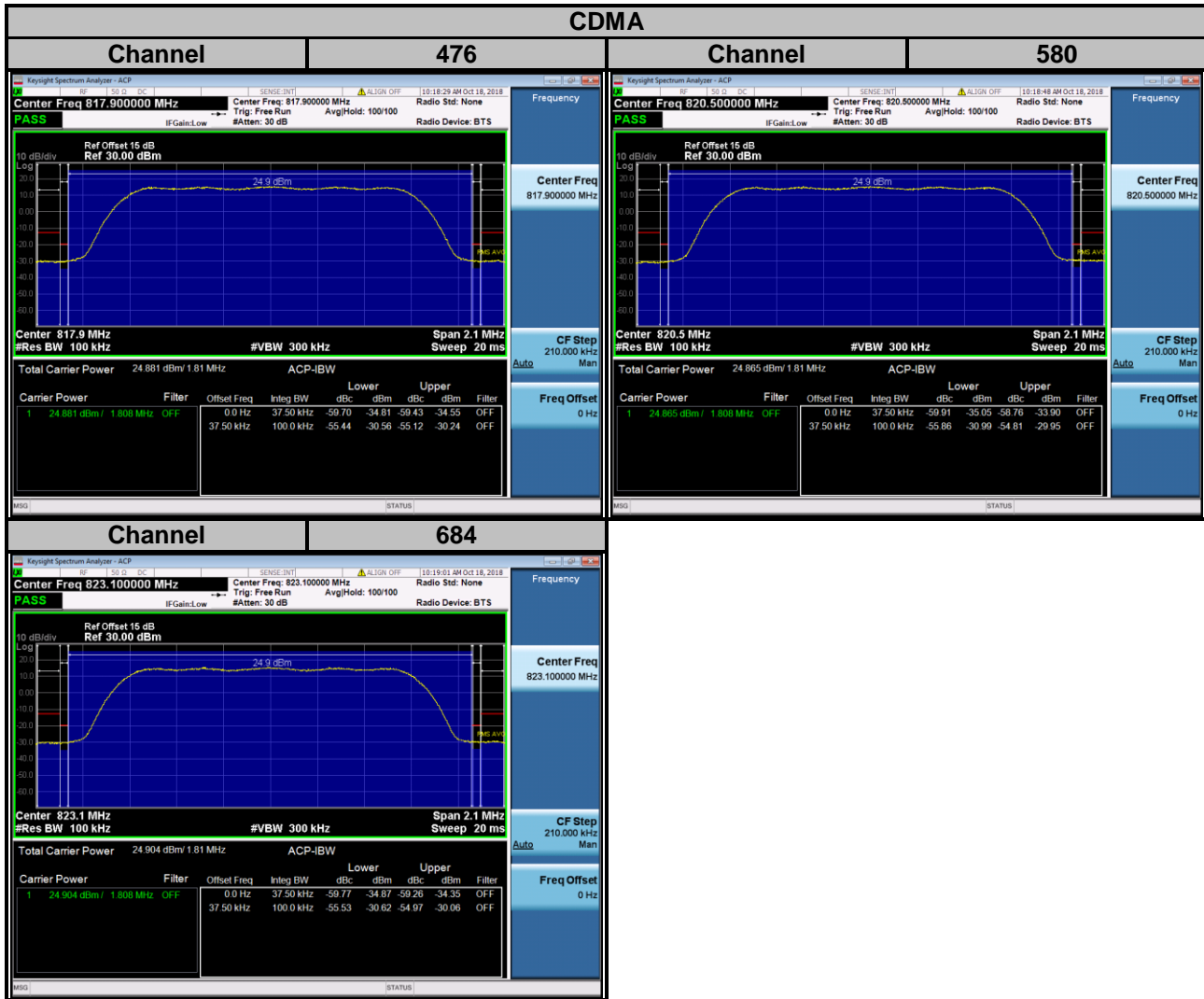

LTE Band 26

Channel Bandwidth: 1.4 MHz / QPSK

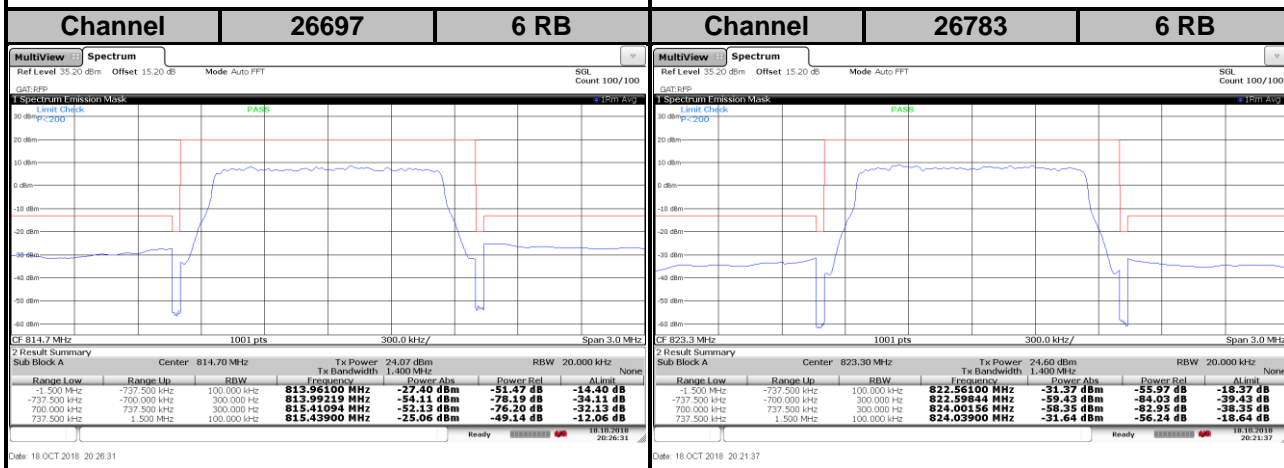
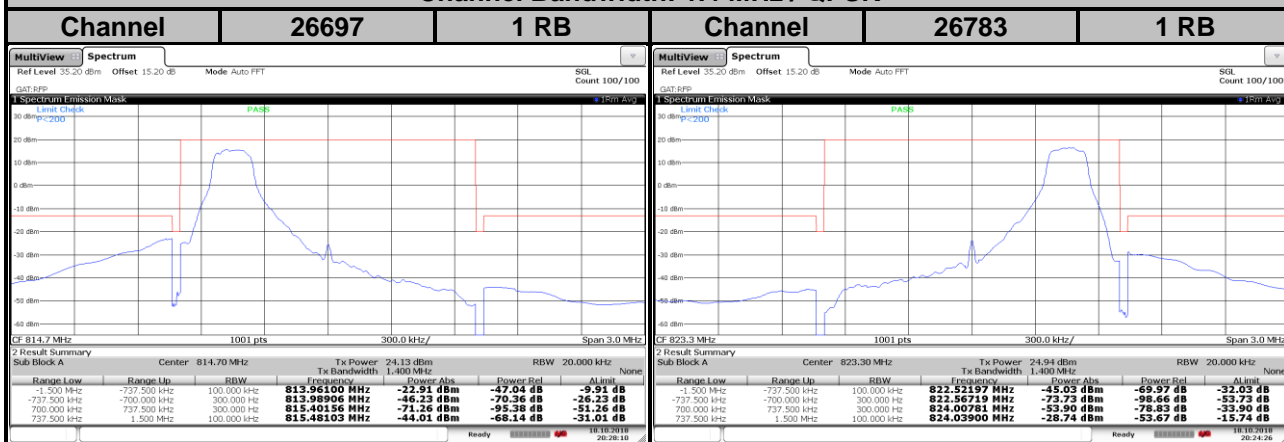

LTE Band 26

Channel Bandwidth: 1.4 MHz / 16QAM

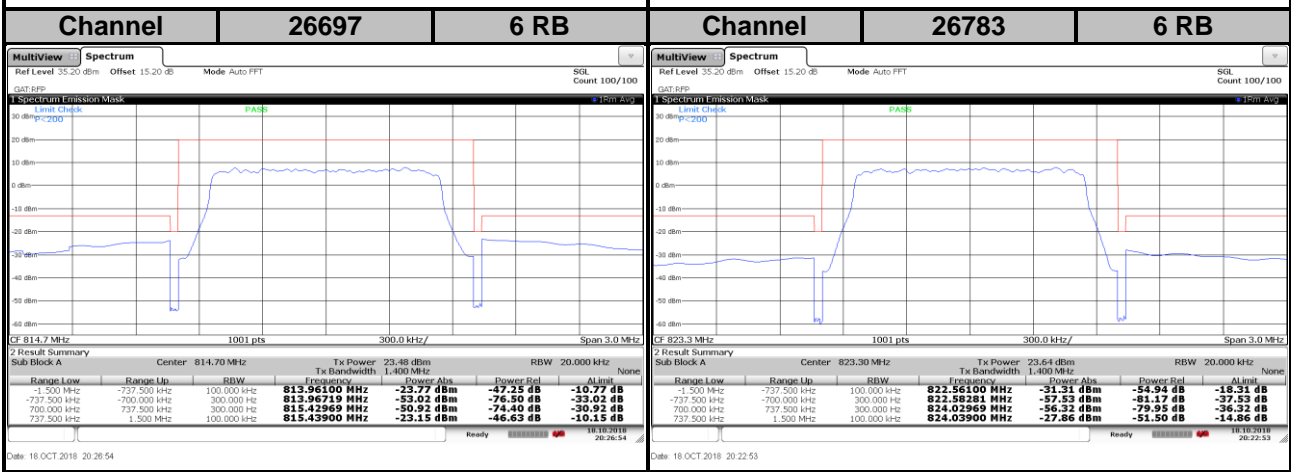
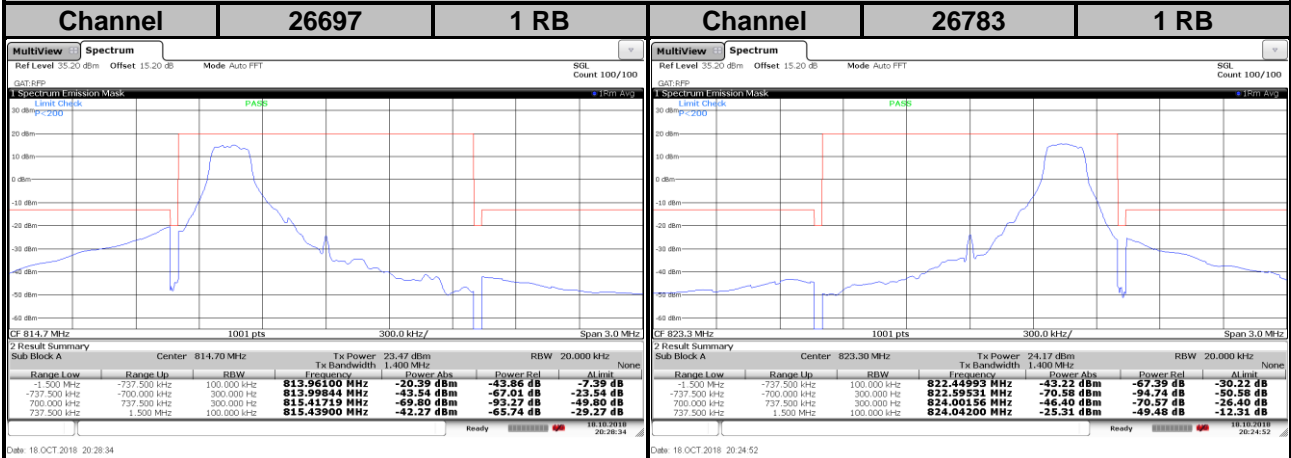

LTE Band 26

Channel Bandwidth: 1.4 MHz / 64QAM

Channel	26697	1 RB	Channel	26783	1 RB
---------	-------	------	---------	-------	------

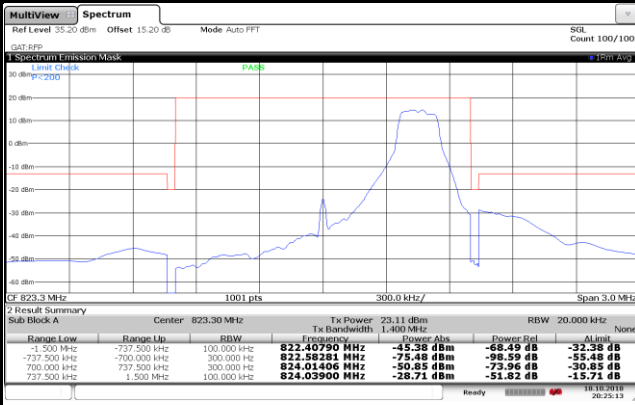
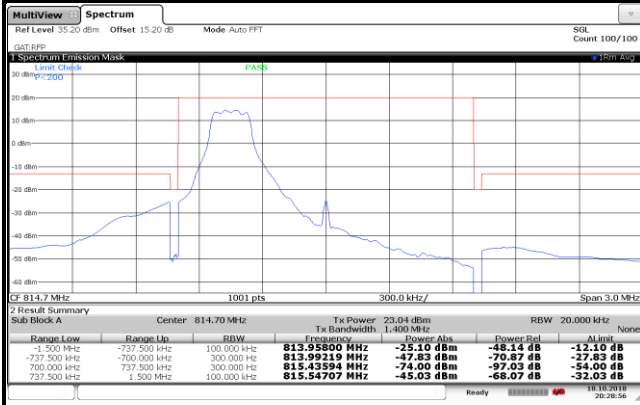

Channel	26697	6 RB	Channel	26783	6 RB
---------	-------	------	---------	-------	------

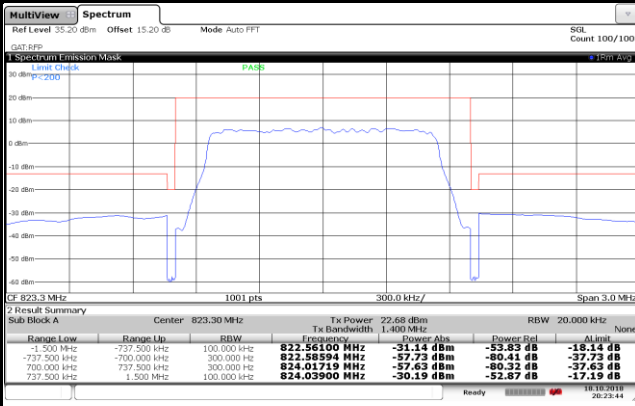
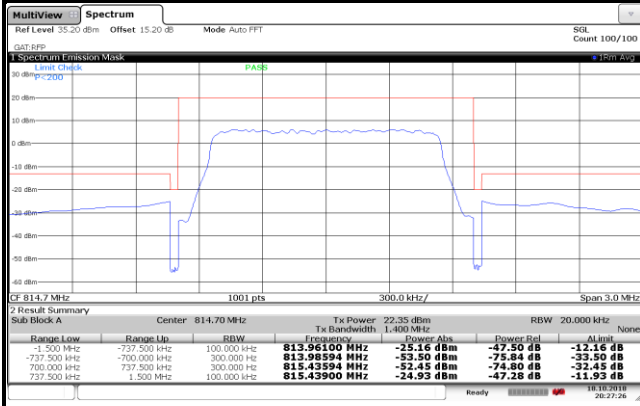

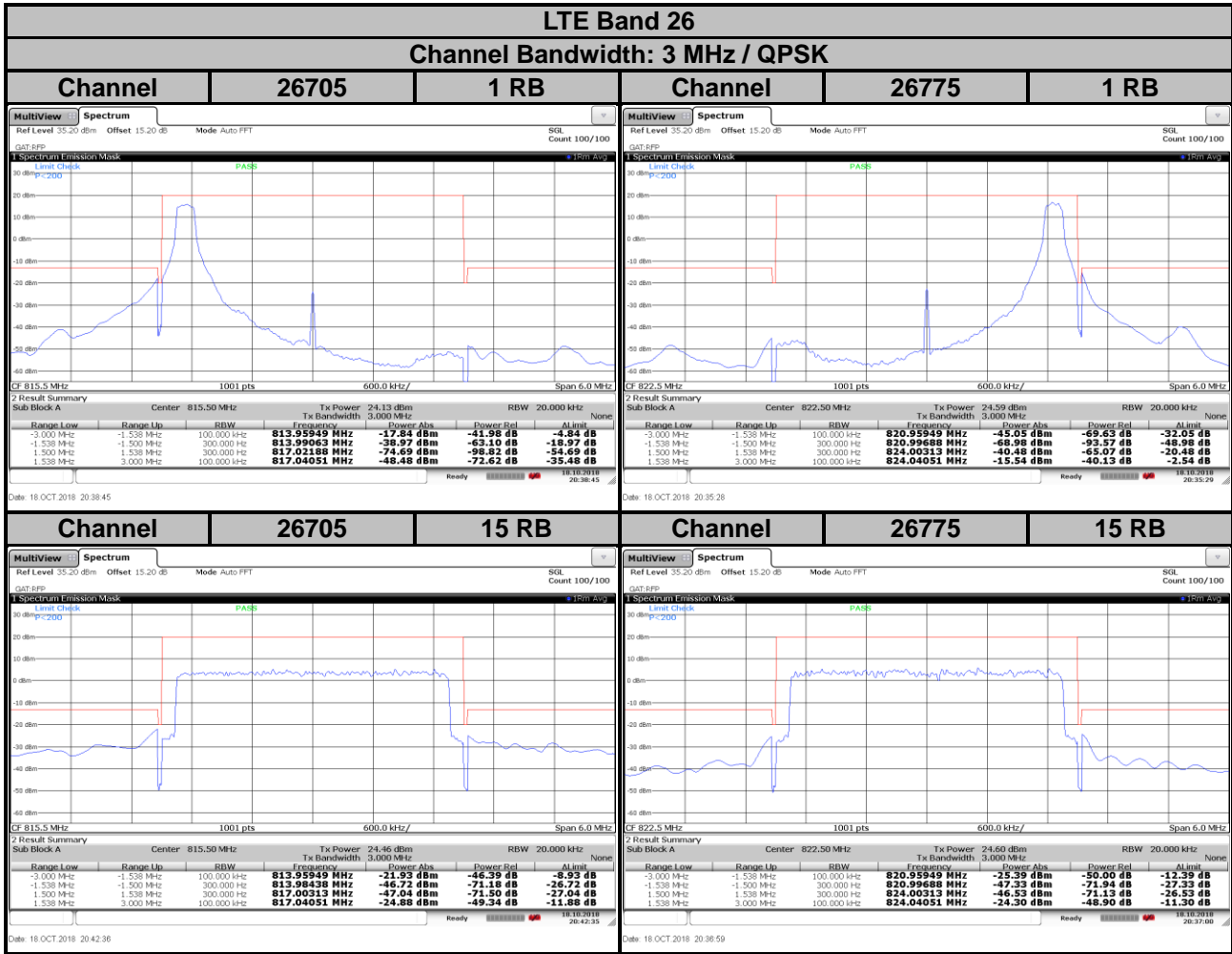

LTE Band 26

Channel Bandwidth: 3 MHz / 16QAM

Channel 26705 1 RB

Channel 26775 1 RB

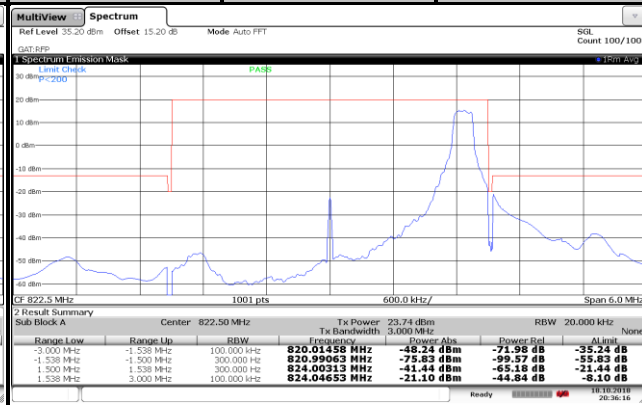
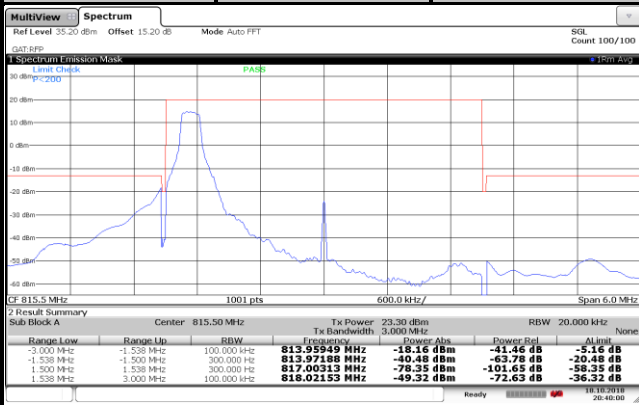

Channel 26705 15 RB

Channel 26775 15 RB

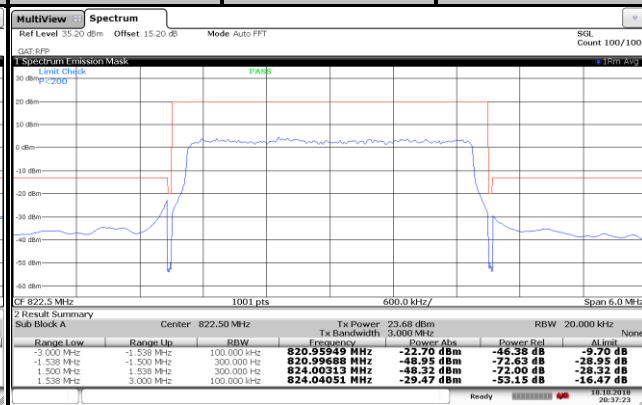
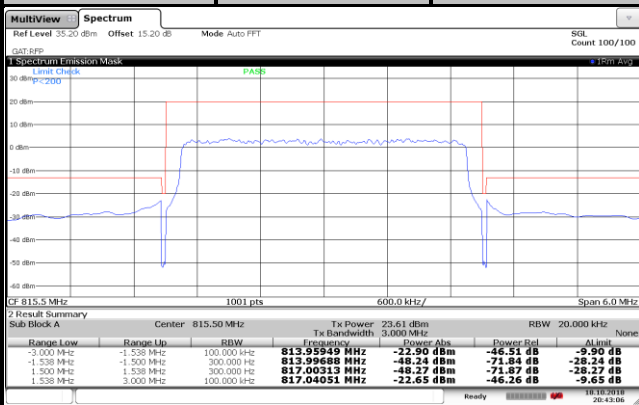

LTE Band 26

Channel Bandwidth: 3 MHz / 64QAM

Channel 26705 1 RB

Channel 26775 1 RB

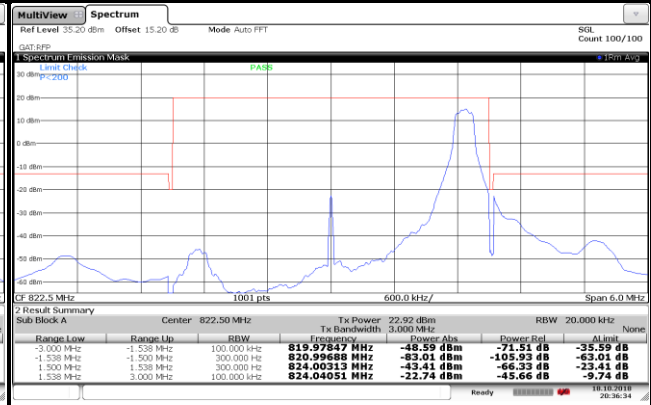
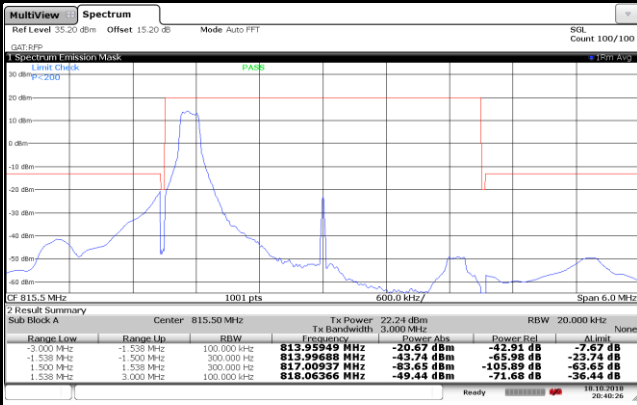

Channel 26705 15 RB

Channel 26775 15 RB

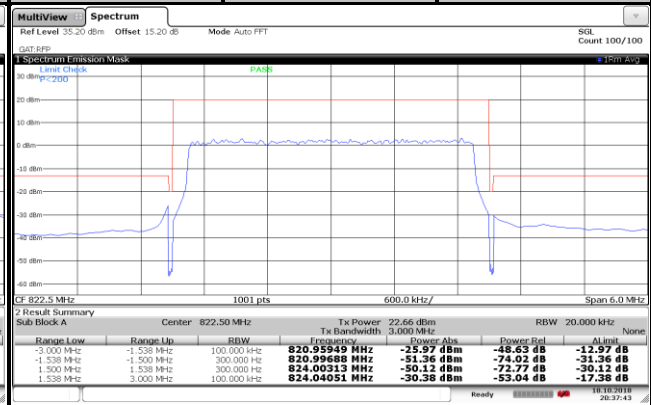
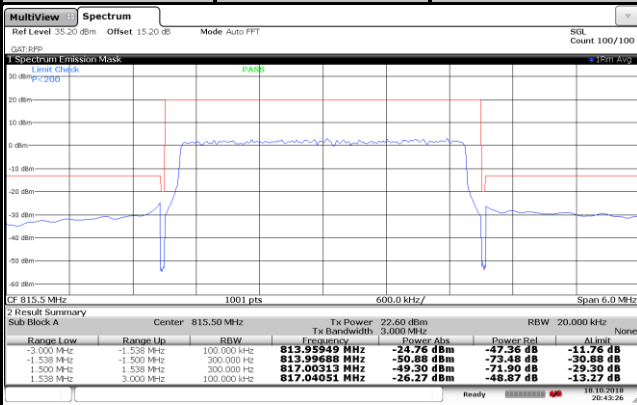

LTE Band 26

Channel Bandwidth: 5 MHz / QPSK

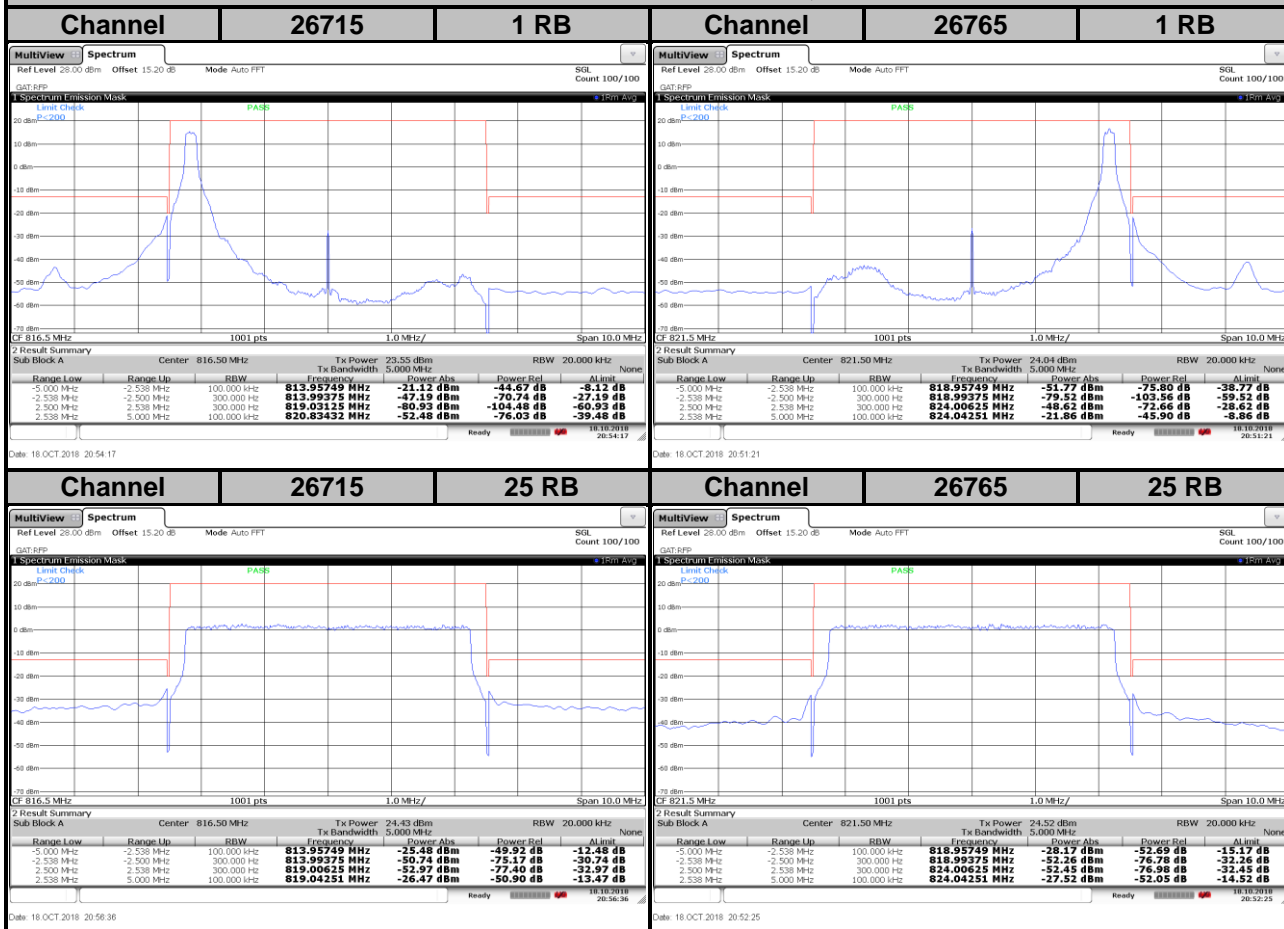

LTE Band 26

Channel Bandwidth: 5 MHz / 16QAM

Channel 26715 1 RB

Channel 26765 1 RB

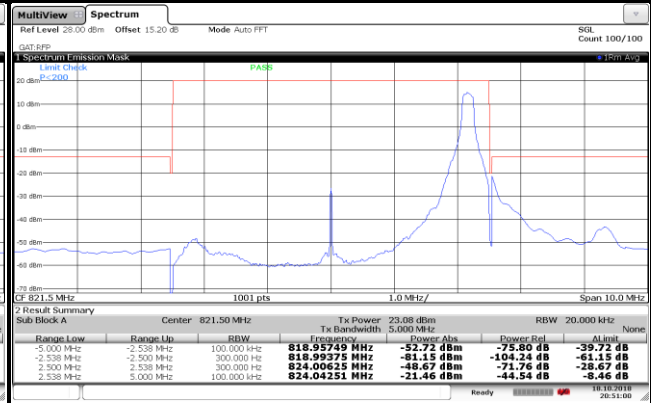
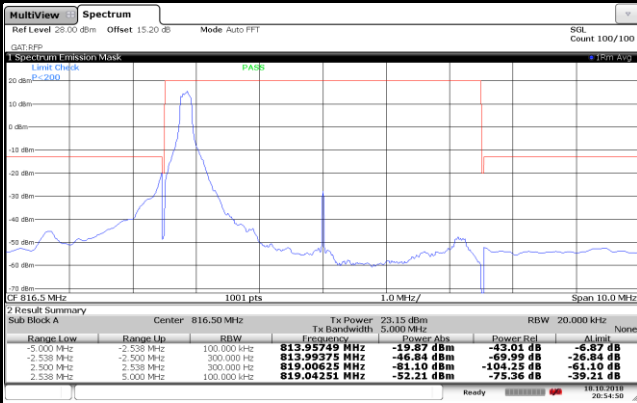

Channel 26715 25 RB

Channel 26765 25 RB

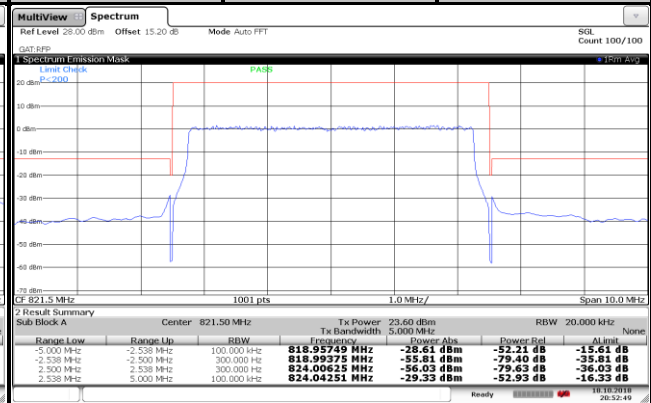
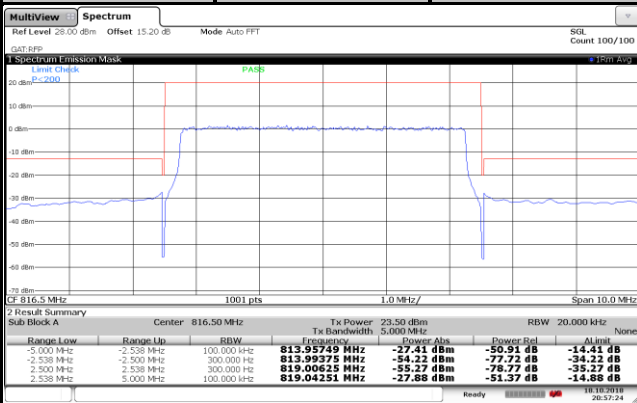

LTE Band 26

Channel Bandwidth: 5 MHz / 64QAM

Channel

26715

1 RB

Channel

26765

1 RB

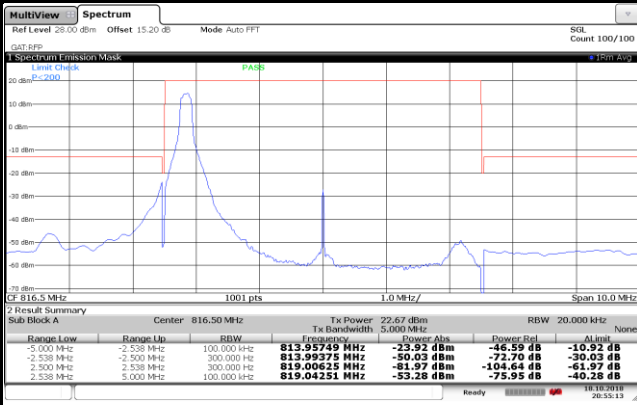

Date: 18 OCT 2018 20:55:13

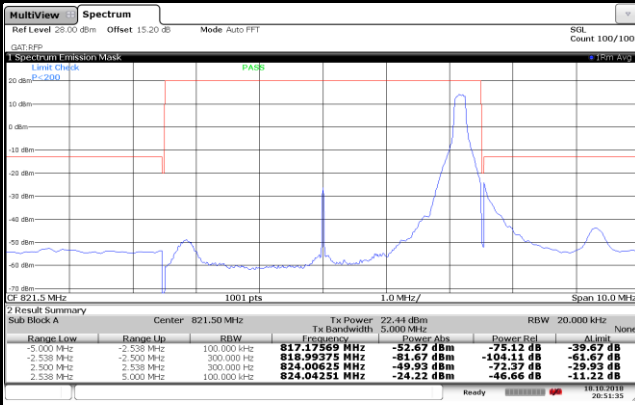

Date: 18 OCT 2018 20:51:35

Channel

26715

25 RB

Channel

26765

25 RB

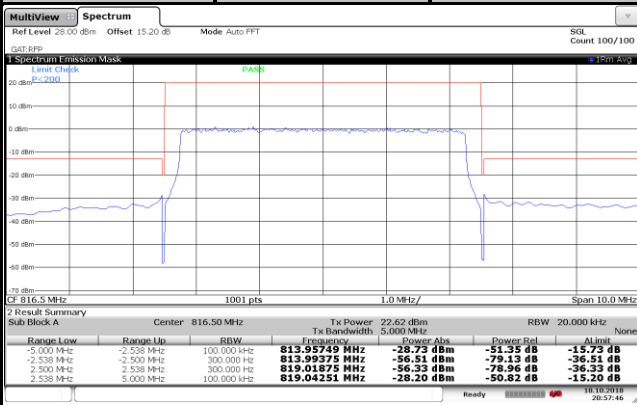

Date: 18 OCT 2018 20:57:46

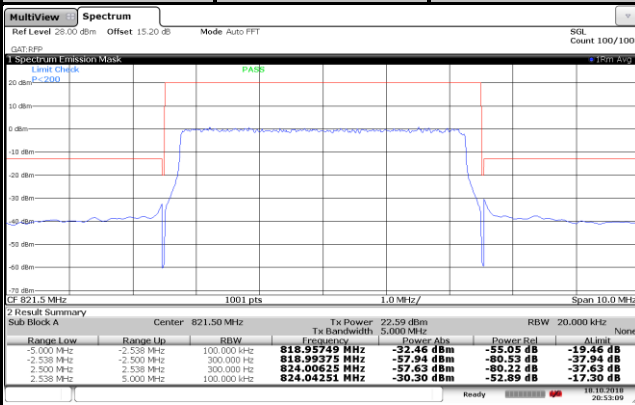

Date: 18 OCT 2018 20:53:10

LTE Band 26

Channel Bandwidth: 10 MHz / QPSK

Channel 26740 1 RB Channel 26740 1 RB

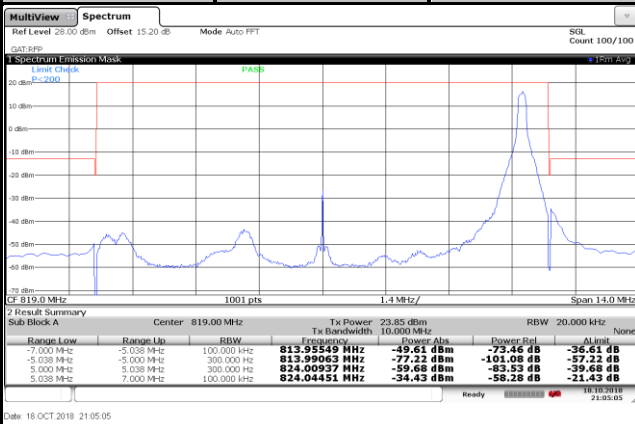
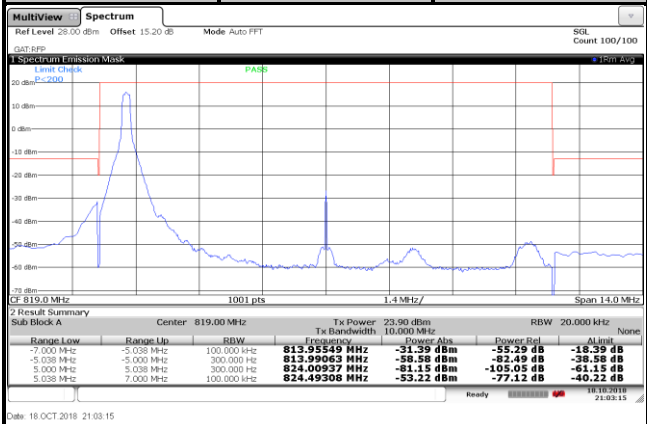

Channel 26740 50 RB

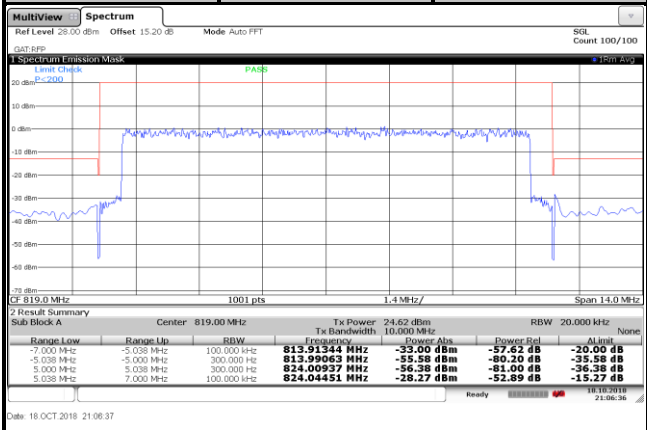

LTE Band 26

Channel Bandwidth: 10 MHz / 16QAM

Channel 26740 1 RB Channel 26740 1 RB

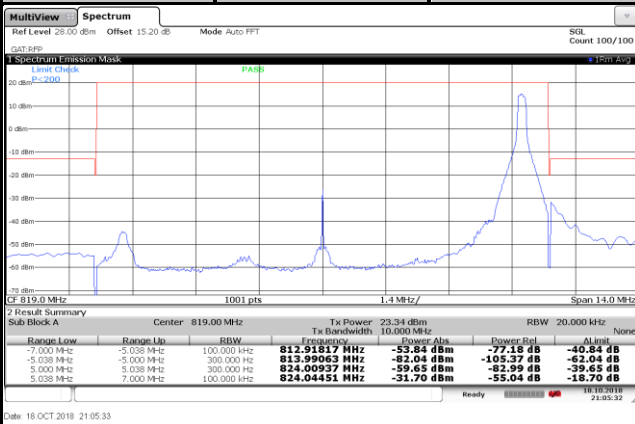
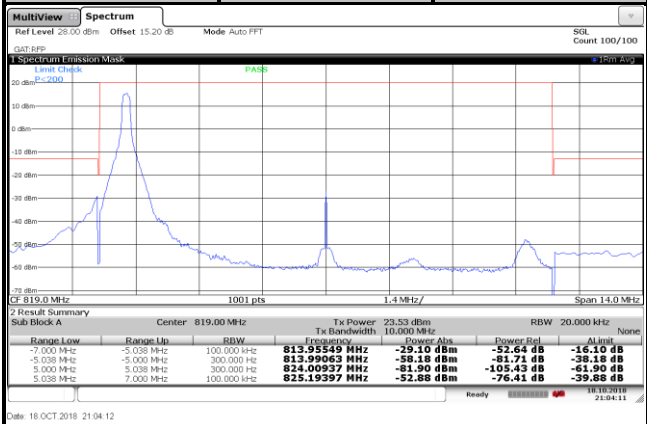

Channel 26740 50 RB

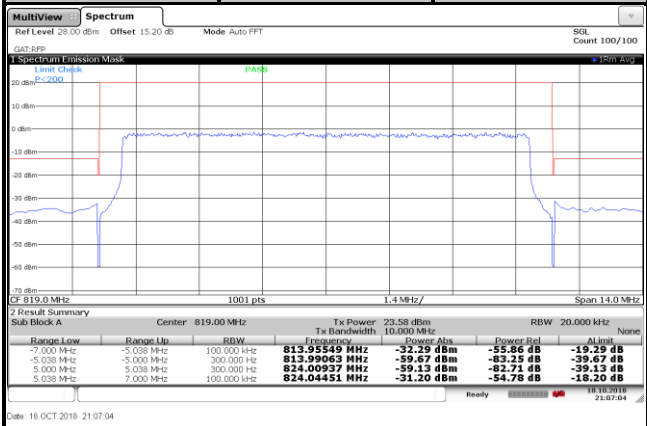

LTE Band 26

Channel Bandwidth: 10 MHz / 64QAM

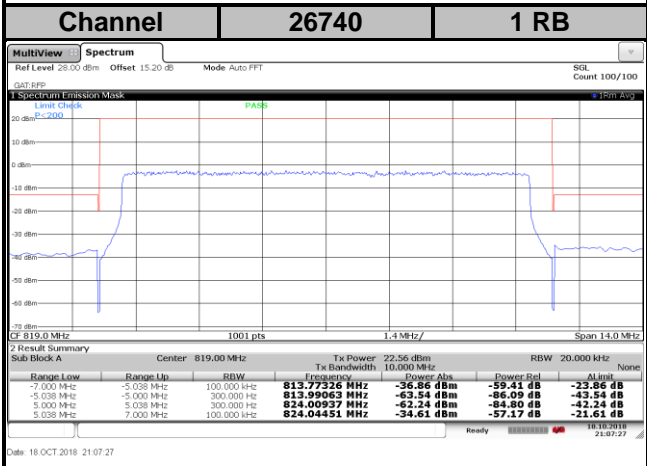
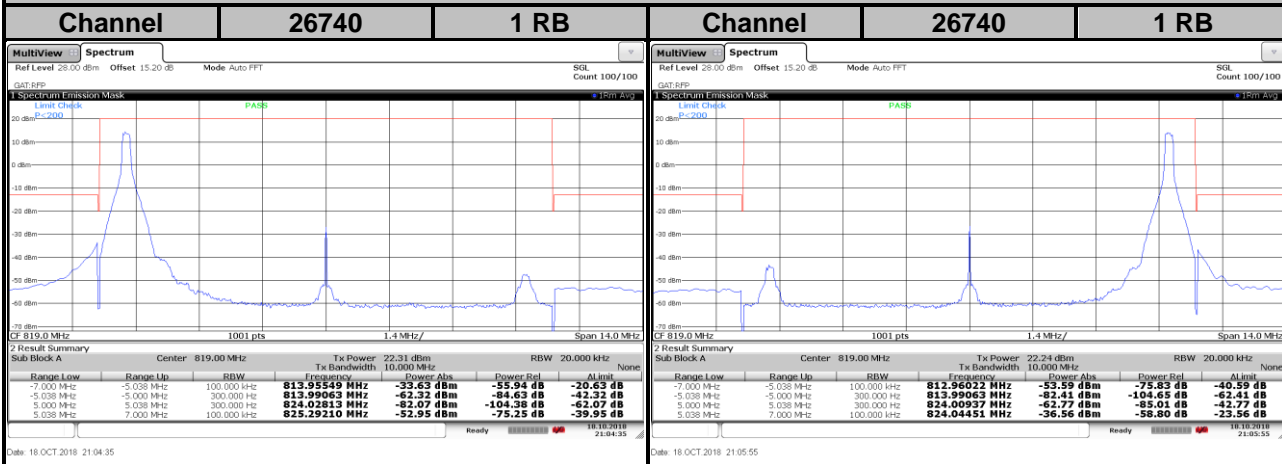

4.6 Conducted Spurious Emissions

4.6.1 Limits of Conducted Spurious Emissions Measurement

The power of any emission outside a licensee's frequency block shall be attenuated below the transmitter power (P) by at least $43 + 10 \log_{10}(P)$ dB. The limit of emission is equal to -13 dBm.

4.6.2 Test Setup

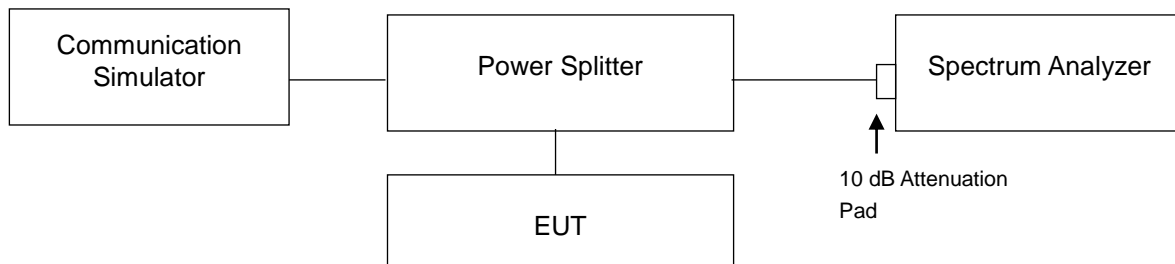

4.6.3 Test Procedure

- The EUT makes a phone call to the communication simulator. All measurements were done at low, middle and high operational frequency range.
- Measuring frequency range is from 9 kHz to 1 GHz. 10 dB attenuation pad is connected with spectrum. RBW = 100 kHz and VBW = 300 kHz are used for conducted emission measurement.
- Measuring frequency range is from 1 GHz to 10 GHz. 10 dB attenuation pad is connected with spectrum. RBW = 1 MHz and VBW = 3 MHz are used for conducted emission measurement.

4.6.4 Test Results



Note: The signal over the limit in 9 kHz is from spectrum analyzer.

LTE Band 26
Channel Bandwidth: 1.4 MHz
Channel 26697

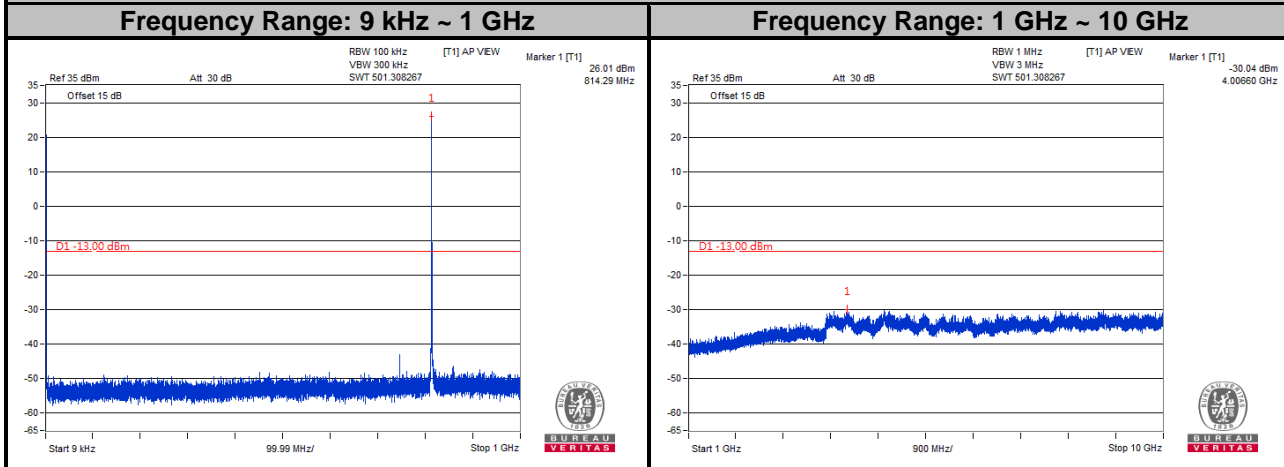

Channel 26740

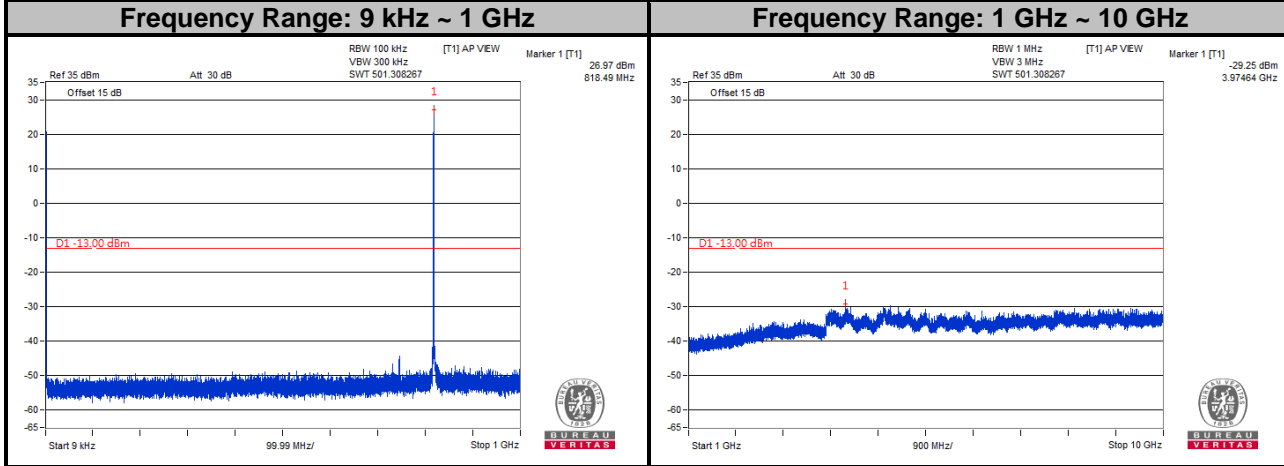

Channel 26783

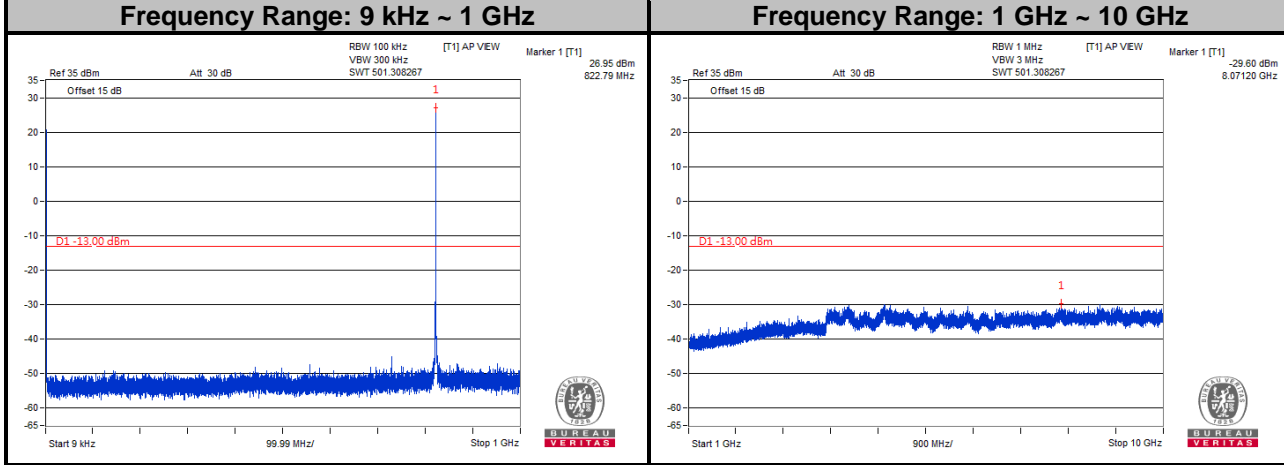

Note: The signal over the limit in 9 kHz is from spectrum analyzer.

LTE Band 26
Channel Bandwidth: 3 MHz
Channel 26705

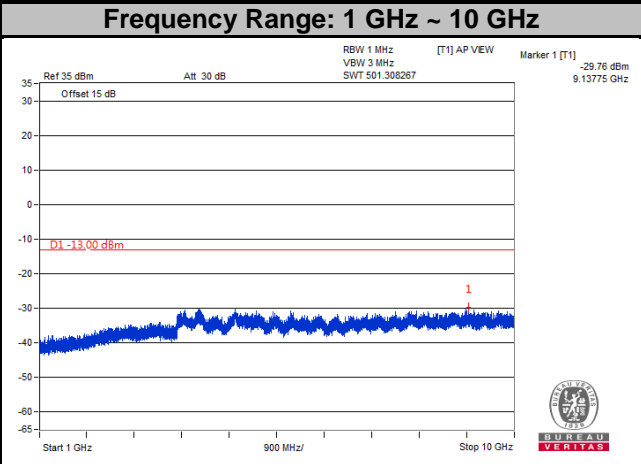
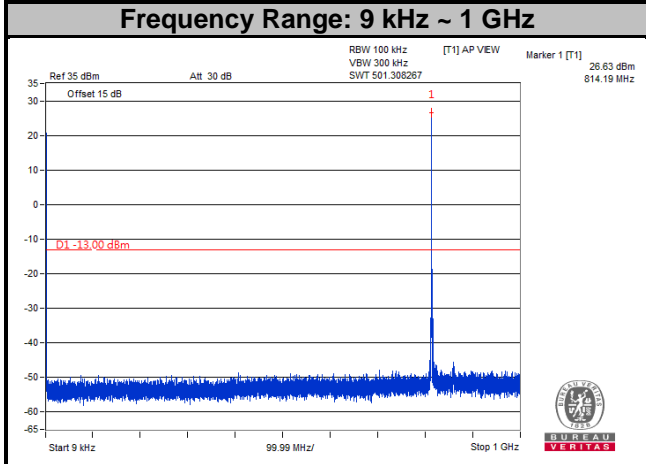

Channel 26740

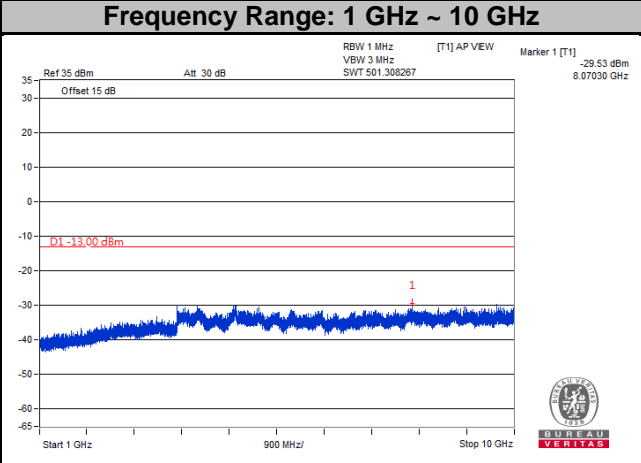
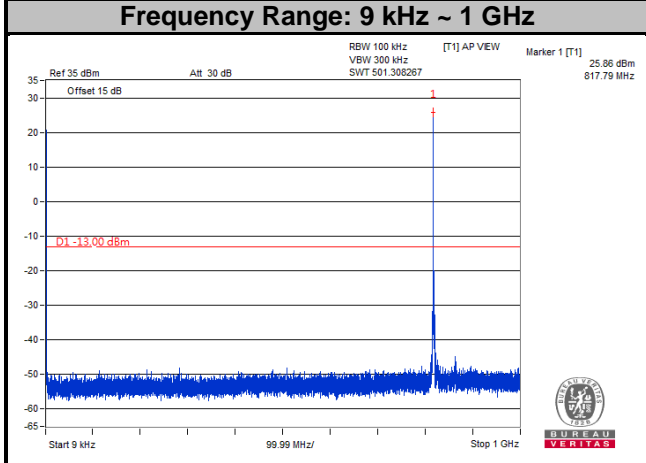

Channel 26775

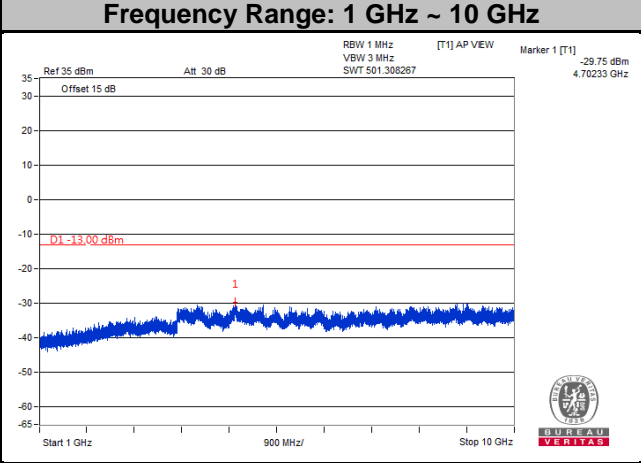
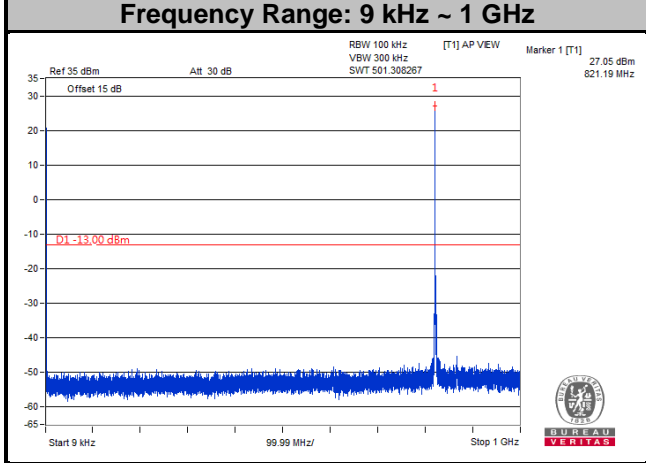

Note: The signal over the limit in 9 kHz is from spectrum analyzer.

LTE Band 26
Channel Bandwidth: 5 MHz
Channel 26715

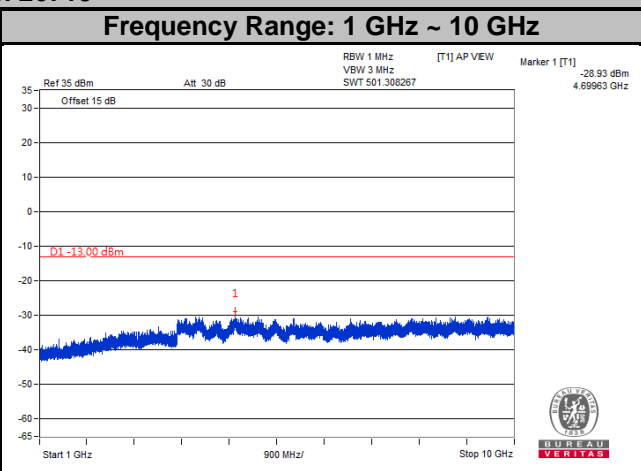
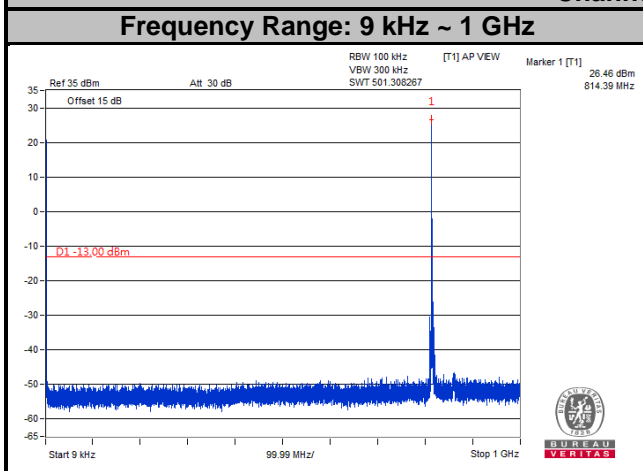

Channel 26740

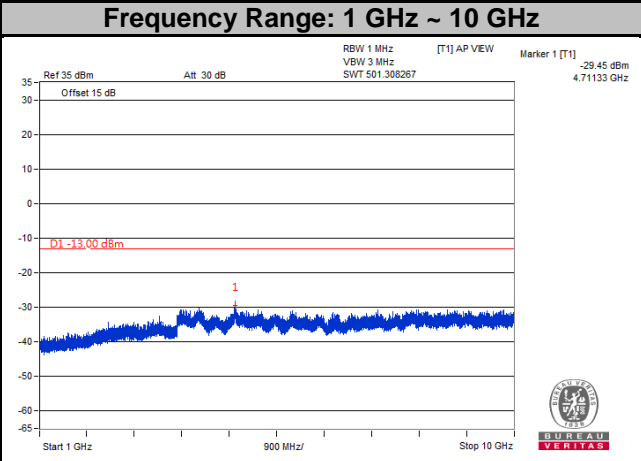
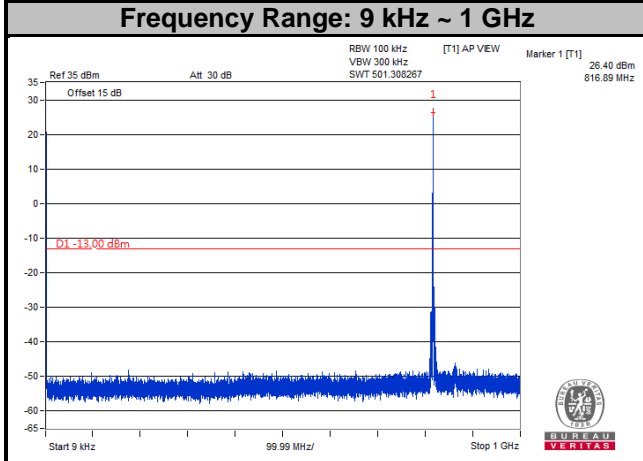

Channel 26765

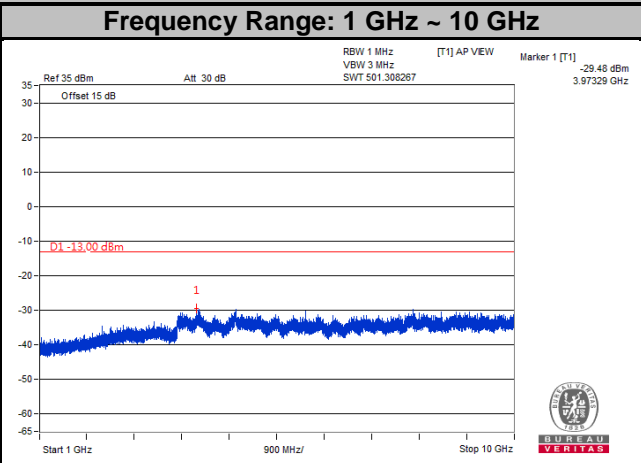
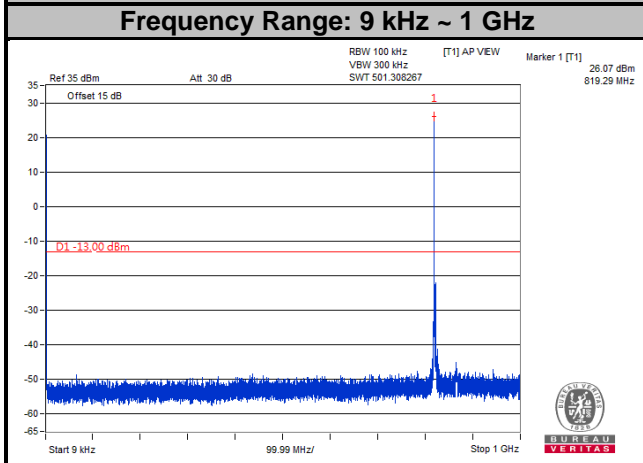

Note: The signal over the limit in 9 kHz is from spectrum analyzer.

LTE Band 26

Channel Bandwidth: 10 MHz

Channel 26740

Frequency Range: 9 kHz ~ 1 GHz

Frequency Range: 1 GHz ~ 10 GHz

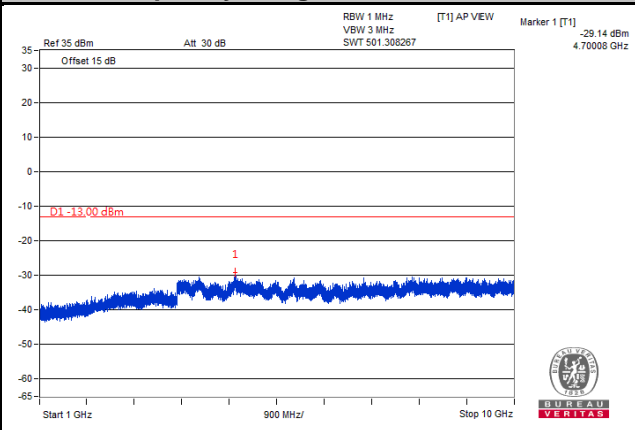
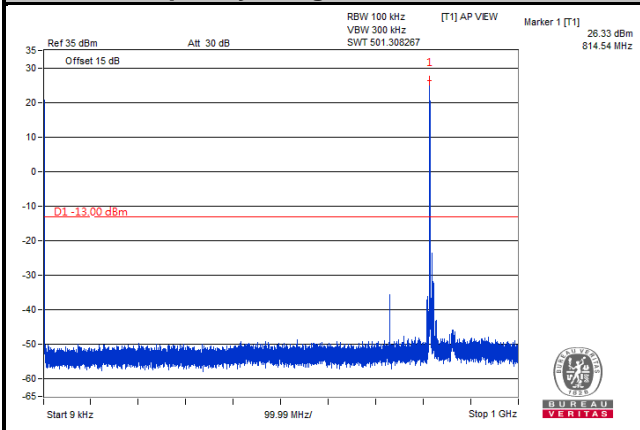

Note: The signal over the limit in 9 kHz is from spectrum analyzer.

4.7 Radiated Emission Measurement

4.7.1 Limits of Radiated Emission Measurement

The power of any emission outside a licensee's frequency block shall be attenuated below the transmitter power (P) by at least $43 + 10 \log (P)$ dB. The limit of emission is equal to -13 dBm.

4.7.2 Test Procedure

- a. Substitution method is used for E.I.R.P measurement. In the semi-anechoic chamber, EUT placed on the 0.8 m (below or equal 1 GHz) and/or 1.5 m (above 1 GHz) height of Turn Table, rotated the table around 360 degrees to search the maximum radiation power and receiver antenna shall be rotated vertical and horizontal polarization and moved height from 1 m to 4 m to find the maximum polar radiated power. The "Read Value" is the spectrum reading the maximum power value.
- b. The substitution horn antenna is substituted for EUT at the same position and signals generator export the CW signal to the substitution antenna via a TX cable. Rotated the Turn Table and moved receiving antenna to find the maximum radiation power. Adjust output power level of S.G to get a Value of spectrum reading equal to "Read Value" of step a. Record the power level of S.G.
- c. $EIRP = \text{Output power level of S.G} - \text{TX cable loss} + \text{Antenna gain of substitution horn}$.
- d. E.R.P power can be calculated form E.I.R.P power by subtracting the gain of dipole, $E.R.P \text{ power} = E.I.P.R \text{ power} - 2.15 \text{ dB}$.

Note: The resolution bandwidth of spectrum analyzer is 1 MHz and the video bandwidth is 3 MHz.

4.7.3 Deviation from Test Standard

No deviation.

4.7.4 Test Setup

<Radiated Emission below or equal 1 GHz>

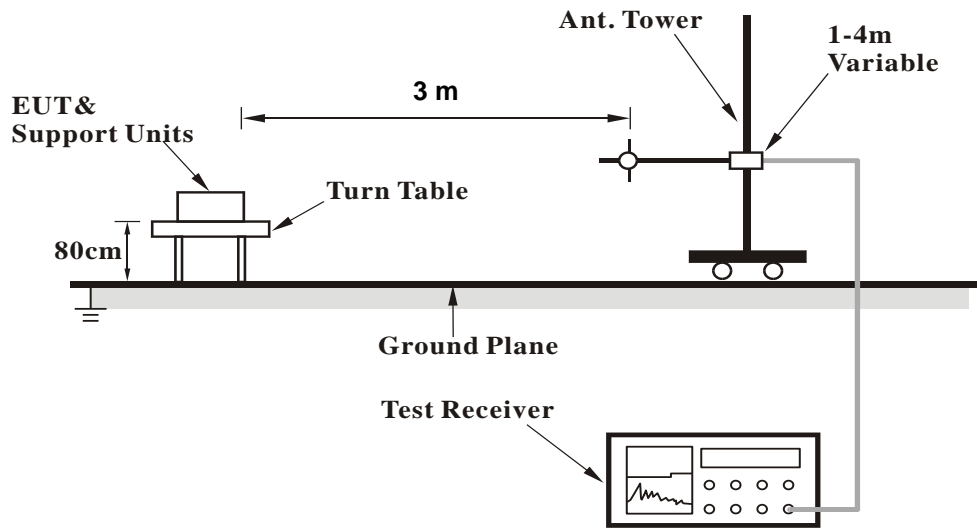

<Radiated Emission above 1 GHz>

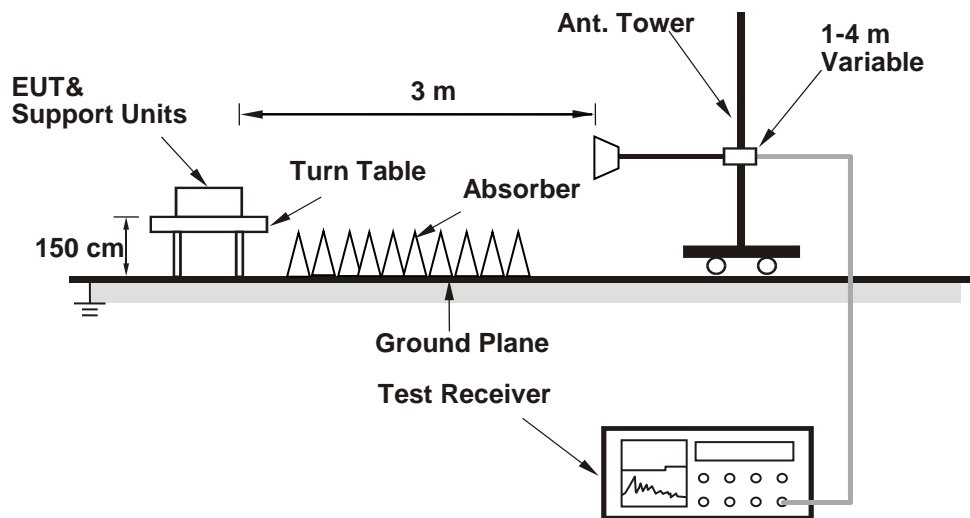

For the actual test configuration, please refer to the attached file (Test Setup Photo).

4.7.5 Test Results

CDMA:
Low Channel



Bureau Veritas Consumer Products Services Ltd., Taoyuan Branch

A D T

Data: 1

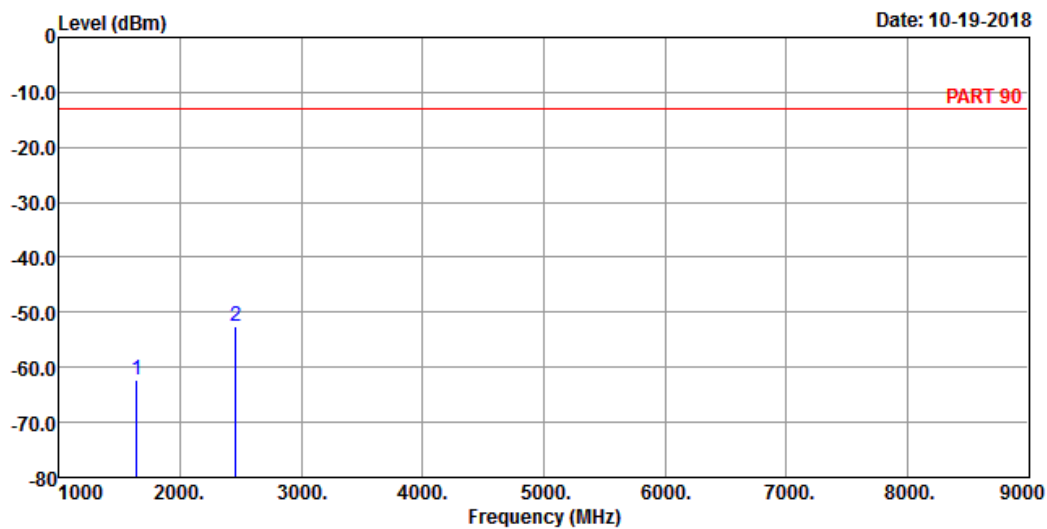

Site : 966 Chamber 5
Condition: PART 90 HORIZONTAL
Remark : CDMA BC10 Link_L-CH
Tested by: Thomas Wei

	Freq	Level	Read Level	Limit Line	Over Limit	Factor	Remark
	MHz	dBm	dBm	dBm	dB	dB	
1	1635.80	-62.16	-47.37	-13.00	-49.16	-14.79	Peak
2	2453.70	-52.58	-42.14	-13.00	-39.58	-10.44	Peak



Bureau Veritas Consumer Products Services Ltd., Taoyuan Branch

A D T

Data: 2

Date: 10-19-2018

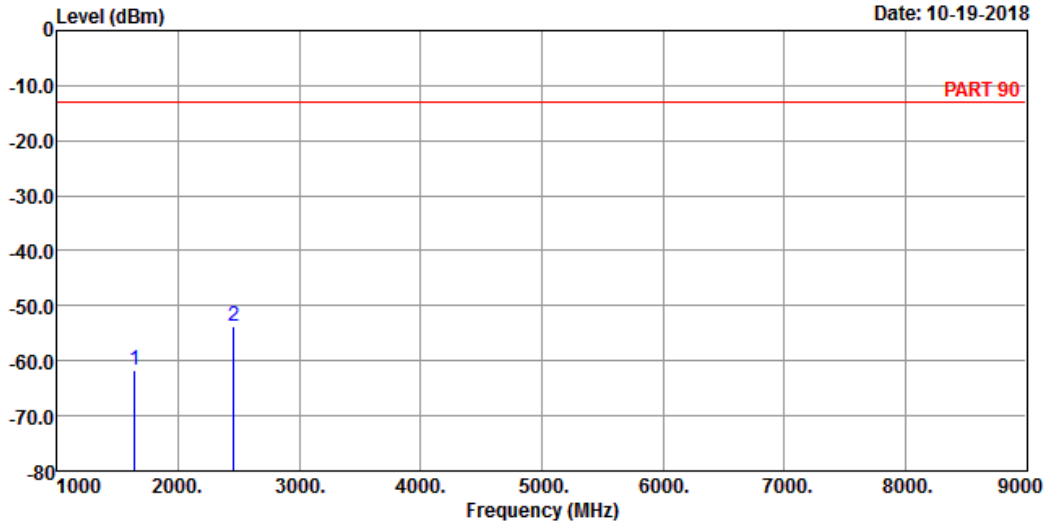

Site : 966 Chamber 5
 Condition: PART 90 VERTICAL
 Remark : CDMA BC10 Link_L-CH
 Tested by: Thomas Wei

	Freq	Level	Read Level	Limit Line	Over Limit	Factor	Remark
	MHz	dBm	dBm	dBm	dB	dB	
1	1635.80	-61.79	-47.00	-13.00	-48.79	-14.79	Peak
2 pp	2453.70	-53.67	-43.23	-13.00	-40.67	-10.44	Peak

Middle Channel



Bureau Veritas Consumer Products Services Ltd., Taoyuan Branch

A D T

Data: 1

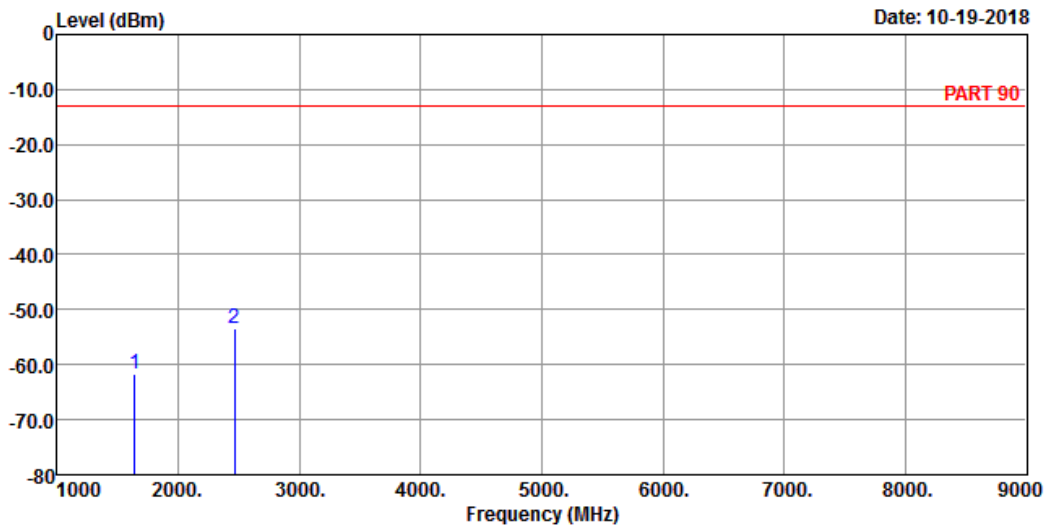

Site : 966 Chamber 5
 Condition: PART 90 HORIZONTAL
 Remark : CDMA BC10 Link_M-CH
 Tested by: Thomas Wei

	Freq	Level	Read Level	Limit Line	Over Limit	Factor	Remark
	MHz	dBm	dBm	dBm	dB	dB	
1	1641.00	-61.79	-47.06	-13.00	-48.79	-14.73	Peak
2 pp	2461.50	-53.39	-42.95	-13.00	-40.39	-10.44	Peak



Bureau Veritas Consumer Products Services Ltd., Taoyuan Branch

A D T

Data: 2

Date: 10-19-2018

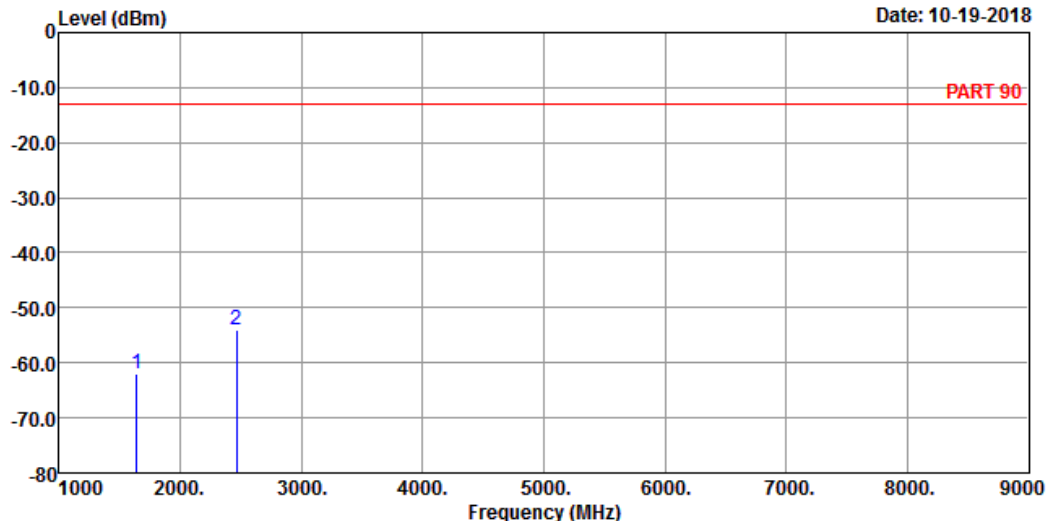

Site : 966 Chamber 5
 Condition: PART 90 VERTICAL
 Remark : CDMA BC10 Link_M-CH
 Tested by: Thomas Wei

	Freq	Level	Read Level	Limit Line	Over Limit	Factor	Remark
	MHz	dBm	dBm	dBm	dB	dB	
1	1641.00	-62.04	-47.31	-13.00	-49.04	-14.73	Peak
2	2461.50	-54.06	-43.62	-13.00	-41.06	-10.44	Peak

High Channel



Bureau Veritas Consumer Products Services Ltd., Taoyuan Branch

A D T

Data: 5

Date: 10-19-2018

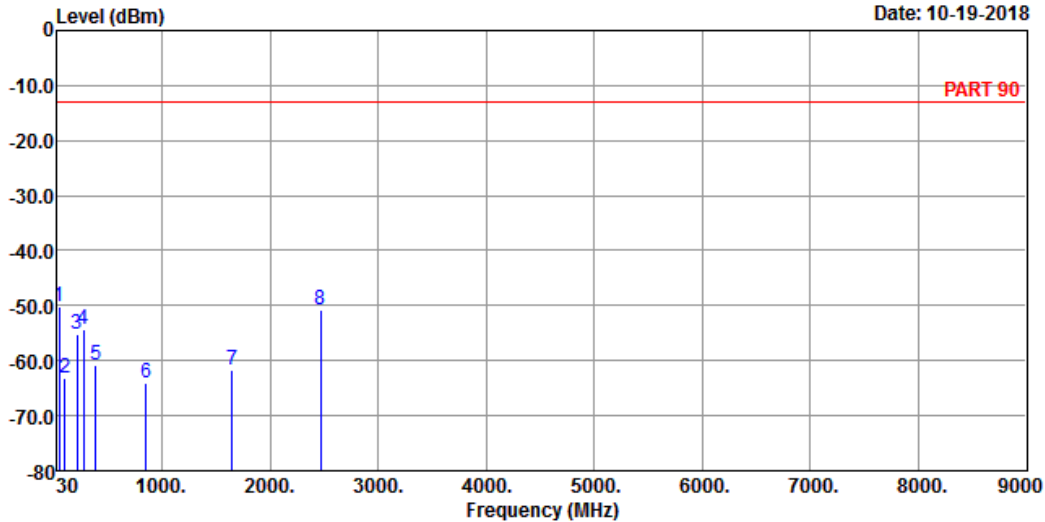

Site : 966 Chamber 5
 Condition: PART 90 HORIZONTAL
 Remark : CDMA BC10 Link_H-CH
 Tested by: Thomas Wei

	Freq	Level	Read Level	Limit Line	Over Limit	Factor	Remark
	MHz	dBm	dBm	dBm	dB	dB	
1 pp	44.55	-50.15	-48.16	-13.00	-37.15	-1.99	Peak
2	96.93	-63.08	-52.35	-13.00	-50.08	-10.73	Peak
3	215.27	-55.21	-47.81	-13.00	-42.21	-7.40	Peak
4	276.38	-54.29	-47.76	-13.00	-41.29	-6.53	Peak
5	382.11	-60.90	-54.85	-13.00	-47.90	-6.05	Peak
6	848.68	-63.95	-64.25	-13.00	-50.95	0.30	Peak
7	1646.20	-61.56	-46.83	-13.00	-48.56	-14.73	Peak
8	2469.30	-50.80	-40.36	-13.00	-37.80	-10.44	Peak



Bureau Veritas Consumer Products Services Ltd., Taoyuan Branch

A D T

Data: 6

Date: 10-19-2018

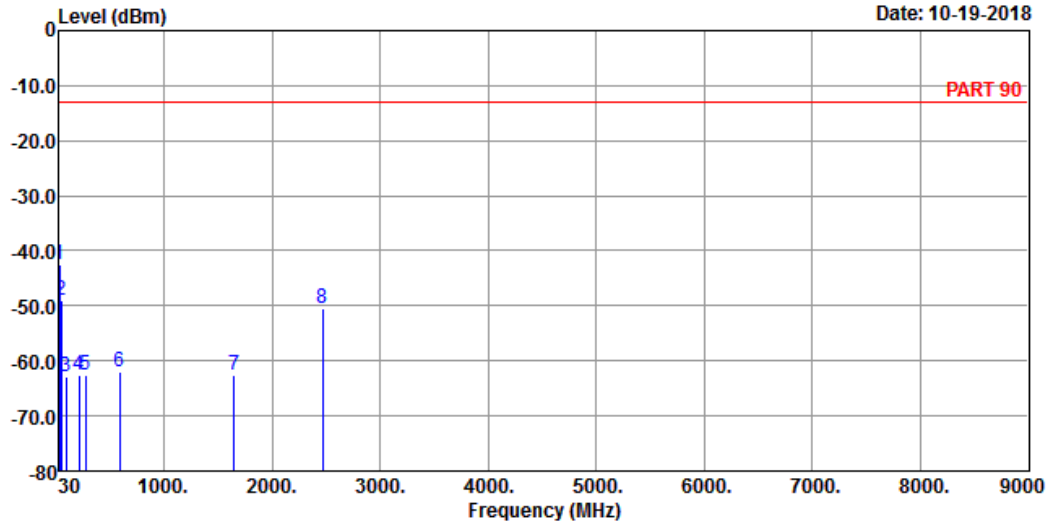

Site : 966 Chamber 5
 Condition: PART 90 VERTICAL
 Remark : CDMA BC10 Link_H-CH
 Tested by: Thomas Wei

	Freq	Level	Read Level	Limit Line	Over Limit	Factor	Remark
	MHz	dBm	dBm	dBm	dB	dB	
1 pp	30.00	-42.55	-42.93	-13.00	-29.55	0.38	Peak
2	43.58	-48.87	-47.40	-13.00	-35.87	-1.47	Peak
3	94.99	-62.94	-52.10	-13.00	-49.94	-10.84	Peak
4	215.27	-62.54	-55.14	-13.00	-49.54	-7.40	Peak
5	274.44	-62.60	-56.11	-13.00	-49.60	-6.49	Peak
6	584.84	-62.00	-60.60	-13.00	-49.00	-1.40	Peak
7	1646.20	-62.47	-47.74	-13.00	-49.47	-14.73	Peak
8	2469.30	-50.54	-40.10	-13.00	-37.54	-10.44	Peak

LTE Band 26
 Channel Bandwidth: 1.4 MHz / QPSK
 Low Channel



Bureau Veritas Consumer Products Services Ltd., Taoyuan Branch

A D T

Data: 1

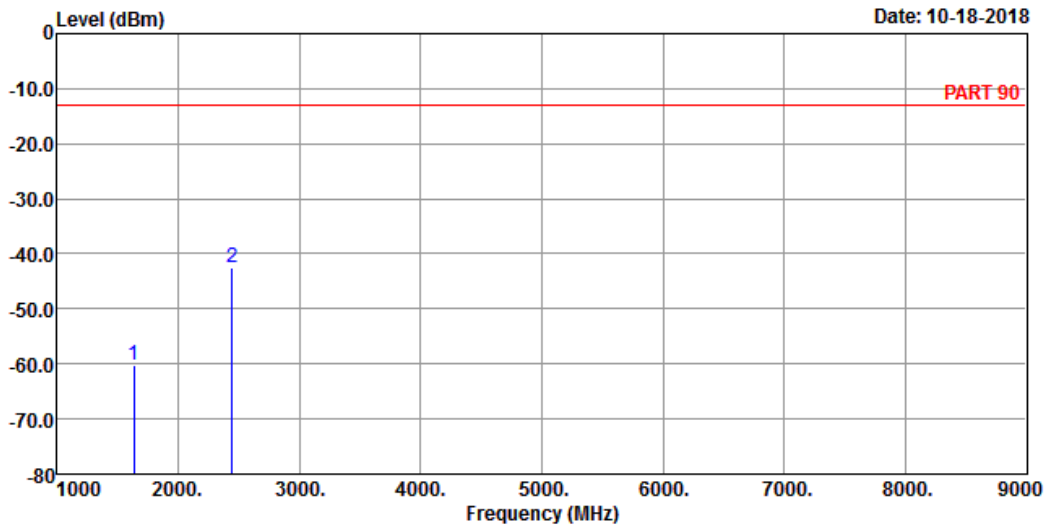

Site : 966 Chamber 5
 Condition: PART 90 HORIZONTAL
 Remak : LTE Band 26 QPSK_1.4M Link_L-CH
 Tested by: Thomas Wei

	Read	Limit	Over				
Freq	Level	Level	Line	Limit	Factor	Remark	
MHz	dBm	dBm	dBm	dB	dB		
1	1629.40	-60.21	-45.42	-13.00	-47.21	-14.79	Peak
2	2444.10	-42.53	-32.09	-13.00	-29.53	-10.44	Peak



Bureau Veritas Consumer Products Services Ltd., Taoyuan Branch

A D T

Data: 2

Date: 10-18-2018

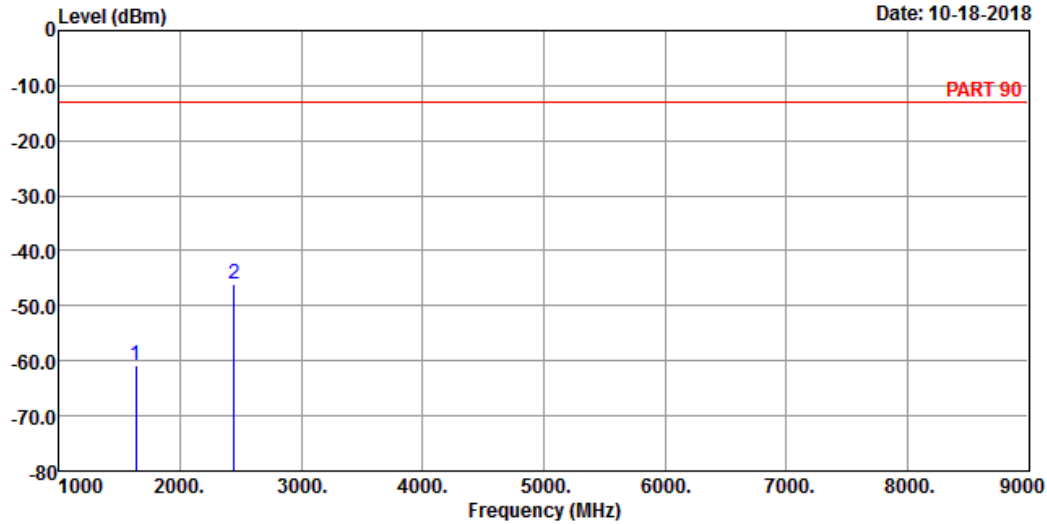

Site : 966 Chamber 5
 Condition: PART 90 VERTICAL
 Remak : LTE Band 26 QPSK_1.4M Link_L-CH
 Tested by: Thomas Wei

	Freq	Level	Read Level	Limit Line	Over Limit	Factor	Remark
	MHz	dBm	dBm	dBm	dB	dB	
1	1629.40	-60.78	-45.99	-13.00	-47.78	-14.79	Peak
2 pp	2444.10	-46.09	-35.65	-13.00	-33.09	-10.44	Peak

Middle Channel



Bureau Veritas Consumer Products Services Ltd., Taoyuan Branch

A D T

Data: 1

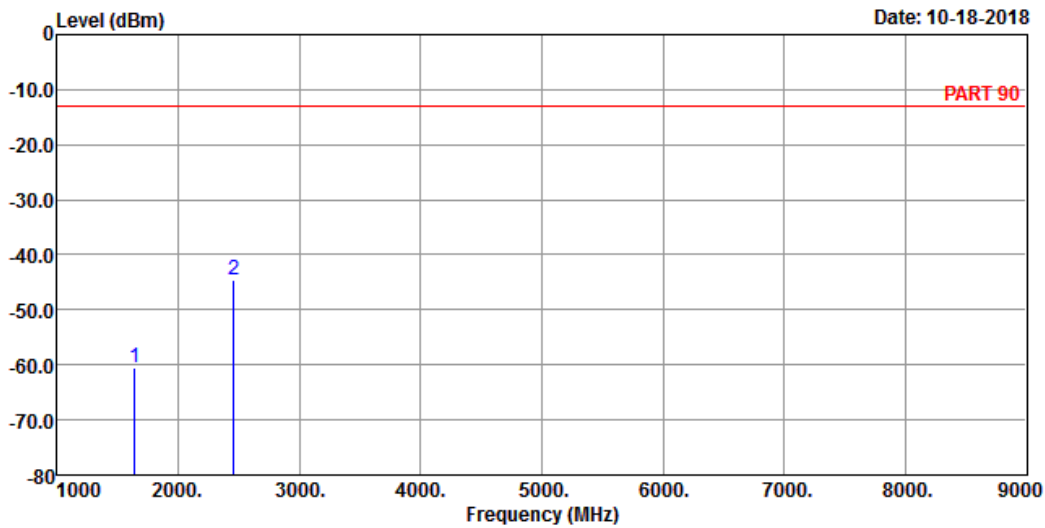

Site : 966 Chamber 5
 Condition: PART 90 HORIZONTAL
 Remak : LTE Band 26 QPSK_1.4M Link_M-CH
 Tested by: Thomas Wei

	Freq	Level	Read Level	Limit Line	Over Limit	Factor	Remark
	MHz	dBm	dBm	dBm	dB	dB	
1	1638.00	-60.61	-45.82	-13.00	-47.61	-14.79	Peak
2 pp	2457.00	-44.67	-34.23	-13.00	-31.67	-10.44	Peak



Bureau Veritas Consumer Products Services Ltd., Taoyuan Branch

A D T

Data: 2

Date: 10-18-2018

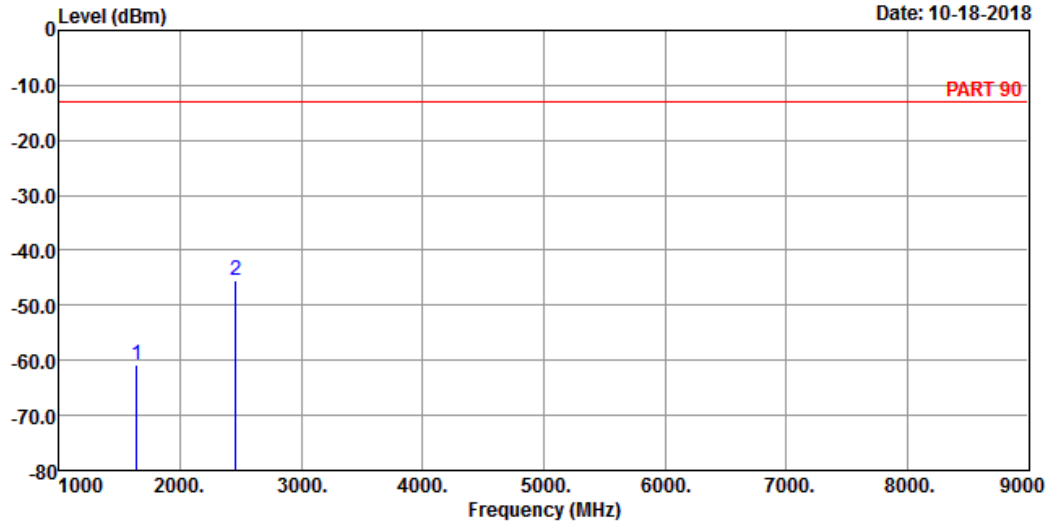

Site : 966 Chamber 5
 Condition: PART 90 VERTICAL
 Remak : LTE Band 26 QPSK_1.4M Link_M-CH
 Tested by: Thomas Wei

	Freq	Level	Read Level	Limit Line	Over Limit	Factor	Remark
	MHz	dBm	dBm	dBm	dB	dB	
1	1638.00	-60.73	-45.94	-13.00	-47.73	-14.79	Peak
2	2457.00	-45.36	-34.92	-13.00	-32.36	-10.44	Peak

High Channel



Bureau Veritas Consumer Products Services Ltd., Taoyuan Branch

A D T

Data: 1

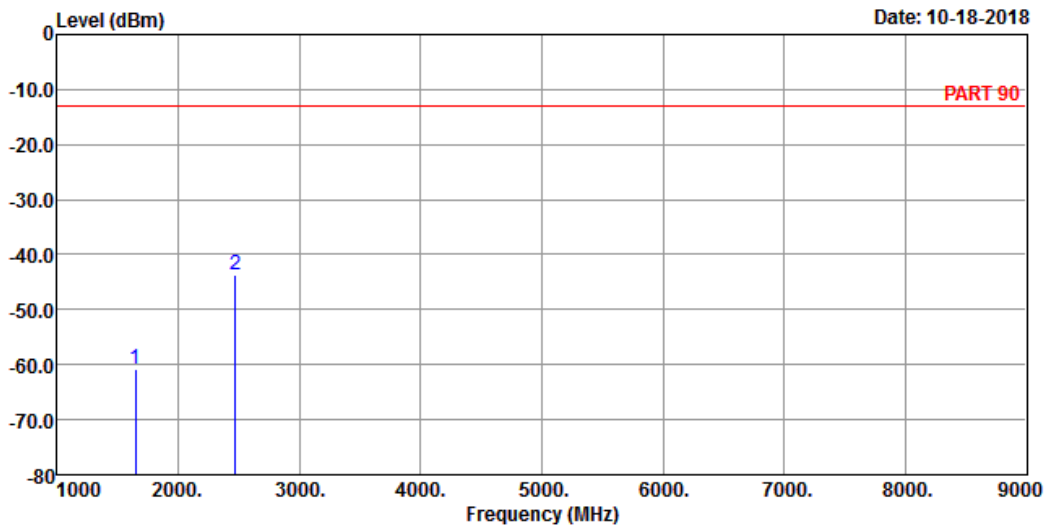

Site : 966 Chamber 5
 Condition: PART 90 HORIZONTAL
 Remak : LTE Band 26 QPSK_1.4M Link_H-CH
 Tested by: Thomas Wei

	Freq	Level	Read Level	Limit Line	Over Limit	Factor	Remark
	MHz	dBm	dBm	dBm	dB	dB	
1	1646.60	-60.69	-45.96	-13.00	-47.69	-14.73	Peak
2 pp	2469.90	-43.77	-33.33	-13.00	-30.77	-10.44	Peak



Bureau Veritas Consumer Products Services Ltd., Taoyuan Branch

A D T

Data: 2

Date: 10-18-2018

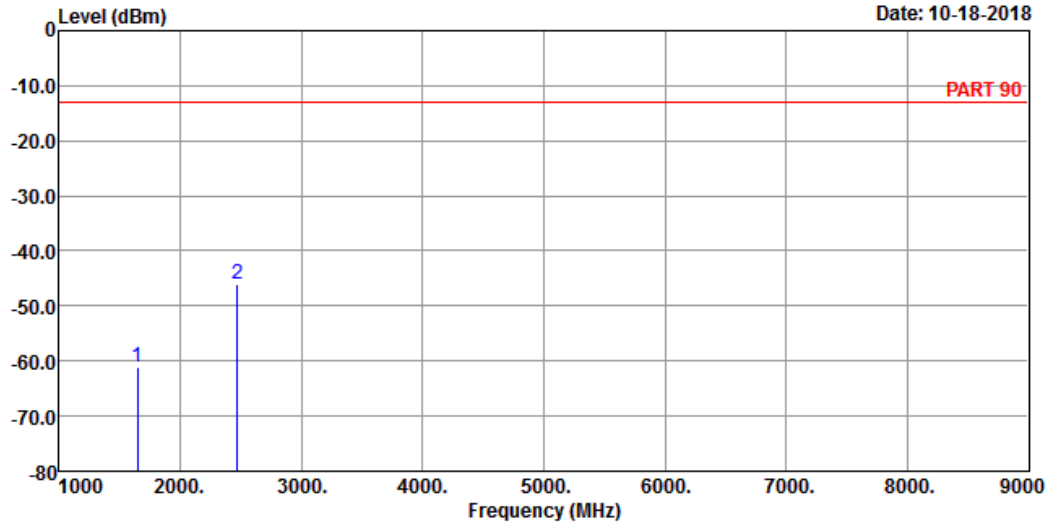

Site : 966 Chamber 5
 Condition: PART 90 VERTICAL
 Remak : LTE Band 26 QPSK_1.4M Link_H-CH
 Tested by: Thomas Wei

	Freq	Level	Read Level	Limit Line	Over Limit	Factor	Remark
	MHz	dBm	dBm	dBm	dB	dB	
1	1646.60	-61.18	-46.45	-13.00	-48.18	-14.73	Peak
2	2469.90	-45.99	-35.55	-13.00	-32.99	-10.44	Peak

Channel Bandwidth: 5 MHz / QPSK
Low Channel



Bureau Veritas Consumer Products Services Ltd., Taoyuan Branch

A D T

Data: 1

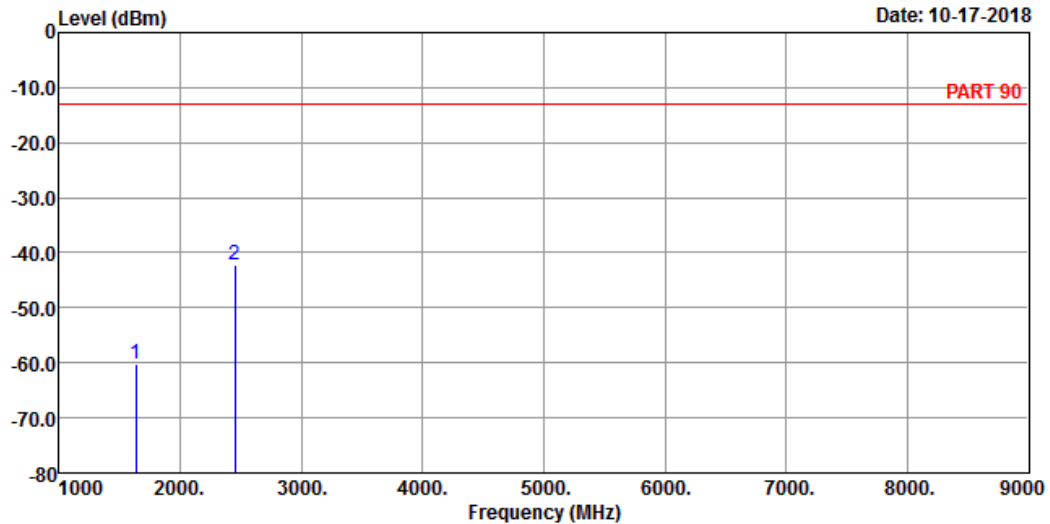

Site : 966 Chamber 5
Condition: PART 90 HORIZONTAL
Remak : LTE Band 26 QPSK_5M Link_L-CH
Tested by: Thomas Wei

	Freq	Level	Read Level	Limit Line	Over Limit	Factor	Remark
	MHz	dBm	dBm	dBm	dB	dB	
1	1633.00	-60.14	-45.35	-13.00	-47.14	-14.79	Peak
2 pp	2449.50	-42.18	-31.74	-13.00	-29.18	-10.44	Peak



Bureau Veritas Consumer Products Services Ltd., Taoyuan Branch

A D T

Data: 2

Date: 10-17-2018

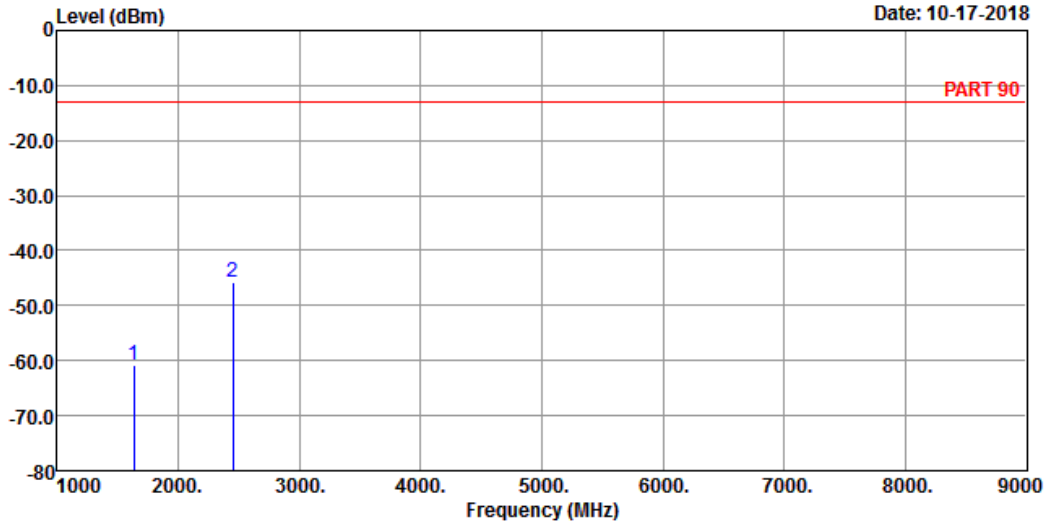

Site : 966 Chamber 5
 Condition: PART 90 VERTICAL
 Remak : LTE Band 26 QPSK_5M Link_L-CH
 Tested by: Thomas Wei

	Freq	Level	Read Level	Limit Line	Over Limit	Factor	Remark
	MHz	dBm	dBm	dBm	dB	dB	
1	1633.00	-60.78	-45.99	-13.00	-47.78	-14.79	Peak
2	2449.50	-45.75	-35.31	-13.00	-32.75	-10.44	Peak

Middle Channel



Bureau Veritas Consumer Products Services Ltd., Taoyuan Branch

A D T

Data: 1

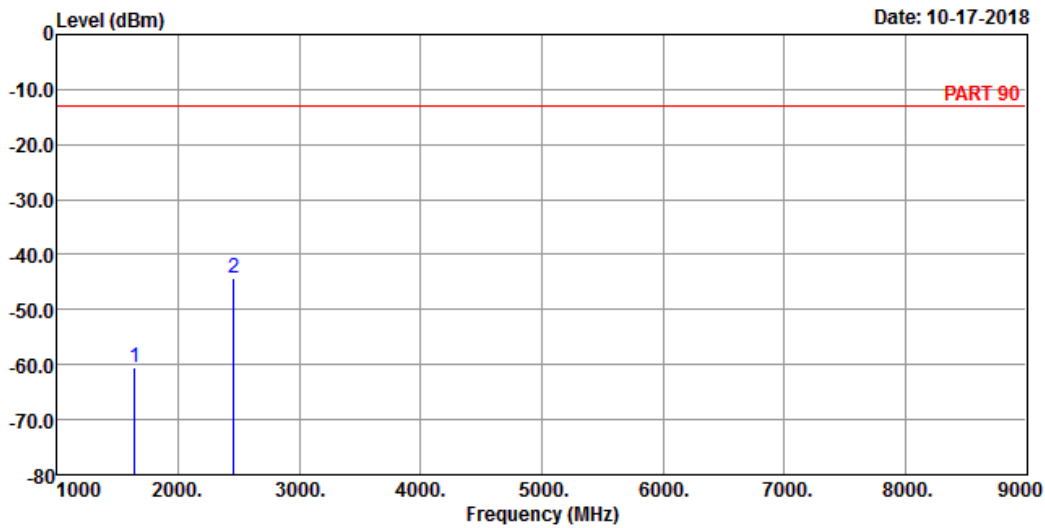

Site : 966 Chamber 5
 Condition: PART 90 HORIZONTAL
 Remak : LTE Band 26 QPSK_5M Link_M-CH
 Tested by: Thomas Wei

	Read	Limit	Over			
Freq	Level	Level	Line	Limit	Factor	Remark
MHz	dBm	dBm	dBm	dB	dB	
1	1638.00	-60.65	-45.86	-13.00	-47.65	-14.79 Peak
2 pp	2457.00	-44.21	-33.77	-13.00	-31.21	-10.44 Peak



Bureau Veritas Consumer Products Services Ltd., Taoyuan Branch

A D T

Data: 2

Date: 10-17-2018

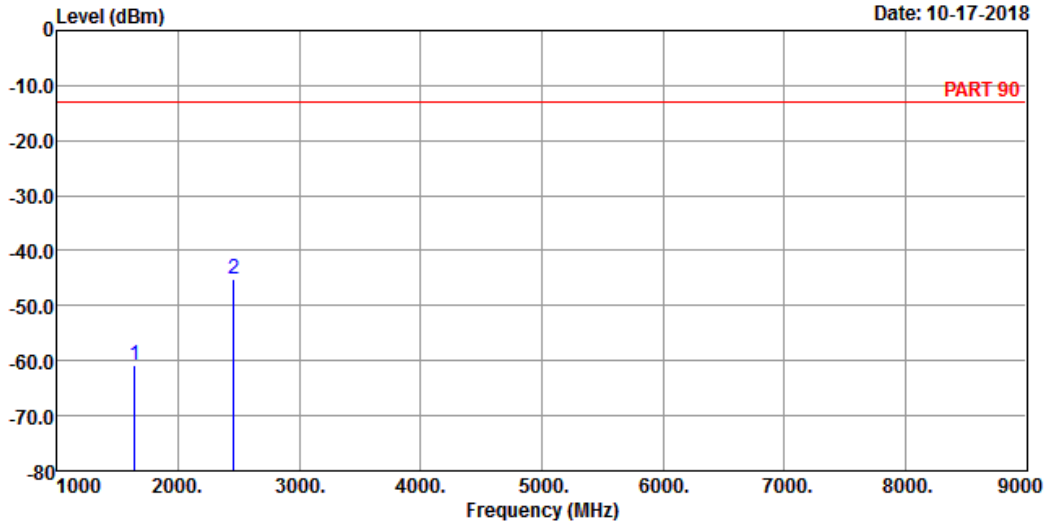

Site : 966 Chamber 5
 Condition: PART 90 VERTICAL
 Remak : LTE Band 26 QPSK_5M Link_M-CH
 Tested by: Thomas Wei

	Freq	Level	Read Level	Limit Line	Over Limit	Factor	Remark
	MHz	dBm	dBm	dBm	dB	dB	
1	1638.00	-60.88	-46.09	-13.00	-47.88	-14.79	Peak
2	2457.00	-45.20	-34.76	-13.00	-32.20	-10.44	Peak

High Channel



Bureau Veritas Consumer Products Services Ltd., Taoyuan Branch

A D T

Data: 1

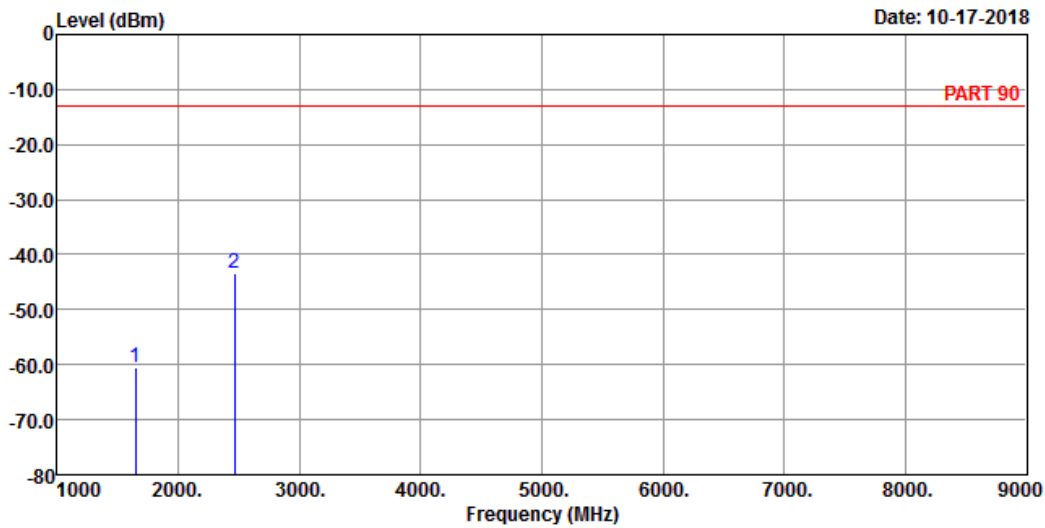

Site : 966 Chamber 5
 Condition: PART 90 HORIZONTAL
 Remak : LTE Band 26 QPSK_5M Link_H-CH
 Tested by: Thomas Wei

	Freq	Level	Read Level	Limit	Over	Factor	Remark
	MHz	dBm	dBm	dBm	dB	dB	
1	1643.00	-60.63	-45.90	-13.00	-47.63	-14.73	Peak
2 pp	2464.50	-43.38	-32.94	-13.00	-30.38	-10.44	Peak



Bureau Veritas Consumer Products Services Ltd., Taoyuan Branch

A D T

Data: 2

Date: 10-17-2018

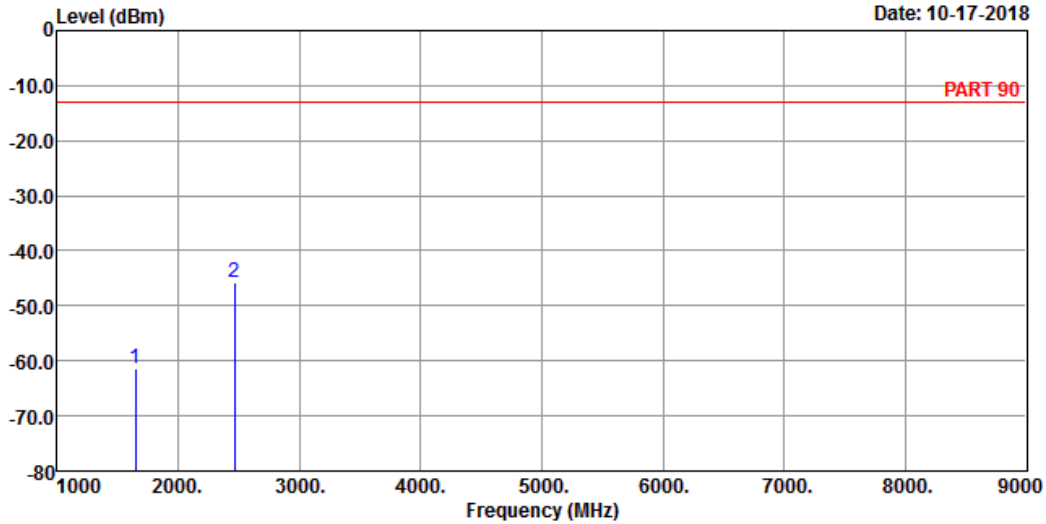

Site : 966 Chamber 5
 Condition: PART 90 VERTICAL
 Remak : LTE Band 26 QPSK_5M Link_H-CH
 Tested by: Thomas Wei

	Freq	Level	Read Level	Limit Line	Over Limit	Factor	Remark
	MHz	dBm	dBm	dBm	dB	dB	
1	1643.00	-61.27	-46.54	-13.00	-48.27	-14.73	Peak
2 pp	2464.50	-45.77	-35.33	-13.00	-32.77	-10.44	Peak

Channel Bandwidth: 10 MHz / QPSK
Middle Channel



Bureau Veritas Consumer Products Services Ltd., Taoyuan Branch

A D T

Data: 5

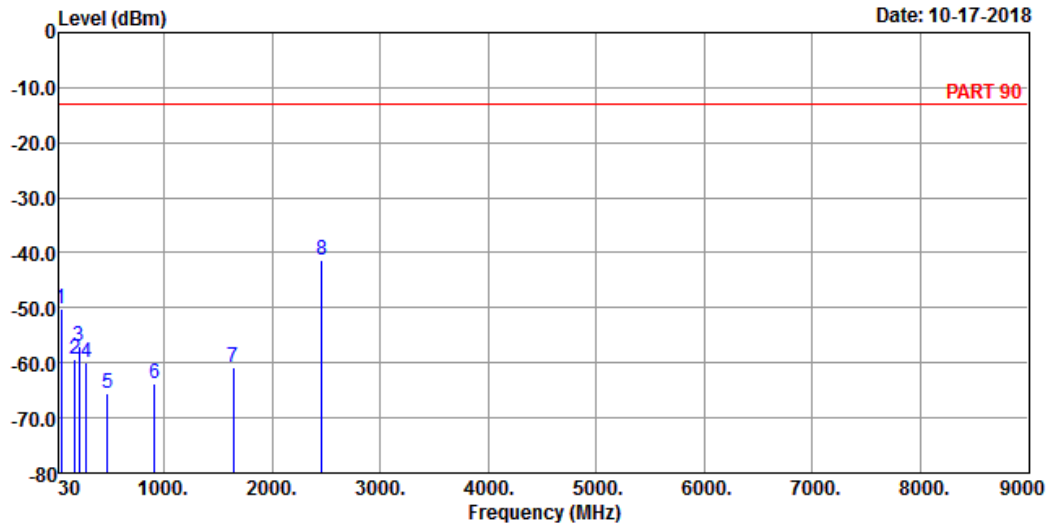

Site : 966 Chamber 5
Condition: PART 90 HORIZONTAL
Remak : LTE Band 26 QPSK_10M Link_M-CH
Tested by: Thomas Wei

	Freq	Level	Read Level	Limit Line	Over Limit	Factor	Remark
	MHz	dBm	dBm	dBm	dB	dB	
1	44.55	-50.24	-48.25	-13.00	-37.24	-1.99	Peak
2	172.59	-59.38	-53.34	-13.00	-46.38	-6.04	Peak
3	212.36	-56.96	-49.45	-13.00	-43.96	-7.51	Peak
4	277.35	-60.06	-53.51	-13.00	-47.06	-6.55	Peak
5	474.26	-65.63	-60.53	-13.00	-52.63	-5.10	Peak
6	913.67	-63.71	-64.62	-13.00	-50.71	0.91	Peak
7	1638.00	-60.76	-45.97	-13.00	-47.76	-14.79	Peak
8 pp	2457.00	-41.43	-30.99	-13.00	-28.43	-10.44	Peak



Bureau Veritas Consumer Products Services Ltd., Taoyuan Branch

A D T

Data: 6

Date: 10-17-2018

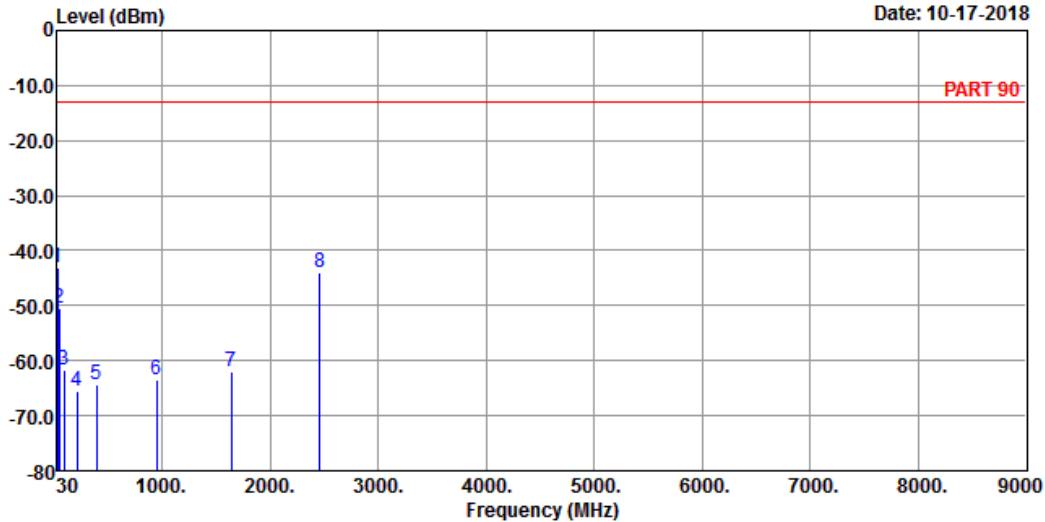

Site : 966 Chamber 5
 Condition: PART 90 VERTICAL
 Remak : LTE Band 26 QPSK_10M Link_M-CH
 Tested by: Thomas Wei

	Freq	Level	Read Level	Limit Line	Over Limit	Factor	Remark
	MHz	dBm	dBm	dBm	dB	dB	
1 pp	30.00	-43.24	-43.62	-13.00	-30.24	0.38	Peak
2	44.55	-50.59	-48.60	-13.00	-37.59	-1.99	Peak
3	95.96	-61.66	-50.88	-13.00	-48.66	-10.78	Peak
4	215.27	-65.49	-58.09	-13.00	-52.49	-7.40	Peak
5	395.69	-64.32	-58.35	-13.00	-51.32	-5.97	Peak
6	945.68	-63.33	-65.03	-13.00	-50.33	1.70	Peak
7	1638.00	-61.85	-47.06	-13.00	-48.85	-14.79	Peak
8	2457.00	-43.84	-33.40	-13.00	-30.84	-10.44	Peak

5 Pictures of Test Arrangements

Please refer to the attached file (Test Setup Photo).

Appendix – Information on the Testing Laboratories

We, Bureau Veritas Consumer Products Services (H.K.) Ltd., Taoyuan Branch, were founded in 1988 to provide our best service in EMC, Radio, Telecom and Safety consultation. Our laboratories are FCC recognized accredited test firms and accredited according to ISO/IEC 17025.

If you have any comments, please feel free to contact us at the following:

Linko EMC/RF Lab

Tel: 886-2-26052180

Fax: 886-2-26051924

Hsin Chu EMC/RF/Telecom Lab

Tel: 886-3-6668565

Fax: 886-3-6668323

Hwa Ya EMC/RF/Safety

Tel: 886-3-3183232

Fax: 886-3-3270892

Email: service.adt@tw.bureauveritas.com

Web Site: www.bureauveritas-adt.com

The address and road map of all our labs can be found in our web site also.

--- END ---