



FCC TEST REPORT

FCC ID:2BN4S-T20

Applicant: NELLO TECHNOLOGY (SHENZHEN) CO., LTD.
Address: 8rd F,Bldg B,Xuda Industrial Bldg, Fuyuan St,Bao'an District, Shenzhen, China
Manufacturer: NELLO TECHNOLOGY (SHENZHEN) CO., LTD.
Address: 8rd F,Bldg B,Xuda Industrial Bldg, Fuyuan St,Bao'an District, Shenzhen, China
EUT: Mobile phone rear camera screen sharing device
Trade Mark: N/A
Model Number: T20
T20B, T20C, T20D, T20H, T20Q, M1, M2, M3, M4, M5, M6, T1H, T1M, T1P, T1C, T1W, T1F, T2H, T2M, T2F, T3, T3B, T3D, T3M, T3H, T5H, T5F, T6H, T6F, T7H, T7F, T8D, T8H, T8Pro, T9H, T9PRO, T9P, T10H, T10M, T10Pro, T11H, T11M, T12H, T12M, T13H, T13M, T15H, T15M, T16H, T16M, T17H, T17F, T17M, T18H, T18P, T19H, T19M, M7, M8, NS-T5, T20B-Lite, T11, T11pro, T11Plus, T1Plus, T1pro
Date of Receipt: Jun. 12, 2025
Test Date: Jun. 12, 2025 to Jul. 09, 2025
Date of Report: Jul. 09, 2025
Prepared By: Shenzhen DL Testing Technology Co., Ltd.
Address: 101-201, Comprehensive Building, Tongzhou Electronics Longgang Factory Area, No.1 Baolong Fifth Road, Baolong Community, Baolong Street, Longgang District, Shenzhen, China
Applicable Standards: FCC CFR Title 47 Part 15 Subpart C Section 15.247
ANSI C63.10:2013
Test Result: Pass
Report Number: DLE-250708004R

Prepared (Engineer): Randy Xie

Reviewer (Supervisor): Jack Bu

Approved (Manager): Jade Yang



This test report is based on a single evaluation of one sample of above mentioned products. It is not permitted to be duplicated in extracts without written approval of Shenzhen DL Testing Technology Co., Ltd.



Table of Contents

	Page
1. VERSION	4
2. TEST SUMMARY	5
2.1 TEST FACILITY	6
2.2 MEASUREMENT UNCERTAINTY	6
3. GENERAL INFORMATION	7
3.1 GENERAL DESCRIPTION OF EUT	7
3.2 TEST SETUP CONFIGURATION	9
3.3 SUPPORT EQUIPMENT	9
3.4 TEST MODE	9
4. EMC EMISSION TEST	11
4.1 CONDUCTED EMISSIONS	11
4.1.1 POWER LINE CONDUCTED EMISSION LIMITS	11
4.1.2 TEST PROCEDURE	11
4.1.3 DEVIATION FROM TEST STANDARD	11
4.1.4 TEST SETUP	12
4.1.5 EUT OPERATING CONDITIONS	12
4.1.6 TEST RESULT	13
4.2 RADIATED EMISSIONS	15
4.2.1 RADIATED EMISSION LIMITS	15
4.2.2 TEST PROCEDURE	15
4.2.3 DEVIATION FROM TEST STANDARD	16
4.2.4 TEST SETUP	16
4.2.5 EUT OPERATING CONDITIONS	17
4.2.6 TEST RESULTS	17
5. RADIATED BAND EMISSION MEASUREMENT	26
5.1 TEST REQUIREMENT	26
5.2 TEST PROCEDURE	26
5.3 DEVIATION FROM TEST STANDARD	27
5.4 TEST SETUP	27
5.5 EUT OPERATING CONDITIONS	27
5.6 TEST RESULT	28
6. CONDUCTED BAND EDGE AND SPURIOUS EMISSION	31
6.1 LIMIT	31



6.2 TEST SETUP	31
6.3 TEST PROCEDURE.....	31
6.4 DEVIATION FROM STANDARD	31
6.5 TEST RESULT	32
7. 20DB OCCUPIED BANDWIDTH.....	38
7.1 TEST SETUP	38
7.2 LIMIT	38
7.3 TEST PROCEDURE.....	38
7.4 DEVIATION FROM STANDARD	38
7.5 TEST RESULT	39
8. MAXIMUM PEAK OUTPUT POWER	43
8.1 BLOCK DIAGRAM OF TEST SETUP	43
8.2 LIMIT	43
8.3 TEST PROCEDURE.....	43
8.4 DEVIATION FROM STANDARD	43
8.5 TEST RESULT	44
9. HOPPING CHANNEL SEPARATION.....	48
9.1 TEST SETUP	48
9.2 TEST PROCEDURE.....	48
9.3 DEVIATION FROM STANDARD	48
9.4 TEST RESULT	49
10.NUMBER OF HOPPING FREQUENCY	53
10.1 TEST SETUP	53
10.2 TEST PROCEDURE.....	53
10.3 DEVIATION FROM STANDARD	53
10.4 TEST RESULT	54
11. DWELL TIME	56
11.1 TEST SETUP	56
11.2 TEST PROCEDURE.....	56
11.3 DEVIATION FROM STANDARD	56
11.4 TEST RESULT	57
12. ANTENNA REQUIREMENT.....	61
13. TEST SETUP PHOTO.....	62
14. EUT CONSTRUCTIONAL DETAILS.....	62



1. VERSION

Report No.	Version	Description	Approved
DLE-250708004R	Rev.01	Initial issue of report	Jul. 09, 2025



2. TEST SUMMARY

Test procedures according to the technical standards:

FCC Part15 (15.247) , Subpart C			
Standard Section	Test Item	Result	Remark
15.203/15.247 (c)	Antenna Requirement	PASS	
15.207	AC Power Line Conducted Emission	PASS	
15.247 (b)(1)	Conducted Peak Output Power	PASS	
15.247 (a)(1)	20dB Occupied Bandwidth	PASS	
15.247 (a)(1)	Carrier Frequencies Separation	PASS	
15.247 (a)(1)(iii)	Hopping Channel Number	PASS	
15.247 (a)(1)(iii)	Dwell Time	PASS	
15.205/15.209 15.247(d)	Radiated Emission and Restricted Band	PASS	
15.247(d)	Conducted Unwanted Emissions and Band Edge	PASS	

NOTE:

(1) "N/A" denotes test is not applicable in this Test Report



2.1 TEST FACILITY

Shenzhen DL Testing Technology Co., Ltd.

Add. : 101-201, Comprehensive Building, Tongzhou Electronics Longgang Factory Area, No.1 Baolong Fifth Road, Baolong Community, Baolong Street, Longgang District, Shenzhen, China

FCC Test Firm Registration Number: 854456

Designation Number: CN1307

IC Registered No.: 27485

CAB identifier: CN0118

2.2 MEASUREMENT UNCERTAINTY

The reported uncertainty of measurement $y \pm U$, where expanded uncertainty U is based on a standard uncertainty multiplied by a coverage factor of $k=2$, providing a level of confidence of approximately 95 %.

No.	Item	Uncertainty
1	3m chamber Radiated spurious emission(9KHz-30MHz)	U=4.5dB
2	3m chamber Radiated spurious emission(30MHz-1GHz)	U=4.8dB
3	3m chamber Radiated spurious emission(1GHz-6GHz)	U=4.9dB
4	3m chamber Radiated spurious emission(6GHz-40GHz)	U=5.0dB
5	Conducted disturbance	U=3.2dB
6	RF Band Edge	U=1.68dB
7	RF power conducted	U=1.86dB
8	RF conducted Spurious Emission	U=2.2dB
9	RF Occupied Bandwidth	U=1.8MHz
10	RF Power Spectral Density	U=1.75dB
11	humidity uncertainty	U=5.3%
12	Temperature uncertainty	U=0.59°C
13	Dwell Time	U=0.02ms



3. GENERAL INFORMATION

3.1 GENERAL DESCRIPTION OF EUT

Product Name:	Mobile phone rear camera screen sharing device
Model No.:	T20
Serial No.:	T20B, T20C, T20D, T20H, T20Q, M1, M2, M3, M4, M5, M6, T1H, T1M, T1P, T1C, T1W, T1F, T2H, T2M, T2F, T3, T3B, T3D, T3M, T3H, T5H, T5F, T6H, T6F, T7H, T7F, T8D, T8H, T8Pro, T9H, T9PRO, T9P, T10H, T10M, T10Pro, T11H, T11M, T12H, T12M, T13H, T13M, T15H, T15M, T16H, T16M, T17H, T17F, T17M, T18H, T18P, T19H, T19M, M7, M8, NS-T5, T20B-Lite, T11, T11pro, T11Plus, T1Plus, T1pro
Model Different.:	All the model are the same circuit and RF module, Only the model name and appearance color is different.
Hardware Version:	V1.0
Software Version:	V1.1
Sample(s) Status:	Engineer sample
Channel Numbers:	79 Channels
Channel Spacing:	1MHz
Operation Frequency:	2402MHz~2480MHz
Bluetooth Version:	V5.0
Modulation Technology:	GFSK, $\pi/4$ -DQPSK, 8-DPSK
Antenna Type:	PCB Antenna
Antenna Gain:	-6.31dBi
Power Supply:	Input: 5V---1A
Battery Capacity:	DC 3.7V, 1500mAh, 5.55Wh



Operation Frequency each of channel							
Channel	Frequency	Channel	Frequency	Channel	Frequency	Channel	Frequency
1	2402MHz	21	2422MHz	41	2442MHz	61	2462MHz
2	2403MHz	22	2423MHz	42	2443MHz	62	2463MHz
3	2404MHz	23	2424MHz	43	2444MHz	63	2464MHz
4	2405MHz	24	2425MHz	44	2445MHz	64	2465MHz
5	2406MHz	25	2426MHz	45	2446MHz	65	2466MHz
6	2407MHz	26	2427MHz	46	2447MHz	66	2467MHz
7	2408MHz	27	2428MHz	47	2448MHz	67	2468MHz
8	2409MHz	28	2429MHz	48	2449MHz	68	2469MHz
9	2410MHz	29	2430MHz	49	2450MHz	69	2470MHz
10	2411MHz	30	2431MHz	50	2451MHz	70	2471MHz
11	2412MHz	31	2432MHz	51	2452MHz	71	2472MHz
12	2413MHz	32	2433MHz	52	2453MHz	72	2473MHz
13	2414MHz	33	2434MHz	53	2454MHz	73	2474MHz
14	2415MHz	34	2435MHz	54	2455MHz	74	2475MHz
15	2416MHz	35	2436MHz	55	2456MHz	75	2476MHz
16	2417MHz	36	2437MHz	56	2457MHz	76	2477MHz
17	2418MHz	37	2438MHz	57	2458MHz	77	2478MHz
18	2419MHz	38	2439MHz	58	2459MHz	78	2479MHz
19	2420MHz	39	2440MHz	59	2460MHz	79	2480MHz
20	2421MHz	40	2441MHz	60	2461MHz		

Note:

In section 15.31(m), regards to the operating frequency range over 10 MHz, the Lowest frequency, the middle frequency, and the highest frequency of channel were selected to perform the test, and the selected channel see below:

Test channel	Frequency
The lowest channel	2402MHz
The middle channel	2441MHz
The Highest channel	2480MHz



3.2 TEST SETUP CONFIGURATION

Conducted Emission

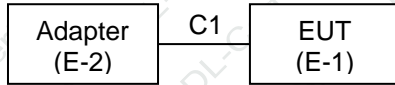

Radiated Emission

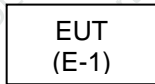

Conducted Spurious

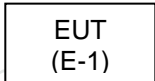

3.3 SUPPORT EQUIPMENT

The EUT has been tested as an independent unit together with other necessary accessories or support units. The following support units or accessories were used to form a representative test configuration during the tests.

Item	Equipment	Mfr/Brand	Model/Type No.	Series No.	Note
E-1	Mobile phone rear camera screen sharing device	N/A	T20	N/A	EUT
E-2	AC/DC Adapter	SAMSUNG	EP-T4510	N/A	Auxiliary

Item	Shielded Type	Ferrite Core	Length	Note
C1	NO	NO	0.8M	Type-C USB Cable

Note:

- (1) The support equipment was authorized by Declaration of Confirmation.
- (2) For detachable type I/O cable should be specified the length in cm in 『Length』 column.

3.4 TEST MODE

Transmitting mode	Keep the EUT in continuously transmitting mode
Remark: During the test, the test voltage was tuned from 85% to 115% of the nominal rated supply voltage, and found that the worst case was under the nominal rated supply condition. So the report just shows that condition's data. For battery operated equipment, the equipment tests shall be performed using a new battery.	

Test Software	CMD
Power level setup	Default



3.5 EQUIPMENTS LIST FOR ALL TEST ITEMS

Radiation test, Band-edge test and 6db bandwidth test equipment

Item	Equipment	Manufacturer	Type No.	Serial No.	Last calibration	Calibrated until
1	Spectrum Analyzer (9kHz-26.5GHz)	Agilent	E4408B	MY50140780	Nov. 01, 2024	Oct. 31, 2025
2	Test Receiver (9kHz-7GHz)	R&S	ESRP7	101393	Nov. 01, 2024	Oct. 31, 2025
3	Bilog Antenna (30MHz-1GHz)	R&S	VULB9162	00306	Nov. 01, 2024	Oct. 31, 2025
4	Horn Antenna (1GHz-18GHz)	Schwarzbeck	BBHA9120D	02139	Nov. 01, 2024	Oct. 31, 2025
5	Horn Antenna (18GHz-40GHz)	A.H. Systems	SAS-574	588	Nov. 01, 2024	Oct. 31, 2025
6	Amplifier (9kHz-6GHz)	Schwarzbeck	BBV9743B	00153	Nov. 01, 2024	Oct. 31, 2025
7	Amplifier (1GHz-18GHz)	EMEC	EM01G8GA	00270	Nov. 01, 2024	Oct. 31, 2025
8	Amplifier (18GHz-40GHz)	Quanjuda	DLE-161	97	Nov. 01, 2024	Oct. 31, 2025
9	Loop Antenna (9kHz-30MHz)	Schwarzbeck	FMZB1519B	00014	Nov. 01, 2024	Oct. 31, 2025
10	RF cables1 (9kHz-1GHz)	ChengYu	966	004	Nov. 01, 2024	Oct. 31, 2025
11	RF cables2 (1GHz-40GHz)	ChengYu	966	003	Nov. 01, 2024	Oct. 31, 2025
12	Antenna connector	Florida RF Labs	N/A	RF 01#	Nov. 01, 2024	Oct. 31, 2025
13	Power probe	KEYSIGHT	U2021XA	MY55210018	Nov. 01, 2024	Oct. 31, 2025
14	Signal Analyzer 9kHz-26.5GHz	Agilent	N9020A	MY55370280	Nov. 01, 2024	Oct. 31, 2025
15	Test Receiver 20kHz-40GHz	R&S	ESU 40	100376	Nov. 01, 2024	Oct. 31, 2025
16	D.C. Power Supply	LongWei	PS-305D	010964729	Nov. 01, 2024	Oct. 31, 2025

Conduction Test equipment

Item	Equipment	Manufacturer	Type No.	Serial No.	Last calibration	Calibrated until
1	843 Shielded Room	YIHENG	843 Room	843	Nov. 05, 2023	Nov. 04, 2026
2	EMI Receiver	R&S	ESR	101421	Nov. 01, 2024	Oct. 31, 2025
3	LISN	R&S	ENV216	102417	Nov. 01, 2024	Oct. 31, 2025
4	843 Cable 1#	ChengYu	CE Cable	001	Nov. 01, 2024	Oct. 31, 2025

Other

Item	Name	Manufacturer	Model	Software version
1	EMC Conduction Test System	FALA	EZ_EMCC	EMC-CON 3A1.1
2	EMC radiation test system	FALA	EZ_EMCC	FA-03A2
3	RF test system	MAIWEI	MTS8310	2.0.0.0
4	RF communication test system	MAIWEI	MTS8200	2.0.0.0



4. EMC EMISSION TEST

4.1 CONDUCTED EMISSIONS

Test Requirement:	FCC Part15 C Section 15.207
Test Method:	ANSI C63.10:2013
Test Frequency Range:	150KHz to 30MHz
Receiver setup:	RBW=9KHz, VBW=30KHz, Sweep time=auto

4.1.1 POWER LINE CONDUCTED EMISSION LIMITS

FREQUENCY (MHz)	Limit (dBuV)		Standard
	Quasi-peak	Average	
0.15 -0.5	66 - 56 *	56 - 46 *	FCC
0.50 -5.0	56.00	46.00	FCC
5.0 -30.0	60.00	50.00	FCC

Note:

(1) *Decreases with the logarithm of the frequency.

4.1.2 TEST PROCEDURE

- The EUT was placed 0.8 meters from the horizontal ground plane with EUT being connected to the power mains through a line impedance stabilization network (LISN). All other support equipments powered from additional LISN(s). The LISN provide 50 Ohm/ 50uH of coupling impedance for the measuring instrument.
- Interconnecting cables that hang closer than 40 cm to the ground plane shall be folded back and forth in the center forming a bundle 30 to 40 cm long.
- I/O cables that are not connected to a peripheral shall be bundled in the center. The end of the cable may be terminated, if required, using the correct terminating impedance. The overall length shall not exceed 1 m.
- LISN at least 80 cm from nearest part of EUT chassis.
- For the actual test configuration, please refer to the related Item –EUT Test Photos.

4.1.3 DEVIATION FROM TEST STANDARD

No deviation



4.1.4 TEST SETUP

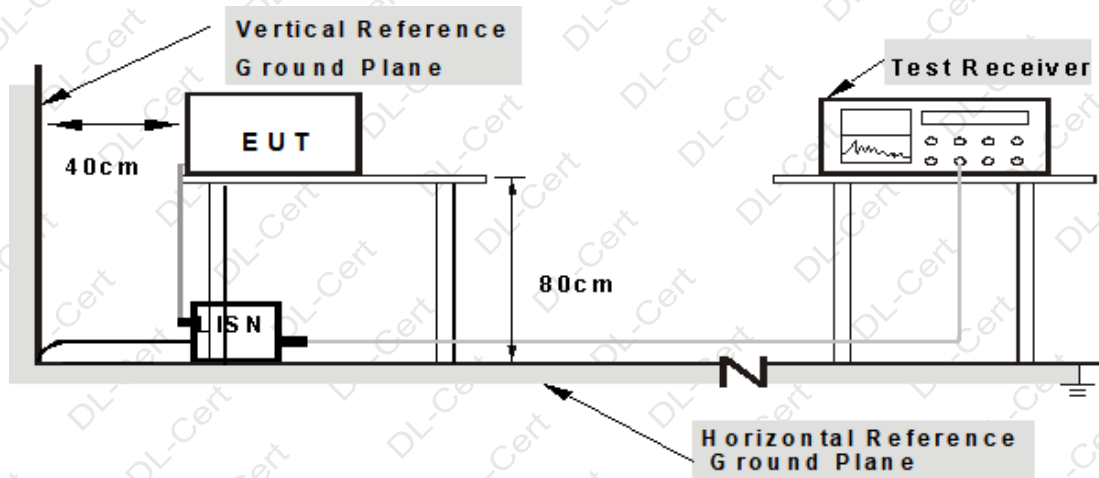

- Note: 1.Support units were connected to second LISN.
2.Both of LISNs (AMN) are 80 cm from EUT and at least 80 from other units and other metal planes**

4.1.5 EUT OPERATING CONDITIONS

The EUT was configured for testing in a typical fashion (as a customer would normally use it). The EUT has been programmed to Charging during test. This operating condition was tested and used to collect the included data.



4.1.6 TEST RESULT

Temperature:	26°C	Relative Humidity:	54%
Pressure:	101 kPa	Polarization:	L
Test Voltage:	AC 120V/60Hz	Test Mode:	8-DPSK 3-DH1 - 2402MHz

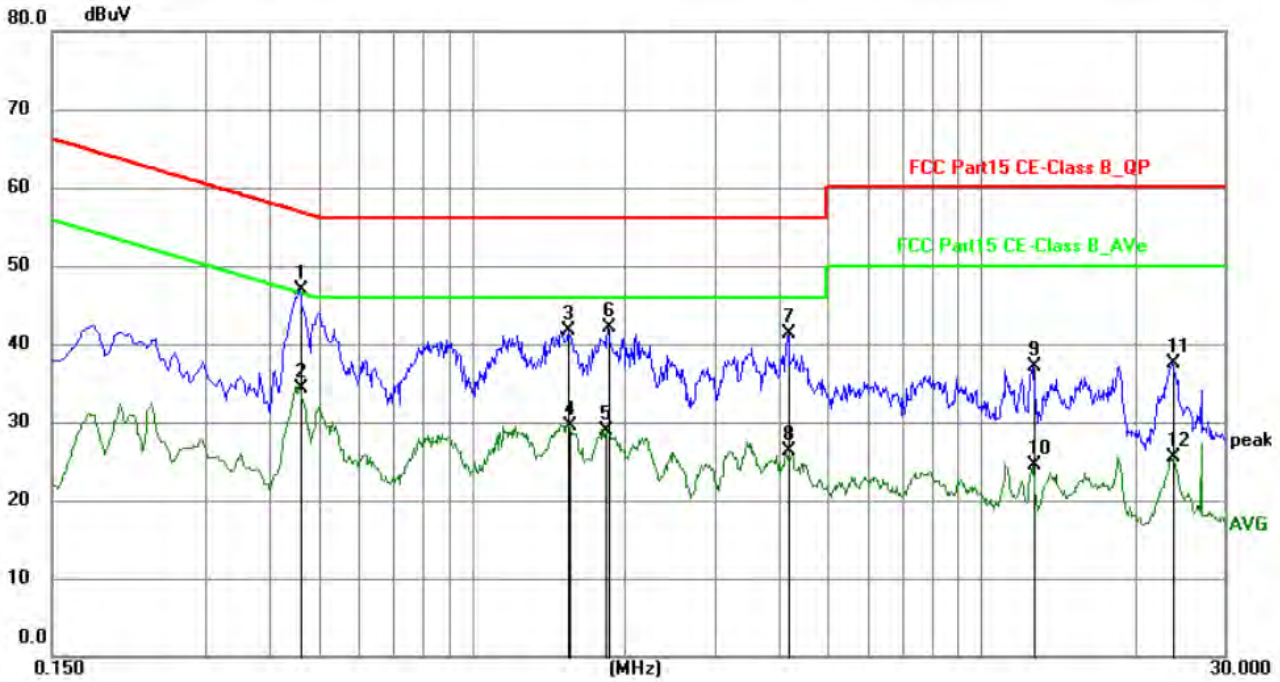

No.	Frequency (MHz)	Reading (dBuV)	Factor (dB)	Level (dBuV)	Limit (dBuV)	Margin (dB)	Detector	P/F	Remark
1	0.4605	26.65	20.31	46.96	56.68	-9.72	QP	P	
2	0.4605	14.03	20.31	34.34	46.68	-12.34	AVG	P	
3	1.5494	21.46	20.30	41.76	56.00	-14.24	QP	P	
4	1.5539	9.27	20.30	29.57	46.00	-16.43	AVG	P	
5	1.8374	8.57	20.31	28.88	46.00	-17.12	AVG	P	
6	1.8554	21.79	20.31	42.10	56.00	-13.90	QP	P	
7	4.1955	20.88	20.35	41.23	56.00	-14.77	QP	P	
8	4.1955	5.95	20.35	26.30	46.00	-19.70	AVG	P	
9	12.6510	16.66	20.47	37.13	60.00	-22.87	QP	P	
10	12.6510	4.05	20.47	24.52	50.00	-25.48	AVG	P	
11	23.6760	16.88	20.60	37.48	60.00	-22.52	QP	P	
12	23.7840	4.93	20.60	25.53	50.00	-24.47	AVG	P	

Notes:

1. An initial pre-scan was performed on the line and neutral lines with peak detector.
2. Quasi - Peak and Average measurement were performed at the frequencies with maximized peak emission.
3. Final Level = Reading level + Correct Factor.
4. Correct Factor = Lisen factor+ Cable loss factor + limiter factor.
5. Margin = Measurement Level-Limit.
6. The test data shows only the worst case 8-DPSK 3DH1 - 2402MHz.



Temperature:	26°C	Relative Humidity:	54%
Pressure:	101 kPa	Polarization:	N
Test Voltage:	AC 120V/60Hz	Test Mode:	8-DPSK 3-DH1 - 2402MHz

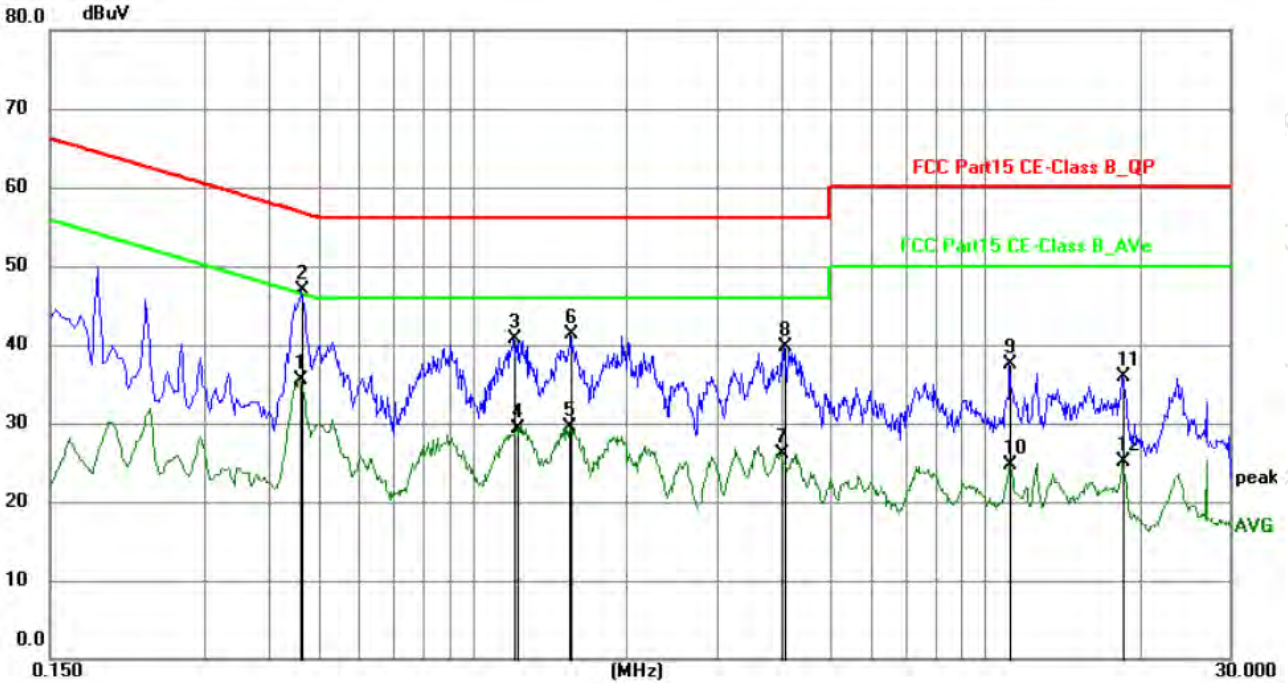

No.	Frequency (MHz)	Reading (dBuV)	Factor (dB)	Level (dBuV)	Limit (dBuV)	Margin (dB)	Detector	P/F	Remark
1	0.4605	15.13	20.31	35.44	46.68	-11.24	AVG	P	
2	0.4650	26.50	20.31	46.81	56.60	-9.79	QP	P	
3	1.2074	20.39	20.30	40.69	56.00	-15.31	QP	P	
4	1.2209	9.03	20.30	29.33	46.00	-16.67	AVG	P	
5	1.5449	9.26	20.30	29.56	46.00	-16.44	AVG	P	
6	1.5539	21.06	20.30	41.36	56.00	-14.64	QP	P	
7	4.0020	5.74	20.33	26.07	46.00	-19.93	AVG	P	
8	4.0605	19.28	20.33	39.61	56.00	-16.39	QP	P	
9	11.1750	17.05	20.47	37.52	60.00	-22.48	QP	P	
10	11.1750	4.19	20.47	24.66	50.00	-25.34	AVG	P	
11	18.6135	15.42	20.52	35.94	60.00	-24.06	QP	P	
12	18.6135	4.56	20.52	25.08	50.00	-24.92	AVG	P	

Notes:

1. An initial pre-scan was performed on the line and neutral lines with peak detector.
2. Quasi - Peak and Average measurement were performed at the frequencies with maximized peak emission.
3. Final Level = Reading level + Correct Factor.
4. Correct Factor = Lisen factor + Cable loss factor + limiter factor.
5. Margin = Measurement Level - Limit.
6. The test data shows only the worst case 8-DPSK 3-DH1 - 2402MHz.



4.2 RADIATED EMISSIONS

Test Requirement:	FCC Part15 C Section 15.209				
Test Method:	ANSI C63.10:2013				
Test Frequency Range:	9kHz to 25GHz				
Test site:	Measurement Distance: 3m				
Receiver setup:	Frequency	Detector	RBW	VBW	Value
	9KHz-150KHz	Quasi-peak	200Hz	MX5Hz	Quasi-peak
	150KHz-30MHz	Quasi-peak	9KHz	30KHz	Quasi-peak
	30MHz-1GHz	Quasi-peak	100KHz	300KHz	Quasi-peak
	Above 1GHz	Peak	1MHz	3MHz	Peak
Peak		1MHz	10Hz	Average	

4.2.1 RADIATED EMISSION LIMITS

Frequencies (MHz)	Field Strength (micovolts/meter)	Measurement Distance (meters)
0.009~0.490	2400/F(KHz)	300
0.490~1.705	24000/F(KHz)	30
1.705~30.0	30	30
30~88	100	3
88~216	150	3
216~960	200	3
Above 960	500	3

LIMITS OF RADIATED EMISSION MEASUREMENT

Frequency (MHz)	Limit (dBuV/m) (at 3M)	
	Peak	Average
Above 1000	74	54

Notes:

- (1) The limit for radiated test was performed according to FCC PART 15C.
- (2) The tighter limit applies at the band edges.
- (3) Emission level (dBuV/m)=20log Emission level (uV/m).

4.2.2 TEST PROCEDURE

Below 1GHz test procedure as below:

- a. The EUT was placed on the top of a rotating table 0.8 meters above the ground at a 3 meter semi-anechoic chamber. The table was rotated 360 degrees to determine the position of the highest radiation.
- b. The EUT was set 3 meters away from the interference-receiving antenna, which was mounted on the top of a variable-height antenna tower.
- c. The antenna height is varied from one meter to four meters above the ground to determine the maximum value of the field strength. Both horizontal and vertical polarizations of the antenna are set to make the measurement.



- d. For each suspected emission, the EUT was arranged to its worst case and then the antenna was tuned to heights from 1 meter to 4 meters (for the test frequency of below 30MHz, the antenna was tuned to heights 1 meter) and the rotatable table was turned from 0 degrees to 360 degrees to find the maximum reading.
- e. The test-receiver system was set to Peak Detect Function and Specified Bandwidth with Maximum Hold Mode.
- f. If the emission level of the EUT in peak mode was 10dB lower than the limit specified, then testing could be stopped and the peak values of the EUT would be reported. Otherwise the emissions that did not have 10dB margin would be re-tested one by one using peak, quasi-peak or average method as specified and then reported in a data sheet.

Above 1GHz test procedure as below:

- g. Different between above is the test site, change from Semi- Anechoic Chamber to fully Anechoic Chamber and change form table 0.8 metre to 1.5 metre(Above 18GHz the distance is 1 meter and table is 1.5 metre).
- h. Test the EUT in the lowest channel ,the middle channel ,the Highest channel

Note:

Both horizontal and vertical antenna polarities were tested and performed pretest to three orthogonal axis. The worst case emissions were reported

4.2.3 DEVIATION FROM TEST STANDARD

No deviation

4.2.4 TEST SETUP

(A) Radiated Emission Test-Up Frequency Below 30MHz

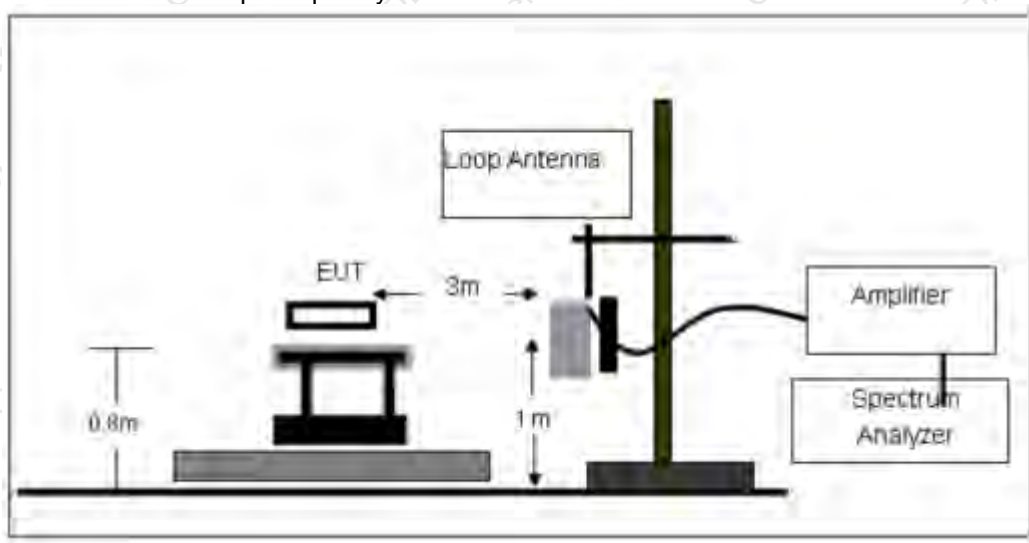

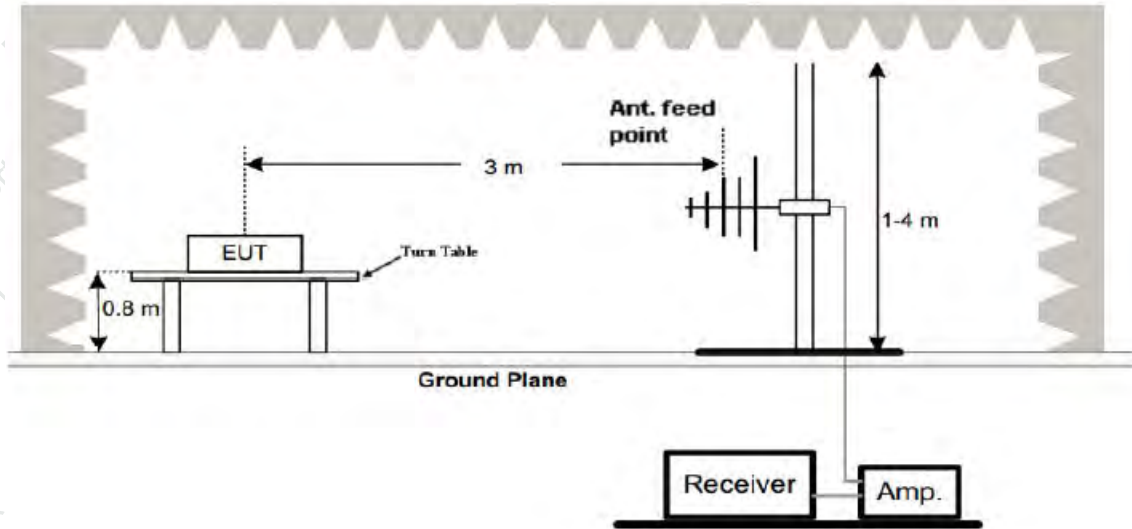
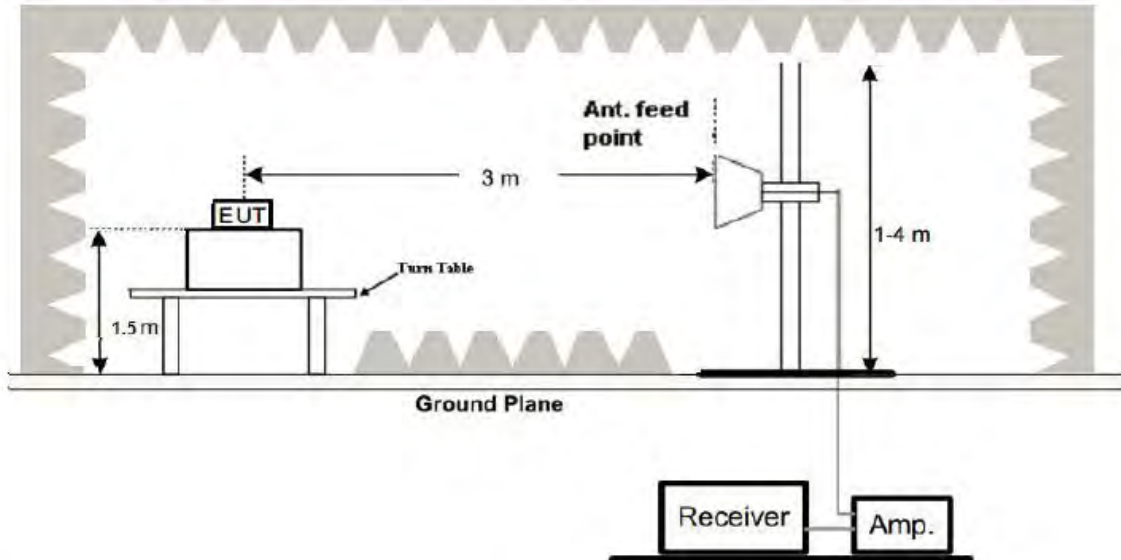
(B) Radiated Emission Test-Up Frequency 30MHz~1GHz**(C) Radiated Emission Test-Up Frequency Above 1GHz****4.2.5 EUT OPERATING CONDITIONS**

The EUT was configured for testing in a typical fashion (as a customer would normally use it). The EUT has been programmed to continuously transmit during test. This operating condition was tested and used to collect the included data.

4.2.6 TEST RESULTS**a. Between 9KHz – 30MHz**

The emission from 9 kHz to 30MHz was pre-tested and found the result was 20dB lower than the limit, and according to 15.31(o) & RSS-Gen 6.13, the test result no need to reported.



b. Between 30MHz – 1GHz

Temperature:	26°C	Relative Humidity:	54%
Pressure:	101 kPa	Polarization:	Horizontal
Test Voltage:	DC 3.7V	Test Mode :	8-DPSK 3-DH1 - 2402MHz

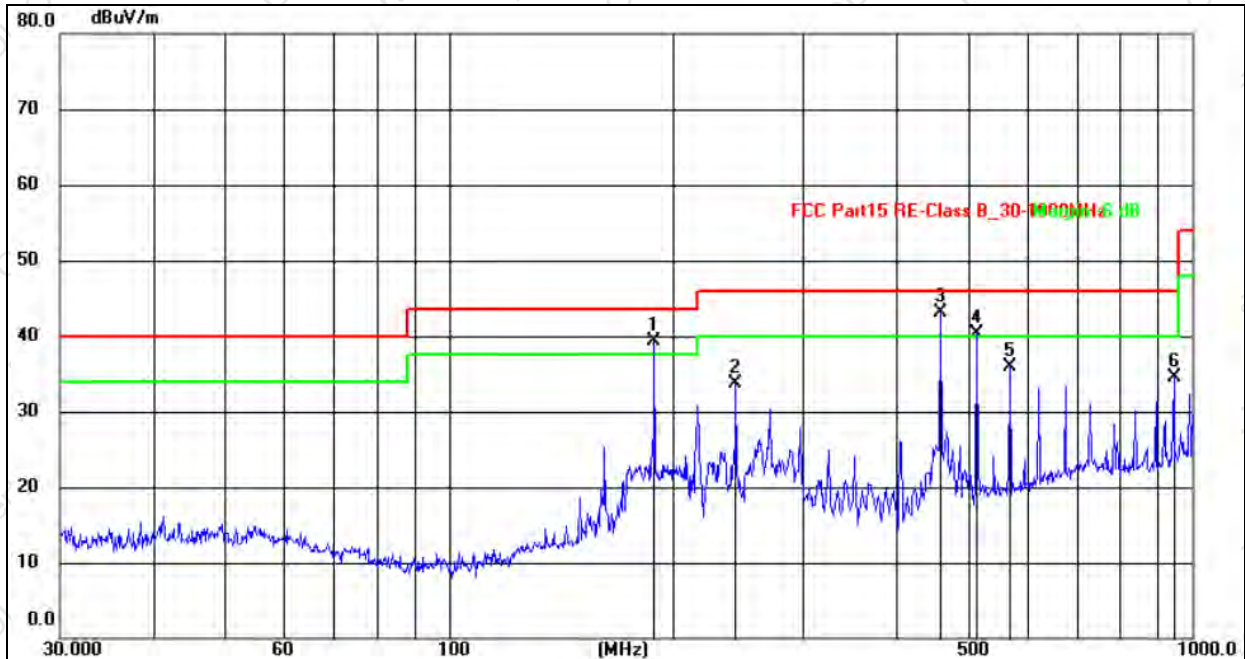

No.	Frequency (MHz)	Reading (dBuV)	Factor (dB/m)	Level (dBuV/m)	Limit (dBuV/m)	Margin (dB)	Detector
1	189.0741	57.20	-17.99	39.21	43.50	-4.29	QP
2	243.3771	49.44	-15.80	33.64	46.00	-12.36	QP
3	459.1143	56.25	-13.09	43.16	46.00	-2.84	QP
4	513.6331	51.05	-10.68	40.37	46.00	-5.63	QP
5	568.6126	45.16	-9.21	35.95	46.00	-10.05	QP
6	945.4400	40.25	-5.72	34.53	46.00	-11.47	QP

Remarks:

1. An initial pre-scan was performed on the peak detector.
2. Quasi-Peak measurement were performed at the frequencies with maximized peak emission.
3. The emission levels of other frequencies are very lower than the limit and not show in test report.
4. Final Level = Reading level + Correct Factor.
5. Correct Factor = Antenna factor+ Cable loss factor - Amplifier factor.
6. Margin= Measurement Level-Limit.
7. The test data shows only the worst case 8-DPSK 3-DH1 - 2402MHz.



Temperature:	26°C	Relative Humidity:	54%
Pressure:	101kPa	Polarization:	Vertical
Test Voltage:	DC 3.7V	Test Mode :	8-DPSK 3-DH1 - 2402MHz

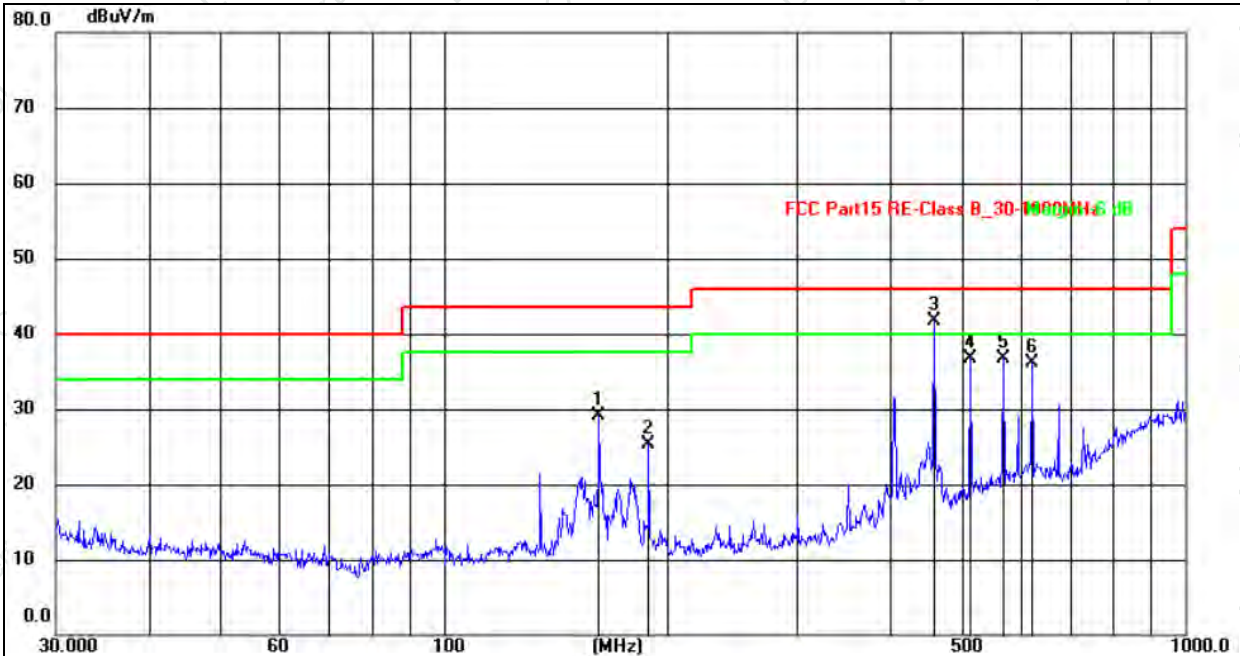

No.	Frequency (MHz)	Reading (dBuV)	Factor (dB/m)	Level (dBuV/m)	Limit (dBuV/m)	Margin (dB)	Detector
1	162.0413	49.03	-19.92	29.11	43.50	-14.39	QP
2	189.0741	45.17	-19.94	25.23	43.50	-18.27	QP
3	459.1143	54.05	-12.43	41.62	46.00	-4.38	QP
4	513.6331	47.12	-10.49	36.63	46.00	-9.37	QP
5	568.6126	45.17	-8.48	36.69	46.00	-9.31	QP
6	622.8900	43.37	-7.34	36.03	46.00	-9.97	QP

Remarks:

1. An initial pre-scan was performed on the peak detector.
2. Quasi-Peak measurement were performed at the frequencies with maximized peak emission.
3. The emission levels of other frequencies are very lower than the limit and not show in test report.
4. Final Level = Reading level + Correct Factor.
5. Correct Factor = Antenna factor+ Cable loss factor - Amplifier factor.
6. Margin= Measurement Level-Limit.
7. The test data shows only the worst case 8-DPSK 3-DH1 - 2402MHz.



c. 1GHz~25GHz

GFSK - 1-DH1

Polar (H/V)	Frequency	Meter Reading	Pre-am plifier	Cable Loss	Antenna Factor	Emission Level	Limits	Margin	Detector Type
	(MHz)	(dBuV)	(dB)	(dB)	(dB)	(dBuV/m)	(dBuV/m)	(dB)	
Low Channel:2402MHz									
V	4804.00	52.63	30.55	5.77	24.66	52.51	74.00	-21.49	PK
V	4804.00	43.69	30.55	5.77	24.66	43.57	54.00	-10.43	AV
V	7206.00	53.42	30.33	6.32	24.55	53.96	74.00	-20.04	PK
V	7206.00	43.52	30.33	6.32	24.55	44.06	54.00	-9.94	AV
V	9608.00	51.30	30.85	7.45	24.69	52.59	74.00	-21.41	PK
V	9608.00	43.65	30.85	7.45	24.69	44.94	54.00	-9.06	AV
V	12010.00	54.68	31.02	8.99	25.57	58.22	74.00	-15.78	PK
V	12010.00	43.96	31.02	8.99	25.57	47.50	54.00	-6.50	AV
H	4804.00	50.73	30.55	5.77	24.66	50.61	74.00	-23.39	PK
H	4804.00	43.54	30.55	5.77	24.66	43.42	54.00	-10.58	AV
H	7206.00	51.90	30.33	6.32	24.55	52.44	74.00	-21.56	PK
H	7206.00	43.53	30.33	6.32	24.55	44.07	54.00	-9.93	AV
H	9608.00	51.65	30.85	7.45	24.69	52.94	74.00	-21.06	PK
H	9608.00	43.96	30.85	7.45	24.69	45.25	54.00	-8.75	AV
H	12010.00	52.81	31.02	8.99	25.57	56.35	74.00	-17.65	PK
H	12010.00	43.72	31.02	8.99	25.57	47.26	54.00	-6.74	AV
Middle Channel:2441MHz									
V	4882.00	53.80	30.55	5.77	24.66	53.68	74.00	-20.32	PK
V	4882.00	43.20	30.55	5.77	24.66	43.08	54.00	-10.92	AV
V	7323.00	52.18	30.33	6.32	24.55	52.72	74.00	-21.28	PK
V	7323.00	43.31	30.33	6.32	24.55	43.85	54.00	-10.15	AV
V	9764.00	51.19	30.85	7.45	24.69	52.48	74.00	-21.52	PK
V	9764.00	43.20	30.85	7.45	24.69	44.49	54.00	-9.51	AV
V	12205.00	52.04	31.02	8.99	25.57	55.58	74.00	-18.42	PK
V	12205.00	43.78	31.02	8.99	25.57	47.32	54.00	-6.68	AV
H	4882.00	50.13	30.55	5.77	24.66	50.01	74.00	-23.99	PK
H	4882.00	43.60	30.55	5.77	24.66	43.48	54.00	-10.52	AV
H	7323.00	50.09	30.33	6.32	24.55	50.63	74.00	-23.37	PK
H	7323.00	43.70	30.33	6.32	24.55	44.24	54.00	-9.76	AV
H	9764.00	54.99	30.85	7.45	24.69	56.28	74.00	-17.72	PK
H	9764.00	43.96	30.85	7.45	24.69	45.25	54.00	-8.75	AV
H	12205.00	54.43	31.02	8.99	25.57	57.97	74.00	-16.03	PK
H	12205.00	43.93	31.02	8.99	25.57	47.47	54.00	-6.53	AV
High Channel:2480MHz									
V	4960.00	52.08	30.55	5.77	24.66	51.96	74.00	-22.04	PK
V	4960.00	43.40	30.55	5.77	24.66	43.28	54.00	-10.72	AV
V	7440.00	51.14	30.33	6.32	24.55	51.68	74.00	-22.32	PK
V	7440.00	43.41	30.33	6.32	24.55	43.95	54.00	-10.05	AV
V	9920.00	50.78	30.85	7.45	24.69	52.07	74.00	-21.93	PK



V	9920.00	43.34	30.85	7.45	24.69	44.63	54.00	-9.37	AV
V	12400.00	52.71	31.02	8.99	25.57	56.25	74.00	-17.75	PK
V	12400.00	43.37	31.02	8.99	25.57	46.91	54.00	-7.09	AV
H	4960.00	53.87	30.55	5.77	24.66	53.75	74.00	-20.25	PK
H	4960.00	43.78	30.55	5.77	24.66	43.66	54.00	-10.34	AV
H	7440.00	51.63	30.33	6.32	24.55	52.17	74.00	-21.83	PK
H	7440.00	43.44	30.33	6.32	24.55	43.98	54.00	-10.02	AV
H	9920.00	50.97	30.85	7.45	24.69	52.26	74.00	-21.74	PK
H	9920.00	43.04	30.85	7.45	24.69	44.33	54.00	-9.67	AV
H	12400.00	52.44	31.02	8.99	25.57	55.98	74.00	-18.02	PK
H	12400.00	43.22	31.02	8.99	25.57	46.76	54.00	-7.24	AV

Remark:

1. Emission Level = Meter Reading + Antenna Factor + Cable Loss – Pre-amplifier,
Margin= Emission Level - Limit
2. If peak below the average limit, the average emission was no test.
3. The amplitude of spurious emissions which are attenuated by more than 20dB below the permissible value has no need to be reported.



π/4-DQPSK - 2-DH1

Polar (H/V)	Frequency	Meter Reading	Pre-amp lifier	Cable Loss	Antenna Factor	Emission Level	Limits	Margin	Detector Type
	(MHz)	(dBuV)	(dB)	(dB)	(dB)	(dBuV/m)	(dBuV/m)	(dB)	
Low Channel:2402MHz									
V	4804.00	51.22	30.55	5.77	24.66	51.10	74.00	-22.90	PK
V	4804.00	43.25	30.55	5.77	24.66	43.13	54.00	-10.87	AV
V	7206.00	51.45	30.33	6.32	24.55	51.99	74.00	-22.01	PK
V	7206.00	43.96	30.33	6.32	24.55	44.50	54.00	-9.50	AV
V	9608.00	52.95	30.85	7.45	24.69	54.24	74.00	-19.76	PK
V	9608.00	43.06	30.85	7.45	24.69	44.35	54.00	-9.65	AV
V	12010.00	54.61	31.02	8.99	25.57	58.15	74.00	-15.85	PK
V	12010.00	43.21	31.02	8.99	25.57	46.75	54.00	-7.25	AV
H	4804.00	50.71	30.55	5.77	24.66	50.59	74.00	-23.41	PK
H	4804.00	43.41	30.55	5.77	24.66	43.29	54.00	-10.71	AV
H	7206.00	51.96	30.33	6.32	24.55	52.50	74.00	-21.50	PK
H	7206.00	43.75	30.33	6.32	24.55	44.29	54.00	-9.71	AV
H	9608.00	53.70	30.85	7.45	24.69	54.99	74.00	-19.01	PK
H	9608.00	43.55	30.85	7.45	24.69	44.84	54.00	-9.16	AV
H	12010.00	54.75	31.02	8.99	25.57	58.29	74.00	-15.71	PK
H	12010.00	43.91	31.02	8.99	25.57	47.45	54.00	-6.55	AV
Middle Channel:2441MHz									
V	4882.00	51.13	30.55	5.77	24.66	51.01	74.00	-22.99	PK
V	4882.00	43.90	30.55	5.77	24.66	43.78	54.00	-10.22	AV
V	7323.00	50.05	30.33	6.32	24.55	50.59	74.00	-23.41	PK
V	7323.00	43.07	30.33	6.32	24.55	43.61	54.00	-10.39	AV
V	9764.00	52.32	30.85	7.45	24.69	53.61	74.00	-20.39	PK
V	9764.00	43.26	30.85	7.45	24.69	44.55	54.00	-9.45	AV
V	12205.00	51.74	31.02	8.99	25.57	55.28	74.00	-18.72	PK
V	12205.00	43.21	31.02	8.99	25.57	46.75	54.00	-7.25	AV
H	4882.00	53.86	30.55	5.77	24.66	53.74	74.00	-20.26	PK
H	4882.00	43.78	30.55	5.77	24.66	43.66	54.00	-10.34	AV
H	7323.00	51.63	30.33	6.32	24.55	52.17	74.00	-21.83	PK
H	7323.00	43.53	30.33	6.32	24.55	44.07	54.00	-9.93	AV
H	9764.00	50.11	30.85	7.45	24.69	51.40	74.00	-22.60	PK
H	9764.00	43.72	30.85	7.45	24.69	45.01	54.00	-8.99	AV
H	12205.00	50.26	31.02	8.99	25.57	53.80	74.00	-20.20	PK
H	12205.00	43.48	31.02	8.99	25.57	47.02	54.00	-6.98	AV
High Channel:2480MHz									
V	4960.00	52.07	30.55	5.77	24.66	51.95	74.00	-22.05	PK
V	4960.00	43.37	30.55	5.77	24.66	43.25	54.00	-10.75	AV
V	7440.00	53.12	30.33	6.32	24.55	53.66	74.00	-20.34	PK
V	7440.00	43.04	30.33	6.32	24.55	43.58	54.00	-10.42	AV
V	9920.00	51.87	30.85	7.45	24.69	53.16	74.00	-20.84	PK



V	9920.00	43.79	30.85	7.45	24.69	45.08	54.00	-8.92	AV
V	12400.00	50.21	31.02	8.99	25.57	53.75	74.00	-20.25	PK
V	12400.00	43.21	31.02	8.99	25.57	46.75	54.00	-7.25	AV
H	4960.00	50.02	30.55	5.77	24.66	49.90	74.00	-24.10	PK
H	4960.00	43.97	30.55	5.77	24.66	43.85	54.00	-10.15	AV
H	7440.00	51.23	30.33	6.32	24.55	51.77	74.00	-22.23	PK
H	7440.00	43.90	30.33	6.32	24.55	44.44	54.00	-9.56	AV
H	9920.00	53.25	30.85	7.45	24.69	54.54	74.00	-19.46	PK
H	9920.00	43.87	30.85	7.45	24.69	45.16	54.00	-8.84	AV
H	12400.00	52.31	31.02	8.99	25.57	55.85	74.00	-18.15	PK
H	12400.00	43.39	31.02	8.99	25.57	46.93	54.00	-7.07	AV

Remark:

1. Emission Level = Meter Reading + Antenna Factor + Cable Loss – Pre-amplifier, Margin= Emission Level - Limit
2. If peak below the average limit, the average emission was no test.
3. The amplitude of spurious emissions which are attenuated by more than 20dB below the permissible value has no need to be reported.



8-DPSK - 3-DH1

Polar (H/V)	Frequency	Meter Reading	Pre-amplifier	Cable Loss	Antenna Factor	Emission Level	Limits	Margin	Detector Type
	(MHz)	(dBuV)	(dB)	(dB)	(dB)	(dBuV/m)	(dBuV/m)	(dB)	
Low Channel:2402MHz									
V	4804.00	53.19	30.55	5.77	24.66	53.07	74.00	-20.93	PK
V	4804.00	43.17	30.55	5.77	24.66	43.05	54.00	-10.95	AV
V	7206.00	52.85	30.33	6.32	24.55	53.39	74.00	-20.61	PK
V	7206.00	43.69	30.33	6.32	24.55	44.23	54.00	-9.77	AV
V	9608.00	50.04	30.85	7.45	24.69	51.33	74.00	-22.67	PK
V	9608.00	43.93	30.85	7.45	24.69	45.22	54.00	-8.78	AV
V	12010.00	51.51	31.02	8.99	25.57	55.05	74.00	-18.95	PK
V	12010.00	43.80	31.02	8.99	25.57	47.34	54.00	-6.66	AV
H	4804.00	53.64	30.55	5.77	24.66	53.52	74.00	-20.48	PK
H	4804.00	43.92	30.55	5.77	24.66	43.80	54.00	-10.20	AV
H	7206.00	51.75	30.33	6.32	24.55	52.29	74.00	-21.71	PK
H	7206.00	43.01	30.33	6.32	24.55	43.55	54.00	-10.45	AV
H	9608.00	50.46	30.85	7.45	24.69	51.75	74.00	-22.25	PK
H	9608.00	43.60	30.85	7.45	24.69	44.89	54.00	-9.11	AV
H	12010.00	51.95	31.02	8.99	25.57	55.49	74.00	-18.51	PK
H	12010.00	43.82	31.02	8.99	25.57	47.36	54.00	-6.64	AV
Middle Channel:2441MHz									
V	4882.00	51.72	30.55	5.77	24.66	51.60	74.00	-22.40	PK
V	4882.00	43.78	30.55	5.77	24.66	43.66	54.00	-10.34	AV
V	7323.00	54.03	30.33	6.32	24.55	54.57	74.00	-19.43	PK
V	7323.00	43.67	30.33	6.32	24.55	44.21	54.00	-9.79	AV
V	9764.00	54.33	30.85	7.45	24.69	55.62	74.00	-18.38	PK
V	9764.00	43.56	30.85	7.45	24.69	44.85	54.00	-9.15	AV
V	12205.00	52.33	31.02	8.99	25.57	55.87	74.00	-18.13	PK
V	12205.00	43.30	31.02	8.99	25.57	46.84	54.00	-7.16	AV
H	4882.00	51.68	30.55	5.77	24.66	51.56	74.00	-22.44	PK
H	4882.00	43.90	30.55	5.77	24.66	43.78	54.00	-10.22	AV
H	7323.00	53.43	30.33	6.32	24.55	53.97	74.00	-20.03	PK
H	7323.00	43.80	30.33	6.32	24.55	44.34	54.00	-9.66	AV
H	9764.00	53.18	30.85	7.45	24.69	54.47	74.00	-19.53	PK
H	9764.00	43.93	30.85	7.45	24.69	45.22	54.00	-8.78	AV
H	12205.00	54.48	31.02	8.99	25.57	58.02	74.00	-15.98	PK
H	12205.00	43.87	31.02	8.99	25.57	47.41	54.00	-6.59	AV
High Channel:2480MHz									
V	4960.00	50.52	30.55	5.77	24.66	50.40	74.00	-23.60	PK
V	4960.00	43.35	30.55	5.77	24.66	43.23	54.00	-10.77	AV
V	7440.00	53.79	30.33	6.32	24.55	54.33	74.00	-19.67	PK
V	7440.00	43.72	30.33	6.32	24.55	44.26	54.00	-9.74	AV
V	9920.00	50.67	30.85	7.45	24.69	51.96	74.00	-22.04	PK
V	9920.00	43.30	30.85	7.45	24.69	44.59	54.00	-9.41	AV



V	12400.00	51.36	31.02	8.99	25.57	54.90	74.00	-19.10	PK
V	12400.00	43.62	31.02	8.99	25.57	47.16	54.00	-6.84	AV
H	4960.00	51.03	30.55	5.77	24.66	50.91	74.00	-23.09	PK
H	4960.00	43.69	30.55	5.77	24.66	43.57	54.00	-10.43	AV
H	7440.00	51.84	30.33	6.32	24.55	52.38	74.00	-21.62	PK
H	7440.00	43.55	30.33	6.32	24.55	44.09	54.00	-9.91	AV
H	9920.00	54.43	30.85	7.45	24.69	55.72	74.00	-18.28	PK
H	9920.00	43.48	30.85	7.45	24.69	44.77	54.00	-9.23	AV
H	12400.00	50.99	31.02	8.99	25.57	54.53	74.00	-19.47	PK
H	12400.00	43.82	31.02	8.99	25.57	47.36	54.00	-6.64	AV

Remark:

1. Emission Level = Meter Reading + Antenna Factor + Cable Loss – Pre-amplifier,
Margin= Emission Level - Limit
2. If peak below the average limit, the average emission was no test.
3. The amplitude of spurious emissions which are attenuated by more than 20dB below the permissible value has no need to be reported.

**5. RADIATED BAND EMISSION MEASUREMENT****5.1 TEST REQUIREMENT**

Test Requirement:	FCC Part15 C Section 15.209 and 15.205 and 15.247(d)				
Test Method:	ANSI C63.10: 2013				
Test Frequency Range:	All of the restrict bands were tested, only the worst band's (2310MHz to 2500MHz) data was showed.				
Test site:	Measurement Distance: 3m				
Receiver setup:	Frequency	Detector	RBW	VBW	Value
	Above 1GHz	Peak	1MHz	3MHz	Peak
		Average	1MHz	3MHz	Average

LIMITS OF RADIATED EMISSION MEASUREMENT (Above 1000MHz)

Frequency (MHz)	Limit (dBuV/m) (at 3M)	
	Peak	Average
Above 1000	74	54

Notes:

- (1) The limit for radiated test was performed according to FCC PART 15C.
- (2) The tighter limit applies at the band edges.
- (3) Emission level (dBuV/m)=20log Emission level (uV/m).

Spectrum Parameter	Setting
Attenuation	Auto
Start Frequency	2310MHz
Stop Frequency	2500MHz
RB / VB (emission in restricted band)	1 MHz / 3 MHz for Peak, 1 MHz / 3MHz for Average

5.2 TEST PROCEDURE

Above 1GHz test procedure as below:

- a. 1. The EUT was placed on the top of a rotating table 0.8meters above the ground at a 3 meter camber. The table was rotated 360 degrees to determine the position of the highest radiation.
- b. The EUT was set 3 meters away from the interference-receiving antenna, which was mounted on the top of a variable-height antenna tower.
- c. The antenna height is varied from one meter to four meters above the ground to determine the maximum value of the field strength. Both horizontal and vertical polarizations of the antenna are set to make the measurement.
- d. For each suspected emission, the EUT was arranged to its worst case and then the antenna was tuned to heights from 1 meter to 4 meters and the rota table was turned from 0 degrees to 360 degrees to find the maximum reading.
- e. The test-receiver system was set to Peak Detect Function and Specified Bandwidth with Maximum Hold Mode.
- f. If the emission level of the EUT in peak mode was 10dB lower than the limit specified, then testing could be stopped and the peak values of the EUT would be reported. Otherwise the emissions that did not have 10dB margin would be re-tested one by one using peak, quasi-peak or average method as specified and then reported in a data sheet.
- g. Test the EUT in the lowest channel,the Highest channel

Note:



Both horizontal and vertical antenna polarities were tested and performed pretest to three orthogonal axis. The worst case emissions were reported

5.3 DEVIATION FROM TEST STANDARD

No deviation

5.4 TEST SETUP

Radiated Emission Test-Up Frequency Above 1GHz

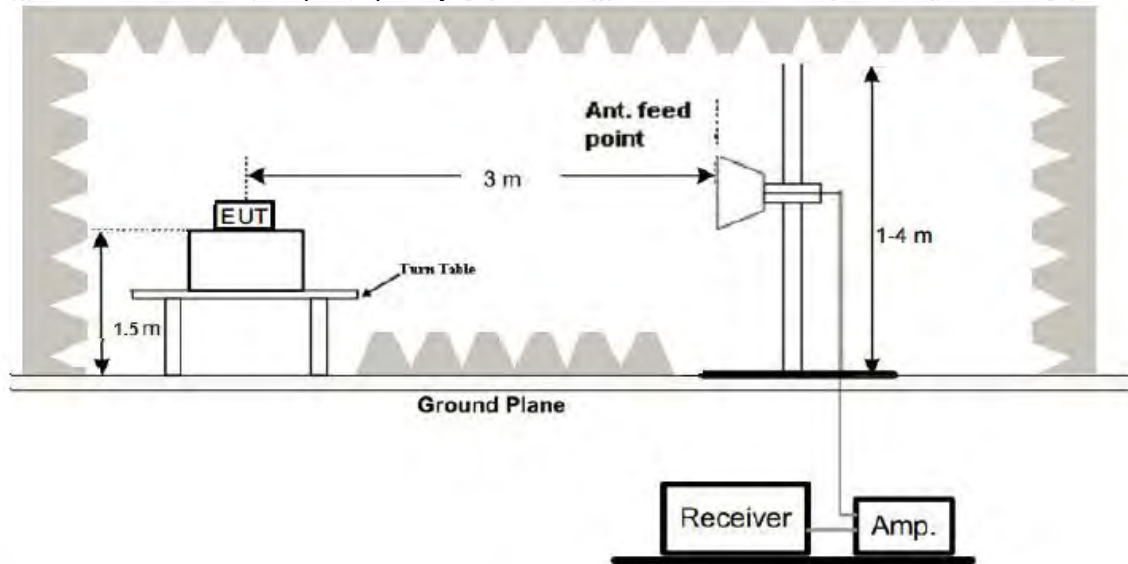

5.5 EUT OPERATING CONDITIONS

The EUT was configured for testing in a typical fashion (as a customer would normally use it). The EUT has been programmed to continuously transmit during test. This operating condition was tested and used to collect the included data.



5.6 TEST RESULT

	Polar (H/V)	Frequency (MHz)	Meter Reading (dBUV)	Pre-amplifier (dB)	Cable Loss (dB)	Antenna Factor (dB/m)	Emission level (dBUV/m)	Limit (dBUV/m)	Margin (dB)	Detect or Type	Result
GFSK 1-DH1	Low Channel: 2402MHz										
	H	2310.00	53.51	30.22	4.85	23.98	52.12	74.00	-21.88	PK	PASS
	H	2310.00	44.24	30.22	4.85	23.98	42.85	54.00	-11.15	AV	PASS
	H	2350.00	53.18	30.22	4.85	23.98	51.79	74.00	-22.21	PK	PASS
	H	2350.00	44.60	30.22	4.85	23.98	43.21	54.00	-10.79	AV	PASS
	H	2390.00	53.52	30.22	4.85	23.98	52.13	74.00	-21.87	PK	PASS
	H	2390.00	44.57	30.22	4.85	23.98	43.18	54.00	-10.82	AV	PASS
	V	2310.00	53.73	30.22	4.85	23.98	52.34	74.00	-21.66	PK	PASS
	V	2310.00	44.39	30.22	4.85	23.98	43.00	54.00	-11.00	AV	PASS
	V	2350.00	53.98	30.22	4.85	23.98	52.59	74.00	-21.41	PK	PASS
	V	2350.00	44.83	30.22	4.85	23.98	43.44	54.00	-10.56	AV	PASS
	V	2390.00	53.22	30.22	4.85	23.98	51.83	74.00	-22.17	PK	PASS
	V	2390.00	44.59	30.22	4.85	23.98	43.20	54.00	-10.80	AV	PASS
	High Channel: 2480MHz										
	H	2483.50	53.02	30.22	4.85	23.98	51.63	74.00	-22.37	PK	PASS
	H	2483.50	44.46	30.22	4.85	23.98	43.07	54.00	-10.93	AV	PASS
	H	2490.00	54.88	30.22	4.85	23.98	53.49	74.00	-20.51	PK	PASS
	H	2490.00	44.19	30.22	4.85	23.98	42.80	54.00	-11.20	AV	PASS
	H	2500.00	54.18	30.22	4.85	23.98	52.79	74.00	-21.21	PK	PASS
	H	2500.00	44.10	30.22	4.85	23.98	42.71	54.00	-11.29	AV	PASS
	V	2483.50	53.93	30.22	4.85	23.98	52.54	74.00	-21.46	PK	PASS
	V	2483.50	44.50	30.22	4.85	23.98	43.11	54.00	-10.89	AV	PASS
	V	2490.00	53.00	30.22	4.85	23.98	51.61	74.00	-22.39	PK	PASS
	V	2490.00	44.52	30.22	4.85	23.98	43.13	54.00	-10.87	AV	PASS
V	2500.00	54.99	30.22	4.85	23.98	53.60	74.00	-20.40	PK	PASS	
V	2500.00	44.43	30.22	4.85	23.98	43.04	54.00	-10.96	AV	PASS	

Remark:

1. Emission Level = Meter Reading + Antenna Factor + Cable Loss – Pre-amplifier, Margin= Emission Level - Limit



	Polar (H/V)	Frequency (MHz)	Meter Reading (dBuV)	Pre-amplifier (dB)	Cable Loss (dB)	Antenna Factor (dB/m)	Emission level (dBuV/m)	Limit (dBuV/m)	Margin (dB)	Detect or Type	Result	
π/4-DQ PSK 2-DH1	Low Channel: 2402MHz											
	H	2310.00	53.98	30.22	4.85	23.98	52.59	74.00	-21.41	PK	PASS	
	H	2310.00	44.16	30.22	4.85	23.98	42.77	54.00	-11.23	AV	PASS	
	H	2350.00	54.96	30.22	4.85	23.98	53.57	74.00	-20.43	PK	PASS	
	H	2350.00	44.40	30.22	4.85	23.98	43.01	54.00	-10.99	AV	PASS	
	H	2390.00	53.42	30.22	4.85	23.98	52.03	74.00	-21.97	PK	PASS	
	H	2390.00	44.67	30.22	4.85	23.98	43.28	54.00	-10.72	AV	PASS	
	V	2310.00	54.78	30.22	4.85	23.98	53.39	74.00	-20.61	PK	PASS	
	V	2310.00	44.89	30.22	4.85	23.98	43.50	54.00	-10.50	AV	PASS	
	V	2350.00	53.46	30.22	4.85	23.98	52.07	74.00	-21.93	PK	PASS	
	V	2350.00	44.55	30.22	4.85	23.98	43.16	54.00	-10.84	AV	PASS	
	V	2390.00	54.42	30.22	4.85	23.98	53.03	74.00	-20.97	PK	PASS	
	V	2390.00	44.86	30.22	4.85	23.98	43.47	54.00	-10.53	AV	PASS	
	High Channel: 2480MHz											
	H	2483.50	54.74	30.22	4.85	23.98	53.35	74.00	-20.65	PK	PASS	
	H	2483.50	44.41	30.22	4.85	23.98	43.02	54.00	-10.98	AV	PASS	
	H	2490.00	54.07	30.22	4.85	23.98	52.68	74.00	-21.32	PK	PASS	
	H	2490.00	44.63	30.22	4.85	23.98	43.24	54.00	-10.76	AV	PASS	
	H	2500.00	54.66	30.22	4.85	23.98	53.27	74.00	-20.73	PK	PASS	
	H	2500.00	44.77	30.22	4.85	23.98	43.38	54.00	-10.62	AV	PASS	
	V	2483.50	54.99	30.22	4.85	23.98	53.60	74.00	-20.40	PK	PASS	
	V	2483.50	44.35	30.22	4.85	23.98	42.96	54.00	-11.04	AV	PASS	
V	2490.00	54.64	30.22	4.85	23.98	53.25	74.00	-20.75	PK	PASS		
V	2490.00	44.56	30.22	4.85	23.98	43.17	54.00	-10.83	AV	PASS		
V	2500.00	53.43	30.22	4.85	23.98	52.04	74.00	-21.96	PK	PASS		
V	2500.00	44.49	30.22	4.85	23.98	43.10	54.00	-10.90	AV	PASS		

Remark:

1. Emission Level = Meter Reading + Antenna Factor + Cable Loss – Pre-amplifier, Margin= Emission Level - Limit



	Polar (H/V)	Frequency (MHz)	Meter Reading (dBuV)	Pre-amplifier (dB)	Cable Loss (dB)	Antenna Factor (dB/m)	Emission level (dBuV/m)	Limit (dBuV/m)	Margin (dB)	Detect or Type	Result
8-DPSK 3-DH1	Low Channel: 2402MHz										
	H	2310.00	53.90	30.22	4.85	23.98	52.51	74.00	-21.49	PK	PASS
	H	2310.00	44.44	30.22	4.85	23.98	43.05	54.00	-10.95	AV	PASS
	H	2350.00	53.99	30.22	4.85	23.98	52.60	74.00	-21.40	PK	PASS
	H	2350.00	44.49	30.22	4.85	23.98	43.10	54.00	-10.90	AV	PASS
	H	2390.00	53.56	30.22	4.85	23.98	52.17	74.00	-21.83	PK	PASS
	H	2390.00	44.63	30.22	4.85	23.98	43.24	54.00	-10.76	AV	PASS
	V	2310.00	53.83	30.22	4.85	23.98	52.44	74.00	-21.56	PK	PASS
	V	2310.00	44.52	30.22	4.85	23.98	43.13	54.00	-10.87	AV	PASS
	V	2350.00	54.72	30.22	4.85	23.98	53.33	74.00	-20.67	PK	PASS
	V	2350.00	44.71	30.22	4.85	23.98	43.32	54.00	-10.68	AV	PASS
	V	2390.00	54.77	30.22	4.85	23.98	53.38	74.00	-20.62	PK	PASS
	V	2390.00	44.33	30.22	4.85	23.98	42.94	54.00	-11.06	AV	PASS
	High Channel: 2480MHz										
	H	2483.50	54.51	30.22	4.85	23.98	53.12	74.00	-20.88	PK	PASS
	H	2483.50	44.50	30.22	4.85	23.98	43.11	54.00	-10.89	AV	PASS
	H	2490.00	53.31	30.22	4.85	23.98	51.92	74.00	-22.08	PK	PASS
	H	2490.00	44.73	30.22	4.85	23.98	43.34	54.00	-10.66	AV	PASS
	H	2500.00	53.36	30.22	4.85	23.98	51.97	74.00	-22.03	PK	PASS
	H	2500.00	44.86	30.22	4.85	23.98	43.47	54.00	-10.53	AV	PASS
	V	2483.50	54.93	30.22	4.85	23.98	53.54	74.00	-20.46	PK	PASS
	V	2483.50	44.75	30.22	4.85	23.98	43.36	54.00	-10.64	AV	PASS
V	2490.00	54.37	30.22	4.85	23.98	52.98	74.00	-21.02	PK	PASS	
V	2490.00	44.55	30.22	4.85	23.98	43.16	54.00	-10.84	AV	PASS	
V	2500.00	53.21	30.22	4.85	23.98	51.82	74.00	-22.18	PK	PASS	
V	2500.00	44.77	30.22	4.85	23.98	43.38	54.00	-10.62	AV	PASS	

Remark:

1. Emission Level = Meter Reading + Antenna Factor + Cable Loss – Pre-amplifier, Margin= Emission Level - Limit



6. CONDUCTED BAND EDGE AND SPURIOUS EMISSION

Test Requirement:	FCC Part15 C Section 15.247 (d)
Test Method:	KDB558074 D0115.247 Meas Guidanceev05r02

6.1 LIMIT

Typical regulatory requirements specify that in any 100 kHz bandwidth outside of the authorized frequency band, the power shall be attenuated according to the following conditions:

The maximum peak conducted output power procedure was used to determine compliance as described in 11.9.1, then the peak output power measured in any 100 kHz bandwidth outside of the authorized frequency band shall be attenuated by at least 20 dB relative to the maximum in-band peak PSD level in 100 kHz (i.e., 20 dBc).

6.2 TEST SETUP

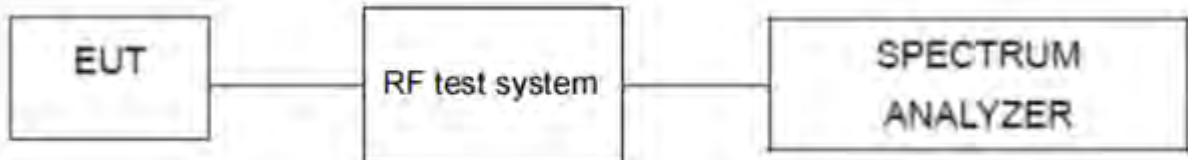

6.3 TEST PROCEDURE

A. Reference level measurement, establish a reference level by using the following procedure:

- Set instrument center frequency to FHSS channel center frequency.
- Set the span to ≥ 1.5 times the 20dB bandwidth.
- Set the RBW = 100 kHz.
- Set the VBW $\geq [3 \times \text{RBW}]$.
- Detector = peak.
- Sweep time = auto couple.
- Trace mode = max hold.
- Allow trace to fully stabilize.
- Use the peak marker function to determine the maximum PSD level.

Note that the channel found to contain the maximum PSD level can be used to establish the reference level.

B. Emission level measurement, establish an emission level by using the following procedure:

- Set the center frequency and span to encompass frequency range to be measured.
- Set the RBW = 100 kHz.
- Set the VBW $\geq [3 \times \text{RBW}]$.
- Detector = peak.
- Sweep time = auto couple.
- Trace mode = max hold.
- Allow trace to fully stabilize.
- Use the peak marker function to determine the maximum amplitude level.

Ensure that the amplitude of all unwanted emissions outside of the authorized frequency band (excluding restricted frequency bands) is attenuated by at least the minimum requirements specified in 11.11. Report the three highest emissions relative to the limit.

6.4 DEVIATION FROM STANDARD

No deviation.



6.5 TEST RESULT

GFSK - 1-DH1
Lowest channel

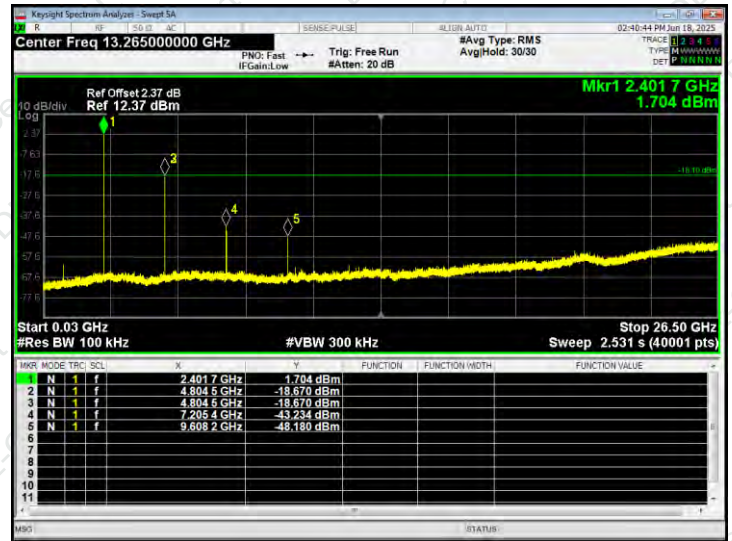

Middle channel

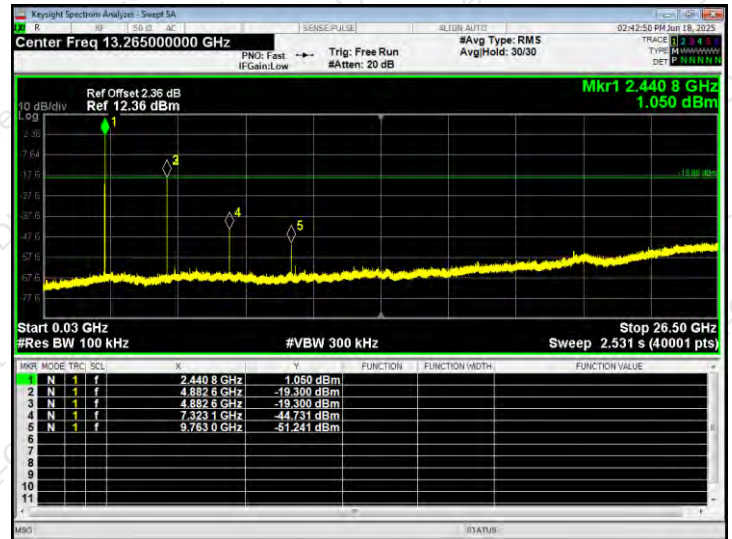

Highest channel

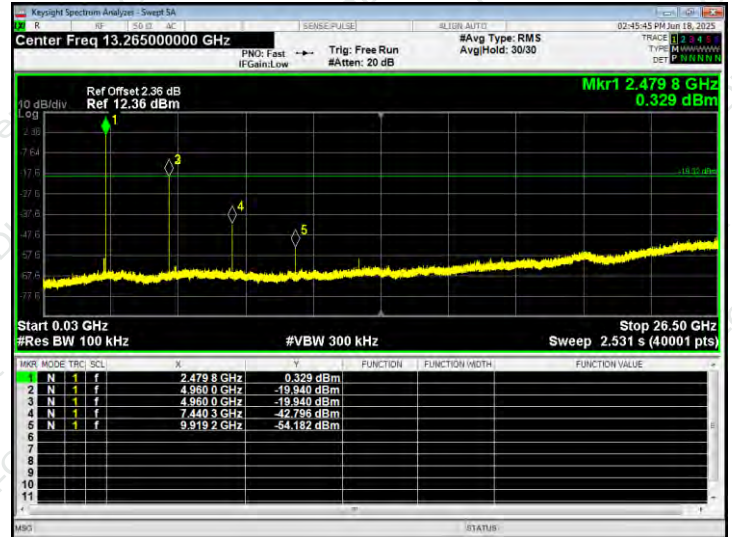

30MHz~26.5GHz



$\pi/4$ -DQPSK - 2-DH1
Lowest channel

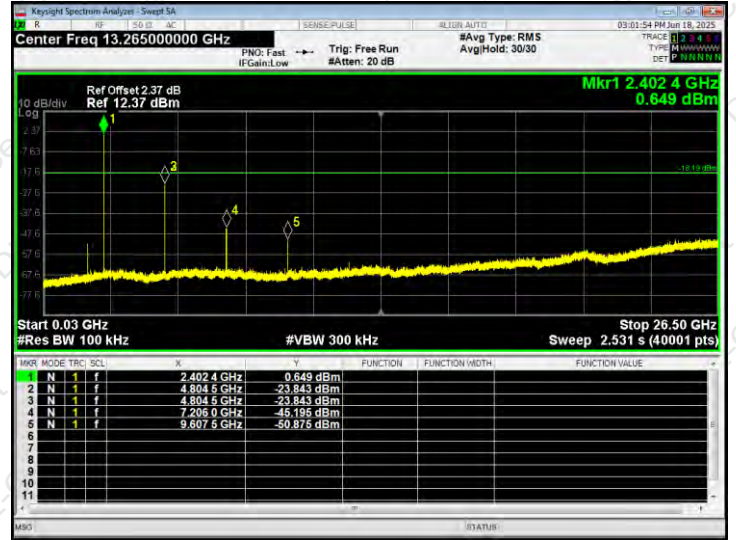

Middle channel

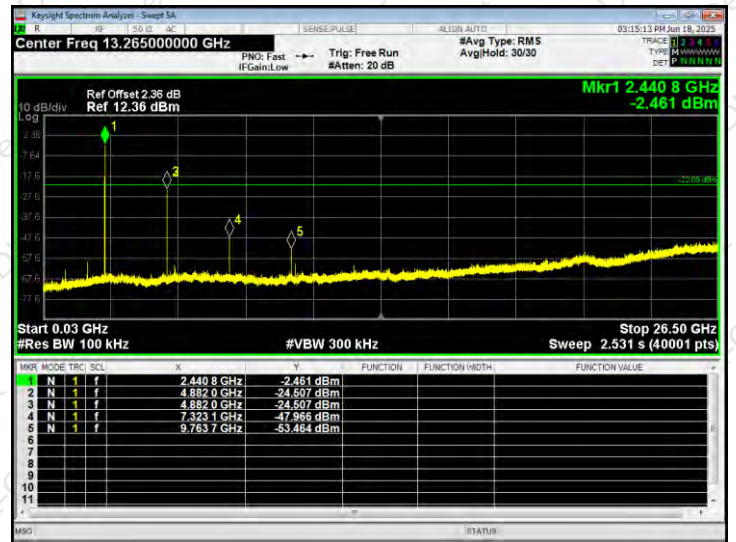

Highest channel

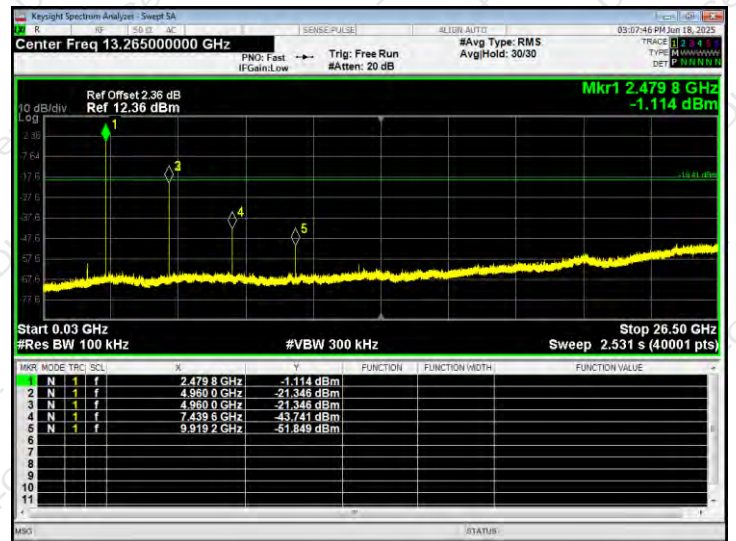

30MHz~26.5GHz



8-DPSK - 3-DH1

Lowest channel

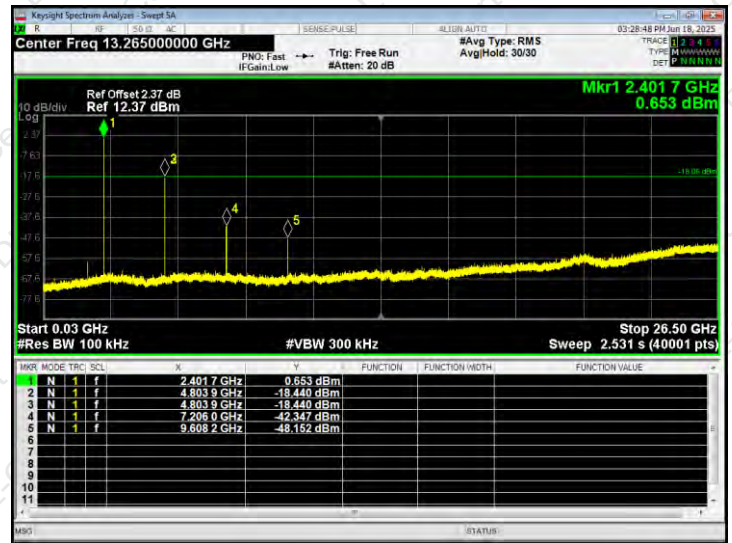

Middle channel

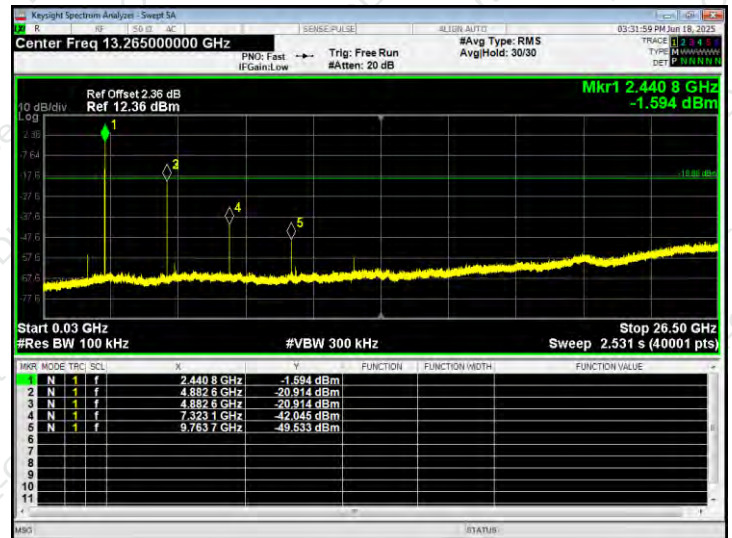

Highest channel

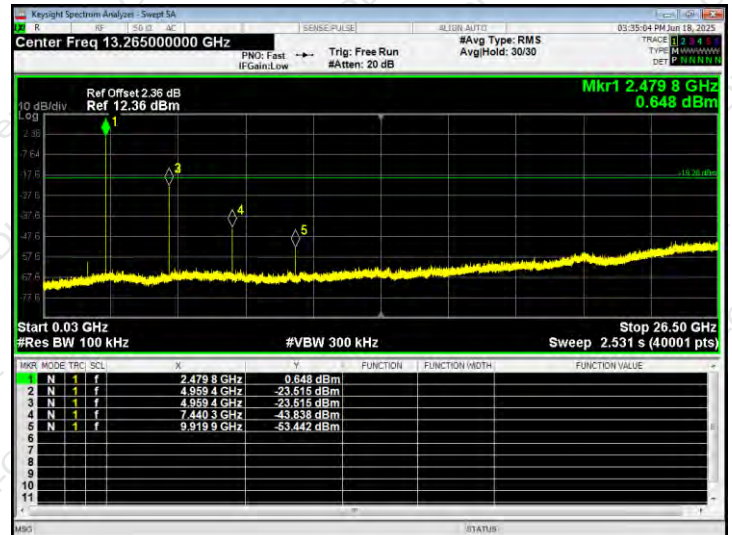

30MHz~26.5GHz



GFSK - 1-DH1

No-hopping Band edge-left side

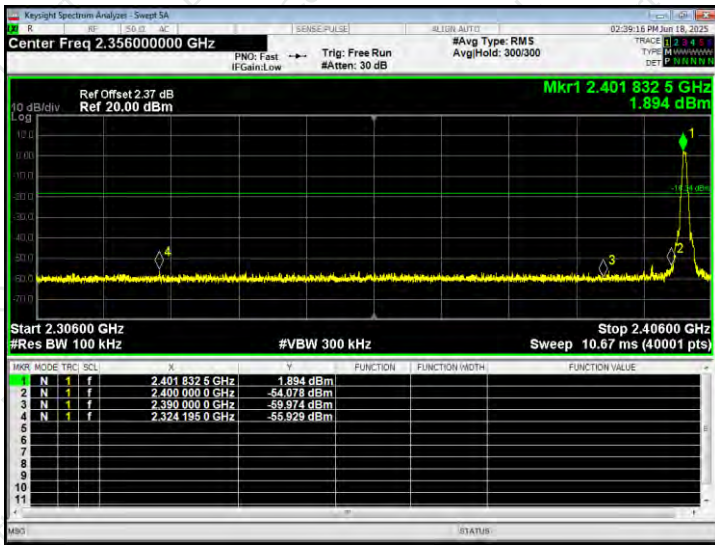

No-hopping Band edge-right side

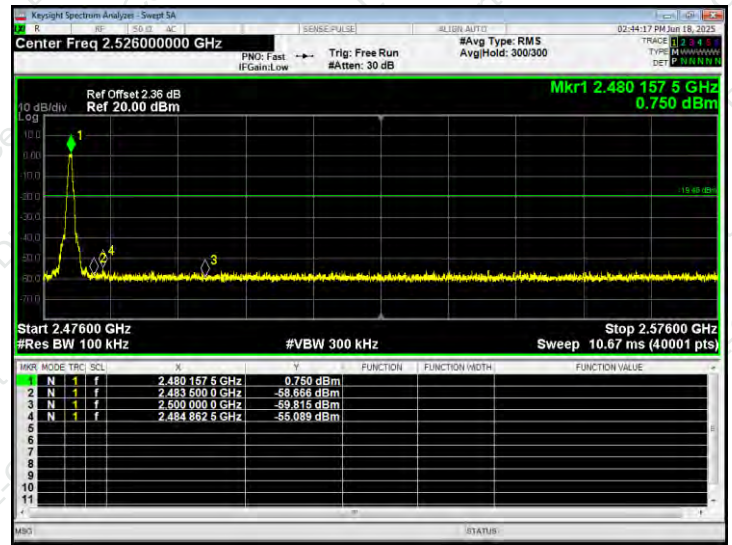

Hopping Band edge-left side

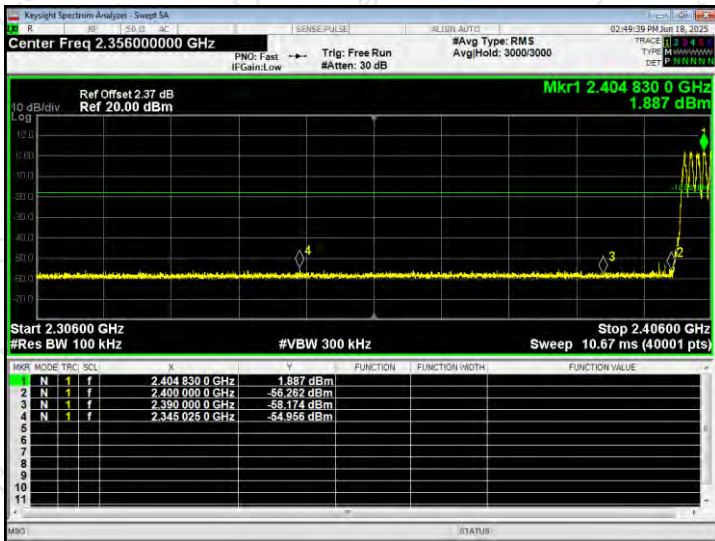

Hopping Band edge-right side

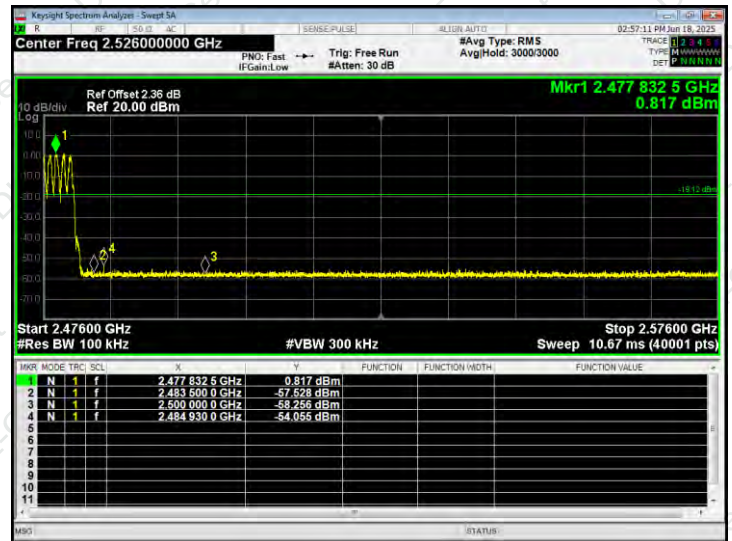



$\pi/4$ -DQPSK - 2-DH1

No-hopping Band edge-left side

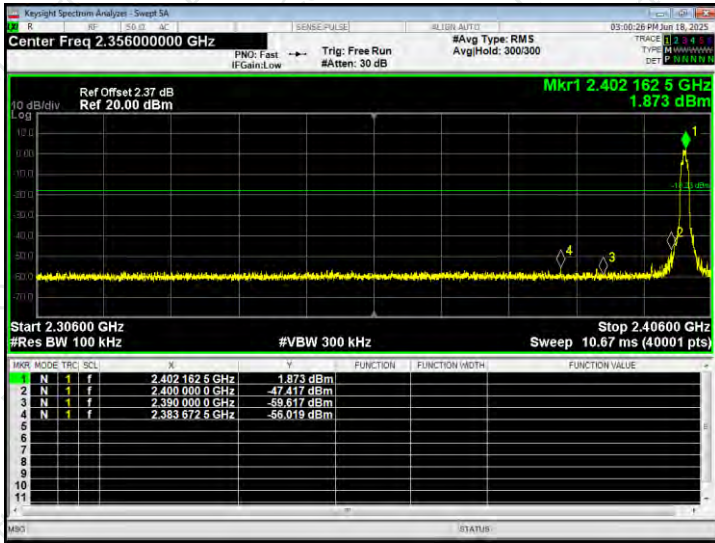

No-hopping Band edge-right side

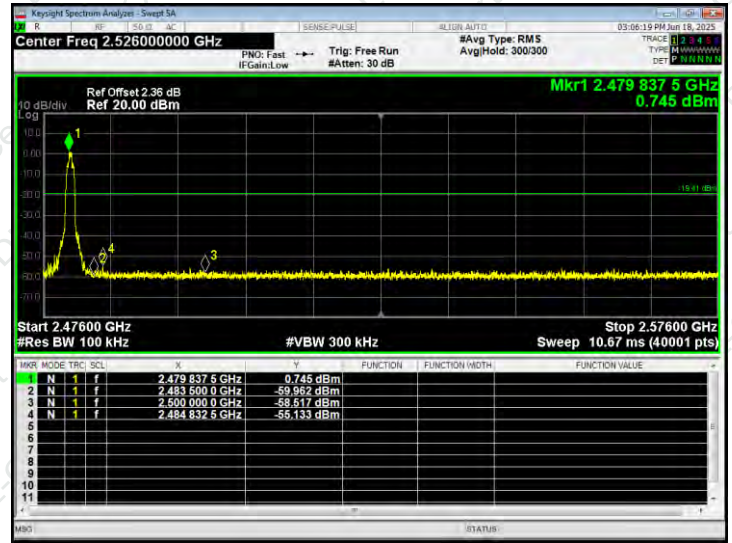

Hopping Band edge-left side

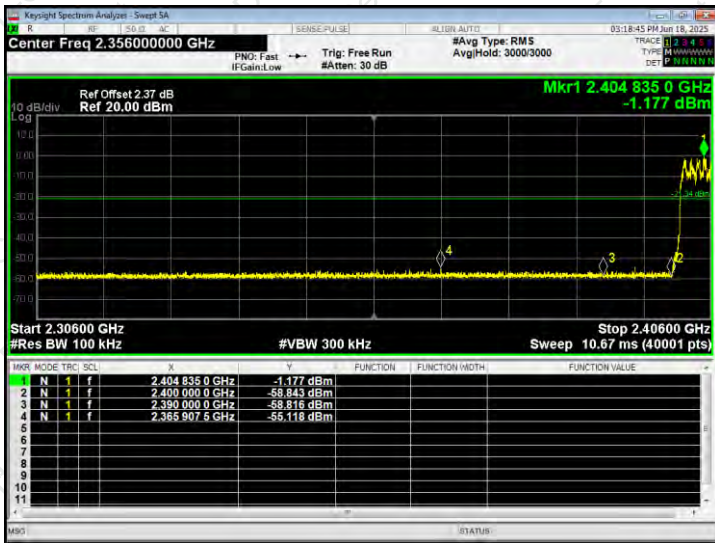

Hopping Band edge-right side

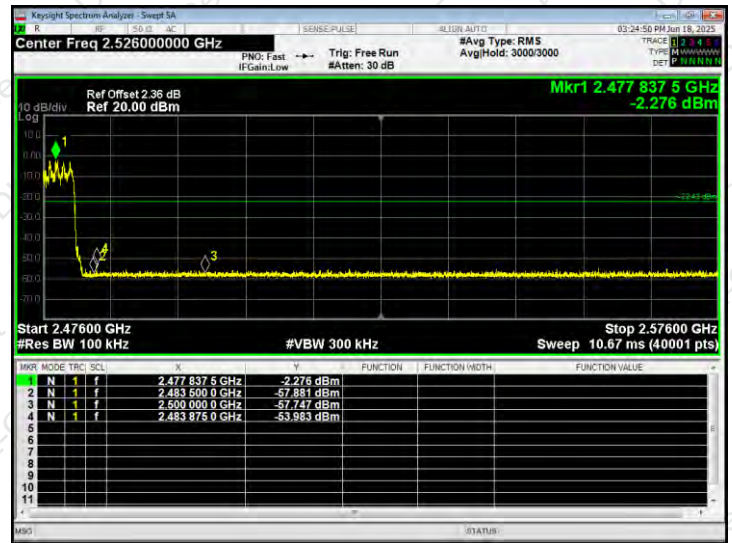



8-DPSK - 3-DH1

No-hopping Band edge-left side

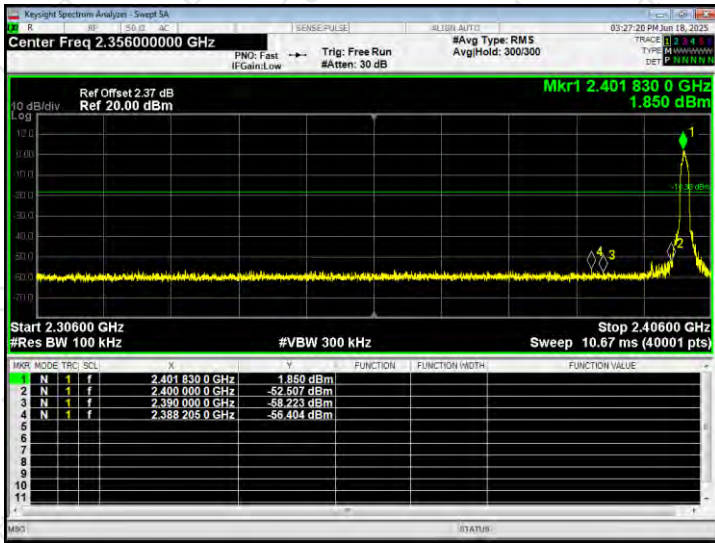

No-hopping Band edge-right side

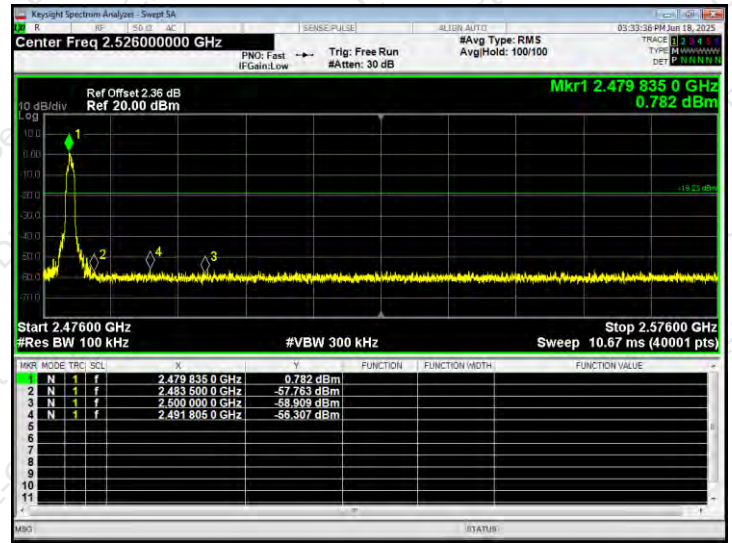

Hopping Band edge-left side

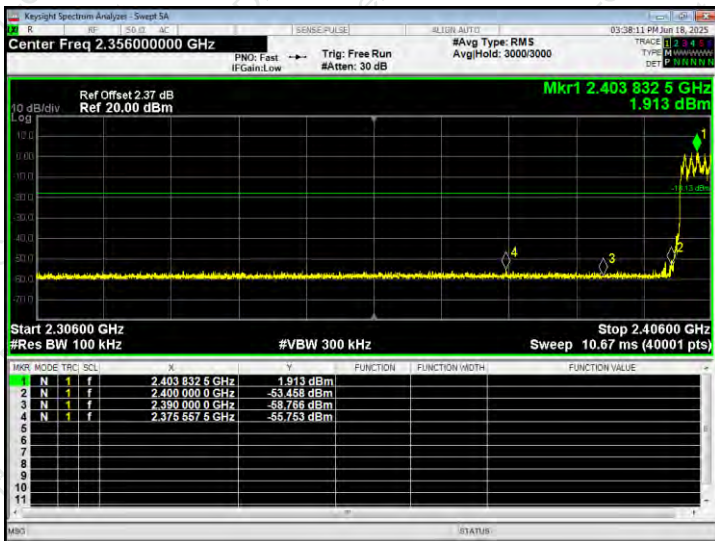

Hopping Band edge-right side

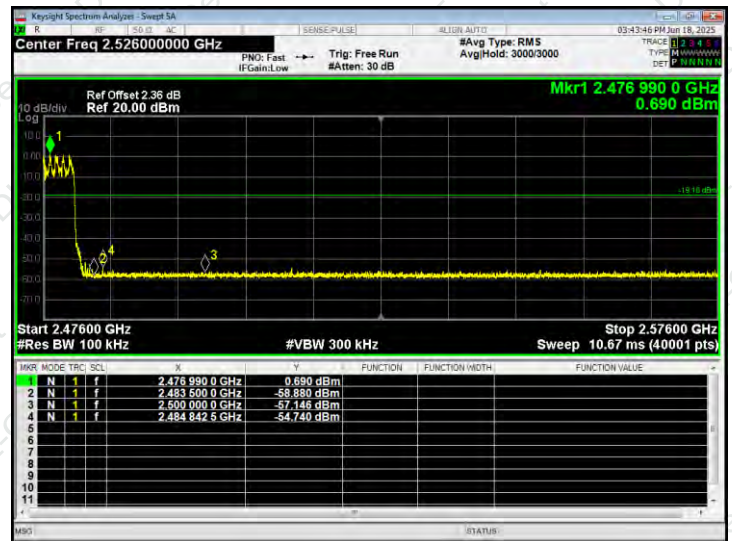



7. 20DB OCCUPIED BANDWIDTH

Test Requirement:	FCC Part15 C Section 15.247 (a)(1)
Test Method:	ANSI C63.10:2013

7.1 TEST SETUP

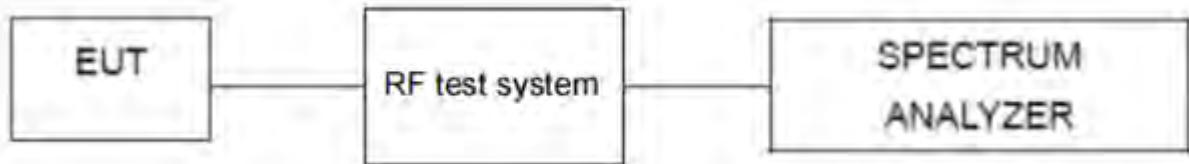

7.2 LIMIT

N/A

7.3 TEST PROCEDURE

1. Set RBW = 30 kHz.
2. Set the video bandwidth (VBW) $\geq 3 \times$ RBW.
3. Detector = Peak.
4. Trace mode = max hold.
5. Sweep = auto couple.
6. Allow the trace to stabilize.
7. Measure the maximum width of the emission that is constrained by the frequencies associated with the two outermost amplitude points (upper and lower frequencies) that are attenuated by 20 dB relative to the maximum level measured in the fundamental emission.

7.4 DEVIATION FROM STANDARD

No deviation.



7.5 TEST RESULT

Modulation	Packet	Test Channel	20dB Occupied Bandwidth (MHz)	Result
GFSK	1-DH1	Lowest	0.9211	Pass
		Middle	0.9213	
		Highest	0.9212	
$\pi/4$ -DQPSK	2-DH1	Lowest	1.247	Pass
		Middle	1.244	
		Highest	1.243	
8-DPSK	3-DH1	Lowest	1.209	Pass
		Middle	1.209	
		Highest	1.208	



GFSK - 1-DH1 Test plots

Low Channel



Middle Channel

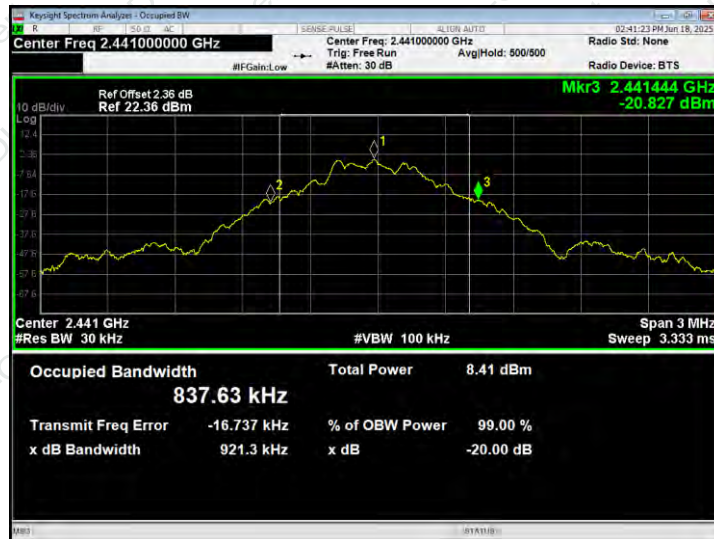

High Channel

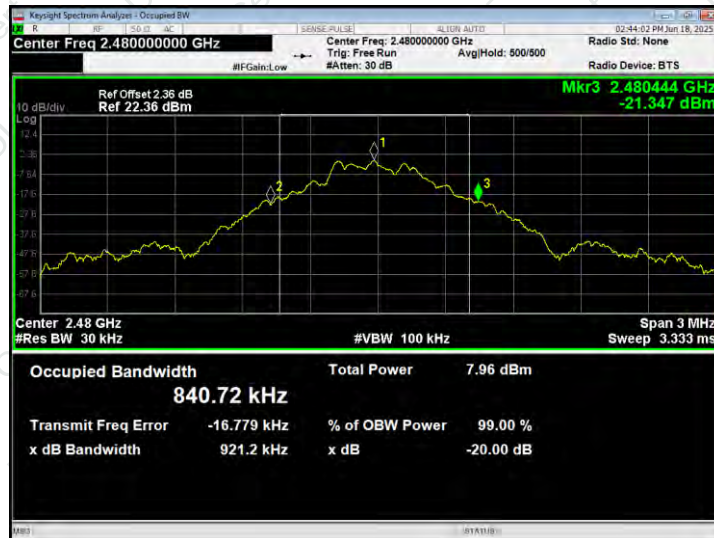



$\pi/4$ -DQPSK - 2-DH1 Test plots

Low Channel



Middle Channel



High Channel

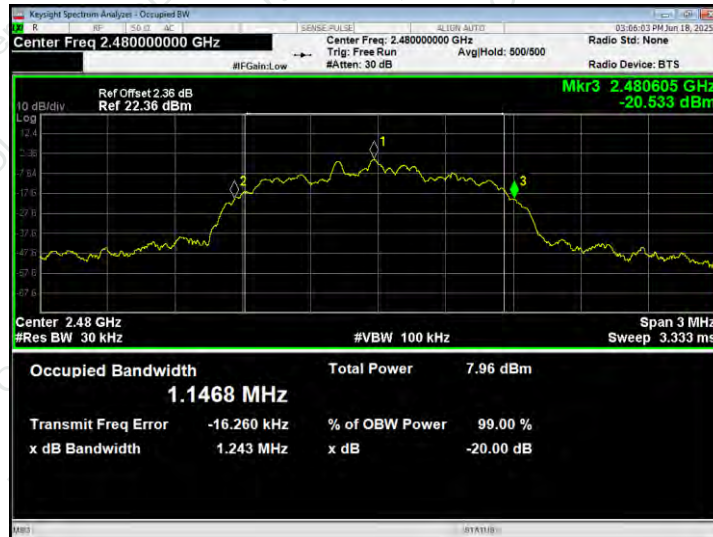



8-DPSK - 3-DH1 Test plots

Low Channel



Middle Channel



High Channel





8. MAXIMUM PEAK OUTPUT POWER

Test Requirement:	FCC Part15 C Section 15.247 (b)(1)
Test Method:	ANSI C63.10:2013
Limit:	GFSK: 30dBm $\pi/4$ -DQPSK & 8-DPSK: 20.97dBm

8.1 BLOCK DIAGRAM OF TEST SETUP

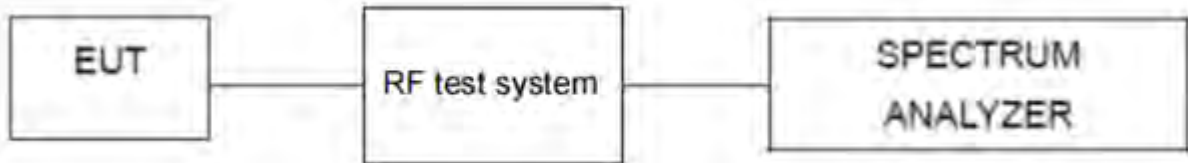

8.2 LIMIT

For frequency hopping systems operating in the 2400-2483.5 MHz band employing at least 75 non-overlapping hopping channels, and all frequency hopping systems in the 5725-5850 MHz band: 1 watt.
For all other frequency hopping systems in the 2400-2483.5 MHz band: 0.125 watts.

8.3 TEST PROCEDURE

1. Remove the antenna from the EUT and then connect a low RF cable from the antenna port to the spectrum.
2. Set the spectrum analyzer: RBW = 2MHz. VBW = 6MHz. Sweep = auto; Detector Function = peak.
3. Keep the EUT in transmitting at lowest, medium and highest channel individually. Record the max value.

8.4 DEVIATION FROM STANDARD

No deviation.



8.5 TEST RESULT

Modulation	Packet	Test channel	Peak output power (dBm)	Limit (dBm)	Result
GFSK	1-DH1	Lowest	2.111	30.00	Pass
		Middle	1.435		
		Highest	1.171		
$\pi/4$ -DQPSK	2-DH1	Lowest	2.798	21.00	Pass
		Middle	2.094		
		Highest	1.645		
8-DPSK	3-DH1	Lowest	3.558	21.00	Pass
		Middle	2.851		
		Highest	2.412		



GFSK - 1-DH1 Test plots

Low Channel

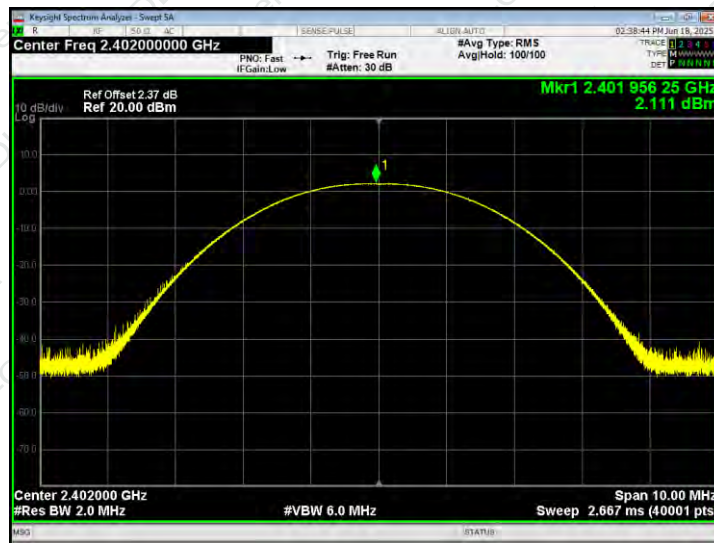

Middle Channel

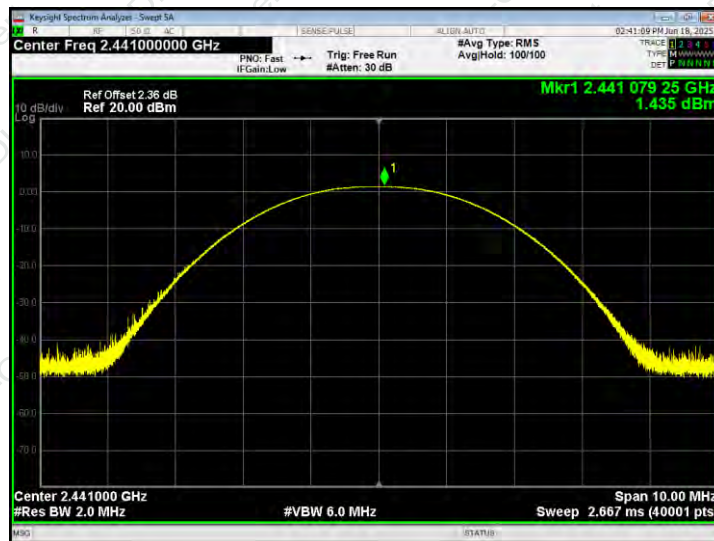

High Channel

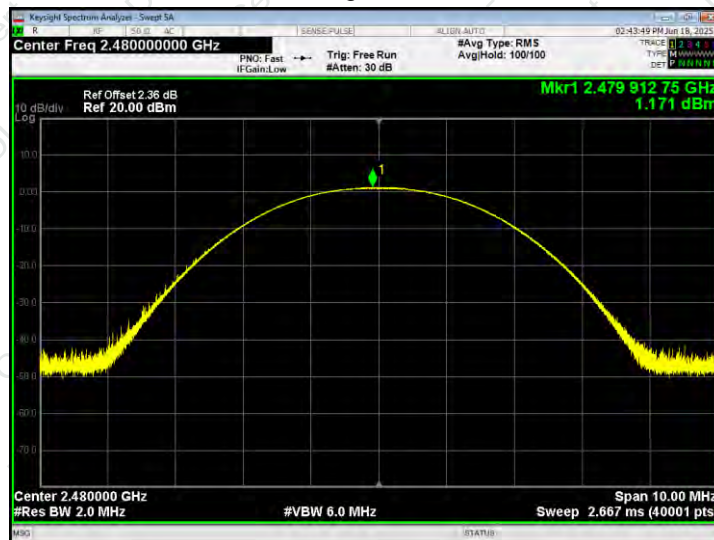



$\pi/4$ -DQPSK - 2-DH1 Test plots

Low Channel

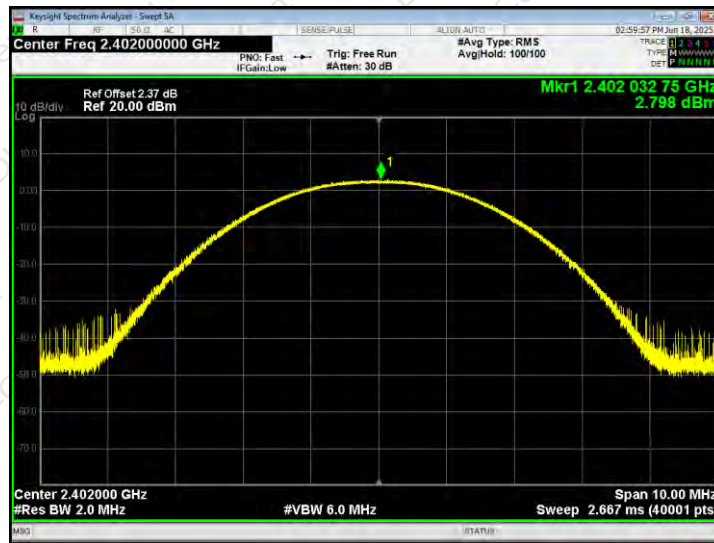

Middle Channel

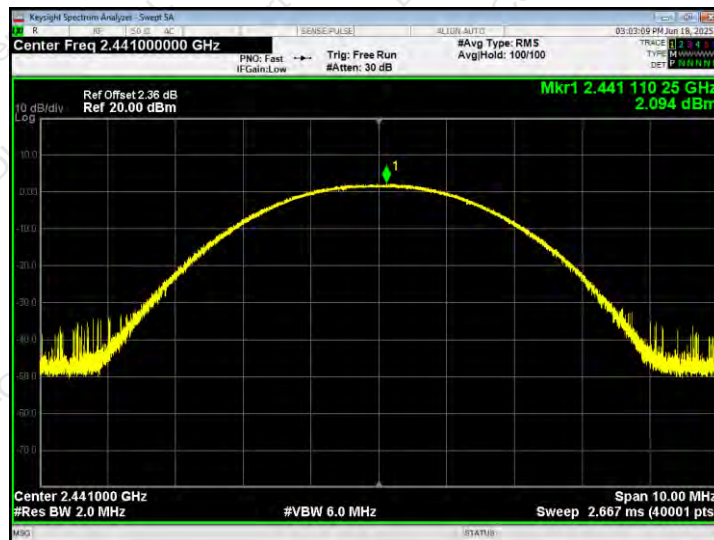

High Channel

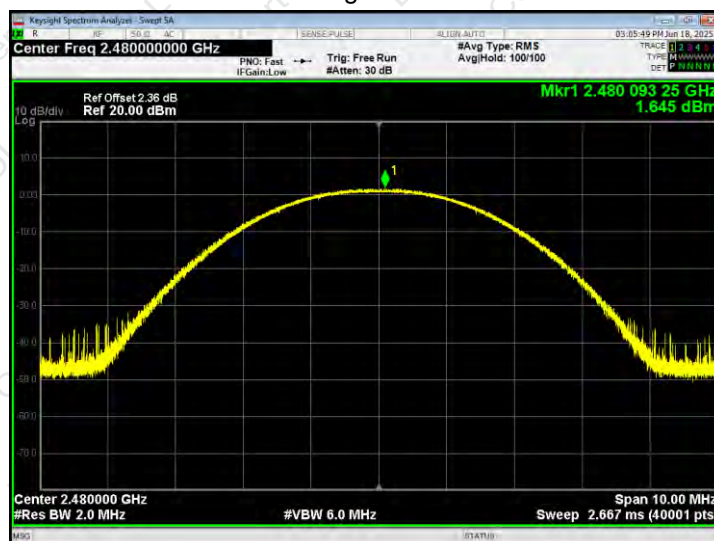



8-DPSK - 3-DH1 Test plots

Low Channel

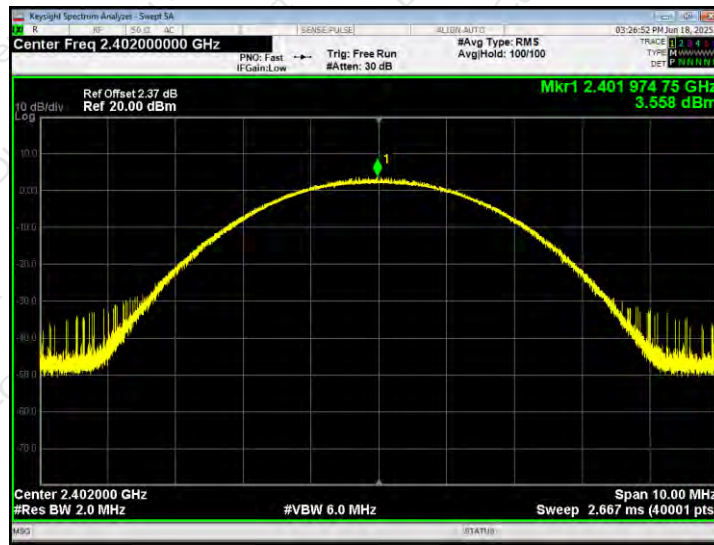

Middle Channel

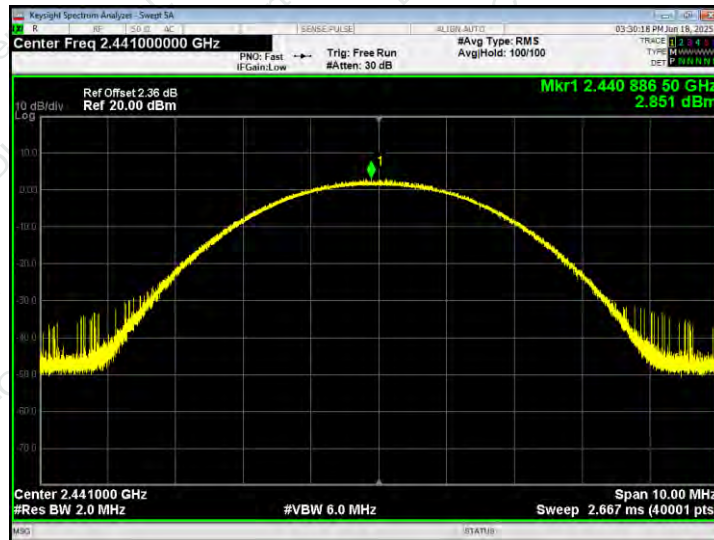

High Channel

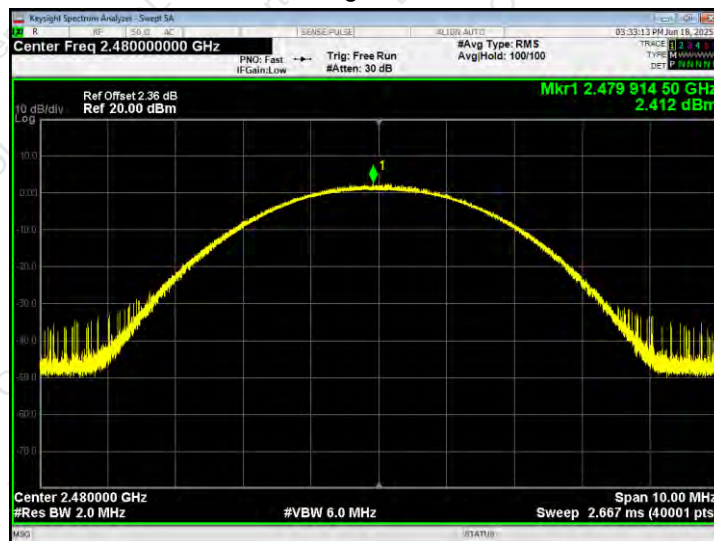



9. HOPPING CHANNEL SEPARATION

Test Requirement:	FCC Part15 C Section 15.247 (a)(1)
Test Method:	ANSI C63.10:2013
Receiver setup:	RBW=30kHz, VBW=100kHz, detector=peak
Limit:	GFSK: 20dB Bandwidth $\pi/4$ -DQPSK & 8DSK: 0.025MHz or 2/3 of the 20dB Bandwidth (whichever is greater)

9.1 TEST SETUP

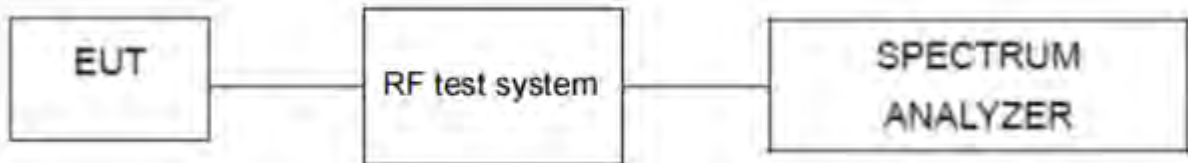

9.2 TEST PROCEDURE

1. Remove the antenna from the EUT and then connect a low RF cable from the antenna port to the spectrum.
2. Set the spectrum analyzer: RBW = 30kHz. VBW = 100kHz , Span = 3.0MHz. Sweep = auto;
Detector Function = Peak; Trace = Max hold.
3. Allow the trace to stabilize. Use the marker-delta function to determine the separation between the peaks of the adjacent channels. The limit is specified in one of the subparagraphs of this Section Submit this plot.

9.3 DEVIATION FROM STANDARD

No deviation.



9.4 TEST RESULT

Modulation	Packet	Test Channel	Separation (MHz)	Limit (MHz)	Result
GFSK	1-DH1	Low	1.152	0.9211	PASS
		Middle	0.996	0.9213	PASS
		High	0.999	0.9212	PASS
$\pi/4$ -DQPSK	2-DH1	Low	0.981	0.8313	PASS
		Middle	1.158	0.8293	PASS
		High	0.996	0.8287	PASS
8-DPSK	3-DH1	Low	1.170	0.8060	PASS
		Middle	0.999	0.8060	PASS
		High	1.011	0.8053	PASS



GFSK - 1-DH1 Test plots

Low Channel



Middle Channel

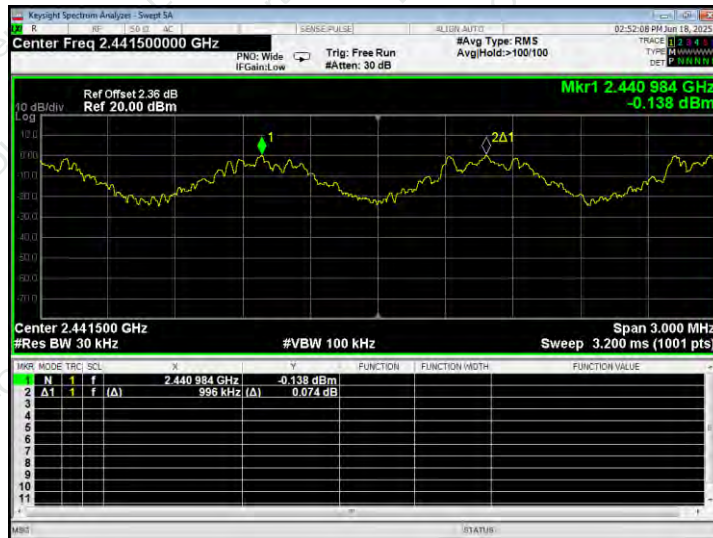

High Channel





$\pi/4$ -DQPSK - 2-DH1 Test plots

Low Channel

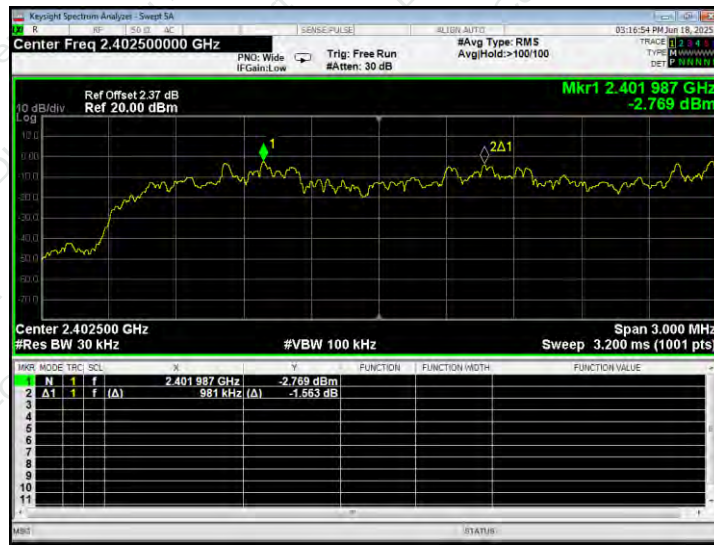

Middle Channel

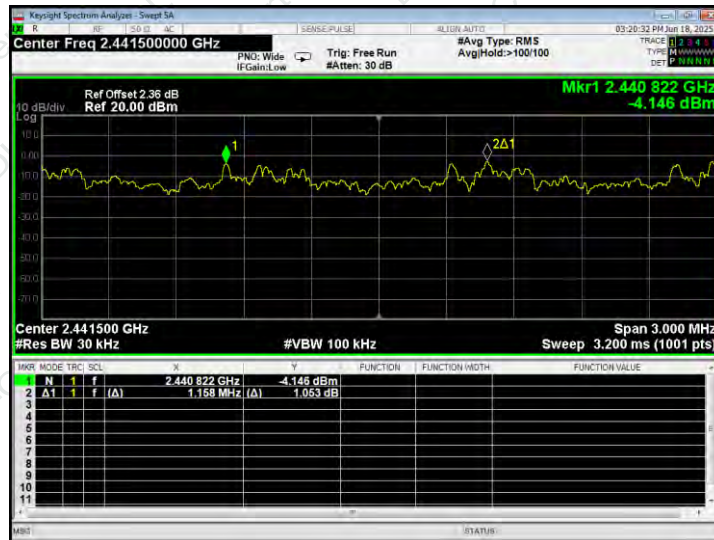

High Channel

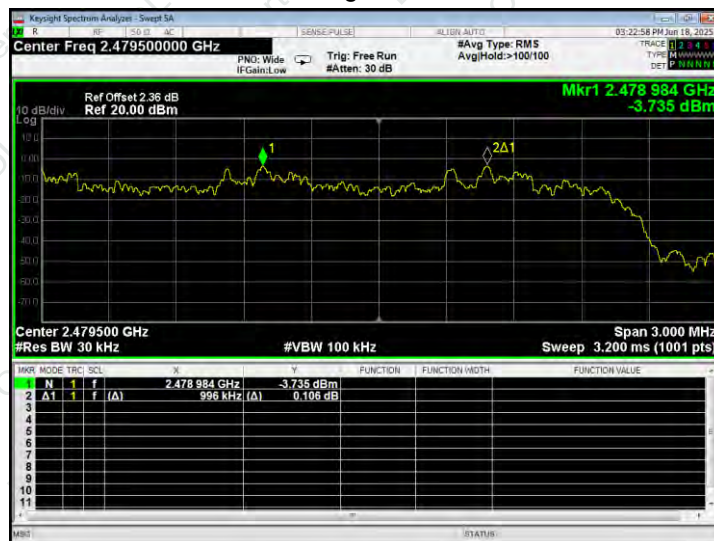



8-DPSK - 3-DH1 Test plots

Low Channel

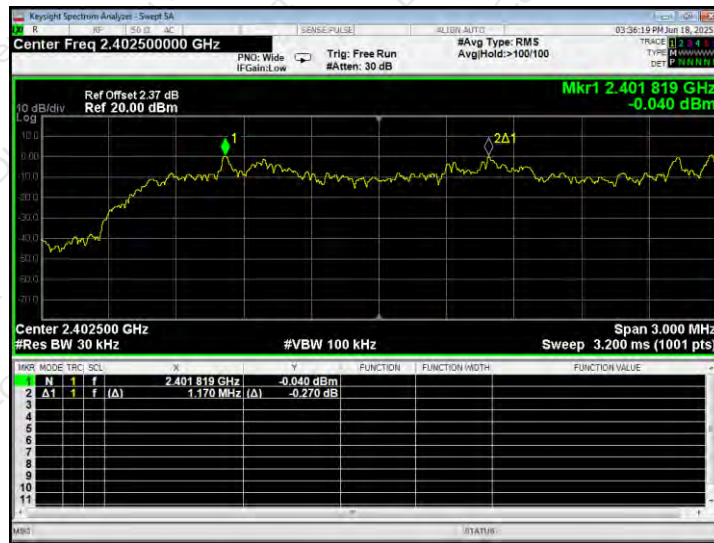

Middle Channel

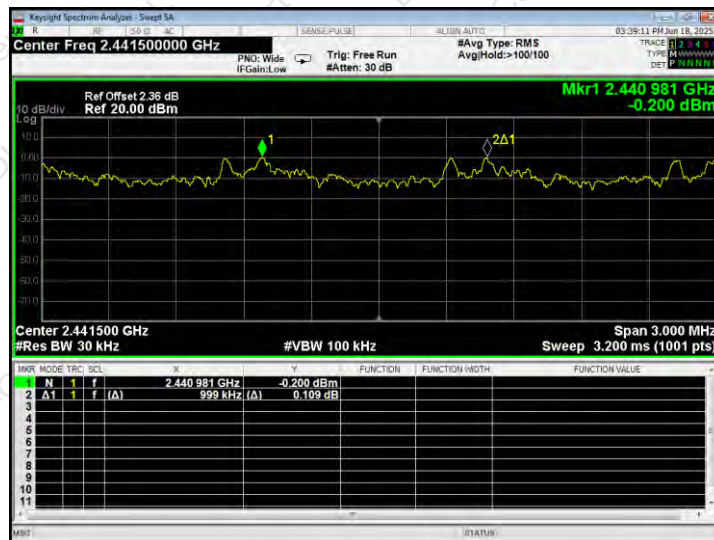

High Channel

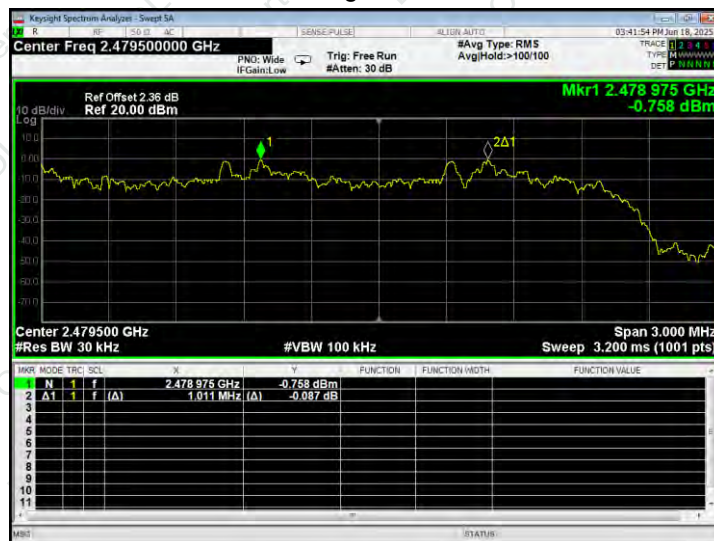



10. NUMBER OF HOPPING FREQUENCY

Test Requirement:	FCC Part15 C Section 15.247 (a)(1)(iii)
Test Method:	ANSI C63.10:2013
Receiver setup:	RBW = 100 kHz, VBW = 300 kHz Frequency range = 2400MHz - 2483.5MHz Detector = peak
Limit:	$P_{\max-pk} \leq 1W$, $N_{ch} \geq 75$ Channels $P_{\max-pk} \leq 0.125W$, $N_{ch} \geq 15$ Channels

10.1 TEST SETUP

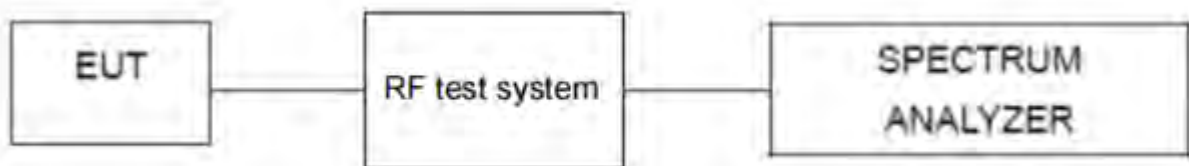

10.2 TEST PROCEDURE

1. Remove the antenna from the EUT and then connect a low RF cable from the antenna port to the spectrum.
2. Set the spectrum analyzer: RBW = 100kHz. VBW = 300kHz. Sweep = auto; Detector Function = Peak. Trace = Max hold.
3. Allow the trace to stabilize. It may prove necessary to break the span up to sections. in order to clearly show all of the hopping frequencies. The limit is specified in one of the subparagraphs of this Section.
4. Set the spectrum analyzer: Start Frequency = 2.4GHz, Stop Frequency = 2.4835GHz. Sweep=auto;

10.3 DEVIATION FROM STANDARD

No deviation.



10.4 TEST RESULT

Modulation	Packet	Hopping Number	Limit	Result
GFSK	1-DH1	79	≥75	Pass
$\pi/4$ -DQPSK	2-DH1	79	≥15	Pass
8-DPSK	3-DH1	79	≥15	Pass

GFSK - 1-DH1 Test Plots

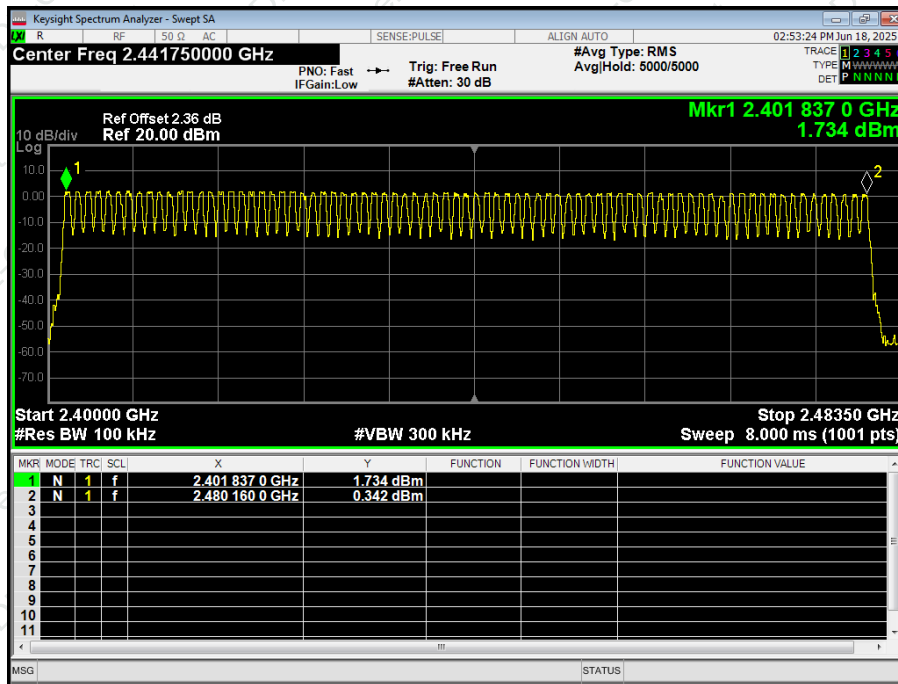

$\pi/4$ -DQPSK - 2-DH1 Test Plots

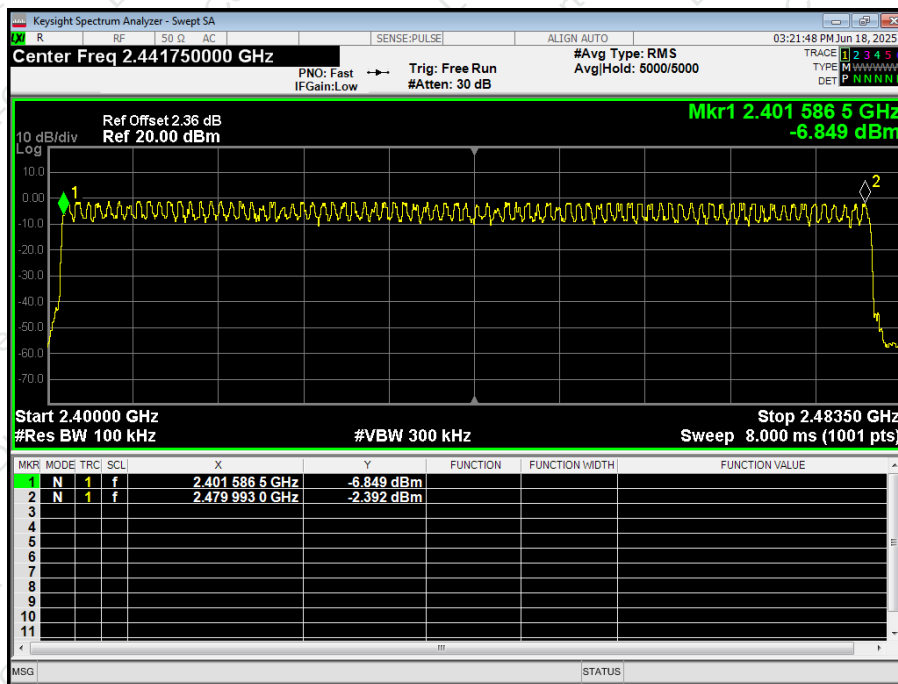



8-DPSK - 3-DH1 Test Plots

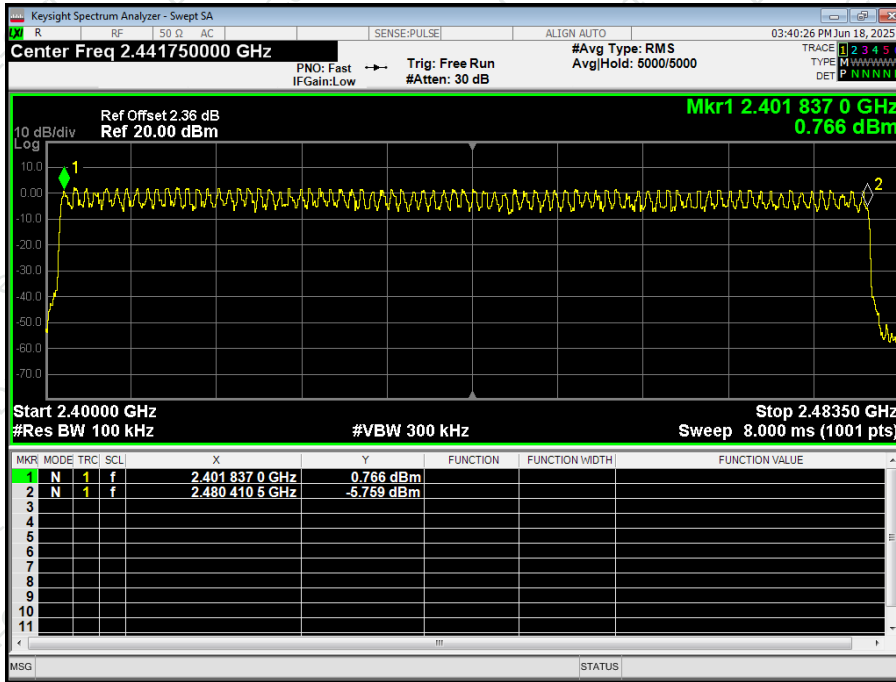



11. DWELL TIME

Test Requirement:	FCC Part15 C Section 15.247 (a)(1)(iii)
Test Method:	ANSI C63.10:2013
Receiver setup:	RBW = 1MHz, VBW = 3MHz, Span = 0Hz, Detector = peak
Limit:	0.4 Second

11.1 TEST SETUP

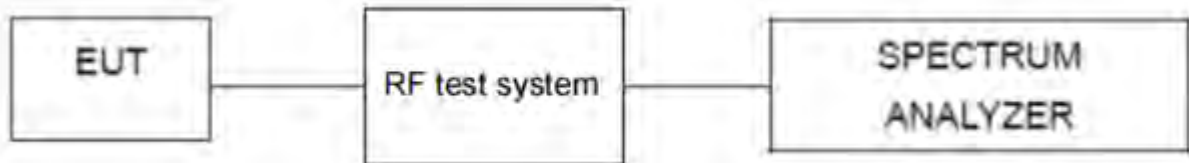

11.2 TEST PROCEDURE

1. Remove the antenna from the EUT and then connect a low RF cable from the antenna port to the spectrum.
2. Set spectrum analyzer span = 0 Hz;
3. Set RBW = 1MHz and VBW = 3MHz. Sweep = as necessary to capture the entire dwell time per hopping channel. Set the EUT for DH5, DH3 and DH1 packet transmitting.
4. Use the marker-delta function to determine the dwell time. If this value varies with different modes of operation (e.g.. data rate. modulation format. etc.). repeat this test for each variation. The limit is specified in one of the subparagraphs of this Section. Submit this plot(s).

11.3 DEVIATION FROM STANDARD

No deviation.



11.4 TEST RESULT

GFSK mode:

Frequency	Packet	Pulse Time (ms)	Total Dwell Time (ms)	Limit (ms)	Result
2441MHz	1-DH1	0.401	128.320	400	Pass
2441MHz	1-DH3	1.657	265.120	400	Pass
2441MHz	1-DH5	2.904	309.760	400	Pass

Remarks:

The test period: $T = 0.4 \text{ Second/Channel} \times 79 \text{ Channel} = 31.6 \text{ s}$

Test channel: as blow

CH:2441MHz time slot= $0.401(\text{ms}) \times (1600 / (2 \times 79)) \times 31.6 = 128.320\text{ms}$ CH:2441MHz time slot= $1.657(\text{ms}) \times (1600 / (4 \times 79)) \times 31.6 = 265.120\text{ms}$ CH:2441MHz time slot= $2.904(\text{ms}) \times (1600 / (6 \times 79)) \times 31.6 = 309.760\text{ms}$ $\pi/4$ -DQPSK mode:

Frequency	Packet	Pulse Time (ms)	Total Dwell Time (ms)	Limit (ms)	Result
2441MHz	2-DH1	0.410	131.200	400	Pass
2441MHz	2-DH3	1.662	265.920	400	Pass
2441MHz	2-DH5	2.910	310.400	400	Pass

Remarks:

The test period: $T = 0.4 \text{ Second/Channel} \times 79 \text{ Channel} = 31.6 \text{ s}$

Test channel: as blow

CH:2441MHz time slot= $0.410(\text{ms}) \times (1600 / (2 \times 79)) \times 31.6 = 131.200\text{ms}$ CH:2441MHz time slot= $1.662(\text{ms}) \times (1600 / (4 \times 79)) \times 31.6 = 265.920\text{ms}$ CH:2441MHz time slot= $2.910(\text{ms}) \times (1600 / (6 \times 79)) \times 31.6 = 310.400\text{ms}$

8-DPSK mode:

Frequency	Packet	Pulse Time (ms)	Total Dwell Time (ms)	Limit (ms)	Result
2441MHz	3-DH1	0.411	131.520	400	Pass
2441MHz	3-DH3	1.661	265.760	400	Pass
2441MHz	3-DH5	2.912	310.613	400	Pass

Remarks:

The test period: $T = 0.4 \text{ Second/Channel} \times 79 \text{ Channel} = 31.6 \text{ s}$

Test channel: as blow

CH:2441MHz time slot= $0.411(\text{ms}) \times (1600 / (2 \times 79)) \times 31.6 = 131.520\text{ms}$ CH:2441MHz time slot= $1.661(\text{ms}) \times (1600 / (4 \times 79)) \times 31.6 = 265.760\text{ms}$ CH:2441MHz time slot= $2.912(\text{ms}) \times (1600 / (6 \times 79)) \times 31.6 = 310.613\text{ms}$



GFSK Test Plots 1-DH1 Middle Channel

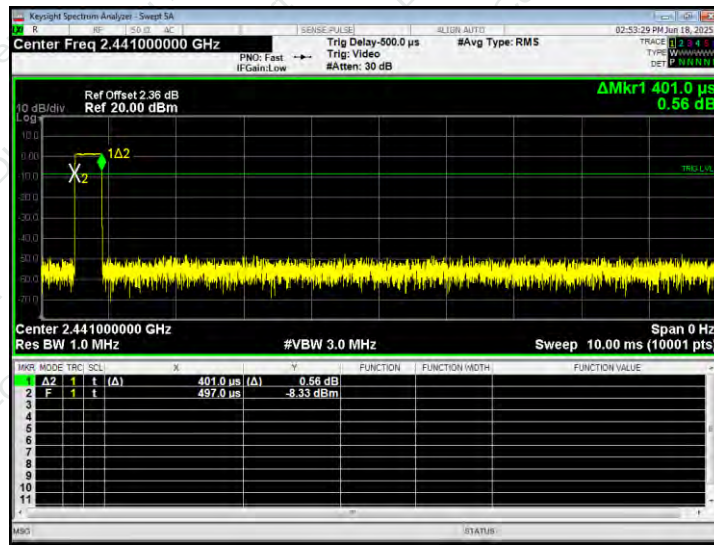

1-DH3 Middle Channel

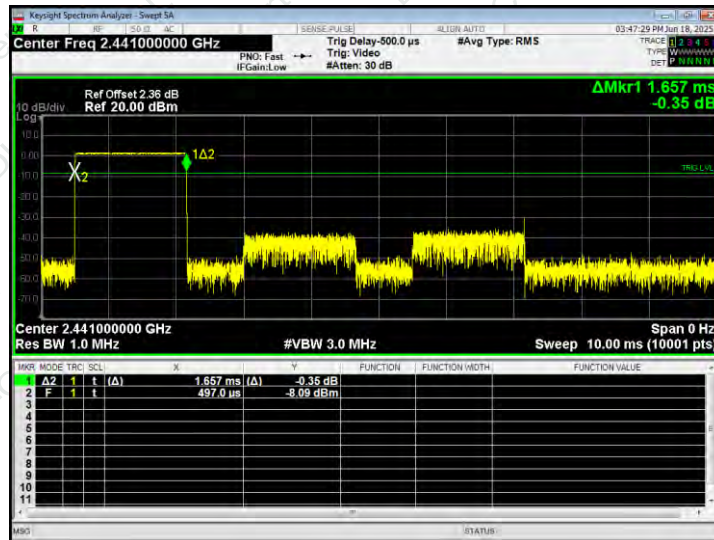

1-DH5 Middle Channel

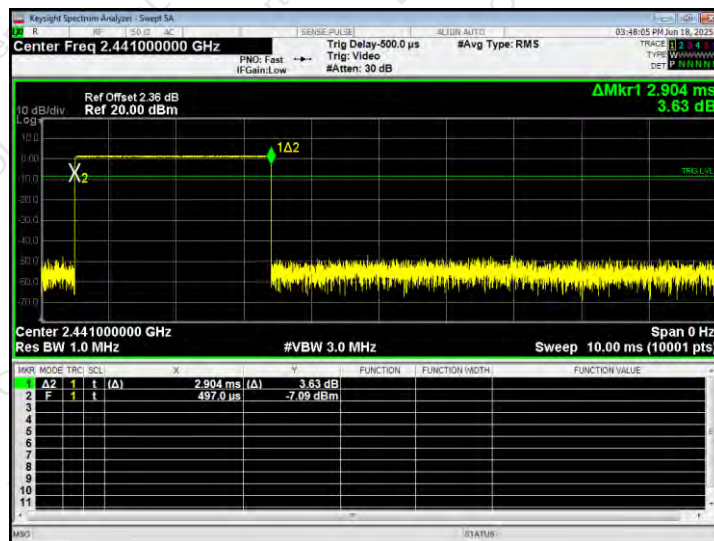



$\pi/4$ -DQPSK Test Plots
2-DH1 Middle Channel

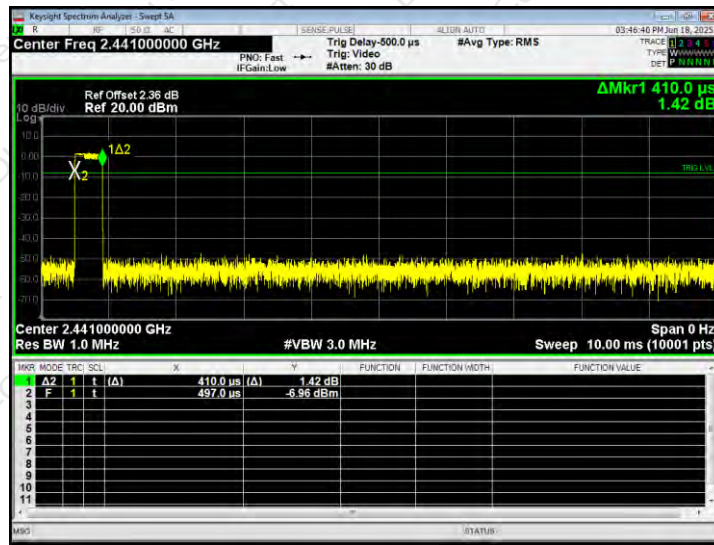

2-DH3 Middle Channel

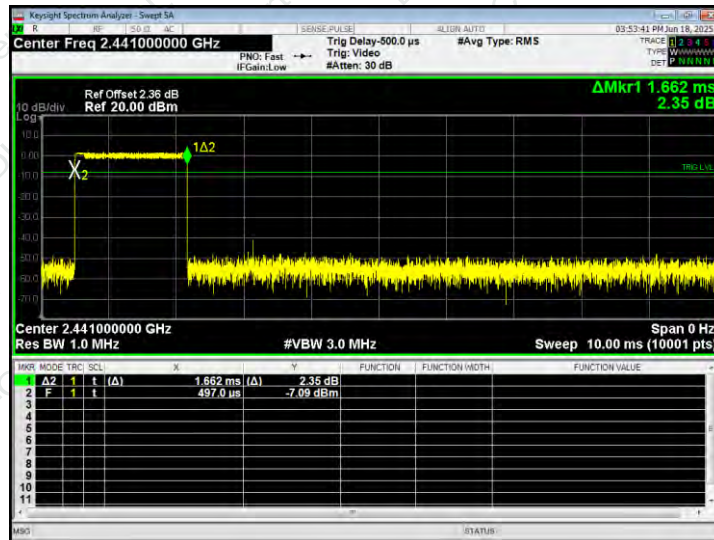

2-DH5 Middle Channel

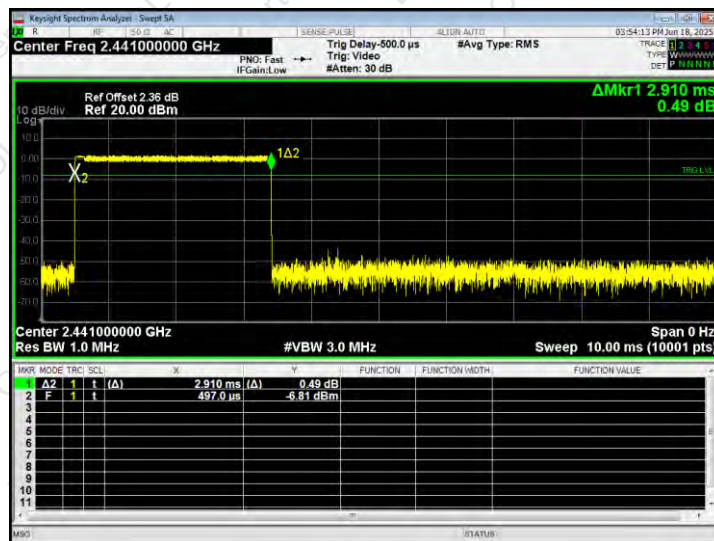



8-DPSK Test Plots 3-DH1 Middle Channel

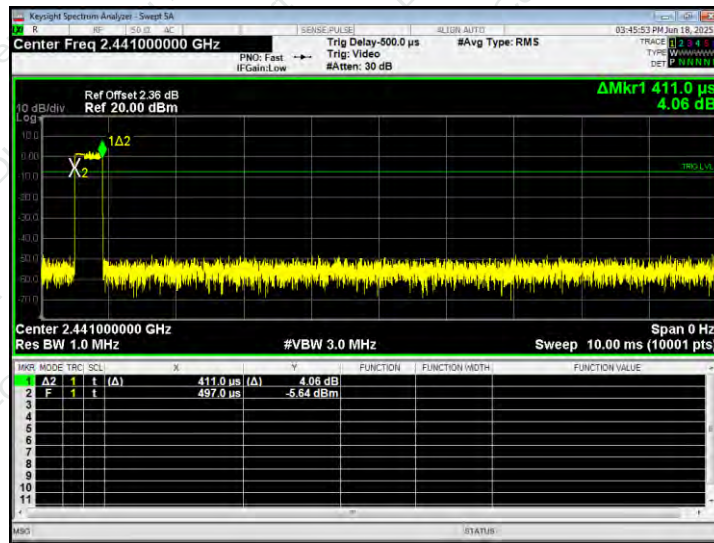

3-DH3 Middle Channel

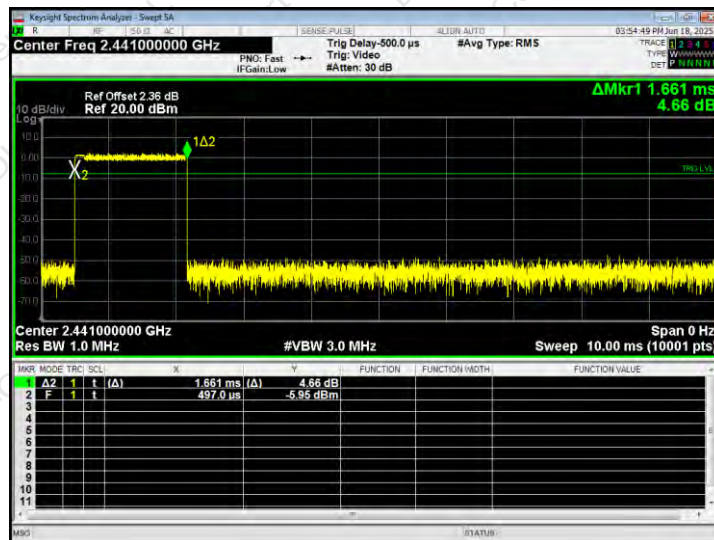

3-DH5 Middle Channel

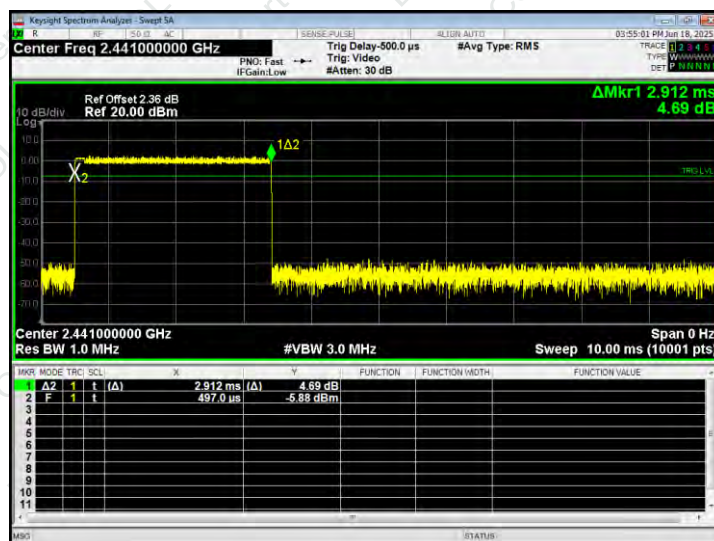



12. ANTENNA REQUIREMENT

Standard requirement:	FCC Part15 C Section 15.203 /247(c)
15.203 requirement: An intentional radiator shall be designed to ensure that no antenna other than that furnished by the responsible party shall be used with the device. The use of a permanently attached antenna or of an antenna that uses a unique coupling to the intentional radiator, the manufacturer may design the unit so that a broken antenna can be replaced by the user, but the use of a standard antenna jack or electrical connector is prohibited.	
15.247(c) (1)(i) requirement: (i) Systems operating in the 2400-2483.5 MHz band that is used exclusively for fixed. Point-to-point operations may employ transmitting antennas with directional gain greater than 6dBi provided the maximum conducted output power of the intentional radiator is reduced by 1 dB for every 3 dB that the directional gain of the antenna exceeds 6dBi.	
EUT Antenna:	
The antenna is PCB Antenna, the best case gain of the antennas is -6.31dBi, reference to the appendix II for details.	



13. TEST SETUP PHOTO

Reference to the appendix I for details.

14. EUT CONSTRUCTIONAL DETAILS

Reference to the appendix II for details.

******* END OF REPORT *******