

EMC TEST REPORT

| | |
|-------------------|-----------------------|
| Applicant | Montage Connect Inc. |
| FCC ID | 2BLQ4-MC25 |
| Product | Montage Cargo Sensor |
| Brand | Montage |
| Model | MC25 |
| Report No. | EFTA25070351-IE-01-E1 |
| Issue Date | August 22, 2025 |

Eurofins TA Technology (Shanghai) Co., Ltd. tested the above equipment in accordance with the requirements in **FCC Code CFR47 Part15B (2024)/ ANSI C63.4-2014**. The test results show that the equipment tested is capable of demonstrating compliance with the requirements as documented in this report.

Prepared by: Liu Wei

Approved by: Xu Kai

Eurofins TA Technology (Shanghai) Co., Ltd.

Building 3, No.145, Jintang Rd, Pudong Shanghai, P.R.China

TEL: +86-021-50791141/2/3

FAX: +86-021-50791141/2/3-8000

Table of Contents

| | | |
|-----|---|----|
| 1 | Test Laboratory | 4 |
| 1.1 | Notes of the Test Report..... | 4 |
| 1.2 | Test Facility..... | 4 |
| 1.3 | Testing Location..... | 4 |
| 2 | General Description of Equipment Under Test | 5 |
| 2.1 | Applicant and Manufacturer Information | 5 |
| 2.2 | General Information | 5 |
| 2.3 | Applied Standards | 6 |
| 2.4 | Test Mode | 7 |
| 3 | Test Case Results | 8 |
| 3.1 | Radiated Emission..... | 8 |
| 3.2 | Conducted Emission..... | 13 |
| 4 | Uncertainty Measurement..... | 16 |
| 5 | Main Test Instruments | 17 |
| 6 | The EUT Appearance..... | 18 |
| 7 | Test Setup Photos | 19 |

Summary of measurement results

| Number | Test Case | Clause in FCC Rules | Conclusion |
|--|--------------------|---------------------------------|------------|
| 1 | Radiated Emission | FCC Part15.109, ANSI C63.4-2014 | PASS |
| 2 | Conducted Emission | FCC Part15.107, ANSI C63.4-2014 | PASS |
| Date of Testing: July 30, 2025 ~ July 31, 2025 | | | |
| Date of Sample Received: July 28, 2025 | | | |
| Note: | | | |
| 1. All indications of Pass/Fail in this report are opinions expressed by Eurofins TA Technology (Shanghai) Co., Ltd. based on interpretations and/or observations of test results. Measurement Uncertainties were not taken into account and are published for informational purposes only. | | | |

1 Test Laboratory

1.1 Notes of the Test Report

This report shall not be reproduced in full or partial, without the written approval of **Eurofins TA Technology (Shanghai) Co., Ltd.** The results documented in this report apply only to the tested sample, under the conditions and modes of operation as described herein. Measurement Uncertainties were not taken into account and are published for informational purposes only. This report is written to support regulatory compliance of the applicable standards stated above.

1.2 Test Facility

FCC (Designation number: CN1179, Test Firm Registration Number: 446626)

Eurofins TA Technology (Shanghai) Co., Ltd. has been listed on the US Federal Communications Commission list of test facilities recognized to perform measurements.

A2LA (Certificate Number: 3857.01)

Eurofins TA Technology (Shanghai) Co., Ltd. has been listed by American Association for Laboratory Accreditation to perform measurement.

1.3 Testing Location

Company: Eurofins TA Technology (Shanghai) Co., Ltd.
Address: Building 3, No.145, Jintang Rd, Pudong Shanghai, P.R.China
City: Shanghai
Post code: 201201
Country: P. R. China
Contact: Xu Kai
Telephone: +86-021-50791141/2/3
Fax: +86-021-50791141/2/3-8000
Website: <https://www.eurofins.com/electrical-and-electronics>
E-mail: Kain.Xu@cpt.eurofinscn.com

2 General Description of Equipment Under Test

2.1 Applicant and Manufacturer Information

| | |
|-----------------------------|--|
| Applicant | Montage Connect Inc. |
| Applicant address | 300 Lenora St #848 Seattle, Washington 98121 United States |
| Manufacturer | / |
| Manufacturer address | / |

2.2 General Information

| EUT Description | | | |
|--|--|---------------|---------------|
| Device Type | Movable Device | | |
| Model | MC25 | | |
| Lab internal SN | EFTA25070351-IE-01/S01 | | |
| HW Version | P1 | | |
| SW Version | 1.1.0 | | |
| Power Rating | DC 12V | | |
| Connecting I/O Port(s) | Please refer to the User's Manual. | | |
| Antenna Type | Internal Antenna | | |
| Frequency | Band | Tx (MHz) | Rx (MHz) |
| | Bluetooth LE | 2400 ~ 2483.5 | 2400 ~ 2483.5 |
| EUT Accessory | | | |
| Cable 1 | Manufacturer: DONGGUAN DINGWEI ELECTRONICTECHNOLOGY Co.,Ltd. Model: M8-P04AMSPM01-03-0500 | | |
| Cable 2 | Manufacturer: DONGGUAN DINGWEI ELECTRONICTECHNOLOGY Co.,Ltd. Model: M8-P04AMSPM01-03-0250 | | |
| Cable 3 | Manufacturer: DONGGUAN DINGWEI ELECTRONICTECHNOLOGY Co.,Ltd. Model: M8-P04AMSPM01-03-0100 | | |
| Note: 1. The EUT is sent from the applicant to Eurofins TA and the information of the EUT is declared by the applicant. | | | |

2.3 Applied Standards

According to the specifications of the manufacturer, it must comply with the requirements of the following standards:

Test standards

FCC Code CFR47 Part15B (2024)

ANSI C63.4-2014

2.4 Test Mode

| Test Mode | |
|-----------|------------------------|
| Mode 1 | Adapter + EUT + SANDBY |

| Test Type | Test Mode | Worst Mode |
|--|-----------|---------------------|
| Radiated Emission | Mode 1 | Mode 1 with Cable 3 |
| Conducted Emission | Mode 1 | Mode 1 with Cable 1 |
| After technical evaluation or/and preliminary test, the test data of the worst-case condition was recorded in this report. | | |

3 Test Case Results

3.1 Radiated Emission

Ambient Condition

| Temperature | Relative humidity |
|-------------|-------------------|
| 15°C ~ 35°C | 30% ~ 60% |

Methods of Measurement

The EUT is placed on a non-metallic table 0.8m above the horizontal metal reference ground plane. The distance between EUT and receive antenna should be 3 meters. During the test, the EUT was operating in its typical mode. The test method is according to ANSI C63.4-2014. Sweep the whole frequency band through the range from 30MHz to the 5th harmonic of the carrier. During the test, the height of receive antenna shall be moved from 1 to 4 meters, and the antenna shall be performed under horizontal and vertical polarization. The turn table shall be rotated from 0 to 360 degrees for detecting the maximum of radiated signal level.

The data of cable loss and antenna factor has been calibrated in full testing frequency range before the testing. During the test, the EUT is worked at maximum output power.

Set the spectrum analyzer in the following:

Below 1GHz:

RBW=100 kHz / VBW=300 kHz / Sweep=AUTO

Above 1GHz:

(a) PEAK Detector: RBW=1MHz / VBW=3MHz/ Sweep=AUTO

(b) AVERAGE Detector: RBW=1MHz / VBW=3MHz / Sweep=AUTO

The radiated emission was measured in the following position: EUT stand-up position (Z axis), lie-down position (X, Y axis). The worst emission was found in lie-down position (X axis) and the worst case was recorded.

Test Setup

Below 1GHz

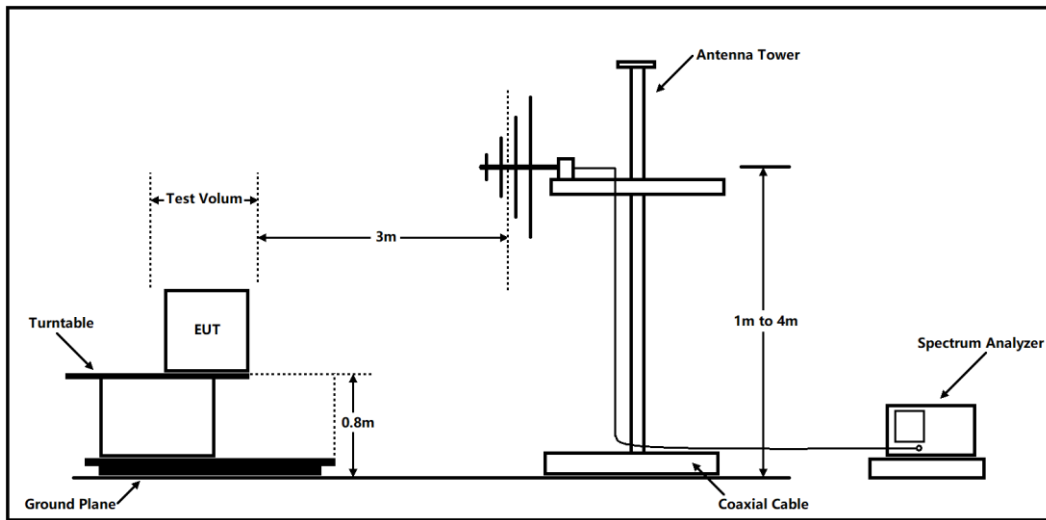

Above 1GHz

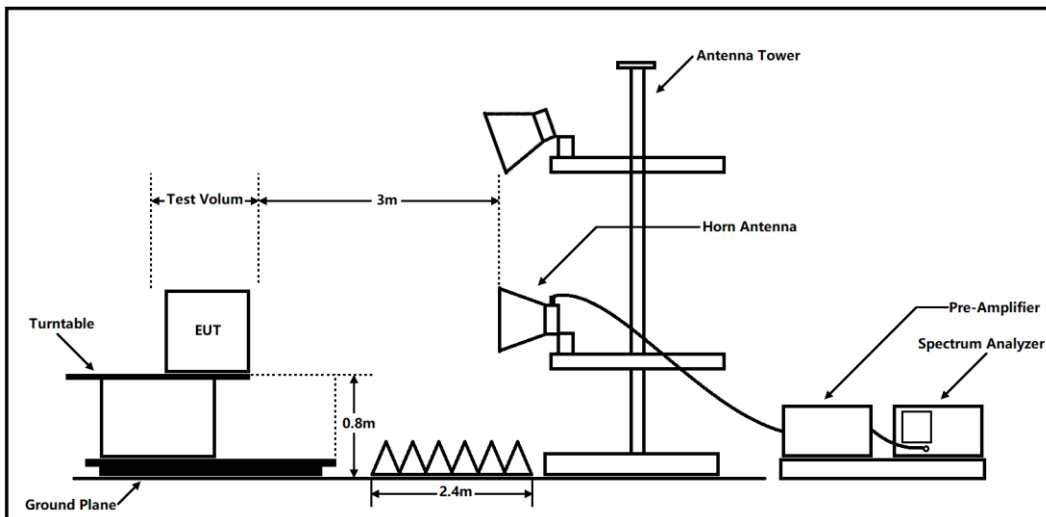

Note: Area side: 2.4mX3.6m

Antenna Tower meets ANSI C63.4 requirements for measurements above 1 GHz by keeping the antenna aimed at the EUT during the antenna's ascent/ descent along the antenna mast.

Limits
Class B

| Frequency (MHz) | Field Strength (dB μ V/m) | Detector |
|---|-------------------------------|-----------------|
| 30 -88 | 40.0 | Quasi-peak |
| 88-216 | 43.5 | Quasi-peak |
| 216 – 960 | 46.0 | Quasi-peak |
| 960-1000 | 54.0 | Quasi-peak |
| 1000-5 th harmonic of the highest frequency or 40GHz, which is lower | 54 74 | Average Peak |

Frequency range of radiated measurements

| Highest frequency generated or used in the device or on which the device operates or tunes (MHz) | Upper frequency of measurement range (MHz) |
|--|--|
| Below 1.705 | 30 |
| 1.705-108 | 1000 |
| 108-500 | 2000 |
| 500-1000 | 5000 |
| Above 1000 | 5th harmonic of the highest frequency or 40 GHz, whichever is lower. |

Test Results

Sweep the whole frequency band through the range from 30MHz to the 5th harmonic of the carrier.

The following graphs display the maximum values of horizontal and vertical by software.
For above 1GHz, Blue trace uses the peak detection, Green trace uses the average detection.

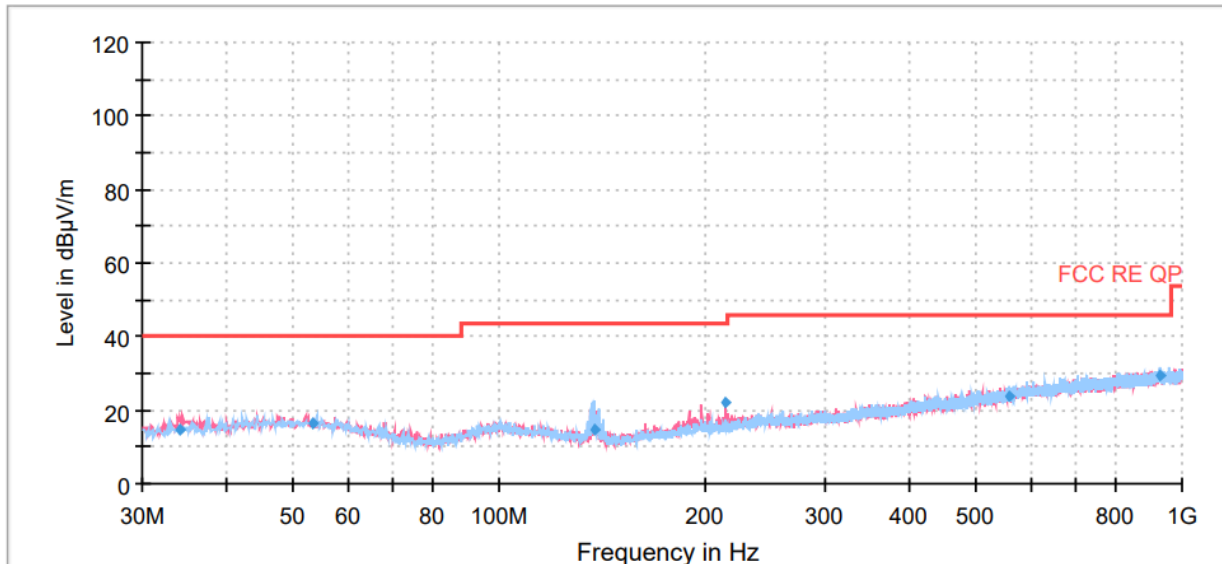

Radiated Emission from 30MHz to 1GHz

Final Result

| Frequency (MHz) | QuasiPeak (dBµV/m) | Limit (dBµV/m) | Margin (dB) | Meas. Time (ms) | Height (cm) | Pol | Azimuth (deg) | Corr. (dB/m) |
|-----------------|--------------------|----------------|-------------|-----------------|-------------|-----|---------------|--------------|
| 34.13 | 14.95 | 40.00 | 25.05 | 1000.00 | 184.0 | V | 191.00 | 18 |
| 53.45 | 16.49 | 40.00 | 23.51 | 1000.00 | 125.0 | H | 166.00 | 20 |
| 137.43 | 14.78 | 43.50 | 28.72 | 1000.00 | 175.0 | H | 199.00 | 15 |
| 214.50 | 22.00 | 43.50 | 21.50 | 1000.00 | 200.0 | V | 138.00 | 18 |
| 557.32 | 23.78 | 46.00 | 22.22 | 1000.00 | 124.0 | H | 192.00 | 26 |
| 930.24 | 29.26 | 46.00 | 16.74 | 1000.00 | 175.0 | H | 114.00 | 32 |

- Remark: 1. Correction Factor = Antenna factor + Insertion loss(cable loss)
2. Margin = Limit – Quasi-Peak

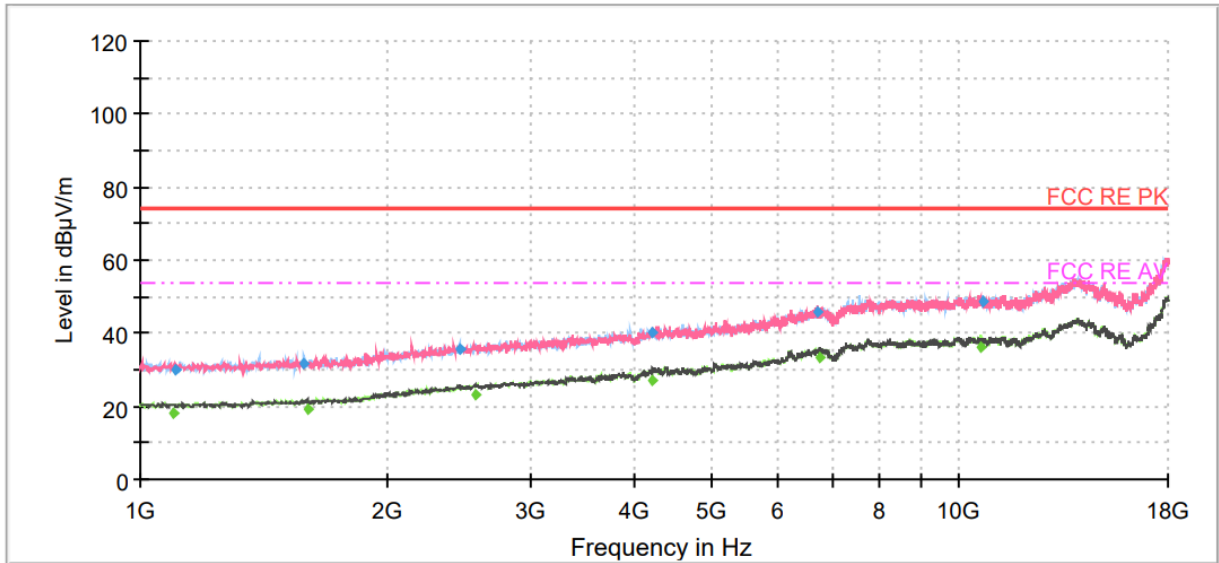

Radiated Emission from 1GHz to 18GHz

Final Result

| Frequency (MHz) | MaxPeak (dBµV/m) | Average (dBµV/m) | Limit (dBµV/m) | Margin (dB) | Meas. Time (ms) | Height (cm) | Pol | Azimuth (deg) | Corr. (dB/m) |
|-----------------|------------------|------------------|----------------|-------------|-----------------|-------------|-----|---------------|--------------|
| 1097.75 | --- | 17.96 | 54.00 | 36.04 | 1000.00 | 103.0 | H | 38.00 | -15 |
| 1106.25 | 30.14 | --- | 74.00 | 43.86 | 1000.00 | 103.0 | V | 0.00 | -15 |
| 1586.50 | 31.86 | --- | 74.00 | 42.14 | 1000.00 | 125.0 | H | 111.00 | -12 |
| 1599.25 | --- | 18.97 | 54.00 | 35.03 | 1000.00 | 102.0 | V | 179.00 | -12 |
| 2451.38 | 35.43 | --- | 74.00 | 38.57 | 1000.00 | 221.0 | H | 350.00 | -8 |
| 2568.25 | --- | 23.41 | 54.00 | 30.59 | 1000.00 | 116.0 | H | 85.00 | -7 |
| 4221.50 | 40.41 | --- | 74.00 | 33.59 | 1000.00 | 184.0 | H | 296.00 | -2 |
| 4227.88 | --- | 27.39 | 54.00 | 26.61 | 1000.00 | 115.0 | V | 1.00 | -2 |
| 6718.38 | 45.66 | --- | 74.00 | 28.34 | 1000.00 | 102.0 | V | 284.00 | 4 |
| 6769.38 | --- | 33.22 | 54.00 | 20.78 | 1000.00 | 176.0 | V | 48.00 | 4 |
| 10596.50 | --- | 36.24 | 54.00 | 17.76 | 1000.00 | 225.0 | H | 232.00 | 8 |
| 10683.63 | 48.76 | --- | 74.00 | 25.24 | 1000.00 | 176.0 | H | 152.00 | 8 |

- Remark: 1. Correction Factor = Antenna factor + Insertion loss (cable loss + amplifier gain)
 2. Margin = Limit – MaxPeak / Average

3.2 Conducted Emission

Ambient Condition

| Temperature | Relative humidity |
|-------------|-------------------|
| 15°C ~ 35°C | 30% ~ 60% |

Methods of Measurement

The EUT is placed on a non-metallic table of 80cm height above the horizontal metal reference ground plane. During the test, the EUT was operating in its typical mode. The test method is according to ANSI C63.4-2014. Connect the AC power line of the EUT to the L.I.S.N. Use EMI receiver to detect the average and Quasi-peak value. RBW is set to 9 kHz, VBW is set to 30kHz. The measurement result should include both L line and N line.

Test Setup

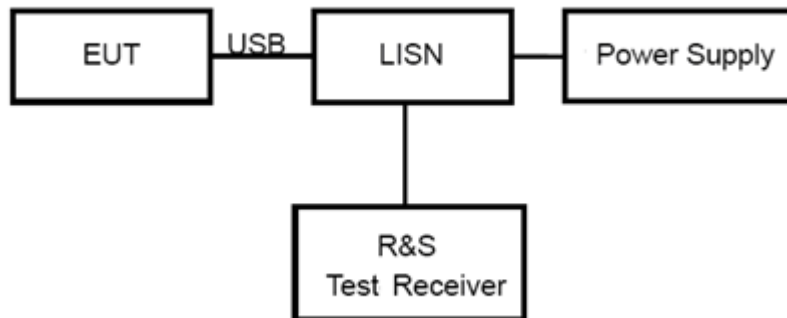

Note: Power Supply is AC Power source and it is used to change the voltage 120V/60Hz.

Limits

| Frequency (MHz) | Class A (dBµV) | | Class B (dBµV) | |
|-----------------|----------------|---------|----------------|-----------|
| | Quasi-peak | Average | Quasi-peak | Average |
| 0.15 - 0.5 | 79 | 66 | 66 to 56 * | 56 to 46* |
| 0.5 - 5 | 73 | 60 | 56 | 46 |
| 5 - 30 | 73 | 60 | 60 | 50 |

*: Decreases with the logarithm of the frequency.

Note: The EUT should meet CLASS B limit.

Test Results

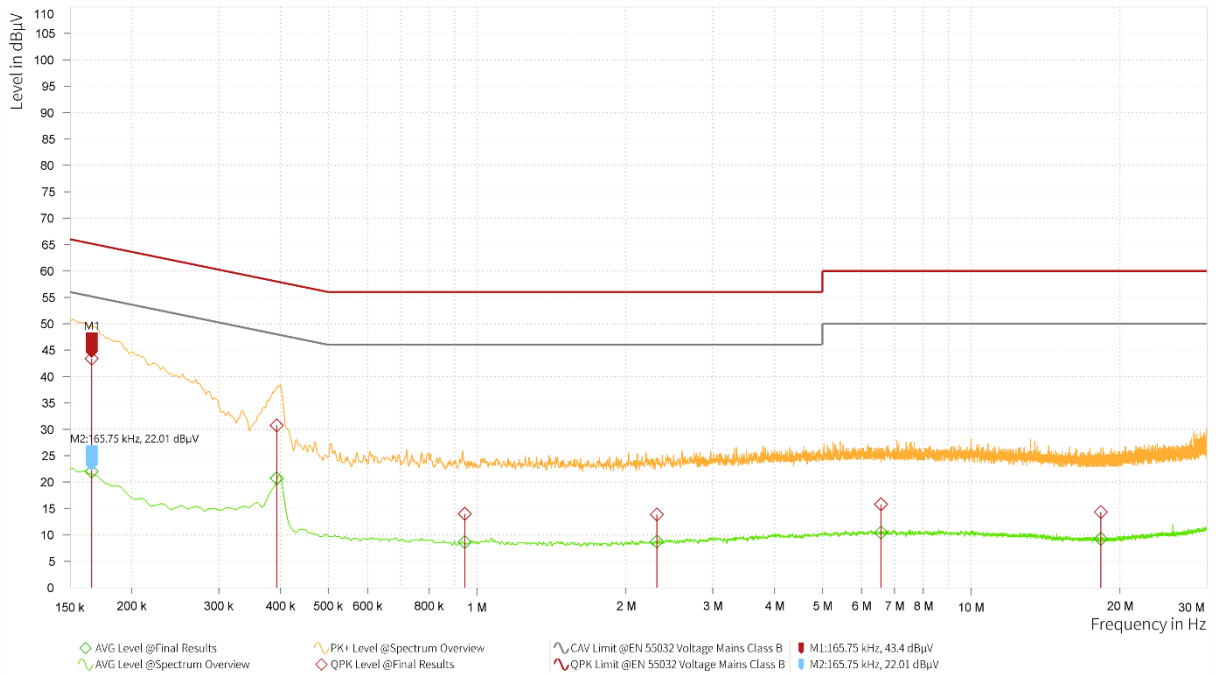

| Frequency [MHz] | QPK Level [dBµV] | QPK Limit [dBµV] | QPK Margin [dB] | AVG Level [dBµV] | AVG: CAV Limit [dBµV] | AVG Margin [dB] | Correction [dB] | Line | Meas. BW [kHz] | Meas. Time [s] |
|-----------------|------------------|------------------|-----------------|------------------|-----------------------|-----------------|-----------------|------|----------------|----------------|
| 0.166 | 43.40 | 65.17 | 21.77 | 22.01 | 55.17 | 33.16 | 20.89 | L1 | 9.000 | 1.000 |
| 0.393 | 30.73 | 58.00 | 27.27 | 20.73 | 48.00 | 27.27 | 20.88 | L1 | 9.000 | 1.000 |
| 0.944 | 13.97 | 56.00 | 42.03 | 8.63 | 46.00 | 37.37 | 20.20 | L1 | 9.000 | 1.000 |
| 2.312 | 13.85 | 56.00 | 42.15 | 8.71 | 46.00 | 37.29 | 19.58 | L1 | 9.000 | 1.000 |
| 6.567 | 15.79 | 60.00 | 44.21 | 10.45 | 50.00 | 39.55 | 19.40 | L1 | 9.000 | 1.000 |
| 18.301 | 14.32 | 60.00 | 45.68 | 9.26 | 50.00 | 40.74 | 19.61 | L1 | 9.000 | 1.000 |

Remark: Correct factor=cable loss + LISN factor

L line

Conducted Emission from 150 kHz to 30 MHz

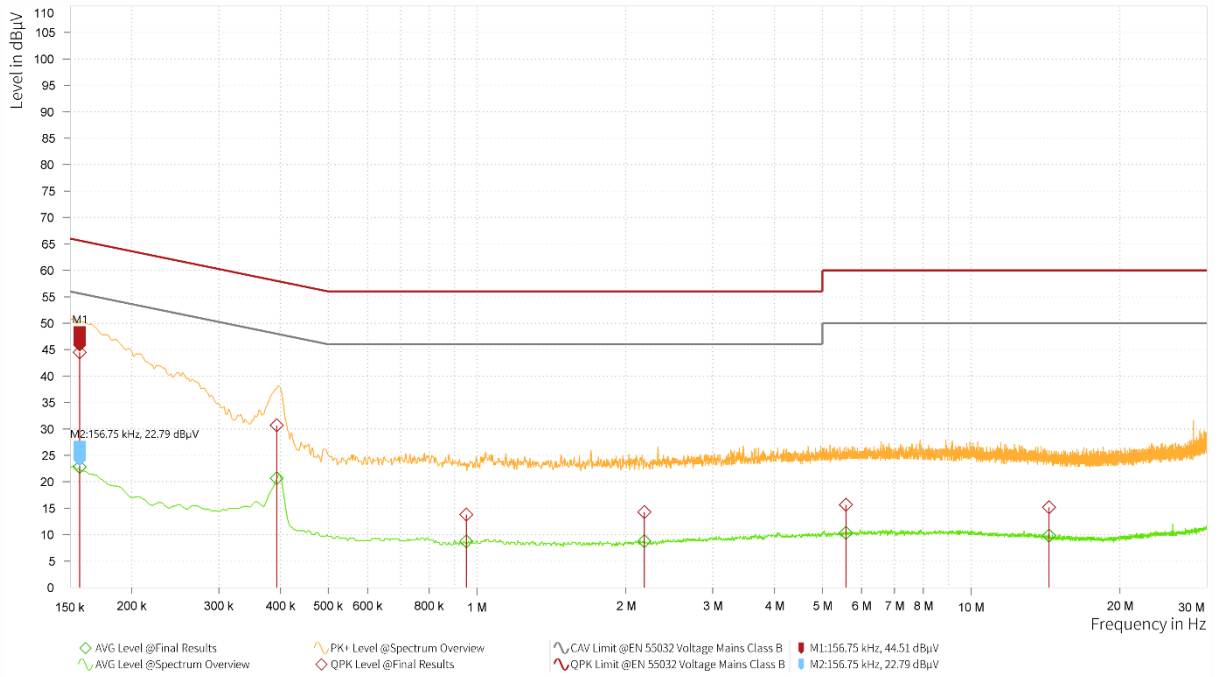

| Frequency [MHz] | QPK Level [dBµV] | QPK Limit [dBµV] | QPK Margin [dB] | AVG Level [dBµV] | AVG: CAV Limit [dBµV] | AVG Margin [dB] | Correction [dB] | Line | Meas. BW [kHz] | Meas. Time [s] |
|-----------------|------------------|------------------|-----------------|------------------|-----------------------|-----------------|-----------------|------|----------------|----------------|
| 0.157 | 44.51 | 65.63 | 21.13 | 22.79 | 55.63 | 32.84 | 20.91 | N | 9.000 | 1.000 |
| 0.393 | 30.67 | 58.00 | 27.33 | 20.70 | 48.00 | 27.30 | 20.89 | N | 9.000 | 1.000 |
| 0.951 | 13.79 | 56.00 | 42.21 | 8.75 | 46.00 | 37.25 | 20.21 | N | 9.000 | 1.000 |
| 2.180 | 14.25 | 56.00 | 41.75 | 8.77 | 46.00 | 37.23 | 19.61 | N | 9.000 | 1.000 |
| 5.579 | 15.68 | 60.00 | 44.32 | 10.36 | 50.00 | 39.64 | 19.41 | N | 9.000 | 1.000 |
| 14.386 | 15.16 | 60.00 | 44.84 | 9.83 | 50.00 | 40.17 | 19.52 | N | 9.000 | 1.000 |

Remark: Correct factor=cable loss + LISN factor
 N line
 Conducted Emission from 150 kHz to 30 MHz

4 Uncertainty Measurement

| Case | Uncertainty | Factor k |
|----------------------------------|-------------|----------|
| Radiated Emission 30MHz – 200MHz | 4.17 dB | 1.96 |
| Radiated Emission 200MHz – 1GHz | 4.84 dB | 1.96 |
| Radiated Emission 1GHz – 18GHz | 4.35 dB | 1.96 |
| Conducted Emission | 2.57 dB | 2 |

5 Main Test Instruments

| Name of Equipment | Manufacturer | Type/Model | Serial Number | Calibration Date | Expiration Time |
|--------------------------|--------------|---------------|---------------|------------------|-----------------|
| Radiated Emission | | | | | |
| EMI Test Receiver | R&S | ESCI3 | 100948 | 2025-05-07 | 2026-05-06 |
| Loop Antenna | SCHWARZBECK | FMZB1519 | 1519-047 | 2023-04-16 | 2026-04-15 |
| TRILOG Broadband Antenna | SCHWARZBECK | VULB 9163 | 1023 | 2023-07-14 | 2026-07-13 |
| Horn Antenna | SCHWARZBECK | BBHA 9120D | 430 | 2024-07-18 | 2027-07-17 |
| Amplifier | R&S | SCU18F | 101022 | 2025-05-06 | 2026-05-05 |
| Horn Antenna | ETS-Lindgren | 3160-09 | 00102643 | 2024-09-24 | 2027-09-23 |
| Amplifier | MicroWave | KLNA-18040050 | 220826001 | 2025-05-06 | 2026-05-05 |
| Software | R&S | EMC32 | 9.26.01 | / | / |
| Conducted Emission | | | | | |
| Artificial main network | R&S | ENV216 | 102191 | 2024-12-02 | 2026-12-01 |
| EMI Test Receiver | R&S | ESR | 101667 | 2025-05-06 | 2026-05-05 |
| Software | R&S | EMC32 | 10.35.10 | / | / |

6 The EUT Appearance

The EUT Appearance are submitted separately.

7 Test Setup Photos

The Test Setup Photos are submitted separately.

***** END OF REPORT *****