

Np413M

Bluetooth Speaker with Karaoke Microphone & FM Radio

1.Product Specifications

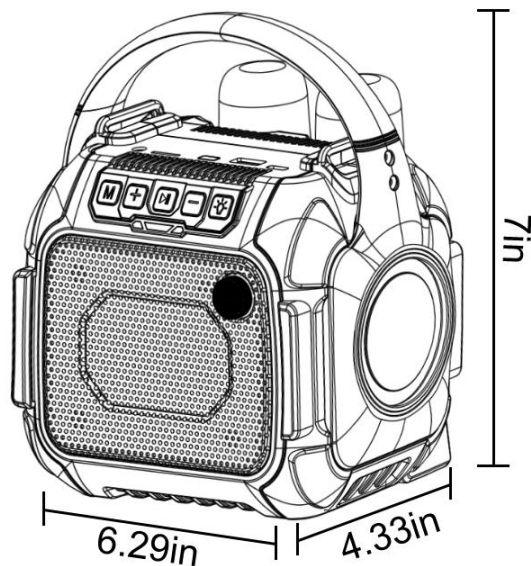









Bluetooth Version	V5.3
Transmission Range	15 meters (no walls in between)
Maximum Output Power	8W
Speaker Built-in battery capacity/voltage	1500MAH*2/3.7V
Input Voltage	5V
Audio Output Impedance	4 Ω
Audio Output Frequency Response Range	50hz-20khz
FM Radio Frequency Range	88M-108MHZ

2.Function Diagram





2.1 Button Description

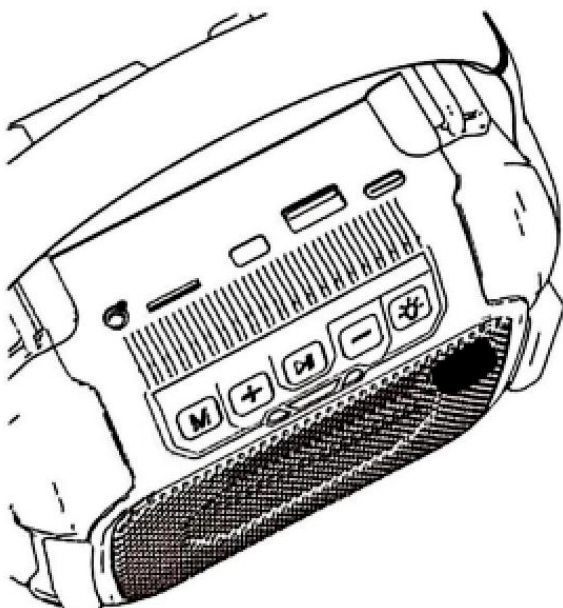

-  **1 Power Switch**
Press and hold to turn the device on/off
-  **2 FM Knob**
Rotate to tune to different radio stations
-  **1 Mode Switch**
Switch between Bluetooth mode, FM mode, and AUX mode
-  **1 Short Press** - Volume up
-  **2 Long Press** - Next track
-  **1 Pause Play**
-  **1 Short Press** - Volume down
-  **2 Long Press** - Previous track
-  **1 Short Press** - Toggle ambient lighting
 - 1 Breathing mode
 - 2 Single-color gradient
 - 3 Rhythm mode (flashes to the beat of the music).

2.2 PORT



-  **TF Card**
Insert a TF card; the songs on the card will be automatically recognized and played.
-  **USB PORT**
Insert a USB drive to play music from the USB source
-  **Accompaniment Switch**
During karaoke, press this button and the speaker will only play the accompaniment of the song.
-  **Type-C Output** - Use to charge build-in battery.
-  **AUX Audio Input**
Connect devices such as laptops, Tv, smart phones, iPads, or computers

3. Usage Instructions

3.1 Bluetooth Connection Operation

- Press and hold the power switch to turn on the device. It prompts "Bluetooth mode"
- In the Bluetooth mode. When the blue light flashes rapidly, the device is in pairing mode.
- Turn on Bluetooth on your phone and search for "Np413M" to Select (the blue light will stay on), and you will hear a prompt tone "dingdong"
- Once connected to your phone, laptop, tablet, or iPad via Bluetooth, you can start playing music.

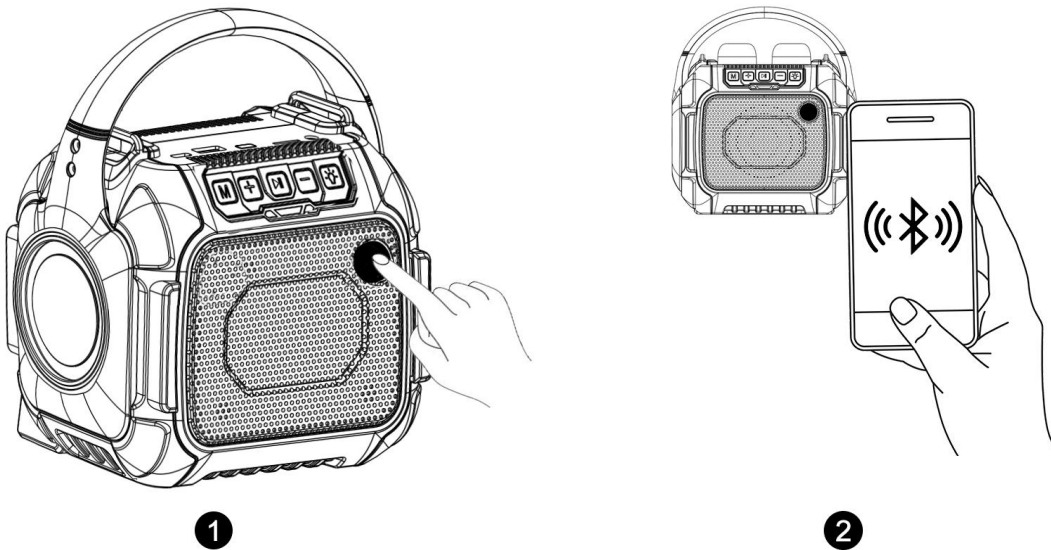

3.2 FM Operation

- After turning on the speaker and entering Bluetooth mode, you can press the speaker's "M" button to switch to FM mode (the green light will illuminate) and the "FM Mode" prompt will appear.

· Rotates the power switch to Change Channel and receive different radio information.

· (If the signal is fuzzy) Fine-tune the frequency slightly to ensure a clear signal. Or go to a window, balcony or other place close to the outdoors to enhance the radio's wireless signal

· By rotating the power switch, you can easily search and switch to different stations, enjoying your favorite broadcasts.

△Note:

If you hear continuous beeping sounds while switching channels, this indicates the FM frequency is outside the 88MHz-108MHz reception range.

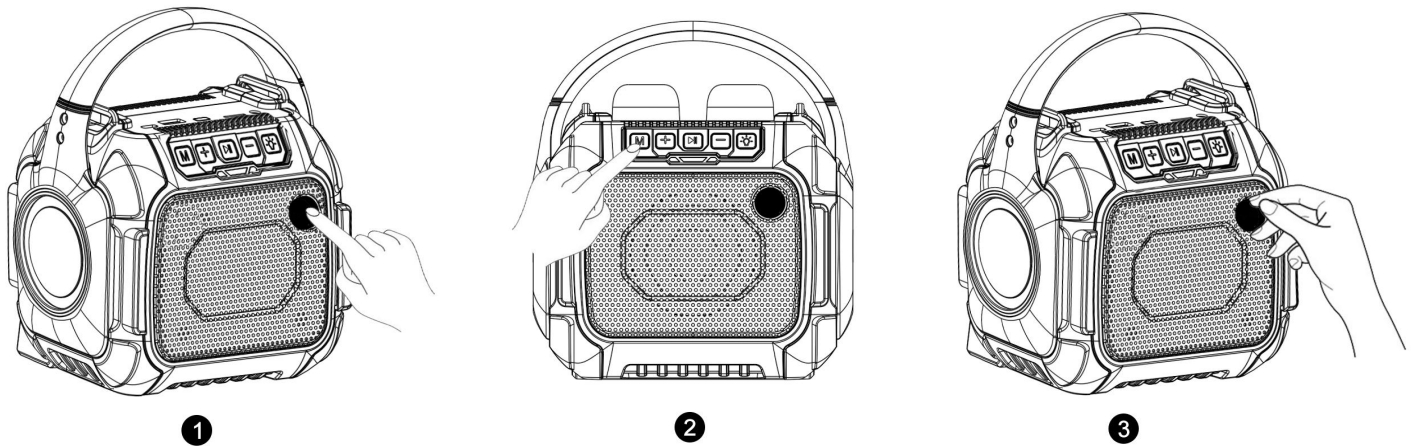

3.3 AUX Connection Operation

·Press and hold the power switch to turn on the device. Use an 3.5` audio cable(not included)to connect one end to your phone or other audio output devices (e.g., iPad, computer)and Insert the round plug into the product, The speaker prompt "AUX Mode" and switch to AUX mode (purple solid light).

Through the AUX line, you can play external audio sources through the speaker.

At this time, press the "M" button and the speaker can be switched between Bluetooth mode, FM radio mode, and aux mode.

(TF card/USB can also play directly in AUX mode, After the TF card/USB is inserted into the port, the speaker will prompt "play by tf card" or "play by usb drive").

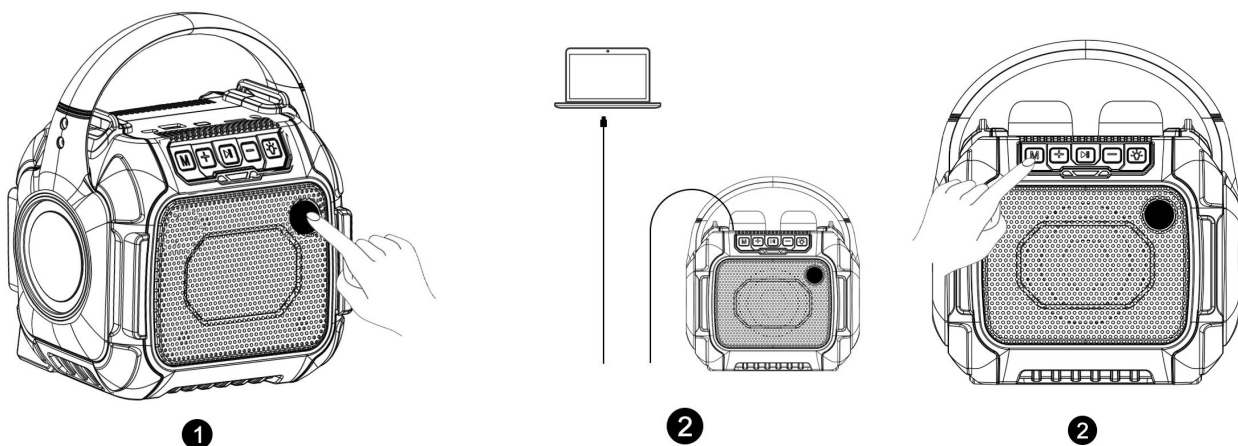

4. How To Use Karaoke Microphone

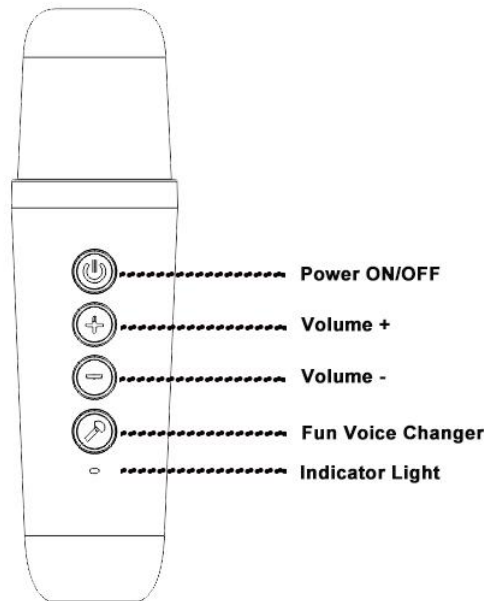

- 1) After the speaker is turned on and in Bluetooth mode, take out the speaker's accompanying microphone and press and hold the power button. The microphone will now connect to the speaker's Bluetooth, and the blue indicator light will illuminate.
- 2) After the microphone is connected to the speaker via Bluetooth, blow into the microphone and listen to the volume of the sound received by the speaker. If the volume of the speaker is too loud, you can press the volume down button on the microphone to lower it. Conversely, press the volume up button on the microphone to increase it.
- 3) After adjusting the microphone volume, play a song through the speaker. You can now sing along with the song into the microphone. If the song is too loud and you can't hear yourself, use the volume-down button on the speaker to lower the volume so you can hear your own singing. If you don't need accompaniment, you can also sing a cappella.
- 4) If you only want accompaniment, press the transparent button on the speaker. The accompaniment will be louder, making it easier for you to sing along. If the song isn't well synthesized, the accompaniment may be missing.
- 5) After singing, press and hold the microphone's power button to turn off the microphone. The blue indicator light on the microphone will turn off.
- 6) The microphone has a built-in 400mAh lithium battery. If the battery is low, the indicator light on the microphone will flash red, indicating that the microphone needs to be charged before use. The red light will remain on while charging and will turn off when fully charged.
- 7) The microphone has a voice change button. Each time you press the button, the sound transmitted from the microphone to the speaker changes to one of four different voices: a monster voice, a female voice, a child's voice, and a male voice. After each of these four changes, the voice returns to normal.

5.Charging Method

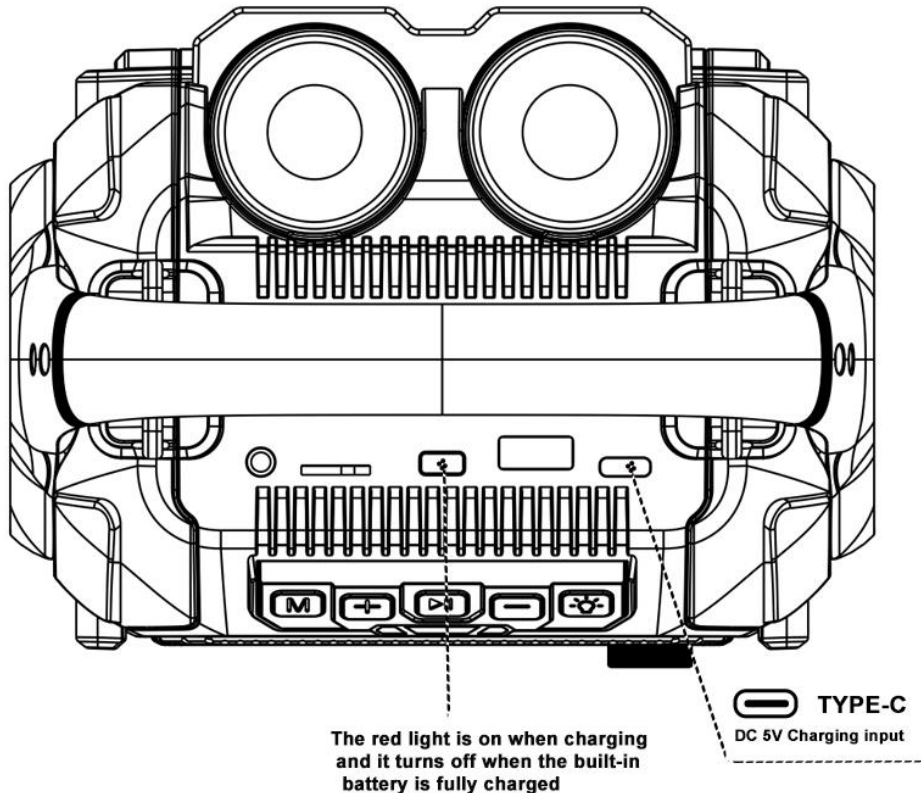

1)When the product prompts “the battery is low”, you need use the USB charging cable with a type-c head to charge the product.

2)The red light is on when charging, and it turns off when the built-in battery is fully charged.

Note:

Before starting any cleaning,always turn off the speaker

- Keep all safety devices,ventilation openings,and the motor housing free from dirt and dust as much as possible.
- Use a clean cloth to wipe the device or blow it with low-pressure compressed air.
- We recommend cleaning the device immediately after each use.
- Do not clean the device with a damp cloth.
- Do not use cleaning agents or solvents.
- Ensure that no water enters the device.

Note:

Water entering the speaker may damage the increase the risk of electric shock.Storeroom-temperature environment.

FCC Caution:

This device complies with part 15 of the FCC Rules. Operation is subject to the following two conditions: (1) This device may not cause harmful interference, and (2) this device must accept any interference received, including interference that may cause undesired operation.

Any changes or modifications not expressly approved by the party responsible for compliance could void the user's authority to operate the equipment.

NOTE: This equipment has been tested and found to comply with the limits for a Class B digital device, pursuant to Part 15 of the FCC Rules. These limits are designed to provide reasonable protection against harmful interference in a residential installation. This equipment generates, uses and can radiate radio frequency energy and, if not installed and used in accordance with the instructions, may cause harmful interference to radio communications. However, there is no guarantee that interference will not occur in a particular installation.

If this equipment does cause harmful interference to radio or television reception, which can be determined by turning the equipment off and on, the user is encouraged to try to correct the interference by one or more of the following measures:

- Reorient or relocate the receiving antenna.
- Increase the separation between the equipment and receiver.
- Connect the equipment into an outlet on a circuit different from that to which the receiver is connected.
- Consult the dealer or an experienced radio/TV technician for help.

The device has been evaluated to meet general RF exposure requirement. The device can be used in portable exposure condition without restriction.