



# TEST REPORT

**Report No.** ..... : **CTC2024255402**

**FCC ID**..... : **2BL4M-HALOSISA1**

**IC** ..... : **33238-HALOASISA1**

**Applicant** ..... : **Nanjing DSeeLab Digital Technology Co., Ltd.**  
 Address..... : Building 3, No.56, Lingzhi Road, Hongshan Street, Xuanwu District, Nanjing, China

**Manufacturer**..... : **Nanjing DSeeLab Digital Technology Co., Ltd.**  
 Address..... : Building 3, No.56, Lingzhi Road, Hongshan Street, Xuanwu District, Nanjing, China

**Product Name** ..... : **Legion Holographic Lyric Wireless Speaker**

**Trade Mark** ..... : **Haloasis**

**Model/Type reference**..... : Haloasis A1

**Listed Model(s)** ..... : /

**Standard** ..... : **FCC CFR Title 47 Part 15 Subpart C Section 15.247  
RSS-247 Issue 3**

**Test Report Form No** ..... : CTC-TR-059\_A1



**Master TRF** ..... : Dated 2024-09-20

**Date of receipt of test sample**..... : Nov. 04, 2024

**Date of testing**..... : Nov. 04, 2024 ~ Dec. 26, 2024

**Date of issue**..... : Feb. 10, 2025

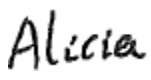
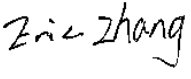
**Result**..... : **PASS**

Compiled by:		
(Printed name+signature)	Alicia Liu	
Supervised by:		
(Printed name+signature)	Eric Zhang	
Approved by:		
(Printed name+signature)	Totti Zhao	

This test report may be duplicated completely for legal use with the approval of the applicant. It should not be reproduced except in full, without the written approval of our laboratory. The client should not use it to claim product endorsement by CTC. The Test Result in the report only apply to the tested sample. The test report shall be invalid without all the signatures of testing engineers, reviewer and approver. Any objections must be raised to CTC within 15 days since the date when the report is received. It will not be taken into consideration beyond this limit.

**Table of Contents****Page**

<b>1. TEST SUMMARY .....</b>	<b>3</b>
1.1. TEST STANDARDS.....	3
1.2. REPORT VERSION .....	3
1.3. TEST DESCRIPTION.....	4
1.4. TEST FACILITY .....	5
1.5. MEASUREMENT UNCERTAINTY .....	6
1.6. ENVIRONMENTAL CONDITIONS.....	6
<b>2. GENERAL INFORMATION .....</b>	<b>7</b>
2.1. CLIENT INFORMATION .....	7
2.2. GENERAL DESCRIPTION OF EUT .....	7
2.3. ACCESSORY EQUIPMENT INFORMATION .....	8
2.4. OPERATION STATE .....	9
2.5. MEASUREMENT INSTRUMENTS LIST .....	10
<b>3. TEST ITEM AND RESULTS .....</b>	<b>11</b>
3.1. CONDUCTED EMISSION.....	11
3.2. RADIATED EMISSION.....	14
3.3. BAND EDGE EMISSIONS (RADIATED) .....	28
3.4. BAND EDGE AND SPURIOUS EMISSIONS (CONDUCTED).....	41
3.5. 20dB BANDWIDTH.....	58
3.6. CHANNEL SEPARATION.....	65
3.7. NUMBER OF HOPPING CHANNEL.....	67
3.8. DWELL TIME .....	69
3.9. PEAK OUTPUT POWER .....	77
3.10. DUTY CYCLE .....	82
3.11. ANTENNA REQUIREMENT.....	87



# 1. TEST SUMMARY

## 1.1. Test Standards

The tests were performed according to following standards:

[FCC Rules Part 15.247](#): Operation within the bands 902–928MHz, 2400–2483.5MHz, and 5725–5850MHz.

[RSS-247 Issue 3](#): Digital Transmission Systems (DTSs), Frequency Hopping Systems (FHSs) and Licence-Exempt Local Area Network (LE-LAN) Devices.

[RSS-Gen Issue 5](#): General Requirements for Compliance of Radio Apparatus.

[ANSI C63.10-2013](#): American National Standard of Procedures for Compliance Testing of Unlicensed Wireless Devices.

## 1.2. Report Version

Revised No.	Report No.	Date of issue	Description
01	CTC2024255402	Feb. 10, 2025	Original



### 1.3. Test Description

FCC Part 15 Subpart C (15.247)				
Test Item	Standard Section		Result	Test Engineer
	FCC	ISED		
Antenna Requirement	15.203	RSS-Gen 6.8	Pass	Alicia Liu
Conducted Emission	15.207	RSS-Gen 8.8	N/A	N/A
Restricted Bands	15.205	RSS-Gen 8.10	Pass	Alicia Liu
Hopping Channel Separation	15.247(a)(1)	RSS-247 5.1 (b)	Pass	Alicia Liu
Dwell Time	15.247(a)(iii)	RSS-247 5.1 (d)	Pass	Alicia Liu
Peak Output Power	15.247(b)(1)	RSS-247 5.4 (b)	Pass	Alicia Liu
Number of Hopping Frequency	15.247(a)(iii)	RSS-247 5.1 (d)	Pass	Alicia Liu
Conducted Band Edge and Spurious Emissions	15.247(d)	RSS-247 5.5	Pass	Alicia Liu
Radiated Band Edge and Spurious Emissions	15.205&15.209&15.247(d)	RSS-247 5.5	Pass	Alicia Liu
Radiated Spurious Emission	15.247(d) & 15.209	RSS-247 5.5 & RSS-Gen 8.9	Pass	Alicia Liu
20dB Bandwidth	15.247(a)	RSS-247 5.1 (b)	Pass	Alicia Liu
Occupied Bandwidth	/	RSS-GEN 6.7	Pass	Alicia Liu

Note:

1. The measurement uncertainty is not included in the test result.
2. N/A: means this test item is not applicable for this device according to the technology characteristic of device.



## 1.4. Test Facility

### Address of the report laboratory

#### CTC Laboratories, Inc.

Add: Room 101 of Building B, Room 107, 108, 207, 208 of Building A, No. 7, Lanqing 1st Road, Luh Community, Guanhu Subdistrict, Longhua District, Shenzhen, Guangdong, China

### Laboratory accreditation

The test facility is recognized, certified, or accredited by the following organizations:

#### A2LA-Lab Cert. No.: 4340.01

CTC Laboratories, Inc. EMC Laboratory has been accredited by A2LA for technical competence in the field of electrical testing, and proved to be in compliance with ISO/IEC 17025:2017 General Requirements for the Competence of Testing and Calibration Laboratories and any additional program requirements in the identified field of testing.

#### Industry Canada (Registration No.: 9783A, CAB Identifier: CN0029)

CTC Laboratories, Inc. EMC Laboratory has been registered by Certification and Engineer Bureau of Industry Canada for the performance of with Registration NO.: 9783A on Jan, 2016.

#### FCC (Registration No.: 951311, Designation Number CN1208)

CTC Laboratories, Inc. EMC Laboratory has been registered and fully described in a report filed with the (FCC) Federal Communications Commission. The acceptance letter from the FCC is maintained in our files. Registration 951311, Aug 26, 2017.



## 1.5. Measurement Uncertainty

The data and results referenced in this document are true and accurate. The reader is cautioned that there may be errors within the calibration limits of the equipment and facilities. The measurement uncertainty was calculated for all measurements listed in this test report acc. to TR-100028-01 “Electromagnetic compatibility and Radio spectrum Matters (ERM);Uncertainties in the measurement of mobile radio equipment characteristics; Part 1” and TR-100028-02 “Electromagnetic compatibility and Radio spectrum Matters (ERM); Uncertainties in the measurement of mobile radio equipment characteristics; Part 2” and is documented in the CTC Laboratories, Inc. quality system acc. to DIN EN ISO/IEC 17025. Furthermore, component and process variability of devices similar to that tested may result in additional deviation. The manufacturer has the sole responsibility of continued compliance of the device.

Below is the best measurement capability for CTC Laboratories, Inc.

Test Items	Measurement Uncertainty	Notes
20dB Emission Bandwidth	±0.0196%	(1)
Carrier Frequency Separation	±1.9%	(1)
Number of Hopping Channel	±1.9%	(1)
Time of Occupancy	±0.028%	(1)
Max Peak Conducted Output Power	±0.743 dB	(1)
Band-edge Spurious Emission	±1.328 dB	(1)
Conducted RF Spurious Emission	9kHz-1GHz: ±0.746dB 1GHz-26GHz: ±1.328dB	(1)
Conducted Emissions 9kHz~30MHz	±3.08 dB	(1)
Radiated Emissions 30~1000MHz	±4.51 dB	(1)
Radiated Emissions 1~18GHz	±5.84 dB	(1)
Radiated Emissions 18~40GHz	±6.12 dB	(1)

Note (1): This uncertainty represents an expanded uncertainty expressed at approximately the 95% confidence level using a coverage factor of k=2.

## 1.6. Environmental Conditions

During the measurement the environmental conditions were within the listed ranges:

Temperature:	15 °C to 35 °C
Relative Humidity:	20 % to 75 %
Air Pressure:	101 kPa



## 2. GENERAL INFORMATION

### 2.1. Client Information

Applicant:	Nanjing DSeeLab Digital Technology Co., Ltd.
Address:	Building 3, No.56, Lingzhi Road, Hongshan Street, Xuanwu District, Nanjing, China
Manufacturer:	Nanjing DSeeLab Digital Technology Co., Ltd.
Address:	Building 3, No.56, Lingzhi Road, Hongshan Street, Xuanwu District, Nanjing, China

### 2.2. General Description of EUT

Product Name:	Legion Holographic Lyric Wireless Speaker
Trade Mark:	Haloasis
Model/Type reference:	Haloasis A1
Listed Model(s):	/
Model Difference:	/
Sample ID:	CTC241030-002-S002
Power Supply:	Input: 100-240V~50/60Hz 1.5A MAX
Hardware Version:	Haloasis A1
Software Version:	Andorid 9
<b>Bluetooth 4.2 / BR+EDR</b>	
Modulation:	GFSK, $\pi/4$ -DQPSK, 8-DPSK
Operation Frequency:	2402MHz~2480MHz
Channel Number:	79
Channel Separation:	1MHz
Antenna Type:	FPC Antenna
Antenna Gain:	3.24dBi



## 2.3. Accessory Equipment Information

Equipment Information			
Name	Model	S/N	Manufacturer
Notebook	ThinkPad T460s	/	Lenovo
SWITCHING MODE POWER SUPPLY	DYS890-240400-23B14	/	DONGSONG
Cable Information			
Name	Shielded Type	Ferrite Core	Length
USB Cable	Unshielded	No	100cm
Test Software Information			
Name	Version	/	/
JS1120-3	V3.3.38	/	/
adb tool	/	/	/

CTC Laboratories, Inc.

Room 101 Building B, No. 7, Lanqing 1st Road, Luhua Community, Guanhu Subdistrict, Longhua District, Shenzhen, Guangdong, China  
Tel.: (86)755-27521059 Fax: (86)755-27521011 Http://www.sz-ctc.org.cn

TRF No: CTC-TR-059\_A1

For anti-fake verification, please visit the official website of China Inspection And Testing Society : [yz.cnca.cn](http://yz.cnca.cn)





## 2.4. Operation State

Operation Frequency List: The EUT has been tested under typical operating condition. The Applicant provides communication tools software to control the EUT for staying in continuous transmitting and receiving mode for testing. BT EDR, 79 channels are provided to the EUT. Channels 00/39/78 were selected for testing.

Operation Frequency List:

Channel	Frequency (MHz)
<b>00</b>	<b>2402</b>
01	2403
:	:
38	2440
<b>39</b>	<b>2441</b>
40	2442
:	:
77	2479
<b>78</b>	<b>2480</b>

Note: The display in grey were the channel selected for testing.

Test Mode:

For RF test items:
The engineering test program was provided and enabled to make EUT continuous transmit.
For AC power line conducted emissions:
The EUT was set to connect with the Bluetooth instrument under large package sizes transmission.
For Radiated spurious emissions test item:
The engineering test program was provided and enabled to make EUT continuous transmit. The EUT in each of three orthogonal axis emissions had been tested, but only the worst case (X axis) data recorded in the report.



## 2.5. Measurement Instruments List

RF Test System - SRD					
Item	Test Equipment	Manufacturer	Model No.	Serial No.	Calibrated Until
1	MXA Signal Analyzer	Keysight	N9020A	MY52091402	Aug. 21, 2025
2	Test Software	Tonscend	JS1120-3	V3.3.38	/

Radiated emission					
Item	Test Equipment	Manufacturer	Model No.	Serial No.	Calibrated Until
1	Trilog-Broadband Antenna	Schwarzbeck	VULB 9168	9168-1013	Dec. 07, 2025
2	Horn Antenna	Schwarzbeck	BBHA 9120D	9120D-648	Dec. 07, 2025
3	Spectrum Analyzer	R&S	FSU26	100105	Dec. 12, 2025
4	Pre-Amplifier	SONOMA	310	186194	Dec. 12, 2025
5	Low Noise Pre-Amplifier	EMCI	EMC051835	980075	Dec. 12, 2025
6	Test Receiver	R&S	ESCI7	100967	Dec. 12, 2025
7	3m chamber 2	Frankonia	EE025	/	Oct. 23, 2025
8	Test Software	FARA	EZ-EMC	FA-03A2	/

Conducted Emission					
Item	Test Equipment	Manufacturer	Model No.	Serial No.	Calibrated Until
1	LISN	R&S	ENV216	101112	Dec. 12, 2025
2	LISN	R&S	ENV216	101113	Dec. 12, 2025
3	EMI Test Receiver	R&S	ESCS30	100353	Dec. 12, 2025
4	ISN CAT6	Schwarzbeck	NTFM 8158	CAT6-8158-0046	Dec. 12, 2025
5	ISN CAT5	Schwarzbeck	NTFM 8158	CAT5-8158-0046	Dec. 12, 2025
6	Test Software	R&S	EMC32	6.10.10	/

Note: 1. The Cal. Interval was one year.

2. The Cal. Interval was three years of the antenna.

3. The cable loss has been calculated in test result which connection between each test instruments.

CTC Laboratories, Inc.

Room 101 Building B, No. 7, Lanqing 1st Road, Luhu Community, Guanhu Subdistrict, Longhua District, Shenzhen, Guangdong, China  
Tel.: (86)755-27521059 Fax: (86)755-27521011 Http://www.sz-ctc.org.cn

TRF No: CTC-TR-059\_A1

For anti-fake verification, please visit the official website of China Inspection And Testing Society : [yz.cnca.cn](http://yz.cnca.cn)

### 3. TEST ITEM AND RESULTS

#### 3.1. Conducted Emission

**Limit**

FCC CFR Title 47 Part 15 Subpart C Section 15.207 / RSS-Gen 8.8

Frequency (MHz)	Conducted Limit (dBμV)	
	Quasi-peak	Average
0.15 - 0.5	66 to 56 *	56 to 46 *
0.5 - 5	56	46
5 - 30	60	50

\* Decreases with the logarithm of the frequency.

**Test Configuration**

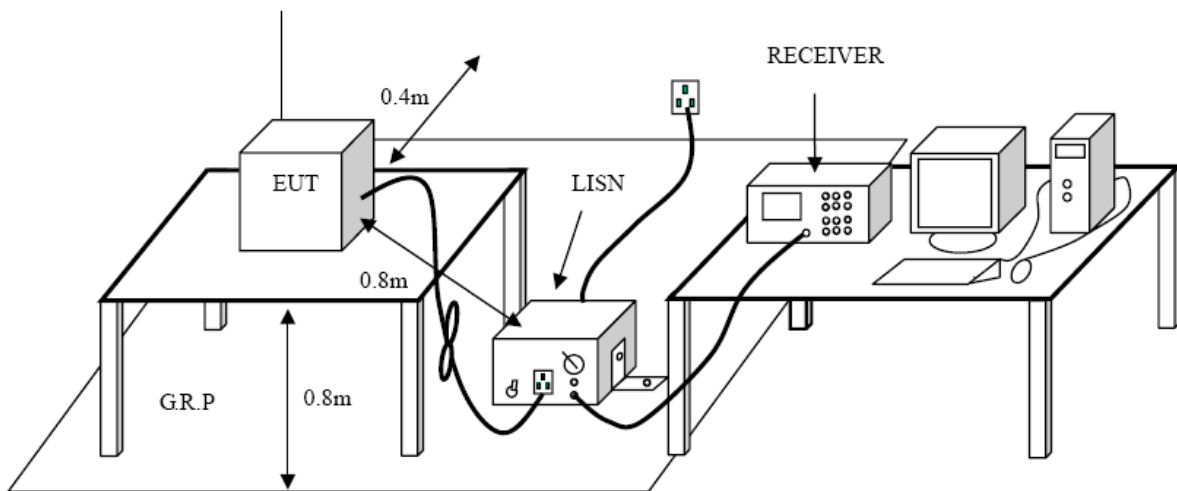

**Test Procedure**

1. The EUT was setup according to ANSI C63.10:2013 requirements.
2. The EUT was placed on a platform of nominal size, 1 m by 1.5 m, raised 80 cm above the conducting ground plane. The vertical conducting plane was located 40 cm to the rear of the EUT. All other surfaces of EUT were at least 80 cm from any other grounded conducting surface.
3. The EUT and simulators are connected to the main power through a line impedance stabilization network (LISN). The LISN provides a 50 ohm / 50 μH coupling impedance for the measuring equipment.
4. The peripheral devices are also connected to the main power through a LISN. (Please refer to the block diagram of the test setup and photographs)
5. Each current-carrying conductor of the EUT power cord, except the ground (safety) conductor, was individually connected through a LISN to the input power source.
6. The excess length of the power cord between the EUT and the LISN receptacle were folded back and forth at the center of the lead to form a bundle not exceeding 40 cm in length.
7. Conducted emissions were investigated over the frequency range from 0.15MHz to 30MHz using a receiver bandwidth of 9 kHz.
8. During the above scans, the emissions were maximized by cable manipulation.

**Test Mode**

Please refer to the clause 2.4.



**Test Result**

<b>Test Voltage:</b>	AC 120V/60Hz
<b>Terminal:</b>	Line
<b>Remark:</b>	Only worse case is reported

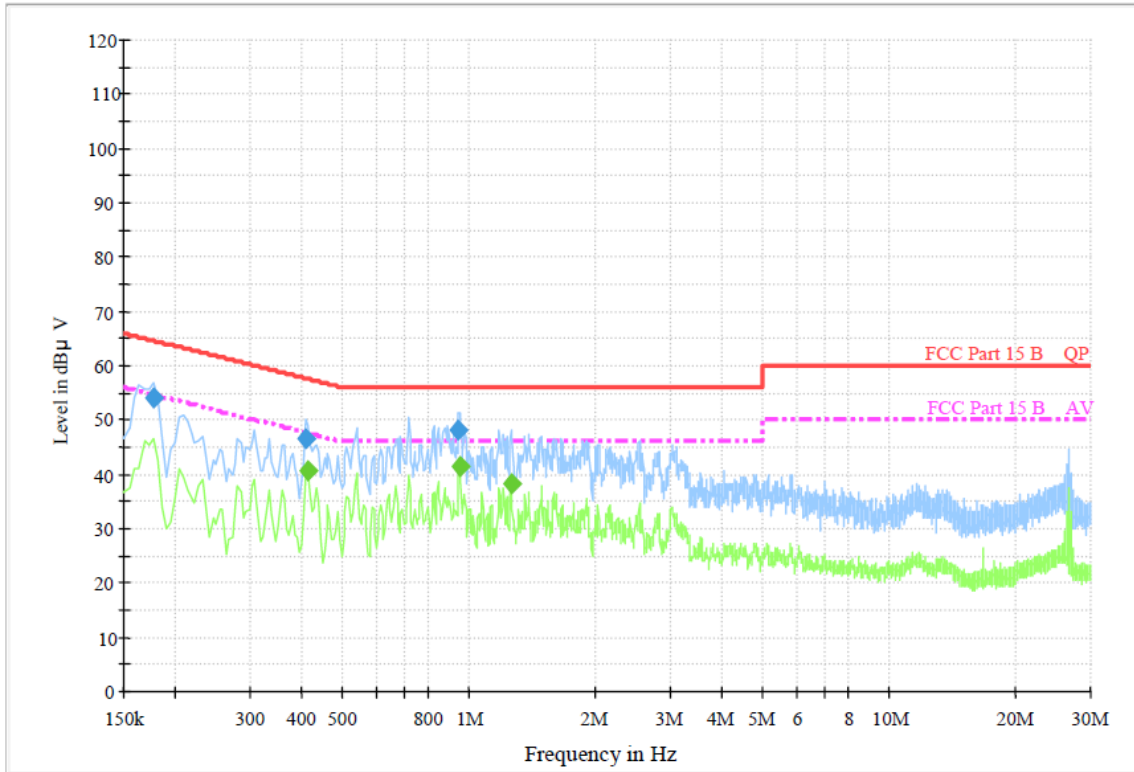

**Final Measurement Detector 1**

Frequency (MHz)	QuasiPeak (dBµ V)	Meas. Time (ms)	Bandwidth (kHz)	Filter	Line	Corr. (dB)	Margin (dB)	Limit (dBµ V)	Comment
0.177000	54.0	1000.00	9.000	On	L1	9.5	10.6	64.6	
0.406500	46.6	1000.00	9.000	On	L1	9.5	11.1	57.7	
0.942000	48.2	1000.00	9.000	On	L1	9.5	7.8	56.0	

**Final Measurement Detector 2**

Frequency (MHz)	Average (dBµ V)	Meas. Time (ms)	Bandwidth (kHz)	Filter	Line	Corr. (dB)	Margin (dB)	Limit (dBµ V)	Comment
0.411000	40.5	1000.00	9.000	On	L1	9.5	7.1	47.6	
0.946500	41.3	1000.00	9.000	On	L1	9.5	4.7	46.0	
1.252500	38.5	1000.00	9.000	On	L1	9.6	7.5	46.0	

Emission Level = Read Level + Correct Factor



<b>Test Voltage:</b>	AC 120V/60Hz
<b>Terminal:</b>	Neutral
<b>Remark:</b>	Only worse case is reported

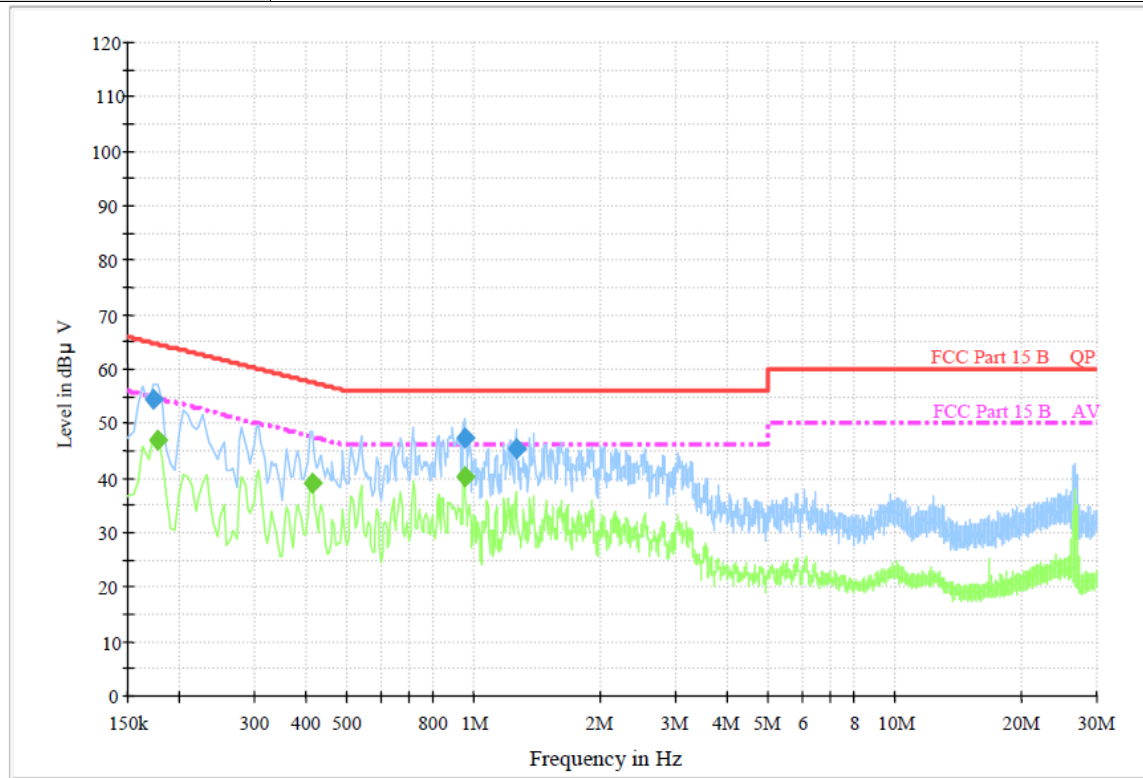

### Final Measurement Detector 1

Frequency (MHz)	QuasiPeak (dBµ V)	Meas. Time (ms)	Bandwidth (kHz)	Filter	Line	Corr. (dB)	Margin (dB)	Limit (dBµ V)	Comment
0.172500	54.3	1000.00	9.000	On	N	9.5	10.5	64.8	
0.946500	47.5	1000.00	9.000	On	N	9.4	8.5	56.0	
1.252500	45.3	1000.00	9.000	On	N	9.5	10.7	56.0	

### Final Measurement Detector 2

Frequency (MHz)	Average (dBµ V)	Meas. Time (ms)	Bandwidth (kHz)	Filter	Line	Corr. (dB)	Margin (dB)	Limit (dBµ V)	Comment
0.177000	46.8	1000.00	9.000	On	N	9.5	7.8	54.6	
0.411000	39.2	1000.00	9.000	On	N	9.4	8.4	47.6	
0.946500	40.2	1000.00	9.000	On	N	9.4	5.8	46.0	

Emission Level = Read Level + Correct Factor

### 3.2. Radiated Emission

**Limit**

FCC CFR Title 47 Part 15 Subpart C Section 15.209 / RSS-Gen 8.9

Frequency (MHz)	Field Strength (microvolts/meter)	Measurement Distance (meters)
0.009~0.490	2400/F (kHz)	300
0.490~1.705	24000/F (kHz)	30
1.705~30.0	30	30
30~88	100	3
88~216	150	3
216~960	200	3
960~1000	500	3

Frequency Range (MHz)	dBµV/m (at 3 meters)	
	Peak	Average
Above 1000	74	54

Note:

- (1) The tighter limit applies at the band edges.
- (2) Emission Level (dBµV/m)=20log Emission Level (µV/m).

**Test Configuration**

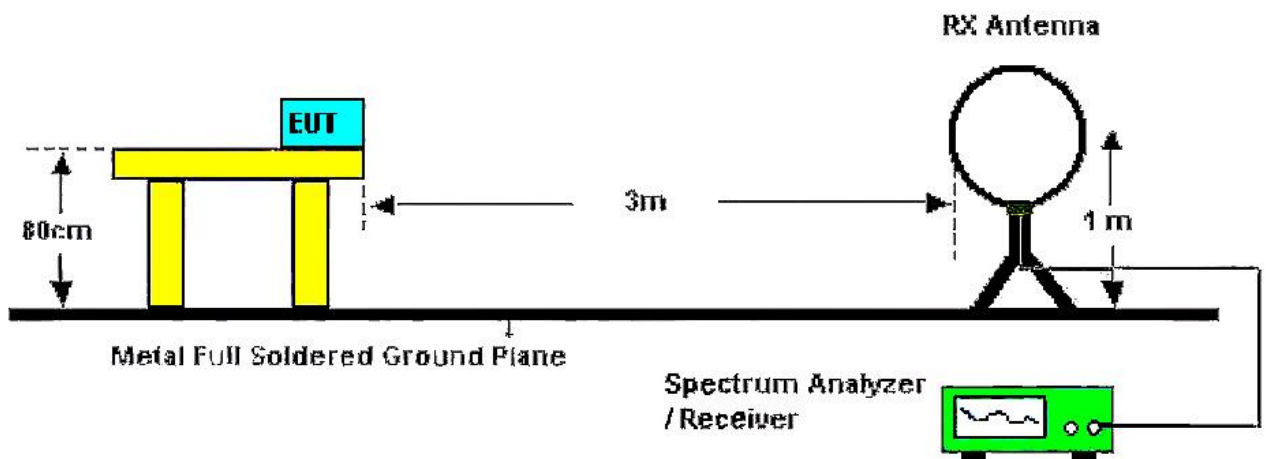

Below 30MHz Test Setup

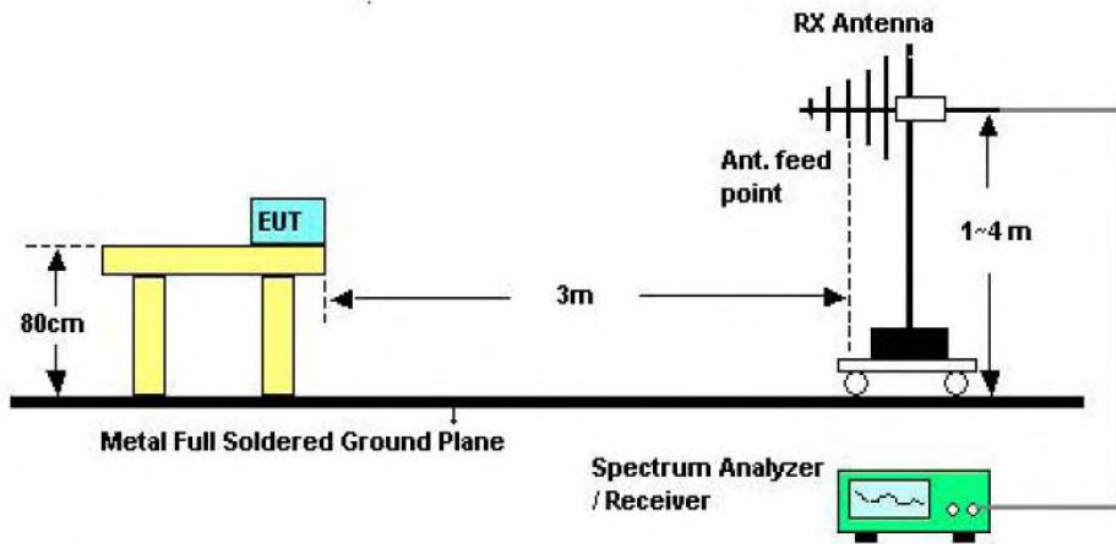

30-1000MHz Test Setup

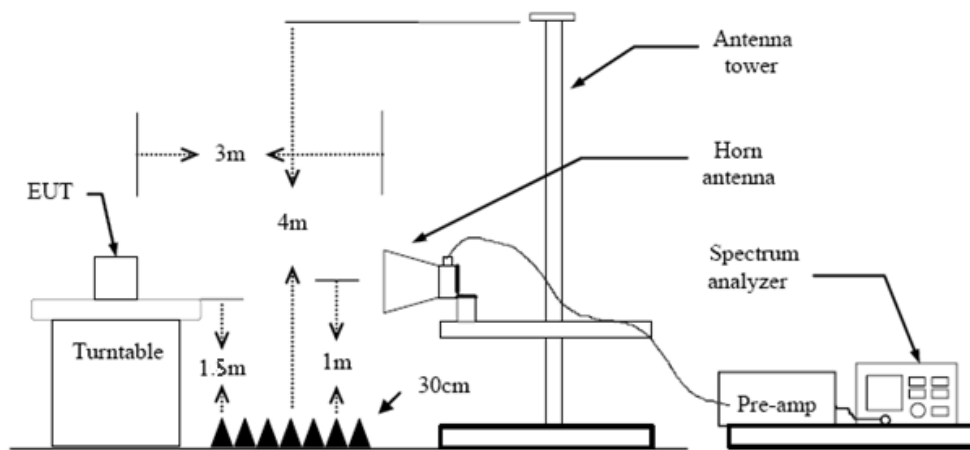

Above 1GHz Test Setup

**Test Procedure**

1. The EUT was setup and tested according to ANSI C63.10:2013.
2. The EUT is placed on a turn table which is 0.8 meter above ground for below 1 GHz, and 1.5 m for above 1 GHz. The turn table is rotated 360 degrees to determine the position of the maximum emission level.
3. The EUT was set 3 meters from the receiving antenna, which was mounted on the top of a variable height antenna tower.
4. For each suspected emission, the EUT was arranged to its worst case and then tune the Antenna tower (from 1 m to 4 m) and turntable (from 0 degree to 360 degrees) to find the maximum reading. A pre-amp and a high pass filter are used for the test in order to get better signal level to comply with the guidelines.
5. Set to the maximum power setting and enable the EUT transmit continuously.
6. Use the following spectrum analyzer settings
  - (1) Span shall wide enough to fully capture the emission being measured;
  - (2) 9k – 150kHz:  
RBW=300 Hz, VBW=1 kHz, Sweep=auto, Detector function=peak, Trace=max hold
  - (3) 0.15M – 30MHz:  
RBW=10 kHz, VBW=30 kHz, Sweep=auto, Detector function=peak, Trace=max hold
  - (4) 30M - 1 GHz:  
RBW=120 kHz, VBW=300 kHz, Sweep=auto, Detector function=peak, Trace=max hold



If the emission level of the EUT measured by the peak detector is 3 dB lower than the applicable limit, the peak emission level will be reported. Otherwise, the emission measurement will be repeated using the quasi-peak detector and reported.

(5) From 1 GHz to 10<sup>th</sup> harmonic:

RBW=1MHz, VBW=3MHz Peak detector for Peak value.

RBW=1MHz, VBW see note 1 with Peak Detector for Average Value.

Note 1: For measurements above 1 GHz the resolution bandwidth is set to 1 MHz, then the video bandwidth is set to 3 MHz for peak measurements and 1 MHz resolution bandwidth with 1/T video bandwidth with peak detector for average measurements. For the Duty Cycle please refer to clause 3.10 Duty Cycle.

### **Test Mode**

Please refer to the clause 2.4.

### **Test Result**

#### **9 kHz~30 MHz**

From 9 kHz to 30 MHz: The conclusion is PASS.

Note: The amplitude of spurious emissions which are attenuated by more than 20dB below the permissible value has no need to be reported.



Ant. Pol.	Horizontal
Test Mode:	TX GFSK Mode 2402MHz
Remark:	Only worse case is reported.

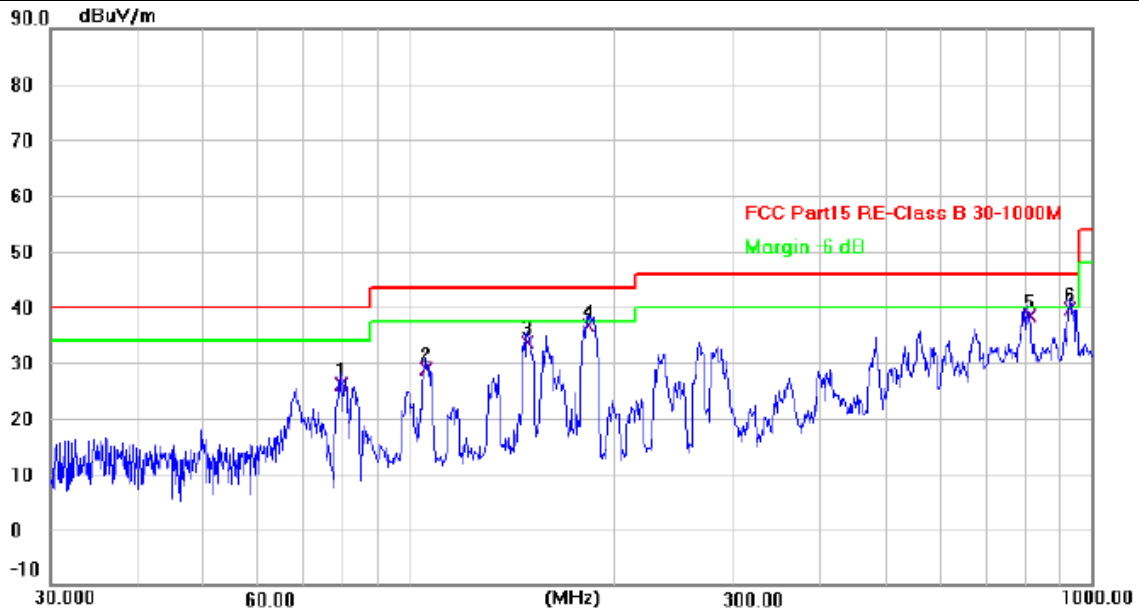

No.	Frequency (MHz)	Reading (dBuV)	Factor (dB/m)	Level (dBuV/m)	Limit (dBuV/m)	Margin (dB)	Detector
1	79.5209	46.84	-20.67	26.17	40.00	-13.83	QP
2	106.3850	48.26	-19.42	28.84	43.50	-14.66	QP
3	149.4857	49.93	-16.23	33.70	43.50	-9.80	QP
4	183.2005	54.85	-18.13	36.72	43.50	-6.78	QP
5	807.4290	42.01	-3.71	38.30	46.00	-7.70	QP
6 *	929.0081	41.63	-2.12	39.51	46.00	-6.49	QP

Remarks:

1. Factor (dB/m) = Antenna Factor (dB/m)+Cable Factor (dB)-Pre-amplifier Factor
2. Margin value = Level -Limit value



<b>Ant. Pol.</b>	Vertical
<b>Test Mode:</b>	TX GFSK Mode 2402MHz
<b>Remark:</b>	Only worse case is reported.

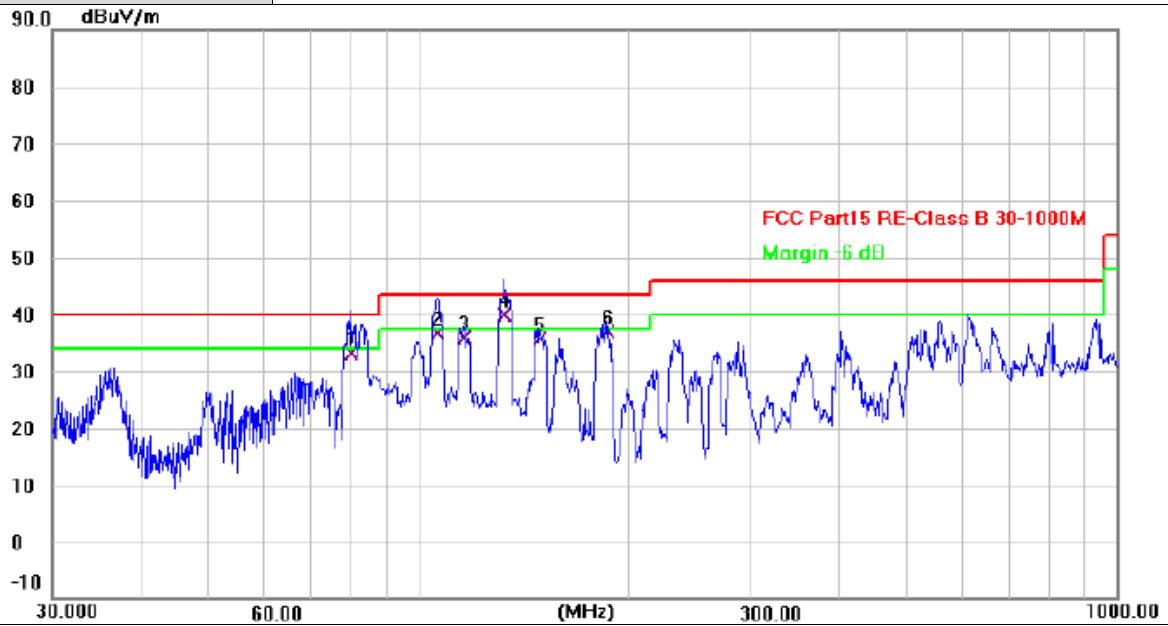

No.	Frequency (MHz)	Reading (dBuV)	Factor (dB/m)	Level (dBuV/m)	Limit (dBuV/m)	Margin (dB)	Detector
1	80.0806	53.96	-20.76	33.20	40.00	-6.80	QP
2	106.7587	56.05	-19.39	36.66	43.50	-6.84	QP
3	116.1321	54.23	-18.39	35.84	43.50	-7.66	QP
4 *	132.6850	57.13	-17.29	39.84	43.50	-3.66	QP
5	148.9625	52.00	-16.26	35.74	43.50	-7.76	QP
6	186.4409	55.47	-18.47	37.00	43.50	-6.50	QP

Remarks:

1. Factor (dB/m) = Antenna Factor (dB/m)+Cable Factor (dB)-Pre-amplifier Factor
2. Margin value = Level -Limit value



Above 1GHz

<b>Ant. Pol.</b>	Horizontal																														
<b>Test Mode:</b>	TX GFSK Mode 2402MHz																														
<b>Remark:</b>	No report for the emission which more than 20 dB below the prescribed limit.																														
<table border="1"> <thead> <tr> <th>No.</th> <th>Frequency (MHz)</th> <th>Reading (dBuV)</th> <th>Factor (dB/m)</th> <th>Level (dBuV/m)</th> <th>Limit (dBuV/m)</th> <th>Margin (dB)</th> <th>Detector</th> </tr> </thead> <tbody> <tr> <td>1</td> <td>4803.763</td> <td>45.81</td> <td>-3.40</td> <td>42.41</td> <td>74.00</td> <td>-31.59</td> <td>peak</td> </tr> <tr> <td>2 *</td> <td>4803.936</td> <td>32.79</td> <td>-3.40</td> <td>29.39</td> <td>54.00</td> <td>-24.61</td> <td>AVG</td> </tr> </tbody> </table>								No.	Frequency (MHz)	Reading (dBuV)	Factor (dB/m)	Level (dBuV/m)	Limit (dBuV/m)	Margin (dB)	Detector	1	4803.763	45.81	-3.40	42.41	74.00	-31.59	peak	2 *	4803.936	32.79	-3.40	29.39	54.00	-24.61	AVG
No.	Frequency (MHz)	Reading (dBuV)	Factor (dB/m)	Level (dBuV/m)	Limit (dBuV/m)	Margin (dB)	Detector																								
1	4803.763	45.81	-3.40	42.41	74.00	-31.59	peak																								
2 *	4803.936	32.79	-3.40	29.39	54.00	-24.61	AVG																								
<b>Remarks:</b> 1.Factor (dB/m) = Antenna Factor (dB/m)+Cable Factor (dB)-Pre-amplifier Factor 2.Margin value = Level -Limit value																															

<b>Ant. Pol.</b>	Vertical																														
<b>Test Mode:</b>	TX GFSK Mode 2402MHz																														
<b>Remark:</b>	No report for the emission which more than 20 dB below the prescribed limit.																														
<table border="1"> <thead> <tr> <th>No.</th> <th>Frequency (MHz)</th> <th>Reading (dBuV)</th> <th>Factor (dB/m)</th> <th>Level (dBuV/m)</th> <th>Limit (dBuV/m)</th> <th>Margin (dB)</th> <th>Detector</th> </tr> </thead> <tbody> <tr> <td>1 *</td> <td>4804.485</td> <td>32.82</td> <td>-3.40</td> <td>29.42</td> <td>54.00</td> <td>-24.58</td> <td>AVG</td> </tr> <tr> <td>2</td> <td>4804.486</td> <td>45.91</td> <td>-3.40</td> <td>42.51</td> <td>74.00</td> <td>-31.49</td> <td>peak</td> </tr> </tbody> </table>								No.	Frequency (MHz)	Reading (dBuV)	Factor (dB/m)	Level (dBuV/m)	Limit (dBuV/m)	Margin (dB)	Detector	1 *	4804.485	32.82	-3.40	29.42	54.00	-24.58	AVG	2	4804.486	45.91	-3.40	42.51	74.00	-31.49	peak
No.	Frequency (MHz)	Reading (dBuV)	Factor (dB/m)	Level (dBuV/m)	Limit (dBuV/m)	Margin (dB)	Detector																								
1 *	4804.485	32.82	-3.40	29.42	54.00	-24.58	AVG																								
2	4804.486	45.91	-3.40	42.51	74.00	-31.49	peak																								
<b>Remarks:</b> 1.Factor (dB/m) = Antenna Factor (dB/m)+Cable Factor (dB)-Pre-amplifier Factor 2.Margin value = Level -Limit value																															



<b>Ant. Pol.</b>	Horizontal
<b>Test Mode:</b>	TX GFSK Mode 2441MHz
<b>Remark:</b>	No report for the emission which more than 20 dB below the prescribed limit.

No.	Frequency (MHz)	Reading (dBuV)	Factor (dB/m)	Level (dBuV/m)	Limit (dBuV/m)	Margin (dB)	Detector
1	4881.584	46.35	-3.26	43.09	74.00	-30.91	peak
2 *	4882.370	32.77	-3.26	29.51	54.00	-24.49	AVG

Remarks:

1.Factor (dB/m) = Antenna Factor (dB/m)+Cable Factor (dB)-Pre-amplifier Factor

2.Margin value = Level -Limit value

<b>Ant. Pol.</b>	Vertical
<b>Test Mode:</b>	TX GFSK Mode 2441MHz
<b>Remark:</b>	No report for the emission which more than 20 dB below the prescribed limit.

No.	Frequency (MHz)	Reading (dBuV)	Factor (dB/m)	Level (dBuV/m)	Limit (dBuV/m)	Margin (dB)	Detector
1	4881.638	46.49	-3.26	43.23	74.00	-30.77	peak
2 *	4881.641	32.72	-3.26	29.46	54.00	-24.54	AVG

Remarks:

1.Factor (dB/m) = Antenna Factor (dB/m)+Cable Factor (dB)-Pre-amplifier Factor

2.Margin value = Level -Limit value



<b>Ant. Pol.</b>	Horizontal
<b>Test Mode:</b>	TX GFSK Mode 2480MHz
<b>Remark:</b>	No report for the emission which more than 20 dB below the prescribed limit.

No.	Frequency (MHz)	Reading (dBuV)	Factor (dB/m)	Level (dBuV/m)	Limit (dBuV/m)	Margin (dB)	Detector
1	4959.731	45.20	-3.10	42.10	74.00	-31.90	peak
2 *	4960.127	32.40	-3.10	29.30	54.00	-24.70	AVG

Remarks:

1. Factor (dB/m) = Antenna Factor (dB/m)+Cable Factor (dB)-Pre-amplifier Factor

2. Margin value = Level -Limit value

<b>Ant. Pol.</b>	Vertical
<b>Test Mode:</b>	TX GFSK Mode 2480MHz
<b>Remark:</b>	No report for the emission which more than 20 dB below the prescribed limit.

No.	Frequency (MHz)	Reading (dBuV)	Factor (dB/m)	Level (dBuV/m)	Limit (dBuV/m)	Margin (dB)	Detector
1 *	4959.936	32.38	-3.10	29.28	54.00	-24.72	AVG
2	4960.308	45.79	-3.10	42.69	74.00	-31.31	peak

Remarks:

1. Factor (dB/m) = Antenna Factor (dB/m)+Cable Factor (dB)-Pre-amplifier Factor

2. Margin value = Level -Limit value



<b>Ant. Pol.</b>	Horizontal																														
<b>Test Mode:</b>	TX $\pi/4$ -DQPSK Mode 2402MHz																														
<b>Remark:</b>	No report for the emission which more than 20 dB below the prescribed limit.																														
<table border="1"> <thead> <tr> <th>No.</th> <th>Frequency (MHz)</th> <th>Reading (dBuV)</th> <th>Factor (dB/m)</th> <th>Level (dBuV/m)</th> <th>Limit (dBuV/m)</th> <th>Margin (dB)</th> <th>Detector</th> </tr> </thead> <tbody> <tr> <td>1 *</td> <td>4803.580</td> <td>32.71</td> <td>-3.40</td> <td>29.31</td> <td>54.00</td> <td>-24.69</td> <td>AVG</td> </tr> <tr> <td>2</td> <td>4804.082</td> <td>45.93</td> <td>-3.40</td> <td>42.53</td> <td>74.00</td> <td>-31.47</td> <td>peak</td> </tr> </tbody> </table>								No.	Frequency (MHz)	Reading (dBuV)	Factor (dB/m)	Level (dBuV/m)	Limit (dBuV/m)	Margin (dB)	Detector	1 *	4803.580	32.71	-3.40	29.31	54.00	-24.69	AVG	2	4804.082	45.93	-3.40	42.53	74.00	-31.47	peak
No.	Frequency (MHz)	Reading (dBuV)	Factor (dB/m)	Level (dBuV/m)	Limit (dBuV/m)	Margin (dB)	Detector																								
1 *	4803.580	32.71	-3.40	29.31	54.00	-24.69	AVG																								
2	4804.082	45.93	-3.40	42.53	74.00	-31.47	peak																								
<b>Remarks:</b> 1. Factor (dB/m) = Antenna Factor (dB/m)+Cable Factor (dB)-Pre-amplifier Factor 2. Margin value = Level -Limit value																															

<b>Ant. Pol.</b>	Vertical																														
<b>Test Mode:</b>	TX $\pi/4$ -DQPSK Mode 2402MHz																														
<b>Remark:</b>	No report for the emission which more than 20 dB below the prescribed limit.																														
<table border="1"> <thead> <tr> <th>No.</th> <th>Frequency (MHz)</th> <th>Reading (dBuV)</th> <th>Factor (dB/m)</th> <th>Level (dBuV/m)</th> <th>Limit (dBuV/m)</th> <th>Margin (dB)</th> <th>Detector</th> </tr> </thead> <tbody> <tr> <td>1 *</td> <td>4804.134</td> <td>32.74</td> <td>-3.40</td> <td>29.34</td> <td>54.00</td> <td>-24.66</td> <td>AVG</td> </tr> <tr> <td>2</td> <td>4804.266</td> <td>45.93</td> <td>-3.40</td> <td>42.53</td> <td>74.00</td> <td>-31.47</td> <td>peak</td> </tr> </tbody> </table>								No.	Frequency (MHz)	Reading (dBuV)	Factor (dB/m)	Level (dBuV/m)	Limit (dBuV/m)	Margin (dB)	Detector	1 *	4804.134	32.74	-3.40	29.34	54.00	-24.66	AVG	2	4804.266	45.93	-3.40	42.53	74.00	-31.47	peak
No.	Frequency (MHz)	Reading (dBuV)	Factor (dB/m)	Level (dBuV/m)	Limit (dBuV/m)	Margin (dB)	Detector																								
1 *	4804.134	32.74	-3.40	29.34	54.00	-24.66	AVG																								
2	4804.266	45.93	-3.40	42.53	74.00	-31.47	peak																								
<b>Remarks:</b> 1. Factor (dB/m) = Antenna Factor (dB/m)+Cable Factor (dB)-Pre-amplifier Factor 2. Margin value = Level -Limit value																															



<b>Ant. Pol.</b>	Horizontal
<b>Test Mode:</b>	TX $\pi/4$ -DQPSK Mode 2441MHz
<b>Remark:</b>	No report for the emission which more than 20 dB below the prescribed limit.

No.	Frequency (MHz)	Reading (dBuV)	Factor (dB/m)	Level (dBuV/m)	Limit (dBuV/m)	Margin (dB)	Detector
1 *	4881.721	32.81	-3.26	29.55	54.00	-24.45	AVG
2	4882.237	45.60	-3.26	42.34	74.00	-31.66	peak

Remarks:

1.Factor (dB/m) = Antenna Factor (dB/m)+Cable Factor (dB)-Pre-amplifier Factor

2.Margin value = Level -Limit value

<b>Ant. Pol.</b>	Vertical
<b>Test Mode:</b>	TX $\pi/4$ -DQPSK Mode 2441MHz
<b>Remark:</b>	No report for the emission which more than 20 dB below the prescribed limit.

No.	Frequency (MHz)	Reading (dBuV)	Factor (dB/m)	Level (dBuV/m)	Limit (dBuV/m)	Margin (dB)	Detector
1	4881.568	46.11	-3.26	42.85	74.00	-31.15	peak
2 *	4882.266	32.70	-3.26	29.44	54.00	-24.56	AVG

Remarks:

1.Factor (dB/m) = Antenna Factor (dB/m)+Cable Factor (dB)-Pre-amplifier Factor

2.Margin value = Level -Limit value



<b>Ant. Pol.</b>	Horizontal
<b>Test Mode:</b>	TX $\pi/4$ -DQPSK Mode 2480MHz
<b>Remark:</b>	No report for the emission which more than 20 dB below the prescribed limit.

No.	Frequency (MHz)	Reading (dBuV)	Factor (dB/m)	Level (dBuV/m)	Limit (dBuV/m)	Margin (dB)	Detector
1	4959.802	45.12	-3.10	42.02	74.00	-31.98	peak
2 *	4959.803	32.43	-3.10	29.33	54.00	-24.67	AVG

Remarks:

1. Factor (dB/m) = Antenna Factor (dB/m)+Cable Factor (dB)-Pre-amplifier Factor

2. Margin value = Level -Limit value

<b>Ant. Pol.</b>	Vertical
<b>Test Mode:</b>	TX $\pi/4$ -DQPSK Mode 2480MHz
<b>Remark:</b>	No report for the emission which more than 20 dB below the prescribed limit.

No.	Frequency (MHz)	Reading (dBuV)	Factor (dB/m)	Level (dBuV/m)	Limit (dBuV/m)	Margin (dB)	Detector
1	4959.516	45.64	-3.10	42.54	74.00	-31.46	peak
2 *	4959.813	32.33	-3.10	29.23	54.00	-24.77	AVG

Remarks:

1. Factor (dB/m) = Antenna Factor (dB/m)+Cable Factor (dB)-Pre-amplifier Factor

2. Margin value = Level -Limit value





<b>Ant. Pol.</b>	Horizontal																														
<b>Test Mode:</b>	TX 8-DPSK Mode 2402MHz																														
<b>Remark:</b>	No report for the emission which more than 20 dB below the prescribed limit.																														
<table border="1"> <thead> <tr> <th>No.</th> <th>Frequency (MHz)</th> <th>Reading (dBuV)</th> <th>Factor (dB/m)</th> <th>Level (dBuV/m)</th> <th>Limit (dBuV/m)</th> <th>Margin (dB)</th> <th>Detector</th> </tr> </thead> <tbody> <tr> <td>1</td> <td>4803.608</td> <td>46.40</td> <td>-3.40</td> <td>43.00</td> <td>74.00</td> <td>-31.00</td> <td>peak</td> </tr> <tr> <td>2 *</td> <td>4804.214</td> <td>32.76</td> <td>-3.40</td> <td>29.36</td> <td>54.00</td> <td>-24.64</td> <td>AVG</td> </tr> </tbody> </table>								No.	Frequency (MHz)	Reading (dBuV)	Factor (dB/m)	Level (dBuV/m)	Limit (dBuV/m)	Margin (dB)	Detector	1	4803.608	46.40	-3.40	43.00	74.00	-31.00	peak	2 *	4804.214	32.76	-3.40	29.36	54.00	-24.64	AVG
No.	Frequency (MHz)	Reading (dBuV)	Factor (dB/m)	Level (dBuV/m)	Limit (dBuV/m)	Margin (dB)	Detector																								
1	4803.608	46.40	-3.40	43.00	74.00	-31.00	peak																								
2 *	4804.214	32.76	-3.40	29.36	54.00	-24.64	AVG																								
<b>Remarks:</b> 1.Factor (dB/m) = Antenna Factor (dB/m)+Cable Factor (dB)-Pre-amplifier Factor 2.Margin value = Level -Limit value																															

<b>Ant. Pol.</b>	Vertical																														
<b>Test Mode:</b>	TX 8-DPSK Mode 2402MHz																														
<b>Remark:</b>	No report for the emission which more than 20 dB below the prescribed limit.																														
<table border="1"> <thead> <tr> <th>No.</th> <th>Frequency (MHz)</th> <th>Reading (dBuV)</th> <th>Factor (dB/m)</th> <th>Level (dBuV/m)</th> <th>Limit (dBuV/m)</th> <th>Margin (dB)</th> <th>Detector</th> </tr> </thead> <tbody> <tr> <td>1 *</td> <td>4804.338</td> <td>32.80</td> <td>-3.40</td> <td>29.40</td> <td>54.00</td> <td>-24.60</td> <td>AVG</td> </tr> <tr> <td>2</td> <td>4804.444</td> <td>46.14</td> <td>-3.40</td> <td>42.74</td> <td>74.00</td> <td>-31.26</td> <td>peak</td> </tr> </tbody> </table>								No.	Frequency (MHz)	Reading (dBuV)	Factor (dB/m)	Level (dBuV/m)	Limit (dBuV/m)	Margin (dB)	Detector	1 *	4804.338	32.80	-3.40	29.40	54.00	-24.60	AVG	2	4804.444	46.14	-3.40	42.74	74.00	-31.26	peak
No.	Frequency (MHz)	Reading (dBuV)	Factor (dB/m)	Level (dBuV/m)	Limit (dBuV/m)	Margin (dB)	Detector																								
1 *	4804.338	32.80	-3.40	29.40	54.00	-24.60	AVG																								
2	4804.444	46.14	-3.40	42.74	74.00	-31.26	peak																								
<b>Remarks:</b> 1.Factor (dB/m) = Antenna Factor (dB/m)+Cable Factor (dB)-Pre-amplifier Factor 2.Margin value = Level -Limit value																															



<b>Ant. Pol.</b>	Horizontal
<b>Test Mode:</b>	TX 8-DPSK Mode 2441MHz
<b>Remark:</b>	No report for the emission which more than 20 dB below the prescribed limit.

No.	Frequency (MHz)	Reading (dBuV)	Factor (dB/m)	Level (dBuV/m)	Limit (dBuV/m)	Margin (dB)	Detector
1 *	4882.039	32.76	-3.26	29.50	54.00	-24.50	AVG
2	4882.302	46.10	-3.26	42.84	74.00	-31.16	peak

Remarks:

1. Factor (dB/m) = Antenna Factor (dB/m)+Cable Factor (dB)-Pre-amplifier Factor

2. Margin value = Level -Limit value

<b>Ant. Pol.</b>	Vertical
<b>Test Mode:</b>	TX 8-DPSK Mode 2441MHz
<b>Remark:</b>	No report for the emission which more than 20 dB below the prescribed limit.

No.	Frequency (MHz)	Reading (dBuV)	Factor (dB/m)	Level (dBuV/m)	Limit (dBuV/m)	Margin (dB)	Detector
1 *	4881.908	32.76	-3.26	29.50	54.00	-24.50	AVG
2	4882.262	46.31	-3.26	43.05	74.00	-30.95	peak

Remarks:

1. Factor (dB/m) = Antenna Factor (dB/m)+Cable Factor (dB)-Pre-amplifier Factor

2. Margin value = Level -Limit value



<b>Ant. Pol.</b>	Horizontal
<b>Test Mode:</b>	TX 8-DPSK Mode 2480MHz
<b>Remark:</b>	No report for the emission which more than 20 dB below the prescribed limit.

No.	Frequency (MHz)	Reading (dBuV)	Factor (dB/m)	Level (dBuV/m)	Limit (dBuV/m)	Margin (dB)	Detector
1	4960.295	45.61	-3.10	42.51	74.00	-31.49	peak
2 *	4960.402	32.41	-3.10	29.31	54.00	-24.69	AVG

Remarks:

1. Factor (dB/m) = Antenna Factor (dB/m)+Cable Factor (dB)-Pre-amplifier Factor

2. Margin value = Level -Limit value

<b>Ant. Pol.</b>	Vertical
<b>Test Mode:</b>	TX 8-DPSK Mode 2480MHz
<b>Remark:</b>	No report for the emission which more than 20 dB below the prescribed limit.

No.	Frequency (MHz)	Reading (dBuV)	Factor (dB/m)	Level (dBuV/m)	Limit (dBuV/m)	Margin (dB)	Detector
1 *	4959.896	32.34	-3.10	29.24	54.00	-24.76	AVG
2	4960.281	45.46	-3.10	42.36	74.00	-31.64	peak

Remarks:

1. Factor (dB/m) = Antenna Factor (dB/m)+Cable Factor (dB)-Pre-amplifier Factor

2. Margin value = Level -Limit value

### 3.3. Band Edge Emissions (Radiated)

**Limit**

**FCC CFR Title 47 Part 15 Subpart C Section 15.247 (d) / RSS-247 5.5**

Restricted Frequency Band (MHz)	(dBµV/m) (at 3m)	
	Peak	Average
2310 ~ 2390	74	54
2483.5 ~ 2500	74	54

**Test Configuration**

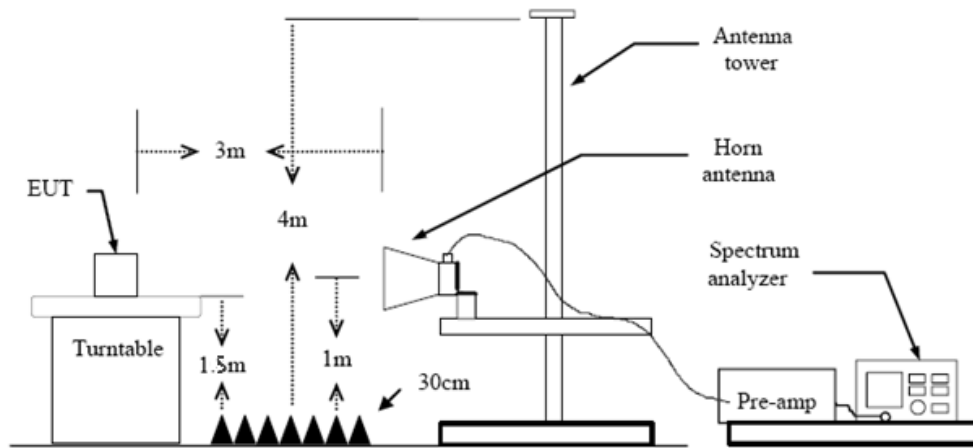

**Test Procedure**

1. The EUT was setup and tested according to ANSI C63.10:2013 requirements.
2. The EUT is placed on a turn table which is 1.5 meter above ground. The turn table is rotated 360 degrees to determine the position of the maximum emission level.
3. The EUT was positioned such that the distance from antenna to the EUT was 3 meters.
4. The antenna is scanned from 1 meter to 4 meters to find out the maximum emission level. This is repeated for both horizontal and vertical polarization of the antenna. In order to find the maximum emission, all of the interface cables were manipulated according to ANSI C63.10:2013 on radiated measurement.
5. The receiver set as follow:  
 RBW=1MHz, VBW=3MHz Peak detector for Peak value.  
 RBW=1MHz, VBW see note 1 with Peak Detector for Average Value.

Note 1: For measurements above 1 GHz the resolution bandwidth is set to 1 MHz, then the video bandwidth is set to 3 MHz for peak measurements and 1 MHz resolution bandwidth with 1/T video bandwidth with peak detector for average measurements. For the Duty Cycle please refer to clause 3.10 Duty Cycle.

**Test Mode**

Please refer to the clause 2.4.



**Test Result**

Ant. Pol.	Horizontal
Test Mode:	GFSK Mode 2402MHz

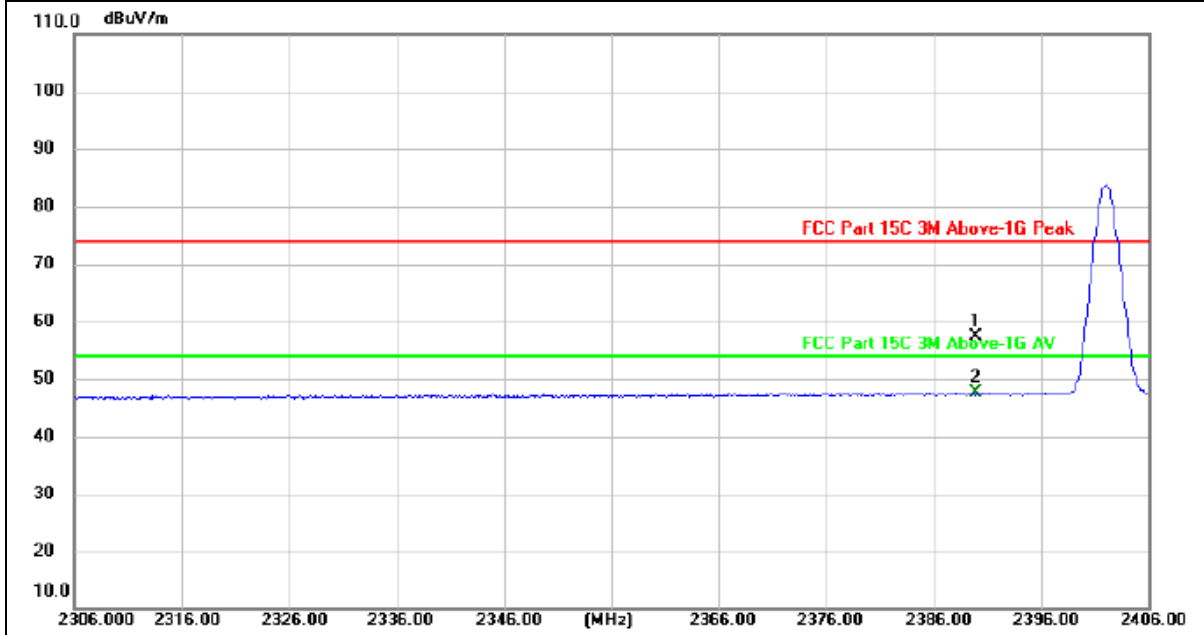

No.	Frequency (MHz)	Reading (dBuV)	Factor (dB/m)	Level (dBuV/m)	Limit (dBuV/m)	Margin (dB)	Detector
1	2390.000	26.35	31.08	57.43	74.00	-16.57	peak
2 *	2390.000	16.51	31.08	47.59	54.00	-6.41	AVG

Remarks:  
 1. Factor (dB/m) = Antenna Factor (dB/m)+Cable Factor (dB)-Pre-amplifier Factor  
 2. Margin value = Level -Limit value

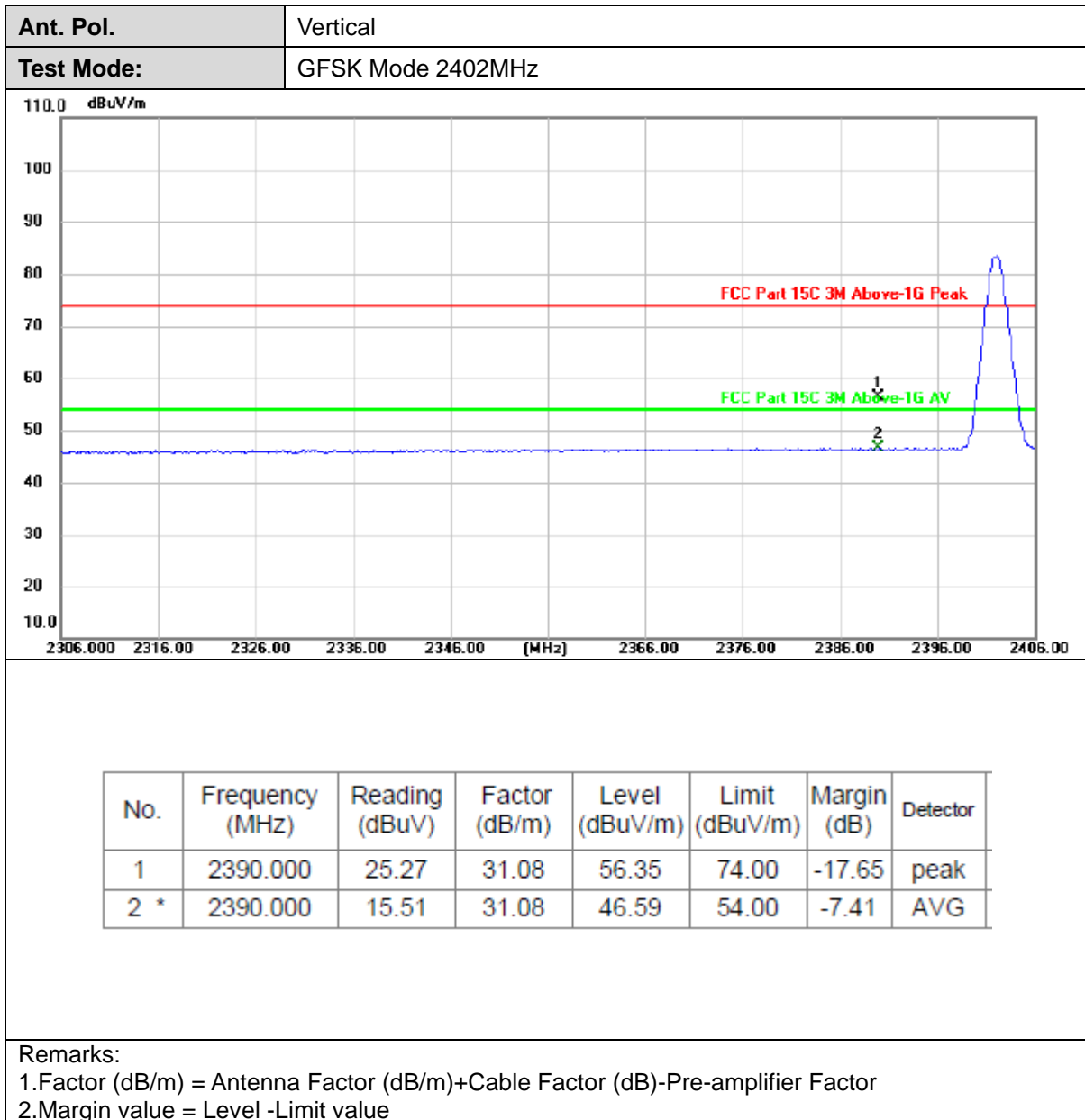



Ant. Pol.	Horizontal
Test Mode:	GFSK Mode 2480MHz

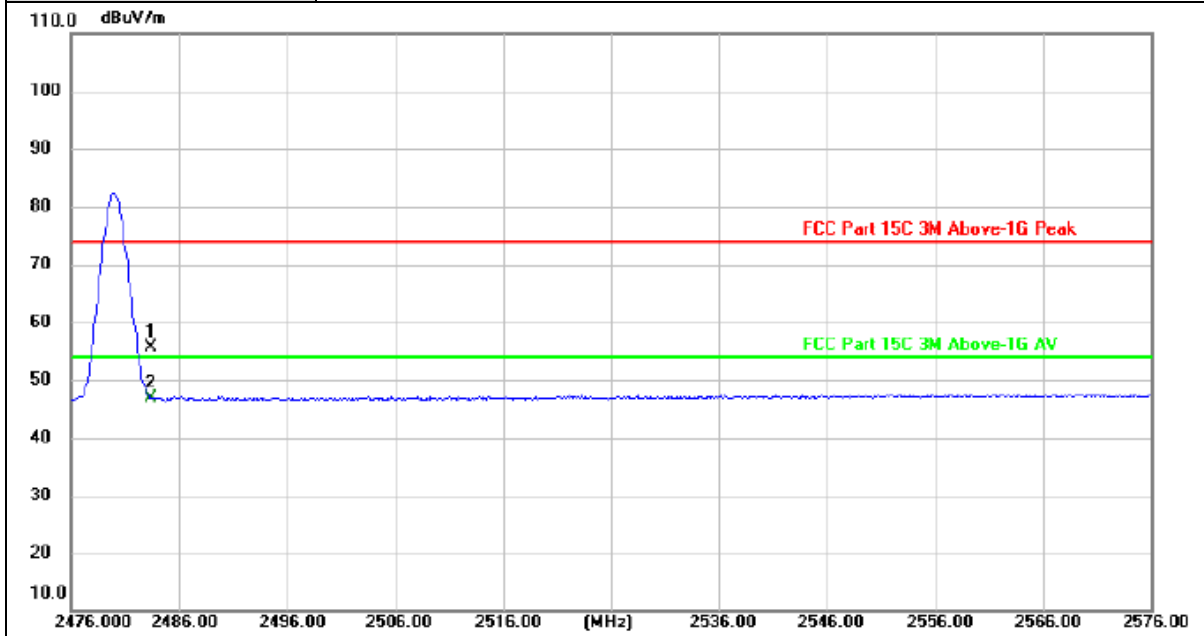

No.	Frequency (MHz)	Reading (dBuV)	Factor (dB/m)	Level (dBuV/m)	Limit (dBuV/m)	Margin (dB)	Detector
1	2483.500	24.31	31.43	55.74	74.00	-18.26	peak
2 *	2483.500	15.46	31.43	46.89	54.00	-7.11	AVG

Remarks:

- Factor (dB/m) = Antenna Factor (dB/m)+Cable Factor (dB)-Pre-amplifier Factor
- Margin value = Level -Limit value



Ant. Pol.	Vertical
Test Mode:	GFSK Mode 2480MHz

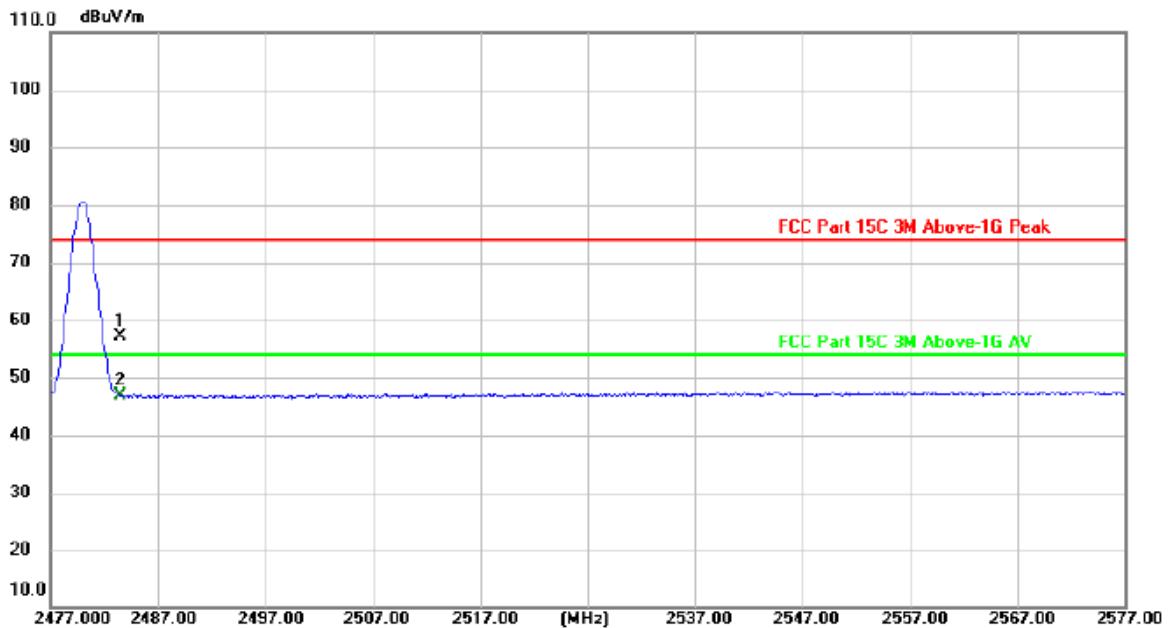

No.	Frequency (MHz)	Reading (dBuV)	Factor (dB/m)	Level (dBuV/m)	Limit (dBuV/m)	Margin (dB)	Detector
1	2483.500	25.65	31.43	57.08	74.00	-16.92	peak
2 *	2483.500	15.43	31.43	46.86	54.00	-7.14	AVG

Remarks:

- Factor (dB/m) = Antenna Factor (dB/m)+Cable Factor (dB)-Pre-amplifier Factor
- Margin value = Level -Limit value





Ant. Pol.	Horizontal
Test Mode:	$\pi/4$ -DQPSK Mode 2402MHz

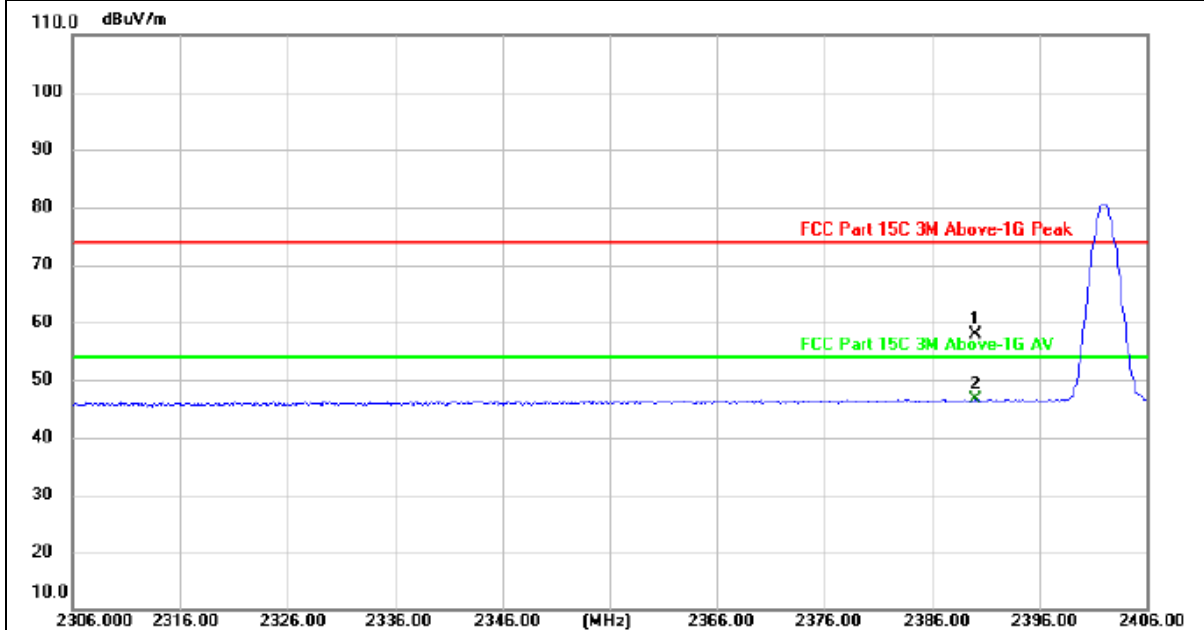

No.	Frequency (MHz)	Reading (dBuV)	Factor (dB/m)	Level (dBuV/m)	Limit (dBuV/m)	Margin (dB)	Detector
1	2390.000	26.88	31.08	57.96	74.00	-16.04	peak
2 *	2390.000	15.50	31.08	46.58	54.00	-7.42	AVG

Remarks:

- Factor (dB/m) = Antenna Factor (dB/m)+Cable Factor (dB)-Pre-amplifier Factor
- Margin value = Level -Limit value



Ant. Pol.	Vertical
Test Mode:	$\pi/4$ -DQPSK Mode 2402MHz

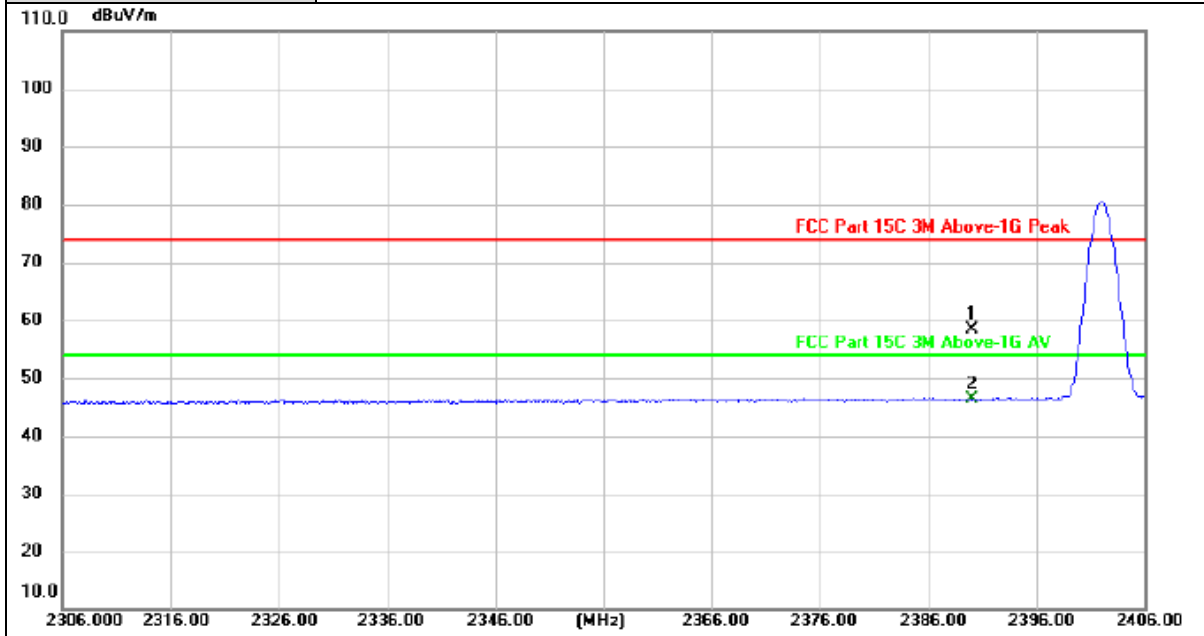

No.	Frequency (MHz)	Reading (dBuV)	Factor (dB/m)	Level (dBuV/m)	Limit (dBuV/m)	Margin (dB)	Detector
1	2390.000	27.30	31.08	58.38	74.00	-15.62	peak
2 *	2390.000	15.26	31.08	46.34	54.00	-7.66	AVG

Remarks:  
 1. Factor (dB/m) = Antenna Factor (dB/m)+Cable Factor (dB)-Pre-amplifier Factor  
 2. Margin value = Level -Limit value



Ant. Pol.	Horizontal
Test Mode:	$\pi/4$ -DQPSK Mode 2480MHz

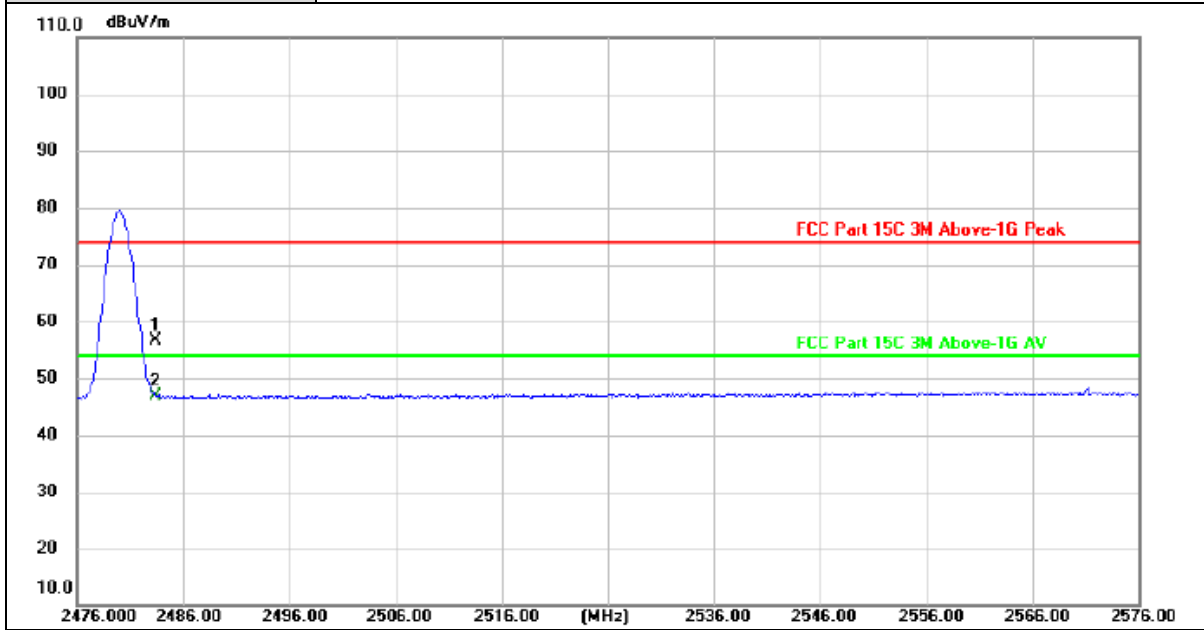

No.	Frequency (MHz)	Reading (dBuV)	Factor (dB/m)	Level (dBuV/m)	Limit (dBuV/m)	Margin (dB)	Detector
1	2483.500	25.20	31.43	56.63	74.00	-17.37	peak
2 *	2483.500	15.45	31.43	46.88	54.00	-7.12	AVG

Remarks:  
 1. Factor (dB/m) = Antenna Factor (dB/m)+Cable Factor (dB)-Pre-amplifier Factor  
 2. Margin value = Level -Limit value



Ant. Pol.	Vertical
Test Mode:	$\pi/4$ -DQPSK Mode 2480MHz

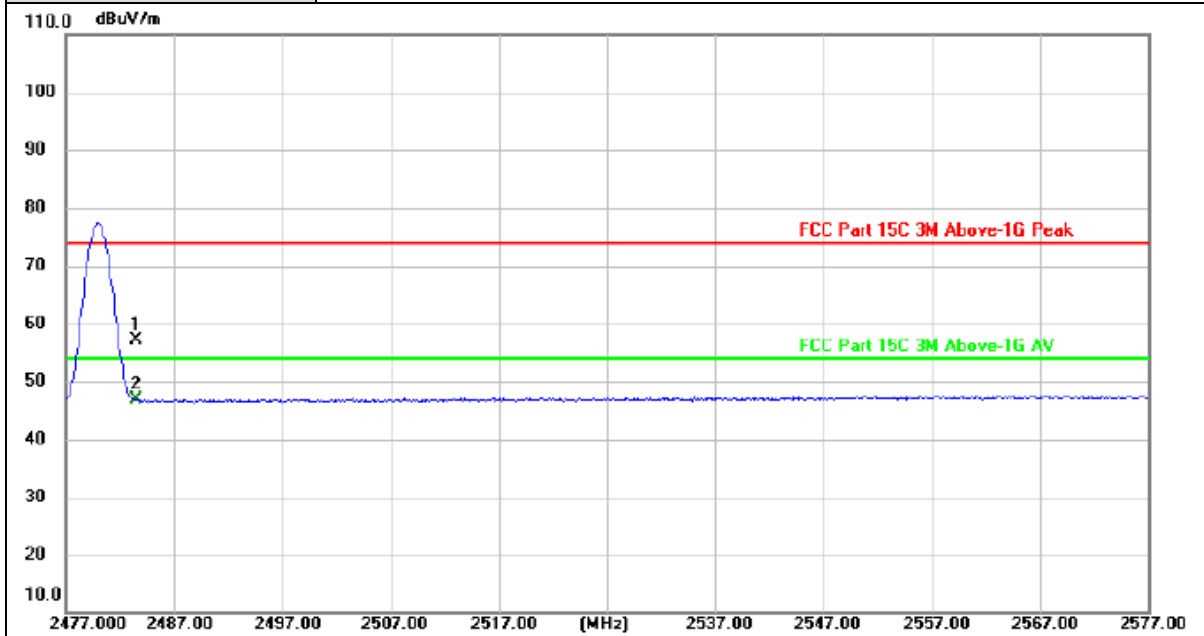

No.	Frequency (MHz)	Reading (dBuV)	Factor (dB/m)	Level (dBuV/m)	Limit (dBuV/m)	Margin (dB)	Detector
1	2483.500	25.65	31.43	57.08	74.00	-16.92	peak
2 *	2483.500	15.38	31.43	46.81	54.00	-7.19	AVG

Remarks:

1. Factor (dB/m) = Antenna Factor (dB/m)+Cable Factor (dB)-Pre-amplifier Factor
2. Margin value = Level -Limit value



<b>Ant. Pol.</b>	Horizontal
<b>Test Mode:</b>	8-DPSK Mode 2402MHz

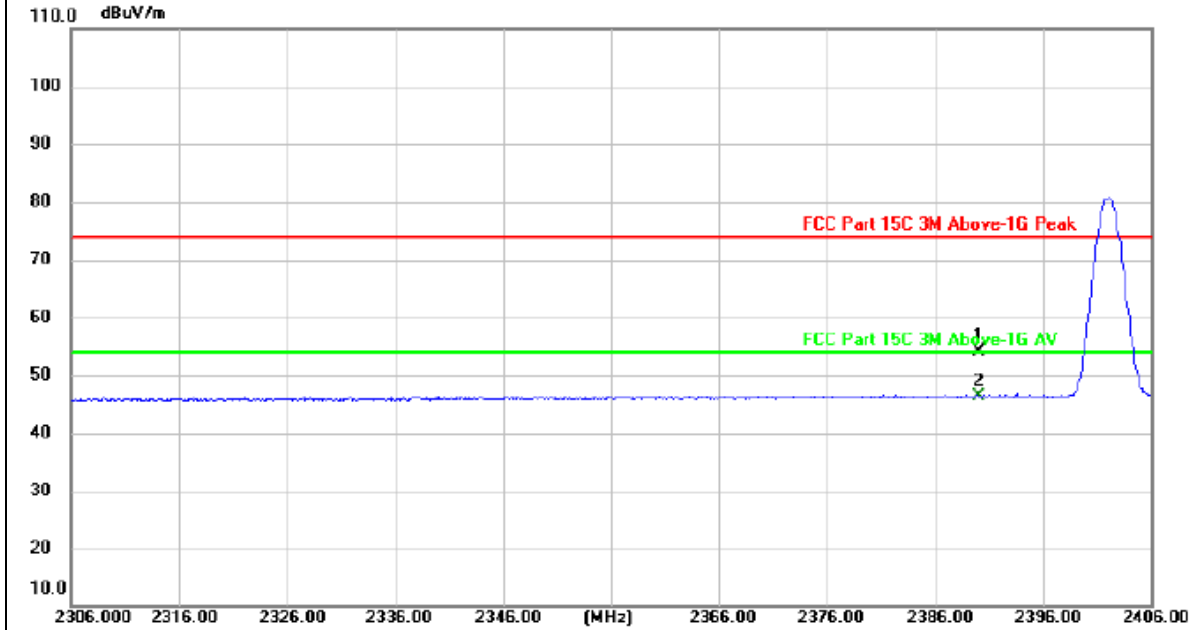

No.	Frequency (MHz)	Reading (dBuV)	Factor (dB/m)	Level (dBuV/m)	Limit (dBuV/m)	Margin (dB)	Detector
1	2390.000	23.07	31.08	54.15	74.00	-19.85	peak
2 *	2390.000	15.27	31.08	46.35	54.00	-7.65	AVG

Remarks:  
 1. Factor (dB/m) = Antenna Factor (dB/m)+Cable Factor (dB)-Pre-amplifier Factor  
 2. Margin value = Level -Limit value



Ant. Pol.	Vertical
Test Mode:	8-DPSK Mode 2402MHz

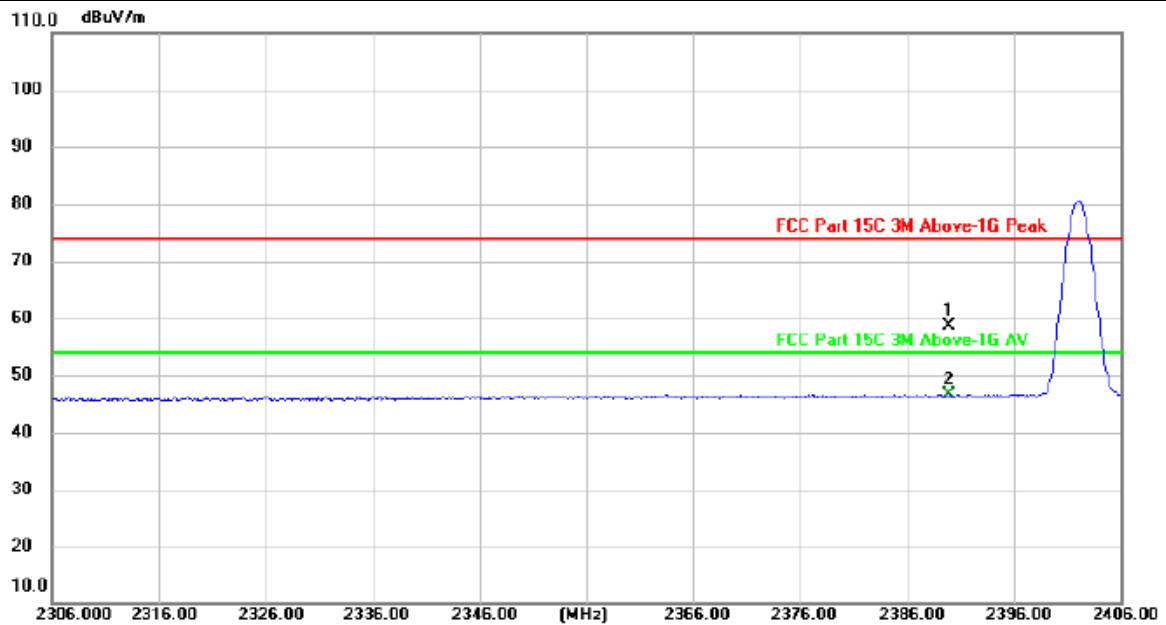

No.	Frequency (MHz)	Reading (dBuV)	Factor (dB/m)	Level (dBuV/m)	Limit (dBuV/m)	Margin (dB)	Detector
1	2390.000	27.50	31.08	58.58	74.00	-15.42	peak
2 *	2390.000	15.43	31.08	46.51	54.00	-7.49	AVG

Remarks:

- 1. Factor (dB/m) = Antenna Factor (dB/m)+Cable Factor (dB)-Pre-amplifier Factor
- 2. Margin value = Level -Limit value



Ant. Pol.	Horizontal
Test Mode:	8-DPSK Mode 2480MHz

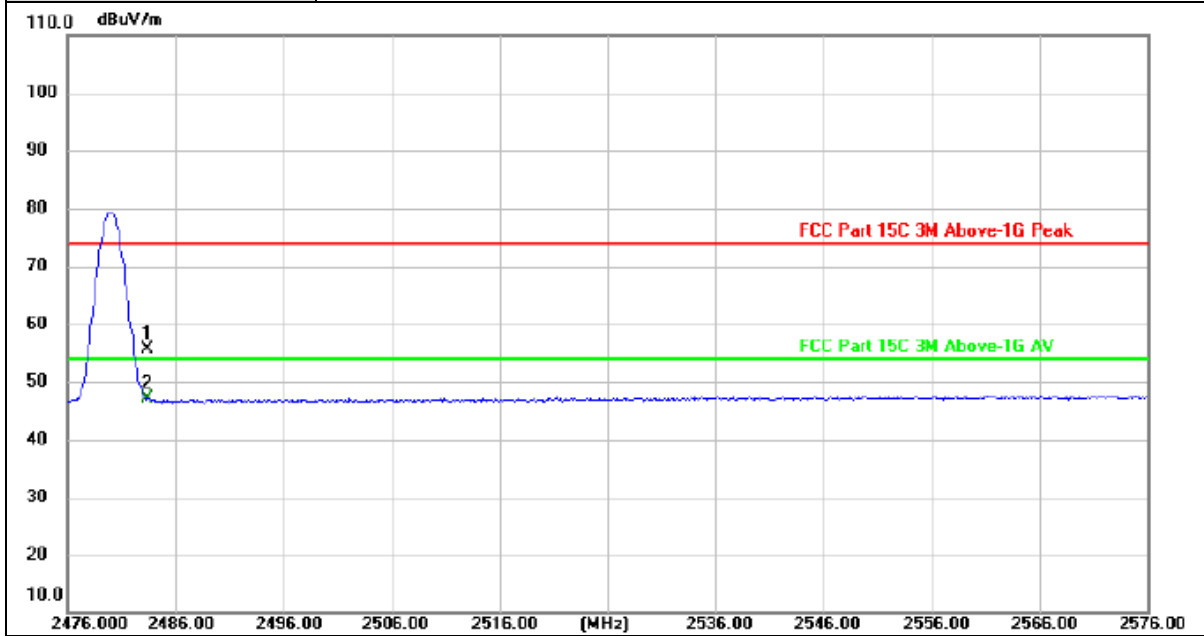

No.	Frequency (MHz)	Reading (dBuV)	Factor (dB/m)	Level (dBuV/m)	Limit (dBuV/m)	Margin (dB)	Detector
1	2483.500	24.11	31.43	55.54	74.00	-18.46	peak
2 *	2483.500	15.61	31.43	47.04	54.00	-6.96	AVG

Remarks:  
 1.Factor (dB/m) = Antenna Factor (dB/m)+Cable Factor (dB)-Pre-amplifier Factor  
 2.Margin value = Level -Limit value



Ant. Pol.	Vertical
Test Mode:	8-DPSK Mode 2480MHz

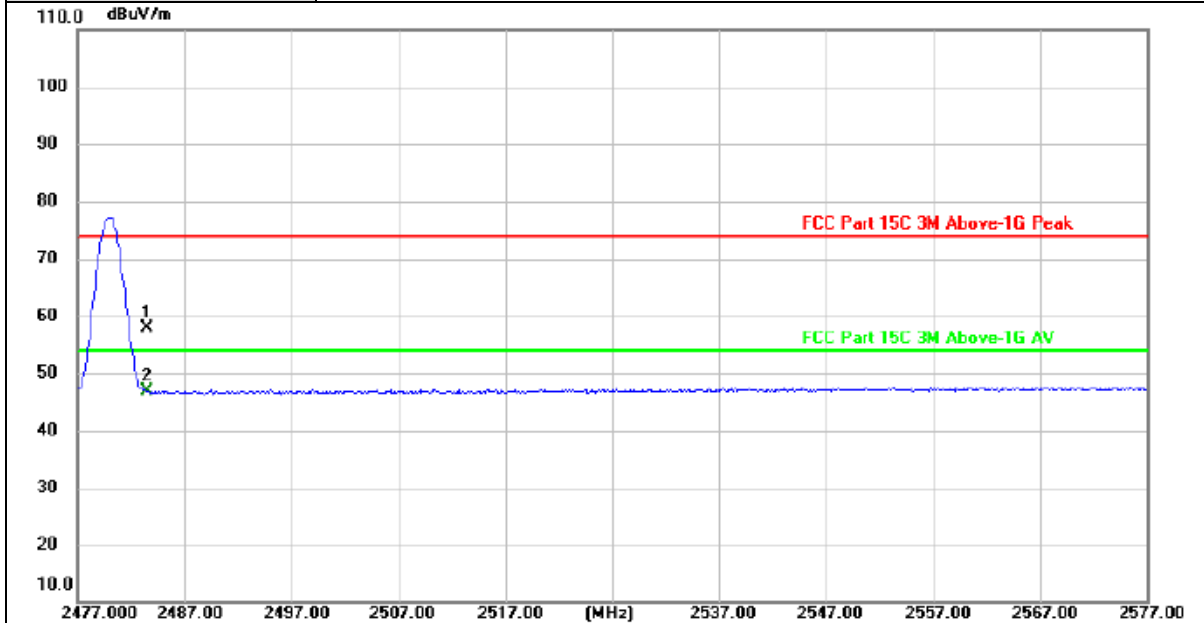

No.	Frequency (MHz)	Reading (dBuV)	Factor (dB/m)	Level (dBuV/m)	Limit (dBuV/m)	Margin (dB)	Detector
1	2483.500	26.50	31.43	57.93	74.00	-16.07	peak
2 *	2483.500	15.50	31.43	46.93	54.00	-7.07	AVG

Remarks:  
 1. Factor (dB/m) = Antenna Factor (dB/m)+Cable Factor (dB)-Pre-amplifier Factor  
 2. Margin value = Level -Limit value





### 3.4. Band Edge and Spurious Emissions (Conducted)

#### Limit

#### **FCC CFR Title 47 Part 15 Subpart C Section 15.247 (d) / RSS-247 5.5**

In any 100 kHz bandwidth outside the frequency band in which the spread spectrum intentional radiator is operating, the radio frequency power that is produced by the intentional radiator shall be at least 20 dB below that in the 100 kHz bandwidth within the band that contains the highest level of the desired power, based on either an RF conducted or a radiated measurement, provided the transmitter demonstrates compliance with the peak conducted power limits. If the transmitter complies with the conducted power limits based on the use of RMS averaging over a time interval, as permitted under paragraph (b)(3) of this section, the attenuation required under this paragraph shall be 30 dB instead of 20 dB.

#### Test Configuration

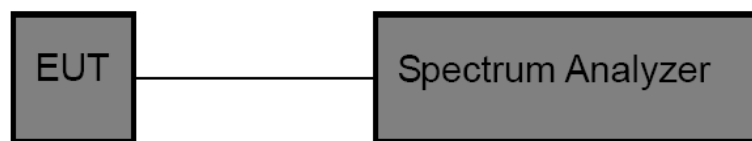

#### Test Procedure

1. The transmitter output was connected to the spectrum analyzer through an attenuator, the path loss was compensated to the results for each measurement.
2. Set to the maximum power setting and enable the EUT transmit continuously.
3. Use the following spectrum analyzer settings:  
RBW = 100 kHz, VBW ≥ RBW, scan up through 10<sup>th</sup> harmonic.  
Sweep = auto, Detector function = peak, Trace = max hold.
4. Measure and record the results in the test report.

#### Test Mode

Please refer to the clause 2.4.

#### Test Result

#### **Band Edge Conducted Test**

TestMode	Antenna	ChName	Freq(MHz)	RefLevel [dBm]	Result [dBm]	Limit [dBm]	Verdict
DH5	Ant1	Low	2402	4.21	-57.3	≤-15.79	PASS
		High	2480	3.55	-58.46	≤-16.46	PASS
		Low	Hop_2402	4.24	-58.51	≤-15.77	PASS
		High	Hop_2480	10.32	-56.03	≤-9.68	PASS
2DH5	Ant1	Low	2402	3.35	-53.23	≤-16.66	PASS
		High	2480	2.03	-57.99	≤-17.97	PASS
		Low	Hop_2402	0.49	-38.14	≤-19.51	PASS
		High	Hop_2480	1.31	-57.87	≤-18.69	PASS
3DH5	Ant1	Low	2402	2.97	-54.08	≤-17.03	PASS

CTC Laboratories, Inc.

Room 101 Building B, No. 7, Lanqing 1st Road, Luhu Community, Guanhu Subdistrict, Longhua District, Shenzhen, Guangdong, China  
Tel.: (86)755-27521059 Fax: (86)755-27521011 Http://www.sz-ctc.org.cn

TRF No: CTC-TR-059\_A1

For anti-fake verification, please visit the official website of China Inspection And Testing Society : [yz.cnca.cn](http://yz.cnca.cn)



	High	2480	8.44	-51.8	≤-11.56	PASS
	Low	Hop_2402	7.00	-48.56	≤-13	PASS
	High	Hop_2480	9.10	-48.39	≤-10.9	PASS

**Conducted Spurious Emissions Test**

TestMode	Antenna	Freq(MHz)	FreqRange [MHz]	RefLevel [dBm]	Result [dBm]	Limit [dBm]	Verdict
DH5	Ant1	2402	Reference	4.51	4.51	---	PASS
			30~1000	4.51	-63.37	≤-15.49	PASS
			1000~26500	4.51	-37.98	≤-15.49	PASS
		2441	Reference	5.08	5.08	---	PASS
			30~1000	5.08	-62.79	≤-14.92	PASS
			1000~26500	5.08	-36.89	≤-14.92	PASS
		2480	Reference	3.45	3.45	---	PASS
			30~1000	3.45	-62.72	≤-16.55	PASS
			1000~26500	3.45	-37.5	≤-16.55	PASS
2DH5	Ant1	2402	Reference	0.00	0.00	---	PASS
			30~1000	0.00	-47.59	≤-20	PASS
			1000~26500	0.00	-37.74	≤-20	PASS
		2441	Reference	3.61	3.61	---	PASS
			30~1000	3.61	-63.13	≤-16.39	PASS
			1000~26500	3.61	-37.65	≤-16.39	PASS
		2480	Reference	-0.32	-0.32	---	PASS
			30~1000	-0.32	-63.09	≤-20.32	PASS
			1000~26500	-0.32	-37.14	≤-20.32	PASS
3DH5	Ant1	2402	Reference	0.45	0.45	---	PASS
			30~1000	0.45	-62.72	≤-19.55	PASS
			1000~26500	0.45	-37.91	≤-19.55	PASS
		2441	Reference	10.11	10.11	---	PASS
			30~1000	10.11	-63.51	≤-9.89	PASS
			1000~26500	10.11	-36.06	≤-9.89	PASS
		2480	Reference	5.64	5.64	---	PASS
			30~1000	5.64	-63.63	≤-14.36	PASS
			1000~26500	5.64	-34.75	≤-14.36	PASS



Band Edge Conducted Test plot as follows:

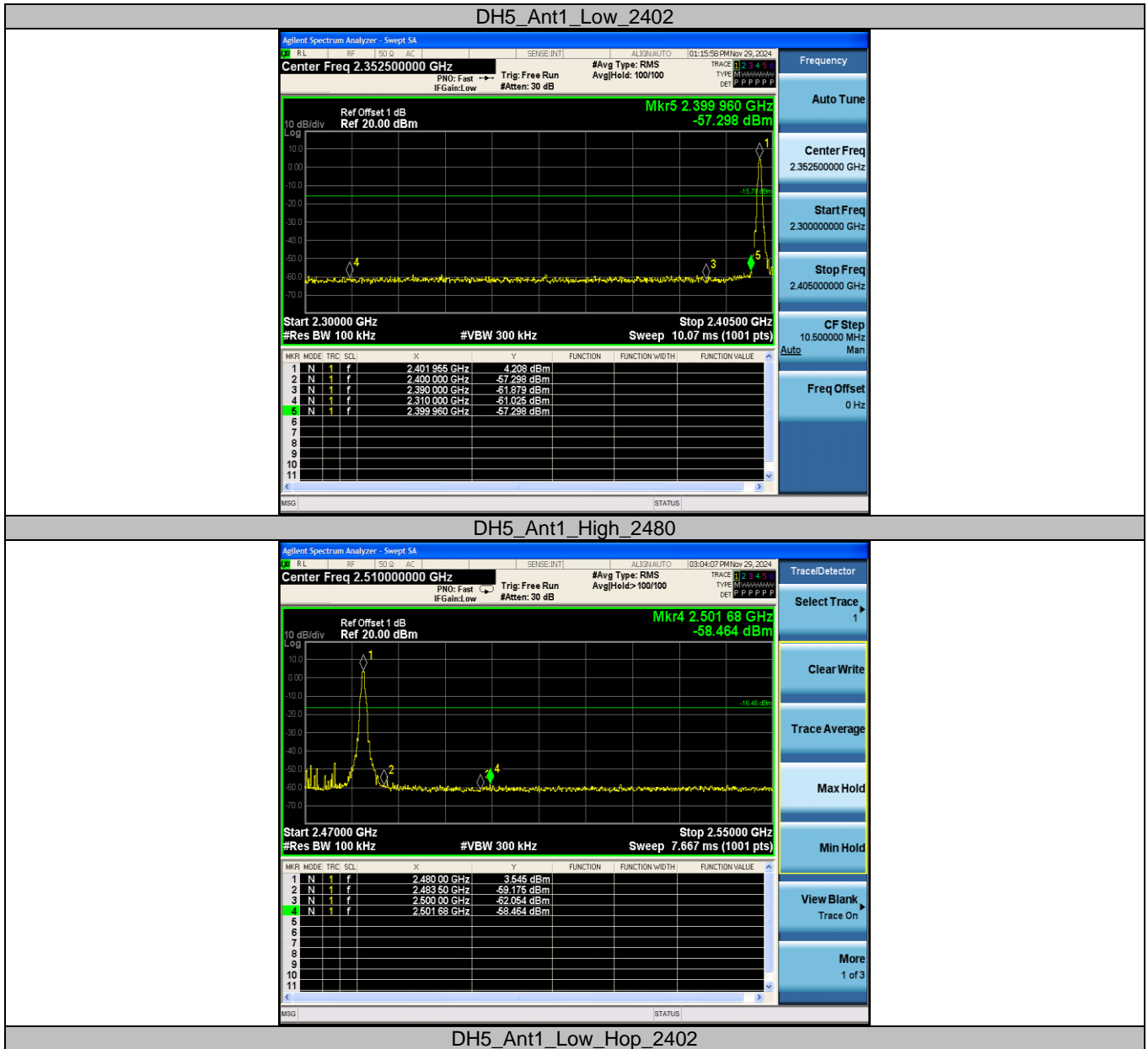

DH5\_Ant1\_Low\_Hop\_2402

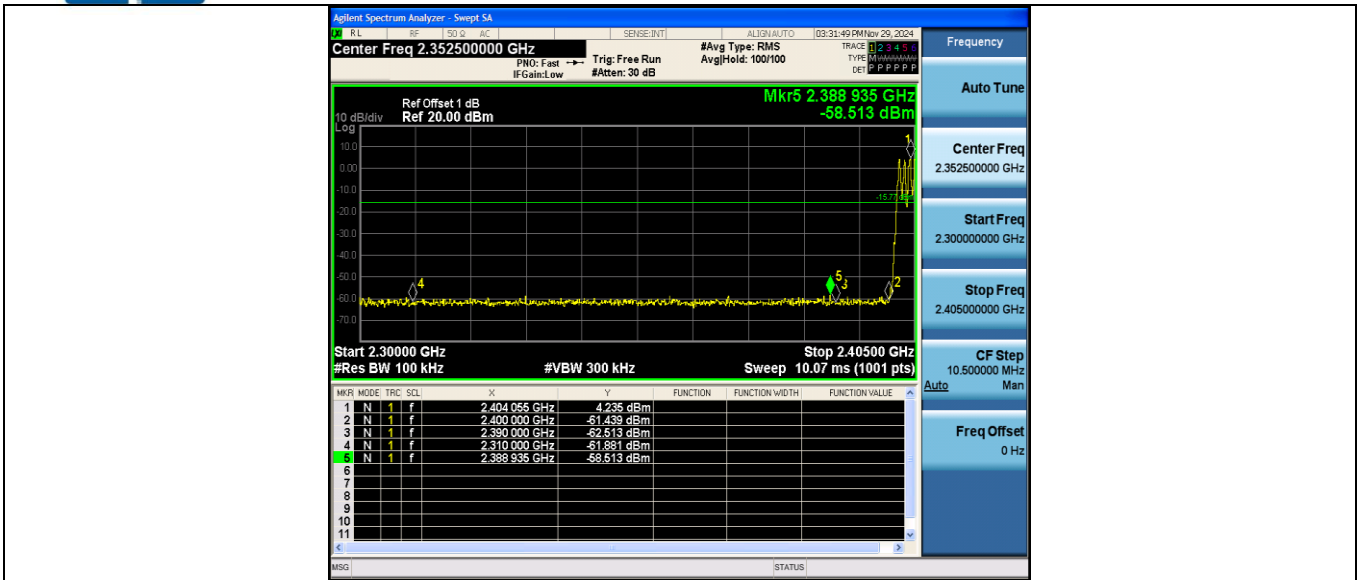

DH5 Ant1 High Hop 2480

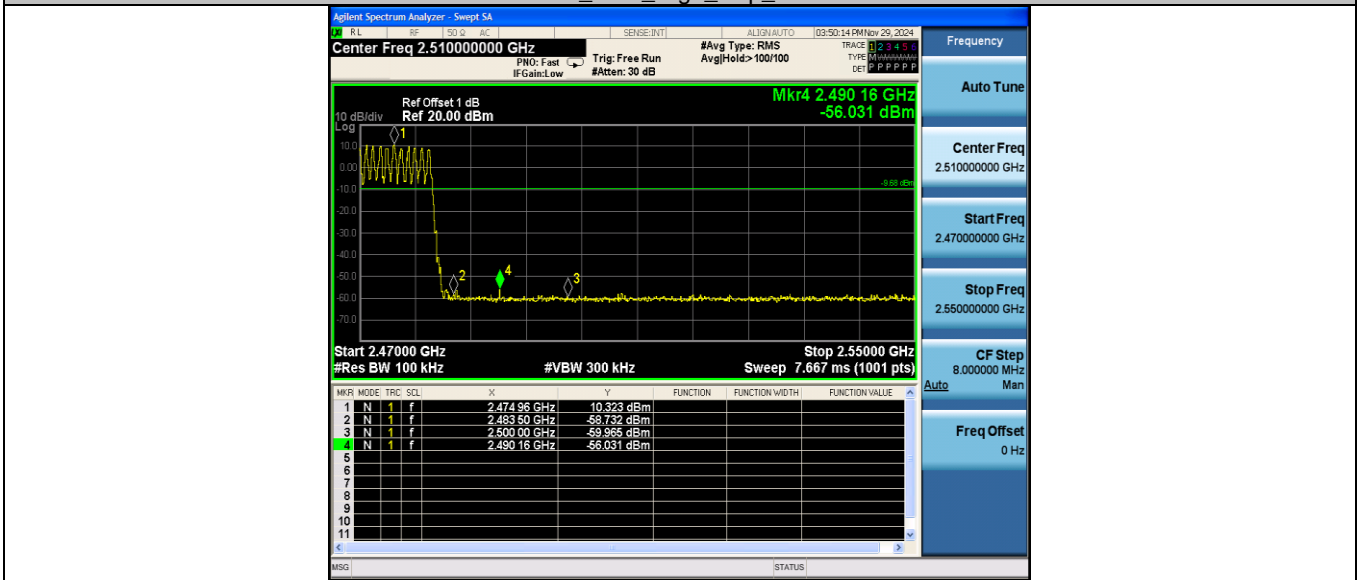

2DH5 Ant1 Low 2402

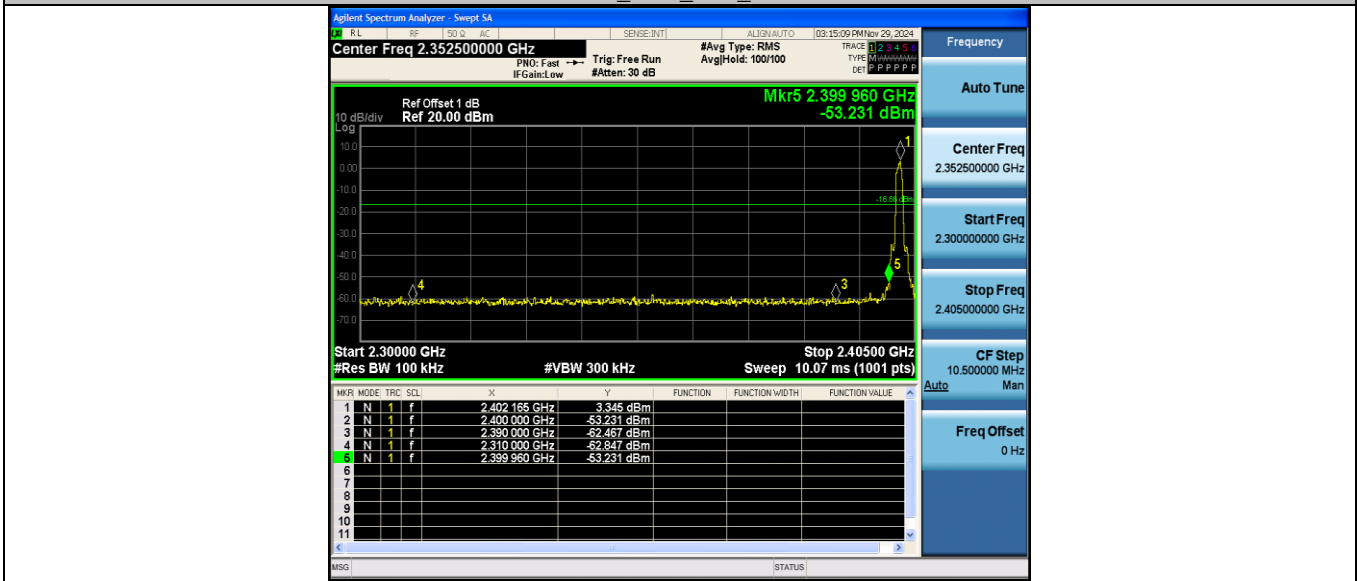

2DH5 Ant1 High 2480

CTC Laboratories, Inc.

Room 101 Building B, No. 7, Lanqing 1st Road, Luhu Community, Guanhu Subdistrict, Longhua District, Shenzhen, Guangdong, China  
Tel.: (86)755-27521059 Fax: (86)755-27521011 Http://www.sz-ctc.org.cn

TRF No: CTC-TR-059\_A1

For anti-fake verification, please visit the official website of China Inspection And Testing Society : [yz.cnca.cn](http://yz.cnca.cn)

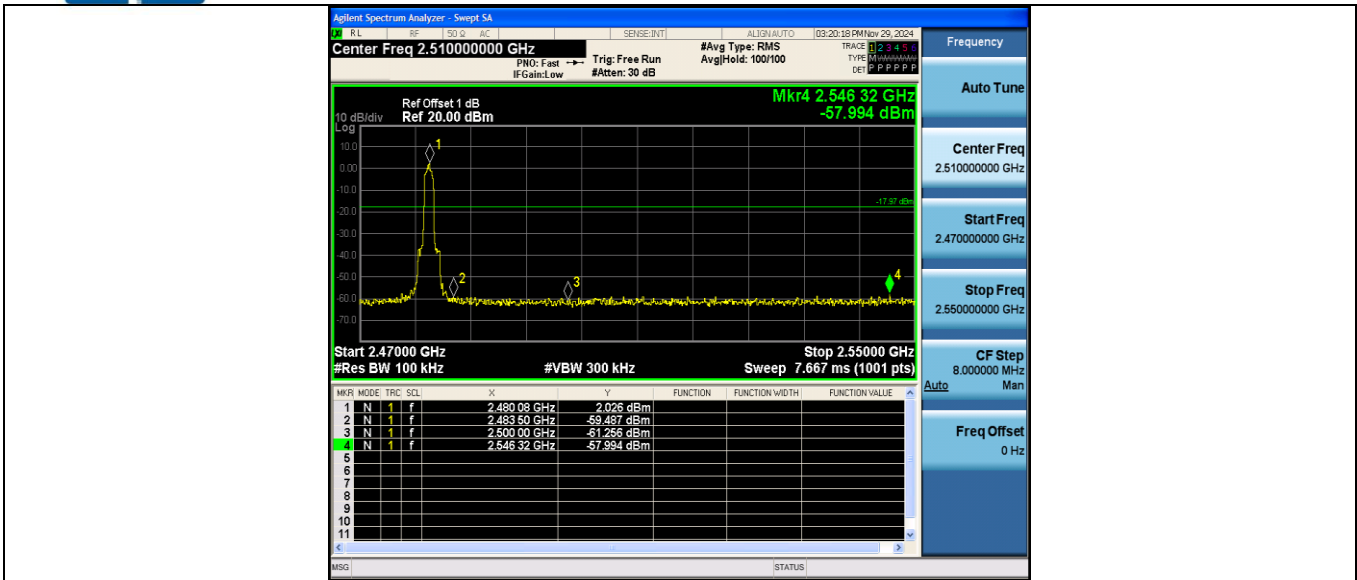

2DH5\_Ant1\_Low\_Hop\_2402

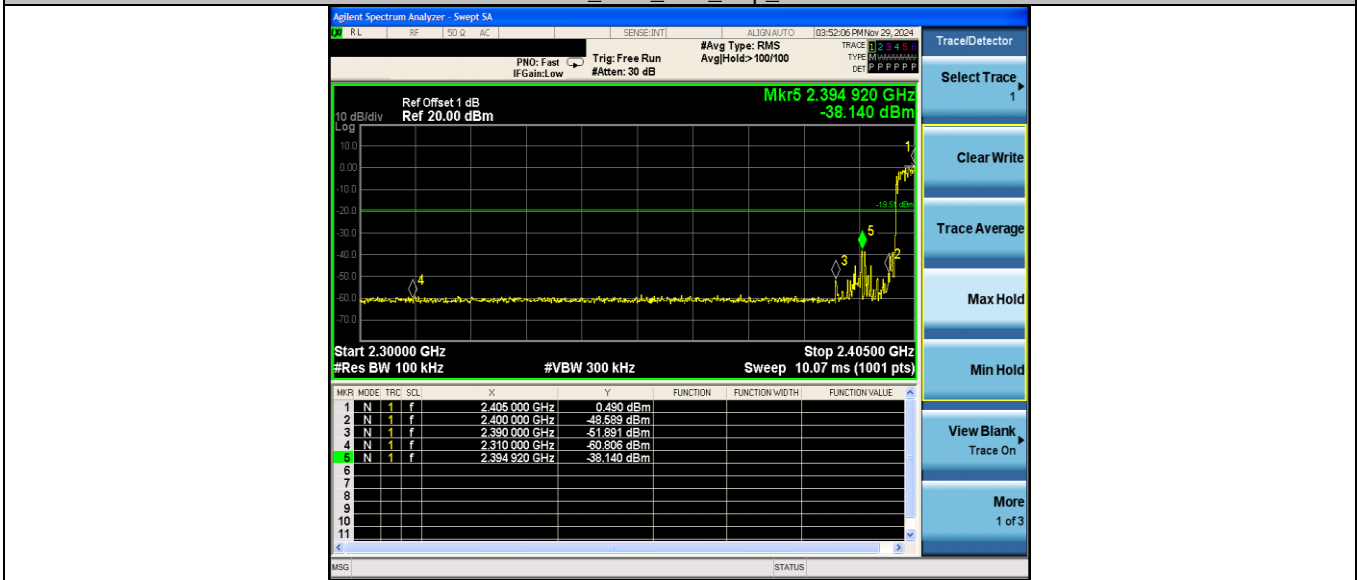

2DH5\_Ant1\_High\_Hop\_2480

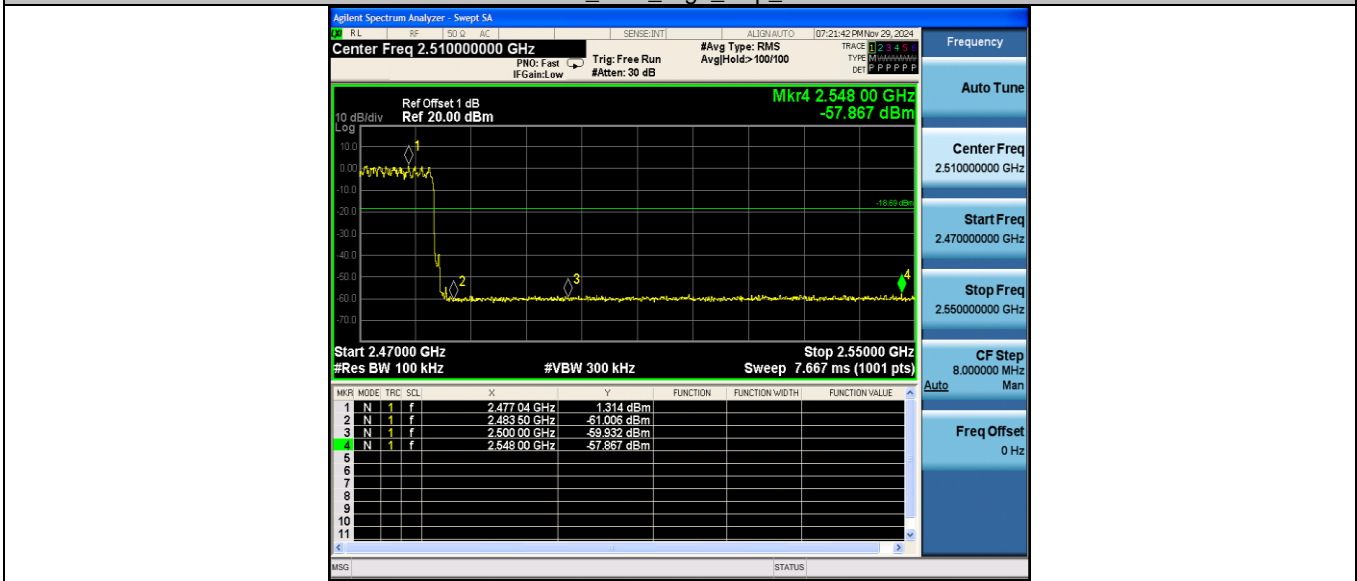

3DH5\_Ant1\_Low\_2402

CTC Laboratories, Inc.

Room 101 Building B, No. 7, Lanqing 1st Road, Luhu Community, Guanhu Subdistrict, Longhua District, Shenzhen, Guangdong, China  
Tel.: (86)755-27521059 Fax: (86)755-27521011 Http://www.sz-ctc.org.cn

TRF No: CTC-TR-059\_A1

For anti-fake verification, please visit the official website of China Inspection And Testing Society : [yz.cnca.cn](http://yz.cnca.cn)

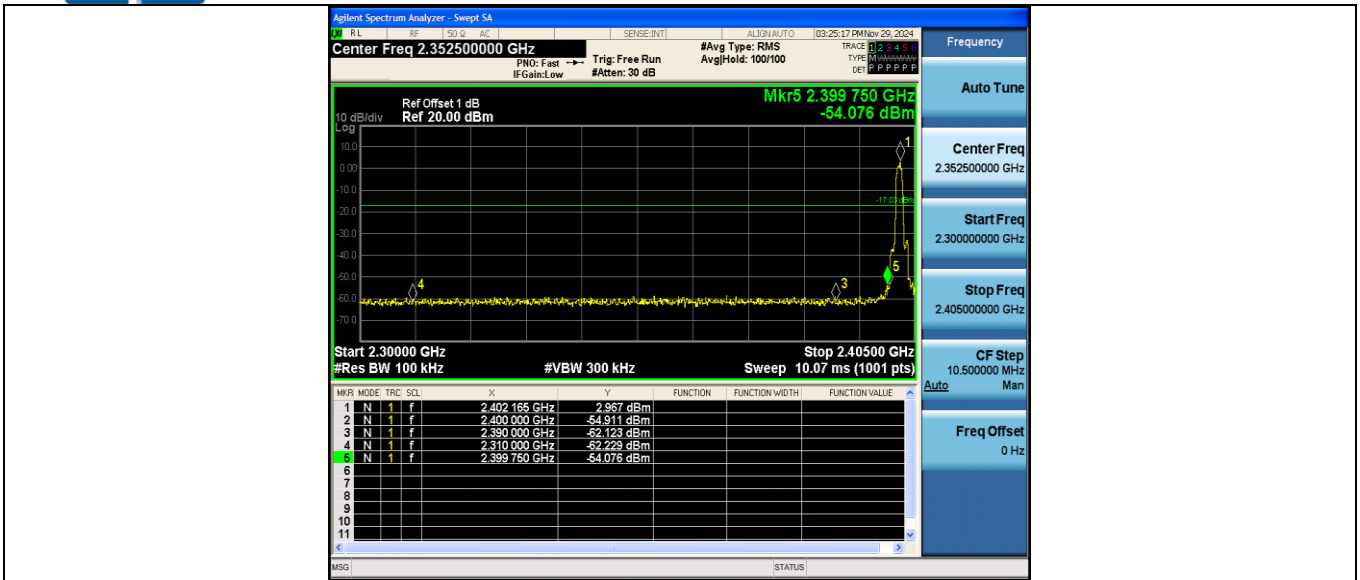

3DH5\_Ant1\_High\_2480

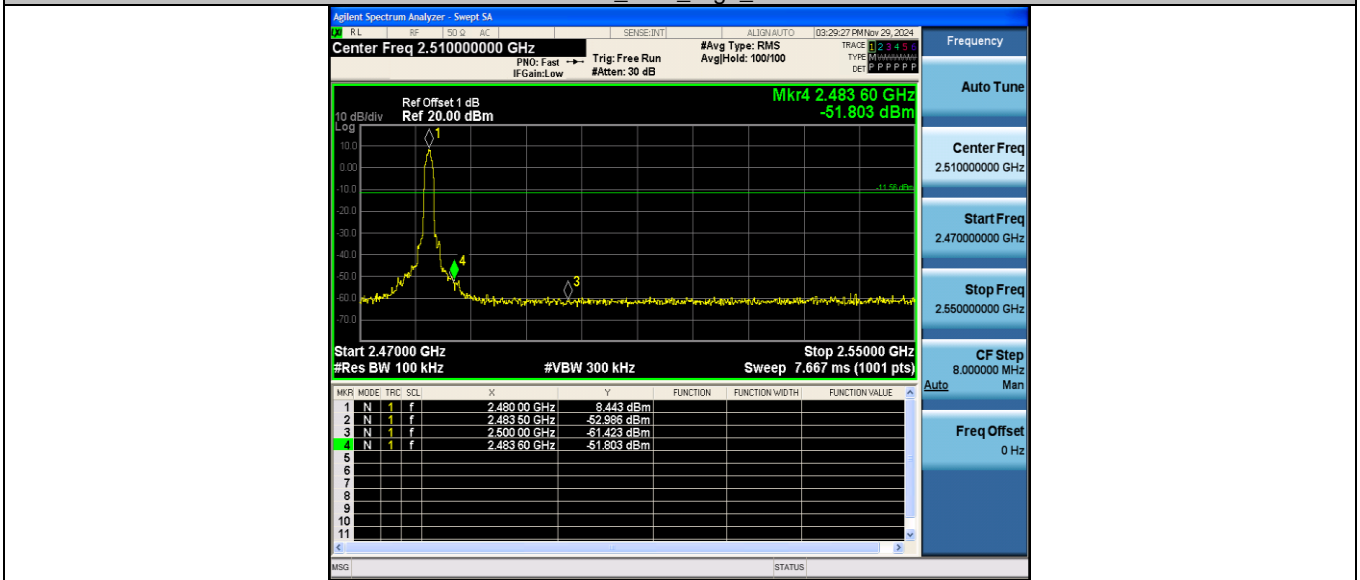

3DH5\_Ant1\_Low\_Hop\_2402

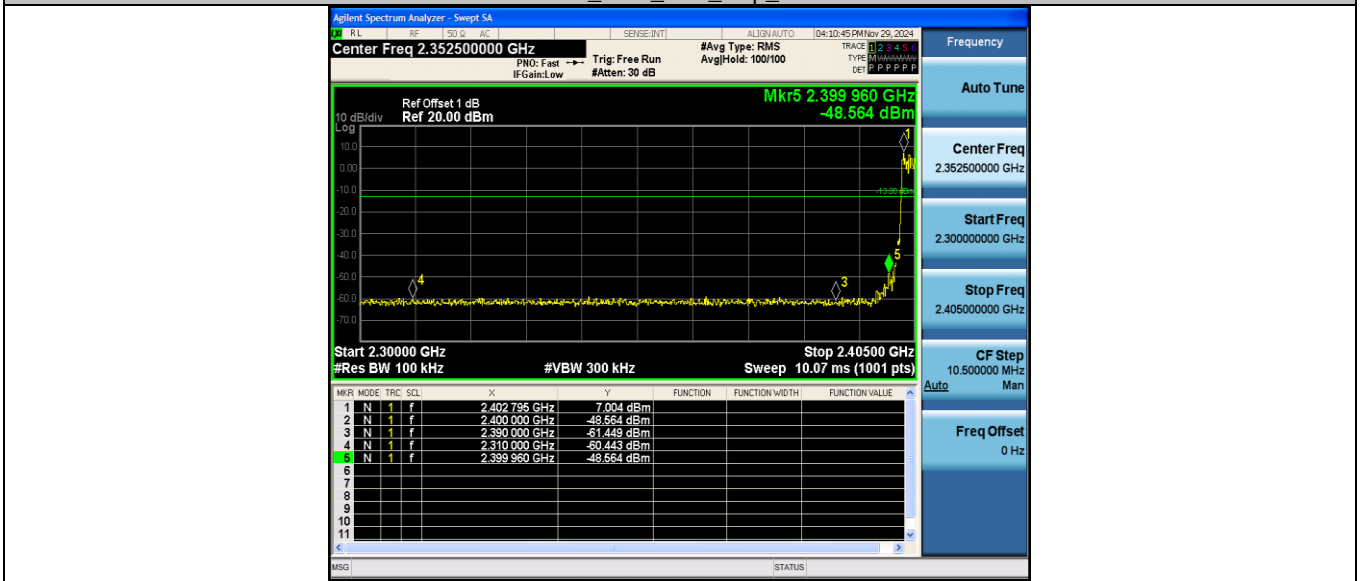

3DH5\_Ant1\_High\_Hop\_2480

CTC Laboratories, Inc.

Room 101 Building B, No. 7, Lanqing 1st Road, Luhu Community, Guanhu Subdistrict, Longhua District, Shenzhen, Guangdong, China  
Tel.: (86)755-27521059 Fax: (86)755-27521011 Http://www.sz-ctc.org.cn

TRF No: CTC-TR-059\_A1

For anti-fake verification, please visit the official website of China Inspection And Testing Society : [yz.cnca.cn](http://yz.cnca.cn)

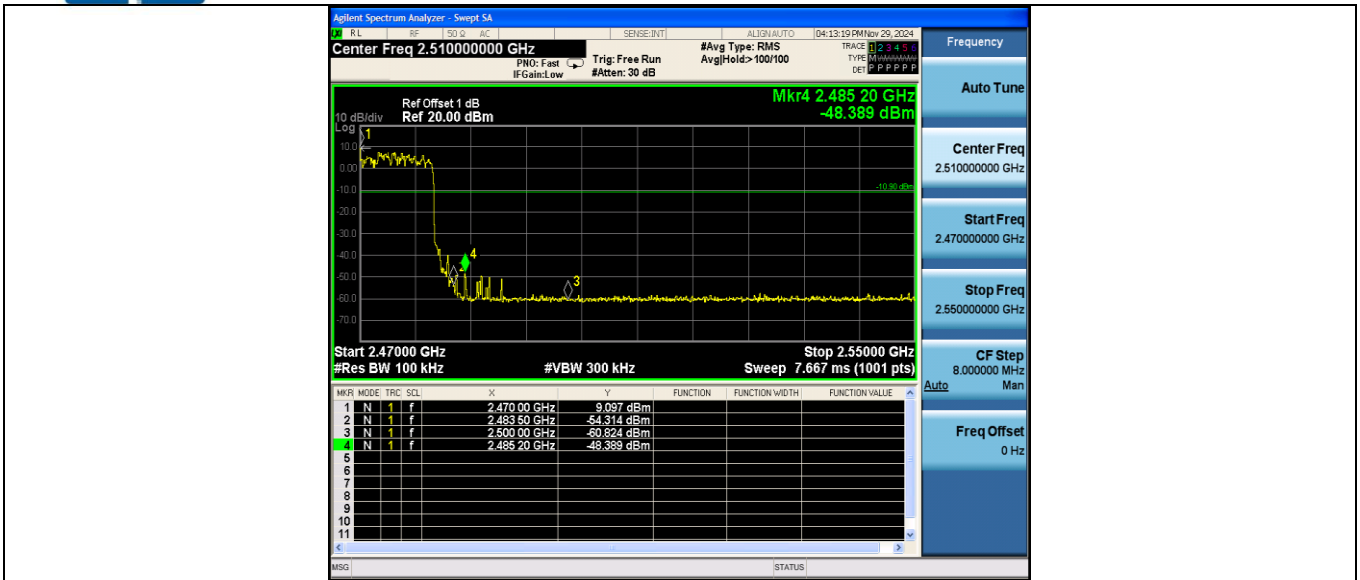

CTC Laboratories, Inc.

Room 101 Building B, No. 7, Lanqing 1st Road, Luhu Community, Guanhu Subdistrict, Longhua District, Shenzhen, Guangdong, China  
Tel.: (86)755-27521059 Fax: (86)755-27521011 Http://www.sz-ctc.org.cn

TRF No: CTC-TR-059\_A1

For anti-fake verification, please visit the official website of China Inspection And Testing Society : [yz.cnca.cn](http://yz.cnca.cn)



Conducted Spurious Emissions Test plot as follows

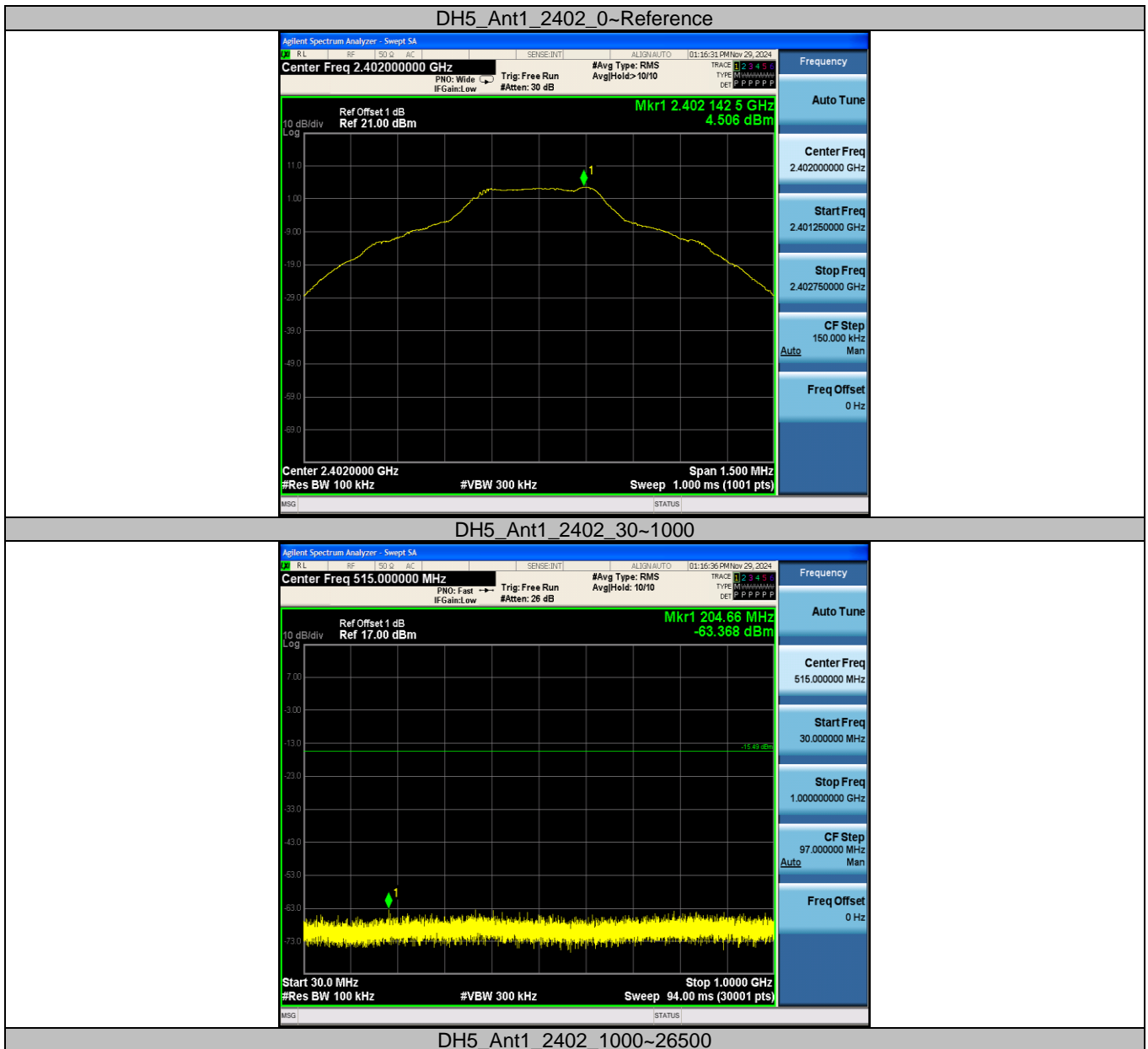



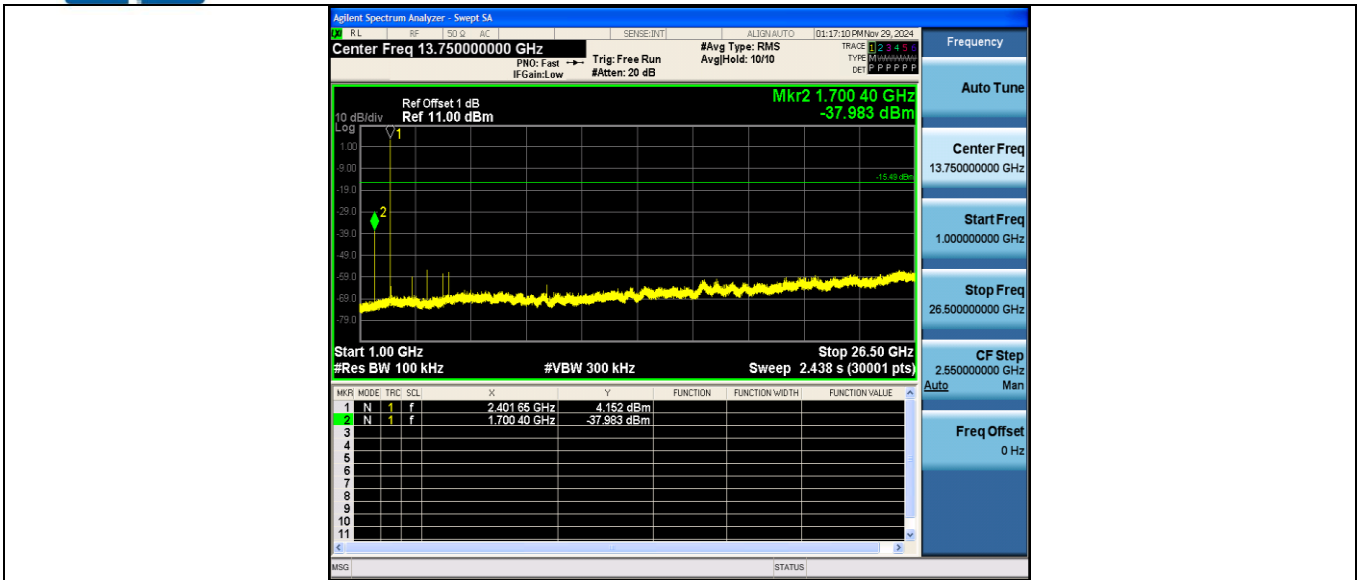

DH5\_Ant1\_2441\_0~Reference

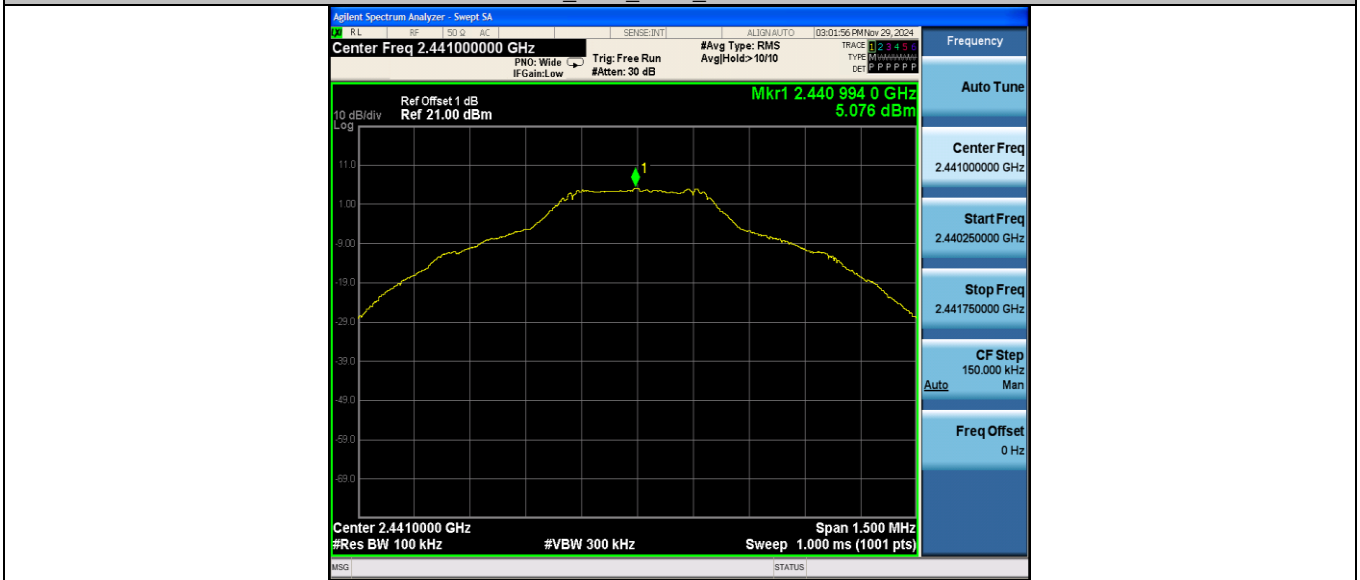

DH5\_Ant1\_2441\_30~1000

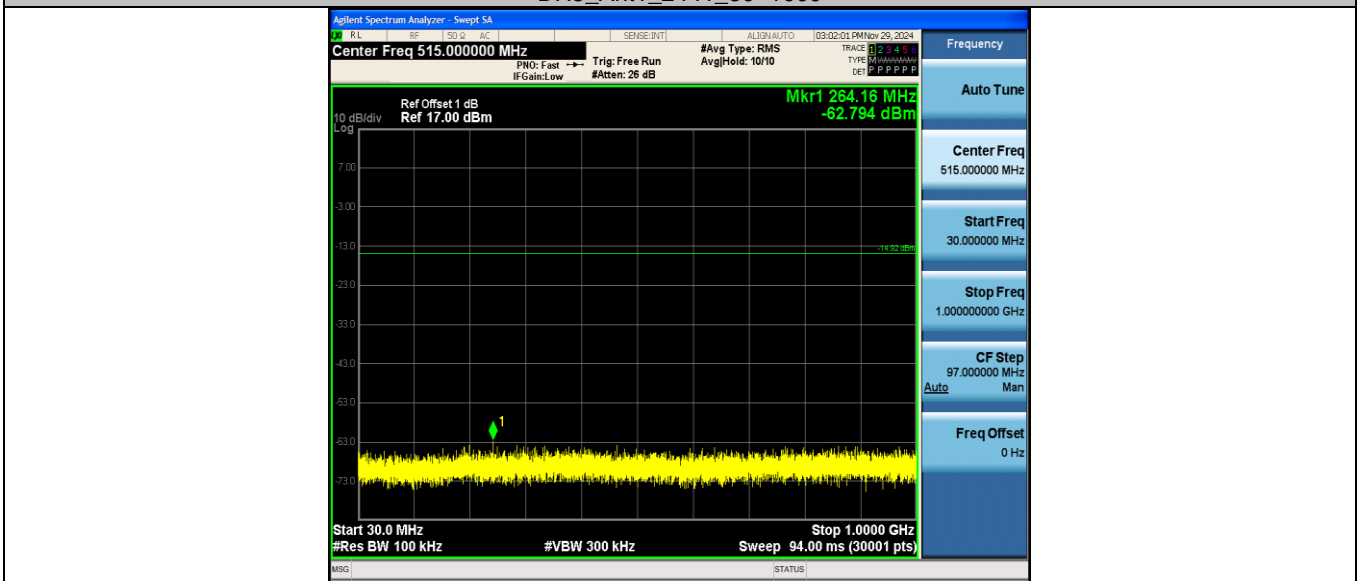

DH5\_Ant1\_2441\_1000~26500

CTC Laboratories, Inc.

Room 101 Building B, No. 7, Lanqing 1st Road, Luhu Community, Guanhu Subdistrict, Longhua District, Shenzhen, Guangdong, China  
Tel.: (86)755-27521059 Fax: (86)755-27521011 Http://www.sz-ctc.org.cn

TRF No: CTC-TR-059\_A1

For anti-fake verification, please visit the official website of China Inspection And Testing Society : [yz.cnca.cn](http://yz.cnca.cn)

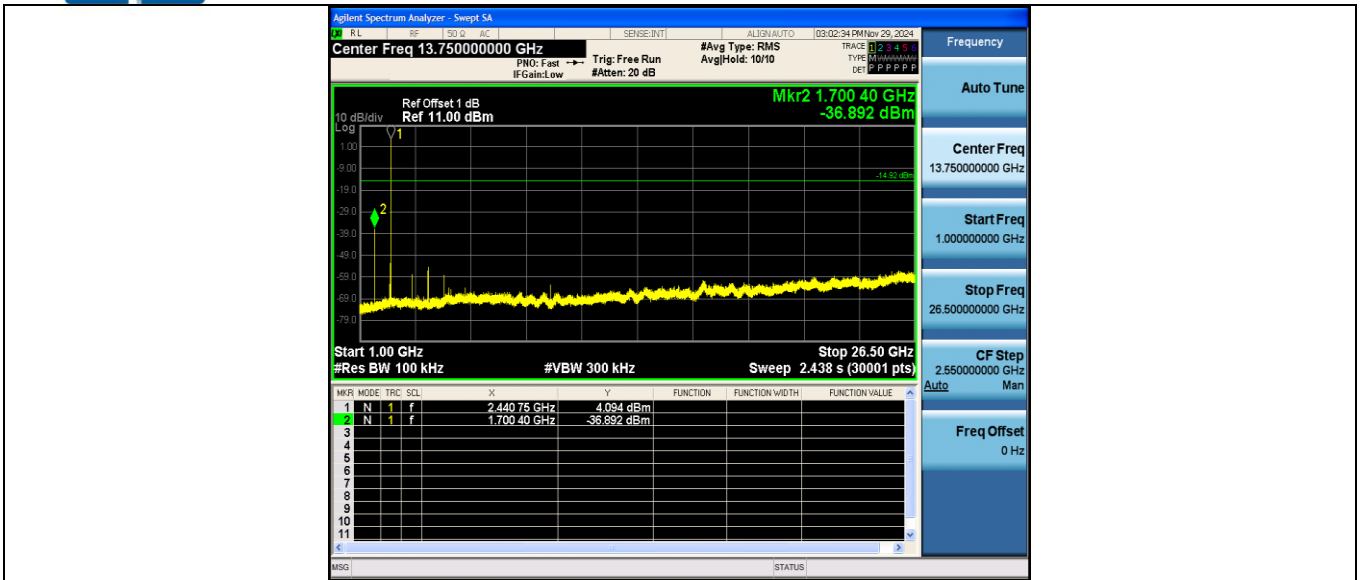

DH5\_Ant1\_2480\_0~Reference

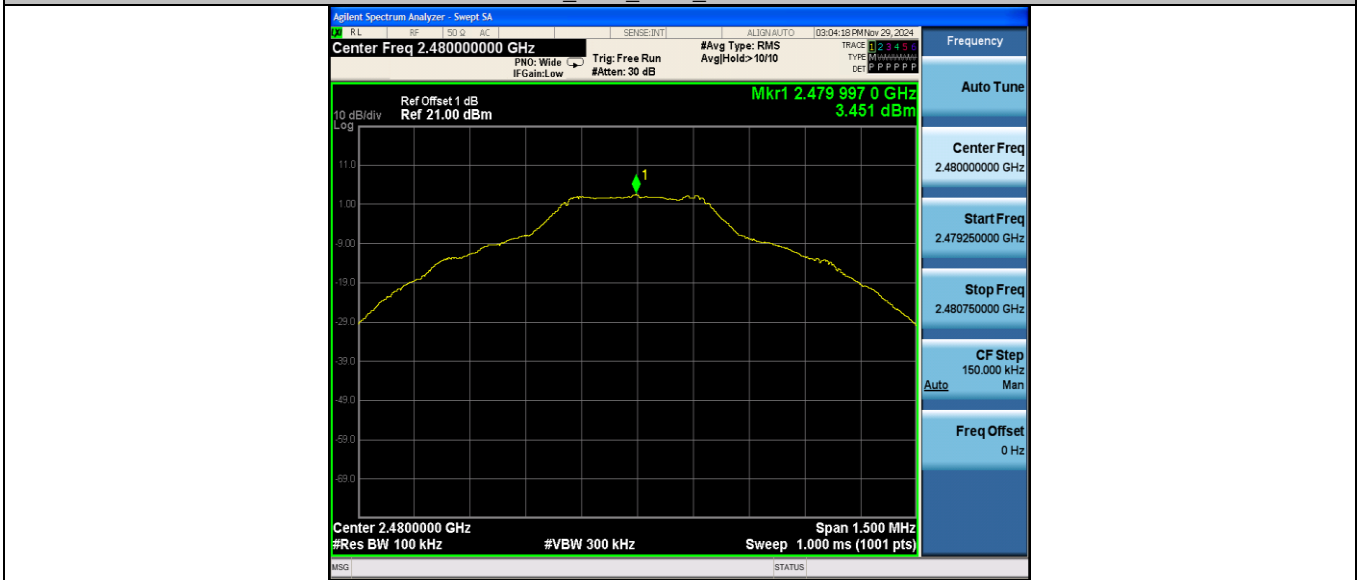

DH5\_Ant1\_2480\_30~1000

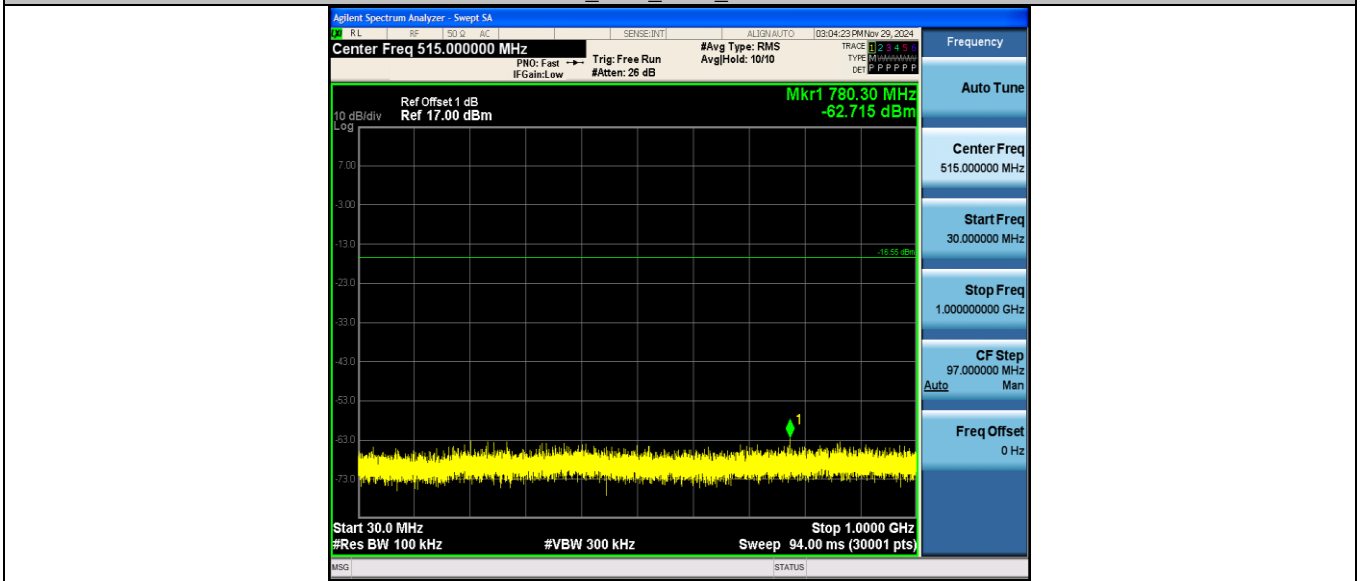

DH5\_Ant1\_2480\_1000~26500

CTC Laboratories, Inc.

Room 101 Building B, No. 7, Lanqing 1st Road, Luhu Community, Guanhu Subdistrict, Longhua District, Shenzhen, Guangdong, China  
Tel.: (86)755-27521059 Fax: (86)755-27521011 Http://www.sz-ctc.org.cn

TRF No: CTC-TR-059\_A1

For anti-fake verification, please visit the official website of China Inspection And Testing Society : [yz.cnca.cn](http://yz.cnca.cn)

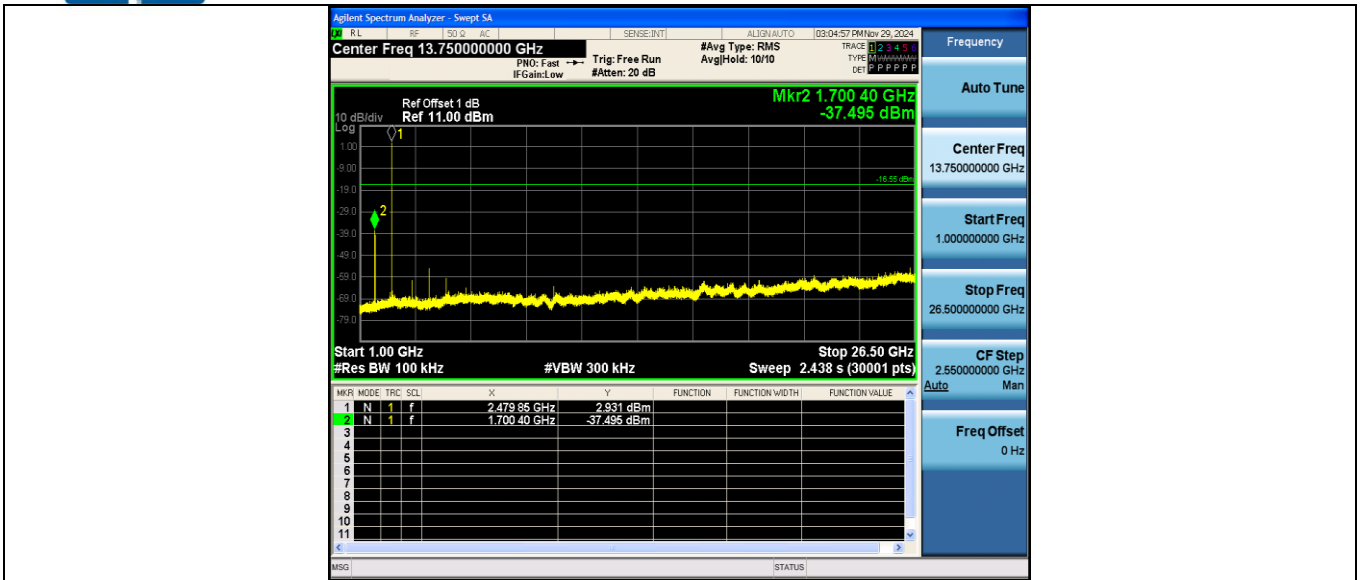

2DH5\_Ant1\_2402\_0~Reference

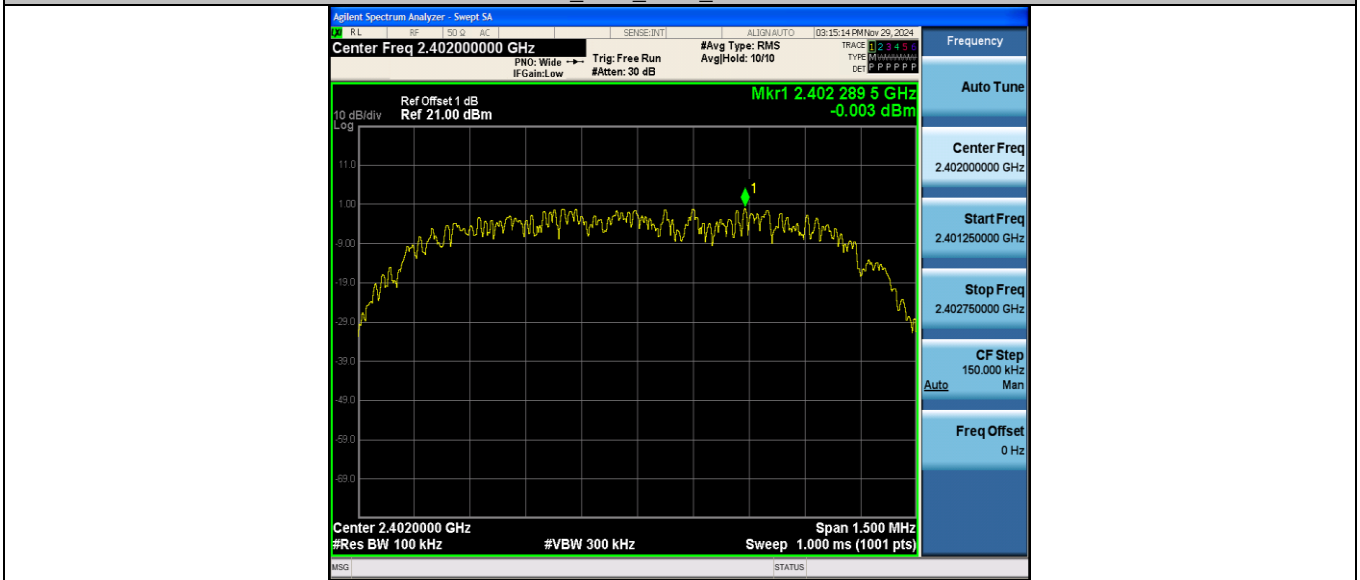

2DH5\_Ant1\_2402\_30~1000

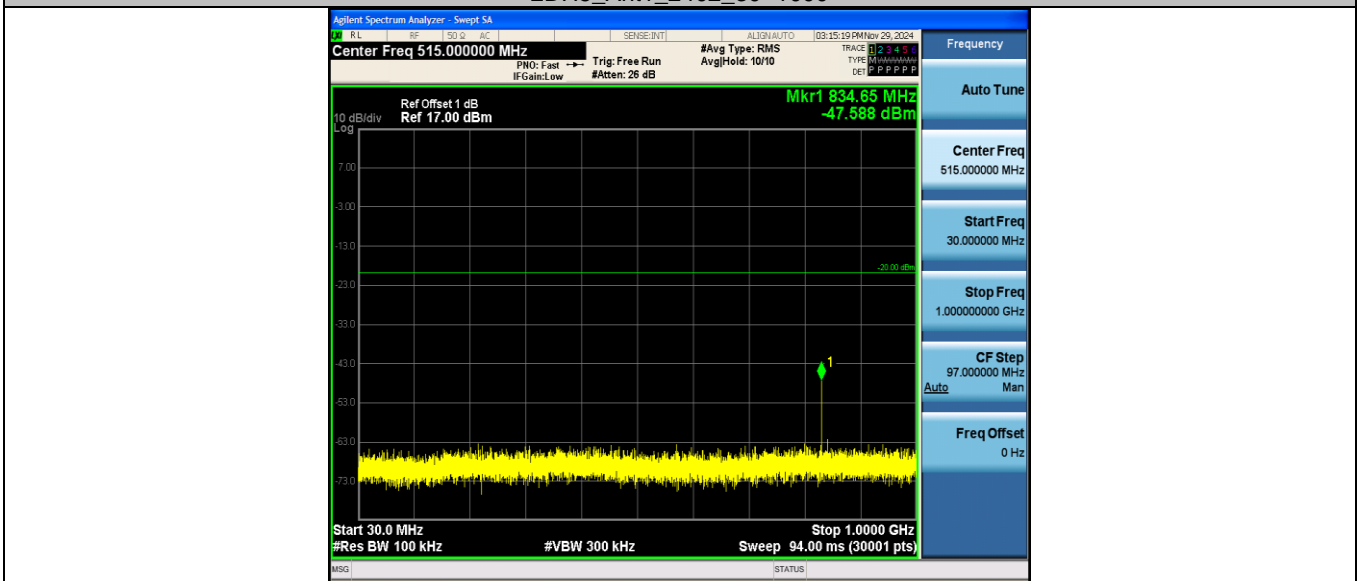

2DH5\_Ant1\_2402\_1000~26500

CTC Laboratories, Inc.

Room 101 Building B, No. 7, Lanqing 1st Road, Luhua Community, Guanhu Subdistrict, Longhua District, Shenzhen, Guangdong, China  
Tel.: (86)755-27521059 Fax: (86)755-27521011 Http://www.sz-ctc.org.cn

TRF No: CTC-TR-059\_A1

For anti-fake verification, please visit the official website of China Inspection And Testing Society : [yz.cnca.cn](http://yz.cnca.cn)

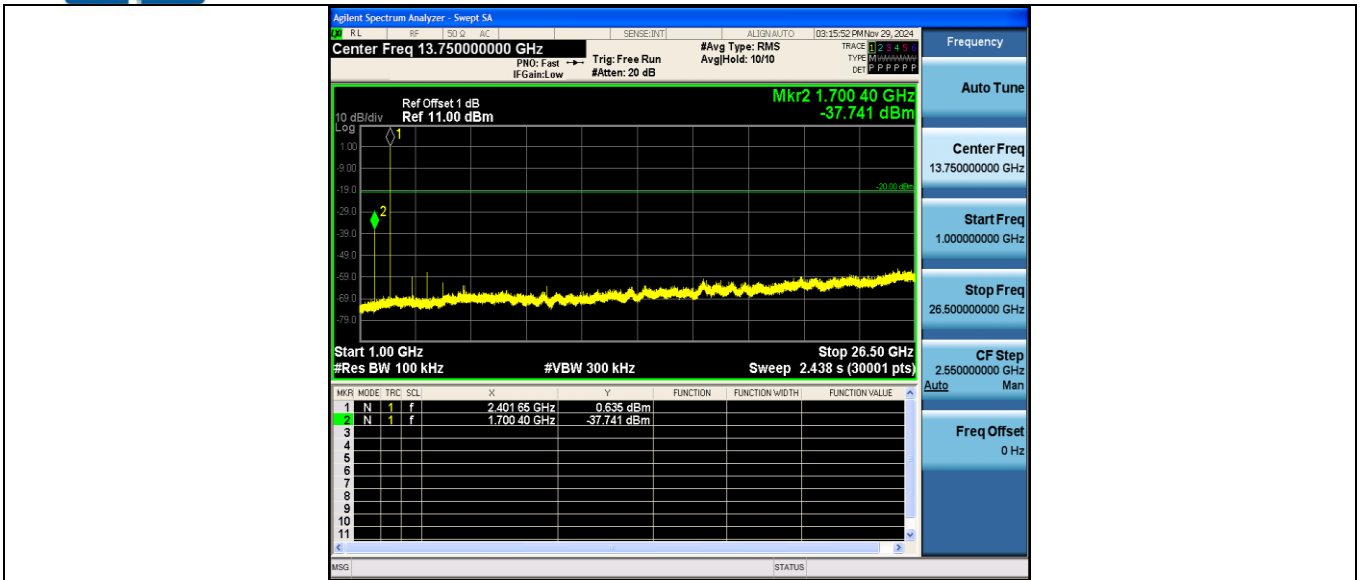

2DH5\_Ant1\_2441\_0~Reference

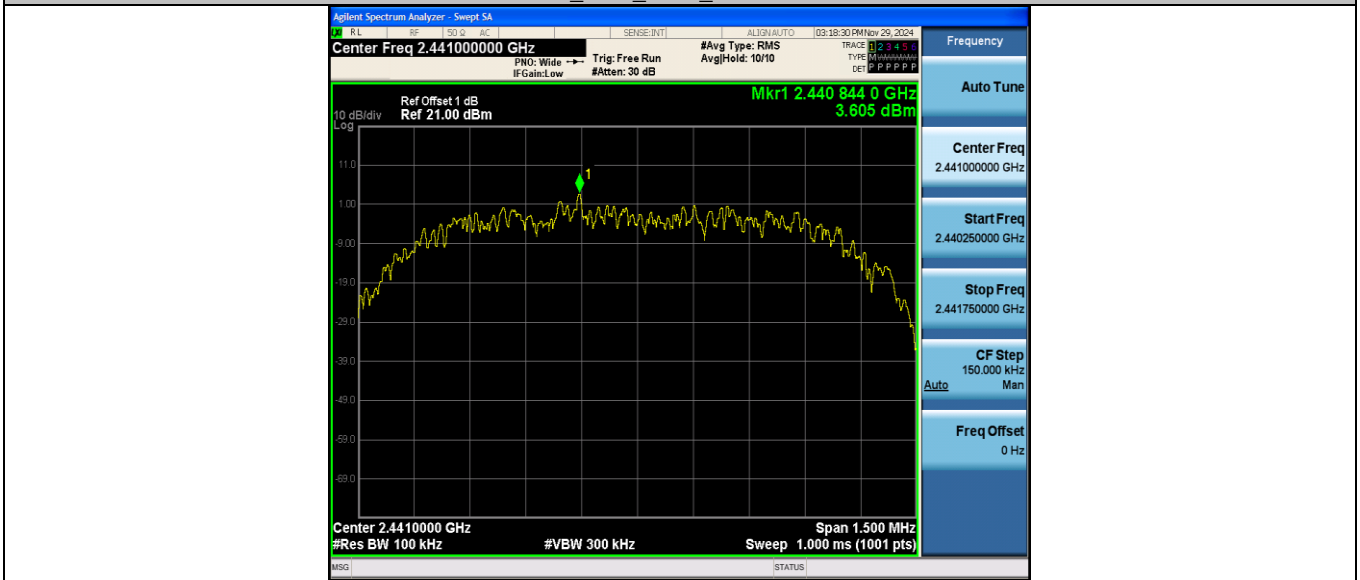

2DH5\_Ant1\_2441\_30~1000

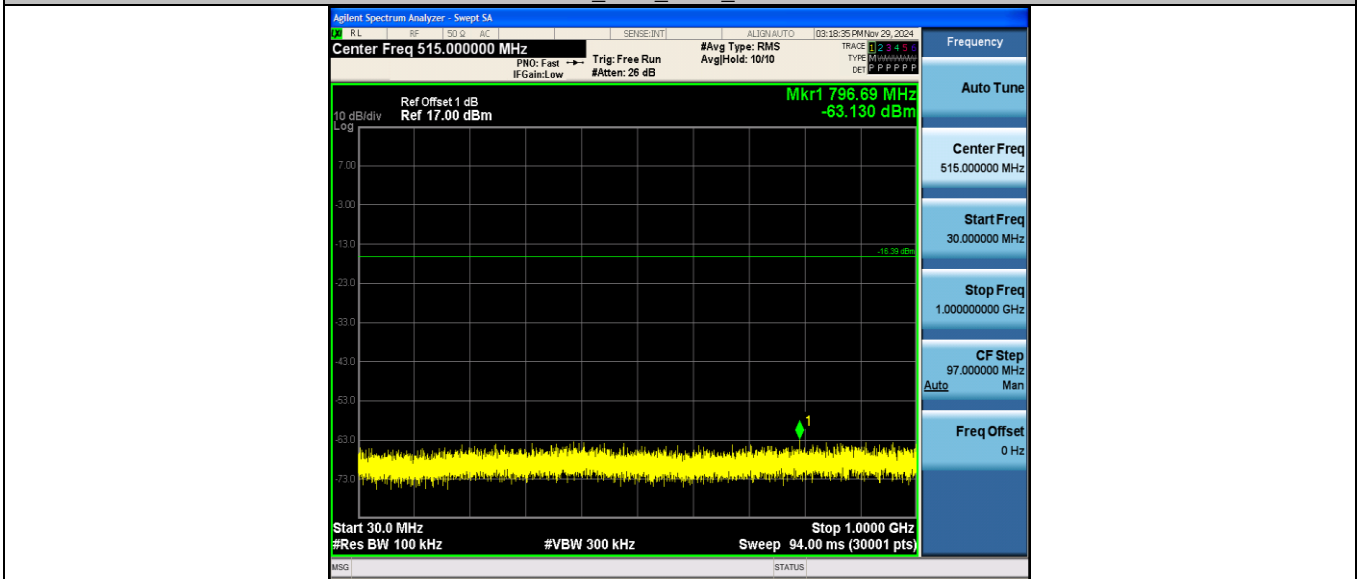

2DH5\_Ant1\_2441\_1000~26500

CTC Laboratories, Inc.

Room 101 Building B, No. 7, Lanqing 1st Road, Luhu Community, Guanhu Subdistrict, Longhua District, Shenzhen, Guangdong, China  
Tel.: (86)755-27521059 Fax: (86)755-27521011 Http://www.sz-ctc.org.cn

TRF No: CTC-TR-059\_A1

For anti-fake verification, please visit the official website of China Inspection And Testing Society : [yz.cnca.cn](http://yz.cnca.cn)

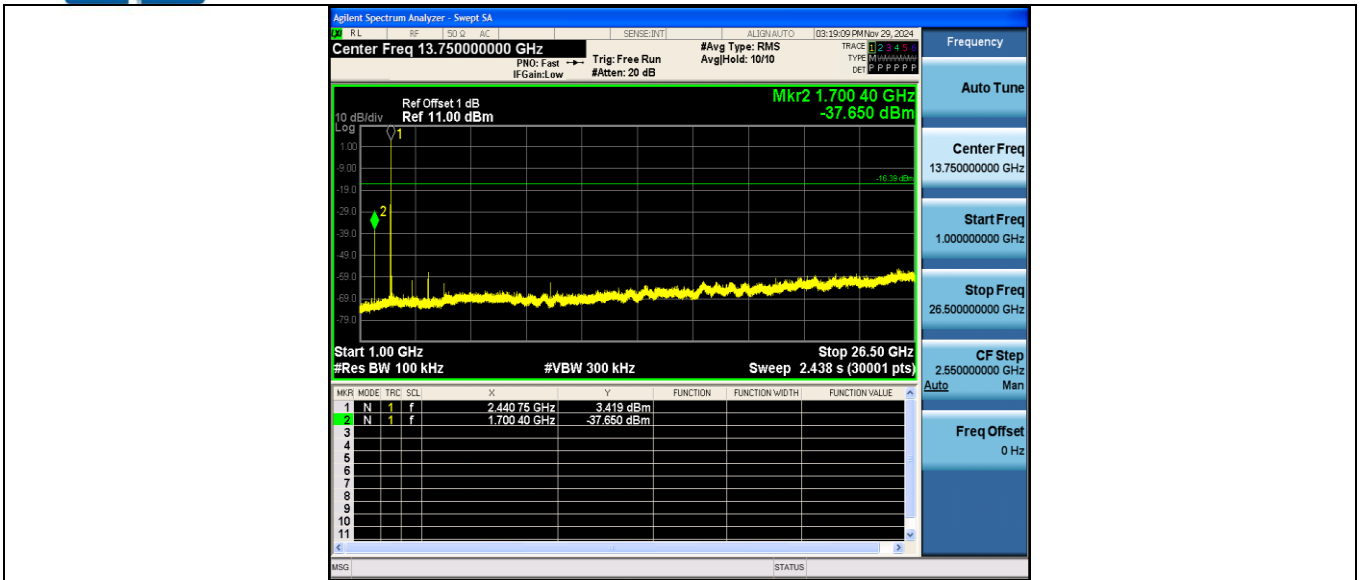

2DH5\_Ant1\_2480\_0~Reference

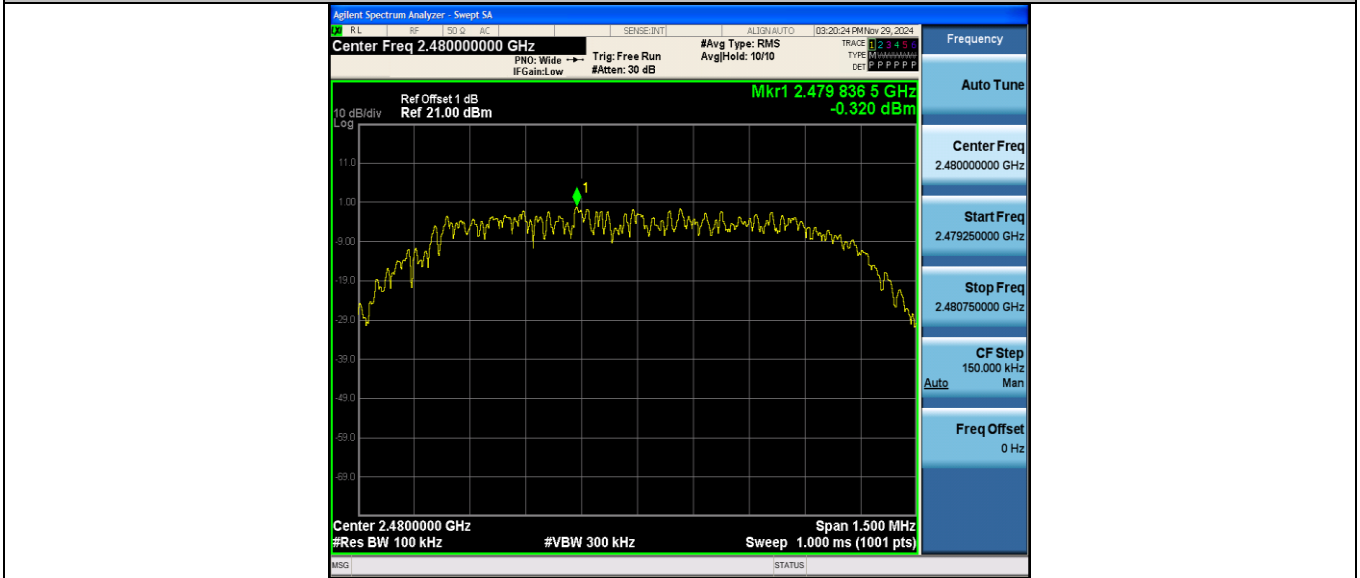

2DH5\_Ant1\_2480\_30~1000

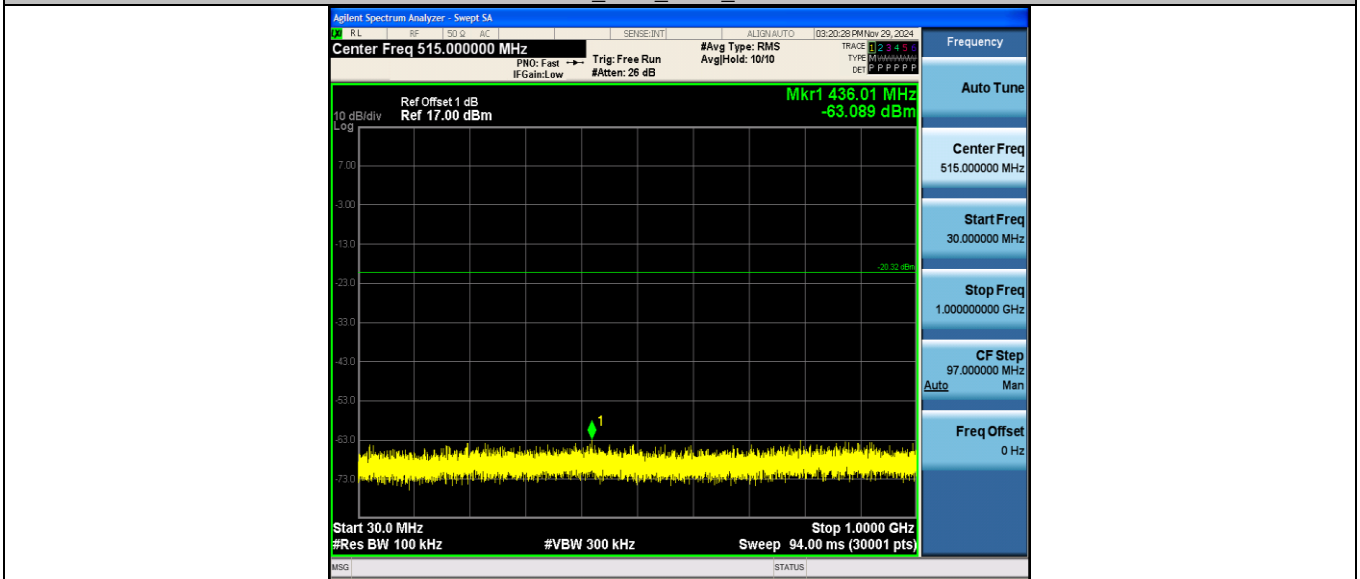

2DH5\_Ant1\_2480\_1000~26500

CTC Laboratories, Inc.

Room 101 Building B, No. 7, Lanqing 1st Road, Luhu Community, Guanhu Subdistrict, Longhua District, Shenzhen, Guangdong, China  
Tel.: (86)755-27521059 Fax: (86)755-27521011 Http://www.sz-ctc.org.cn

TRF No: CTC-TR-059\_A1

For anti-fake verification, please visit the official website of China Inspection And Testing Society : [yz.cnca.cn](http://yz.cnca.cn)

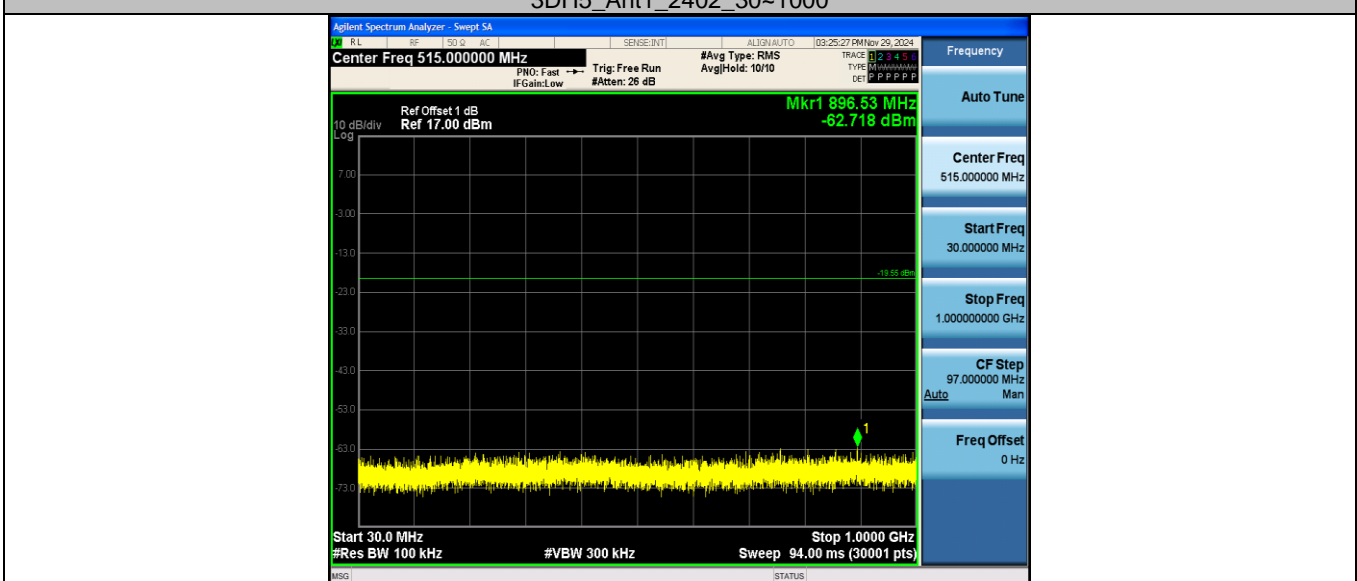
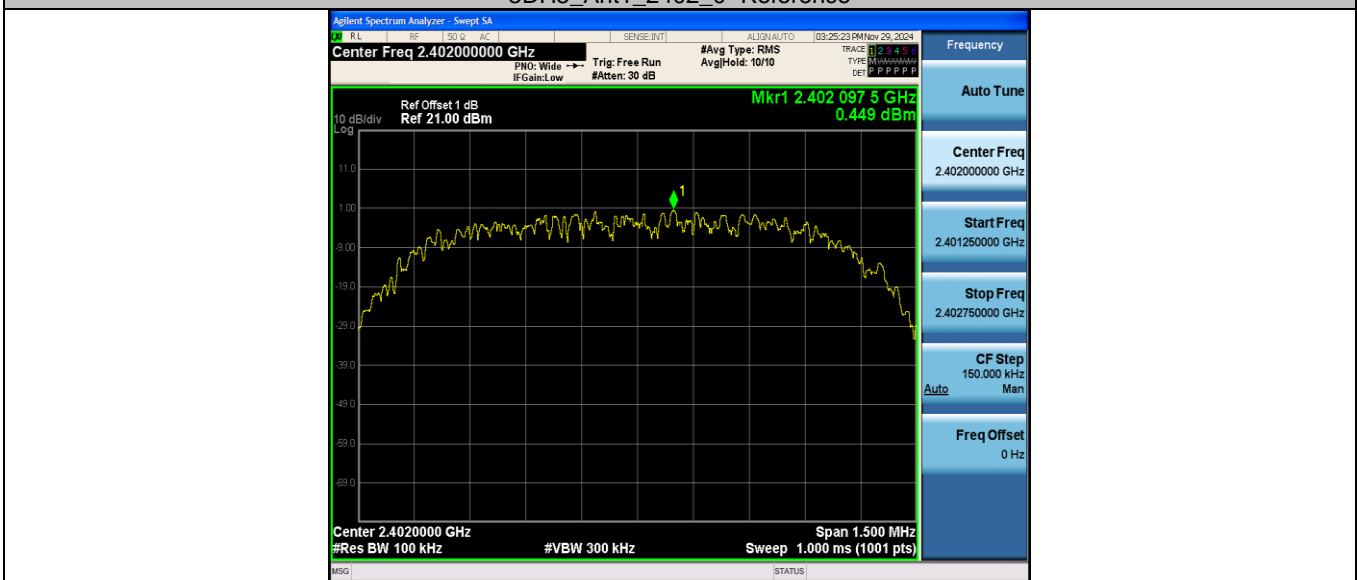
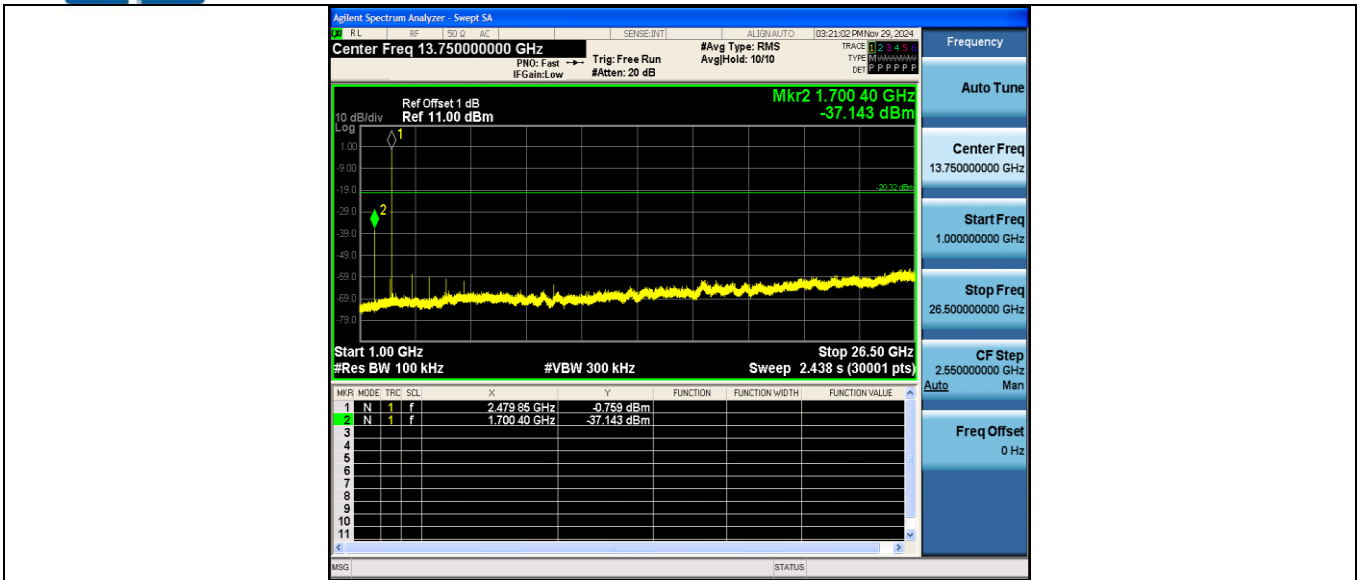

CTC Laboratories, Inc.

Room 101 Building B, No. 7, Lanqing 1st Road, Luhu Community, Guanhu Subdistrict, Longhua District, Shenzhen, Guangdong, China  
Tel.: (86)755-27521059 Fax: (86)755-27521011 Http://www.sz-ctc.org.cn

TRF No: CTC-TR-059\_A1

For anti-fake verification, please visit the official website of China Inspection And Testing Society : [yz.cnca.cn](http://yz.cnca.cn)

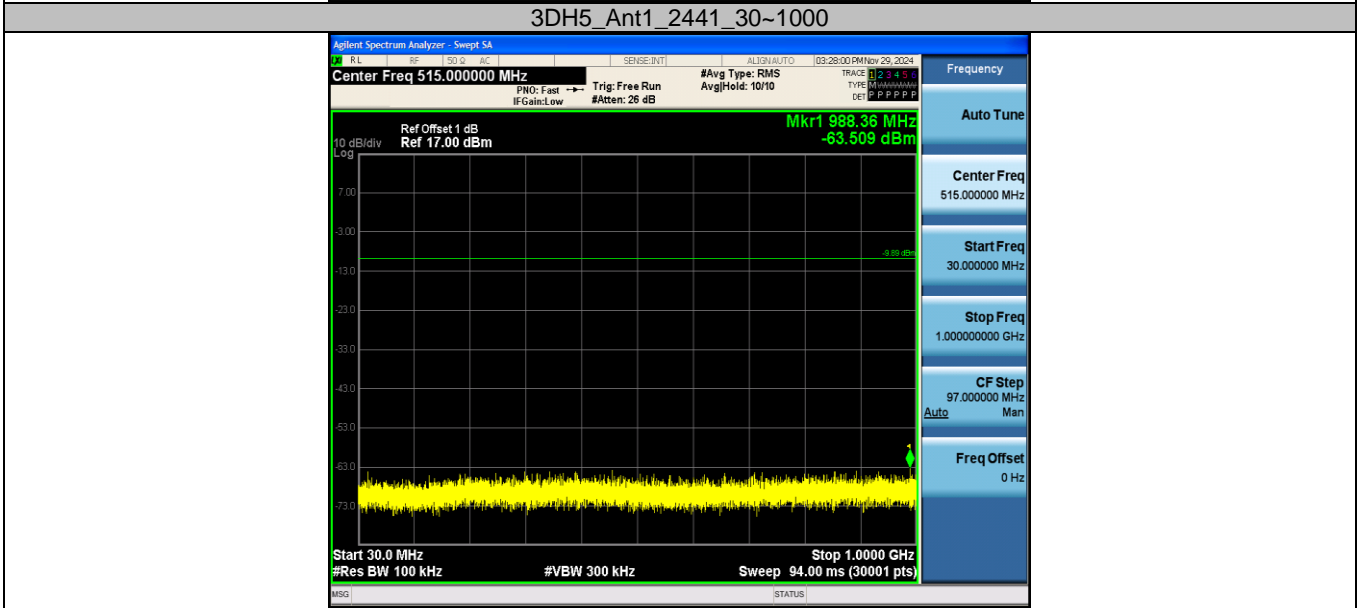
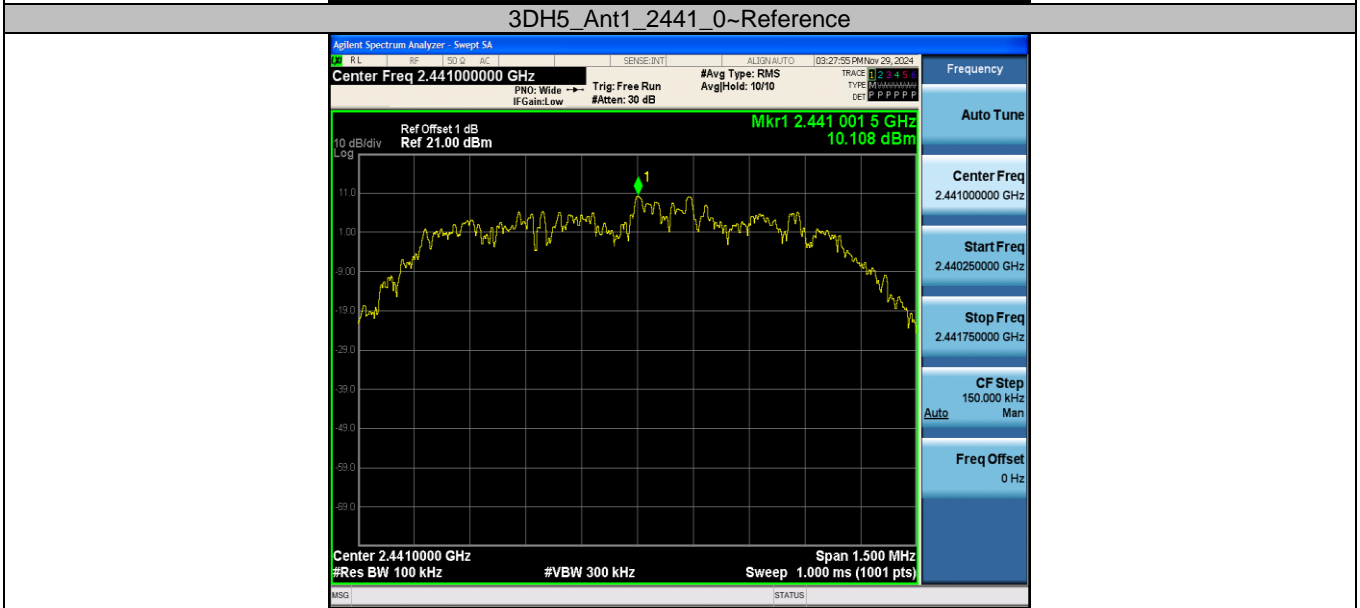
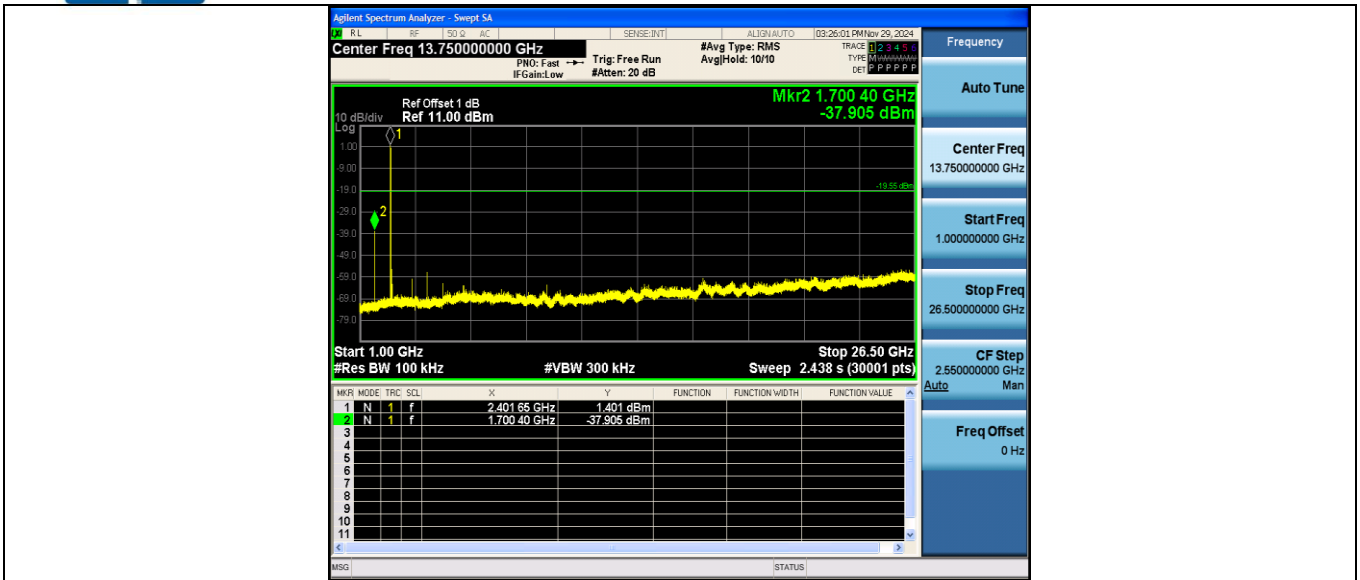

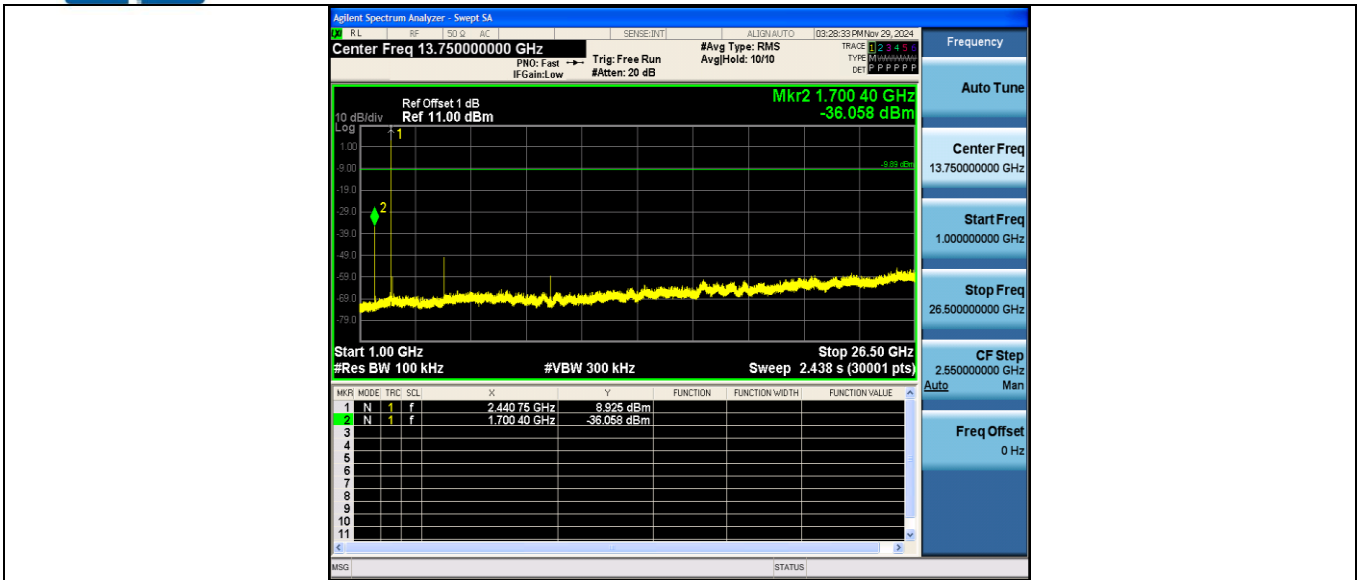

3DH5\_Ant1\_2480\_0~Reference

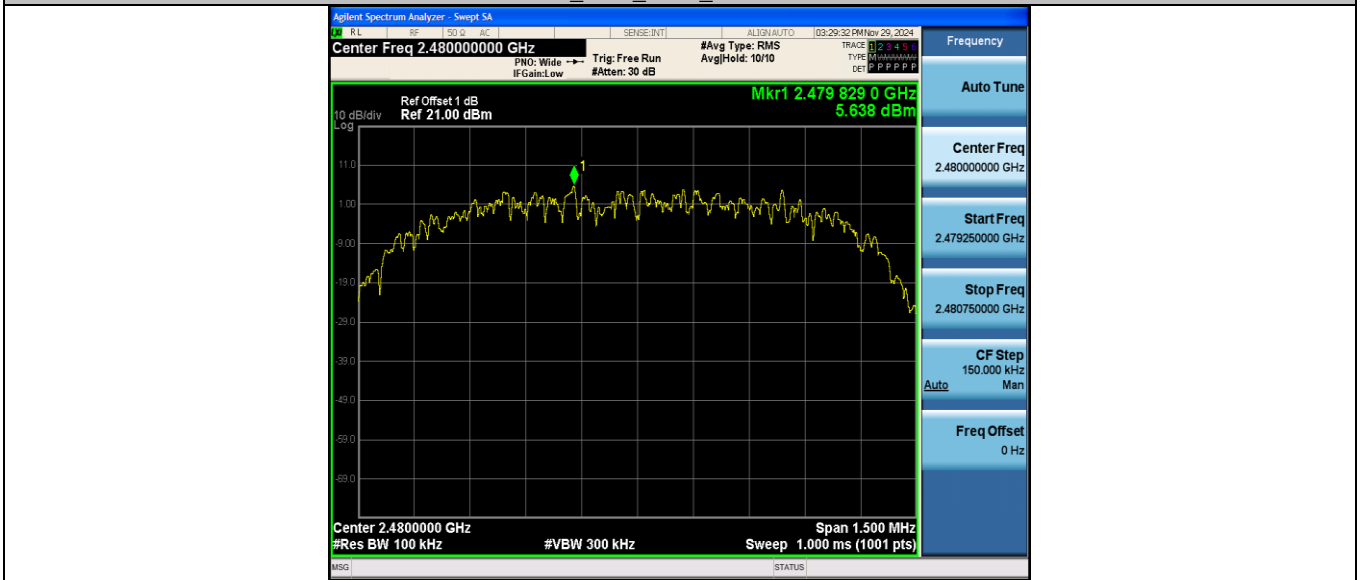

3DH5\_Ant1\_2480\_30~1000

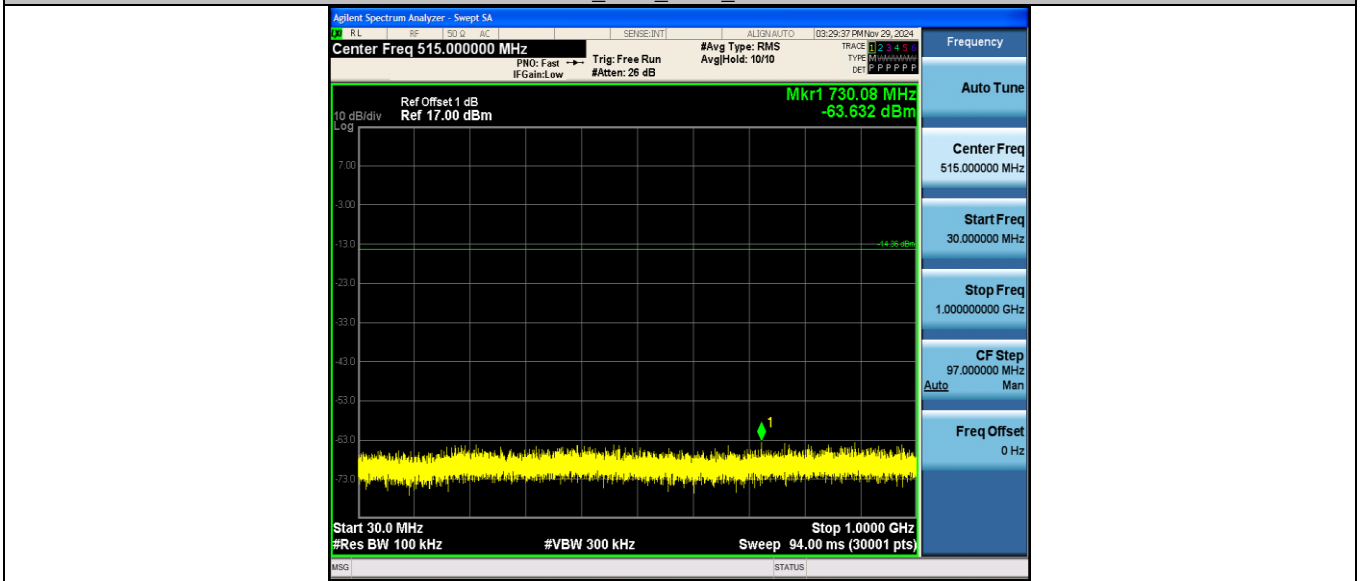

3DH5\_Ant1\_2480\_1000~26500

CTC Laboratories, Inc.

Room 101 Building B, No. 7, Lanqing 1st Road, Luhu Community, Guanhu Subdistrict, Longhua District, Shenzhen, Guangdong, China  
Tel.: (86)755-27521059 Fax: (86)755-27521011 Http://www.sz-ctc.org.cn

TRF No: CTC-TR-059\_A1

For anti-fake verification, please visit the official website of China Inspection And Testing Society : [yz.cnca.cn](http://yz.cnca.cn)



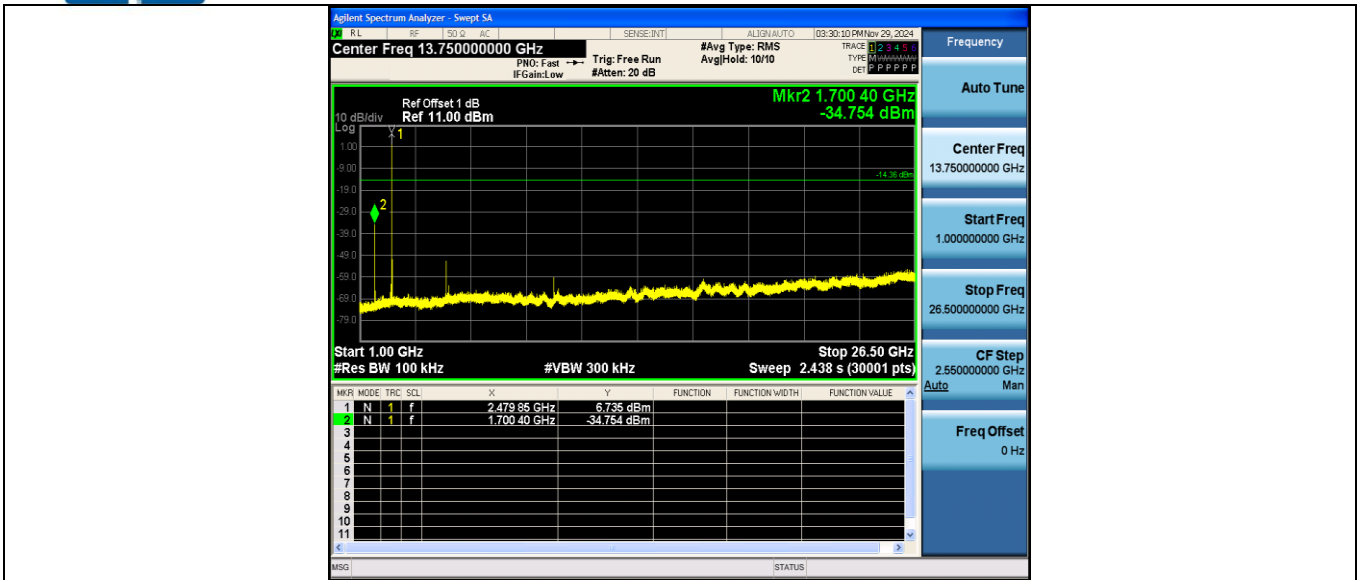

CTC Laboratories, Inc.

Room 101 Building B, No. 7, Lanqing 1st Road, Luhu Community, Guanhu Subdistrict, Longhua District, Shenzhen, Guangdong, China  
Tel.: (86)755-27521059 Fax: (86)755-27521011 Http://www.sz-ctc.org.cn

TRF No: CTC-TR-059\_A1

For anti-fake verification, please visit the official website of China Inspection And Testing Society : [yz.cnca.cn](http://yz.cnca.cn)



### 3.5. 20dB Bandwidth

#### Limit

N/A

#### Test Configuration

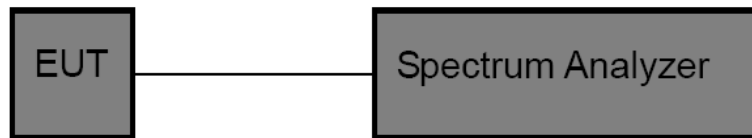

#### Test Procedure

1. The EUT was directly connected to the spectrum analyzer and antenna output port as show in the block diagram above.
2. OCB and 20dB Spectrum Setting:
  - (1) Set RBW = 1% ~ 5% occupied bandwidth.
  - (2) Set the video bandwidth (VBW)  $\geq 3$  RBW.
  - (3) Detector = Peak.
  - (4) Trace mode = Max hold.
  - (5) Sweep = Auto couple.

Note: The EUT was set to continuously transmitting in each mode and low, Middle and high channel for the test.

#### Test Mode

Please refer to the clause 2.4.

#### Test Result

Test Mode	Frequency (MHz)	99% Bandwidth (MHz)	20dB Bandwidth (MHz)	20dB Bandwidth *2/3 (MHz)
GFSK	2402	0.911	0.963	0.642
	2441	0.904	0.933	0.622
	2480	0.889	0.945	0.630
$\pi/4$ -DQPSK	2402	1.175	1.284	0.856
	2441	1.182	1.293	0.862
	2480	1.171	1.281	0.854
8-DPSK	2402	1.180	1.281	0.854
	2441	1.196	1.287	0.858
	2480	1.203	1.293	0.862

CTC Laboratories, Inc.

Room 101 Building B, No. 7, Lanqing 1st Road, Luhu Community, Guanhu Subdistrict, Longhua District, Shenzhen, Guangdong, China  
Tel.: (86)755-27521059 Fax: (86)755-27521011 Http://www.sz-ctc.org.cn

TRF No: CTC-TR-059\_A1

For anti-fake verification, please visit the official website of China Inspection And Testing Society : [yz.cnca.cn](http://yz.cnca.cn)