



# FCC TEST REPORT

## FCC ID:2BKZD-ES1

Applicant: Shenzhen Tangrong Chuanwen Trading Co., Ltd  
Address: Room B111, North Block 1205, International Commercial Building, Nanhu Street, Luohu District, Shenzhen city, Guangdong, CN  
Manufacturer: Shenzhen Tangrong Chuanwen Trading Co., Ltd  
Address: Room B111, North Block 1205, International Commercial Building, Nanhu Street, Luohu District, Shenzhen city, Guangdong, CN  
EUT: Open Ear Headphones  
Trade Mark: Bakeey  
Model Number: ES1  
Date of Receipt: Jan. 17, 2025  
Test Date: Jan. 17, 2025 to Aug. 27, 2025  
Date of Report: Aug. 27, 2025  
Prepared By: Shenzhen DL Testing Technology Co., Ltd.  
Address: 101-201, Comprehensive Building, Tongzhou Electronics Longgang Factory Area, No.1 Baolong Fifth Road, Baolong Community, Baolong Street, Longgang District, Shenzhen, China  
Applicable Standards: FCC CFR Title 47 Part 15 Subpart C Section 15.247  
ANSI C63.10:2013  
Test Result: Pass  
Report Number: DLE-250729008R  
Prepared (Test Engineer): Dimon Tan  
Reviewer (Supervisor): Jack Bu  
Approved (Manager): Jade Yang



*This test report is based on a single evaluation of one sample of above mentioned products. It is not permitted to be duplicated in extracts without written approval of Shenzhen DL Testing Technology Co., Ltd.*



**Table of Contents**

	<b>Page</b>
<b>1. VERSION</b> .....	<b>4</b>
<b>2. TEST SUMMARY</b> .....	<b>5</b>
2.1 TEST FACILITY .....	6
2.2 MEASUREMENT UNCERTAINTY .....	6
3.1 GENERAL DESCRIPTION OF EUT .....	7
3.2 Test Setup Configuration .....	9
3.3 Support Equipment .....	9
<b>4. EMC EMISSION TEST</b> .....	<b>12</b>
4.1 Conducted emissions .....	12
4.1.1 POWER LINE CONDUCTED EMISSION Limits .....	12
4.1.2 TEST PROCEDURE .....	12
4.1.3 DEVIATION FROM TEST STANDARD .....	12
4.1.4 TEST SETUP .....	12
4.1.5 EUT OPERATING CONDITIONS .....	13
4.1.6 Test Result .....	13
4.2 Radiated emissions .....	16
4.2.1 Radiated Emission Limits .....	16
4.2.2 TEST PROCEDURE .....	16
4.2.3 DEVIATION FROM TEST STANDARD .....	17
4.2.4 TEST SETUP .....	17
4.2.5 EUT OPERATING CONDITIONS .....	18
4.2.6 TEST RESULTS .....	18
<b>5. RADIATED BAND EMISSION MEASUREMENT</b> .....	<b>35</b>
5.1 Test Requirement: .....	35
5.2 TEST PROCEDURE .....	35
5.3 DEVIATION FROM TEST STANDARD .....	36
5.4 TEST SETUP .....	36
5.5 EUT OPERATING CONDITIONS .....	36
5.6 TEST RESULT .....	37
<b>6. CONDUCTED BAND EDGE AND SPURIOUS EMISSION</b> .....	<b>41</b>
6.1 Limit .....	41
6.2 Test Setup .....	41
6.3 Test procedure .....	41
6.4 DEVIATION FROM STANDARD .....	41
6.5 Test Result .....	42
<b>7. 20DB BANDWIDTH</b> .....	<b>51</b>
7.1 Test Setup .....	51
7.2 Limit .....	51
7.3 Test procedure .....	51
7.4 DEVIATION FROM STANDARD .....	51



---

7.5 Test Result .....	52
<b>8. MAXIMUM PEAK OUTPUT POWER .....</b>	<b>57</b>
8.1 Block Diagram Of Test Setup .....	57
8.2 Limit .....	57
8.3 Test procedure .....	57
8.4 DEVIATION FROM STANDARD .....	57
8.5 Test Result .....	58
9.1 Test Setup .....	63
9.2 Test procedure .....	63
9.3 DEVIATION FROM STANDARD .....	63
9.4 Test Result .....	64
<b>10.NUMBER OF HOPPING FREQUENCY .....</b>	<b>69</b>
10.1 Test Setup .....	69
10.2 Test procedure .....	69
10.3 DEVIATION FROM STANDARD .....	69
10.4 Test Result .....	70
<b>11. DWELL TIME .....</b>	<b>72</b>
11.1 Test Setup .....	72
11.2 Test procedure .....	72
11.3 DEVIATION FROM STANDARD .....	72
11.4 Test Result .....	73
<b>12. ANTENNA REQUIREMENT .....</b>	<b>79</b>
<b>13. TEST SETUP PHOTO .....</b>	<b>80</b>
<b>14. EUT CONSTRUCTIONAL DETAILS .....</b>	<b>80</b>



**1. VERSION**

Report No.	Version	Description	Approved
DLE-250729008R	Rev.01	Initial issue of report	Aug. 27, 2025



## 2. TEST SUMMARY

Test procedures according to the technical standards:

FCC Part15 (15.247) , Subpart C			
Standard Section	Test Item	Result	Remark
15.203/15.247 (c)	Antenna Requirement	PASS	
15.207	AC Power Line Conducted Emission	PASS	
15.247 (b)(1)	Conducted Peak Output Power	PASS	
15.247 (a)(1)	20dB Occupied Bandwidth	PASS	
15.247 (a)(1)	Carrier Frequencies Separation	PASS	
15.247 (a)(1)(iii)	Hopping Channel Number	PASS	
15.247 (a)(1)(iii)	Dwell Time	PASS	
15.205/15.209	Radiated Emission and Restricted Band	PASS	
15.247(d)	Conducted Unwanted emissions and Band Edge	PASS	

NOTE:

(1) "N/A" denotes test is not applicable in this Test Report



## 2.1 TEST FACILITY

Shenzhen DL Testing Technology Co., Ltd.

Add. : 101-201, Comprehensive Building, Tongzhou Electronics Longgang Factory Area, No.1 Baolon Fifth Road, Baolong Community, Baolong Street, Longgang District, Shenzhen, China

FCC Test Firm Registration Number: 854456

Designation Number: CN1307

IC Registered No.: 27485

CAB identifier: CN0118

## 2.2 MEASUREMENT UNCERTAINTY

The reported uncertainty of measurement  $y \pm U$ , where expanded uncertainty  $U$  is based on a standard uncertainty multiplied by a coverage factor of  $k=2$ , providing a level of confidence of approximately 95 %.

No.	Item	Uncertainty
1	3m chamber Radiated spurious emission(9KHz-30MHz)	U=4.5dB
2	3m chamber Radiated spurious emission(30MHz-1GHz)	U=4.8dB
3	3m chamber Radiated spurious emission(1GHz-6GHz)	U=4.9dB
4	3m chamber Radiated spurious emission(6GHz-40GHz)	U=5.0dB
5	Conducted disturbance	U=3.2dB
6	RF Band Edge	U=1.68dB
7	RF power conducted	U=1.86dB
8	RF conducted Spurious Emission	U=2.2dB
9	RF Occupied Bandwidth	U=1.8MHz
10	RF Power Spectral Density	U=1.75dB
11	humidity uncertainty	U=5.3%
12	Temperature uncertainty	U=0.59°C



### 3. GENERAL INFORMATION

#### 3.1 GENERAL DESCRIPTION OF EUT

Product Name:	Open Ear Headphones
Model No.:	ES1
Model Different.:	N/A
Serial No.:	N/A
Hardware Version:	H1.0
Software Version:	S1.0
Sample(s) Status:	Engineer sample
Channel numbers:	79
Operation Frequency:	2402MHz ~ 2480MHz
Modulation technology:	GFSK, $\pi/4$ -DQPSK, 8-DPSK
Antenna Type:	Chip Antenna
Antenna gain:	2.7dBi
Power supply:	Input: DC 5V/0.5A
Battery:	Battery: 3.7V, 60mAh, 0.222Wh



Operation Frequency each of channel							
Channel	Frequency	Channel	Frequency	Channel	Frequency	Channel	Frequency
1	2402MHz	21	2422MHz	41	2442MHz	61	2462MHz
2	2403MHz	22	2423MHz	42	2443MHz	62	2463MHz
3	2404MHz	23	2424MHz	43	2444MHz	63	2464MHz
4	2405MHz	24	2425MHz	44	2445MHz	64	2465MHz
5	2406MHz	25	2426MHz	45	2446MHz	65	2466MHz
6	2407MHz	26	2427MHz	46	2447MHz	66	2467MHz
7	2408MHz	27	2428MHz	47	2448MHz	67	2468MHz
8	2409MHz	28	2429MHz	48	2449MHz	68	2469MHz
9	2410MHz	29	2430MHz	49	2450MHz	69	2470MHz
10	2411MHz	30	2431MHz	50	2451MHz	70	2471MHz
11	2412MHz	31	2432MHz	51	2452MHz	71	2472MHz
12	2413MHz	32	2433MHz	52	2453MHz	72	2473MHz
13	2414MHz	33	2434MHz	53	2454MHz	73	2474MHz
14	2415MHz	34	2435MHz	54	2455MHz	74	2475MHz
15	2416MHz	35	2436MHz	55	2456MHz	75	2476MHz
16	2417MHz	36	2437MHz	56	2457MHz	76	2477MHz
17	2418MHz	37	2438MHz	57	2458MHz	77	2478MHz
18	2419MHz	38	2439MHz	58	2459MHz	78	2479MHz
19	2420MHz	39	2440MHz	59	2460MHz	79	2480MHz
20	2421MHz	40	2441MHz	60	2461MHz		

**Note:**

In section 15.31(m), regards to the operating frequency range over 10 MHz, the Lowest frequency, the middle frequency, and the highest frequency of channel were selected to perform the test, and the selected channel see below:

Test channel	Frequency
The lowest channel	2402MHz
The middle channel	2441MHz
The Highest channel	2480MHz





3.2 Test Setup Configuration

Conducted Emission

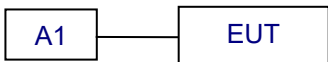

Radiated Emission



3.3 Support Equipment

The EUT has been tested as an independent unit together with other necessary accessories or support units. The following support units or accessories were used to form a representative test configuration during the tests.

Item	Equipment	Mfr/Brand	Model/Type No.	Series No.	Note
E-1	Open Ear Headphones	Bakeey	ES1	N/A	EUT
A-1	Adapter	N/A	BI18L-090200-Ad U	N/A	Auxiliary

Item	Shielded Type	Ferrite Core	Length	Note

Note:

- (1) The support equipment was authorized by Declaration of Confirmation.
- (2) For detachable type I/O cable should be specified the length in cm in 『Length』 column.

3.4 Test Mode

Transmitting mode	Keep the EUT in continuously transmitting mode.
Remark: During the test, the test voltage was tuned from 85% to 115% of the nominal rated supply voltage, and found that the worst case was under the nominal rated supply condition. So the report just shows that condition's data.	

Test Software	FCC_assist Test Tool
Power level setup	Default



## 3.5 EQUIPMENTS LIST FOR ALL TEST ITEMS

## Conduction Emissions Test

Item	Kind of Equipment	Manufacturer	Type No.	Serial No.	Firmware Version	Last calibration	Calibrated until
1	LISN	R&S	ENV216	101471	N/A	Sep. 30, 2024	Sep. 29, 2025
2	LISN	CYBERTEK	EM5040A	E1850400149	N/A	Sep. 30, 2024	Sep. 29, 2025
3	Test Cable	N/A	C-01	N/A	N/A	Sep. 30, 2024	Sep. 29, 2025
4	EMI Test Receiver	R&S	ESCI3	101393	4.42 SP3	Sep. 29, 2024	Sep. 28, 2025
5	EMC Software	Frad	EZ-EMC	Ver.EMC-CON 3A1.1	N/A	\	\

## Radiation Emissions &amp; Radiation Spurious Emissions Test

Item	Equipment	Manufacturer	Type No.	Serial No.	Firmware Version	Last calibration	Calibrated until
1	Spectrum Analyzer (9kHz-26.5GHz)	KEYSIGHT	N9020A	MY55370835	A.17.05	Sep. 29, 2024	Sep. 28, 2025
2	Spectrum Analyzer (10kHz-39.9GHz)	R&S	FSV40-N	100363	1.71 SP2	Sep. 30, 2024	Sep. 29, 2025
3	EMI Test Receiver (9kHz-7GHz)	R&S	ESCI7	100969	4.32	Sep. 29, 2024	Sep. 28, 2025
4	Bilog Antenna (30MHz-1500MHz)	Schwarzbeck	VULB9168	00877	N/A	Sep. 30, 2024	Sep. 29, 2025
5	Horn Antenna (1GHz-18GHz)	Agilent	AH-118	071145	N/A	Sep. 30, 2024	Sep. 29, 2025
6	Horn Antenna (15GHz-40GHz)	A.H.System	SAS-574	588	N/A	Sep. 30, 2024	Sep. 29, 2025
7	Loop Antenna	TESEQ	HLA6121	58357	N/A	Oct. 11, 2024	Oct. 10, 2025
8	Amplifier (30-1000MHz)	EM Electronics	EM330 Amplifier	60747	N/A	Sep. 29, 2024	Sep. 28, 2025
9	Amplifier (1GHz-26.5GHz)	HuiPu	8449B	3008A00315	N/A	Sep. 29, 2024	Sep. 28, 2025
10	Amplifier (500MHz-40GHz)	QuanJuDa	DLE-161	097	N/A	Sep. 30, 2024	Sep. 29, 2025
11	Test Cable	N/A	R-01	N/A	N/A	Sep. 30, 2024	Sep. 29, 2025
12	Test Cable	N/A	R-02	N/A	N/A	Sep. 30, 2024	Sep. 29, 2025
13	Test Cable	N/A	R-03	N/A	N/A	Sep. 30, 2024	Sep. 29, 2025
14	D.C. Power Supply	LongWei	TPR-6405D	GQ7516	N/A	Sep. 29, 2024	Sep. 28, 2025
15	EMC Software	Frad	EZ-EMC	Ver.EMC-CO N 3A1.1	N/A	\	\
16	Turntable	MF	MF-7802BS	N/A	N/A	\	\
17	Antenna tower	MF	MF-7802BS	N/A	N/A	\	\



## RF Conducted Test

Item	Equipment	Manufacturer	Type No.	Serial No.	Firmware Version	Last calibration	Calibrated until
1	Spectrum Analyzer (9kHz-26.5GHz)	KEYSIGHT	N9020A	MY55370835	A.17.05	Sep. 29, 2024	Sep. 28, 2025
2	Spectrum Analyzer (10kHz-39.9GHz)	R&S	FSV40-N	100363	1.71 SP2	Sep. 30, 2024	Sep. 29, 2025
3	Test Cable	N/A	RF-01	N/A	N/A	Sep. 30, 2024	Sep. 29, 2025
4	Test Cable	N/A	RF-02	N/A	N/A	Sep. 30, 2024	Sep. 29, 2025
5	Test Cable	N/A	RF-03	N/A	N/A	Sep. 30, 2024	Sep. 29, 2025
6	ESG Signal Generator	Agilent	E4421B	GB40051203	B.03.84	Sep. 29, 2024	Sep. 28, 2025
7	Signal Generator	Agilent	N5182A	MY47420215	A.01.87	Sep. 29, 2024	Sep. 28, 2025
8	Magnetic Field Probe Tester	Narda	ELT-400	0-0344/M-1752	N/A	Sep. 29, 2024	Sep. 28, 2025
9	Van der Hoofden measuring head	Schwarzbeck Mess-elektronik	VDHH 9502	9502-039	N/A	Sep. 30, 2024	Sep. 29, 2025
10	Wideband Radio Communication Test	R&S	CMW500	106504	V 3.7.22	Sep. 30, 2024	Sep. 29, 2025
11	MWRF Power Meter Test system	MW	MW100-RF CB	10371	N/A	Sep. 29, 2024	Sep. 28, 2025
12	Power Meter	KEYSIGHT	N1912AP	926431	A.05.00	Sep. 29, 2024	Sep. 28, 2025
13	D.C. Power Supply	LongWei	TPR-6405 D	GQ7516	N/A	Sep. 29, 2024	Sep. 28, 2025
14	RF Software	MW	MTS8310	V2.0.0.0	N/A	\	\



#### 4. EMC EMISSION TEST

##### 4.1 Conducted emissions

Test Requirement:	FCC Part15 C Section 15.207
Test Method:	ANSI C63.10:2013
Test Frequency Range:	150KHz to 30MHz
Receiver setup:	RBW=9KHz, VBW=30KHz, Sweep time=auto

##### 4.1.1 POWER LINE CONDUCTED EMISSION Limits

FREQUENCY (MHz)	Limit (dBuV)		Standard
	Quasi-peak	Average	
0.15 -0.5	66 - 56 *	56 - 46 *	FCC
0.50 -5.0	56.00	46.00	FCC
5.0 -30.0	60.00	50.00	FCC

Note:

(1) \*Decreases with the logarithm of the frequency.

##### 4.1.2 TEST PROCEDURE

- The EUT was placed 0.8 meters from the horizontal ground plane with EUT being connected to the power mains through a line impedance stabilization network (LISN). All other support equipments powered from additional LISN(s). The LISN provide 50 Ohm/ 50uH of coupling impedance for the measuring instrument.
- Interconnecting cables that hang closer than 40 cm to the ground plane shall be folded back and forth in the center forming a bundle 30 to 40 cm long.
- I/O cables that are not connected to a peripheral shall be bundled in the center. The end of the cable may be terminated, if required, using the correct terminating impedance. The overall length shall not exceed 1 m.
- LISN at least 80 cm from nearest part of EUT chassis.
- For the actual test configuration, please refer to the related Item –EUT Test Photos.

##### 4.1.3 DEVIATION FROM TEST STANDARD

No deviation

##### 4.1.4 TEST SETUP

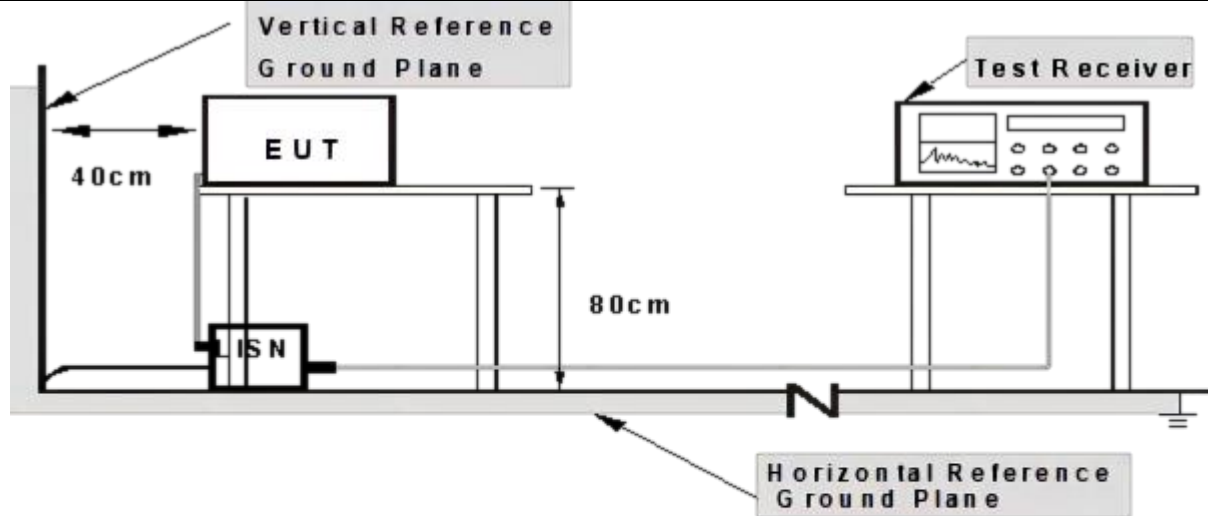

**Note: 1. Support units were connected to second LISN.**

**2. Both of LISNs (AMN) are 80 cm from EUT and at least 80 cm from other units and other metal planes**

#### 4.1.5 EUT OPERATING CONDITIONS

The EUT was configured for testing in a typical fashion (as a customer would normally use it). The EUT has been programmed to continuously transmit during test. This operating condition was tested and used to collect the included data.

#### 4.1.6 Test Result



Temperature:	26°C	Relative Humidity:	54%
Pressure:	101kPa	Phase :	L
Test Voltage :	AC 120V/60Hz	Test Mode:	BT TX

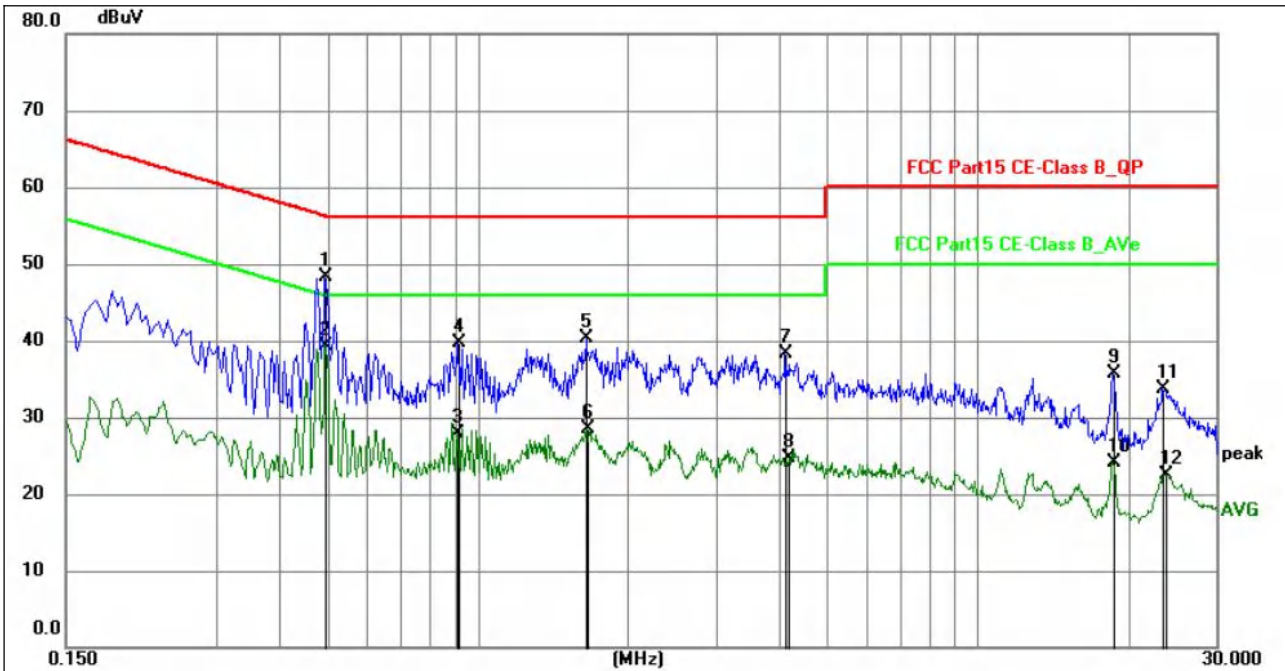

No.	Frequency (MHz)	Reading (dBuV)	Factor (dB)	Level (dBuV)	Limit (dBuV)	Margin (dB)	Detector	P/F	Remark
1	0.4965	27.91	20.30	48.21	56.06	-7.85	QP	P	
2	0.4967	19.00	20.30	39.30	46.06	-6.76	AVG	P	
3	0.9104	7.52	20.30	27.82	46.00	-18.18	AVG	P	
4	0.9149	19.31	20.30	39.61	56.00	-16.39	QP	P	
5	1.6484	19.92	20.30	40.22	56.00	-15.78	QP	P	
6	1.6574	8.17	20.30	28.47	46.00	-17.53	AVG	P	
7	4.1280	17.97	20.35	38.32	56.00	-17.68	QP	P	
8	4.1865	4.44	20.35	24.79	46.00	-21.21	AVG	P	
9	18.6494	15.29	20.50	35.79	60.00	-24.21	QP	P	
10	18.6494	3.66	20.50	24.16	50.00	-25.84	AVG	P	
11	23.4150	13.21	20.59	33.80	60.00	-26.20	QP	P	
12	23.8604	1.94	20.60	22.54	50.00	-27.46	AVG	P	





Temperature:	26°C	Relative Humidity:	54%
Pressure:	101kPa	Phase :	N
Test Voltage :	AC 120V/60Hz	Test Mode:	BT TX

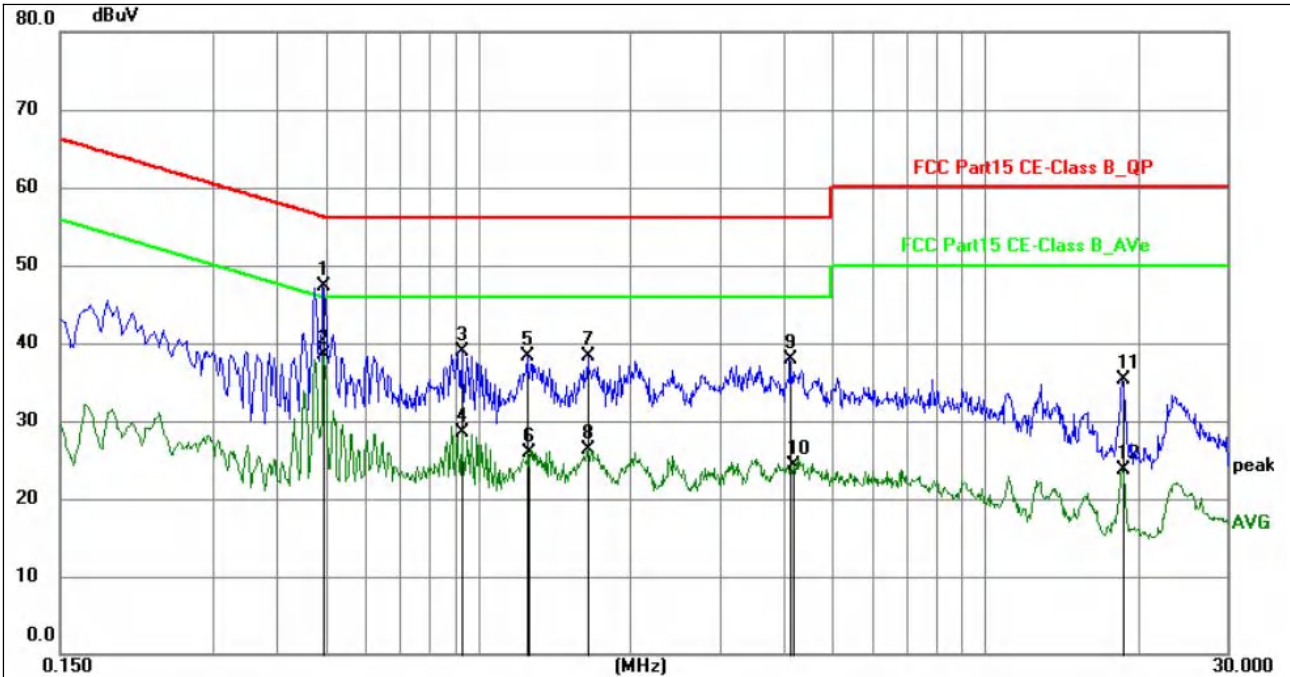

No.	Frequency (MHz)	Reading (dBuV)	Factor (dB)	Level (dBuV)	Limit (dBuV)	Margin (dB)	Detector	P/F	Remark
1	0.4964	26.91	20.30	47.21	56.06	-8.85	QP	P	
2	0.4964	18.11	20.30	38.41	46.06	-7.65	AVG	P	
3	0.9328	18.70	20.30	39.00	56.00	-17.00	QP	P	
4	0.9328	8.24	20.30	28.54	46.00	-17.46	AVG	P	
5	1.2523	18.01	20.30	38.31	56.00	-17.69	QP	P	
6	1.2567	5.61	20.31	25.92	46.00	-20.08	AVG	P	
7	1.6484	17.92	20.30	38.22	56.00	-17.78	QP	P	
8	1.6484	5.91	20.30	26.21	46.00	-19.79	AVG	P	
9	4.1280	17.47	20.35	37.82	56.00	-18.18	QP	P	
10	4.1864	3.94	20.35	24.29	46.00	-21.71	AVG	P	
11	18.6494	14.79	20.50	35.29	60.00	-24.71	QP	P	
12	18.6494	3.16	20.50	23.66	50.00	-26.34	AVG	P	

Notes:

1. An initial pre-scan was performed on the line and neutral lines with peak detector.
2. Quasi-Peak and Average measurement were performed at the frequencies with maximized peak emission.
3. Measurement Level = Reading level + Correct Factor
4. The test data shows only the worst case π/4-DQPSK and AC 120V mode



4.2 Radiated emissions

Test Requirement:	FCC Part15 C Section 15.209				
Test Method:	ANSI C63.10:2013				
Test Frequency Range:	9kHz to 25GHz				
Test site:	Measurement Distance: 3m				
Receiver setup:	Frequency	Detector	RBW	VBW	Value
	9KHz-150KHz	Quasi-peak	200Hz	MX5Hz	Quasi-peak
	150KHz-30MHz	Quasi-peak	9KHz	30KHz	Quasi-peak
	30MHz-1GHz	Quasi-peak	100KHz	300KHz	Quasi-peak
	Above 1GHz	Peak	1MHz	3MHz	Peak
		Peak	1MHz	10Hz	Average

4.2.1 Radiated Emission Limits

Frequencies (MHz)	Field Strength (micovolts/meter)	Measurement Distance (meters)
0.009~0.490	2400/F(KHz)	300
0.490~1.705	24000/F(KHz)	30
1.705~30.0	30	30
30~88	100	3
88~216	150	3
216~960	200	3
Above 960	500	3

LIMITS OF RADIATED EMISSION MEASUREMENT

FREQUENCY (MHz)	Limit (dBuV/m) (at 3M)	
	PEAK	AVERAGE
Above 1000	74	54

Notes:

- (1) The limit for radiated test was performed according to FCC PART 15C.
- (2) The tighter limit applies at the band edges.
- (3) Emission level (dBuV/m)=20log Emission level (uV/m).

4.2.2 TEST PROCEDURE

Below 1GHz test procedure as below:

- a. The EUT was placed on the top of a rotating table 0.8 meters above the ground at a 3 meter semi-anechoic chamber. The table was rotated 360 degrees to determine the position of the highest radiation.
- b. The EUT was set 3 meters away from the interference-receiving antenna, which was mounted on the top of a variable-height antenna tower.





- c. The antenna height is varied from one meter to four meters above the ground to determine the maximum value of the field strength. Both horizontal and vertical polarizations of the antenna are set to make the measurement.
- d. For each suspected emission, the EUT was arranged to its worst case and then the antenna was tuned to heights from 1 meter to 4 meters (for the test frequency of below 30MHz, the antenna was tuned to heights 1 meter) and the rotatable table was turned from 0 degrees to 360 degrees to find the maximum reading.
- e. The test-receiver system was set to Peak Detect Function and Specified Bandwidth with Maximum Hold Mode.
- f. If the emission level of the EUT in peak mode was 10dB lower than the limit specified, then testing could be stopped and the peak values of the EUT would be reported. Otherwise the emissions that did not have 10dB margin would be re-tested one by one using peak, quasi-peak or average method as specified and then reported in a data sheet.

Above 1GHz test procedure as below:

- g. Different between above is the test site, change from Semi- Anechoic Chamber to fully Anechoic Chamber and change form table 0.8 metre to 1.5 metre( Above 18GHz the distance is 1 meter and table is 1.5 metre).
- h. Test the EUT in the lowest channel ,the middle channel ,the Highest channel

Note:

Both horizontal and vertical antenna polarities were tested and performed pretest to three orthogonal axis. The worst case emissions were reported

#### 4.2.3 DEVIATION FROM TEST STANDARD

No deviation

#### 4.2.4 TEST SETUP

(A) Radiated Emission Test-Up Frequency Below 30MHz

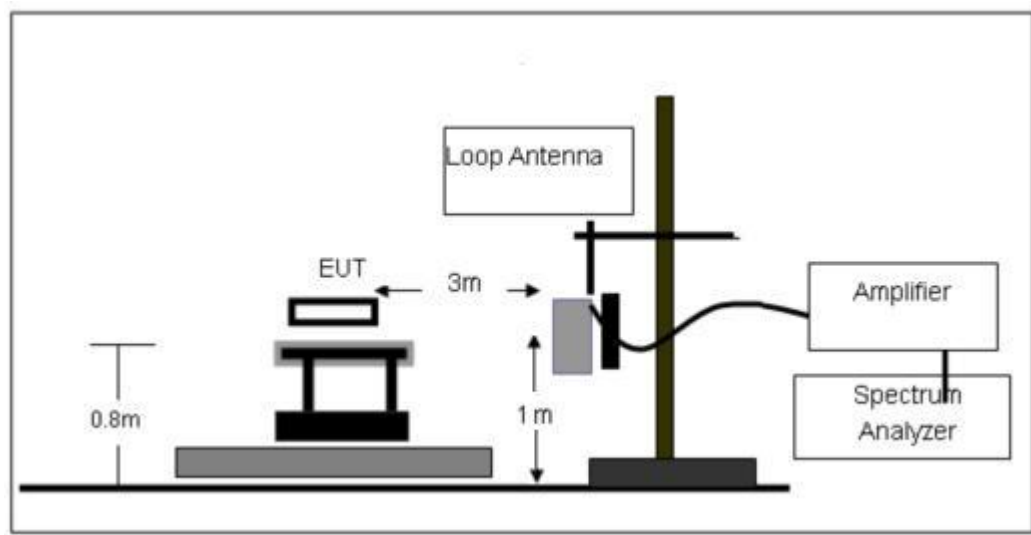

## (B) Radiated Emission Test-Up Frequency 30MHz~1GHz

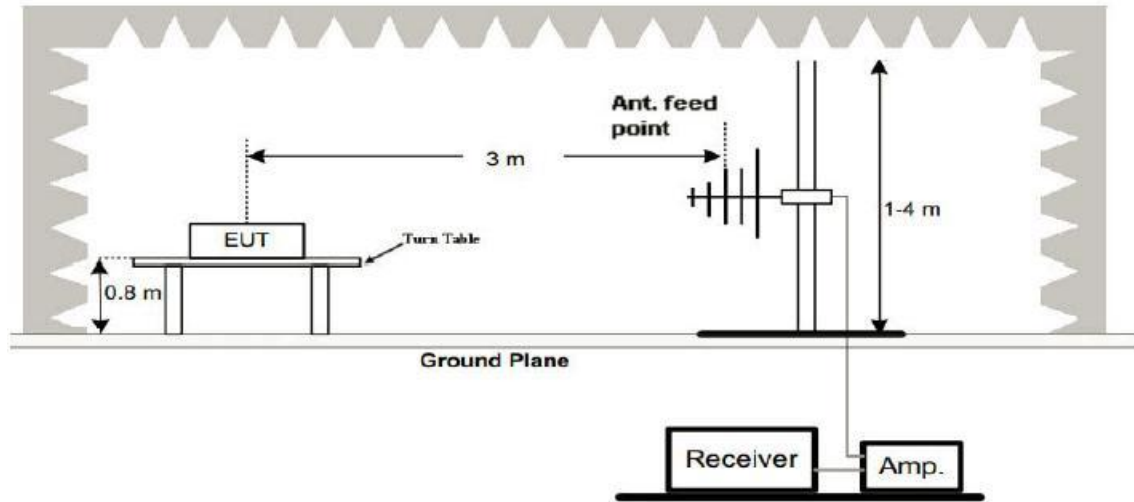

## (C) Radiated Emission Test-Up Frequency Above 1GHz

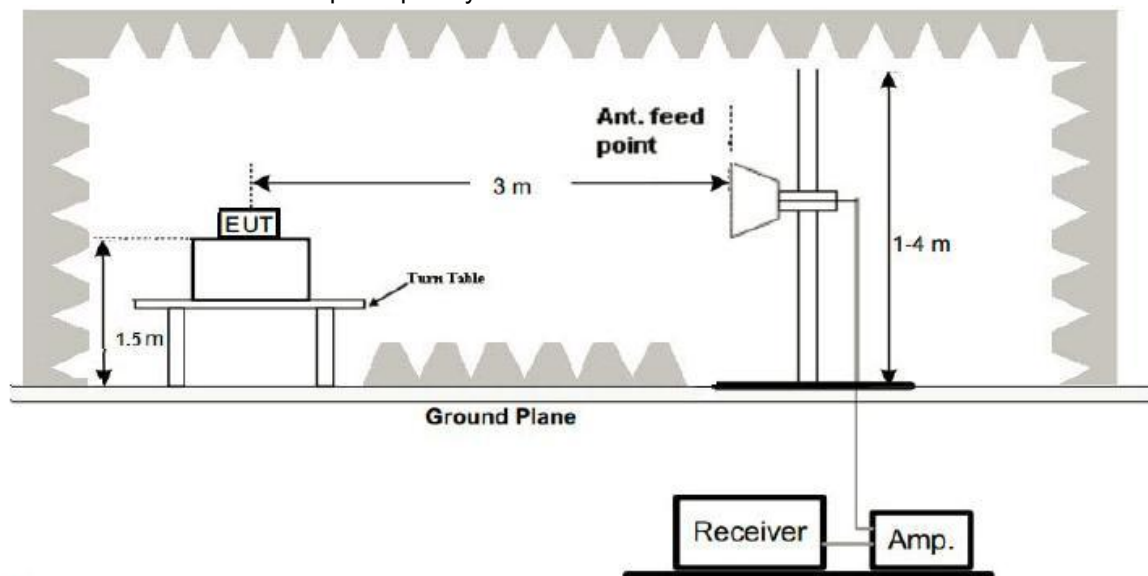

#### 4.2.5 EUT OPERATING CONDITIONS

The EUT tested system was configured as the statements of 2.4 Unless otherwise a special operating condition is specified in the follows during the testing.

#### 4.2.6 TEST RESULTS

Between 9KHz – 30MHz

The emission from 9 kHz to 30MHz was pre-tested and found the result was 20dB lower than the limit, and according to 15.31(o) & RSS-Gen 6.13, the test result no need to reported.



Between 30MHz – 1GHz(Left ear headphones)

Temperature:	26°C	Relative Humidity:	54%
Pressure:	101 kPa	Polarization:	Horizontal
Test Voltage:	DC 3.7V	Mode:	BT TX

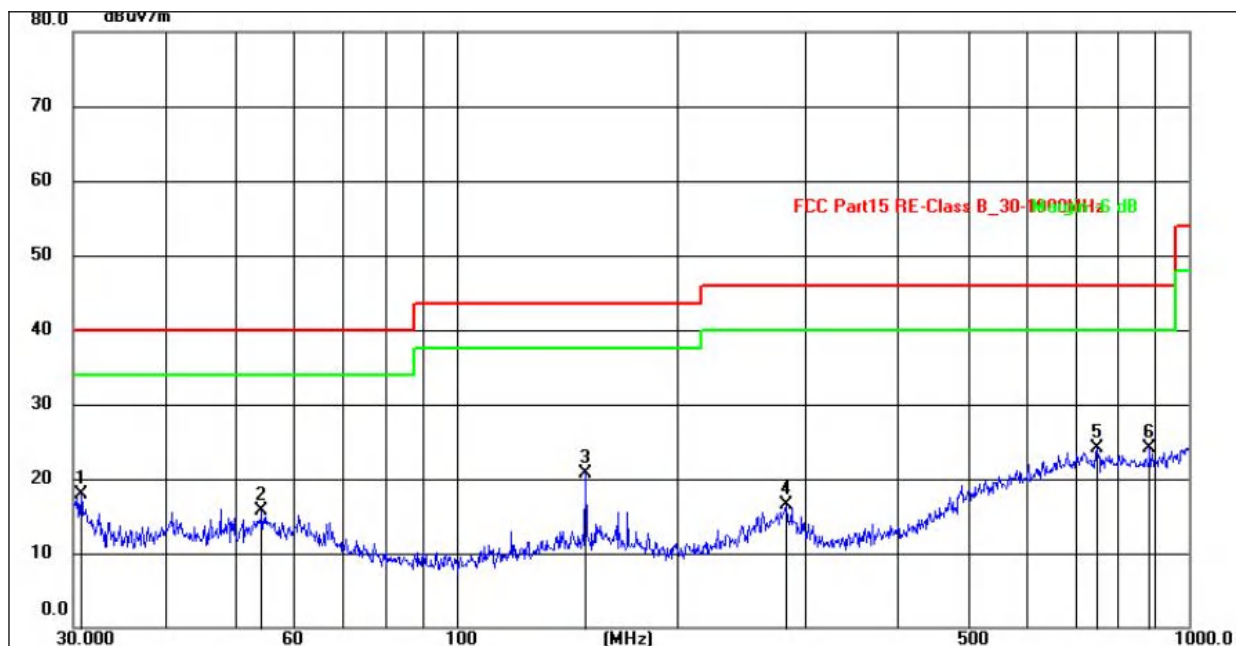

No.	Frequency (MHz)	Reading (dBuV)	Factor (dB/m)	Level (dBuV/m)	Limit (dBuV/m)	Margin (dB)	Detector
1	30.7454	32.18	-14.23	17.95	40.00	-22.05	QP
2	54.2608	29.68	-14.02	15.66	40.00	-24.34	QP
3	150.0107	37.08	-16.35	20.73	43.50	-22.77	QP
4	281.9945	30.62	-14.20	16.42	46.00	-29.58	QP
5	750.1082	30.58	-6.54	24.04	46.00	-21.96	QP
6	884.5027	30.80	-6.69	24.11	46.00	-21.89	QP



Temperature:	26°C	Relative Humidity:	54%
Pressure:	101kPa	Polarization:	Vertical
Test Voltage:	DC 3.7V	Mode:	BT TX

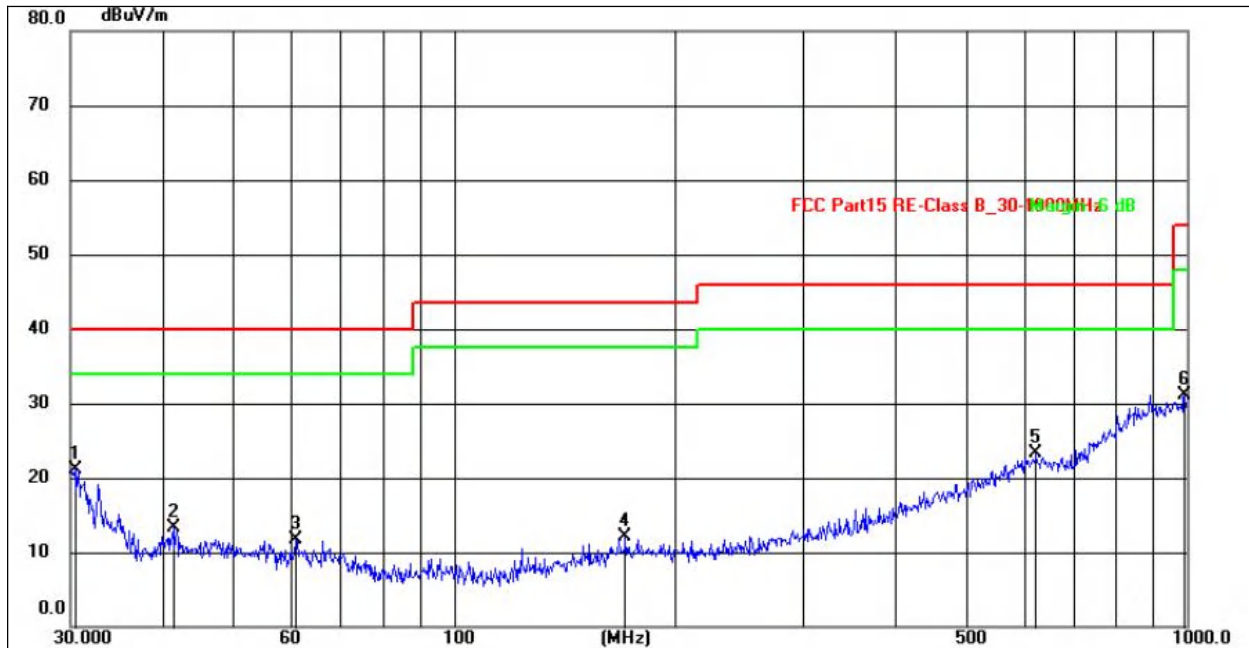

No.	Frequency (MHz)	Reading (dBuV)	Factor (dB/m)	Level (dBuV/m)	Limit (dBuV/m)	Margin (dB)	Detector
1	30.4237	39.34	-18.27	21.07	40.00	-18.93	QP
2	41.4215	30.06	-16.82	13.24	40.00	-26.76	QP
3	60.9174	29.95	-18.30	11.65	40.00	-28.35	QP
4	171.3925	31.79	-19.75	12.04	43.50	-31.46	QP
5	622.8900	30.55	-7.34	23.21	46.00	-22.79	QP
6	993.0113	31.06	0.05	31.11	54.00	-22.89	QP

Remarks:

- 1.An initial pre-scan was performed on the peak detector.
- 2.Quasi-Peak measurement were performed at the frequencies with maximized peak emission.
- 3.The emission levels of other frequencies are very lower than the limit and not show in test report.
- 4.Final Level = Reading level + Correct Factor
- 5.Correct Factor= Antenna factor+ Cable loss factor - Amplifier factor
- 6.Margin= Measurement Level-Limit
- 7.The test data shows only the worst case  $\pi/4$ -DQPSK and DC 3.7Vmode



Between 30MHz – 1GHz(Right ear headphones)

Temperature:	26°C	Relative Humidity:	54%
Pressure:	101 kPa	Polarization:	Horizontal
Test Voltage:	DC 3.7V	Mode:	BT TX

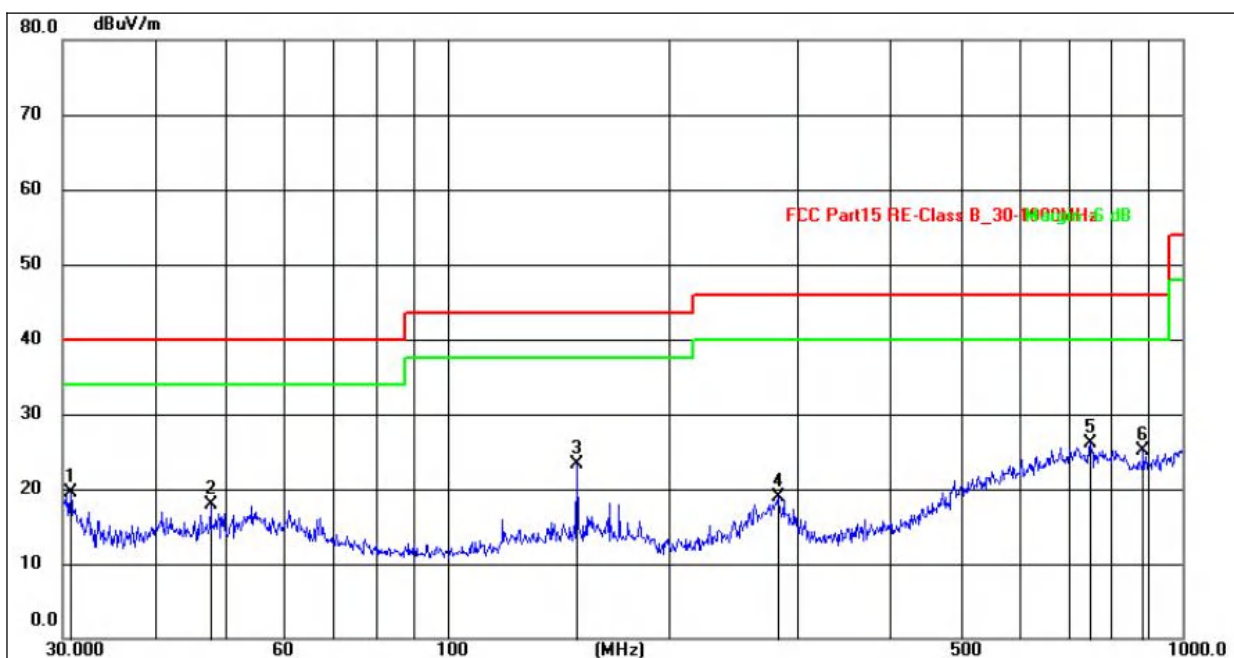

No.	Frequency (MHz)	Reading (dBuV)	Factor (dB/m)	Level (dBuV/m)	Limit (dBuV/m)	Margin (dB)	Detector
1	30.7454	33.68	-14.23	19.45	40.00	-20.55	QP
2	47.6584	31.89	-13.95	17.94	40.00	-22.06	QP
3	150.0107	39.58	-16.35	23.23	43.50	-20.27	QP
4	281.9945	33.12	-14.20	18.92	46.00	-27.08	QP
5	750.1082	32.58	-6.54	26.04	46.00	-19.96	QP
6	884.5027	31.80	-6.69	25.11	46.00	-20.89	QP





Temperature:	26°C	Relative Humidity:	54%
Pressure:	101kPa	Polarization:	Vertical
Test Voltage:	DC 3.7V	Mode:	BT TX

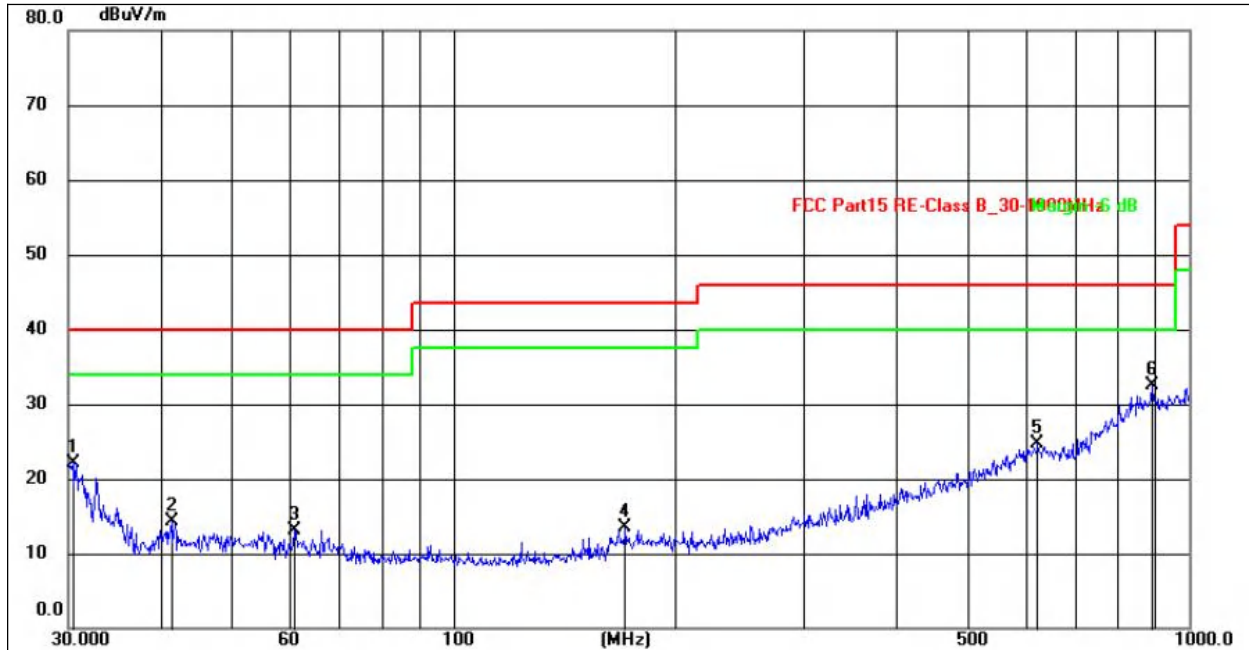

No.	Frequency (MHz)	Reading (dBuV)	Factor (dB/m)	Level (dBuV/m)	Limit (dBuV/m)	Margin (dB)	Detector
1	30.4237	40.34	-18.27	22.07	40.00	-17.93	QP
2	41.4215	31.06	-16.82	14.24	40.00	-25.76	QP
3	60.9174	31.45	-18.30	13.15	40.00	-26.85	QP
4	171.3925	33.29	-19.75	13.54	43.50	-29.96	QP
5	622.8900	32.05	-7.34	24.71	46.00	-21.29	QP
6	890.7277	33.24	-0.70	32.54	46.00	-13.46	QP

Remarks:

1. An initial pre-scan was performed on the peak detector.
2. Quasi-Peak measurement were performed at the frequencies with maximized peak emission.
3. The emission levels of other frequencies are very lower than the limit and not show in test report.
4. Final Level = Reading level + Correct Factor
5. Correct Factor = Antenna factor + Cable loss factor - Amplifier factor
6. Margin = Measurement Level - Limit
7. The test data shows only the worst case  $\pi/4$ -DQPSK and DC 3.7V mode



1GHz~25GHz(Left ear headphones)

## GFSK

Polar (H/V)	Frequency	Meter Reading	Pre-amplifier	Cable Loss	Antenna Factor	Emission Level	Limits	Margin	Detector Type
	(MHz)	(dBuV)	(dB)	(dB)	(dB)	(dBuV/m)	(dBuV/m)	(dB)	
Low Channel:2402MHz									
V	4804.00	52.29	30.55	5.77	24.66	52.17	74.00	-21.83	Pk
V	4804.00	43.32	30.55	5.77	24.66	43.20	54.00	-10.80	AV
V	7206.00	51.41	30.33	6.32	24.55	51.95	74.00	-22.05	Pk
V	7206.00	43.06	30.33	6.32	24.55	43.60	54.00	-10.40	AV
V	9608.00	52.62	30.85	7.45	24.69	53.91	74.00	-20.09	Pk
V	9608.00	43.31	30.85	7.45	24.69	44.60	54.00	-9.40	AV
V	12010.00	51.60	31.02	8.99	25.57	55.14	74.00	-18.86	Pk
V	12010.00	43.66	31.02	8.99	25.57	47.20	54.00	-6.80	AV
H	4804.00	53.54	30.55	5.77	24.66	53.42	74.00	-20.58	Pk
H	4804.00	43.89	30.55	5.77	24.66	43.77	54.00	-10.23	AV
H	7206.00	54.23	30.33	6.32	24.55	54.77	74.00	-19.23	Pk
H	7206.00	43.99	30.33	6.32	24.55	44.53	54.00	-9.47	AV
H	9608.00	50.26	30.85	7.45	24.69	51.55	74.00	-22.45	Pk
H	9608.00	43.86	30.85	7.45	24.69	45.15	54.00	-8.85	AV
H	12010.00	53.01	31.02	8.99	25.57	56.55	74.00	-17.45	Pk
H	12010.00	43.97	31.02	8.99	25.57	47.51	54.00	-6.49	AV

Polar (H/V)	Frequency	Meter Reading	Pre-amplifier	Cable Loss	Antenna Factor	Emission Level	Limits	Margin	Detector Type
	(MHz)	(dBuV)	(dB)	(dB)	(dB)	(dBuV/m)	(dBuV/m)	(dB)	
Middle Channel:2441MHz									
V	4882.00	53.50	30.55	5.77	24.66	53.38	74.00	-20.62	Pk
V	4882.00	43.79	30.55	5.77	24.66	43.67	54.00	-10.33	AV
V	7323.00	53.02	30.33	6.32	24.55	53.56	74.00	-20.44	Pk
V	7323.00	43.89	30.33	6.32	24.55	44.43	54.00	-9.57	AV
V	9764.00	54.83	30.85	7.45	24.69	56.12	74.00	-17.88	Pk
V	9764.00	43.97	30.85	7.45	24.69	45.26	54.00	-8.74	AV
V	12205.00	51.25	31.02	8.99	25.57	54.79	74.00	-19.21	Pk
V	12205.00	43.66	31.02	8.99	25.57	47.20	54.00	-6.80	AV
H	4882.00	51.38	30.55	5.77	24.66	51.26	74.00	-22.74	Pk
H	4882.00	43.87	30.55	5.77	24.66	43.75	54.00	-10.25	AV
H	7323.00	51.97	30.33	6.32	24.55	52.51	74.00	-21.49	Pk
H	7323.00	43.49	30.33	6.32	24.55	44.03	54.00	-9.97	AV
H	9764.00	52.35	30.85	7.45	24.69	53.64	74.00	-20.36	Pk
H	9764.00	43.21	30.85	7.45	24.69	44.50	54.00	-9.50	AV
H	12205.00	51.08	31.02	8.99	25.57	54.62	74.00	-19.38	Pk
H	12205.00	43.15	31.02	8.99	25.57	46.69	54.00	-7.31	AV



Polar (H/V)	Frequency	Meter Reading	Pre-ampli fier	Cable Loss	Antenna Factor	Emission Level	Limits	Margin	Detector Type
	(MHz)	(dBuV)	(dB)	(dB)	(dB)	(dBuV/m)	(dBuV/m)	(dB)	
High Channel:2480MHz									
V	4960.00	50.47	30.55	5.77	24.66	50.35	74.00	-23.65	Pk
V	4960.00	43.63	30.55	5.77	24.66	43.51	54.00	-10.49	AV
V	7440.00	54.37	30.33	6.32	24.55	54.91	74.00	-19.09	Pk
V	7440.00	43.21	30.33	6.32	24.55	43.75	54.00	-10.25	AV
V	9920.00	53.13	30.85	7.45	24.69	54.42	74.00	-19.58	Pk
V	9920.00	43.33	30.85	7.45	24.69	44.62	54.00	-9.38	AV
V	12400.00	53.75	31.02	8.99	25.57	57.29	74.00	-16.71	Pk
V	12400.00	43.26	31.02	8.99	25.57	46.80	54.00	-7.20	AV
H	4960.00	54.33	30.55	5.77	24.66	54.21	74.00	-19.79	Pk
H	4960.00	43.57	30.55	5.77	24.66	43.45	54.00	-10.55	AV
H	7440.00	50.38	30.33	6.32	24.55	50.92	74.00	-23.08	Pk
H	7440.00	43.27	30.33	6.32	24.55	43.81	54.00	-10.19	AV
H	9920.00	54.54	30.85	7.45	24.69	55.83	74.00	-18.17	Pk
H	9920.00	43.98	30.85	7.45	24.69	45.27	54.00	-8.73	AV
H	12400.00	52.04	31.02	8.99	25.57	55.58	74.00	-18.42	Pk
H	12400.00	43.11	31.02	8.99	25.57	46.65	54.00	-7.35	AV

## Remark:

1. Emission Level = Meter Reading + Antenna Factor + Cable Loss – Pre-amplifier,  
Margin= Emission Level - Limit
2. If peak below the average limit, the average emission was no test.
3. The amplitude of spurious emissions which are attenuated by more than 20dB below the permissible value has no need to be reported.





$\pi/4$ -DQPSK

Polar (H/V)	Frequency	Meter Reading	Pre-amplifier	Cable Loss	Antenna Factor	Emission Level	Limits	Margin	Detector Type
	(MHz)	(dBuV)	(dB)	(dB)	(dB)	(dBuV/m)	(dBuV/m)	(dB)	
Low Channel:2402MHz									
V	4804.00	51.66	30.55	5.77	24.66	51.54	74.00	-22.46	Pk
V	4804.00	43.03	30.55	5.77	24.66	42.91	54.00	-11.09	AV
V	7206.00	54.74	30.33	6.32	24.55	55.28	74.00	-18.72	Pk
V	7206.00	43.86	30.33	6.32	24.55	44.40	54.00	-9.60	AV
V	9608.00	51.08	30.85	7.45	24.69	52.37	74.00	-21.63	Pk
V	9608.00	43.36	30.85	7.45	24.69	44.65	54.00	-9.35	AV
V	12010.00	54.87	31.02	8.99	25.57	58.41	74.00	-15.59	Pk
V	12010.00	43.57	31.02	8.99	25.57	47.11	54.00	-6.89	AV
H	4804.00	51.80	30.55	5.77	24.66	51.68	74.00	-22.32	Pk
H	4804.00	43.02	30.55	5.77	24.66	42.90	54.00	-11.10	AV
H	7206.00	54.28	30.33	6.32	24.55	54.82	74.00	-19.18	Pk
H	7206.00	43.38	30.33	6.32	24.55	43.92	54.00	-10.08	AV
H	9608.00	51.30	30.85	7.45	24.69	52.59	74.00	-21.41	Pk
H	9608.00	43.29	30.85	7.45	24.69	44.58	54.00	-9.42	AV
H	12010.00	51.76	31.02	8.99	25.57	55.30	74.00	-18.70	Pk
H	12010.00	43.34	31.02	8.99	25.57	46.88	54.00	-7.12	AV

Polar (H/V)	Frequency	Meter Reading	Pre-amplifier	Cable Loss	Antenna Factor	Emission Level	Limits	Margin	Detector Type
	(MHz)	(dBuV)	(dB)	(dB)	(dB)	(dBuV/m)	(dBuV/m)	(dB)	
Middle Channel:2441MHz									
V	4882.00	50.75	30.55	5.77	24.66	50.63	74.00	-23.37	Pk
V	4882.00	43.94	30.55	5.77	24.66	43.82	54.00	-10.18	AV
V	7323.00	53.85	30.33	6.32	24.55	54.39	74.00	-19.61	Pk
V	7323.00	43.76	30.33	6.32	24.55	44.30	54.00	-9.70	AV
V	9764.00	50.68	30.85	7.45	24.69	51.97	74.00	-22.03	Pk
V	9764.00	43.44	30.85	7.45	24.69	44.73	54.00	-9.27	AV
V	12205.00	53.51	31.02	8.99	25.57	57.05	74.00	-16.95	Pk
V	12205.00	43.62	31.02	8.99	25.57	47.16	54.00	-6.84	AV
H	4882.00	51.27	30.55	5.77	24.66	51.15	74.00	-22.85	Pk
H	4882.00	43.68	30.55	5.77	24.66	43.56	54.00	-10.44	AV
H	7323.00	51.07	30.33	6.32	24.55	51.61	74.00	-22.39	Pk
H	7323.00	43.52	30.33	6.32	24.55	44.06	54.00	-9.94	AV
H	9764.00	53.59	30.85	7.45	24.69	54.88	74.00	-19.12	Pk
H	9764.00	43.93	30.85	7.45	24.69	45.22	54.00	-8.78	AV
H	12205.00	52.39	31.02	8.99	25.57	55.93	74.00	-18.07	Pk
H	12205.00	43.18	31.02	8.99	25.57	46.72	54.00	-7.28	AV



Polar (H/V)	Frequency	Meter Reading	Pre-ampli fier	Cable Loss	Antenna Factor	Emission Level	Limits	Margin	Detector Type
	(MHz)	(dBuV)	(dB)	(dB)	(dB)	(dBuV/m)	(dBuV/m)	(dB)	
High Channel:2480MHz									
V	4960.00	54.13	30.55	5.77	24.66	54.01	74.00	-19.99	Pk
V	4960.00	43.63	30.55	5.77	24.66	43.51	54.00	-10.49	AV
V	7440.00	50.46	30.33	6.32	24.55	51.00	74.00	-23.00	Pk
V	7440.00	43.72	30.33	6.32	24.55	44.26	54.00	-9.74	AV
V	9920.00	54.87	30.85	7.45	24.69	56.16	74.00	-17.84	Pk
V	9920.00	43.80	30.85	7.45	24.69	45.09	54.00	-8.91	AV
V	12400.00	50.58	31.02	8.99	25.57	54.12	74.00	-19.88	Pk
V	12400.00	43.42	31.02	8.99	25.57	46.96	54.00	-7.04	AV
H	4960.00	53.84	30.55	5.77	24.66	53.72	74.00	-20.28	Pk
H	4960.00	43.76	30.55	5.77	24.66	43.64	54.00	-10.36	AV
H	7440.00	52.69	30.33	6.32	24.55	53.23	74.00	-20.77	Pk
H	7440.00	43.80	30.33	6.32	24.55	44.34	54.00	-9.66	AV
H	9920.00	51.62	30.85	7.45	24.69	52.91	74.00	-21.09	Pk
H	9920.00	43.71	30.85	7.45	24.69	45.00	54.00	-9.00	AV
H	12400.00	52.54	31.02	8.99	25.57	56.08	74.00	-17.92	Pk
H	12400.00	43.91	31.02	8.99	25.57	47.45	54.00	-6.55	AV

## Remark:

1. Emission Level = Meter Reading + Antenna Factor + Cable Loss – Pre-amplifier,  
Margin= Emission Level - Limit
2. If peak below the average limit, the average emission was no test.
3. The amplitude of spurious emissions which are attenuated by more than 20dB below the permissible value has no need to be reported.



8-DPSK

Polar (H/V)	Frequency	Meter Reading	Pre-amplifier	Cable Loss	Antenna Factor	Emission Level	Limits	Margin	Detector Type
	(MHz)	(dBuV)	(dB)	(dB)	(dB)	(dBuV/m)	(dBuV/m)	(dB)	
Low Channel:2402MHz									
V	4804.00	52.40	30.55	5.77	24.66	52.28	74.00	-21.72	Pk
V	4804.00	43.07	30.55	5.77	24.66	42.95	54.00	-11.05	AV
V	7206.00	52.97	30.33	6.32	24.55	53.51	74.00	-20.49	Pk
V	7206.00	43.20	30.33	6.32	24.55	43.74	54.00	-10.26	AV
V	9608.00	52.97	30.85	7.45	24.69	54.26	74.00	-19.74	Pk
V	9608.00	43.01	30.85	7.45	24.69	44.30	54.00	-9.70	AV
V	12010.00	50.53	31.02	8.99	25.57	54.07	74.00	-19.93	Pk
V	12010.00	43.02	31.02	8.99	25.57	46.56	54.00	-7.44	AV
H	4804.00	51.08	30.55	5.77	24.66	50.96	74.00	-23.04	Pk
H	4804.00	43.73	30.55	5.77	24.66	43.61	54.00	-10.39	AV
H	7206.00	51.08	30.33	6.32	24.55	51.62	74.00	-22.38	Pk
H	7206.00	43.49	30.33	6.32	24.55	44.03	54.00	-9.97	AV
H	9608.00	50.94	30.85	7.45	24.69	52.23	74.00	-21.77	Pk
H	9608.00	43.75	30.85	7.45	24.69	45.04	54.00	-8.96	AV
H	12010.00	54.19	31.02	8.99	25.57	57.73	74.00	-16.27	Pk
H	12010.00	43.83	31.02	8.99	25.57	47.37	54.00	-6.63	AV

Polar (H/V)	Frequency	Meter Reading	Pre-amplifier	Cable Loss	Antenna Factor	Emission Level	Limits	Margin	Detector Type
	(MHz)	(dBuV)	(dB)	(dB)	(dB)	(dBuV/m)	(dBuV/m)	(dB)	
Middle Channel:2441MHz									
V	4882.00	51.17	30.55	5.77	24.66	51.05	74.00	-22.95	Pk
V	4882.00	43.51	30.55	5.77	24.66	43.39	54.00	-10.61	AV
V	7323.00	51.05	30.33	6.32	24.55	51.59	74.00	-22.41	Pk
V	7323.00	43.53	30.33	6.32	24.55	44.07	54.00	-9.93	AV
V	9764.00	54.09	30.85	7.45	24.69	55.38	74.00	-18.62	Pk
V	9764.00	43.01	30.85	7.45	24.69	44.30	54.00	-9.70	AV
V	12205.00	51.48	31.02	8.99	25.57	55.02	74.00	-18.98	Pk
V	12205.00	43.96	31.02	8.99	25.57	47.50	54.00	-6.50	AV
H	4882.00	50.38	30.55	5.77	24.66	50.26	74.00	-23.74	Pk
H	4882.00	43.76	30.55	5.77	24.66	43.64	54.00	-10.36	AV
H	7323.00	51.70	30.33	6.32	24.55	52.24	74.00	-21.76	Pk
H	7323.00	43.06	30.33	6.32	24.55	43.60	54.00	-10.40	AV
H	9764.00	54.06	30.85	7.45	24.69	55.35	74.00	-18.65	Pk
H	9764.00	43.08	30.85	7.45	24.69	44.37	54.00	-9.63	AV
H	12205.00	54.87	31.02	8.99	25.57	58.41	74.00	-15.59	Pk
H	12205.00	43.72	31.02	8.99	25.57	47.26	54.00	-6.74	AV



Polar (H/V)	Frequency	Meter Reading	Pre-ampli fier	Cable Loss	Antenna Factor	Emission Level	Limits	Margin	Detector Type
	(MHz)	(dBuV)	(dB)	(dB)	(dB)	(dBuV/m)	(dBuV/m)	(dB)	
High Channel:2480MHz									
V	4960.00	54.86	30.55	5.77	24.66	54.74	74.00	-19.26	Pk
V	4960.00	43.76	30.55	5.77	24.66	43.64	54.00	-10.36	AV
V	7440.00	54.07	30.33	6.32	24.55	54.61	74.00	-19.39	Pk
V	7440.00	43.51	30.33	6.32	24.55	44.05	54.00	-9.95	AV
V	9920.00	54.37	30.85	7.45	24.69	55.66	74.00	-18.34	Pk
V	9920.00	43.39	30.85	7.45	24.69	44.68	54.00	-9.32	AV
V	12400.00	50.13	31.02	8.99	25.57	53.67	74.00	-20.33	Pk
V	12400.00	43.58	31.02	8.99	25.57	47.12	54.00	-6.88	AV
H	4960.00	50.18	30.55	5.77	24.66	50.06	74.00	-23.94	Pk
H	4960.00	43.07	30.55	5.77	24.66	42.95	54.00	-11.05	AV
H	7440.00	50.36	30.33	6.32	24.55	50.90	74.00	-23.10	Pk
H	7440.00	43.29	30.33	6.32	24.55	43.83	54.00	-10.17	AV
H	9920.00	52.43	30.85	7.45	24.69	53.72	74.00	-20.28	Pk
H	9920.00	43.97	30.85	7.45	24.69	45.26	54.00	-8.74	AV
H	12400.00	50.22	31.02	8.99	25.57	53.76	74.00	-20.24	Pk
H	12400.00	43.49	31.02	8.99	25.57	47.03	54.00	-6.97	AV

## Remark:

1. Emission Level = Meter Reading + Antenna Factor + Cable Loss – Pre-amplifier,  
Margin= Emission Level - Limit
2. If peak below the average limit, the average emission was no test.
3. The amplitude of spurious emissions which are attenuated by more than 20dB below the permissible value has no need to be reported.



1GHz~25GHz(Right ear headphones)

## GFSK

Polar (H/V)	Frequency	Meter Reading	Pre-amplifier	Cable Loss	Antenna Factor	Emission Level	Limits	Margin	Detector Type
	(MHz)	(dBuV)	(dB)	(dB)	(dB)	(dBuV/m)	(dBuV/m)	(dB)	
Low Channel:2402MHz									
V	4804.00	53.97	30.55	5.77	24.66	53.85	74.00	-20.15	Pk
V	4804.00	43.53	30.55	5.77	24.66	43.41	54.00	-10.59	AV
V	7206.00	51.37	30.33	6.32	24.55	51.91	74.00	-22.09	Pk
V	7206.00	43.81	30.33	6.32	24.55	44.35	54.00	-9.65	AV
V	9608.00	52.86	30.85	7.45	24.69	54.15	74.00	-19.85	Pk
V	9608.00	43.33	30.85	7.45	24.69	44.62	54.00	-9.38	AV
V	12010.00	54.47	31.02	8.99	25.57	58.01	74.00	-15.99	Pk
V	12010.00	43.76	31.02	8.99	25.57	47.30	54.00	-6.70	AV
H	4804.00	53.54	30.55	5.77	24.66	53.42	74.00	-20.58	Pk
H	4804.00	43.27	30.55	5.77	24.66	43.15	54.00	-10.85	AV
H	7206.00	53.93	30.33	6.32	24.55	54.47	74.00	-19.53	Pk
H	7206.00	43.15	30.33	6.32	24.55	43.69	54.00	-10.31	AV
H	9608.00	50.22	30.85	7.45	24.69	51.51	74.00	-22.49	Pk
H	9608.00	43.07	30.85	7.45	24.69	44.36	54.00	-9.64	AV
H	12010.00	51.15	31.02	8.99	25.57	54.69	74.00	-19.31	Pk
H	12010.00	43.60	31.02	8.99	25.57	47.14	54.00	-6.86	AV

Polar (H/V)	Frequency	Meter Reading	Pre-amplifier	Cable Loss	Antenna Factor	Emission Level	Limits	Margin	Detector Type
	(MHz)	(dBuV)	(dB)	(dB)	(dB)	(dBuV/m)	(dBuV/m)	(dB)	
Middle Channel:2441MHz									
V	4882.00	50.21	30.55	5.77	24.66	50.09	74.00	-23.91	Pk
V	4882.00	43.05	30.55	5.77	24.66	42.93	54.00	-11.07	AV
V	7323.00	50.79	30.33	6.32	24.55	51.33	74.00	-22.67	Pk
V	7323.00	43.99	30.33	6.32	24.55	44.53	54.00	-9.47	AV
V	9764.00	51.33	30.85	7.45	24.69	52.62	74.00	-21.38	Pk
V	9764.00	43.88	30.85	7.45	24.69	45.17	54.00	-8.83	AV
V	12205.00	53.97	31.02	8.99	25.57	57.51	74.00	-16.49	Pk
V	12205.00	43.26	31.02	8.99	25.57	46.80	54.00	-7.20	AV
H	4882.00	53.20	30.55	5.77	24.66	53.08	74.00	-20.92	Pk
H	4882.00	43.86	30.55	5.77	24.66	43.74	54.00	-10.26	AV
H	7323.00	50.93	30.33	6.32	24.55	51.47	74.00	-22.53	Pk
H	7323.00	43.55	30.33	6.32	24.55	44.09	54.00	-9.91	AV
H	9764.00	51.84	30.85	7.45	24.69	53.13	74.00	-20.87	Pk
H	9764.00	43.84	30.85	7.45	24.69	45.13	54.00	-8.87	AV
H	12205.00	51.54	31.02	8.99	25.57	55.08	74.00	-18.92	Pk
H	12205.00	43.77	31.02	8.99	25.57	47.31	54.00	-6.69	AV



Polar (H/V)	Frequency	Meter Reading	Pre-ampli fier	Cable Loss	Antenna Factor	Emission Level	Limits	Margin	Detector Type
	(MHz)	(dBuV)	(dB)	(dB)	(dB)	(dBuV/m)	(dBuV/m)	(dB)	
High Channel:2480MHz									
V	4960.00	50.54	30.55	5.77	24.66	50.42	74.00	-23.58	Pk
V	4960.00	43.49	30.55	5.77	24.66	43.37	54.00	-10.63	AV
V	7440.00	52.45	30.33	6.32	24.55	52.99	74.00	-21.01	Pk
V	7440.00	43.24	30.33	6.32	24.55	43.78	54.00	-10.22	AV
V	9920.00	53.94	30.85	7.45	24.69	55.23	74.00	-18.77	Pk
V	9920.00	43.75	30.85	7.45	24.69	45.04	54.00	-8.96	AV
V	12400.00	53.38	31.02	8.99	25.57	56.92	74.00	-17.08	Pk
V	12400.00	43.84	31.02	8.99	25.57	47.38	54.00	-6.62	AV
H	4960.00	51.07	30.55	5.77	24.66	50.95	74.00	-23.05	Pk
H	4960.00	43.03	30.55	5.77	24.66	42.91	54.00	-11.09	AV
H	7440.00	53.57	30.33	6.32	24.55	54.11	74.00	-19.89	Pk
H	7440.00	43.17	30.33	6.32	24.55	43.71	54.00	-10.29	AV
H	9920.00	53.47	30.85	7.45	24.69	54.76	74.00	-19.24	Pk
H	9920.00	43.33	30.85	7.45	24.69	44.62	54.00	-9.38	AV
H	12400.00	50.59	31.02	8.99	25.57	54.13	74.00	-19.87	Pk
H	12400.00	43.32	31.02	8.99	25.57	46.86	54.00	-7.14	AV

## Remark:

1. Emission Level = Meter Reading + Antenna Factor + Cable Loss – Pre-amplifier,  
Margin= Emission Level - Limit
2. If peak below the average limit, the average emission was no test.
3. The amplitude of spurious emissions which are attenuated by more than 20dB below the permissible value has no need to be reported.

 $\pi/4$ -DQPSK

Polar (H/V)	Frequency	Meter Reading	Pre-amplifier	Cable Loss	Antenna Factor	Emission Level	Limits	Margin	Detector Type
	(MHz)	(dBuV)	(dB)	(dB)	(dB)	(dBuV/m)	(dBuV/m)	(dB)	
Low Channel:2402MHz									
V	4804.00	52.12	30.55	5.77	24.66	52.00	74.00	-22.00	Pk
V	4804.00	43.80	30.55	5.77	24.66	43.68	54.00	-10.32	AV
V	7206.00	54.46	30.33	6.32	24.55	55.00	74.00	-19.00	Pk
V	7206.00	43.82	30.33	6.32	24.55	44.36	54.00	-9.64	AV
V	9608.00	54.05	30.85	7.45	24.69	55.34	74.00	-18.66	Pk
V	9608.00	43.98	30.85	7.45	24.69	45.27	54.00	-8.73	AV
V	12010.00	52.65	31.02	8.99	25.57	56.19	74.00	-17.81	Pk
V	12010.00	43.02	31.02	8.99	25.57	46.56	54.00	-7.44	AV
H	4804.00	51.87	30.55	5.77	24.66	51.75	74.00	-22.25	Pk
H	4804.00	43.05	30.55	5.77	24.66	42.93	54.00	-11.07	AV
H	7206.00	50.33	30.33	6.32	24.55	50.87	74.00	-23.13	Pk
H	7206.00	43.40	30.33	6.32	24.55	43.94	54.00	-10.06	AV
H	9608.00	51.24	30.85	7.45	24.69	52.53	74.00	-21.47	Pk
H	9608.00	43.38	30.85	7.45	24.69	44.67	54.00	-9.33	AV
H	12010.00	51.63	31.02	8.99	25.57	55.17	74.00	-18.83	Pk
H	12010.00	43.65	31.02	8.99	25.57	47.19	54.00	-6.81	AV

Polar (H/V)	Frequency	Meter Reading	Pre-amplifier	Cable Loss	Antenna Factor	Emission Level	Limits	Margin	Detector Type
	(MHz)	(dBuV)	(dB)	(dB)	(dB)	(dBuV/m)	(dBuV/m)	(dB)	
Middle Channel:2441MHz									
V	4882.00	53.86	30.55	5.77	24.66	53.74	74.00	-20.26	Pk
V	4882.00	43.71	30.55	5.77	24.66	43.59	54.00	-10.41	AV
V	7323.00	53.79	30.33	6.32	24.55	54.33	74.00	-19.67	Pk
V	7323.00	43.34	30.33	6.32	24.55	43.88	54.00	-10.12	AV
V	9764.00	53.07	30.85	7.45	24.69	54.36	74.00	-19.64	Pk
V	9764.00	43.79	30.85	7.45	24.69	45.08	54.00	-8.92	AV
V	12205.00	53.29	31.02	8.99	25.57	56.83	74.00	-17.17	Pk
V	12205.00	43.18	31.02	8.99	25.57	46.72	54.00	-7.28	AV
H	4882.00	52.42	30.55	5.77	24.66	52.30	74.00	-21.70	Pk
H	4882.00	43.64	30.55	5.77	24.66	43.52	54.00	-10.48	AV
H	7323.00	52.36	30.33	6.32	24.55	52.90	74.00	-21.10	Pk
H	7323.00	43.79	30.33	6.32	24.55	44.33	54.00	-9.67	AV
H	9764.00	54.75	30.85	7.45	24.69	56.04	74.00	-17.96	Pk
H	9764.00	43.32	30.85	7.45	24.69	44.61	54.00	-9.39	AV
H	12205.00	52.70	31.02	8.99	25.57	56.24	74.00	-17.76	Pk
H	12205.00	43.45	31.02	8.99	25.57	46.99	54.00	-7.01	AV





Polar (H/V)	Frequency	Meter Reading	Pre-amplifier	Cable Loss	Antenna Factor	Emission Level	Limits	Margin	Detector Type
	(MHz)	(dBuV)	(dB)	(dB)	(dB)	(dBuV/m)	(dBuV/m)	(dB)	
High Channel:2480MHz									
V	4960.00	53.32	30.55	5.77	24.66	53.20	74.00	-20.80	Pk
V	4960.00	43.93	30.55	5.77	24.66	43.81	54.00	-10.19	AV
V	7440.00	53.86	30.33	6.32	24.55	54.40	74.00	-19.60	Pk
V	7440.00	43.43	30.33	6.32	24.55	43.97	54.00	-10.03	AV
V	9920.00	51.88	30.85	7.45	24.69	53.17	74.00	-20.83	Pk
V	9920.00	43.77	30.85	7.45	24.69	45.06	54.00	-8.94	AV
V	12400.00	53.05	31.02	8.99	25.57	56.59	74.00	-17.41	Pk
V	12400.00	43.45	31.02	8.99	25.57	46.99	54.00	-7.01	AV
H	4960.00	51.49	30.55	5.77	24.66	51.37	74.00	-22.63	Pk
H	4960.00	43.53	30.55	5.77	24.66	43.41	54.00	-10.59	AV
H	7440.00	54.36	30.33	6.32	24.55	54.90	74.00	-19.10	Pk
H	7440.00	43.48	30.33	6.32	24.55	44.02	54.00	-9.98	AV
H	9920.00	51.67	30.85	7.45	24.69	52.96	74.00	-21.04	Pk
H	9920.00	44.00	30.85	7.45	24.69	45.29	54.00	-8.71	AV
H	12400.00	53.86	31.02	8.99	25.57	57.40	74.00	-16.60	Pk
H	12400.00	43.54	31.02	8.99	25.57	47.08	54.00	-6.92	AV

Remark:

1. Emission Level = Meter Reading + Antenna Factor + Cable Loss – Pre-amplifier, Margin= Emission Level - Limit
2. If peak below the average limit, the average emission was no test.
3. The amplitude of spurious emissions which are attenuated by more than 20dB below the permissible value has no need to be reported.





## 8-DPSK

Polar (H/V)	Frequency	Meter Reading	Pre-amplifier	Cable Loss	Antenna Factor	Emission Level	Limits	Margin	Detector Type
	(MHz)	(dBuV)	(dB)	(dB)	(dB)	(dBuV/m)	(dBuV/m)	(dB)	
Low Channel:2402MHz									
V	4804.00	50.07	30.55	5.77	24.66	49.95	74.00	-24.05	Pk
V	4804.00	43.49	30.55	5.77	24.66	43.37	54.00	-10.63	AV
V	7206.00	50.85	30.33	6.32	24.55	51.39	74.00	-22.61	Pk
V	7206.00	43.43	30.33	6.32	24.55	43.97	54.00	-10.03	AV
V	9608.00	53.78	30.85	7.45	24.69	55.07	74.00	-18.93	Pk
V	9608.00	43.35	30.85	7.45	24.69	44.64	54.00	-9.36	AV
V	12010.00	50.35	31.02	8.99	25.57	53.89	74.00	-20.11	Pk
V	12010.00	43.72	31.02	8.99	25.57	47.26	54.00	-6.74	AV
H	4804.00	50.23	30.55	5.77	24.66	50.11	74.00	-23.89	Pk
H	4804.00	43.47	30.55	5.77	24.66	43.35	54.00	-10.65	AV
H	7206.00	52.38	30.33	6.32	24.55	52.92	74.00	-21.08	Pk
H	7206.00	43.03	30.33	6.32	24.55	43.57	54.00	-10.43	AV
H	9608.00	53.12	30.85	7.45	24.69	54.41	74.00	-19.59	Pk
H	9608.00	43.31	30.85	7.45	24.69	44.60	54.00	-9.40	AV
H	12010.00	53.68	31.02	8.99	25.57	57.22	74.00	-16.78	Pk
H	12010.00	43.10	31.02	8.99	25.57	46.64	54.00	-7.36	AV

Polar (H/V)	Frequency	Meter Reading	Pre-amplifier	Cable Loss	Antenna Factor	Emission Level	Limits	Margin	Detector Type
	(MHz)	(dBuV)	(dB)	(dB)	(dB)	(dBuV/m)	(dBuV/m)	(dB)	
Middle Channel:2441MHz									
V	4882.00	52.66	30.55	5.77	24.66	52.54	74.00	-21.46	Pk
V	4882.00	43.45	30.55	5.77	24.66	43.33	54.00	-10.67	AV
V	7323.00	50.56	30.33	6.32	24.55	51.10	74.00	-22.90	Pk
V	7323.00	43.08	30.33	6.32	24.55	43.62	54.00	-10.38	AV
V	9764.00	51.60	30.85	7.45	24.69	52.89	74.00	-21.11	Pk
V	9764.00	43.14	30.85	7.45	24.69	44.43	54.00	-9.57	AV
V	12205.00	54.08	31.02	8.99	25.57	57.62	74.00	-16.38	Pk
V	12205.00	43.89	31.02	8.99	25.57	47.43	54.00	-6.57	AV
H	4882.00	52.65	30.55	5.77	24.66	52.53	74.00	-21.47	Pk
H	4882.00	43.43	30.55	5.77	24.66	43.31	54.00	-10.69	AV
H	7323.00	51.44	30.33	6.32	24.55	51.98	74.00	-22.02	Pk
H	7323.00	43.38	30.33	6.32	24.55	43.92	54.00	-10.08	AV
H	9764.00	51.70	30.85	7.45	24.69	52.99	74.00	-21.01	Pk
H	9764.00	43.41	30.85	7.45	24.69	44.70	54.00	-9.30	AV
H	12205.00	50.94	31.02	8.99	25.57	54.48	74.00	-19.52	Pk
H	12205.00	43.16	31.02	8.99	25.57	46.70	54.00	-7.30	AV



Polar (H/V)	Frequency	Meter Reading	Pre-amplifier	Cable Loss	Antenna Factor	Emission Level	Limits	Margin	Detector Type
	(MHz)	(dBuV)	(dB)	(dB)	(dB)	(dBuV/m)	(dBuV/m)	(dB)	
High Channel:2480MHz									
V	4960.00	53.67	30.55	5.77	24.66	53.55	74.00	-20.45	Pk
V	4960.00	43.55	30.55	5.77	24.66	43.43	54.00	-10.57	AV
V	7440.00	51.56	30.33	6.32	24.55	52.10	74.00	-21.90	Pk
V	7440.00	43.43	30.33	6.32	24.55	43.97	54.00	-10.03	AV
V	9920.00	53.28	30.85	7.45	24.69	54.57	74.00	-19.43	Pk
V	9920.00	43.24	30.85	7.45	24.69	44.53	54.00	-9.47	AV
V	12400.00	50.33	31.02	8.99	25.57	53.87	74.00	-20.13	Pk
V	12400.00	43.91	31.02	8.99	25.57	47.45	54.00	-6.55	AV
H	4960.00	52.20	30.55	5.77	24.66	52.08	74.00	-21.92	Pk
H	4960.00	43.65	30.55	5.77	24.66	43.53	54.00	-10.47	AV
H	7440.00	50.09	30.33	6.32	24.55	50.63	74.00	-23.37	Pk
H	7440.00	43.51	30.33	6.32	24.55	44.05	54.00	-9.95	AV
H	9920.00	51.20	30.85	7.45	24.69	52.49	74.00	-21.51	Pk
H	9920.00	43.50	30.85	7.45	24.69	44.79	54.00	-9.21	AV
H	12400.00	50.73	31.02	8.99	25.57	54.27	74.00	-19.73	Pk
H	12400.00	43.01	31.02	8.99	25.57	46.55	54.00	-7.45	AV

Remark:

1. Emission Level = Meter Reading + Antenna Factor + Cable Loss – Pre-amplifier, Margin= Emission Level - Limit
2. If peak below the average limit, the average emission was no test.
3. The amplitude of spurious emissions which are attenuated by more than 20dB below the permissible value has no need to be reported.



## 5. RADIATED BAND EMISSION MEASUREMENT

### 5.1 Test Requirement:

Test Requirement:	FCC Part15 C Section 15.209 and 15.205				
Test Method:	ANSI C63.10: 2013				
Test Frequency Range:	All of the restrict bands were tested, only the worst band's (2310MHz to 2500MHz) data was showed.				
Test site:	Measurement Distance: 3m				
Receiver setup:	Frequency	Detector	RBW	VBW	Value
	Above 1GHz	Peak	1MHz	3MHz	Peak
		Average	1MHz	3MHz	Average

### LIMITS OF RADIATED EMISSION MEASUREMENT (Above 1000MHz)

FREQUENCY (MHz)	Limit (dBuV/m) (at 3M)	
	PEAK	AVERAGE
Above 1000	74	54

#### Notes:

- (1) The limit for radiated test was performed according to FCC PART 15C.
- (2) The tighter limit applies at the band edges.
- (3) Emission level (dBuV/m)=20log Emission level (uV/m).

Spectrum Parameter	Setting
Attenuation	Auto
Start Frequency	2300MHz
Stop Frequency	2520
RB / VB (emission in restricted band)	1 MHz / 1 MHz for Peak, 1 MHz / 10Hz for Average

### 5.2 TEST PROCEDURE

Above 1GHz test procedure as below:

- a. 1. The EUT was placed on the top of a rotating table 1.5 meters above the ground at a 3 meter camber. The table was rotated 360 degrees to determine the position of the highest radiation.
- b. The EUT was set 3 meters away from the interference-receiving antenna, which was mounted on the top of a variable-height antenna tower.
- c. The antenna height is varied from one meter to four meters above the ground to determine the maximum value of the field strength. Both horizontal and vertical polarizations of the antenna are set to make the measurement.
- d. For each suspected emission, the EUT was arranged to its worst case and then the antenna was tuned to heights from 1 meter to 4 meters and the rota table was turned from 0 degrees to 360 degrees to find the maximum reading.
- e. The test-receiver system was set to Peak Detect Function and Specified Bandwidth with Maximum Hold Mode.
- f. If the emission level of the EUT in peak mode was 10dB lower than the limit specified, then testing could be stopped and the peak values of the EUT would be reported. Otherwise the emissions that did not have 10dB margin would be re-tested one by one using peak, quasi-peak or average method as specified and then reported in a data sheet.



g. Test the EUT in the lowest channel, the Highest channel

Note:

Both horizontal and vertical antenna polarities were tested and performed pretest to three orthogonal axis. The worst case emissions were reported

### 5.3 DEVIATION FROM TEST STANDARD

No deviation

### 5.4 TEST SETUP

Radiated Emission Test-Up Frequency Above 1GHz

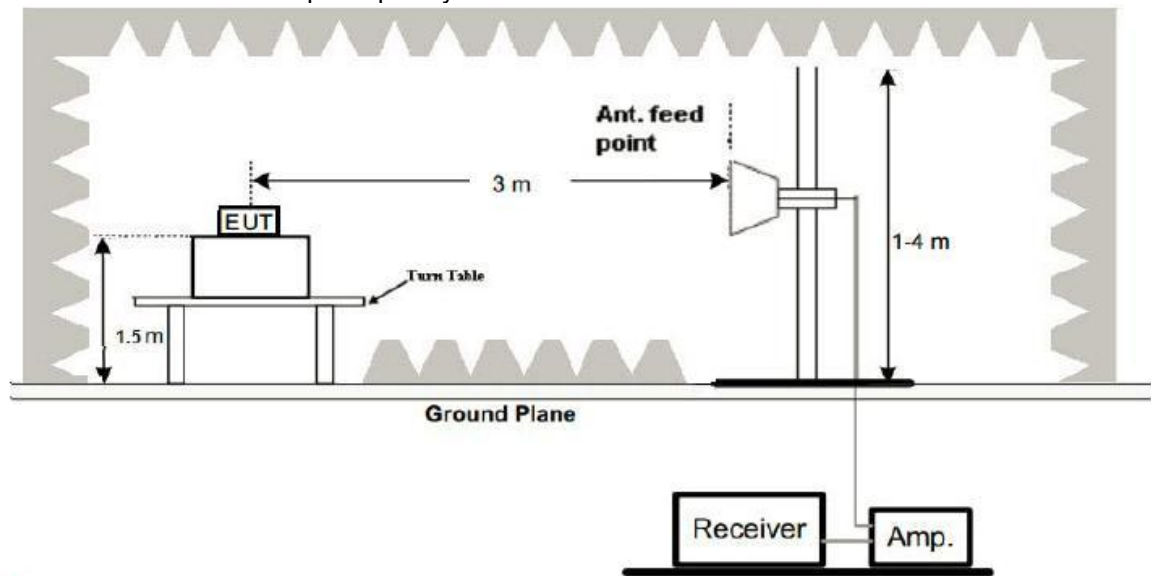

### 5.5 EUT OPERATING CONDITIONS

The EUT tested system was configured as the statements of 2.3 Unless otherwise a special operating condition is specified in the follows during the testing.



5.6 TEST RESULT

(Left ear headphones)

	Polar (H/V)	Frequency (MHz)	Meter Reading (dBuV)	Pre-amplifier (dB)	Cable Loss (dB)	Antenna Factor (dB/m)	Emission level (dBuV/m)	Limit (dBuV/m)	Detector Type	Result
GFSK	Low Channel: 2402MHz									
	H	2390.00	54.05	30.22	4.85	23.98	52.66	74.00	PK	PASS
	H	2390.00	44.01	30.22	4.85	23.98	42.62	54.00	AV	PASS
	H	2400.00	54.51	30.22	4.85	23.98	53.12	74.00	PK	PASS
	H	2400.00	44.90	30.22	4.85	23.98	43.51	54.00	AV	PASS
	V	2390.00	54.41	30.22	4.85	23.98	53.02	74.00	PK	PASS
	V	2390.00	44.66	30.22	4.85	23.98	43.27	54.00	AV	PASS
	V	2400.00	53.40	30.22	4.85	23.98	52.01	74.00	PK	PASS
	V	2400.00	44.53	30.22	4.85	23.98	43.14	54.00	AV	PASS
	High Channel: 2480MHz									
	H	2483.50	54.19	30.22	4.85	23.98	52.80	74.00	PK	PASS
	H	2483.50	44.55	30.22	4.85	23.98	43.16	54.00	AV	PASS
	H	2500.00	54.70	30.22	4.85	23.98	53.31	74.00	PK	PASS
	H	2500.00	44.94	30.22	4.85	23.98	43.55	54.00	AV	PASS
	V	2483.50	54.84	30.22	4.85	23.98	53.45	74.00	PK	PASS
	V	2483.50	44.94	30.22	4.85	23.98	43.55	54.00	AV	PASS
V	2500.00	53.66	30.22	4.85	23.98	52.27	74.00	PK	PASS	
V	2500.00	44.64	30.22	4.85	23.98	43.25	54.00	AV	PASS	
π/4-DQPSK	Low Channel: 2402MHz									
	H	2390.00	53.27	30.22	4.85	23.98	51.88	74.00	PK	PASS
	H	2390.00	44.00	30.22	4.85	23.98	42.61	54.00	AV	PASS
	H	2400.00	53.63	30.22	4.85	23.98	52.24	74.00	PK	PASS
	H	2400.00	44.63	30.22	4.85	23.98	43.24	54.00	AV	PASS
	V	2390.00	54.14	30.22	4.85	23.98	52.75	74.00	PK	PASS
	V	2390.00	44.95	30.22	4.85	23.98	43.56	54.00	AV	PASS
	V	2400.00	53.76	30.22	4.85	23.98	52.37	74.00	PK	PASS
	V	2400.00	44.90	30.22	4.85	23.98	43.51	54.00	AV	PASS
	High Channel: 2480MHz									
	H	2483.50	53.95	30.22	4.85	23.98	52.56	74.00	PK	PASS
	H	2483.50	44.52	30.22	4.85	23.98	43.13	54.00	AV	PASS
	H	2500.00	53.35	30.22	4.85	23.98	51.96	74.00	PK	PASS
	H	2500.00	44.47	30.22	4.85	23.98	43.08	54.00	AV	PASS
	V	2483.50	53.59	30.22	4.85	23.98	52.20	74.00	PK	PASS
	V	2483.50	44.24	30.22	4.85	23.98	42.85	54.00	AV	PASS
V	2500.00	53.73	30.22	4.85	23.98	52.34	74.00	PK	PASS	
V	2500.00	44.43	30.22	4.85	23.98	43.04	54.00	AV	PASS	



Low Channel: 2402MHz											
8-DPSK	H	2390.00	53.58	30.22	4.85	23.98	52.19	74.00	PK	PASS	
	H	2390.00	44.55	30.22	4.85	23.98	43.16	54.00	AV	PASS	
	H	2400.00	53.20	30.22	4.85	23.98	51.81	74.00	PK	PASS	
	H	2400.00	44.06	30.22	4.85	23.98	42.67	54.00	AV	PASS	
	V	2390.00	53.69	30.22	4.85	23.98	52.30	74.00	PK	PASS	
	V	2390.00	44.78	30.22	4.85	23.98	43.39	54.00	AV	PASS	
	V	2400.00	53.59	30.22	4.85	23.98	52.20	74.00	PK	PASS	
	V	2400.00	44.15	30.22	4.85	23.98	42.76	54.00	AV	PASS	
	High Channel: 2480MHz										
	H	2483.50	54.69	30.22	4.85	23.98	53.30	74.00	PK	PASS	
	H	2483.50	44.97	30.22	4.85	23.98	43.58	54.00	AV	PASS	
	H	2500.00	53.41	30.22	4.85	23.98	52.02	74.00	PK	PASS	
	H	2500.00	44.20	30.22	4.85	23.98	42.81	54.00	AV	PASS	
	V	2483.50	53.60	30.22	4.85	23.98	52.21	74.00	PK	PASS	
	V	2483.50	44.27	30.22	4.85	23.98	42.88	54.00	AV	PASS	
	V	2500.00	53.62	30.22	4.85	23.98	52.23	74.00	PK	PASS	
V	2500.00	44.67	30.22	4.85	23.98	43.28	54.00	AV	PASS		

**Remark:**

1. Emission Level = Meter Reading + Antenna Factor + Cable Loss – Pre-amplifier, Margin= Emission Level - Limit



(Right ear headphones)

	Polar (H/V)	Frequency (MHz)	Meter Reading (dBuV)	Pre-amplifier (dB)	Cable Loss (dB)	Antenna Factor (dB/m)	Emission level (dBuV/m)	Limit (dBuV/m)	Detector Type	Result
GFSK	Low Channel: 2402MHz									
	H	2390.00	53.37	30.22	4.85	23.98	51.98	74.00	PK	PASS
	H	2390.00	44.97	30.22	4.85	23.98	43.58	54.00	AV	PASS
	H	2400.00	53.33	30.22	4.85	23.98	51.94	74.00	PK	PASS
	H	2400.00	44.28	30.22	4.85	23.98	42.89	54.00	AV	PASS
	V	2390.00	54.54	30.22	4.85	23.98	53.15	74.00	PK	PASS
	V	2390.00	44.45	30.22	4.85	23.98	43.06	54.00	AV	PASS
	V	2400.00	53.75	30.22	4.85	23.98	52.36	74.00	PK	PASS
	V	2400.00	44.21	30.22	4.85	23.98	42.82	54.00	AV	PASS
	High Channel: 2480MHz									
	H	2483.50	54.02	30.22	4.85	23.98	52.63	74.00	Pk	PASS
	H	2483.50	44.47	30.22	4.85	23.98	43.08	54.00	AV	PASS
	H	2500.00	53.96	30.22	4.85	23.98	52.57	74.00	Pk	PASS
	H	2500.00	44.11	30.22	4.85	23.98	42.72	54.00	AV	PASS
	V	2483.50	54.15	30.22	4.85	23.98	52.76	74.00	Pk	PASS
	V	2483.50	44.03	30.22	4.85	23.98	42.64	54.00	AV	PASS
V	2500.00	54.28	30.22	4.85	23.98	52.89	74.00	Pk	PASS	
V	2500.00	44.58	30.22	4.85	23.98	43.19	54.00	AV	PASS	
π/4-DQPSK	Low Channel: 2402MHz									
	H	2390.00	53.04	30.22	4.85	23.98	51.65	74.00	PK	PASS
	H	2390.00	44.22	30.22	4.85	23.98	42.83	54.00	AV	PASS
	H	2400.00	53.96	30.22	4.85	23.98	52.57	74.00	PK	PASS
	H	2400.00	44.89	30.22	4.85	23.98	43.50	54.00	AV	PASS
	V	2390.00	53.50	30.22	4.85	23.98	52.11	74.00	PK	PASS
	V	2390.00	44.88	30.22	4.85	23.98	43.49	54.00	AV	PASS
	V	2400.00	54.02	30.22	4.85	23.98	52.63	74.00	PK	PASS
	V	2400.00	44.14	30.22	4.85	23.98	42.75	54.00	AV	PASS
	High Channel: 2480MHz									
	H	2483.50	53.04	30.22	4.85	23.98	51.65	74.00	PK	PASS
	H	2483.50	44.22	30.22	4.85	23.98	42.83	54.00	AV	PASS
	H	2500.00	53.96	30.22	4.85	23.98	52.57	74.00	PK	PASS
	H	2500.00	44.89	30.22	4.85	23.98	43.50	54.00	AV	PASS
	V	2483.50	53.50	30.22	4.85	23.98	52.11	74.00	PK	PASS
	V	2483.50	44.88	30.22	4.85	23.98	43.49	54.00	AV	PASS
V	2500.00	54.02	30.22	4.85	23.98	52.63	74.00	PK	PASS	
V	2500.00	44.14	30.22	4.85	23.98	42.75	54.00	AV	PASS	



		Low Channel: 2402MHz									
		H	2390.00	53.89	30.22	4.85	23.98	52.50	74.00	PK	PASS
8-DPSK	H	2390.00	44.37	30.22	4.85	23.98	42.98	54.00	AV	PASS	
	H	2400.00	54.38	30.22	4.85	23.98	52.99	74.00	PK	PASS	
	H	2400.00	44.86	30.22	4.85	23.98	43.47	54.00	AV	PASS	
	V	2390.00	54.84	30.22	4.85	23.98	53.45	74.00	PK	PASS	
	V	2390.00	44.66	30.22	4.85	23.98	43.27	54.00	AV	PASS	
	V	2400.00	53.45	30.22	4.85	23.98	52.06	74.00	PK	PASS	
	V	2400.00	44.30	30.22	4.85	23.98	42.91	54.00	AV	PASS	
			High Channel: 2480MHz								
	H	2483.50	53.58	30.22	4.85	23.98	52.19	74.00	PK	PASS	
	H	2483.50	44.54	30.22	4.85	23.98	43.15	54.00	AV	PASS	
	H	2500.00	53.08	30.22	4.85	23.98	51.69	74.00	PK	PASS	
	H	2500.00	44.72	30.22	4.85	23.98	43.33	54.00	AV	PASS	
	V	2483.50	53.51	30.22	4.85	23.98	52.12	74.00	PK	PASS	
	V	2483.50	44.86	30.22	4.85	23.98	43.47	54.00	AV	PASS	
	V	2500.00	53.83	30.22	4.85	23.98	52.44	74.00	PK	PASS	
	V	2500.00	44.22	30.22	4.85	23.98	42.83	54.00	AV	PASS	

**Remark:**

1. Emission Level = Meter Reading + Antenna Factor + Cable Loss – Pre-amplifier, Margin= Emission Level - Limit





## 6. CONDUCTED BAND EDGE AND SPURIOUS EMISSION

Test Requirement:	FCC Part15 C Section 15.247 (d)
Test Method:	KDB558074 D0115.247 Meas Guidancev05r02

### 6.1 Limit

Regulation 15.247 (d), In any 100 kHz bandwidth outside the frequency band in which the spread spectrum or digitally modulated intentional radiator is operating, the radio frequency power that is produced by the intentional radiator shall be at least 20 dB below that in the 100 kHz bandwidth within the band that contains the highest level of the desired power, based on either an RF conducted or a radiated measurement, provided the transmitter demonstrates compliance with the peak conducted power limits. If the transmitter complies with the conducted power limits based on the use of RMS averaging over a time interval, as permitted under paragraph (b)(3) of this section, the attenuation required under this paragraph shall be 30 dB instead of 20 dB. Attenuation below the general limits specified in §15.209(a) is not required. In addition, radiated emissions which fall in the restricted bands, as defined in §15.205(a), must also comply with the radiated emission limits specified in §15.209(a) (see §15.205(c)).

### 6.2 Test Setup



### 6.3 Test procedure

Using the following spectrum analyzer setting:

- A) Set the RBW = 100KHz.
- B) Set the VBW = 300KHz.
- C) Sweep time = auto couple.
- D) Detector function = peak.
- E) Trace mode = max hold.
- F) Allow trace to fully stabilize.

### 6.4 DEVIATION FROM STANDARD

No deviation.



6.5 Test Result

GFSK mode:
Lowest channel

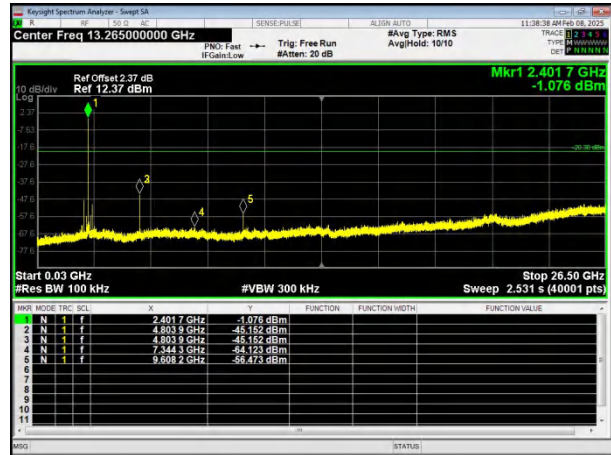
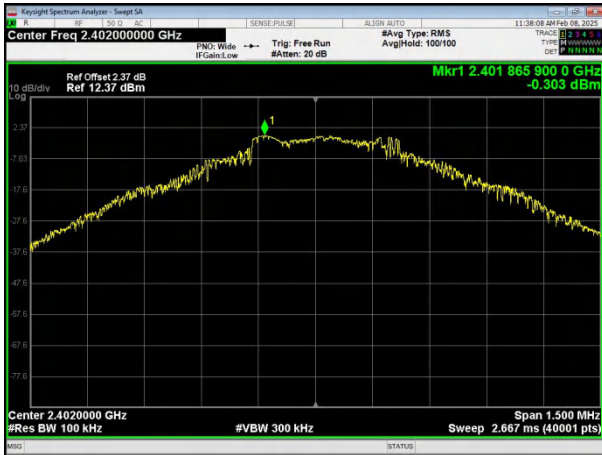

Middle channel

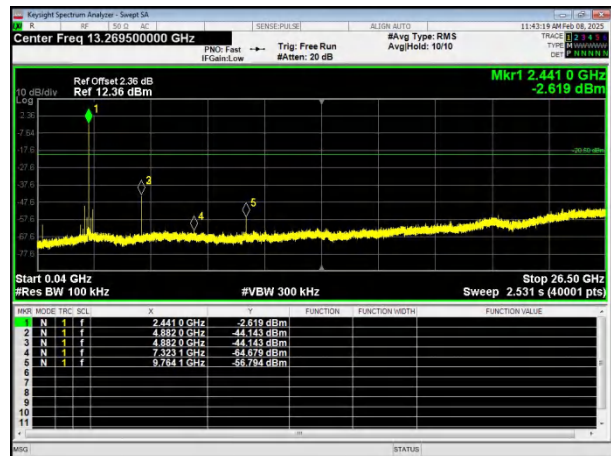

Highest channel

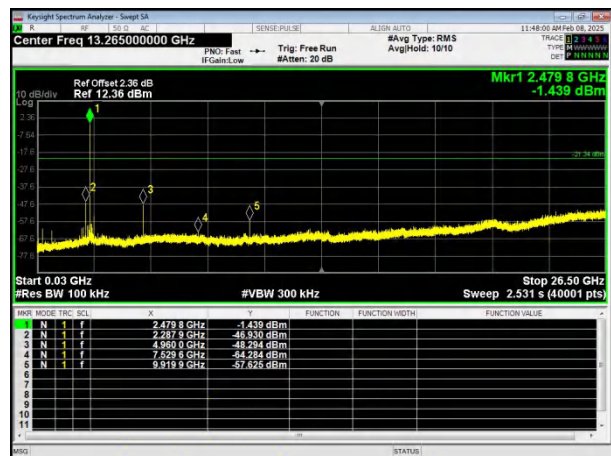

30MHz~26.5GHz



$\pi/4$ -DQPSK mode  
Lowest channel

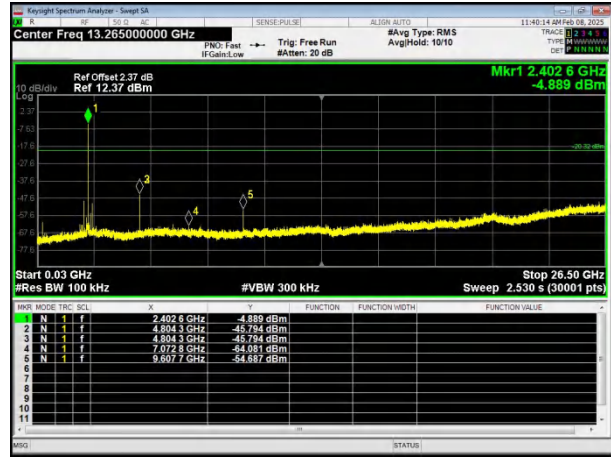
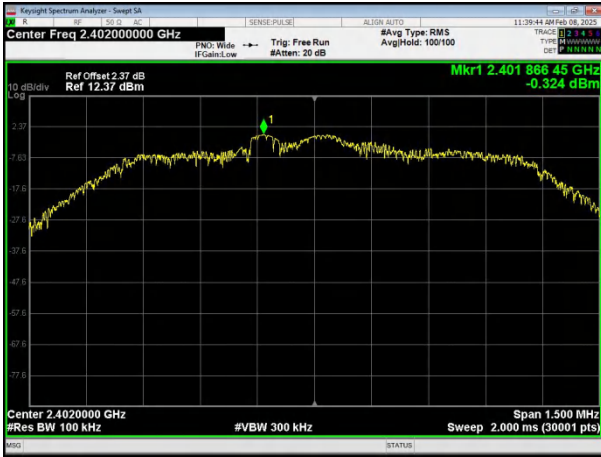

Middle channel

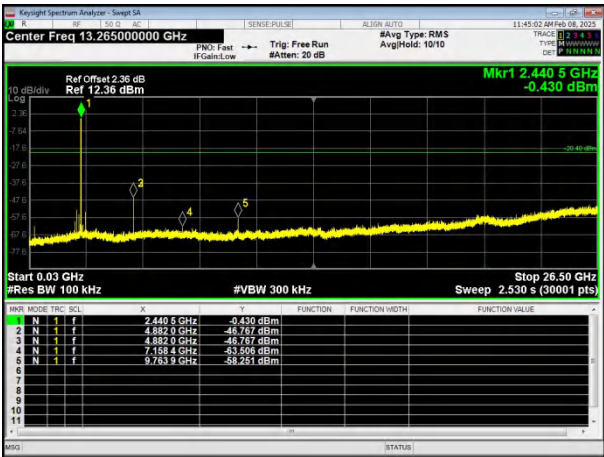
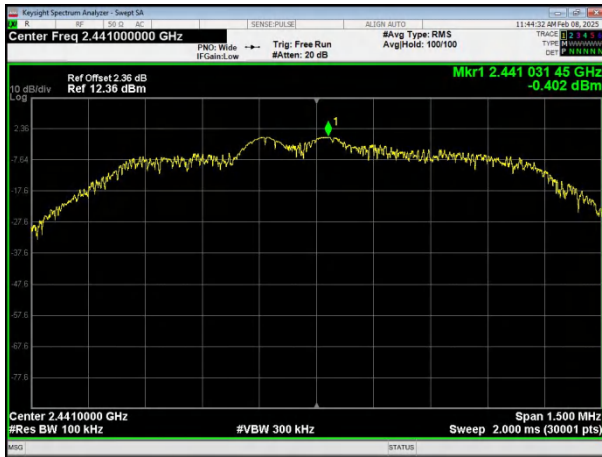

Highest channel

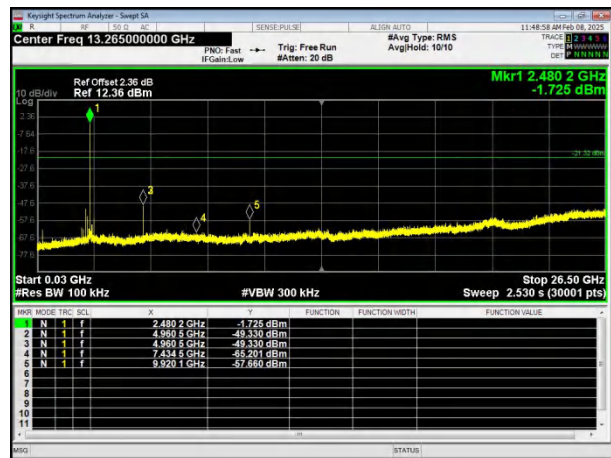
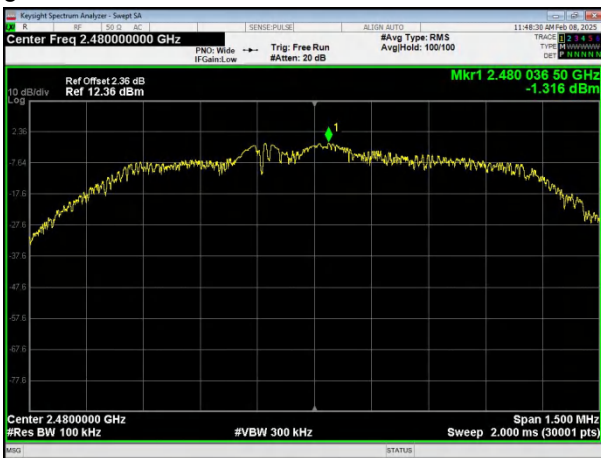

30MHz~26.5GHz



8-DPSK mode:  
Lowest channel

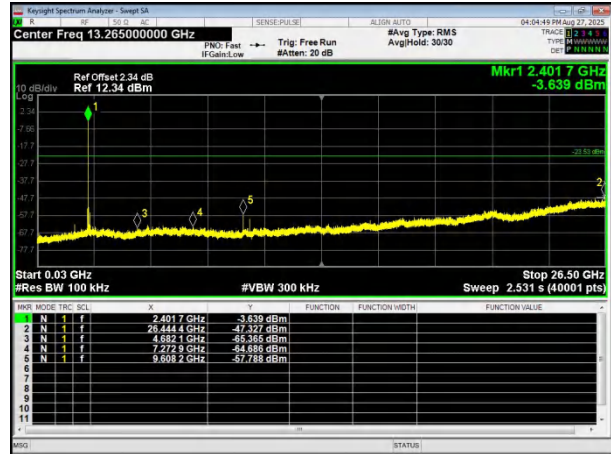

Middle channel

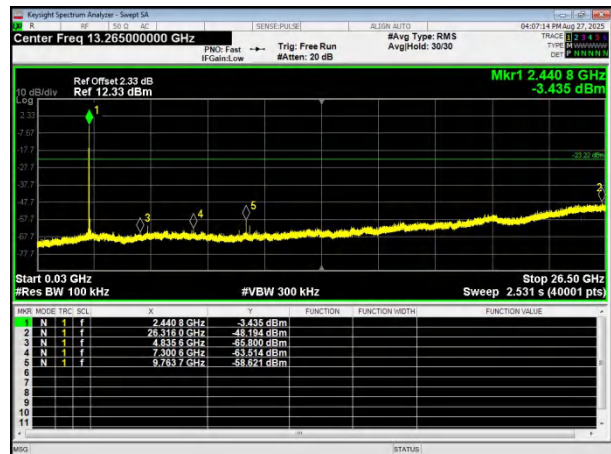

Highest channel

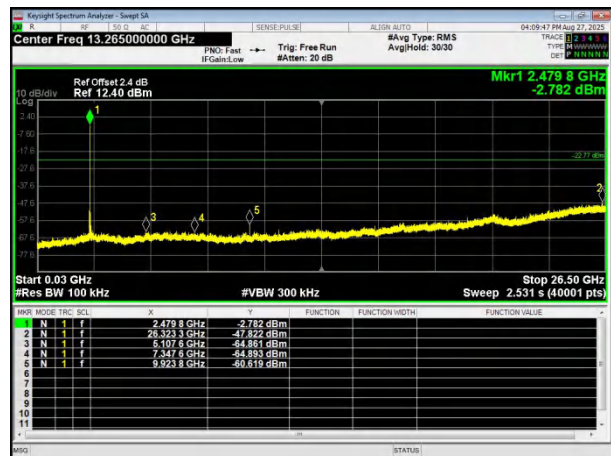

30MHz~26.5GHz





GFSK No-hopping Band edge-left side

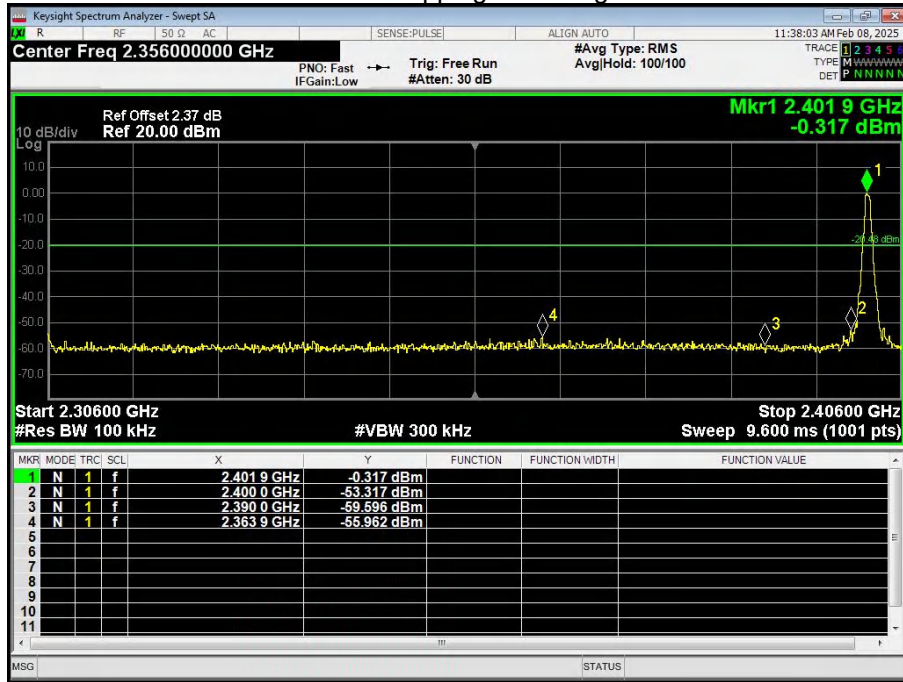

GFSK Hopping Band edge-left side

