

SHARE SLAM S20

User Manual V1.1

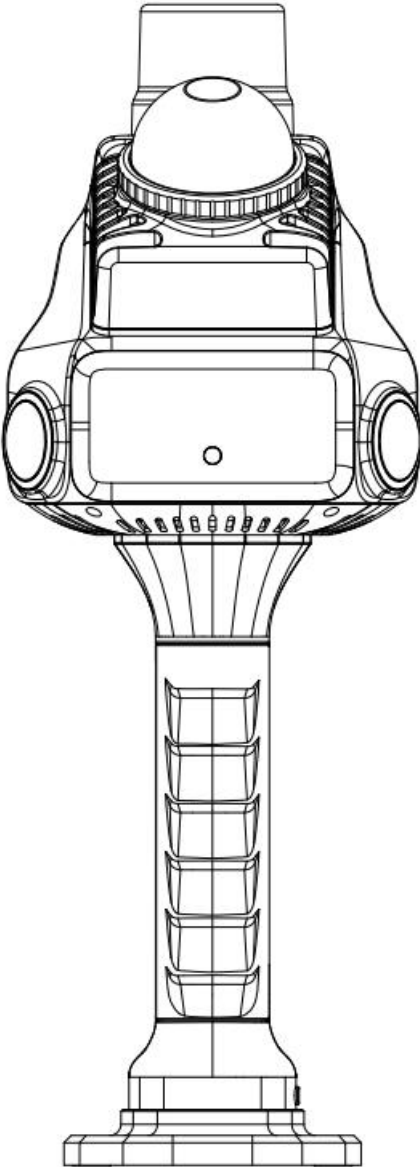

SHAREUAV Ltd

Disclaimer and Warning

Please read this entire document carefully to ensure proper configuration before use. The copyright of this document and all other collateral documents belong to SHAREUAV Ltd (abbreviated as “SHARE UAV”). SHARE UAV has the final interpretation right of this document and all other collateral documents.

SHARE UAV has right to update, modify or terminate the content of this document without prior notice. For update information, visit website “www.shareuavtec.com” and click on the product page for this product.

Do not allow people under the age of 18 to use the SHARE SLAM S20.

Do not modify or disassemble the SHARE SLAM S20. SHARE UAV accepts no liability for damage, injury or any legal responsibility incurred directly or indirectly from the use of this product. The user shall observe safe and lawful practices including, but not limited to, those set forth in this manual.

By using SHARE UAV products, you hereby signify that you have read this disclaimer and warning carefully and that you understand and agree to abide by the terms and condition herein.

You agree that you are solely responsible for your own conduct while using this product, and for any consequences thereof. You agree to use this product only for purposes that are proper and in accordance with all applicable laws, rules, and regulations.

Catalog

1 Product Overview	3
1.1 Product Introduction	3
1.2 Features	3
1.3 In the box	4
1.4 Parameter	4
2 Installation	7
2.1 Structure Introduction	7
2.2 Installation	7
2.3 Uninstallation	8
2.4 Charge	8
3 Scanner Operation	9
3.1 Power On	10
3.2 Device Starting Up	10
3.3 Device Connect Mobile APP	10
3.4 Start Scanning	11
3.5 Parameter Setting	12
3.6 New Project	14
3.7 Control Point Collection	15
3.8 Data Collection	17
3.9 Data Saving	18
3.10 Power Off	18
4 SHARE Capture	19
4.1 Data Storage	19
4.2 Local	19
4.3 Review Data	20
5 SHARE Pointclouds Studio	21
5.1 Software Configuration Requirements	21
5.2 Installation and Uninstallation	21
5.3 User Registration and Login	22
5.4 Data Processing	23
5.6 Process Result	24
5.7 Software Interface	25
5.8 Interface Control Toolbar	31
5.9 Tool Menu	35
6 Device Maintenance	41
6.1 Charge	41
6.2 Precaution	41
7 After Sales	42
7.1 Shipment	42

1 Product Overview

1.1 Product Introduction

SHARE SLAM S20 is handheld 3D lidar scanner designed and developed by SHAREUAV. It integrates high-precision lidar, surveying and mapping wide-angle camera, and integrated RTK module. It deeply integrates lidar and image, and cooperates with self-developed point cloud algorithm. A person operation can obtain accurate color point cloud data in a short time, and scanning with a handheld lidar device can complete spatial mapping. Whether they are architectural designers, construction workers or surveying professionals, they can quickly obtain real-life 3D information by using SHARE SLAM S20.

1.2 Features

- * Supports real-time calculation and post-processing calculation, and adds color to point clouds in real time. The color point cloud effect is industry-leading;
- * The point cloud thickness is within 1cm, and relative accuracy can reach 1cm;
- * Two wide-angle fish-eye lenses with a total of 32 million pixels;
- * Built-in visual SLAM lens, integrating laser SLAM and visual SLAM to solve difficult problems in complex scenes
- * The built-in RTK module does not require external antennas and 4G cards, and can be used by turning on the device with just one click;
- * The grip battery supports quick-release installation and firmly installed, can work continuously for 2 hours;
- * Standard "SHARE Capture" software, real-time feedback on data collection status, real-time preview of color point cloud;
- * Standard SHARE Pointclouds Studio software can generate color point clouds with one-click and generate point clouds in a variety of common formats;
- * Standard magnetic mobile phone clip, the mobile phone is more firmly adsorbed and more convenient to use
- * Connect to wifi with one-click encryption via Bluetooth, making the wifi connection more stable
- * RTK antenna has stronger anti-interference ability and can obtain RTK fixed signals faster
- * Product power is as low as 24W, and the device generates less heat

1.3 In the box

Item	LiDAR Scanner	Grip Battery	Charger	Position Plate	Card Reader
QTY	1 PC	1 PC	1 PC	1 PC	1 PC
Item	Wipe Cloth	Warranty Card	User Manual	Data Cable	Phone Clip
QTY	2 PCS	1 PC	1 PC	1PC	1PC

1.4 Parameter

SHARE SLAM S20 Handheld LiDAR Scanner		
Overall	Dimensions	Overall: 110.5*140*313.3mm; Main Unit : 110.5*114*143.1mm
	Weight	Main Unit: 700g Grip Battery: 350g
	Protection Class	IP5X
	WIFI	WIFI 6, Support 2.4G/5G
	Working Temperature	-20℃to 55℃
	Storage Temperature	-20℃to 60℃
	WIFI Distance	20m
	Bluetooth	Support
	Supply Voltage	13.2V~16.8V
	Working Power	<24W
	Wireless Connectivity	WIFI/Bluetooth
	Interface	TF Card slot/ Type-C
	Booting Time	40 S
	Initialization Duration	10 S
	Storage Capacity	256G (Support memory expansion)
Phone Adsorption	Magnetic phone clip	

LiDAR	Radar Head	1
	Lidar Class	Class 1 /905 nm
	Point Cloud Number	200000 points/s
	Point Cloud Frequency	10 Hz (Typical Value)
	Scanning Range	0.1~40m@10% reflectivity 0.1m~70m@80% reflectivity
	LiDAR FOV	Horizontal 360°; Vertical -7°~52°
	Lidar Installation	Tilt 25° to the ground
RTK	RTK Accuracy	Horizontal 0.8cm+1ppm; Vertical 1.5cm+1ppm
	PPK	Support
	Supported Regions	China/Overseas
	Support Satellite	BDS B11,B21,B31,B1C,B2a,B2b GPS L1C/A, L1C,L2C,L2P(Y),L5 GLONASS G1,G2,G3 Galileo E1, E5a, E5b, E6 QZSS LIC/A, L1C, L2C, L5 NavIC L5 SBAS LIC/A
Camera	Sensor Size	13.13*8.76mm; 1-inch
	Actual Used Sensor Size	11.21mm*8.41mm
	Pixel Size	2.4μm
	Image Size	3504*4672
	Effective Pixels	Single lens 16million
	Lens Number	2
	Installation Angle	120°
	Focal Length	3.5mm
	Image Format	JPG
	Shooting Interval	≥0.5s
	ISO	Auto, 50-3200
	White Balance	Auto
	Shutter Speed	Auto, 1/100-1/1000
Trigger Mode	Auto	

	Shutter Type	Mechanical shutter
	Aperture	F2.8
	Lens FOV	H: 140° V: 200°
V-SLAM Camera	Focal Length	1.68mm
	Image Size	1280*800
	Effective Pixels	1million
	FOV	Diagonal: 120°; Horizontal: 97.4°; Vertical: 79.1°
	Frame Rate	30HZ
Battery Parameters	Battery Capacity	45.36wh (3150mAh)
	Supply Voltage	14.8V~16.8V
	Working Time	120min
	Charging Port	Type-C
	Charging Power	PD 30W
Processor Parameters	Computing Power	6Tops
	Memory	8G
Data& Software	Point Cloud Thickness	≤1cm
	Relative Accuracy	≤ 1cm
	Absolute Accuracy	≤ 5cm
	Point Cloud Format	.las, .ply, .pcd, (Support color and colorless)
	Mobile App	Supports preview of color point clouds, iOS and Android compatibility
	Processing Software	Supports spatially correlated viewing of point clouds and images
	Point Cloud Information	Contains intensity information
	Processing	RTK-SLAM; PPK-SLAM; only SLAM
	Processing Method	Real-time calculation processing/post-processing calculation processing
	Point Cloud Coloring	Support real-time point cloud coloring; support post-processing coloring

2 Installation

2.1 Structure Introduction

The SHARE SLAM S20 device is divided into two parts, scanning module and the special grip (contains a battery and Position Plate inside). The grip battery provides power and supports the scanning module; the scanning module includes lidar, lens, RTK module, storage module, etc.

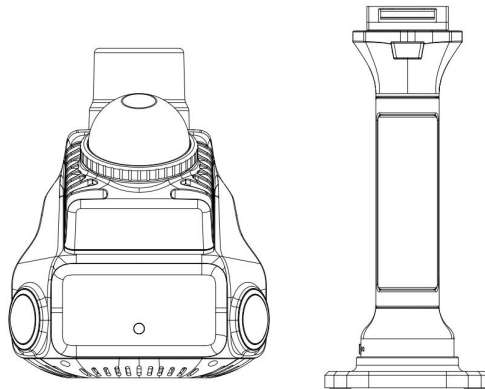

2.2 Installation

2.2.1 Install Position Plate

First, install the grip battery and the position plate together. Align the direction of the grip battery buttons with the rear end of the positioning plate. Align the screw holes at the bottom of the grip with the screws at the bottom of the positioning plate. Turn the screws to the right until they are tightened. Shake slightly to confirm that the grip and position plate are secure.

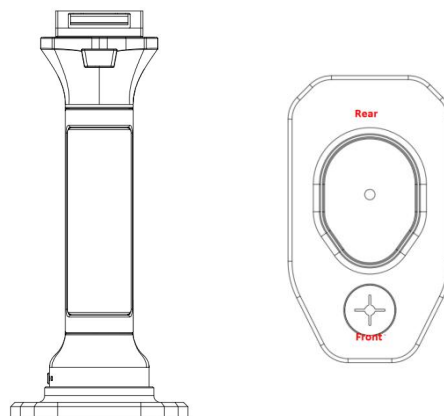

2.2.2 Install Scanner Module

Align power interface on the top of the grip battery with the power interface on the bottom of the scanner, with the white circle mark of the scanner facing you. Gently press down on the scanner and insert it directly. A click sound indicates installation is complete.

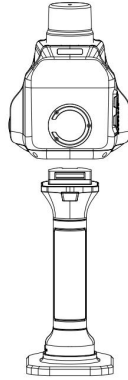

2.3 Uninstallation

Hold the grip battery with your left hand and the scanner module with your right hand. There is a button above the grip battery. Press and hold the button while pulling out the scanner module. At this time, be careful not to use excessive force to avoid bumping the device. Finally, turn the screw on the position plate to the left and loosen it until the grip battery can be removed.

2.4 Charge

When charging the device, Remove the scanner module from grip battery. The grip battery and position plate do not need to be disassembled. Take out the charging device provided in the box and insert it into the TYPE-C charging port at the bottom of the grip. Wait until the power indicator lights light up one by one. Indicates that the grip battery is charging.

3 Scanner Operation

When starting the scan, use the SHARE Capture App to control the device. Through this app, you can control the device to start scanning, end scanning, manage data and other operations. There is an indicator light under the RTK antenna of the scanner, which can be used to check the working status. The color and corresponding status of the indicator light are as shown in the table below.

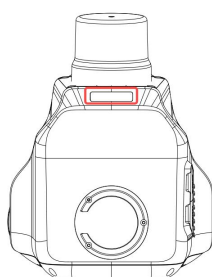

Device Status	Left	Right	Overall Display
POST			chaser lights
Booting	–	–	rapid blue flash
Boot Completed	–	–	solid blue light
Firmware Upgrading	–	–	solid yellow light
Data Saving	–	–	slow yellow flash
Shutting Down	–	–	rapid yellow flash
Device Abnormality		–	solid red light
Starting Operation	–	–	rapid green flash
Scanning	slow green flash	Depends on RTK Status Display	
RTK Status Display			
RTK is not used (RTK function is turned off or no GPS signal)	–	slow blue flash	
RTK has no signal (GPS signal exists, but no RTK or RTCM. The base station may not be configured properly)	–	slow red flash	–
RTK single & RTK floating (antenna interfered)	–	slow yellow flash	–
RTK Fixed (normal)	–	slow green flash	–
RTK Abnormality	–	solid red light	–

3.1 Power On

Find the battery button on the bottom of the device's grip battery. Short press and then long press the battery button to turn on the device, the battery indicator light will light up, and grip battery will be turned on to provide power to the device. When the battery indicator light stays on, it means that SHARE SLAM S20 is power on. Different numbers of lights on indicate different levels of power.

Light Number	Power
Red	15%
1	5%-25%
2	25%-50%
3	50%-75%
4	75%-100%

When the device is turned off, short press grip battery button and check the number of four indicator lights on to check the current battery level of the grip battery.

3.2 Device Starting Up

After turning on SHARE SLAM S20, wait for about a minute for the device to start up in order to prepare for subsequent scanning. SHARE SLAM S20 vibrates slightly and the device indicator light is always on, indicating that the device has been successfully started.

3.3 Device Connect Mobile APP

You can download the "SHARE Capture" installation package from the SHAREUAV official website.

Then install, open the app, log in or register, Then enter the main interface of the software; In the software interface, the SAHRE SLAM S20 loading status (buffer icon) is visible, which means it is not connected to the device.

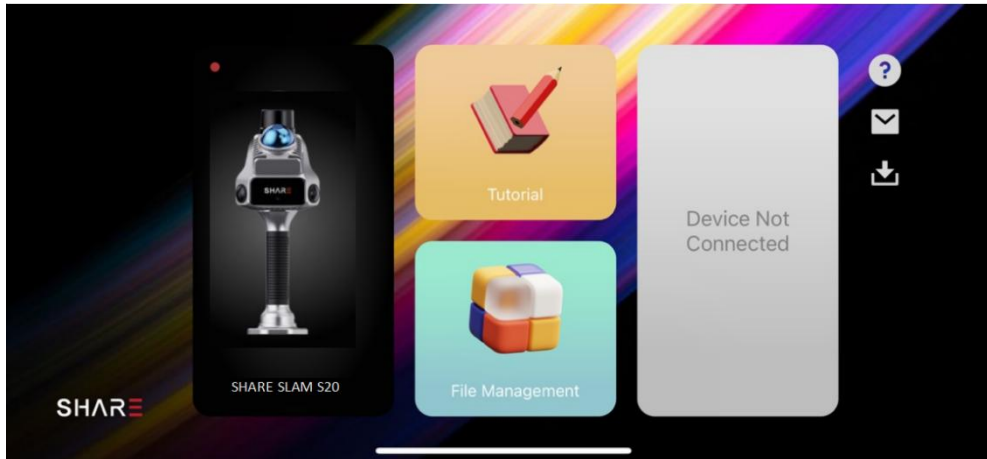

You can directly click the button and select the WLAN starting with "SLAM S20-xxxx" in the pop-up Wi-Fi list (no need to enter a password), which is the WLAN sent by the SHARE SLAM S20 device for connection your phone. When the red dot in the upper left corner of the phone screen turns green and there is no buffer icon, it means that SHARE SLAM S20 is successfully connected to your phone.

3.4 Start Scanning

After the device is connected, click "Start " to enter the scanning interface. Users can set relevant parameters according to their own needs before starting scanning.

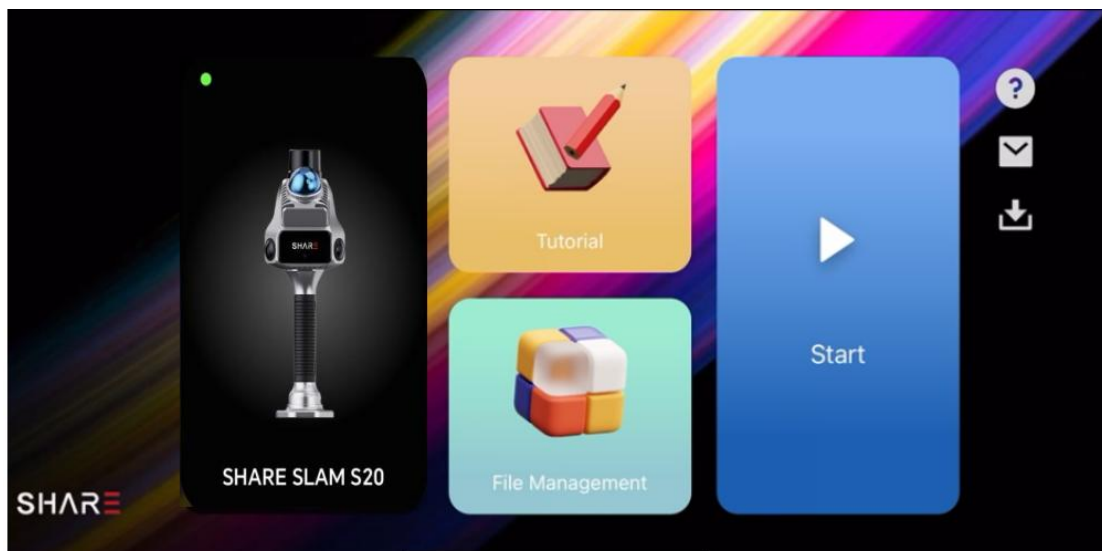

3.5 Parameter Setting

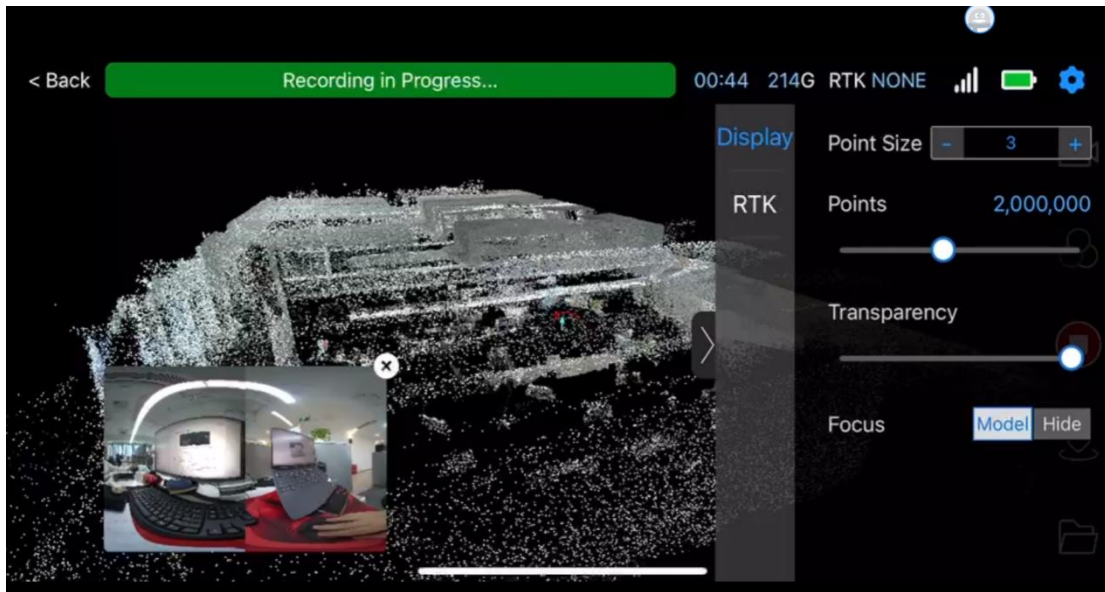

Click the "⚙️" settings button in the upper right corner of the APP interface to set point cloud display and RTK.

Display	Point Size	Range 1-10 can set
	Point Number	0-4 million optional
	Focus	Users can switch handheld device Model or Hide, Can display the current device location
	Transparency	0-100 Transparency
RTK	RTK Switch	Control RTK switch

3.5.1 RTK Setting

Users can open RTK and log in to the network CORS account. Using the RTK module can greatly improve the accuracy of data collection. It is recommended to turn on this function.

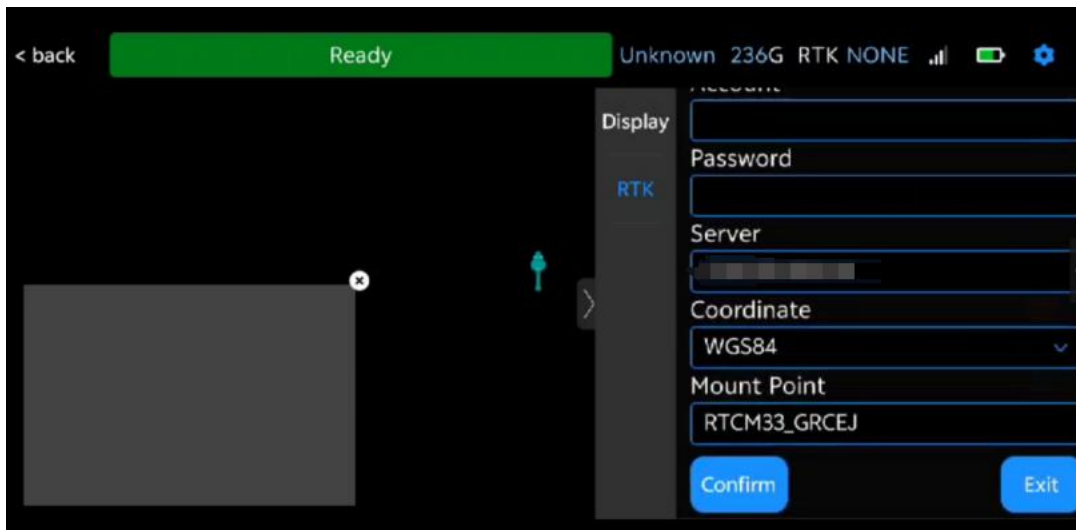
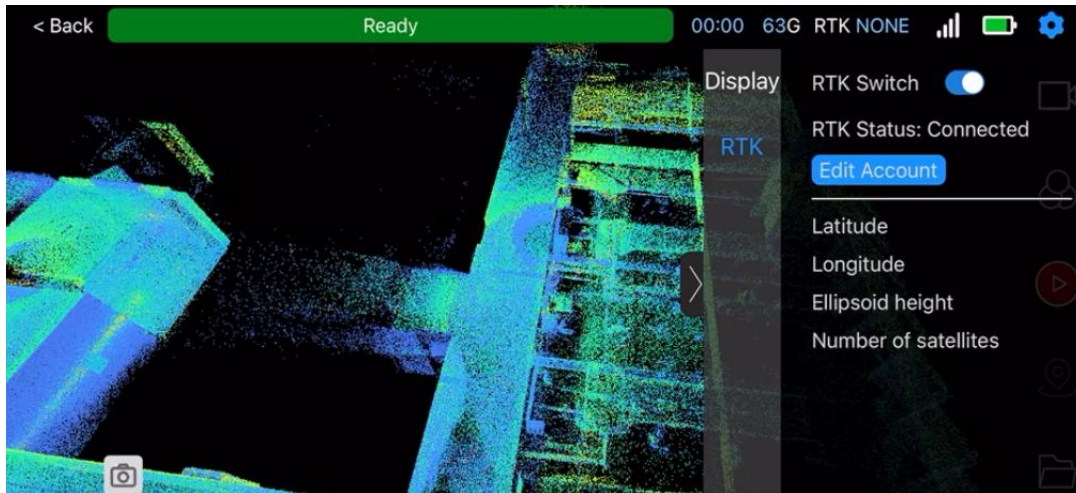

3.6 New Project

When the device status shows "Ready", you can click the "Start" button on the right to start the project.

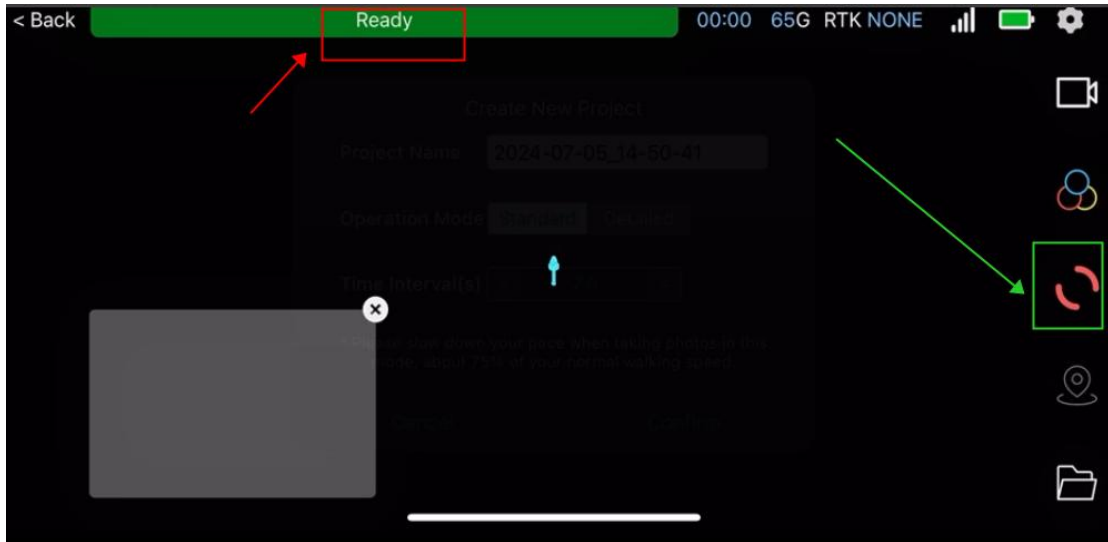

Next, the "New Project" window will pop up. Enter the project name, select the operation mode standard or Detailed, then set the photo interval and click "OK".

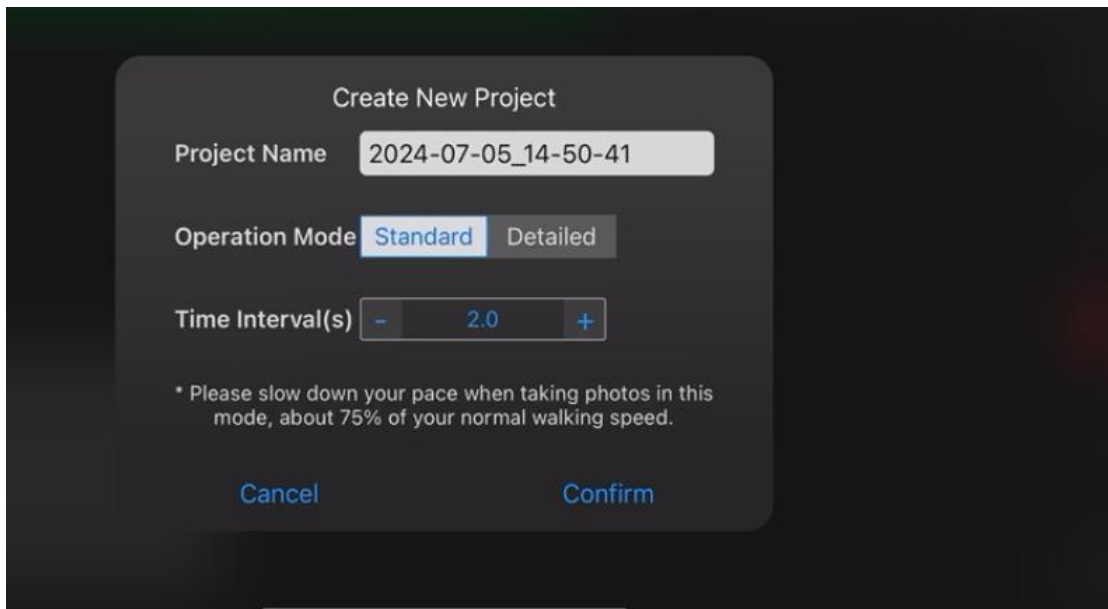

The upper part of the screen will display the status, operation time, storage capacity, etc. of the device at this time.



3.7 Control Point Collection

When you need to place control points, you can click  button on the right side of the interface to add or delete control points. Placing control points can enhance the overall accuracy of the collected data.

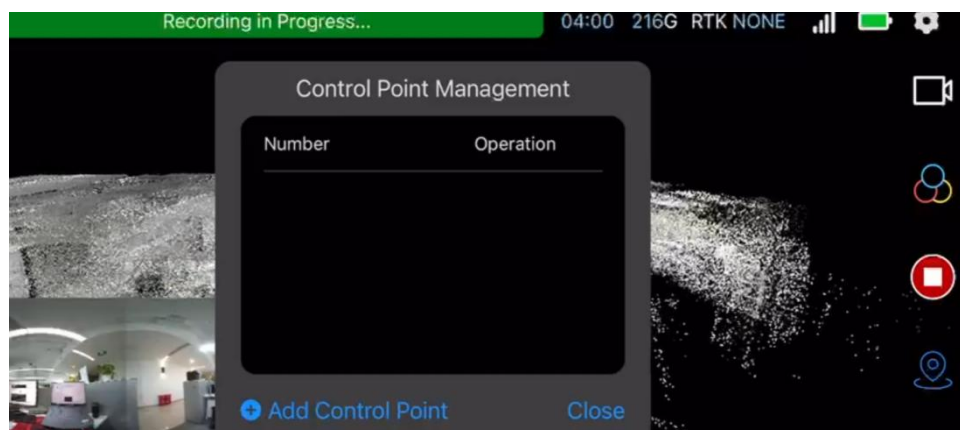

When collecting control points, you need to align the center of the control point placement area on the front end of the position plate with the position of the control point you want to add, and then click “Add Control Point”. Keep the device stable for about 10 seconds to complete the collection.

Place Control Point

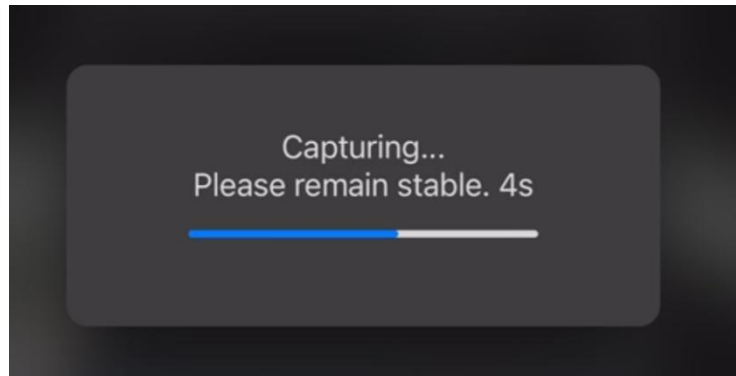
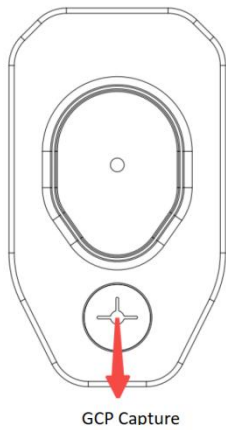

For control points that have been set, users can cover and delete them according to needs.

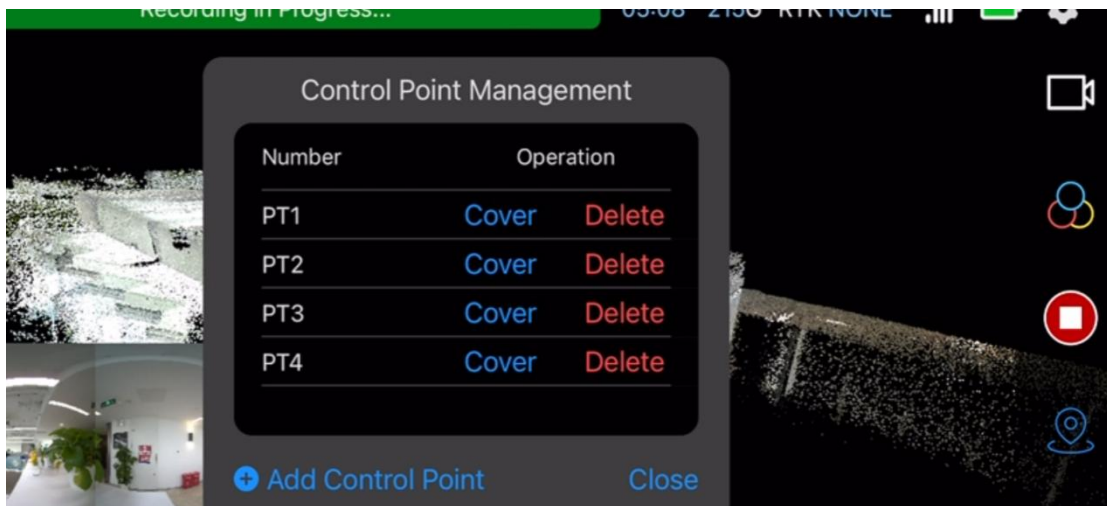

3.8 Data Collection

When the device status shows "Ready", the scanning operation can begin. The APP displays the reconstructed three-dimensional space point cloud information and collection trajectory in real time, and you can manually view the spatial three-dimensional color point cloud.

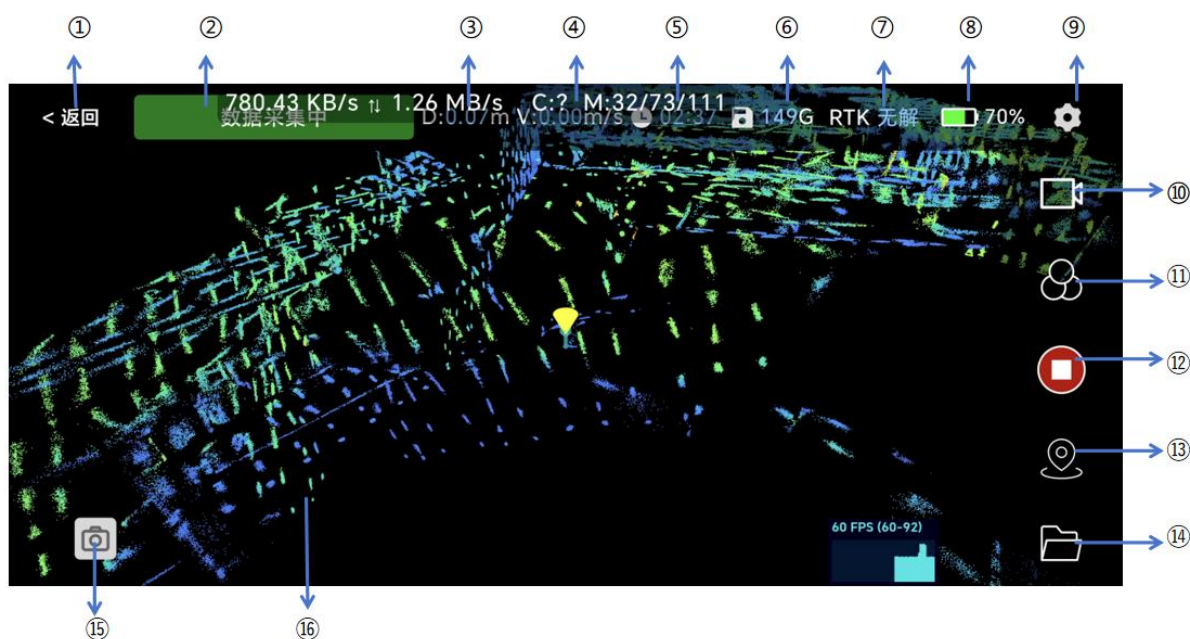

The operation interface function description is as follows:

- ① Back : Click to return to the main interface of the software;
- ② Status Description: prompts the current status of the project;
- ③ Working Time: Prompts the working time of the current project;
- ④ Storage Status: Used storage
- ⑤ RTK Status: prompts the status of the RTK device;
- ⑥ Signal: Prompt the current information of the device;
- ⑦ Power: device power description;
- ⑧ Setting: project parameter setting button, click to set relevant parameters;
- ⑨ Roaming mode: Switch between roaming modes, including free roaming and third-person
- ⑩ Point Cloud Mode: Switch the display mode of point cloud in the three-dimensional scene, including three modes: color point cloud, intensity coloring and elevation gradient;

(Continued on next page)

- ⑪ ON/OFF: Control the start and end of engineering operations;
- ⑫ Control Point Management: Operations such as adding, deleting and covering control points of the project can be performed. Adding control points can enhance the overall calculation accuracy of the data collected ;
- ⑬ File Management: Jump to the file management page, where you can manage, delete, view and other operations on local (save in mobile) and device project data;
- ⑭ Photo: View photo information taken by the device;
- ⑮ Three-dimensional Scene: The device analyzes and displays the collected point cloud in real time. You can manually zoom in/out/translate the three-dimensional scene to view the point cloud details.

3.9 Data Saving

To end the scan, please click the red button on the right side of the screen. A "Saving" prompt will be displayed about 10 seconds after clicking the button. After the status changes from "Saving" to "Ready", it means the saving is successful.

If you want to do the next project , be sure to wait one minute after the above "Ready" prompt appears before performing the next project .

3.10 Power Off

First, make sure that the device has completed collecting data and saved it. It is in a stopped working state. Short press and long press the power button on the grip battery. After about 10 seconds, the indicator light goes out and there is no working sound from the device, which means the camera has been turned off.

4 SHARE Capture

SHARE APP provides various functions for data management. Users can upload, download, rename, delete and other functions of files through the File Management page. If users download data from their device to their phone, they can simply view the data on their phone.

4.1 Data Storage

Please note that although can view the entire process of scanning data on mobile phone, after each project, the project data is saved in the TF card of SHARE SLAM S20. So user can find data which just scanned in the " File Management"->"Device" option. The default file name is the time when scanning started. The default preview cover is the first photo when recording is started. It is recommended to use the "Rename" function to change each project to a name specified by yourself, so that the file can be found again later. The function buttons in the upper right corner are "Download", "Delete" and "More" from left to right. The "More" menu can help you select all project, or sort the project by name or size. Please note that once deleted, project data cannot be retrieved.



4.2 Local

Download the project data to your phone. You can click on the "Device" page to select the file

you want to download. After selecting, click "Download". Then you can find the downloaded file on the "Local" page.

From the Local interface you can control movement to view the scanned area. Please note that due to the limited computing power of mobile phones, the point clouds seen in "Review" are thinned out point cloud data and are only used to help you determine the area you have traveled. If you need to see a better complete effect, you need to post-process data in SHARE Pointclouds Studio.

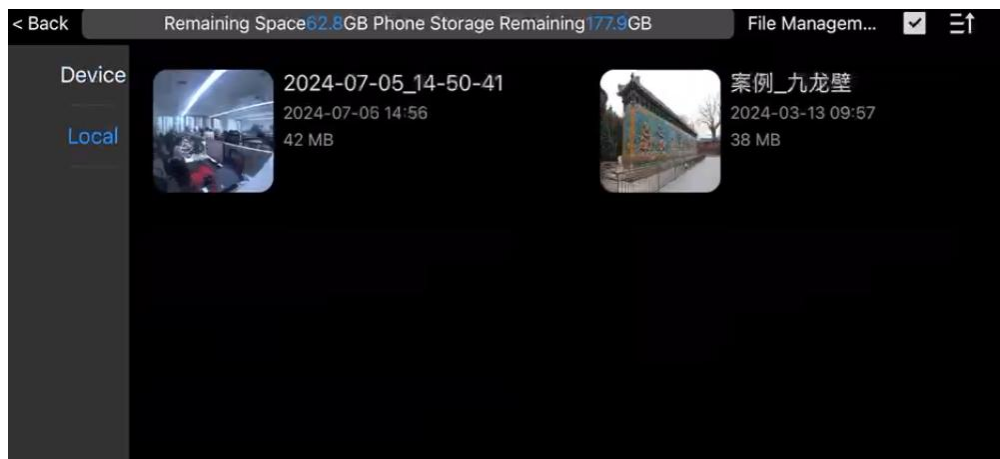

4.3 Review Data

Switch to "Local" file management, click on the corresponding project, and in the "Review" interface, you can rotate/zoom and pan point cloud.

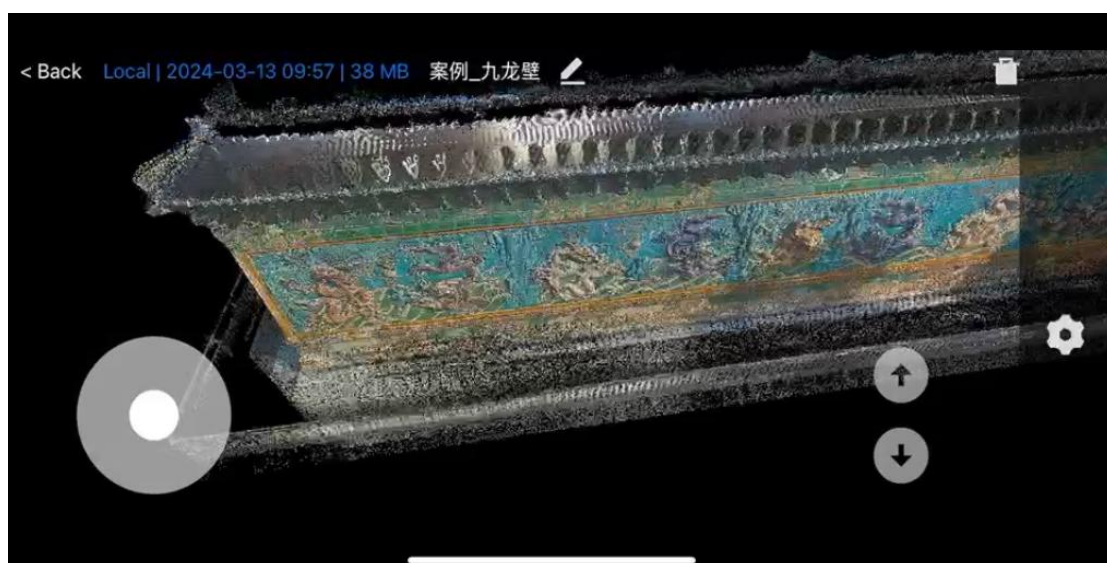

5 SHARE Pointclouds Studio

SHARE PointClouds Studio software is data processing tool software for SHARE handheld 3D LiDAR scanner series products. The software provides functions such as original data analysis, 3D point cloud viewing, and measurement analysis. When matched with SHARE handheld LiDAR products, it can completely cover the entire process of data collection, data processing and data analysis, and fully supports the application of 3D LiDAR point cloud.

5.1 Software Configuration Requirements

To ensure that the software uses smoothly, the recommended configuration is as follows:

CPU	Intel® Core™ i7-10700H@2.90 GHz (Or equivalent performance processor to AMD)
GPU	GeForce RTX2060 4GB
RAM	32GB
Hard Drive Capacity	64G capacity available
Operating System	Windows 11 series

5.2 Installation and Uninstallation

5.2.1 Installation

Scan the QR code on the shipping box to download the installation packages for SHARE Capture and SHARE Pointclouds Studio software.

Open the installation package and click Next to complete the installation, all installation settings can use the default settings.

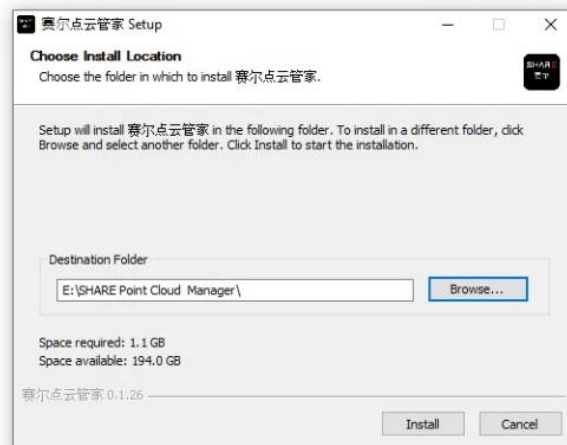

5.2.2 Upgrade

When there is a new version of software, a pop-up window will prompt you to upgrade. Click the "Update " button to update the software.

5.2.3 Uninstallation

If you use the installation package to install SHARE Pointcloud Studio, then you could open the "Uninstall SHARE Pointcloud Studio.exe" program in the software directory or uninstall it directly in control panel when uninstalling.

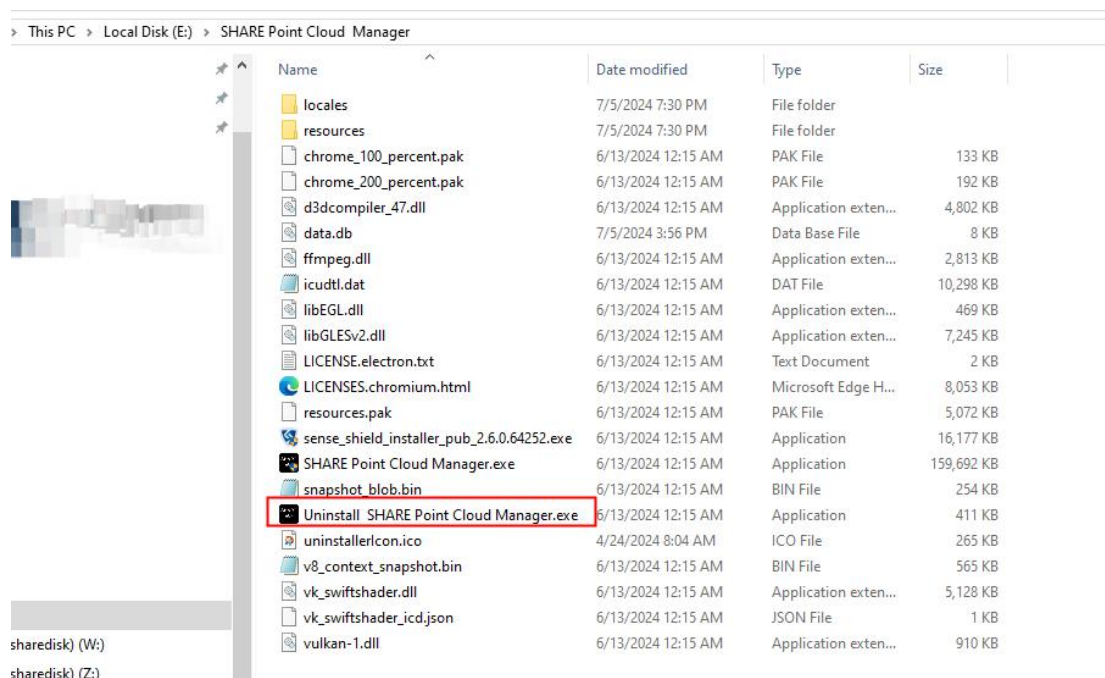

In the uninstallation interface, click "Uninstall" to enter the software uninstallation process. Click the "Finish" button to complete the uninstallation of the software.

5.3 User Registration and Login

When using SHARE Pointcloud Studio for the first time, a login window will pop up. You need to log in to your SHARE account to use the software. If you don't have a SHARE account yet, you can register first. After you log in, the login process will be automatically skipped when you open the software for the second time.

5.4 Data Processing

Remove TF card from device, insert it into the card reader, connect it to the computer to read the data, and copy project file (Such as 2024-03-26_xxx) to the computer local disk.

Open SHARE Pointclouds Studio software, click “New Build”,then select the data file in the computer local disk, and click “Confirm” to start data processing.

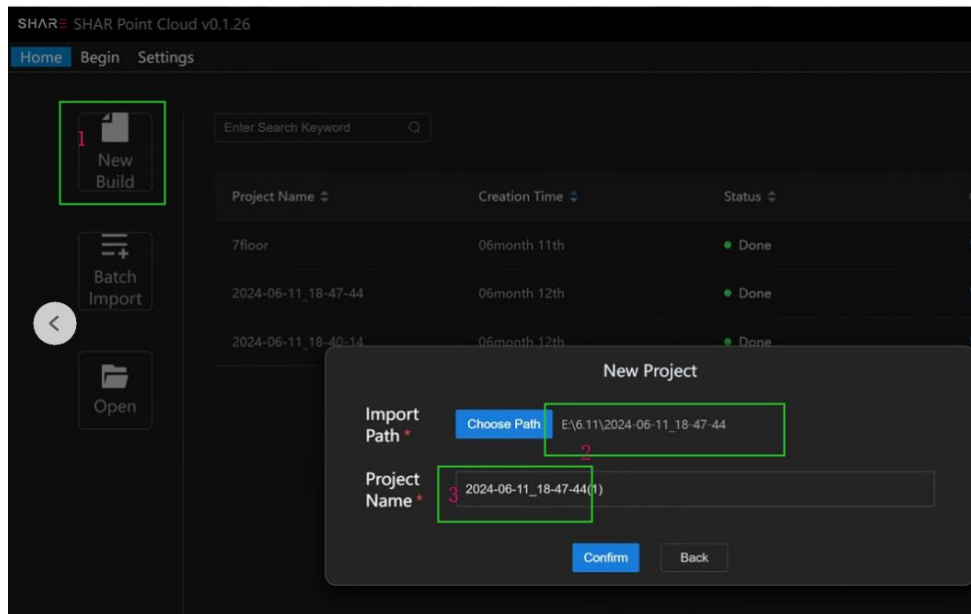

If control points are collected, “Control Points” needs to be checked during data processing.

Manually enter longitude, latitude and altitude data.

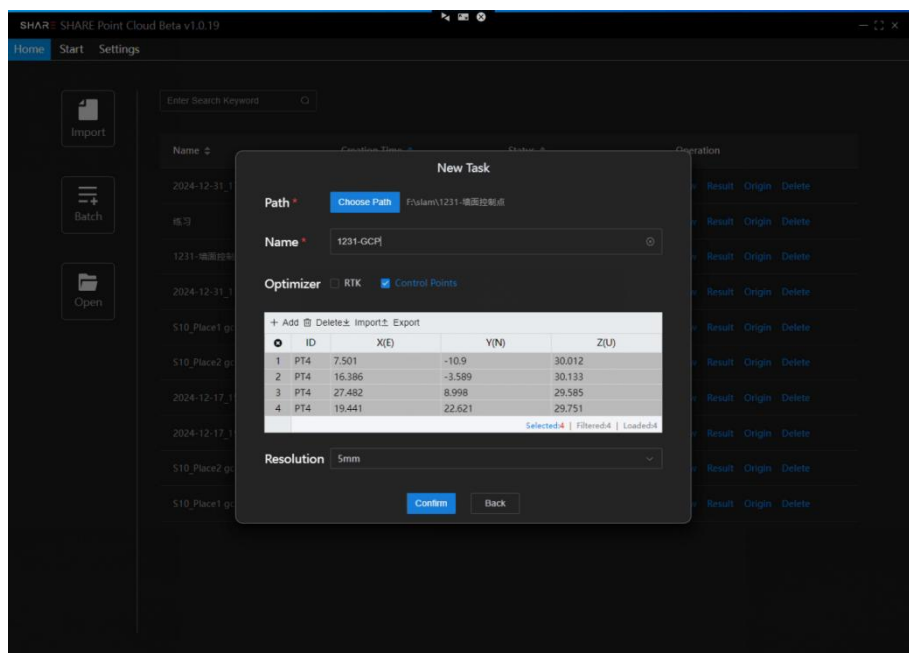

5.6 Process Result

After the data is successfully imported, will start processing, and the status will display processing status in real time. After the point cloud rendering is completed, it will be displayed as done. Select "View" on the right side of the project bar to view the processing effect of the point cloud.

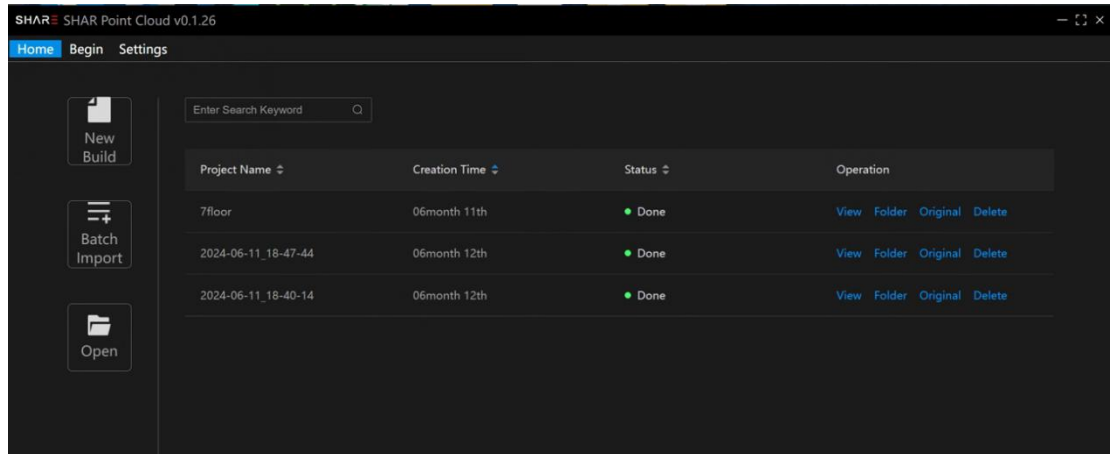

View the processed project. You can adjust the point cloud effect according to actual needs in the toolbar on the left, and the plane graph and photos taken will be displayed synchronously on the right.

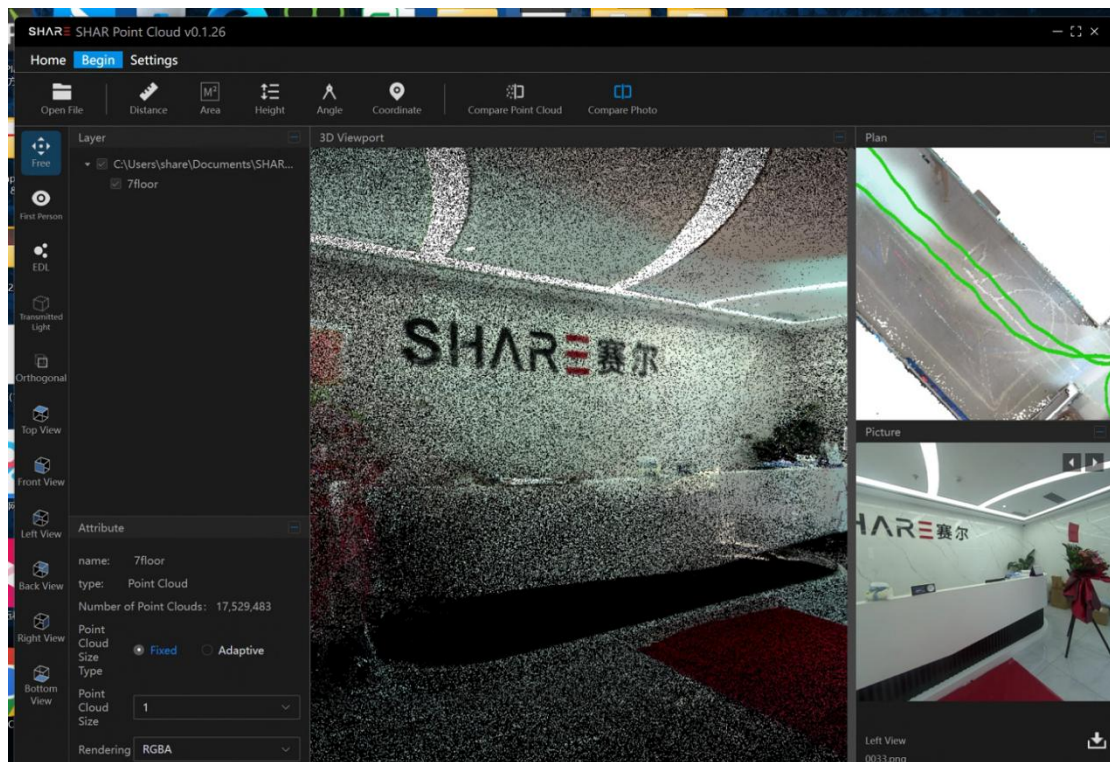

5.7 Software Interface

5.7.1 Layer Interface

The point cloud data loaded in the 3D-View is displayed in the form of a directory tree, making it convenient for users to operate on the point cloud data.

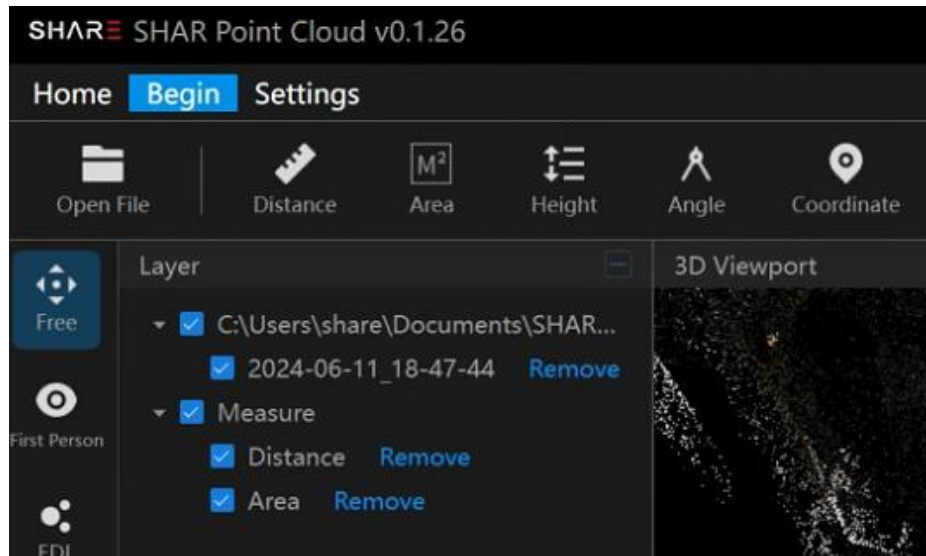

● Layer Show/Hide

Click the small box in front of the layer to change the visibility of the layer. When the layer is in the "checked" state, the data of the layer is displayed in the 3D scene.

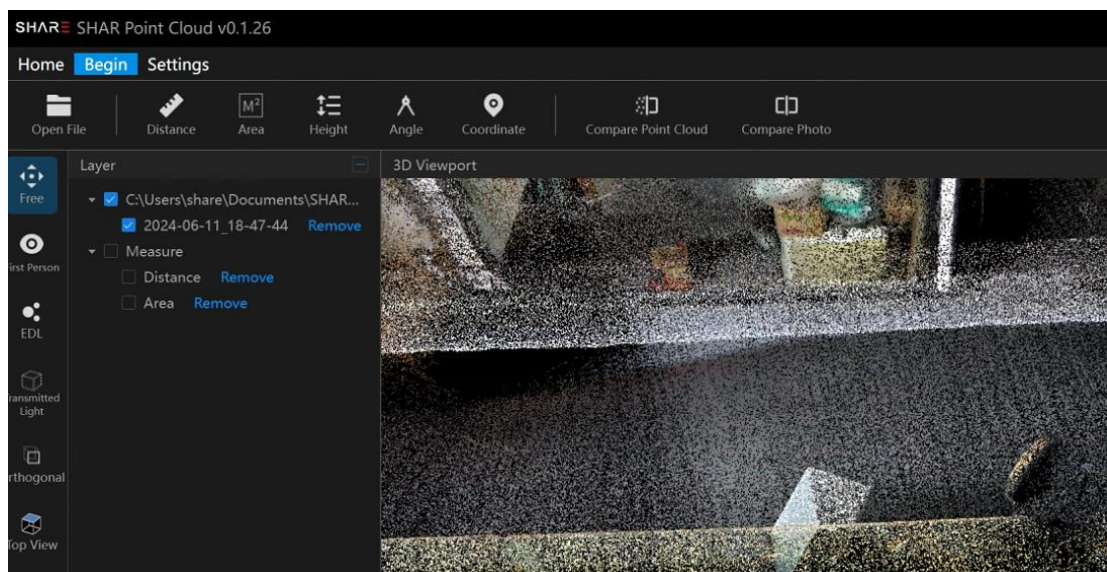

● Remove Layer

Click the "Remove" option behind the layer to remove the current layer.

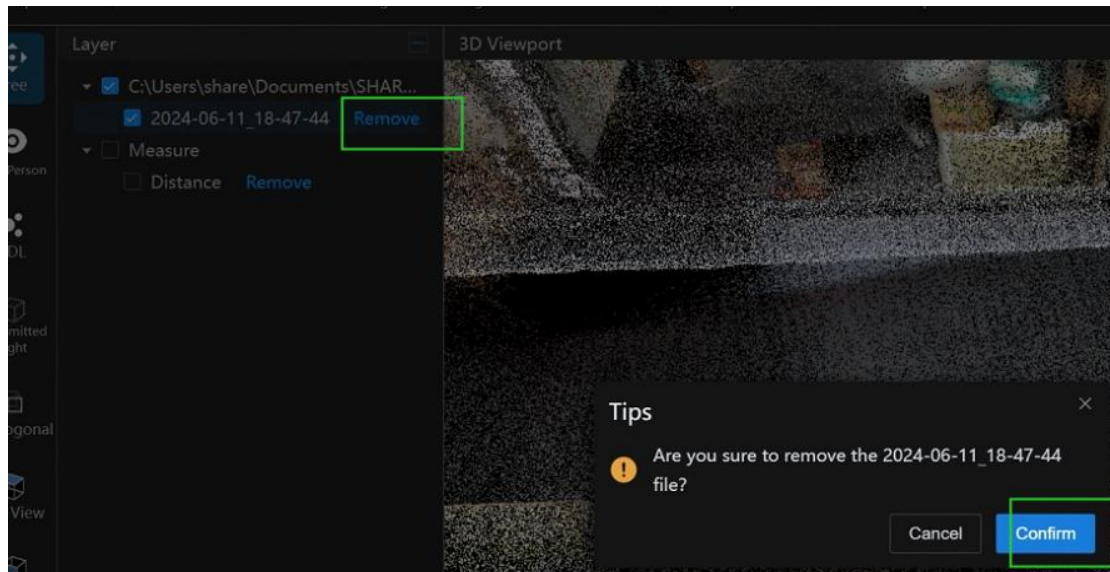

● Rename Layer

Select the layer, right-click and click "Rename".

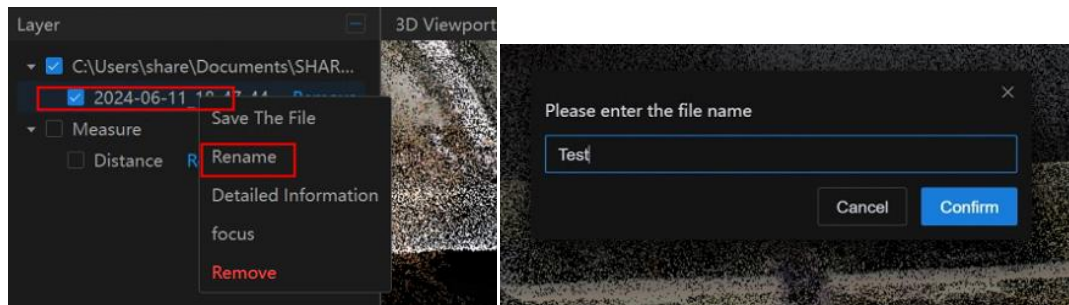

5.7.2 Attribute Interface

Displays detailed attribute information of the project selected in the layer window, and allows interactively changing related attributes of the layer.

● Point Cloud Layer Attribute

Selecting the point cloud layer will display the detailed attribute information of the point cloud, and the attributes of the point cloud can be changed.

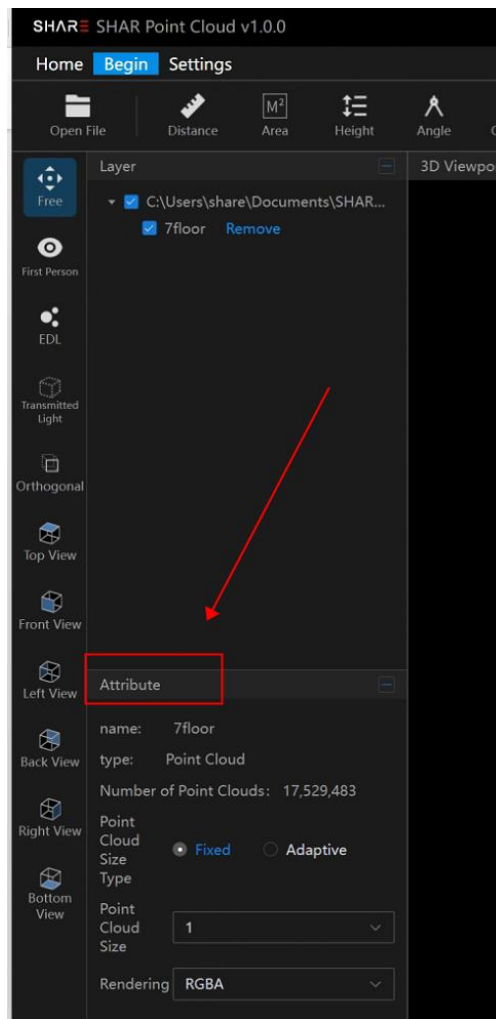

The detailed description of each parameter is as follows

Name: Project Name

Type: data type,display Point Cloud

Point Cloud Number: Display Point Cloud Number of selected layer

(Continued on next page)

Size Type: Control of the point cloud display size in the scene. When "Fixed" is selected, the point cloud display size can be adjusted in the "Point Cloud Size" parameter; when the "Adaptive" option is selected, the point cloud automatically calculates the size of the point cloud.

Point Cloud Size: Control the size of the point cloud displayed in the scene

Rendering: Set point cloud rendering mode . The default is "RGBA (True Color)", which can be switched to "Elevation" or "Intensity" rendering mode.



True Color Rendering

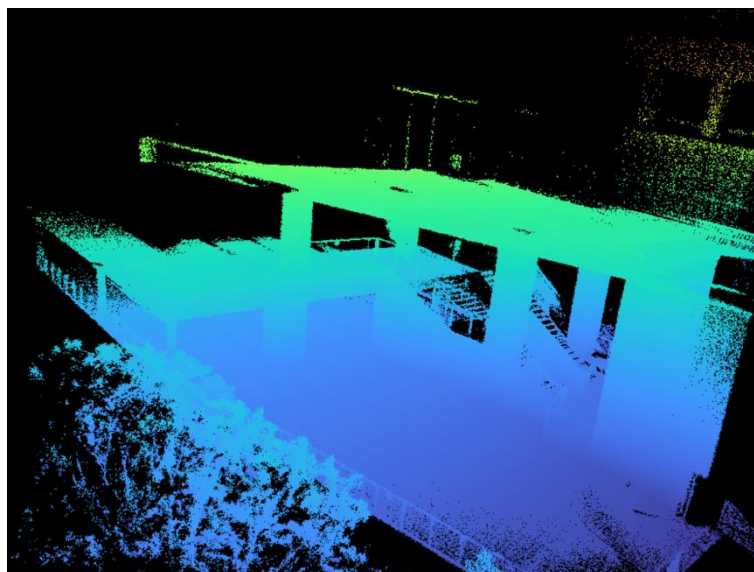

Elevation Rendering

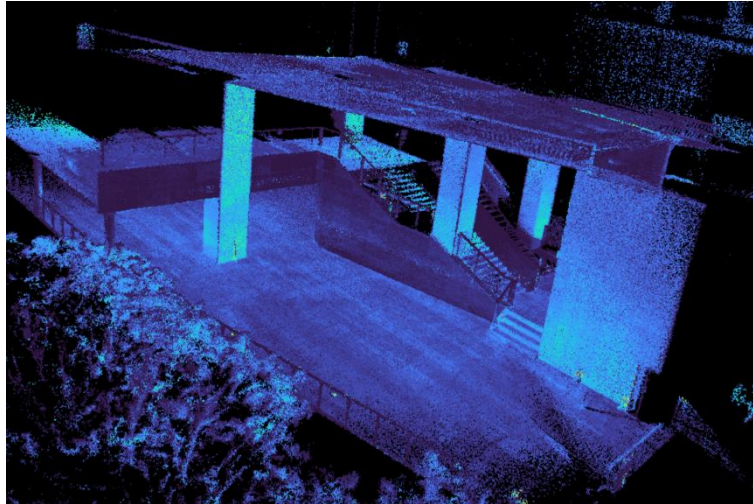

Intensity Rendering

● Measurement Layer Attribute

Select the measurement layer in the layer window to display information related to the measurement results, and you can also copy the measurement results.

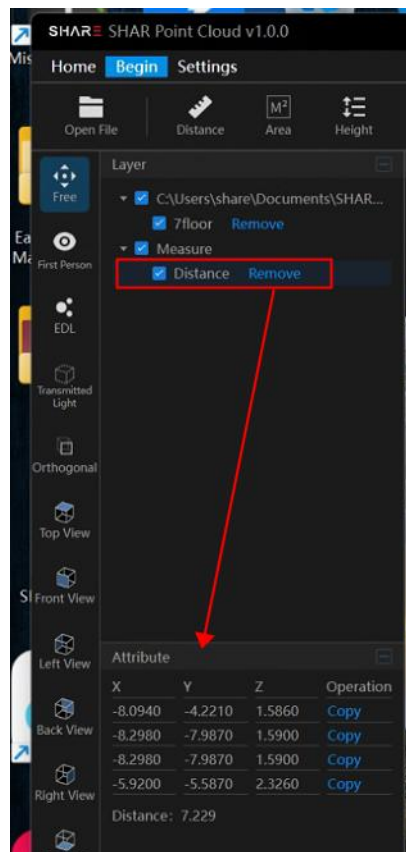

5.7.3 3D Viewport interface

The 3D viewport is the main interface for point cloud display and supports 3D display of point clouds.



The operation logic of the mouse control window is as follows

Pan : hold down the left mouse button and drag to pan 3D viewport interface;

Rotate: hold down the right mouse button and drag to rotate the 3D viewport;

Zoom the viewport: scroll the mouse wheel to zoom the scene, and the zoom center is the mouse pick-up point.

Note: You can also control the display of the 3D viewport interface through the "Interface Control Toolbar", see the "Interface Control Toolbar" section for details.

5.8 Interface Control Toolbar

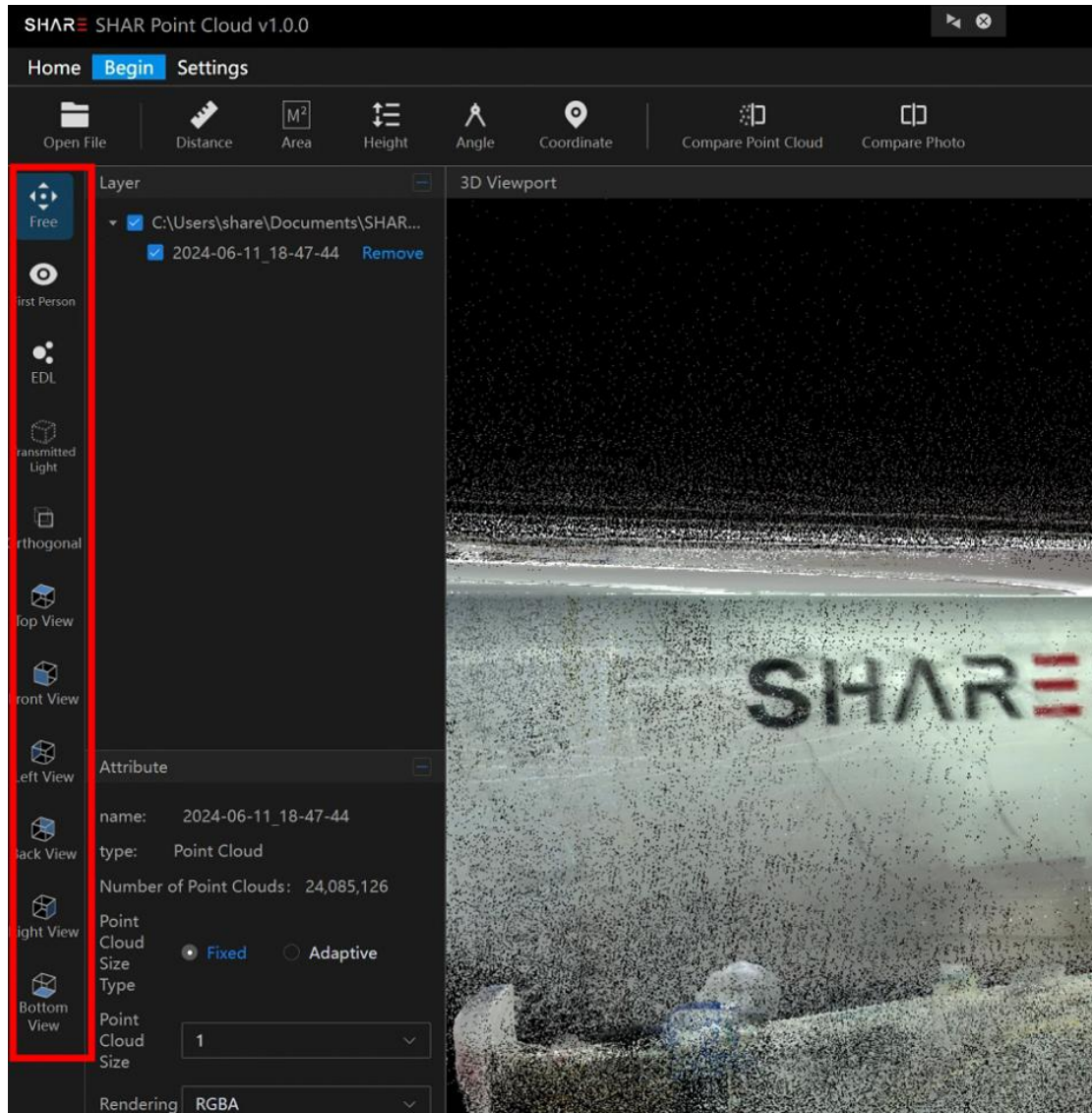

- **Free Mode/First Person**

Free Mode: Use the mouse to control the browsing of the point cloud in the 3D viewport, such as pan, zooming and rotation

First Person: Use the keyboard to control the navigation of the point cloud in the 3D viewport.

W: Forward	S: Backward	A: Move Left
D: Move Right	Q: Descend	E: Ascend

- Perspective /Orthogonal

The default mode is Perspective. Click Orthogonal to switch to Ortho mode.

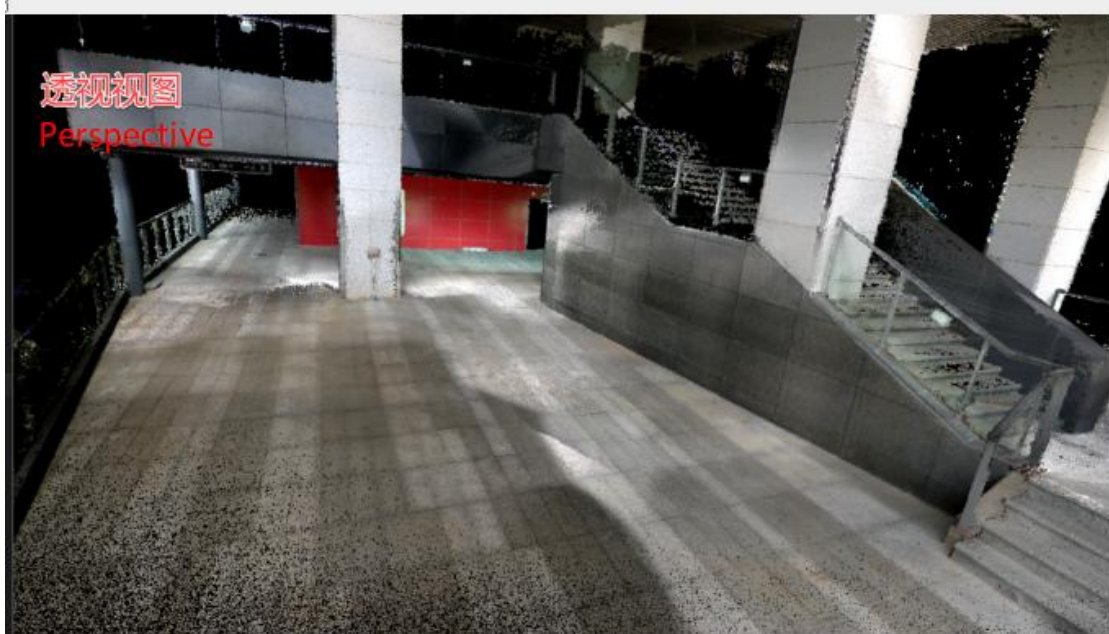

- EDL Effect

Visual enhancement technology enhances the depth and contour clarity of point clouds by simulating lighting effects, making the details of the model more prominent.



- **Transmitted Light Effect**

Simulate the X-ray transmission effect to facilitate viewing the internal structure of the model.



- **Top View/Front View/Left View/Right View/Bottom View/Back View**

The point cloud in the 3D viewport can be viewed from different perspectives.

5.9 Tool Menu

The tool menu provides common measurement functions, point cloud comparison and photo comparison functions

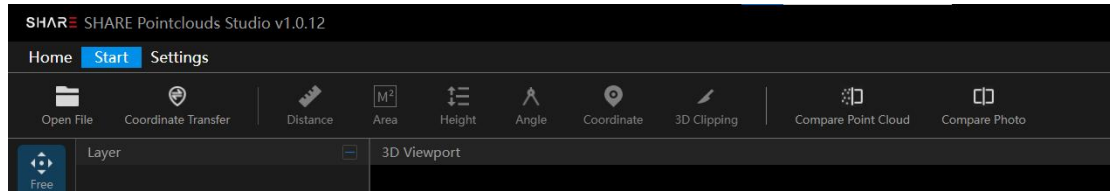

5.9.1 Coordinate Transfer

Coordinate transfer function supports using external control points or GNSS data to transform point clouds into absolute coordinate systems. Only when point cloud data has absolute coordinates can it be matched with the real world. (Only data collected using RTK can be processed.)

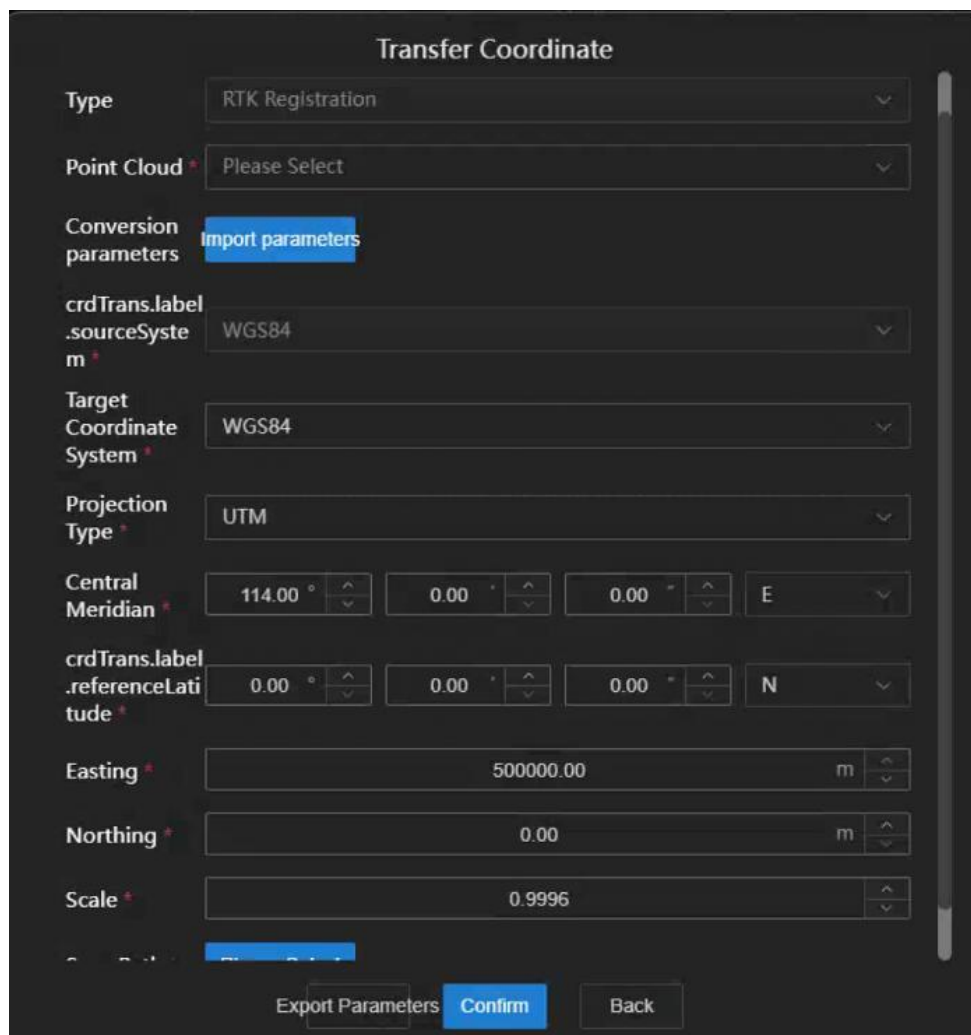

5.9.2 RTK Registration

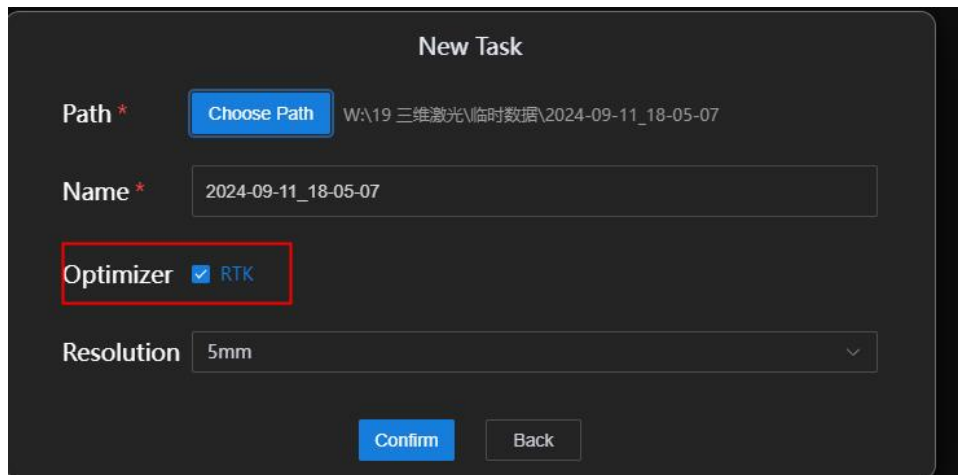

When the collected data contains RTK information and the "Optimizer RTK" Parameter is selected when creating a new task, you can choose "RTK Registration" As the transformation type in the "Coordinate Transfer" function to convert point cloud data to an absolute coordinate system.

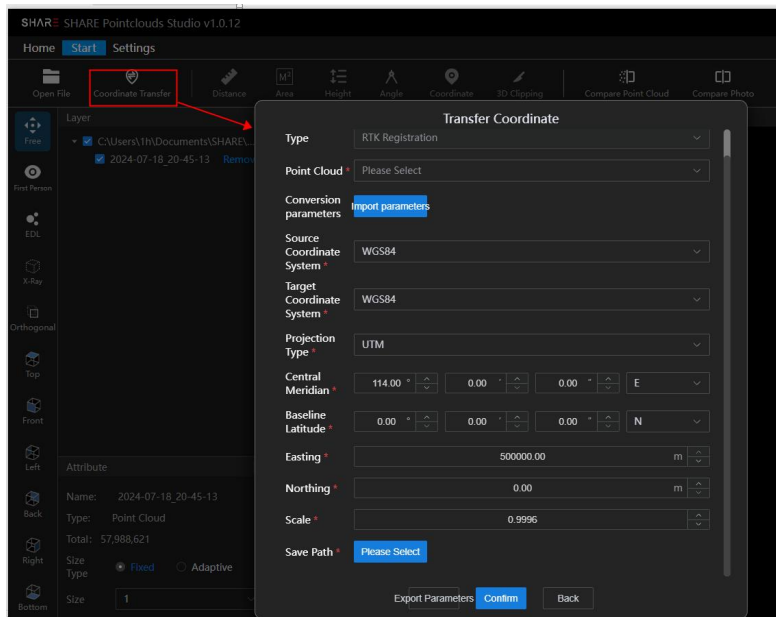

In the "Coordinate Transfer" interface, set the "Type" to "RTK Registration," and add the point cloud files to be transformed. You can add point cloud data from the layer list via the drop-down menu, or add external point cloud data by clicking the "Add" button in the drop-down menu.

Conversion Parameters : Supports setting the Source Coordinate System, Target Coordinate System, Projection Type, Central Meridian, Baseline Latitude, Easting (offset), northing (offset),

and scale. Manual input is supported, as well as unified setting through the “Import Parameters” button. The meanings of each parameter are as follows:

Source Coordinate System: Should be consistent with the RTK account coordinate system when the RTK account is enabled during data collection. By default, it is the WGS84 ellipsoid system, but it can be switched to the CGCS2000 ellipsoid system.

Target Coordinate System: Sets the ellipsoid system for the resulting data after transformation. By default, it is the WGS84 ellipsoid, but it can be switched to the CGCS2000 ellipsoid. If there are corresponding check points collected during data collection, the target system can be set to the same ellipsoid system as the check points.

Projection Type: Supports UTM projection, Gauss three-degree zone projection, and Gauss six-degree zone projection.

Projection Parameters: Includes central meridian, reference latitude, east offset, north offset, and scale. Typically, only the “central meridian” needs to be set.

Save Path : By default, it remains the same as the source file path, but you can choose to save it in another location.

After completing the parameter settings, click the “Confirm” button to do RTK Registration operation, with the progress displayed in a progress bar.

Upon completion, a pop-up will notify the user. Clicking “Browse” will add the data to the scene. The “Coordinate Pickup” function can be used to obtain the position information of a point cloud in the scene.

Note:

- You can click the “Export Parameters” button to export the parameters, which can be used for performing “Coordinate Transformation” on other point cloud data in the same batch.
- Typically, you only need to set the central meridian and Projection Type of the data collection area, and the other parameters can be kept as default.

5.9.3 Measurement Functions

Distance/Area/ Height/Angle/Coordinate

Click the "Distance" button to open the distance measurement function; click the point to be measured in the 3D View interface, and you can view the measurement results in the 3D View or click the attribute in the measurement layer to view the measurement results. The same method can be used to measure area, elevation, angle, coordinates, etc.

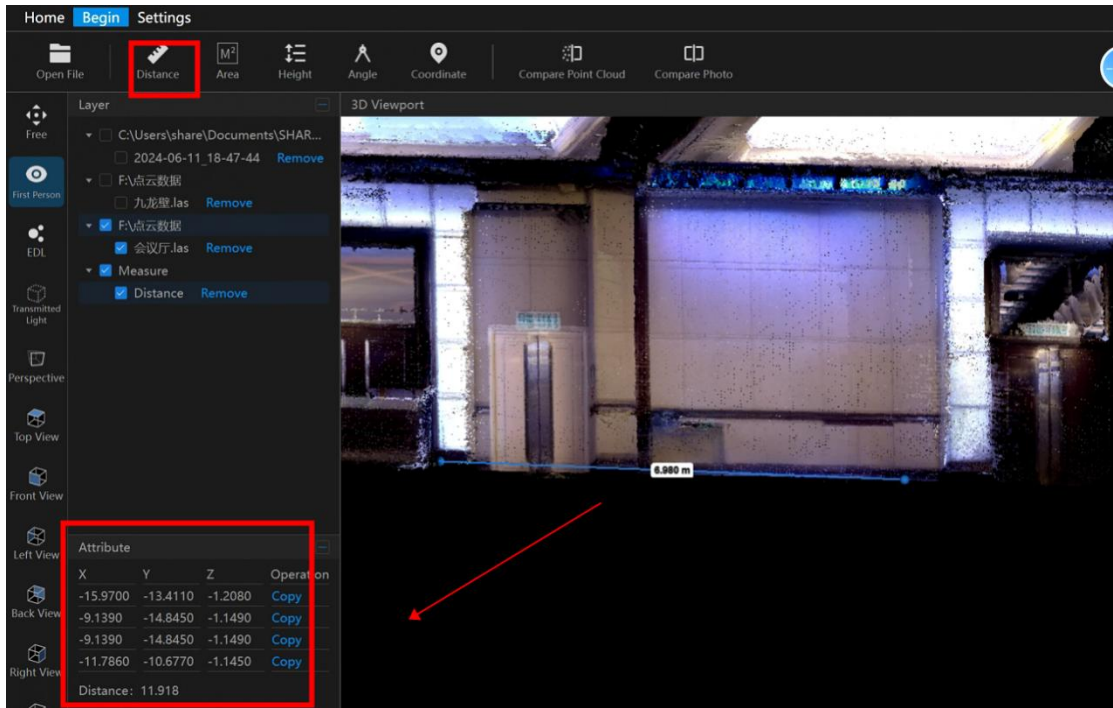

5.9.4 Compare Point Cloud

The Compare Point Cloud function provides users with an efficient way to visually compare point cloud data. By synchronizing the point cloud views in two windows, users can find differences and similarities between different project file.

➤ Data Loading

Users open the point cloud data they want to compare in two separate view windows. This data can be that has been previously loaded into the layer window, or directly imported from an external file.

➤ Perspective Synchronization

After activating the Perspective Lock function, rotation, translation, or zoom operations on the point cloud in one window will automatically be replicated in the point cloud view of the other window for synchronized viewing.

➤ Independent Operation

If you need to view a point cloud in more detail, you can unlock the perspective and operate the view of one window independently without affecting the display status of the other window.

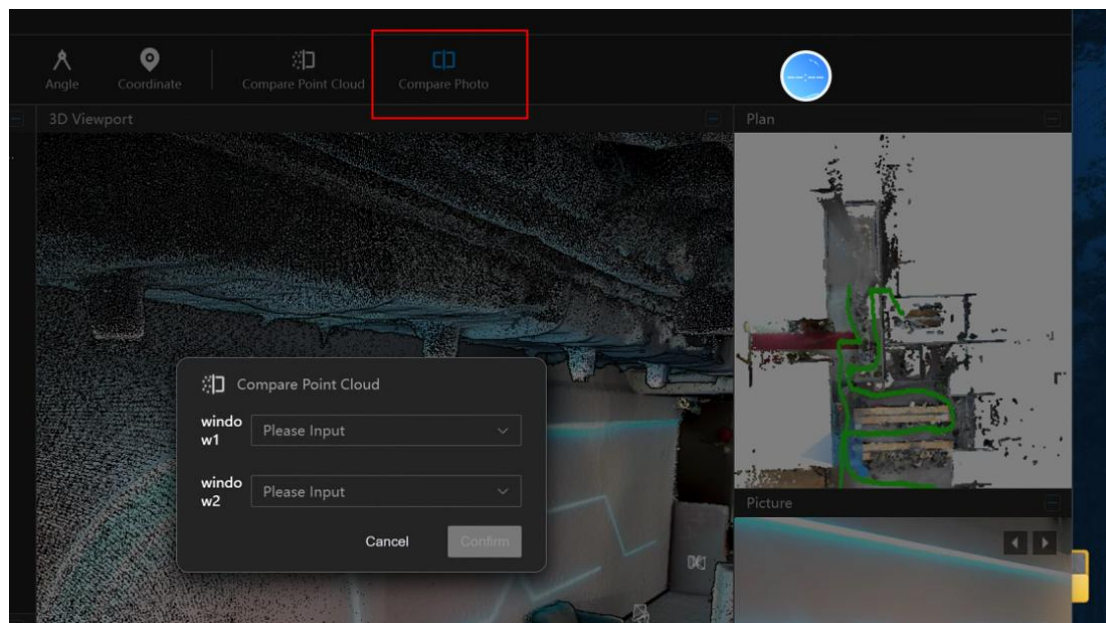

5.9.5 Compare Photo

The photo comparison function enables users to conduct in-depth comparative analysis of color point clouds, plan graph and on-site photos. This function facilitates users' applications in point cloud analysis, on-site reproduction and data verification

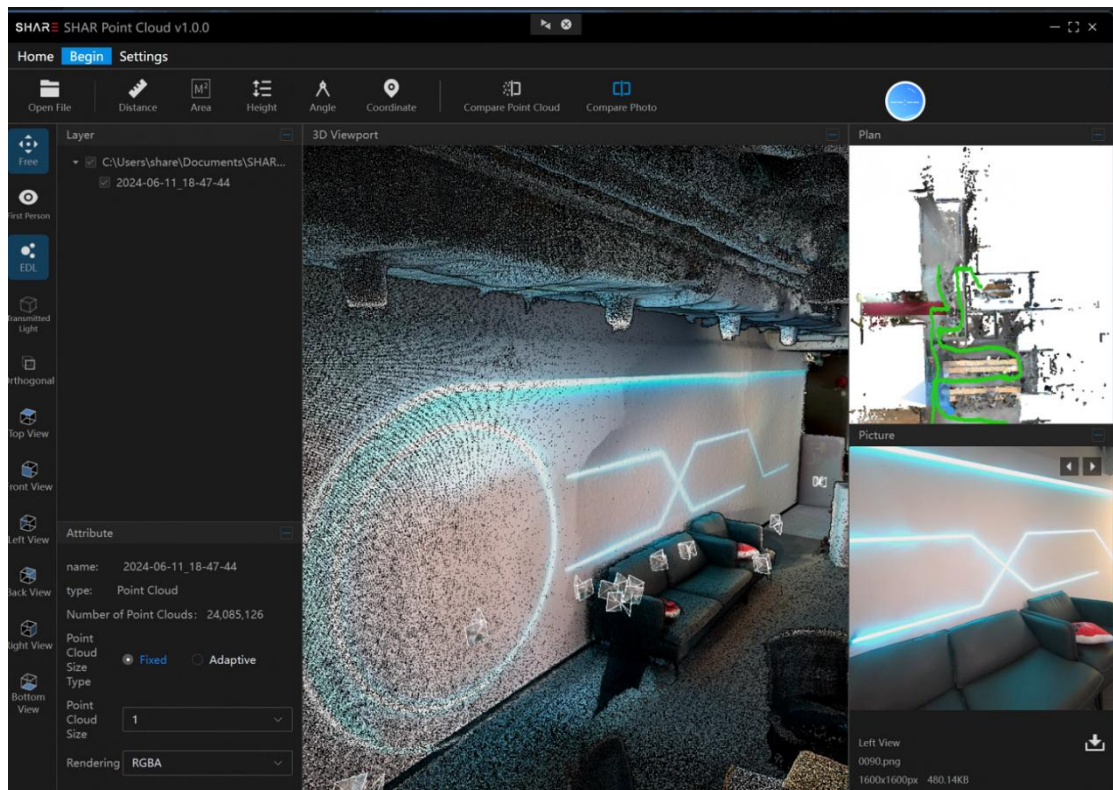

6 Device Maintenance

Do not disassemble or alter the device without permission.

Handheld LiDAR Device checking and debugging have been completed before delivery. Please do not alter or dismantle the device by yourself. The consequences caused by users' unauthorized modification of the camera shall be borne by users. If you need to design or modify the camera to install and load, please contact SHARE technical support staff.

6.1 Charge

If you need to charge, please take out the charger that comes with SHARE SLAM S20. After inserting the charger into the TYPE-C port of the charging slot, the power indicator light on the grip battery will light up, indicating that the battery is connected to the charger. At the same time, you can press the power button on the grip to check the remaining battery power. When charging, you can check the charging progress by observing the number of indicator lights on the battery.

6.2 Precaution

(1) Please store the Handheld LiDAR Device in a dry and ventilated place at normal temperature to avoid lens fogging caused by excessive humidity. The recommended storage environment temperature is from -20°C to 60°C , If the lens fogs up, water vapor will dissipate automatically after the Handheld LiDAR Device is turned on and heat up for a period of time.

(2) Avoid storing the Handheld LiDAR Device in a place of strong vibration and strong magnetic .

(3) Avoid bringing the equipment directly from cold places to warm places to prevent moisture condensation.

(4) Do not place the Handheld LiDAR Device in strong light for a long time

(5) Avoid scratching the lens & Lidar surface coating by hand or hard objects, otherwise the camera image will be blurred.

(6) Keep the Handheld LiDAR Device interface clean and dry, and install the protective cover in time;

(7) When cleaning the lens, please use a soft and dry cleaning cloth to wipe. Please do not use a cleaner containing organic solvents such as thinner or gasoline to clean the UV lens.

(8) Do not use unstable power supply or power supply that exceeds the voltage range of the Handheld LiDAR Device.

(9) Do not turn on or turn off the camera frequently. Please wait for more than 60 s at the interval of continuous power on or off, otherwise it will affect the life of the Handheld LiDAR Device.

(10) The Handheld LiDAR Device is kind of a precision equipment, please keep it stored in the shipping box during transportation process.

7 After Sales

7.1 Shipment

All equipment delivered by SHARE UAV shall be packed in accordance with the standard protective measures for packaging and transportation. Such packaging shall meet the requirements according to the specific properties of the equipment for long-distance transportation, moisture resistance, shock resistance, rust prevention, etc. to ensure that the equipment could be arrived safely at the place of delivery.

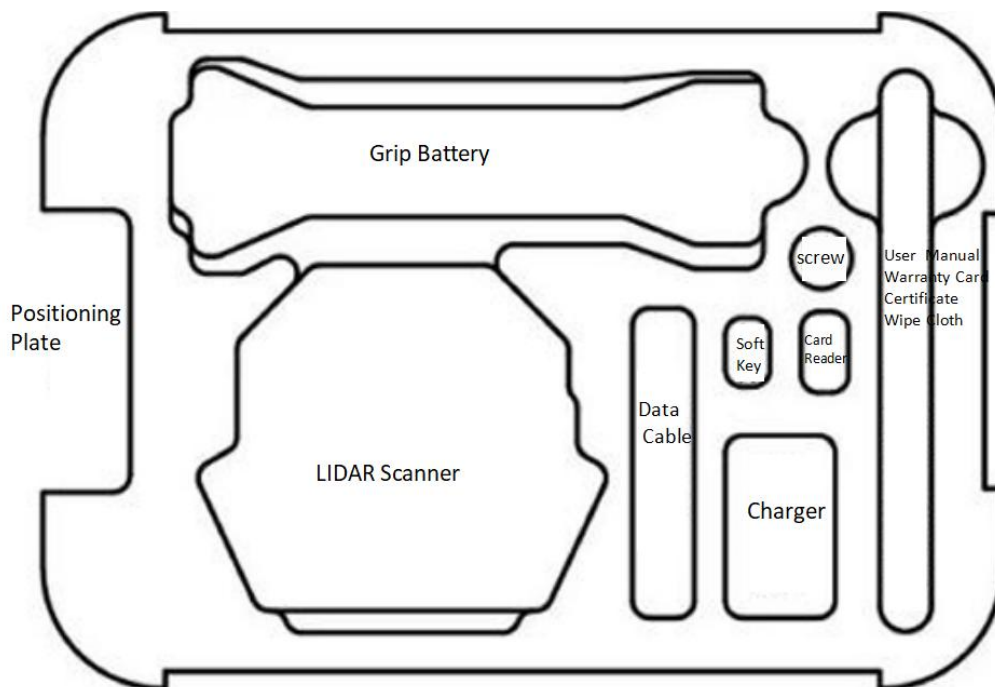

Shipping Box Layout

The SHARE SLAM S20 shipping box adopts an industrial-grade box manufacturing process. The case uses an engineering plastic moisture-proof box. The structure is strong and durable. Keep the cover of the shipping box upward, and do not place it upside down. Avoid severe vibration and turbulence during transportation.

7.2 After-sales Service

- 1) Hardware warranty terms: 1 year warranty since delivery. During the warranty period, Party B shall only undertake the delivery, maintenance and quality guarantee of Party A's goods within the territory of the People's Republic of China.
- 2) Warranty service: Regulations on after-sales service of SHARE UAV

Party A: Buyer of Products

Party B: SHAREUAV Ltd

The after-sales service content shall refer to the after-sales service regulations of SHARE UAV;

During the warranty period, Party B will provide Party A with regular technical support free of charge, and bear the related costs of repair and replacement caused by product quality problems. Devices with below conditions will be out of warranty even if within warranty time: water damaged, for damage caused by non-quality problems, Party B will provide repairing service and charge to Party A. The warranty label shall not be opened, torn or destroyed privately, otherwise the warranty will be invalid.

If you have any questions, please contact SHAREUAV Ltd

After-sales service and technical support tel: +86-755-23216686 (working days 9:00-18:00 Beijing time)

SHARE 赛尔



Official Website



YouTube



Facebook

If you have any questions about the product
Please contact us via below email:
INFO@SHAREUAVTEC.COM

SHAREUAV Ltd

FCC Caution.

§ 15.19 Labelling requirements.

This device complies with part 15 of the FCC Rules. Operation is subject to the following two conditions: (1) This device may not cause harmful interference, and (2) this device must accept any interference received, including interference that may cause undesired operation.

§ 15.21 Information to user.

Any Changes or modifications not expressly approved by the party responsible for compliance could void the user's authority to operate the equipment.

§ 15.105 Information to the user.

Note: This equipment has been tested and found to comply with the limits for a Class B digital device, pursuant to part 15 of the FCC Rules. These limits are designed to provide reasonable protection against harmful interference in a residential installation. This equipment generates uses and can radiate radio frequency energy and, if not installed and used in accordance with the instructions, may cause harmful interference to radio communications. However, there is no guarantee that interference will not occur in a particular installation. If this equipment does cause harmful interference to radio or television reception, which can be determined by turning the equipment off and on, the user is encouraged to try to correct the interference by one or more of the following measures:

- Reorient or relocate the receiving antenna.
- Increase the separation between the equipment and receiver.
- Connect the equipment into an outlet on a circuit different from that to which the receiver is connected.
- Consult the dealer or an experienced radio/TV technician for help.

This equipment complies with FCC radiation exposure limits set forth for an uncontrolled environment. This equipment should be installed and operated with minimum distance 20cm between the radiator & your body.

