



FCC TEST REPORT

FCC ID:2BGWH-S3PRO

Report Number..... : ZKT-2406036170E

Date of Test..... Jun. 03, 2024 to Jun. 11, 2024

Date of issue..... : Jun. 11, 2024

Total number of pages..... 61

Test Result..... : PASS

Testing Laboratory..... : **Shenzhen ZKT Technology Co., Ltd.**

Address : 1/F, No. 101, Building B, No. 6, Tangwei Community Industrial Avenue, Fuhai Street, Bao'an District, Shenzhen, China

Applicant's name : **Shenzhen HOTVISION Technology Co., Ltd**

Address : 4th Floor, Comprehensive Building, Xiang Technology and Cultural Industry Park, Jiuwei Community, Hangcheng Street, Bao'an District, Shenzhen

Manufacturer's name : **Shenzhen HOTVISION Technology Co., Ltd**

Address : 4th Floor, Comprehensive Building, Xiang Technology and Cultural Industry Park, Jiuwei Community, Hangcheng Street, Bao'an District, Shenzhen

Test specification:

Standard..... : FCC CFR Title 47 Part 15 Subpart C Section 15.247
ANSI C63.10:2013

Test procedure..... : /

Non-standard test method : N/A

Test Report Form No..... : TRF-EL-110_V0

Test Report Form(s) Originator..... : ZKT Testing

Master TRF : Dated: 2020-01-06

This device described above has been tested by ZKT, and the test results show that the equipment under test (EUT) is in compliance with the FCC requirements. And it is applicable only to the tested sample identified in the report.

This report shall not be reproduced except in full, without the written approval of ZKT, this document may be altered or revised by ZKT, personal only, and shall be noted in the revision of the document.

Product name..... : **S3PRO low-power PIR camera**

Trademark : N/A

Model/Type reference..... : S3PRO

S2

Ratings..... : Input: 5V --- 1.0A

Battery: 3.7V, 2600mAh, 9.62Wh



Testing procedure and testing location:

Testing Laboratory.....: **Shenzhen ZKT Technology Co., Ltd.**

Address.....: 1/F, No. 101, Building B, No. 6, Tangwei Community Industrial Avenue, Fuhai Street, Bao'an District, Shenzhen, China

Tested by (name + signature).....: Jim.Liu

Reviewer (name + signature).....: Jackson.Fang

Approved (name + signature).....: Lake Xie





Table of Contents

| | Page |
|---|-----------|
| 1. VERSION | 5 |
| 2. SUMMARY OF TEST RESULTS | 6 |
| 2.1 TEST FACILITY | 7 |
| 2.2 MEASUREMENT UNCERTAINTY | 7 |
| 3. GENERAL INFORMATION | 8 |
| 3.1 GENERAL DESCRIPTION OF EUT | 8 |
| 3.2 DESCRIPTION OF TEST MODES | 9 |
| 3.3 BLOCK DIGRAM SHOWING THE CONFIGURATION OF SYSTEM TESTED | 9 |
| 3.4 DESCRIPTION OF SUPPORT UNITS(CONDUCTED MODE) | 10 |
| 3.5EQUIPMENTS LIST FOR ALL TEST ITEMS | 11 |
| 4. EMC EMISSION TEST | 13 |
| 4.1 CONDUCTED EMISSION MEASUREMENT | 13 |
| 4.1.1 POWER LINE CONDUCTED EMISSION Limits | 13 |
| 4.1.2 TEST PROCEDURE | 13 |
| 4.1.3 DEVIATION FROM TEST STANDARD | 13 |
| 4.1.4 TEST SETUP | 14 |
| 4.1.5 EUT OPERATING CONDITIONS | 14 |
| 4.2.1 RADIATED EMISSION LIMITS | 17 |
| 4.2.2 TEST PROCEDURE | 18 |
| 4.2.3 DEVIATION FROM TEST STANDARD | 18 |
| 4.2.4 TEST SETUP | 18 |
| 4.2.5 EUT OPERATING CONDITIONS | 19 |
| 4.2.6 TEST RESULTS | 19 |
| 5.RADIATED BAND EMISSIONMEASUREMENT | 30 |
| 5.1 TEST REQUIREMENT: | 30 |
| 5.2 TEST PROCEDURE | 30 |
| 5.3 DEVIATION FROM TEST STANDARD | 30 |
| 5.4 TEST SETUP | 31 |
| 5.5 EUT OPERATING CONDITIONS | 31 |
| 5.6 TEST RESULT | 32 |
| 6.POWER SPECTRAL DENSITY TEST | 34 |
| 6.1 APPLIED PROCEDURES / LIMIT | 34 |
| 6.2 TEST PROCEDURE | 34 |
| 6.3 DEVIATION FROM STANDARD | 34 |
| 6.4 TEST SETUP | 34 |
| 6.5 EUT OPERATION CONDITIONS | 34 |
| 6.6 TEST RESULT | 35 |



- 7. CHANNEL BANDWIDTH OCCUPY BANDWIDTH43**
 - 7.1 APPLIED PROCEDURES / LIMIT 43
 - 7.2 TEST PROCEDURE 43
 - 7.3 DEVIATION FROM STANDARD 43
 - 7.4 TEST SETUP43
 - 7.5 EUT OPERATION CONDITIONS 43
 - 7.6 TEST RESULT44
- 8.PEAK OUTPUT POWER TEST 47**
 - 8.1 APPLIED PROCEDURES/LIMIT 47
 - 8.2 TEST PROCEDURE 47
 - 8.3 DEVIATION FROM STANDARD 47
 - 8.4 TEST SETUP47
 - 8.5 EUT OPERATION CONDITIONS 47
 - 8.6 TEST RESULT48
- 9. CONDUCTED BAND EDGE AND SPURIOUS EMISSION 49**
 - 9.1 APPLICABLE STANDARD49
 - 9.2 TEST PROCEDURE 49
 - 9.3 DEVIATION FROM STANDARD 49
 - 9.4 TEST SETUP49
 - 9.5 EUT OPERATION CONDITIONS 49
 - 9.6 TEST RESULTS 49
- 10. DUTY CYCLE56**
 - 10.1 APPLIED PROCEDURES / LIMIT 56
 - 10.2 DEVIATION FROM STANDARD 56
 - 10.3 TEST SETUP 56
- 11. ANTENNA REQUIREMENT 60**
- 12. TEST SETUP PHOTO 61**
- 13. EUT CONSTRUCTIONAL DETAILS 61**



1. VERSION

| ReportNo. | Version | Description | Approved |
|-----------------|---------|-------------------------|---------------|
| ZKT-2406036170E | Rev.01 | Initial issue of report | Jun. 11, 2024 |
| | | | |
| | | | |



2. SUMMARY OF TEST RESULTS

Test procedures according to the technical standards:

| FCC Part15 (15.247) , Subpart C | | | |
|---------------------------------|----------------------------------|--------|--------|
| Standard Section | Test Item | Result | Remark |
| FCC part 15.203/15.247 (c) | Antenna requirement | PASS | |
| FCC part 15.207 | AC Power Line Conducted Emission | PASS | |
| FCC part 15.247 (b)(3) | Conducted Peak Output Power | PASS | |
| FCC part 15.247 (a)(2) | -6dB Channel Bandwidth | PASS | |
| FCC part 15.247 (e) | Power Spectral Density | PASS | |
| FCC part 15.247(d) | Band Edge | PASS | |
| FCC part 15.205/15.209 | Spurious Emission | PASS | |

NOTE:

(1)" N/A" denotes test is not applicable in this Test Report



2.1 TEST FACILITY

Shenzhen ZKT Technology Co., Ltd.

Add. : 1/F, No. 101, Building B, No. 6, Tangwei Community Industrial Avenue, Fuhai Street, Bao'an District, Shenzhen, China

FCC Test Firm Registration Number: 692225

Designation Number: CN1299

IC Registered No.: 27033

CAB identifier: CN0110

2.2 MEASUREMENT UNCERTAINTY

The reported uncertainty of measurement $y \pm U$ · where expanded uncertainty U is based on a standard uncertainty multiplied by a coverage factor of $k=2$ · providing a level of confidence of approximately 95 % .

| No. | Item | Uncertainty |
|-----|---|-------------|
| 1 | 3m chamber Radiated spurious emission(9KHz-30MHz) | U=4.5dB |
| 2 | 3m chamber Radiated spurious emission(30MHz-1GHz) | U=4.8dB |
| 3 | 3m chamber Radiated spurious emission(1GHz-6GHz) | U=4.9dB |
| 4 | 3m chamber Radiated spurious emission(6GHz-40GHz) | U=5.0dB |
| 5 | Conducted disturbance | U=3.2dB |
| 6 | RF Band Edge | U=1.68dB |
| 7 | RF power conducted | U=1.86dB |
| 8 | RF conducted Spurious Emission | U=2.2dB |
| 9 | RF Occupied Bandwidth | U=1.8MHz |
| 10 | RF Power Spectral Density | U=1.75dB |
| 11 | humidity uncertainty | U=5.3% |
| 12 | Temperature uncertainty | U=0.59°C |



3. GENERAL INFORMATION

3.1 GENERAL DESCRIPTION OF EUT

| | |
|-----------------------------------|---|
| Product Name: | S3PRO low-power PIR camera |
| Model No.: | S3PRO |
| Model Different.: | Only for different model name |
| Serial No.: | S2 |
| Sample ID | ZKT-2406036170E |
| Sample(s) Status: | Engineer sample |
| Channel numbers: | 802.11b/802.11g /802.11n(HT20):11 802.11n(HT40):7 |
| Channel separation: | 5MHz |
| Modulation technology: | 802.11b: Direct Sequence Spread Spectrum(DSSS) 802.11g/802.11n(H20/H40): Orthogonal Frequency Division Multiplexing(OFDM) |
| Frequency range: | 20M: 2412MHz-2462MHz 40M: 2422MHz-2452MHz |
| Antenna Type and Antenna gain: | 802.11b/g/n20/n40: FPC Antenna Antenna gain: 2dBi |
| Power Supply: | Input: AC100-240V~, 50/60Hz, 1A |
| Adapter: | N/A |



| Operation Frequency each of channel | | | | | | | |
|-------------------------------------|-----------|-------------|-----------|-------------|-----------|-------------|-----------|
| Channel | Frequency | Chann el | Frequency | Chann el | Frequency | Chann el | Frequency |
| 1 | 2412MHz | 4 | 2427MHz | 7 | 2442MHz | 10 | 2457MHz |
| 2 | 2417MHz | 5 | 2432MHz | 8 | 2447MHz | 11 | 2462MHz |
| 3 | 2422MHz | 6 | 2437MHz | 9 | 2452MHz | X | |

Note:

In section 15.31(m), regards to the operating frequency range over 10 MHz, the Lowest frequency, the middle frequency, and the highest frequency of channel were selected to perform the test, and the selected channel see below:

| Test channel | Frequency (MHz) | |
|-----------------|-------------------------------|---------------|
| | 802.11b/802.11g/802.11n(HT20) | 802.11n(HT40) |
| Lowest channel | 2412MHz | 2422MHz |
| Middle channel | 2437MHz | 2437MHz |
| Highest channel | 2462MHz | 2452MHz |

3.2 DESCRIPTION OF TEST MODES

| | |
|---|--|
| Transmitting mode | Keep the EUT in continuously transmitting mode |
| Remark: During the test, the test voltage was tuned from 85% to 115% of the nominal rated supply voltage, and found that the worst case was under the nominal rated supply condition. So the report just shows that condition's data. | |

| | | | | |
|--|---------|---------|---------------|---------------|
| We have verified the construction and function in typical operation. All the test modes were carried out with the EUT in transmitting operation, which was shown in this test report and defined as follows: | | | | |
| Pre-scan all kind of data rate in lowest channel, and found the follow list which it was worst case. | | | | |
| Mode | 802.11b | 802.11g | 802.11n(HT20) | 802.11n(HT40) |
| Data rate | 1Mbps | 6Mbps | 6.5Mbps | 13Mbps |

| | |
|-----------------|------------------------|
| Test Software | Dbgmon (CMD) Test Tool |
| Powerlevelsetup | <17dBm |

3.3 BLOCK DIGRAM SHOWING THE CONFIGURATION OF SYSTEM TESTED

Conducted Emission

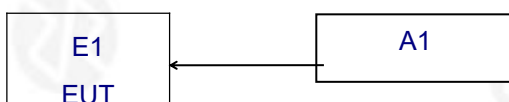

Radiated Emission





3.4 DESCRIPTION OF SUPPORT UNITS(CONDUCTED MODE)

The EUT has been tested as an independent unit together with other necessary accessories or support units. The following support units or accessories were used to form a representative test configuration during the tests.

| Item | Equipment | Mfr/Brand | Model/Type No. | Series No. | Note |
|------|--------------------|-----------|----------------|------------|-----------|
| E1 | Portable projector | N/A | S3PRO | S2 | EUT |
| A1 | Adapter | HUAWEI | HW-050100B3W | N/A | Auxiliary |

| Item | Shielded Type | Ferrite Core | Length | Note |
|------|---------------|--------------|--------|------|
| | | | | |
| | | | | |

Note:

- (1) The support equipment was authorized by Declaration of Confirmation.
- (2) For detachable type I/O cable should be specified the length in cm in 『Length』 column.



3.5EQUIPMENTS LIST FOR ALL TEST ITEMS

Conducted emissions Test

| Item | Kind of Equipment | Manufacturer | Type No. | Serial No. | Firmware Version | Last calibration | Calibrated until |
|------|---------------------|--------------|----------|----------------------|------------------|------------------|------------------|
| 1 | LISN | R&S | ENV216 | 101471 | N/A | Nov. 14, 2023 | Nov. 13, 2024 |
| 2 | LISN | CYBERTEK | EM5040A | E1850400149 | N/A | Nov. 02, 2023 | Nov. 01, 2024 |
| 3 | Test Cable | N/A | C-01 | N/A | N/A | Nov. 02, 2023 | Nov. 01, 2024 |
| 4 | Test Cable | N/A | C-02 | N/A | N/A | Nov. 02, 2023 | Nov. 01, 2024 |
| 5 | Test Cable | N/A | C-03 | N/A | N/A | Nov. 02, 2023 | Nov. 01, 2024 |
| 6 | EMI Test Receiver | R&S | ESCI3 | 101393 | 4.42 SP3 | Nov. 02, 2023 | Nov. 01, 2024 |
| 7 | Triple-Loop Antenna | N/A | RF300 | N/A | N/A | Nov. 02, 2023 | Nov. 01, 2024 |
| 8 | Absorbing Clamp | DZ | ZN23201 | 15034 | N/A | Nov. 07, 2023 | Nov. 06, 2024 |
| 9 | EMC Software | Frad | EZ-EMC | Ver.EMC-CON 3A1.1 | N/A | \ | \ |

Radiation emissions & Radio Test equipment

| Item | Equipment | Manufacturer | Type No. | Serial No. | Firmware Version | Last calibration | Calibrated until |
|------|-----------------------------------|----------------|-----------------|------------|------------------|------------------|------------------|
| 1 | Spectrum Analyzer (9kHz-26.5GHz) | KEYSIGHT | 9020A | MY55370835 | A.17.05 | Nov. 02, 2023 | Nov. 01, 2024 |
| 2 | Spectrum Analyzer (10kHz-39.9GHz) | R&S | FSV40-N | 100363 | 1.71 SP2 | Nov. 02, 2023 | Nov. 01, 2024 |
| 3 | EMI Test Receiver (9kHz-7GHz) | R&S | ESCI7 | 100969 | 4.32 | Nov. 02, 2023 | Nov. 01, 2024 |
| 4 | Bilog Antenna (30MHz-1500MHz) | Schwarzbeck | VULB9168 | N/A | N/A | Nov. 13, 2023 | Nov. 12, 2024 |
| 5 | Horn Antenna (1GHz-18GHz) | Agilent | AH-118 | 071145 | N/A | Nov. 13, 2023 | Nov. 12, 2024 |
| 6 | Horn Antenna (15GHz-40GHz) | A.H.System | SAS-574 | 588 | N/A | Nov. 13, 2023 | Nov. 12, 2024 |
| 7 | Loop Antenna | TESEQ | HLA6121 | 58357 | N/A | Nov. 16, 2023 | Nov. 15, 2024 |
| 8 | Amplifier (30-1000MHz) | EM Electronics | EM330 Amplifier | 60747 | N/A | Nov. 02, 2023 | Nov. 01, 2024 |
| 9 | Amplifier (1GHz-26.5GHz) | HuiPu | 8449B | 3008A00315 | N/A | Nov. 02, 2023 | Nov. 01, 2024 |
| 10 | Amplifier (500MHz-40GHz) | QuanJuDa | DLE-161 | 097 | N/A | Nov. 02, 2023 | Nov. 01, 2024 |
| 11 | Test Cable | N/A | R-01 | N/A | N/A | Nov. 02, 2023 | Nov. 01, 2024 |
| 12 | Test Cable | N/A | R-02 | N/A | N/A | Nov. 02, 2023 | Nov. 01, 2024 |
| 13 | Test Cable | N/A | R-03 | N/A | N/A | Nov. 02, 2023 | Nov. 01, 2024 |
| 14 | Test Cable | N/A | RF-01 | N/A | N/A | Nov. 02, 2023 | Nov. 01, 2024 |
| 15 | Test Cable | N/A | RF-02 | N/A | N/A | Nov. 02, 2023 | Nov. 01, 2024 |



| | | | | | | | |
|----|-----------------------------------|----------|-----------|-----------------------|----------|---------------|---------------|
| 16 | Test Cable | N/A | RF-03 | N/A | N/A | Nov. 02, 2023 | Nov. 01, 2024 |
| 17 | ESG Signal Generator | Agilent | E4421B | N/A | B.03.84 | Nov. 02, 2023 | Nov. 01, 2024 |
| 18 | Signal Generator | Agilent | N5182A | N/A | A.01.87 | Nov. 02, 2023 | Nov. 01, 2024 |
| 19 | Magnetic Field Probe Tester | Narda | ELT-400 | 0-0344 | N/A | Nov. 16, 2023 | Nov. 15, 2024 |
| 20 | Wideband Radio Communication Test | R&S | CMW500 | 106504 | V 3.7.22 | Nov. 02, 2023 | Nov. 01, 2024 |
| 21 | Power Meter | KEYSIGHT | N1912A P | N/A | A.05.00 | Nov. 02, 2023 | Nov. 01, 2024 |
| 22 | D.C. Power Supply | LongWei | TPR-6405D | N/A | N/A | \ | \ |
| 23 | EMC Software | Frad | EZ-EMC | Ver.EMC-CO N 3A1.1 | N/A | \ | \ |
| 24 | RF Software | MW | MTS8310 | V2.0.0.0 | N/A | \ | \ |
| 25 | Turntable | MF | MF-7802BS | N/A | N/A | \ | \ |
| 26 | Antenna tower | MF | MF-7802BS | N/A | N/A | \ | \ |



4. EMC EMISSION TEST

4.1 CONDUCTED EMISSION MEASUREMENT

| | |
|-----------------------|--------------------------------------|
| Test Requirement: | FCC Part15 C Section 15.207 |
| Test Method: | ANSI C63.10:2013 |
| Test Frequency Range: | 150KHz to 30MHz |
| Receiver setup: | RBW=9KHz, VBW=30KHz, Sweep time=auto |

4.1.1 POWER LINE CONDUCTED EMISSION Limits

| FREQUENCY (MHz) | Limit (dBuV) | | Standard |
|-----------------|--------------|-----------|----------|
| | Quasi-peak | Average | |
| 0.15 -0.5 | 66 - 56 * | 56 - 46 * | FCC |
| 0.50 -5.0 | 56.00 | 46.00 | FCC |
| 5.0 -30.0 | 60.00 | 50.00 | FCC |

Note:

(1) *Decreases with the logarithm of the frequency.

4.1.2 TEST PROCEDURE

- a. The EUT was placed 0.8 meters from the horizontal ground plane with EUT being connected to the power mains through a line impedance stabilization network (LISN). All other support equipments powered from additional LISN(s). The LISN provide 50 Ohm/ 50uH of coupling impedance for the measuring instrument.
- b. Interconnecting cables that hang closer than 40 cm to the ground plane shall be folded back and forth in the center forming a bundle 30 to 40 cm long.
- c. I/O cables that are not connected to a peripheral shall be bundled in the center. The end of the cable may be terminated, if required, using the correct terminating impedance. The overall length shall not exceed 1 m.
- d. LISN at least 80 cm from nearest part of EUT chassis.
- e. For the actual test configuration, please refer to the related Item –EUT Test Photos.

4.1.3 DEVIATION FROM TEST STANDARD

No deviation



4.1.4 TEST SETUP

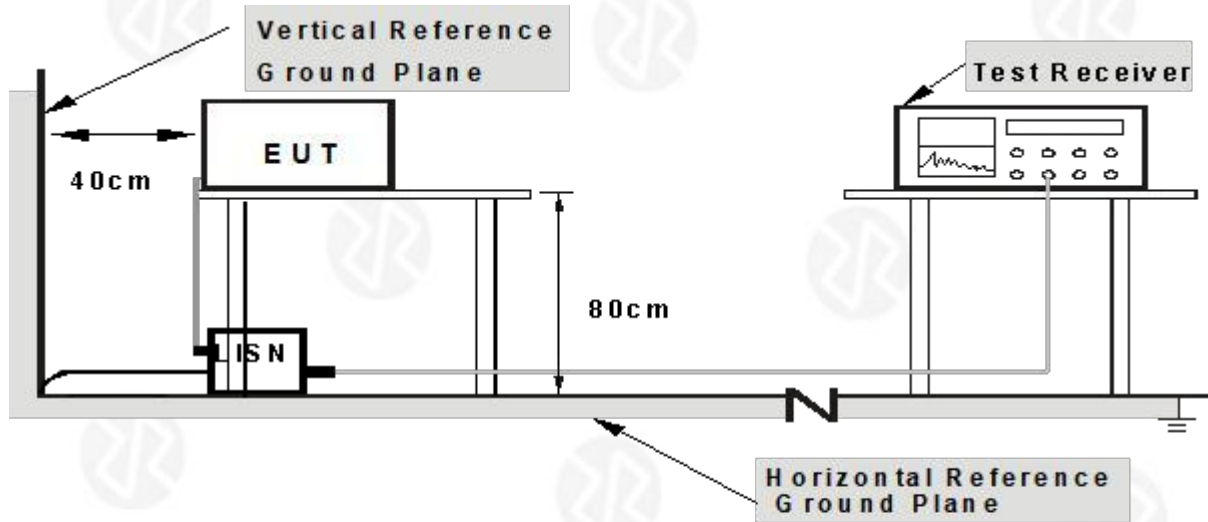

- Note: 1.Support units were connected to second LISN.**
2.Both of LISNs (AMN) are 80 cm from EUT and at least 80 from other units and other metal planes

4.1.5 EUT OPERATING CONDITIONS

The EUT was configured for testing in a typical fashion (as a customer would normally use it). The EUT has been programmed to continuously transmit during test. This operating condition was tested and used to collect the included data.

We pretest AC 120V and AC 230V, the worst voltage was AC 120V and the data recording in the report.



4.1.6 Test Result

| | | | |
|---------------|--------------|--------------------|-----|
| Temperature: | 26°C | Relative Humidity: | 54% |
| Pressure: | 101 kPa | Polarization: | L |
| Test Voltage: | AC 120V/60Hz | | |

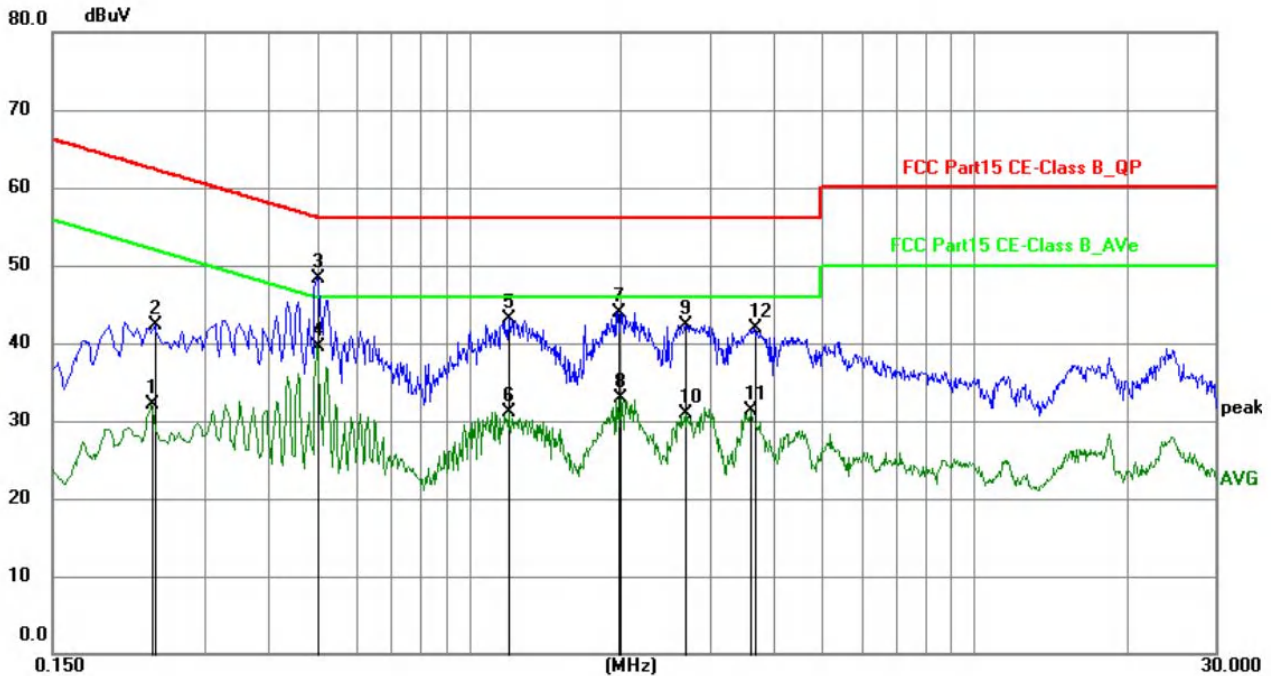

| No. | Frequency (MHz) | Reading (dBuV) | Factor (dB) | Level (dBuV) | Limit (dBuV) | Margin (dB) | Detector | P/F | Remark |
|-----|-----------------|----------------|-------------|--------------|--------------|-------------|----------|-----|--------|
| 1 | 0.2354 | 11.07 | 21.02 | 32.09 | 52.26 | -20.17 | AVG | P | |
| 2 | 0.2400 | 21.25 | 21.02 | 42.27 | 62.10 | -19.83 | QP | P | |
| 3 | 0.5010 | 27.57 | 20.83 | 48.40 | 56.00 | -7.60 | QP | P | |
| 4 | 0.5010 | 18.77 | 20.83 | 39.60 | 46.00 | -6.40 | AVG | P | |
| 5 | 1.1983 | 22.08 | 20.97 | 43.05 | 56.00 | -12.95 | QP | P | |
| 6 | 1.1983 | 10.12 | 20.97 | 31.09 | 46.00 | -14.91 | AVG | P | |
| 7 | 1.9769 | 22.81 | 21.03 | 43.84 | 56.00 | -12.16 | QP | P | |
| 8 | 1.9994 | 11.92 | 21.03 | 32.95 | 46.00 | -13.05 | AVG | P | |
| 9 | 2.6880 | 21.33 | 21.04 | 42.37 | 56.00 | -13.63 | QP | P | |
| 10 | 2.6924 | 9.83 | 21.04 | 30.87 | 46.00 | -15.13 | AVG | P | |
| 11 | 3.6105 | 10.22 | 21.07 | 31.29 | 46.00 | -14.71 | AVG | P | |
| 12 | 3.6779 | 20.87 | 21.07 | 41.94 | 56.00 | -14.06 | QP | P | |

Notes:

1. An initial pre-scan was performed on the line and neutral lines with peak detector.
2. Quasi-Peak and Average measurement were performed at the frequencies with maximized peak emission.
3. Measurement Level = Reading level + Correct Factor
4. The test data shows only the worst case 802.11g 2437MHz



| | | | |
|---------------|--------------|--------------------|-----|
| Temperature: | 26°C | Relative Humidity: | 54% |
| Pressure: | 101 kPa | Polarization: | N |
| Test Voltage: | AC 120V/60Hz | | |

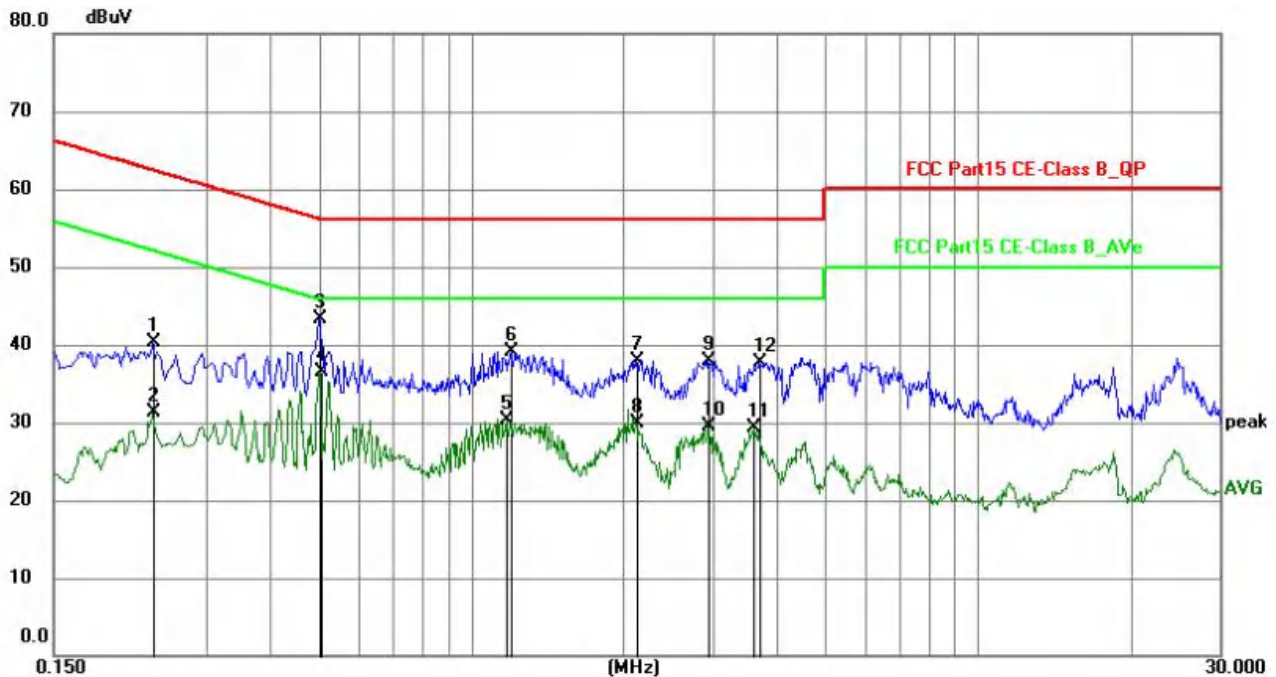

| No. | Frequency (MHz) | Reading (dBuV) | Factor (dB) | Level (dBuV) | Limit (dBuV) | Margin (dB) | Detector | P/F | Remark |
|-----|-----------------|----------------|-------------|--------------|--------------|-------------|----------|-----|--------|
| 1 | 0.2354 | 19.41 | 20.99 | 40.40 | 62.26 | -21.86 | QP | P | |
| 2 | 0.2354 | 10.26 | 20.99 | 31.25 | 52.26 | -21.01 | AVG | P | |
| 3 | 0.5010 | 22.44 | 20.85 | 43.29 | 56.00 | -12.71 | QP | P | |
| 4 | 0.5054 | 15.61 | 20.85 | 36.46 | 46.00 | -9.54 | AVG | P | |
| 5 | 1.1758 | 9.28 | 20.94 | 30.22 | 46.00 | -15.78 | AVG | P | |
| 6 | 1.1983 | 18.20 | 20.94 | 39.14 | 56.00 | -16.86 | QP | P | |
| 7 | 2.1208 | 16.83 | 21.04 | 37.87 | 56.00 | -18.13 | QP | P | |
| 8 | 2.1208 | 8.78 | 21.04 | 29.82 | 46.00 | -16.18 | AVG | P | |
| 9 | 2.9355 | 16.84 | 21.08 | 37.92 | 56.00 | -18.08 | QP | P | |
| 10 | 2.9355 | 8.43 | 21.08 | 29.51 | 46.00 | -16.49 | AVG | P | |
| 11 | 3.6059 | 8.27 | 21.10 | 29.37 | 46.00 | -16.63 | AVG | P | |
| 12 | 3.7004 | 16.62 | 21.10 | 37.72 | 56.00 | -18.28 | QP | P | |

Notes:

1. An initial pre-scan was performed on the line and neutral lines with peak detector.
2. Quasi-Peak and Average measurement were performed at the frequencies with maximized peak emission.
3. Measurement Level = Reading level + Correct Factor
4. The test data shows only the worst case 802.11g 2437MHz



4.2 RADIATED EMISSION MEASUREMENT

| | | | | | |
|-----------------------|-----------------------------|------------|--------|---------|------------|
| Test Requirement: | FCC Part15 C Section 15.209 | | | | |
| Test Method: | ANSI C63.10:2013 | | | | |
| Test Frequency Range: | 9kHz to 25GHz | | | | |
| Test site: | Measurement Distance: 3m | | | | |
| Receiver setup: | Frequency | Detector | RBW | VBW | Value |
| | 9KHz-150KHz | Quasi-peak | 200Hz | 600Hz | Quasi-peak |
| | 150KHz-30MHz | Quasi-peak | 9KHz | 30KHz | Quasi-peak |
| | 30MHz-1GHz | Quasi-peak | 100KHz | 300KHz | Quasi-peak |
| | Above 1GHz | Peak | 1MHz | 3MHz | Peak |
| Peak | | 1MHz | 10Hz | Average | |

4.2.1 RADIATED EMISSION LIMITS

| Frequencies (MHz) | Field Strength (micorvolts/meter) | Measurement Distance (meters) |
|-------------------|-----------------------------------|-------------------------------|
| 0.009~0.490 | 2400/F(KHz) | 300 |
| 0.490~1.705 | 24000/F(KHz) | 30 |
| 1.705~30.0 | 30 | 30 |
| 30~88 | 100 | 3 |
| 88~216 | 150 | 3 |
| 216~960 | 200 | 3 |
| Above 960 | 500 | 3 |

LIMITS OF RADIATED EMISSION MEASUREMENT

| FREQUENCY (MHz) | Limit (dBuV/m) (at 3M) | |
|-----------------|------------------------|---------|
| | PEAK | AVERAGE |
| Above 1000 | 74 | 54 |

Notes:

- (1) The limit for radiated test was performed according to FCC PART 15C.
- (2) The tighter limit applies at the band edges.
- (3) Emission level (dBuV/m)=20log Emission level (uV/m).



4.2.2 TEST PROCEDURE

Below 1GHz test procedure as below:

- The EUT was placed on the top of a rotating table 0.8 meters above the ground at a 3 meter semi-anechoic chamber. The table was rotated 360 degrees to determine the position of the highest radiation.
- The EUT was set 3 meters away from the interference-receiving antenna, which was mounted on the top of a variable-height antenna tower.
- The antenna height is varied from one meter to four meters above the ground to determine the maximum value of the field strength. Both horizontal and vertical polarizations of the antenna are set to make the measurement.
- For each suspected emission, the EUT was arranged to its worst case and then the antenna was tuned to heights from 1 meter to 4 meters (for the test frequency of below 30MHz, the antenna was tuned to heights 1 meter) and the rotatable table was turned from 0 degrees to 360 degrees to find the maximum reading.
- The test-receiver system was set to Peak Detect Function and Specified Bandwidth with Maximum Hold Mode.
- If the emission level of the EUT in peak mode was 10dB lower than the limit specified, then testing could be stopped and the peak values of the EUT would be reported. Otherwise the emissions that did not have 10dB margin would be re-tested one by one using peak, quasi-peak or average method as specified and then reported in a data sheet.

Above 1GHz test procedure as below:

- Different from above is the test site, change from Semi-Anechoic Chamber to fully Anechoic Chamber and change from table 0.8 meter to 1.5 meter (Above 18GHz the distance is 1 meter and table is 1.5 meter).
- Test the EUT in the lowest channel, the middle channel, the Highest channel

Note:

Both horizontal and vertical antenna polarities were tested and performed pretest to three orthogonal axis. The worst case emissions were reported

4.2.3 DEVIATION FROM TEST STANDARD

No deviation

4.2.4 TEST SETUP

(A) Radiated Emission Test-Up Frequency Below 30MHz

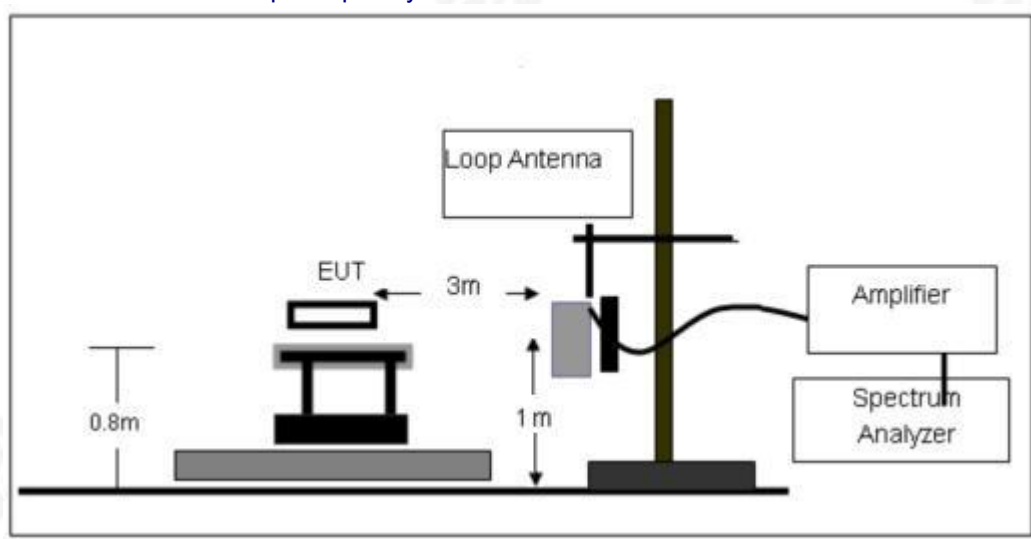



(B) Radiated Emission Test-Up Frequency 30MHz~1GHz

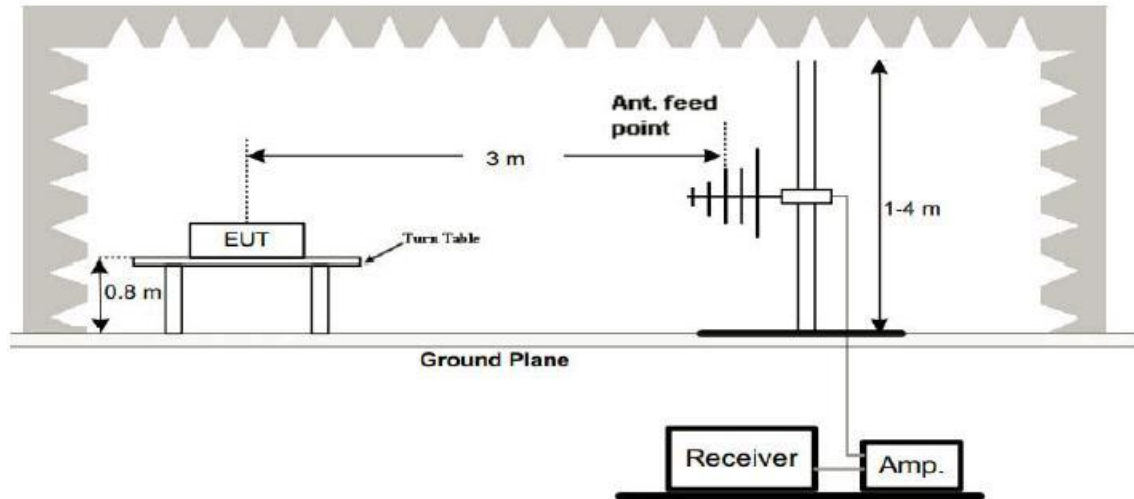

(C) Radiated Emission Test-Up Frequency Above 1GHz

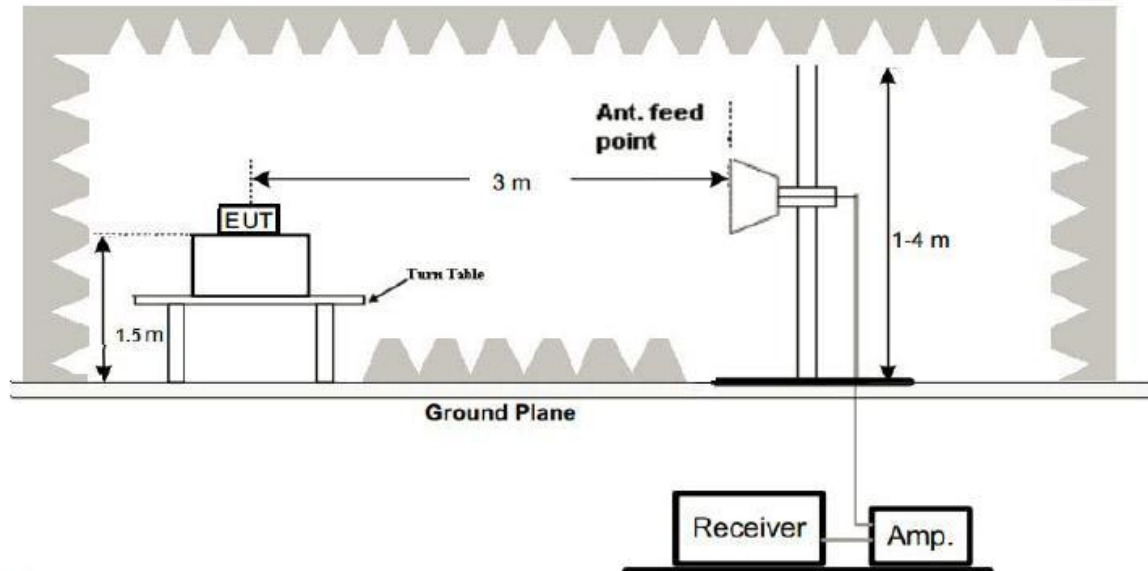

4.2.5 EUT OPERATING CONDITIONS

The EUT tested system was configured as the statements of 2.4 Unless otherwise a special operating condition is specified in the follows during the testing.

4.2.6 TEST RESULTS

Between 9KHz – 30MHz

The emission from 9 kHz to 30MHz was pre-tested and found the result was 20dB lower than the limit, and according to 15.31(o) & RSS-Gen 6.13, the test result no need to reported.



Between 30MHz – 1GHz

| | | | |
|---------------|--------------|--------------------|-----------------|
| Temperature: | 26°C | Relative Humidity: | 54% |
| Pressure: | 101 kPa | Polarization: | Horizontal |
| Test Voltage: | AC 120V/60Hz | Test Mode | 802.11g 2437MHz |

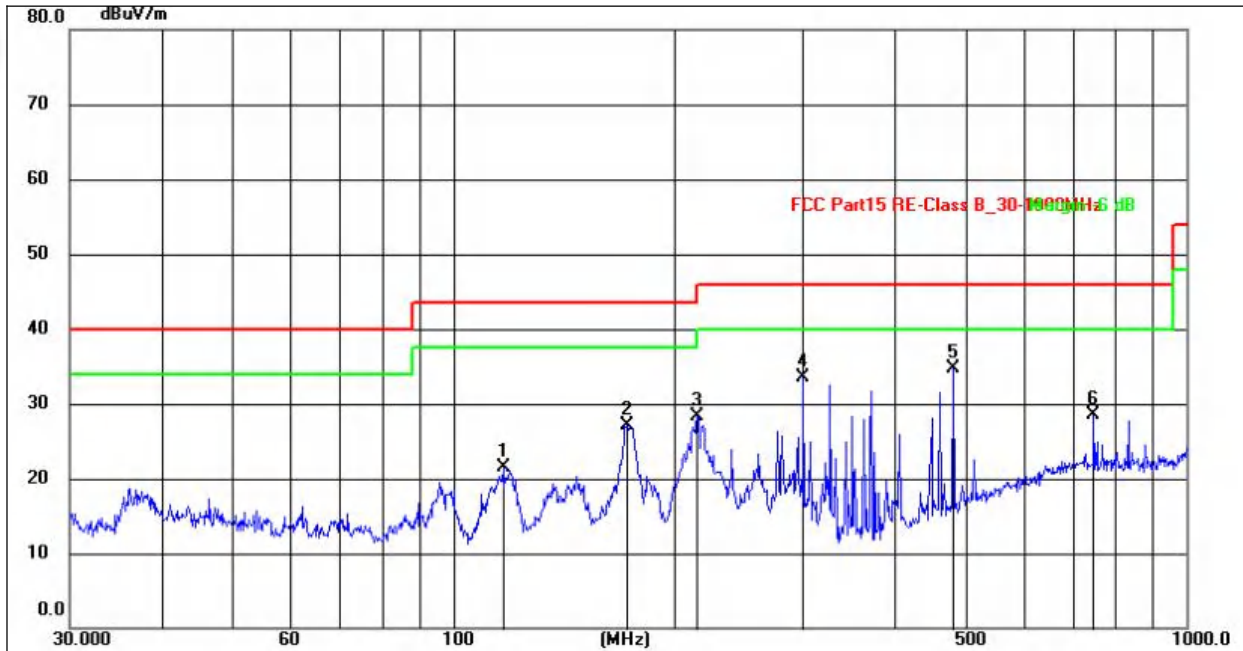

| No. | Frequency (MHz) | Reading (dBuV) | Factor (dB/m) | Level (dBuV/m) | Limit (dBuV/m) | Margin (dB) | Detector |
|-----|-----------------|----------------|---------------|----------------|----------------|-------------|----------|
| 1 | 116.9492 | 40.29 | -18.77 | 21.52 | 43.50 | -21.98 | QP |
| 2 | 172.5987 | 44.41 | -17.23 | 27.18 | 43.50 | -16.32 | QP |
| 3 | 215.2675 | 46.33 | -18.03 | 28.30 | 43.50 | -15.20 | QP |
| 4 | 300.3672 | 50.40 | -16.98 | 33.42 | 46.00 | -12.58 | QP |
| 5 | 480.5276 | 47.22 | -12.58 | 34.64 | 46.00 | -11.36 | QP |
| 6 | 747.4823 | 35.38 | -6.82 | 28.56 | 46.00 | -17.44 | QP |

Remarks:

1. Final Level = Receiver Read level + Antenna Factor + Cable Loss – Pre-amplifier Factor
2. The emission levels of other frequencies are very lower than the limit and not show in test report.
3. The test data shows only the worst case 802.11g 2437MHz



| | | | |
|---------------|--------------|--------------------|-----------------|
| Temperature: | 26°C | Relative Humidity: | 54% |
| Pressure: | 101kPa | Polarization: | Vertical |
| Test Voltage: | AC 120V/60Hz | Test Mode | 802.11g 2437MHz |

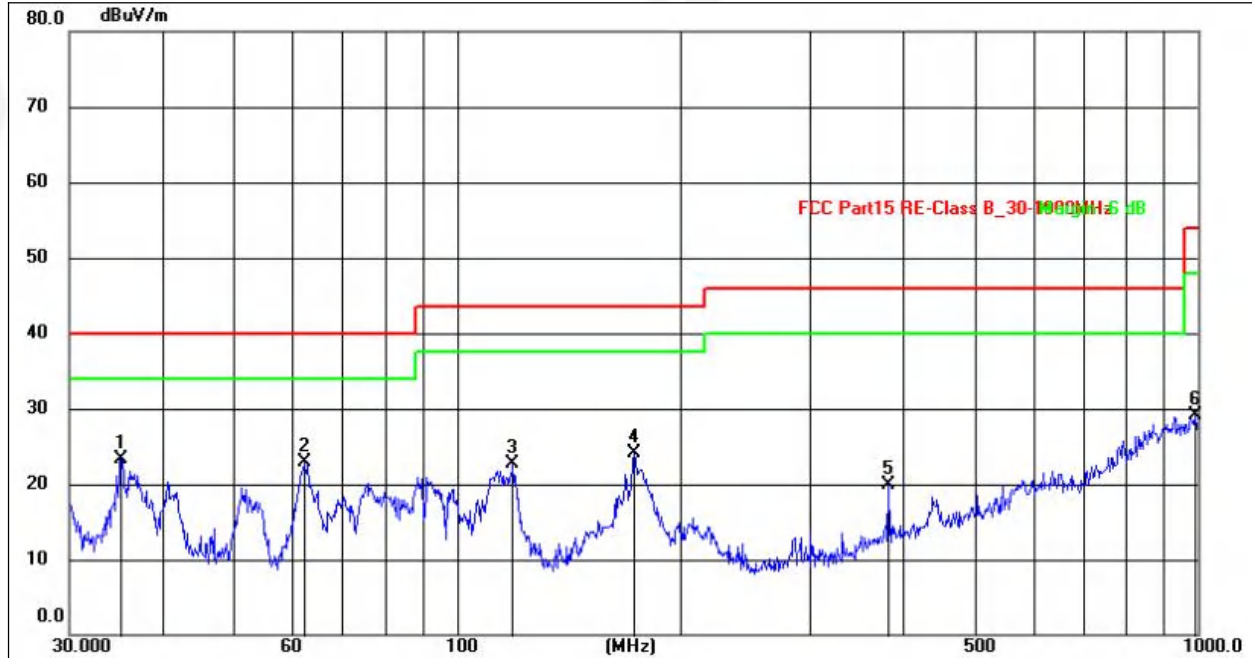

| No. | Frequency (MHz) | Reading (dBuV) | Factor (dB/m) | Level (dBuV/m) | Limit (dBuV/m) | Margin (dB) | Detector |
|-----|-----------------|----------------|---------------|----------------|----------------|-------------|----------|
| 1 | 35.2511 | 40.93 | -17.56 | 23.37 | 40.00 | -16.63 | QP |
| 2 | 62.2128 | 41.53 | -18.54 | 22.99 | 40.00 | -17.01 | QP |
| 3 | 119.0177 | 44.15 | -21.38 | 22.77 | 43.50 | -20.73 | QP |
| 4 | 173.8135 | 44.01 | -19.95 | 24.06 | 43.50 | -19.44 | QP |
| 5 | 382.5878 | 35.51 | -15.61 | 19.90 | 46.00 | -26.10 | QP |
| 6 | 993.0113 | 29.35 | -0.26 | 29.09 | 54.00 | -24.91 | QP |

Remarks:

1. Final Level = Receiver Read level + Antenna Factor + Cable Loss – Preamplifier Factor
2. The emission levels of other frequencies are very lower than the limit and not show in test report.
3. The test data shows only the worst case 802.11g 2437MHz



1GHz~25GHz

802.11b

| Polar (H/V) | Frequency | Meter Reading | Pre-ampl ifier | Cable Loss | Antenna Factor | Emission Level | Limits | Margin | Detect or Type |
|---------------------|-----------|------------------|-------------------|---------------|-------------------|-------------------|--------------|--------|----------------------|
| | (MHz) | (dBuV) | (dB) | (dB) | (dB) | (dBuV/m) | (dBuV/ m) | (dB) | |
| Low Channel:2412MHz | | | | | | | | | |
| V | 4824.00 | 50.66 | 30.55 | 5.77 | 24.66 | 50.54 | 74.00 | -23.46 | PK |
| V | 4824.00 | 43.52 | 30.55 | 5.77 | 24.66 | 43.40 | 54.00 | -10.60 | AV |
| V | 7236.00 | 51.62 | 30.33 | 6.32 | 24.55 | 52.16 | 74.00 | -21.84 | PK |
| V | 7236.00 | 43.49 | 30.33 | 6.32 | 24.55 | 44.03 | 54.00 | -9.97 | AV |
| V | 9648.00 | 54.66 | 30.85 | 7.45 | 24.69 | 55.95 | 74.00 | -18.05 | PK |
| V | 9648.00 | 43.27 | 30.85 | 7.45 | 24.69 | 44.56 | 54.00 | -9.44 | AV |
| V | 12060.00 | 51.39 | 31.02 | 8.99 | 25.57 | 54.93 | 74.00 | -19.07 | PK |
| V | 12060.00 | 43.50 | 31.02 | 8.99 | 25.57 | 47.04 | 54.00 | -6.96 | AV |
| H | 4824.00 | 54.61 | 30.55 | 5.77 | 24.66 | 54.49 | 74.00 | -19.51 | PK |
| H | 4824.00 | 43.78 | 30.55 | 5.77 | 24.66 | 43.66 | 54.00 | -10.34 | AV |
| H | 7236.00 | 53.38 | 30.33 | 6.32 | 24.55 | 53.92 | 74.00 | -20.08 | PK |
| H | 7236.00 | 43.85 | 30.33 | 6.32 | 24.55 | 44.39 | 54.00 | -9.61 | AV |
| H | 9648.00 | 50.55 | 30.85 | 7.45 | 24.69 | 51.84 | 74.00 | -22.16 | PK |
| H | 9648.00 | 43.70 | 30.85 | 7.45 | 24.69 | 44.99 | 54.00 | -9.01 | AV |
| H | 12060.00 | 53.32 | 31.02 | 8.99 | 25.57 | 56.86 | 74.00 | -17.14 | PK |
| H | 12060.00 | 43.67 | 31.02 | 8.99 | 25.57 | 47.21 | 54.00 | -6.79 | AV |

| Polar (H/V) | Frequency | Meter Reading | Pre-ampl ifier | Cable Loss | Antenna Factor | Emission Level | Limits | Margin | Detect or Type |
|------------------------|-----------|------------------|-------------------|---------------|-------------------|-------------------|--------------|--------|----------------------|
| | (MHz) | (dBuV) | (dB) | (dB) | (dB) | (dBuV/m) | (dBuV/ m) | (dB) | |
| Middle Channel:2437MHz | | | | | | | | | |
| V | 4874.00 | 53.70 | 30.55 | 5.77 | 24.66 | 53.58 | 74.00 | -20.42 | PK |
| V | 4874.00 | 43.89 | 30.55 | 5.77 | 24.66 | 43.77 | 54.00 | -10.23 | AV |
| V | 7311.00 | 54.05 | 30.33 | 6.32 | 24.55 | 54.59 | 74.00 | -19.41 | PK |
| V | 7311.00 | 43.81 | 30.33 | 6.32 | 24.55 | 44.35 | 54.00 | -9.65 | AV |
| V | 9748.00 | 54.54 | 30.85 | 7.45 | 24.69 | 55.83 | 74.00 | -18.17 | PK |
| V | 9748.00 | 43.12 | 30.85 | 7.45 | 24.69 | 44.41 | 54.00 | -9.59 | AV |
| V | 12185.00 | 53.77 | 31.02 | 8.99 | 25.57 | 57.31 | 74.00 | -16.69 | PK |
| V | 12185.00 | 43.84 | 31.02 | 8.99 | 25.57 | 47.38 | 54.00 | -6.62 | AV |
| H | 4874.00 | 53.77 | 30.55 | 5.77 | 24.66 | 53.65 | 74.00 | -20.35 | PK |
| H | 4874.00 | 43.08 | 30.55 | 5.77 | 24.66 | 42.96 | 54.00 | -11.04 | AV |
| H | 7311.00 | 54.80 | 30.33 | 6.32 | 24.55 | 55.34 | 74.00 | -18.66 | PK |
| H | 7311.00 | 43.85 | 30.33 | 6.32 | 24.55 | 44.39 | 54.00 | -9.61 | AV |
| H | 9748.00 | 53.80 | 30.85 | 7.45 | 24.69 | 55.09 | 74.00 | -18.91 | PK |
| H | 9748.00 | 43.09 | 30.85 | 7.45 | 24.69 | 44.38 | 54.00 | -9.62 | AV |
| H | 12185.00 | 52.14 | 31.02 | 8.99 | 25.57 | 55.68 | 74.00 | -18.32 | PK |
| H | 12185.00 | 43.78 | 31.02 | 8.99 | 25.57 | 47.32 | 54.00 | -6.68 | AV |



| Polar (H/V) | Frequency | Meter Reading | Pre-ampli fier | Cable Loss | Antenna Factor | Emission Level | Limits | Margin | Detect or Type |
|----------------------|-----------|------------------|-------------------|---------------|-------------------|-------------------|--------------|--------|----------------------|
| | (MHz) | (dBuV) | (dB) | (dB) | (dB) | (dBuV/m) | (dBuV/ m) | (dB) | |
| High Channel:2462MHz | | | | | | | | | |
| V | 4924.00 | 52.57 | 30.55 | 5.77 | 24.66 | 52.45 | 74.00 | -21.55 | PK |
| V | 4924.00 | 43.40 | 30.55 | 5.77 | 24.66 | 43.28 | 54.00 | -10.72 | AV |
| V | 7386.00 | 54.79 | 30.33 | 6.32 | 24.55 | 55.33 | 74.00 | -18.67 | PK |
| V | 7386.00 | 44.00 | 30.33 | 6.32 | 24.55 | 44.54 | 54.00 | -9.46 | AV |
| V | 9848.00 | 52.70 | 30.85 | 7.45 | 24.69 | 53.99 | 74.00 | -20.01 | PK |
| V | 9848.00 | 43.56 | 30.85 | 7.45 | 24.69 | 44.85 | 54.00 | -9.15 | AV |
| V | 12310.00 | 50.37 | 31.02 | 8.99 | 25.57 | 53.91 | 74.00 | -20.09 | PK |
| V | 12310.00 | 43.60 | 31.02 | 8.99 | 25.57 | 47.14 | 54.00 | -6.86 | AV |
| H | 4924.00 | 54.88 | 30.55 | 5.77 | 24.66 | 54.76 | 74.00 | -19.24 | PK |
| H | 4924.00 | 43.74 | 30.55 | 5.77 | 24.66 | 43.62 | 54.00 | -10.38 | AV |
| H | 7386.00 | 50.06 | 30.33 | 6.32 | 24.55 | 50.60 | 74.00 | -23.40 | PK |
| H | 7386.00 | 43.09 | 30.33 | 6.32 | 24.55 | 43.63 | 54.00 | -10.37 | AV |
| H | 9848.00 | 54.86 | 30.85 | 7.45 | 24.69 | 56.15 | 74.00 | -17.85 | PK |
| H | 9848.00 | 43.38 | 30.85 | 7.45 | 24.69 | 44.67 | 54.00 | -9.33 | AV |
| H | 12310.00 | 52.22 | 31.02 | 8.99 | 25.57 | 55.76 | 74.00 | -18.24 | PK |
| H | 12310.00 | 43.50 | 31.02 | 8.99 | 25.57 | 47.04 | 54.00 | -6.96 | AV |

Remark:

1. Emission Level = Meter Reading + Antenna Factor + Cable Loss – Pre-amplifier,
Margin= Emission Level - Limit
2. If peak below the average limit, the average emission was no test.
3. The amplitude of spurious emissions which are attenuated by more than 20dB below the permissible value has no need to be reported.



802.11g

| Polar (H/V) | Frequency | Meter Reading | Pre-amplifier | Cable Loss | Antenna Factor | Emission Level | Limits | Margin | Detect or Type |
|---------------------|-----------|------------------|---------------|---------------|-------------------|-------------------|----------|--------|----------------------|
| | (MHz) | (dBuV) | (dB) | (dB) | (dB) | (dBuV/m) | (dBuV/m) | (dB) | |
| Low Channel:2412MHz | | | | | | | | | |
| V | 4824.00 | 50.43 | 30.55 | 5.77 | 24.66 | 50.31 | 74.00 | -23.69 | PK |
| V | 4824.00 | 43.64 | 30.55 | 5.77 | 24.66 | 43.52 | 54.00 | -10.48 | AV |
| V | 7236.00 | 54.54 | 30.33 | 6.32 | 24.55 | 55.08 | 74.00 | -18.92 | PK |
| V | 7236.00 | 43.81 | 30.33 | 6.32 | 24.55 | 44.35 | 54.00 | -9.65 | AV |
| V | 9648.00 | 53.62 | 30.85 | 7.45 | 24.69 | 54.91 | 74.00 | -19.09 | PK |
| V | 9648.00 | 43.67 | 30.85 | 7.45 | 24.69 | 44.96 | 54.00 | -9.04 | AV |
| V | 12060.00 | 53.65 | 31.02 | 8.99 | 25.57 | 57.19 | 74.00 | -16.81 | PK |
| V | 12060.00 | 43.13 | 31.02 | 8.99 | 25.57 | 46.67 | 54.00 | -7.33 | AV |
| H | 4824.00 | 50.45 | 30.55 | 5.77 | 24.66 | 50.33 | 74.00 | -23.67 | PK |
| H | 4824.00 | 43.40 | 30.55 | 5.77 | 24.66 | 43.28 | 54.00 | -10.72 | AV |
| H | 7236.00 | 52.46 | 30.33 | 6.32 | 24.55 | 53.00 | 74.00 | -21.00 | PK |
| H | 7236.00 | 43.44 | 30.33 | 6.32 | 24.55 | 43.98 | 54.00 | -10.02 | AV |
| H | 9648.00 | 51.92 | 30.85 | 7.45 | 24.69 | 53.21 | 74.00 | -20.79 | PK |
| H | 9648.00 | 43.06 | 30.85 | 7.45 | 24.69 | 44.35 | 54.00 | -9.65 | AV |
| H | 12060.00 | 51.95 | 31.02 | 8.99 | 25.57 | 55.49 | 74.00 | -18.51 | PK |
| H | 12060.00 | 43.00 | 31.02 | 8.99 | 25.57 | 46.54 | 54.00 | -7.46 | AV |

| Polar (H/V) | Frequency | Meter Reading | Pre-amplifier | Cable Loss | Antenna Factor | Emission Level | Limits | Margin | Detect or Type |
|------------------------|-----------|------------------|---------------|---------------|-------------------|-------------------|----------|--------|----------------------|
| | (MHz) | (dBuV) | (dB) | (dB) | (dB) | (dBuV/m) | (dBuV/m) | (dB) | |
| Middle Channel:2437MHz | | | | | | | | | |
| V | 4874.00 | 51.47 | 30.55 | 5.77 | 24.66 | 51.35 | 74.00 | -22.65 | PK |
| V | 4874.00 | 43.78 | 30.55 | 5.77 | 24.66 | 43.66 | 54.00 | -10.34 | AV |
| V | 7311.00 | 50.36 | 30.33 | 6.32 | 24.55 | 50.90 | 74.00 | -23.10 | PK |
| V | 7311.00 | 43.29 | 30.33 | 6.32 | 24.55 | 43.83 | 54.00 | -10.17 | AV |
| V | 9748.00 | 51.64 | 30.85 | 7.45 | 24.69 | 52.93 | 74.00 | -21.07 | PK |
| V | 9748.00 | 43.60 | 30.85 | 7.45 | 24.69 | 44.89 | 54.00 | -9.11 | AV |
| V | 12185.00 | 52.70 | 31.02 | 8.99 | 25.57 | 56.24 | 74.00 | -17.76 | PK |
| V | 12185.00 | 43.82 | 31.02 | 8.99 | 25.57 | 47.36 | 54.00 | -6.64 | AV |
| H | 4874.00 | 53.78 | 30.55 | 5.77 | 24.66 | 53.66 | 74.00 | -20.34 | PK |
| H | 4874.00 | 43.83 | 30.55 | 5.77 | 24.66 | 43.71 | 54.00 | -10.29 | AV |
| H | 7311.00 | 54.80 | 30.33 | 6.32 | 24.55 | 55.34 | 74.00 | -18.66 | PK |
| H | 7311.00 | 43.63 | 30.33 | 6.32 | 24.55 | 44.17 | 54.00 | -9.83 | AV |
| H | 9748.00 | 52.92 | 30.85 | 7.45 | 24.69 | 54.21 | 74.00 | -19.79 | PK |
| H | 9748.00 | 43.31 | 30.85 | 7.45 | 24.69 | 44.60 | 54.00 | -9.40 | AV |
| H | 12185.00 | 53.05 | 31.02 | 8.99 | 25.57 | 56.59 | 74.00 | -17.41 | PK |
| H | 12185.00 | 43.15 | 31.02 | 8.99 | 25.57 | 46.69 | 54.00 | -7.31 | AV |



| Polar (H/V) | Frequency | Meter Reading | Pre-ampl ifier | Cable Loss | Antenna Factor | Emission Level | Limits | Margin | Detect or Type |
|----------------------|-----------|------------------|-------------------|---------------|-------------------|-------------------|--------------|--------|----------------------|
| | (MHz) | (dBuV) | (dB) | (dB) | (dB) | (dBuV/m) | (dBuV/ m) | (dB) | |
| High Channel:2462MHz | | | | | | | | | |
| V | 4924.00 | 53.62 | 30.55 | 5.77 | 24.66 | 53.50 | 74.00 | -20.50 | PK |
| V | 4924.00 | 43.82 | 30.55 | 5.77 | 24.66 | 43.70 | 54.00 | -10.30 | AV |
| V | 7386.00 | 50.19 | 30.33 | 6.32 | 24.55 | 50.73 | 74.00 | -23.27 | PK |
| V | 7386.00 | 43.09 | 30.33 | 6.32 | 24.55 | 43.63 | 54.00 | -10.37 | AV |
| V | 9848.00 | 53.09 | 30.85 | 7.45 | 24.69 | 54.38 | 74.00 | -19.62 | PK |
| V | 9848.00 | 43.54 | 30.85 | 7.45 | 24.69 | 44.83 | 54.00 | -9.17 | AV |
| V | 12310.00 | 51.35 | 31.02 | 8.99 | 25.57 | 54.89 | 74.00 | -19.11 | PK |
| V | 12310.00 | 43.89 | 31.02 | 8.99 | 25.57 | 47.43 | 54.00 | -6.57 | AV |
| H | 4924.00 | 53.06 | 30.55 | 5.77 | 24.66 | 52.94 | 74.00 | -21.06 | PK |
| H | 4924.00 | 43.28 | 30.55 | 5.77 | 24.66 | 43.16 | 54.00 | -10.84 | AV |
| H | 7386.00 | 53.28 | 30.33 | 6.32 | 24.55 | 53.82 | 74.00 | -20.18 | PK |
| H | 7386.00 | 43.81 | 30.33 | 6.32 | 24.55 | 44.35 | 54.00 | -9.65 | AV |
| H | 9848.00 | 54.67 | 30.85 | 7.45 | 24.69 | 55.96 | 74.00 | -18.04 | PK |
| H | 9848.00 | 43.93 | 30.85 | 7.45 | 24.69 | 45.22 | 54.00 | -8.78 | AV |
| H | 12310.00 | 53.07 | 31.02 | 8.99 | 25.57 | 56.61 | 74.00 | -17.39 | PK |
| H | 12310.00 | 43.38 | 31.02 | 8.99 | 25.57 | 46.92 | 54.00 | -7.08 | AV |

Remark:

1. Emission Level = Meter Reading + Antenna Factor + Cable Loss – Pre-amplifier,
Margin= Emission Level - Limit
2. If peak below the average limit, the average emission was no test.
3. The amplitude of spurious emissions which are attenuated by more than 20dB below the permissible value has no need to be reported.



802.11n20

| Polar (H/V) | Frequency | Meter Reading | Pre-ampl ifier | Cable Loss | Antenna Factor | Emission Level | Limits | Margin | Detect or Type |
|---------------------|-----------|------------------|-------------------|---------------|-------------------|-------------------|--------------|--------|----------------------|
| | (MHz) | (dBuV) | (dB) | (dB) | (dB) | (dBuV/m) | (dBuV/ m) | (dB) | |
| Low Channel:2412MHz | | | | | | | | | |
| V | 4824.00 | 50.84 | 30.55 | 5.77 | 24.66 | 50.72 | 74.00 | -23.28 | PK |
| V | 4824.00 | 43.36 | 30.55 | 5.77 | 24.66 | 43.24 | 54.00 | -10.76 | AV |
| V | 7236.00 | 54.18 | 30.33 | 6.32 | 24.55 | 54.72 | 74.00 | -19.28 | PK |
| V | 7236.00 | 43.99 | 30.33 | 6.32 | 24.55 | 44.53 | 54.00 | -9.47 | AV |
| V | 9648.00 | 53.15 | 30.85 | 7.45 | 24.69 | 54.44 | 74.00 | -19.56 | PK |
| V | 9648.00 | 43.20 | 30.85 | 7.45 | 24.69 | 44.49 | 54.00 | -9.51 | AV |
| V | 12060.00 | 51.52 | 31.02 | 8.99 | 25.57 | 55.06 | 74.00 | -18.94 | PK |
| V | 12060.00 | 43.08 | 31.02 | 8.99 | 25.57 | 46.62 | 54.00 | -7.38 | AV |
| H | 4824.00 | 53.84 | 30.55 | 5.77 | 24.66 | 53.72 | 74.00 | -20.28 | PK |
| H | 4824.00 | 43.24 | 30.55 | 5.77 | 24.66 | 43.12 | 54.00 | -10.88 | AV |
| H | 7236.00 | 54.75 | 30.33 | 6.32 | 24.55 | 55.29 | 74.00 | -18.71 | PK |
| H | 7236.00 | 43.65 | 30.33 | 6.32 | 24.55 | 44.19 | 54.00 | -9.81 | AV |
| H | 9648.00 | 54.65 | 30.85 | 7.45 | 24.69 | 55.94 | 74.00 | -18.06 | PK |
| H | 9648.00 | 43.68 | 30.85 | 7.45 | 24.69 | 44.97 | 54.00 | -9.03 | AV |
| H | 12060.00 | 54.17 | 31.02 | 8.99 | 25.57 | 57.71 | 74.00 | -16.29 | PK |
| H | 12060.00 | 43.82 | 31.02 | 8.99 | 25.57 | 47.36 | 54.00 | -6.64 | AV |

| Polar (H/V) | Frequency | Meter Reading | Pre-ampl ifier | Cable Loss | Antenna Factor | Emission Level | Limits | Margin | Detect or Type |
|------------------------|-----------|------------------|-------------------|---------------|-------------------|-------------------|--------------|--------|----------------------|
| | (MHz) | (dBuV) | (dB) | (dB) | (dB) | (dBuV/m) | (dBuV/ m) | (dB) | |
| Middle Channel:2437MHz | | | | | | | | | |
| V | 4874.00 | 50.90 | 30.55 | 5.77 | 24.66 | 50.78 | 74.00 | -23.22 | PK |
| V | 4874.00 | 43.02 | 30.55 | 5.77 | 24.66 | 42.90 | 54.00 | -11.10 | AV |
| V | 7311.00 | 53.07 | 30.33 | 6.32 | 24.55 | 53.61 | 74.00 | -20.39 | PK |
| V | 7311.00 | 43.83 | 30.33 | 6.32 | 24.55 | 44.37 | 54.00 | -9.63 | AV |
| V | 9748.00 | 52.52 | 30.85 | 7.45 | 24.69 | 53.81 | 74.00 | -20.19 | PK |
| V | 9748.00 | 43.91 | 30.85 | 7.45 | 24.69 | 45.20 | 54.00 | -8.80 | AV |
| V | 12185.00 | 54.98 | 31.02 | 8.99 | 25.57 | 58.52 | 74.00 | -15.48 | PK |
| V | 12185.00 | 43.15 | 31.02 | 8.99 | 25.57 | 46.69 | 54.00 | -7.31 | AV |
| H | 4874.00 | 51.95 | 30.55 | 5.77 | 24.66 | 51.83 | 74.00 | -22.17 | PK |
| H | 4874.00 | 43.48 | 30.55 | 5.77 | 24.66 | 43.36 | 54.00 | -10.64 | AV |
| H | 7311.00 | 52.68 | 30.33 | 6.32 | 24.55 | 53.22 | 74.00 | -20.78 | PK |
| H | 7311.00 | 43.62 | 30.33 | 6.32 | 24.55 | 44.16 | 54.00 | -9.84 | AV |
| H | 9748.00 | 50.11 | 30.85 | 7.45 | 24.69 | 51.40 | 74.00 | -22.60 | PK |
| H | 9748.00 | 43.34 | 30.85 | 7.45 | 24.69 | 44.63 | 54.00 | -9.37 | AV |
| H | 12185.00 | 54.47 | 31.02 | 8.99 | 25.57 | 58.01 | 74.00 | -15.99 | PK |
| H | 12185.00 | 43.47 | 31.02 | 8.99 | 25.57 | 47.01 | 54.00 | -6.99 | AV |



| Polar (H/V) | Frequency | Meter Reading | Pre-ampl ifier | Cable Loss | Antenna Factor | Emission Level | Limits | Margin | Detect or Type |
|----------------------|-----------|------------------|-------------------|---------------|-------------------|-------------------|--------------|--------|----------------------|
| | (MHz) | (dBuV) | (dB) | (dB) | (dB) | (dBuV/m) | (dBuV/ m) | (dB) | |
| High Channel:2462MHz | | | | | | | | | |
| V | 4924.00 | 54.23 | 30.55 | 5.77 | 24.66 | 54.11 | 74.00 | -19.89 | PK |
| V | 4924.00 | 43.22 | 30.55 | 5.77 | 24.66 | 43.10 | 54.00 | -10.90 | AV |
| V | 7386.00 | 54.59 | 30.33 | 6.32 | 24.55 | 55.13 | 74.00 | -18.87 | PK |
| V | 7386.00 | 43.74 | 30.33 | 6.32 | 24.55 | 44.28 | 54.00 | -9.72 | AV |
| V | 9848.00 | 52.44 | 30.85 | 7.45 | 24.69 | 53.73 | 74.00 | -20.27 | PK |
| V | 9848.00 | 43.34 | 30.85 | 7.45 | 24.69 | 44.63 | 54.00 | -9.37 | AV |
| V | 12310.00 | 50.92 | 31.02 | 8.99 | 25.57 | 54.46 | 74.00 | -19.54 | PK |
| V | 12310.00 | 43.01 | 31.02 | 8.99 | 25.57 | 46.55 | 54.00 | -7.45 | AV |
| H | 4924.00 | 52.82 | 30.55 | 5.77 | 24.66 | 52.70 | 74.00 | -21.30 | PK |
| H | 4924.00 | 43.81 | 30.55 | 5.77 | 24.66 | 43.69 | 54.00 | -10.31 | AV |
| H | 7386.00 | 50.48 | 30.33 | 6.32 | 24.55 | 51.02 | 74.00 | -22.98 | PK |
| H | 7386.00 | 43.05 | 30.33 | 6.32 | 24.55 | 43.59 | 54.00 | -10.41 | AV |
| H | 9848.00 | 54.71 | 30.85 | 7.45 | 24.69 | 56.00 | 74.00 | -18.00 | PK |
| H | 9848.00 | 43.35 | 30.85 | 7.45 | 24.69 | 44.64 | 54.00 | -9.36 | AV |
| H | 12310.00 | 51.16 | 31.02 | 8.99 | 25.57 | 54.70 | 74.00 | -19.30 | PK |
| H | 12310.00 | 43.39 | 31.02 | 8.99 | 25.57 | 46.93 | 54.00 | -7.07 | AV |

Remark:

1. Emission Level = Meter Reading + Antenna Factor + Cable Loss – Pre-amplifier,
Margin= Emission Level - Limit
2. If peak below the average limit, the average emission was no test.
3. The amplitude of spurious emissions which are attenuated by more than 20dB below the permissible value has no need to be reported.



802.11n40

| Polar (H/V) | Frequency | Meter Reading | Pre-ampli fier | Cable Loss | Antenna Factor | Emission Level | Limits | Margin | Detect or Type |
|---------------------|-----------|------------------|-------------------|---------------|-------------------|-------------------|--------------|--------|----------------------|
| | (MHz) | (dBuV) | (dB) | (dB) | (dB) | (dBuV/m) | (dBuV/ m) | (dB) | |
| Low Channel:2422MHz | | | | | | | | | |
| V | 4844.00 | 53.71 | 30.55 | 5.77 | 24.66 | 53.59 | 74.00 | -20.41 | PK |
| V | 4844.00 | 43.91 | 30.55 | 5.77 | 24.66 | 43.79 | 54.00 | -10.21 | AV |
| V | 7266.00 | 52.81 | 30.33 | 6.32 | 24.55 | 53.35 | 74.00 | -20.65 | PK |
| V | 7266.00 | 43.56 | 30.33 | 6.32 | 24.55 | 44.10 | 54.00 | -9.90 | AV |
| V | 9688.00 | 53.15 | 30.85 | 7.45 | 24.69 | 54.44 | 74.00 | -19.56 | PK |
| V | 9688.00 | 43.65 | 30.85 | 7.45 | 24.69 | 44.94 | 54.00 | -9.06 | AV |
| V | 12110.00 | 50.00 | 31.02 | 8.99 | 25.57 | 53.54 | 74.00 | -20.46 | PK |
| V | 12110.00 | 43.79 | 31.02 | 8.99 | 25.57 | 47.33 | 54.00 | -6.67 | AV |
| H | 4844.00 | 53.78 | 30.55 | 5.77 | 24.66 | 53.66 | 74.00 | -20.34 | PK |
| H | 4844.00 | 43.86 | 30.55 | 5.77 | 24.66 | 43.74 | 54.00 | -10.26 | AV |
| H | 7266.00 | 51.88 | 30.33 | 6.32 | 24.55 | 52.42 | 74.00 | -21.58 | PK |
| H | 7266.00 | 43.95 | 30.33 | 6.32 | 24.55 | 44.49 | 54.00 | -9.51 | AV |
| H | 9688.00 | 51.56 | 30.85 | 7.45 | 24.69 | 52.85 | 74.00 | -21.15 | PK |
| H | 9688.00 | 43.99 | 30.85 | 7.45 | 24.69 | 45.28 | 54.00 | -8.72 | AV |
| H | 12110.00 | 51.01 | 31.02 | 8.99 | 25.57 | 54.55 | 74.00 | -19.45 | PK |
| H | 12110.00 | 43.29 | 31.02 | 8.99 | 25.57 | 46.83 | 54.00 | -7.17 | AV |

| Polar (H/V) | Frequency | Meter Reading | Pre-ampli fier | Cable Loss | Antenna Factor | Emission Level | Limits | Margin | Detect or Type |
|------------------------|-----------|------------------|-------------------|---------------|-------------------|-------------------|--------------|--------|----------------------|
| | (MHz) | (dBuV) | (dB) | (dB) | (dB) | (dBuV/m) | (dBuV/ m) | (dB) | |
| Middle Channel:2437MHz | | | | | | | | | |
| V | 4874.00 | 54.39 | 30.55 | 5.77 | 24.66 | 54.27 | 74.00 | -19.73 | PK |
| V | 4874.00 | 43.75 | 30.55 | 5.77 | 24.66 | 43.63 | 54.00 | -10.37 | AV |
| V | 7311.00 | 50.22 | 30.33 | 6.32 | 24.55 | 50.76 | 74.00 | -23.24 | PK |
| V | 7311.00 | 43.61 | 30.33 | 6.32 | 24.55 | 44.15 | 54.00 | -9.85 | AV |
| V | 9748.00 | 50.81 | 30.85 | 7.45 | 24.69 | 52.10 | 74.00 | -21.90 | PK |
| V | 9748.00 | 43.13 | 30.85 | 7.45 | 24.69 | 44.42 | 54.00 | -9.58 | AV |
| V | 12185.00 | 52.00 | 31.02 | 8.99 | 25.57 | 55.54 | 74.00 | -18.46 | PK |
| V | 12185.00 | 43.30 | 31.02 | 8.99 | 25.57 | 46.84 | 54.00 | -7.16 | AV |
| H | 4874.00 | 53.50 | 30.55 | 5.77 | 24.66 | 53.38 | 74.00 | -20.62 | PK |
| H | 4874.00 | 43.84 | 30.55 | 5.77 | 24.66 | 43.72 | 54.00 | -10.28 | AV |
| H | 7311.00 | 53.89 | 30.33 | 6.32 | 24.55 | 54.43 | 74.00 | -19.57 | PK |
| H | 7311.00 | 43.45 | 30.33 | 6.32 | 24.55 | 43.99 | 54.00 | -10.01 | AV |
| H | 9748.00 | 52.20 | 30.85 | 7.45 | 24.69 | 53.49 | 74.00 | -20.51 | PK |
| H | 9748.00 | 43.26 | 30.85 | 7.45 | 24.69 | 44.55 | 54.00 | -9.45 | AV |
| H | 12185.00 | 53.37 | 31.02 | 8.99 | 25.57 | 56.91 | 74.00 | -17.09 | PK |
| H | 12185.00 | 43.39 | 31.02 | 8.99 | 25.57 | 46.93 | 54.00 | -7.07 | AV |



| Polar (H/V) | Frequency | Meter Reading | Pre-amp lifier | Cable Loss | Antenna Factor | Emission Level | Limits | Margin | Detect or Type |
|----------------------|-----------|------------------|-------------------|---------------|-------------------|-------------------|--------------|--------|----------------------|
| | (MHz) | (dBuV) | (dB) | (dB) | (dB) | (dBuV/m) | (dBuV/ m) | (dB) | |
| High Channel:2452MHz | | | | | | | | | |
| V | 4904.00 | 52.07 | 30.55 | 5.77 | 24.66 | 51.95 | 74.00 | -22.05 | PK |
| V | 4904.00 | 43.94 | 30.55 | 5.77 | 24.66 | 43.82 | 54.00 | -10.18 | AV |
| V | 7356.00 | 50.31 | 30.33 | 6.32 | 24.55 | 50.85 | 74.00 | -23.15 | PK |
| V | 7356.00 | 43.77 | 30.33 | 6.32 | 24.55 | 44.31 | 54.00 | -9.69 | AV |
| V | 9808.00 | 51.96 | 30.85 | 7.45 | 24.69 | 53.25 | 74.00 | -20.75 | PK |
| V | 9808.00 | 43.41 | 30.85 | 7.45 | 24.69 | 44.70 | 54.00 | -9.30 | AV |
| V | 12260.00 | 53.39 | 31.02 | 8.99 | 25.57 | 56.93 | 74.00 | -17.07 | PK |
| V | 12260.00 | 43.66 | 31.02 | 8.99 | 25.57 | 47.20 | 54.00 | -6.80 | AV |
| H | 4904.00 | 53.61 | 30.55 | 5.77 | 24.66 | 53.49 | 74.00 | -20.51 | PK |
| H | 4904.00 | 43.80 | 30.55 | 5.77 | 24.66 | 43.68 | 54.00 | -10.32 | AV |
| H | 7356.00 | 50.18 | 30.33 | 6.32 | 24.55 | 50.72 | 74.00 | -23.28 | PK |
| H | 7356.00 | 43.73 | 30.33 | 6.32 | 24.55 | 44.27 | 54.00 | -9.73 | AV |
| H | 9808.00 | 53.23 | 30.85 | 7.45 | 24.69 | 54.52 | 74.00 | -19.48 | PK |
| H | 9808.00 | 43.60 | 30.85 | 7.45 | 24.69 | 44.89 | 54.00 | -9.11 | AV |
| H | 12260.00 | 53.45 | 31.02 | 8.99 | 25.57 | 56.99 | 74.00 | -17.01 | PK |
| H | 12260.00 | 43.48 | 31.02 | 8.99 | 25.57 | 47.02 | 54.00 | -6.98 | AV |

Remark:

1. Emission Level = Meter Reading + Antenna Factor + Cable Loss – Pre-amplifier,
Margin= Emission Level - Limit
2. If peak below the average limit, the average emission was no test.
3. The amplitude of spurious emissions which are attenuated by more than 20dB below the permissible value has no need to be reported.



5. RADIATED BAND EMISSION MEASUREMENT

5.1 TEST REQUIREMENT:

| | | | | | |
|-----------------------|--|----------|------|------|---------|
| Test Requirement: | FCC Part15 C Section 15.209 and 15.205 | | | | |
| Test Method: | ANSI C63.10: 2013 | | | | |
| Test Frequency Range: | All of the restrict bands were tested, only the worst band's (2310MHz to 2500MHz) data was showed. | | | | |
| Test site: | Measurement Distance: 3m | | | | |
| Receiver setup: | Frequency | Detector | RBW | VBW | Value |
| | Above 1GHz | Peak | 1MHz | 3MHz | Peak |
| | | Average | 1MHz | 3MHz | Average |

LIMITS OF RADIATED EMISSION MEASUREMENT (Above 1000MHz)

| FREQUENCY (MHz) | Class B (dBuV/m) (at 3M) | |
|-----------------|--------------------------|---------|
| | PEAK | AVERAGE |
| Above 1000 | 74 | 54 |

Notes:

- (1) The limit for radiated test was performed according to FCC PART 15C.
- (2) The tighter limit applies at the band edges.
- (3) Emission level (dBuV/m)=20log Emission level (uV/m).

5.2 TEST PROCEDURE

Above 1GHz test procedure as below:

- a. 1. The EUT was placed on the top of a rotating table 1.5 meters above the ground at a 3 meter camber. The table was rotated 360 degrees to determine the position of the highest radiation.
- b. The EUT was set 3 meters away from the interference-receiving antenna, which was mounted on the top of a variable-height antenna tower.
- c. The antenna height is varied from one meter to four meters above the ground to determine the maximum value of the field strength. Both horizontal and vertical polarizations of the antenna are set to make the measurement.
- d. For each suspected emission, the EUT was arranged to its worst case and then the antenna was tuned to heights from 1 meter to 4 meters and the rota table was turned from 0 degrees to 360 degrees to find the maximum reading.
- e. The test-receiver system was set to Peak Detect Function and Specified Bandwidth with Maximum Hold Mode.
- f. If the emission level of the EUT in peak mode was 10dB lower than the limit specified, then testing could bestopped and the peak values of the EUT would be reported. Otherwise the emissions that did not have 10dBmargin would be re-tested one by one using peak, quasi-peak or average method as specified and then reportedin a data sheet.
- g. Test the EUT in the lowest channel,the Highest channel

Note:

Both horizontal and vertical antenna polarities were tested and performed pretest to three orthogonal axis. The worst case emissions were reported

5.3 DEVIATION FROM TEST STANDARD

No deviation



5.4 TEST SETUP

Radiated Emission Test-Up Frequency Above 1GHz

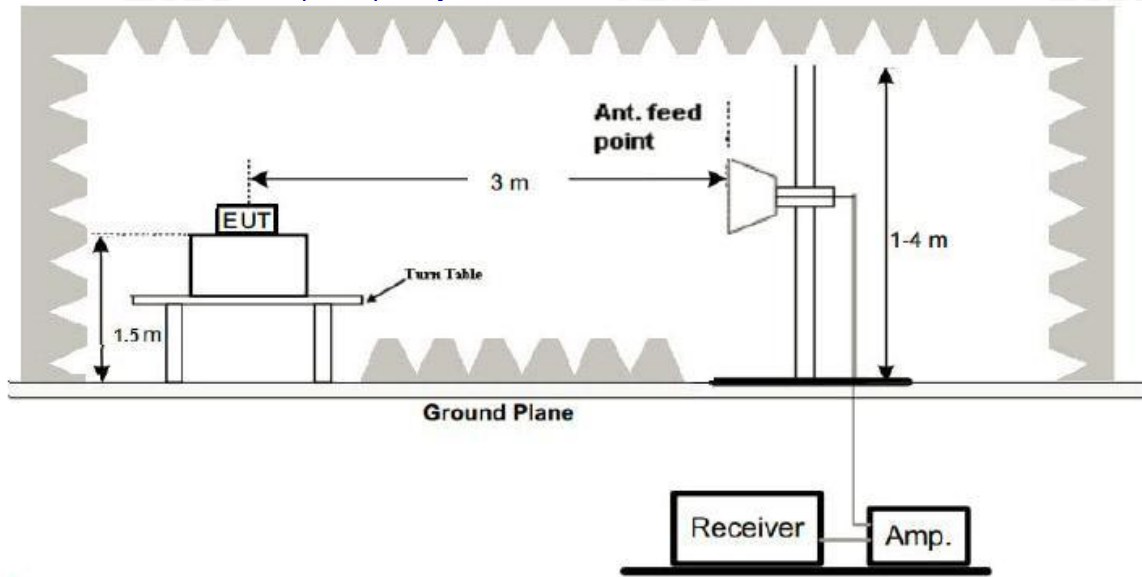

5.5 EUT OPERATING CONDITIONS

The EUT tested system was configured as the statements of 2.3 Unless otherwise a special operating condition is specified in the follows during the testing.



5.6 TEST RESULT

| | Polar (H/V) | Frequenc y (MHz) | Meter Reading (dBUV) | Pre-amplifier (dB) | Cable Loss (dB) | Antenna Factor (dB/m) | Emission level (dBUV/m) | Limit (dBUV/ m) | Detec tor Type | Result |
|---|----------------------|------------------|----------------------|--------------------|-----------------|-----------------------|--------------------------|-----------------|----------------|--------|
| 802.11b | LowChannel 2412MHz | | | | | | | | | |
| | H | 2390.00 | 54.93 | 30.22 | 4.85 | 23.98 | 53.54 | 74.00 | PK | PASS |
| | H | 2390.00 | 44.18 | 30.22 | 4.85 | 23.98 | 42.79 | 54.00 | AV | PASS |
| | H | 2400.00 | 53.71 | 30.22 | 4.85 | 23.98 | 52.32 | 74.00 | PK | PASS |
| | H | 2400.00 | 44.48 | 30.22 | 4.85 | 23.98 | 43.09 | 54.00 | AV | PASS |
| | V | 2390.00 | 54.54 | 30.22 | 4.85 | 23.98 | 53.15 | 74.00 | PK | PASS |
| | V | 2390.00 | 44.51 | 30.22 | 4.85 | 23.98 | 43.12 | 54.00 | AV | PASS |
| | V | 2400.00 | 53.01 | 30.22 | 4.85 | 23.98 | 51.62 | 74.00 | PK | PASS |
| | V | 2400.00 | 44.62 | 30.22 | 4.85 | 23.98 | 43.23 | 54.00 | AV | PASS |
| | HighChannel 2462MHz | | | | | | | | | |
| | H | 2483.50 | 53.54 | 30.22 | 4.85 | 23.98 | 52.15 | 74.00 | PK | PASS |
| | H | 2483.50 | 44.07 | 30.22 | 4.85 | 23.98 | 42.68 | 54.00 | AV | PASS |
| | H | 2500.00 | 54.60 | 30.22 | 4.85 | 23.98 | 53.21 | 74.00 | PK | PASS |
| | H | 2500.00 | 44.89 | 30.22 | 4.85 | 23.98 | 43.50 | 54.00 | AV | PASS |
| | V | 2483.50 | 54.99 | 30.22 | 4.85 | 23.98 | 53.60 | 74.00 | PK | PASS |
| | V | 2483.50 | 44.72 | 30.22 | 4.85 | 23.98 | 43.33 | 54.00 | AV | PASS |
| V | 2500.00 | 54.51 | 30.22 | 4.85 | 23.98 | 53.12 | 74.00 | PK | PASS | |
| V | 2500.00 | 44.15 | 30.22 | 4.85 | 23.98 | 42.76 | 54.00 | AV | PASS | |
| 802.11g | LowChannel 2412MHz | | | | | | | | | |
| | H | 2390.00 | 54.33 | 30.22 | 4.85 | 23.98 | 52.94 | 74.00 | PK | PASS |
| | H | 2390.00 | 44.67 | 30.22 | 4.85 | 23.98 | 43.28 | 54.00 | AV | PASS |
| | H | 2400.00 | 53.95 | 30.22 | 4.85 | 23.98 | 52.56 | 74.00 | PK | PASS |
| | H | 2400.00 | 44.82 | 30.22 | 4.85 | 23.98 | 43.43 | 54.00 | AV | PASS |
| | V | 2390.00 | 54.68 | 30.22 | 4.85 | 23.98 | 53.29 | 74.00 | PK | PASS |
| | V | 2390.00 | 44.22 | 30.22 | 4.85 | 23.98 | 42.83 | 54.00 | AV | PASS |
| | V | 2400.00 | 53.17 | 30.22 | 4.85 | 23.98 | 51.78 | 74.00 | PK | PASS |
| | V | 2400.00 | 44.69 | 30.22 | 4.85 | 23.98 | 43.30 | 54.00 | AV | PASS |
| | High Channel 2462MHz | | | | | | | | | |
| | H | 2483.50 | 54.54 | 30.22 | 4.85 | 23.98 | 53.15 | 74.00 | PK | PASS |
| | H | 2483.50 | 44.06 | 30.22 | 4.85 | 23.98 | 42.67 | 54.00 | AV | PASS |
| | H | 2500.00 | 54.85 | 30.22 | 4.85 | 23.98 | 53.46 | 74.00 | PK | PASS |
| | H | 2500.00 | 44.85 | 30.22 | 4.85 | 23.98 | 43.46 | 54.00 | AV | PASS |
| | V | 2483.50 | 53.23 | 30.22 | 4.85 | 23.98 | 51.84 | 74.00 | PK | PASS |
| | V | 2483.50 | 44.84 | 30.22 | 4.85 | 23.98 | 43.45 | 54.00 | AV | PASS |
| V | 2500.00 | 53.12 | 30.22 | 4.85 | 23.98 | 51.73 | 74.00 | PK | PASS | |
| V | 2500.00 | 44.78 | 30.22 | 4.85 | 23.98 | 43.39 | 54.00 | AV | PASS | |
| Remark: | | | | | | | | | | |
| 1. Emission Level = Meter Reading + Antenna Factor + Cable Loss – Pre-amplifier, Margin= Emission Level - Limit | | | | | | | | | | |



| | | LowChannel 2412MHz | | | | | | | | | | |
|---|---------|--------------------|---------|----------------------|-------|-------|-------|-------|-------|----|------|--|
| | | H | 2390.00 | 53.84 | 30.22 | 4.85 | 23.98 | 52.45 | 74.00 | PK | PASS | |
| 802.11n20 | | H | 2390.00 | 44.33 | 30.22 | 4.85 | 23.98 | 42.94 | 54.00 | AV | PASS | |
| | | H | 2400.00 | 53.91 | 30.22 | 4.85 | 23.98 | 52.52 | 74.00 | PK | PASS | |
| | | H | 2400.00 | 44.56 | 30.22 | 4.85 | 23.98 | 43.17 | 54.00 | AV | PASS | |
| | | V | 2390.00 | 54.54 | 30.22 | 4.85 | 23.98 | 53.15 | 74.00 | PK | PASS | |
| | | V | 2390.00 | 44.17 | 30.22 | 4.85 | 23.98 | 42.78 | 54.00 | AV | PASS | |
| | | V | 2400.00 | 54.97 | 30.22 | 4.85 | 23.98 | 53.58 | 74.00 | PK | PASS | |
| | | V | 2400.00 | 44.66 | 30.22 | 4.85 | 23.98 | 43.27 | 54.00 | AV | PASS | |
| | | | | High Channel 2462MHz | | | | | | | | |
| | | H | 2483.50 | 54.96 | 30.22 | 4.85 | 23.98 | 53.57 | 74.00 | PK | PASS | |
| | | H | 2483.50 | 44.46 | 30.22 | 4.85 | 23.98 | 43.07 | 54.00 | AV | PASS | |
| | | H | 2500.00 | 53.95 | 30.22 | 4.85 | 23.98 | 52.56 | 74.00 | PK | PASS | |
| | | H | 2500.00 | 44.34 | 30.22 | 4.85 | 23.98 | 42.95 | 54.00 | AV | PASS | |
| | | V | 2483.50 | 53.48 | 30.22 | 4.85 | 23.98 | 52.09 | 74.00 | PK | PASS | |
| | | V | 2483.50 | 44.36 | 30.22 | 4.85 | 23.98 | 42.97 | 54.00 | AV | PASS | |
| V | 2500.00 | 54.71 | 30.22 | 4.85 | 23.98 | 53.32 | 74.00 | PK | PASS | | | |
| V | 2500.00 | 44.68 | 30.22 | 4.85 | 23.98 | 43.29 | 54.00 | AV | PASS | | | |
| 802.11n40 | | LowChannel 2422MHz | | | | | | | | | | |
| | | H | 2390.00 | 53.76 | 30.22 | 4.85 | 23.98 | 52.37 | 74.00 | PK | PASS | |
| | | H | 2390.00 | 44.71 | 30.22 | 4.85 | 23.98 | 43.32 | 54.00 | AV | PASS | |
| | | H | 2400.00 | 53.04 | 30.22 | 4.85 | 23.98 | 51.65 | 74.00 | PK | PASS | |
| | | H | 2400.00 | 44.63 | 30.22 | 4.85 | 23.98 | 43.24 | 54.00 | AV | PASS | |
| | | V | 2390.00 | 53.57 | 30.22 | 4.85 | 23.98 | 52.18 | 74.00 | PK | PASS | |
| | | V | 2390.00 | 44.02 | 30.22 | 4.85 | 23.98 | 42.63 | 54.00 | AV | PASS | |
| | | V | 2400.00 | 53.34 | 30.22 | 4.85 | 23.98 | 51.95 | 74.00 | PK | PASS | |
| | | V | 2400.00 | 44.15 | 30.22 | 4.85 | 23.98 | 42.76 | 54.00 | AV | PASS | |
| | | | | High Channel 2452MHz | | | | | | | | |
| | | H | 2483.50 | 53.86 | 30.22 | 4.85 | 23.98 | 52.47 | 74.00 | PK | PASS | |
| | | H | 2483.50 | 44.74 | 30.22 | 4.85 | 23.98 | 43.35 | 54.00 | AV | PASS | |
| | | H | 2500.00 | 53.29 | 30.22 | 4.85 | 23.98 | 51.90 | 74.00 | PK | PASS | |
| | | H | 2500.00 | 44.77 | 30.22 | 4.85 | 23.98 | 43.38 | 54.00 | AV | PASS | |
| V | 2483.50 | 53.08 | 30.22 | 4.85 | 23.98 | 51.69 | 74.00 | PK | PASS | | | |
| V | 2483.50 | 44.83 | 30.22 | 4.85 | 23.98 | 43.44 | 54.00 | AV | PASS | | | |
| V | 2500.00 | 53.07 | 30.22 | 4.85 | 23.98 | 51.68 | 74.00 | PK | PASS | | | |
| V | 2500.00 | 44.70 | 30.22 | 4.85 | 23.98 | 43.31 | 54.00 | AV | PASS | | | |
| Remark: | | | | | | | | | | | | |
| 1. Emission Level = Meter Reading + Antenna Factor + Cable Loss – Pre-amplifier, Margin= Emission Level - Limit | | | | | | | | | | | | |



6. POWER SPECTRAL DENSITY TEST

| | |
|-------------------|---|
| Test Requirement: | FCC Part15 C Section 15.247 (e) |
| Test Method: | ANSI C63.10:2013 and KDB558074 D01DTS Meas Guidancev05r02 |

6.1 APPLIED PROCEDURES / LIMIT

| FCC Part15 (15.247) , Subpart C | | | | |
|---------------------------------|------------------------|-----------|-----------------------|--------|
| Section | Test Item | Limit | Frequency Range (MHz) | Result |
| 15.247 | Power Spectral Density | 8dBm/3kHz | 2400-2483.5 | PASS |

6.2 TEST PROCEDURE

1. Set analyzer center frequency to DTS channel center frequency.
2. Set the span to 1.5 times the DTS bandwidth.
3. Set the RBW to: $3 \text{ kHz} \leq \text{RBW} \leq 100 \text{ kHz}$.
4. Set the VBW $\geq 3 \times \text{RBW}$.
5. Detector = peak.
6. Sweep time = auto couple.
7. Trace mode = max hold.
8. Allow trace to fully stabilize.
9. Use the peak marker function to determine the maximum amplitude level within the RBW.
10. If measured value exceeds limit, reduce RBW (no less than 3 kHz) and repeat.

6.3 DEVIATION FROM STANDARD

No deviation.

6.4 TEST SETUP



6.5 EUT OPERATION CONDITIONS

The EUT tested system was configured as the statements of 2.1 Unless otherwise a special operating condition is specified in the follows during the testing.



6.6 TEST RESULT

| | | | |
|--------------|-----------|--------------------|--------------|
| Temperature: | 26°C | Relative Humidity: | 54% |
| Pressure: | 101kPa | Test Voltage : | AC 120V/60Hz |
| Test Mode : | TX b Mode | | |

| Frequency | Power Spectral Density (dBm/3kHz) | Limit (dBm/3kHz) | Result |
|-----------|-----------------------------------|------------------|--------|
| 2412 MHz | -18.089 | 8 | PASS |
| 2437 MHz | -17.657 | 8 | PASS |
| 2462 MHz | -17.87 | 8 | PASS |





TX CH06



TX CH11

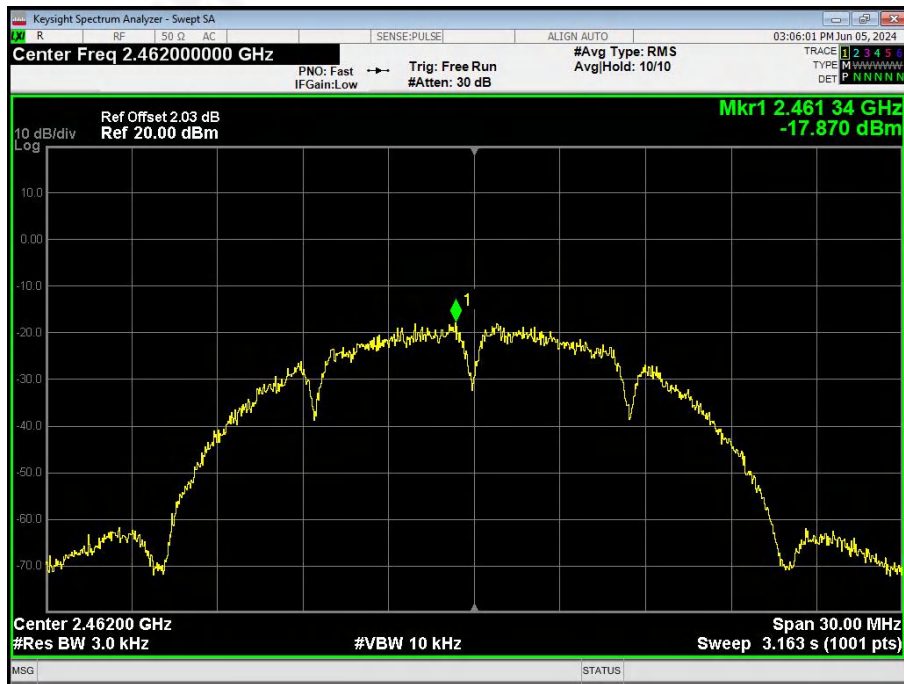



| | | | |
|--------------|-----------|--------------------|--------------|
| Temperature: | 26°C | Relative Humidity: | 54% |
| Pressure: | 101kPa | Test Voltage: | AC 120V/60Hz |
| Test Mode : | TX g Mode | | |

| Frequency | Power Spectral Density (dBm/3kHz) | Limit (dBm/3kHz) | Result |
|-----------|-----------------------------------|------------------|--------|
| 2412 MHz | -22.016 | 8 | PASS |
| 2437 MHz | -20.98 | 8 | PASS |
| 2462 MHz | -21.646 | 8 | PASS |

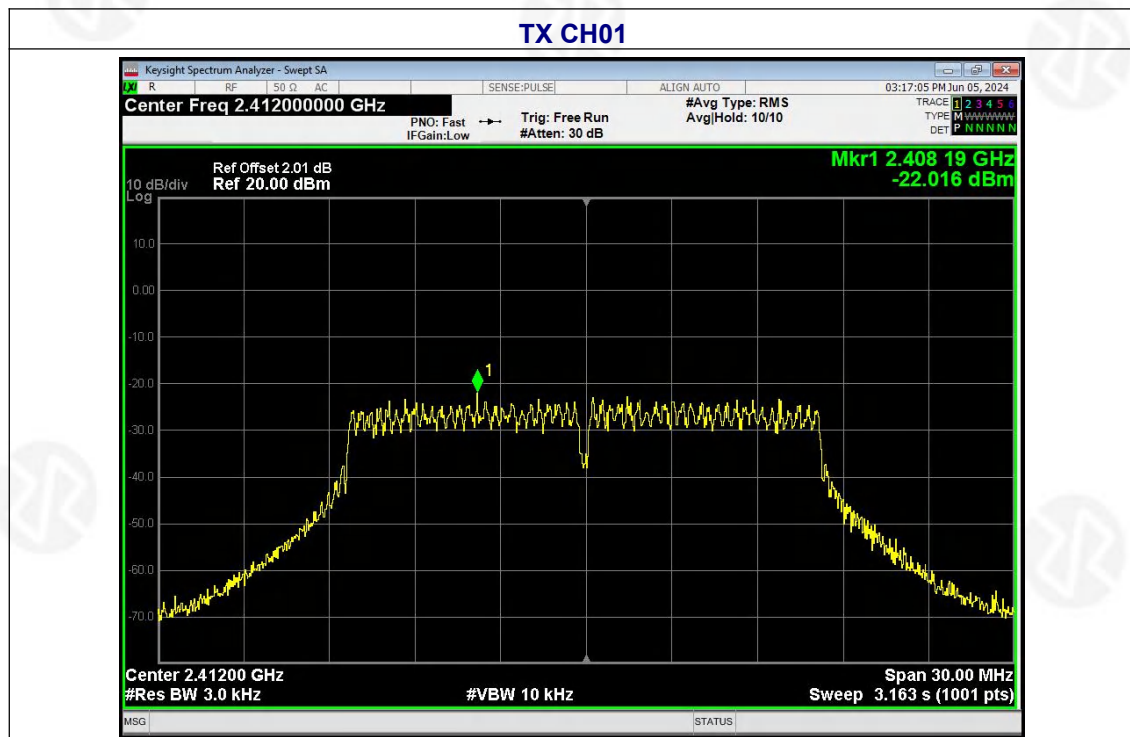



TX CH06

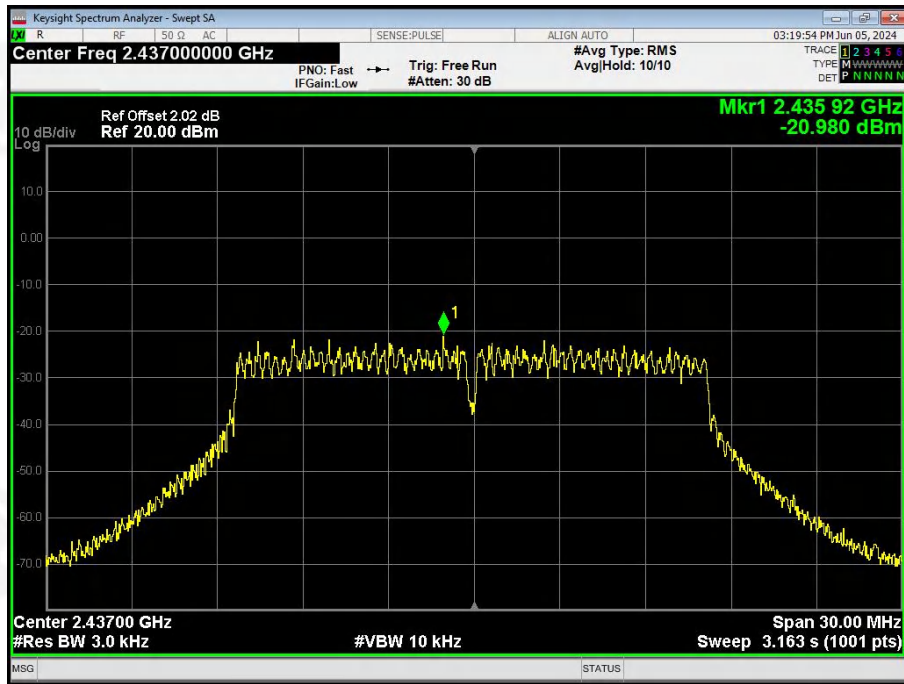

TX CH11

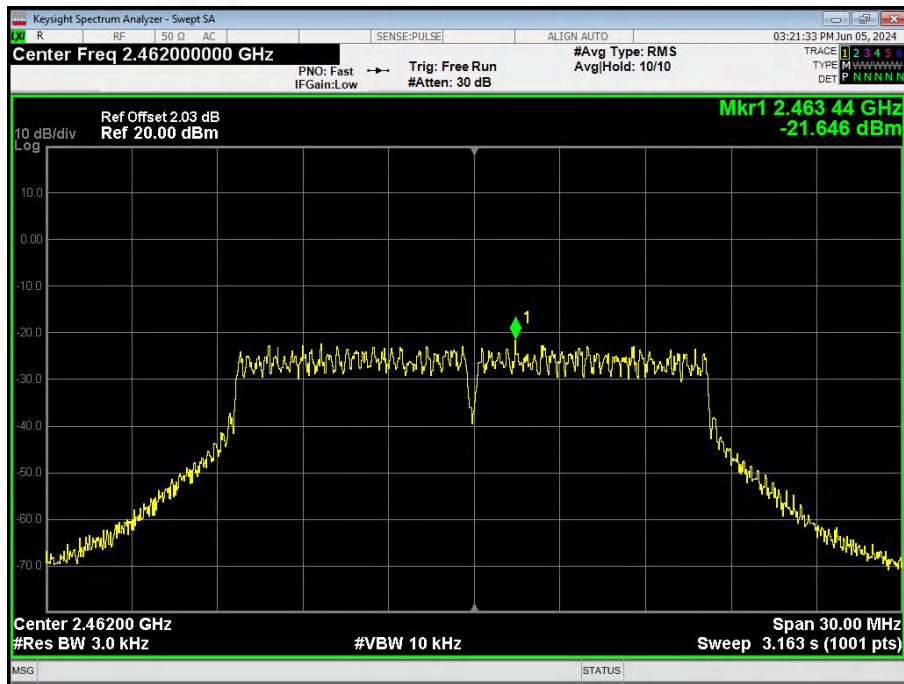



| | | | |
|--------------|----------------|--------------------|--------------|
| Temperature: | 26°C | Relative Humidity: | 54% |
| Pressure: | 101kPa | Test Voltage: | AC 120V/60Hz |
| Test Mode : | TX n Mode(20M) | | |

| Frequency | Power Spectral Density (dBm/3kHz) | Limit (dBm/3kHz) | Result |
|-----------|-----------------------------------|------------------|--------|
| 2412 MHz | -22.159 | 8 | PASS |
| 2437 MHz | -21.014 | 8 | PASS |
| 2462 MHz | -21.831 | 8 | PASS |

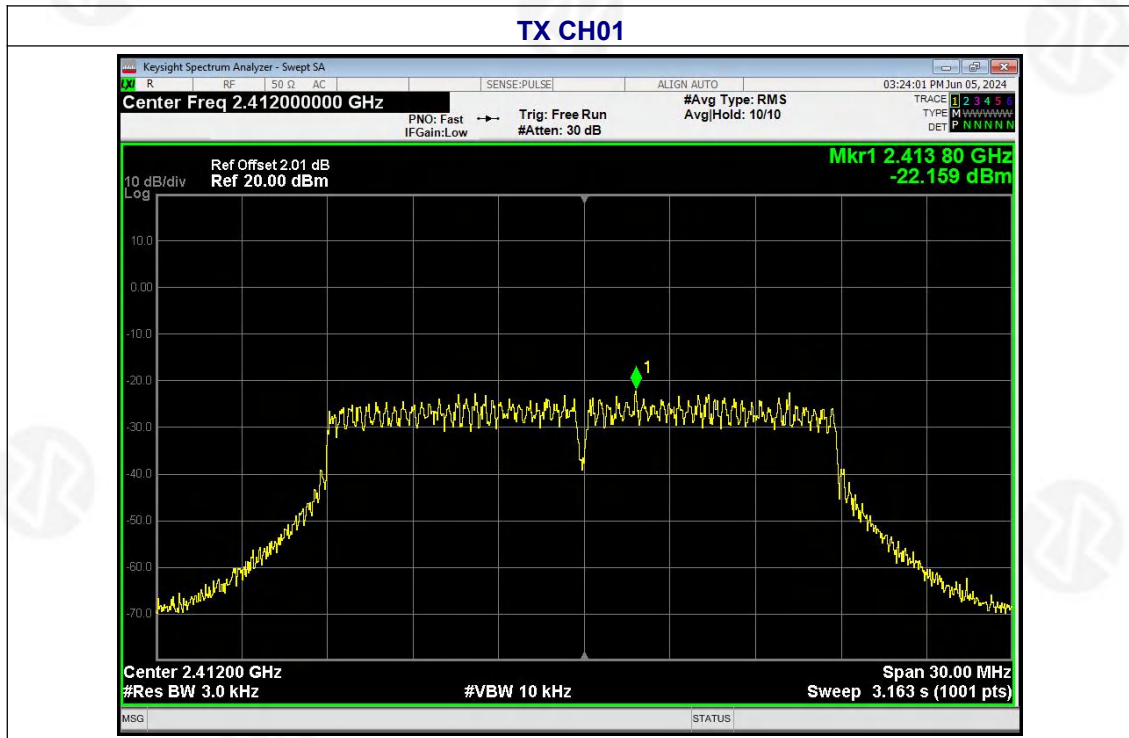



TX CH06

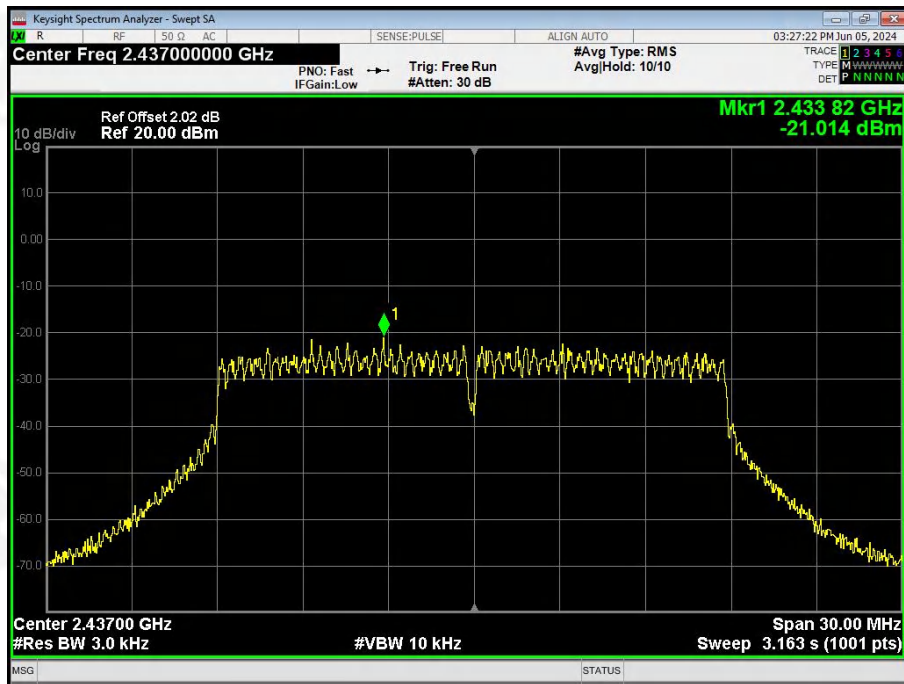

TX CH11

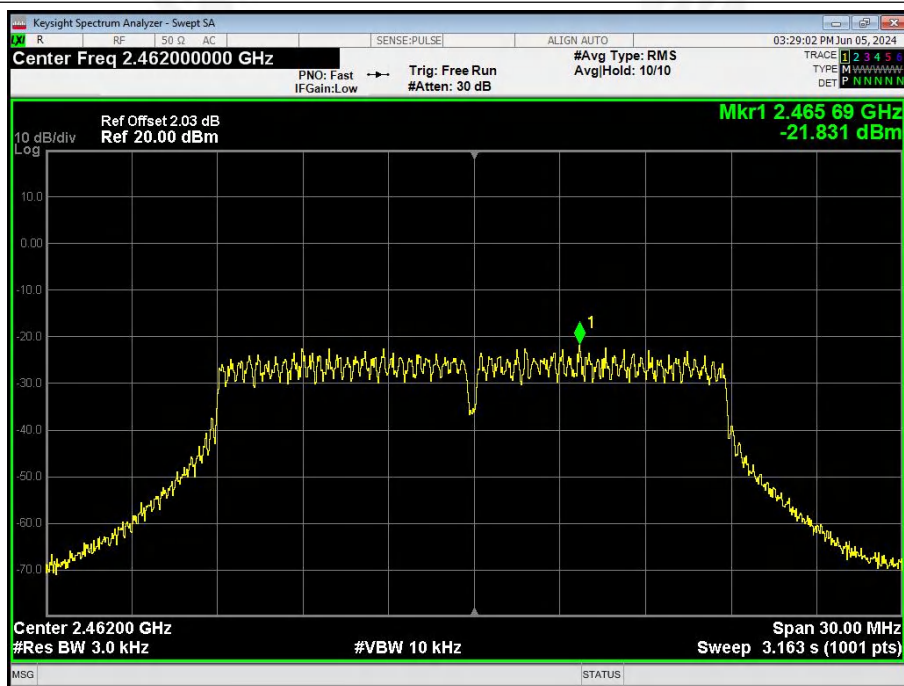



| | | | |
|--------------|----------------|--------------------|--------------|
| Temperature: | 26°C | Relative Humidity: | 54% |
| Pressure: | 101kPa | Test Voltage: | AC 120V/60Hz |
| Test Mode : | TX n Mode(40M) | | |

| Frequency | Power Spectral Density (dBm/3kHz) | Limit (dBm/3kHz) | Result |
|-----------|-----------------------------------|------------------|--------|
| 2422 MHz | -25.195 | 8 | PASS |
| 2437 MHz | -24.336 | 8 | PASS |
| 2452 MHz | -24.942 | 8 | PASS |

TX CH03

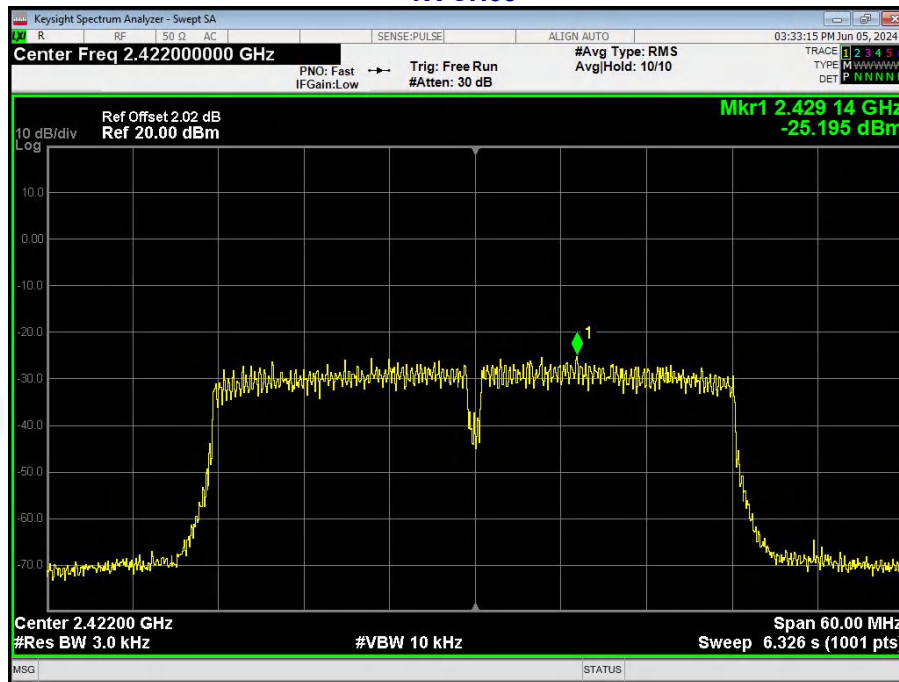



TX CH06

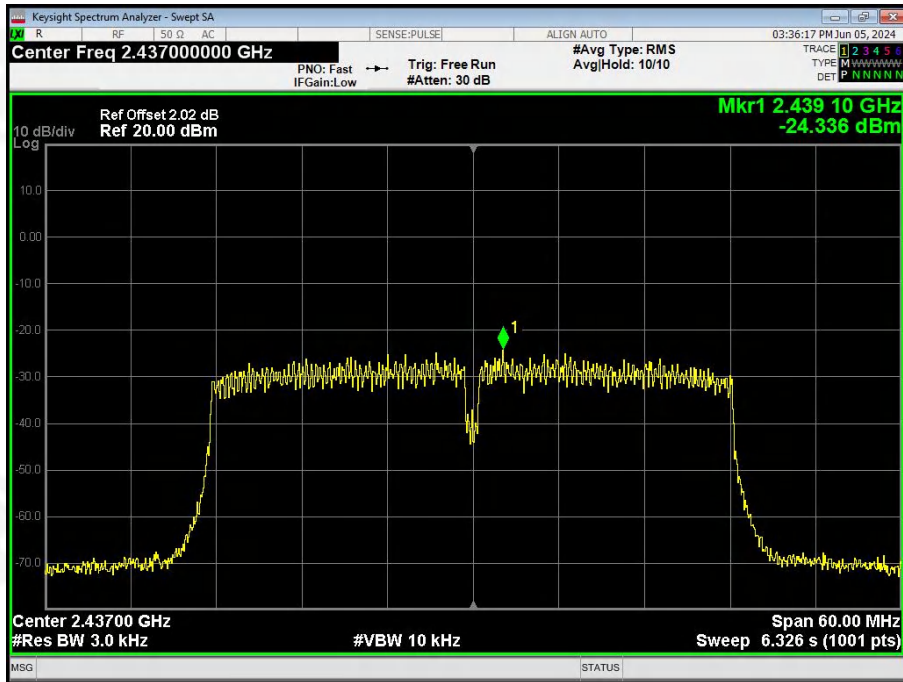

TX CH09

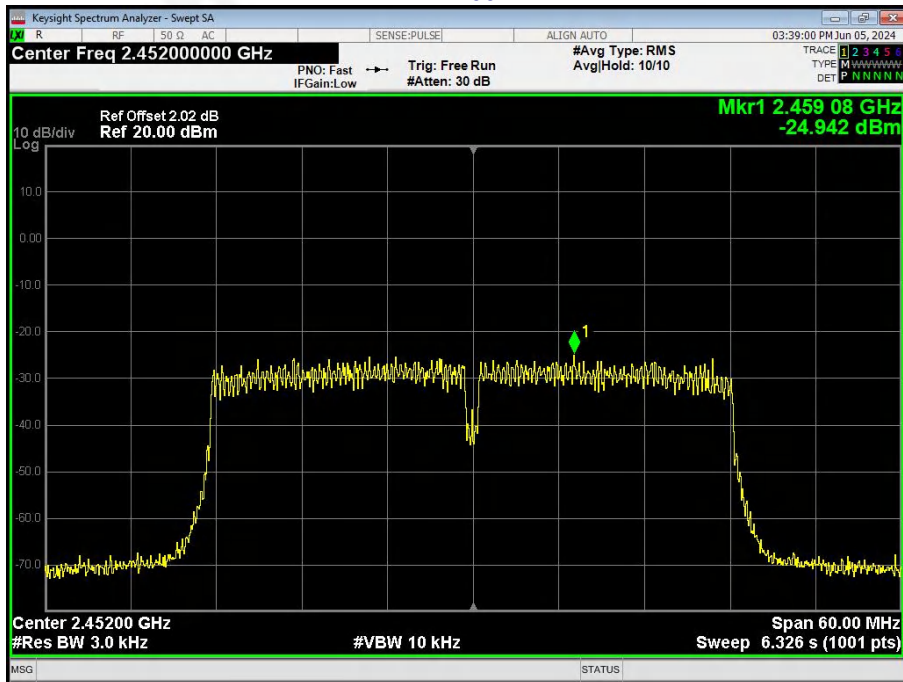



7. CHANNEL BANDWIDTH OCCUPY BANDWIDTH

| | |
|-------------------|---|
| Test Requirement: | FCC Part15 C Section 15.247 (a)(2) |
| Test Method: | ANSI C63.10:2013 and KDB558074 D01DTS Meas Guidancev05r02 |

7.1 APPLIED PROCEDURES / LIMIT

| FCC Part15 (15.247) , Subpart C | | | | |
|---------------------------------|-----------|---|-----------------------|--------|
| Section | Test Item | Limit | Frequency Range (MHz) | Result |
| 15.247(a)(2) | Bandwidth | $\geq 500\text{KHz}$ (6dB bandwidth) | 2400-2483.5 | PASS |

7.2 TEST PROCEDURE

1. Set RBW = 100 kHz.
2. Set the video bandwidth (VBW) $\geq 3 \times \text{RBW}$.
3. Detector = Peak.
4. Trace mode = max hold.
5. Sweep = auto couple.
6. Allow the trace to stabilize.
7. Measure the maximum width of the emission that is constrained by the frequencies associated with the two outermost amplitude points (upper and lower frequencies) that are attenuated by 6 dB relative to the maximum level measured in the fundamental emission.

7.3 DEVIATION FROM STANDARD

No deviation.

7.4 TEST SETUP



7.5 EUT OPERATION CONDITIONS

The EUT tested system was configured as the statements of 2.4 Unless otherwise a special operating condition is specified in the follows during the testing.



7.6 TEST RESULT

| | | | |
|--------------|-----------|--------------------|--------------|
| Temperature: | 26°C | Relative Humidity: | 54% |
| Pressure: | 101kPa | Test Voltage : | AC 120V/60Hz |
| Test Mode : | TX b Mode | | |

| Test CH | -6dB Occupy Bandwidth (MHz) | | | | Limit(KHz) | Result |
|---------|-----------------------------|---------|---------------|---------------|------------|--------|
| | 802.11b | 802.11g | 802.11n(HT20) | 802.11n(HT40) | | |
| Lowest | 9.569 | 16.32 | 17.277 | 35.067 | >500 | Pass |
| Middle | 10.046 | 16.447 | 17.007 | 35.14 | | |
| Highest | 10.031 | 16.309 | 17.537 | 35.072 | | |



Test plot as follows:

Lowest channel

802.11b

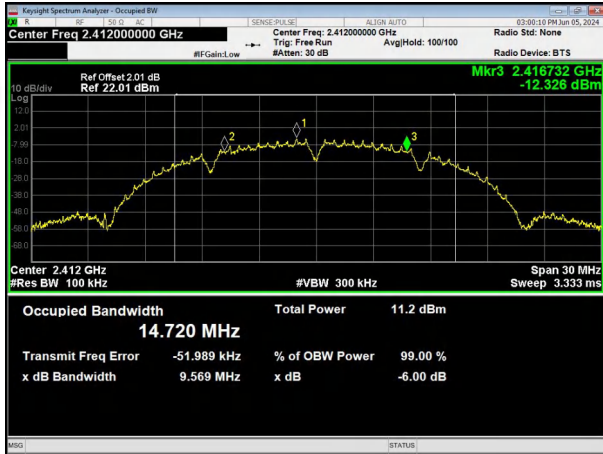

802.11g

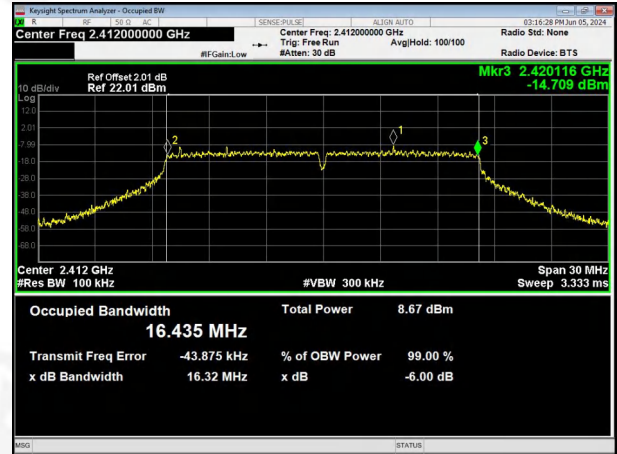

Middle channel

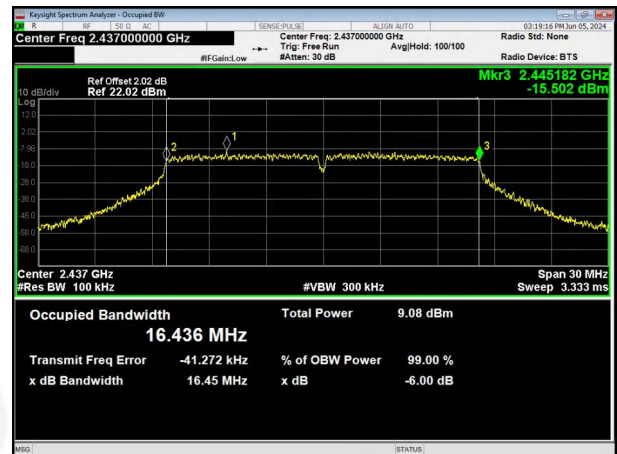
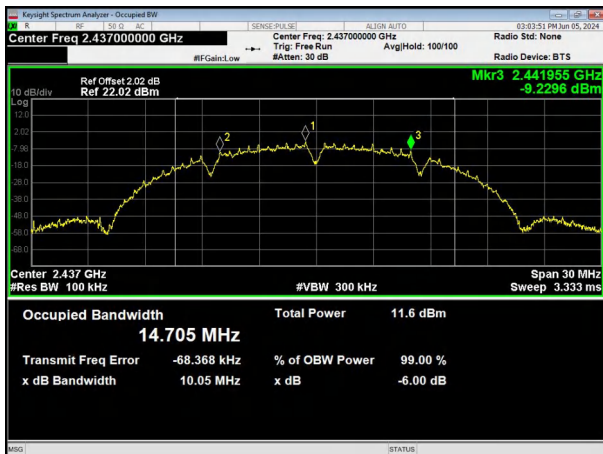

Highest channel

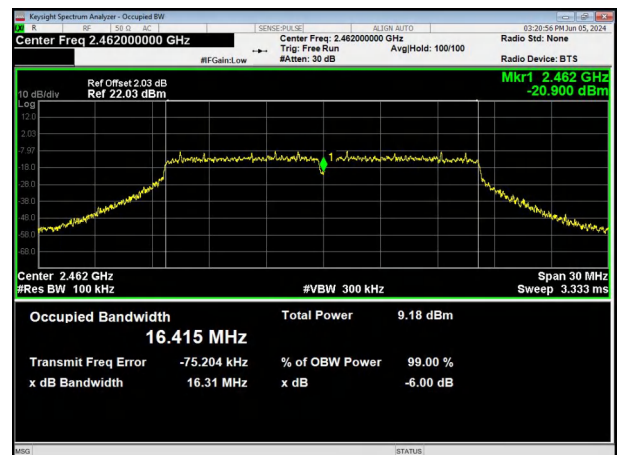
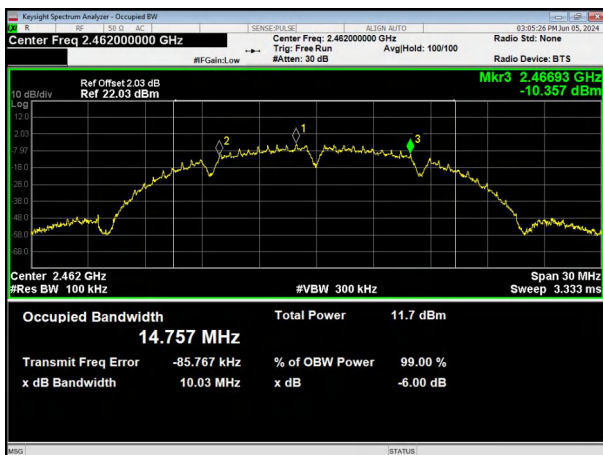



Lowest channel

802.11n20

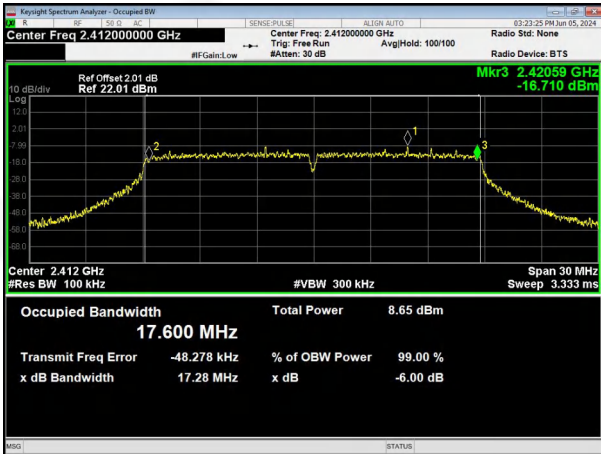

802.11n40

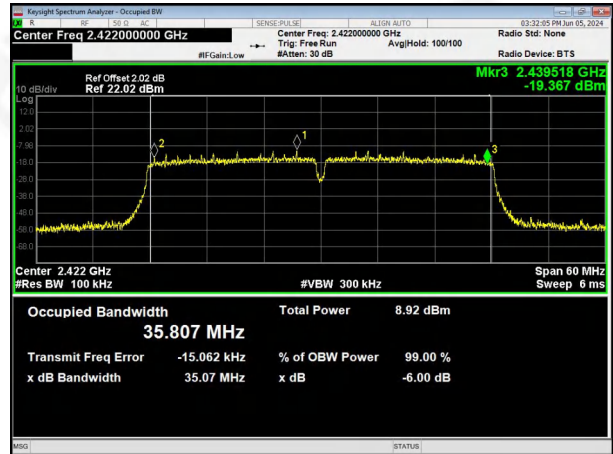

Middle channel

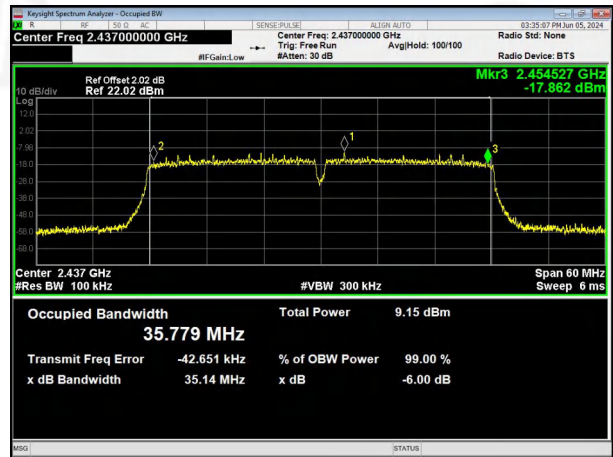
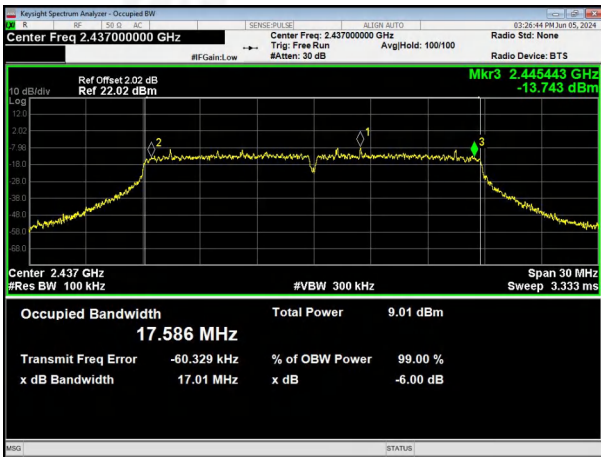

Highest channel

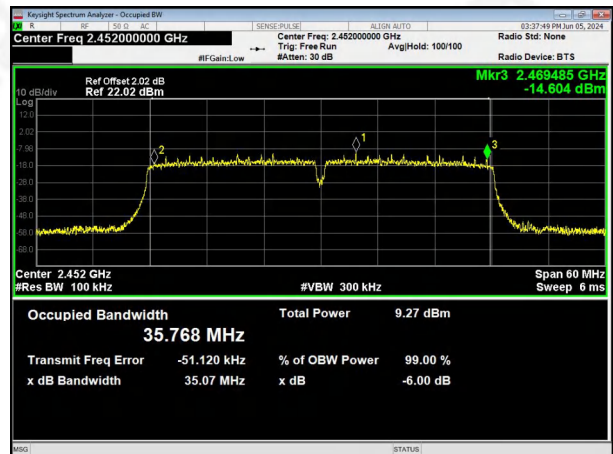
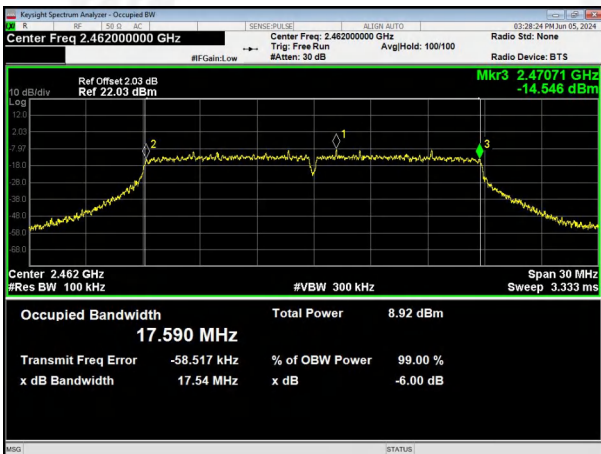



8. PEAK OUTPUT POWER TEST

| | |
|-------------------|---|
| Test Requirement: | FCC Part15 C Section 15.247 (b)(3) |
| Test Method: | ANSI C63.10:2013 and KDB558074 D01DTS Meas Guidancev05r02 |

8.1 APPLIED PROCEDURES/LIMIT

| FCC Part15 (15.247) , Subpart C | | | | |
|---------------------------------|-------------------|-----------------|-----------------------|--------|
| Section | Test Item | Limit | Frequency Range (MHz) | Result |
| 15.247(b)(3) | Peak Output Power | 1 watt or 30dBm | 2400-2483.5 | PASS |

8.2 TEST PROCEDURE

- a. The EUT was directly connected to the Power meter

8.3 DEVIATION FROM STANDARD

No deviation.

8.4 TEST SETUP



8.5 EUT OPERATION CONDITIONS

The EUT tested system was configured as the statements of 2.4 Unless otherwise a special operating condition is specified in the follows during the testing.



8.6 TEST RESULT

| | | | |
|--------------|--------|--------------------|--------------|
| Temperature: | 26°C | Relative Humidity: | 54% |
| Pressure: | 101kPa | Test Voltage : | AC 120V/60Hz |

| Test CH | Peak Output Power (dBm) | | | | Limit(dBm) | Result |
|---------|-------------------------|---------|-----------|-----------|------------|--------|
| | 802.11b | 802.11g | 802.11n20 | 802.11n40 | | |
| Lowest | 6.231 | 7.556 | 7.492 | 7.59 | 30.00 | Pass |
| Middle | 6.608 | 7.987 | 7.827 | 7.7 | | |
| Highest | 6.7 | 8.043 | 7.686 | 7.838 | | |



9. CONDUCTED BAND EDGE AND SPURIOUS EMISSION

| | |
|-------------------|---|
| Test Requirement: | FCC Part15 C Section 15.247 (d) |
| Test Method: | ANSI C63.10:2013 and KDB558074 D01DTS Meas Guidancev05r02 |

9.1 APPLICABLE STANDARD

in any 100 kHz bandwidth outside the frequency bands in which the spread spectrum intentional radiator is operating, the radio frequency power that is produced by the intentional radiator shall be at least 20dB below that in the 100kHz bandwidth within the band that contains the highest level of the desired power, In addition, radiated emissions which fall in the restricted bands, as defined in§15.205(a), must also comply with the radiated emission limits specified in15.209(a).

9.2 TEST PROCEDURE

Using the following spectrum analyzer setting:

- A) Set the RBW = 100KHz.
- B) Set the VBW = 300KHz.
- C) Sweep time = auto couple.
- D) Detector function = peak.
- E) Trace mode = max hold.
- F) Allow trace to fully stabilize.

9.3 DEVIATION FROM STANDARD

No deviation.

9.4 TEST SETUP



9.5 EUT OPERATION CONDITIONS

The EUT tested system was configured as the statements of 2.4 Unless otherwise a special operating condition is specified in the follows during the testing.

9.6 TEST RESULTS



Test plot as follows:

Test mode: 802.11b

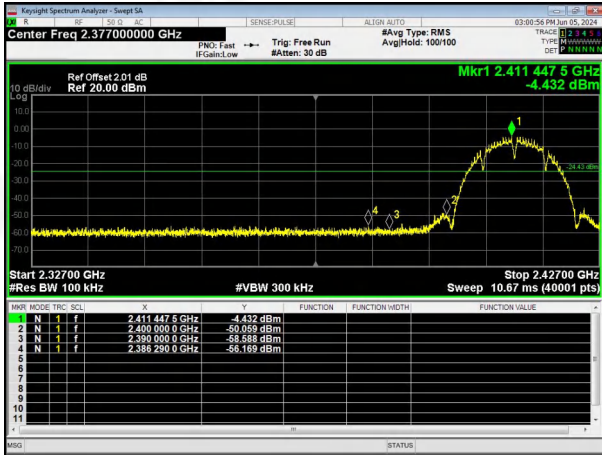

Lowest channel

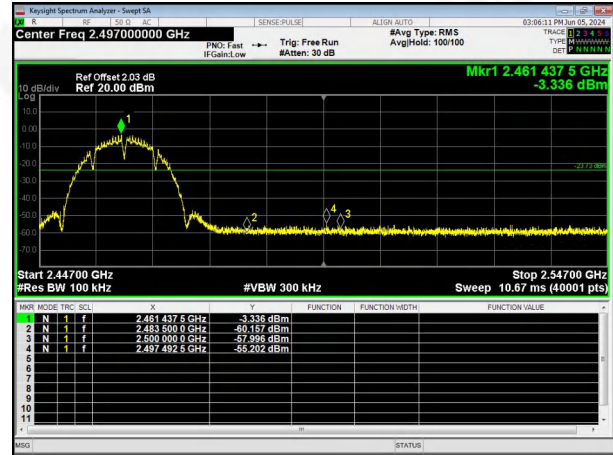

Highest channel

Test mode: 802.11g

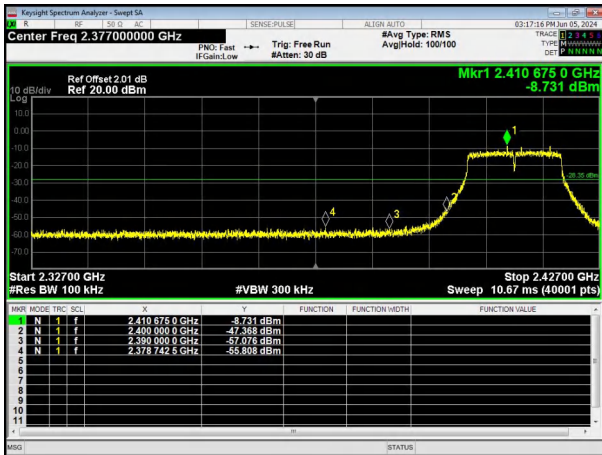

Lowest channel

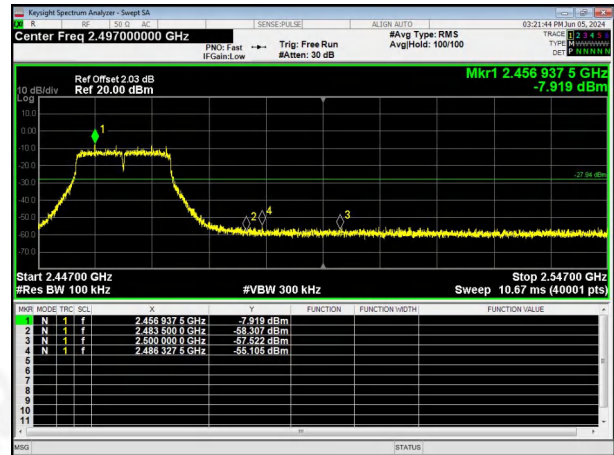

Highest channel



Test mode: 802.11n(HT20)

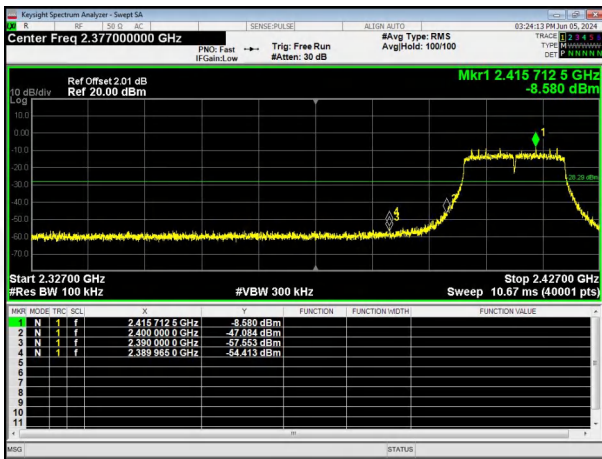

Lowest channel

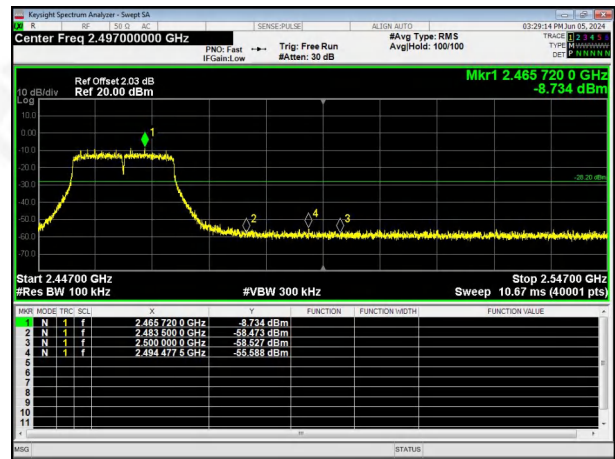

Highest channel

Test mode: 802.11n(HT40)

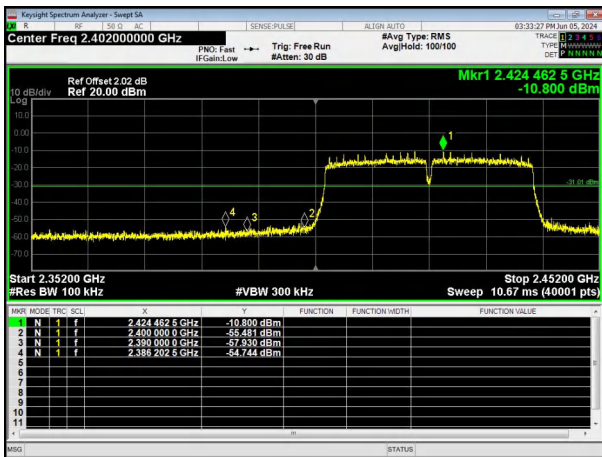

Lowest channel

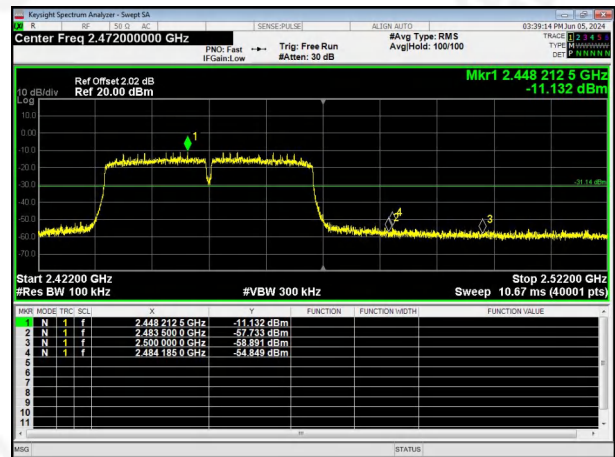

Highest channel



Test plot as follows:

802.11b
Lowest channel

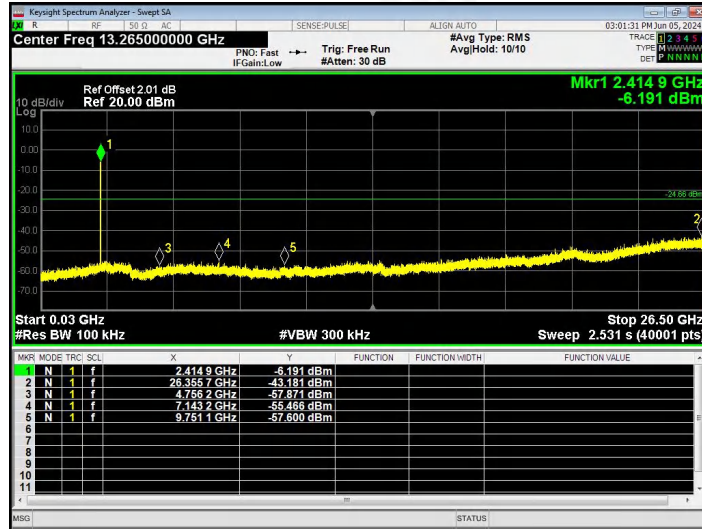

Middle channel

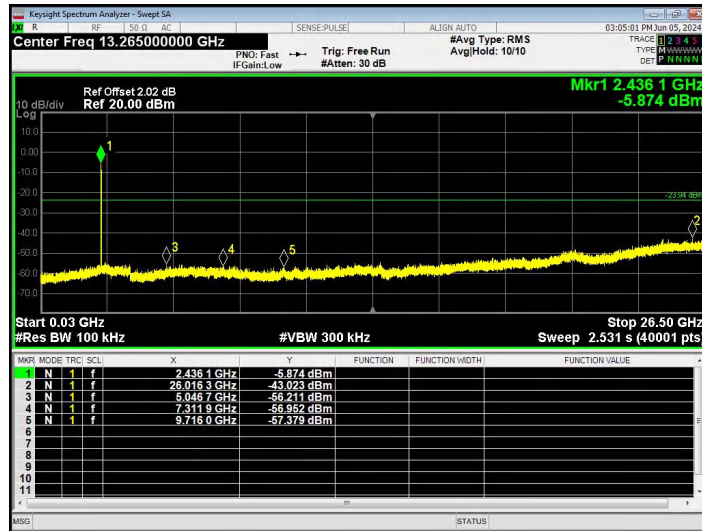

Highest channel

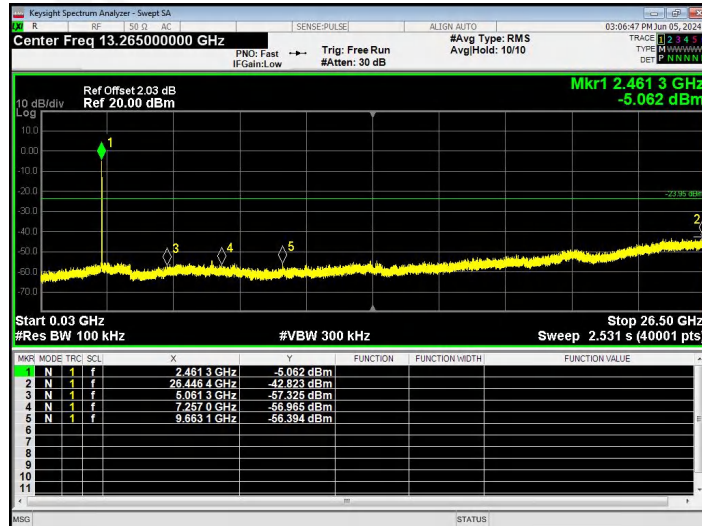



802.11g
Lowest channel

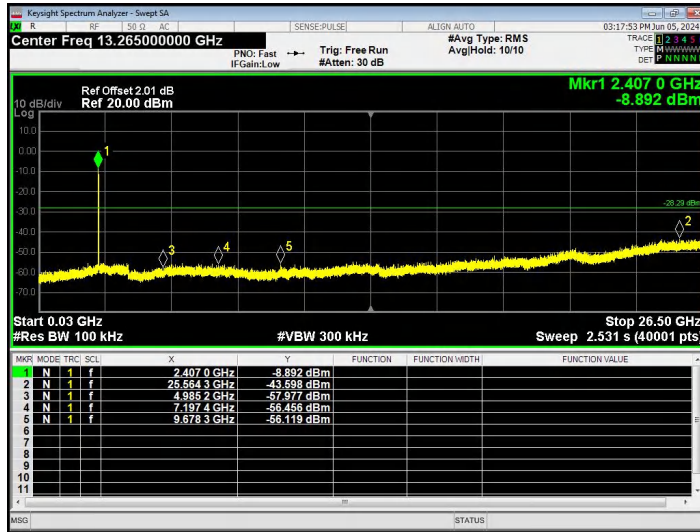

Middle channel

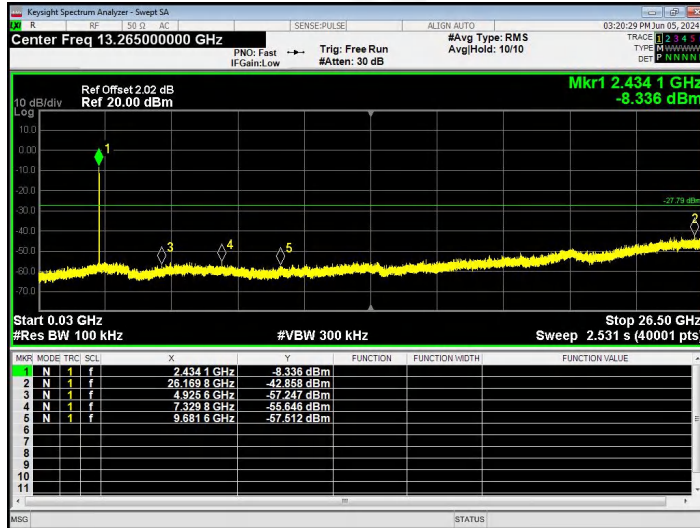

Highest channel

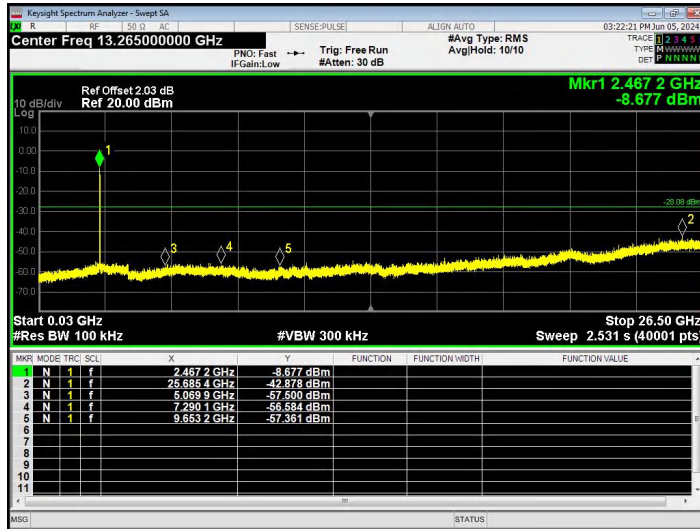



802.11n(HT20)
Lowest channel

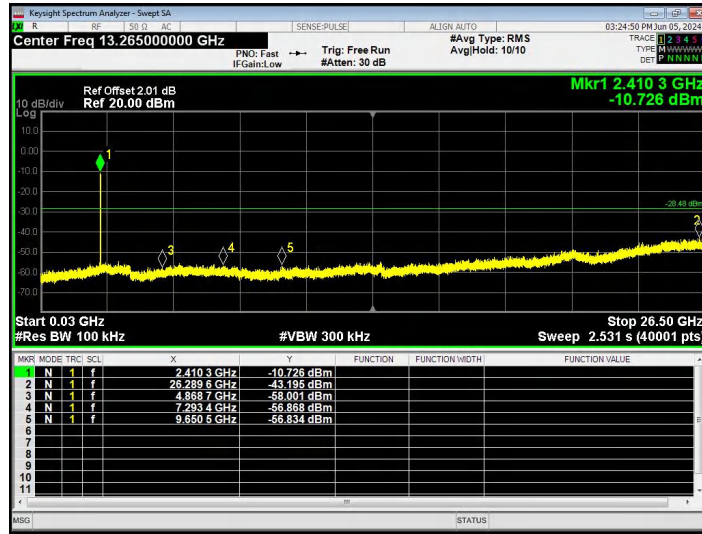

Middle channel

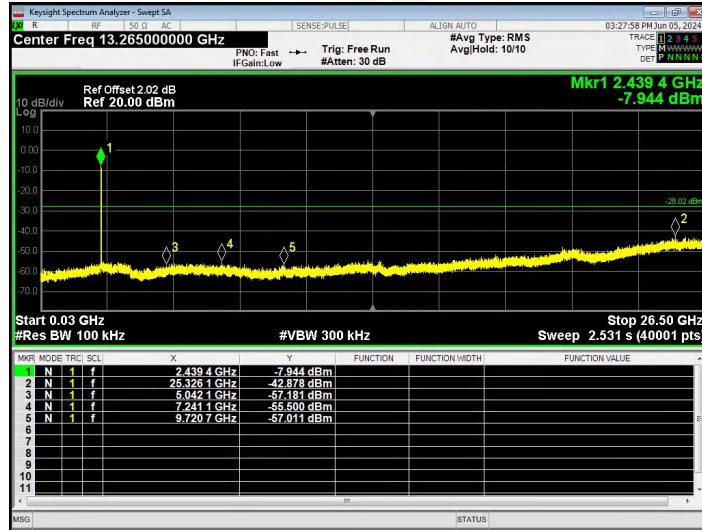

Highest channel

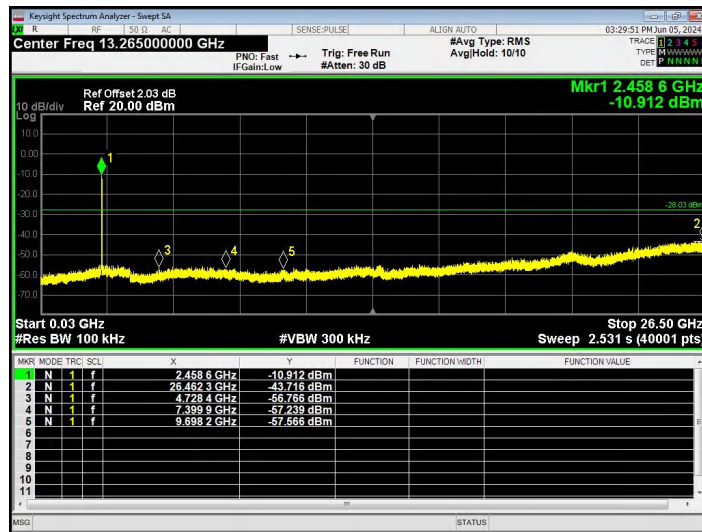



802.11n(HT40)
Lowest channel

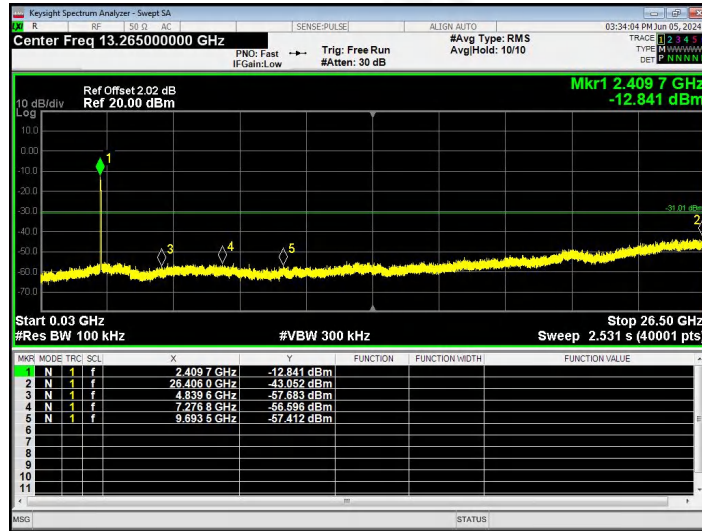

Middle channel

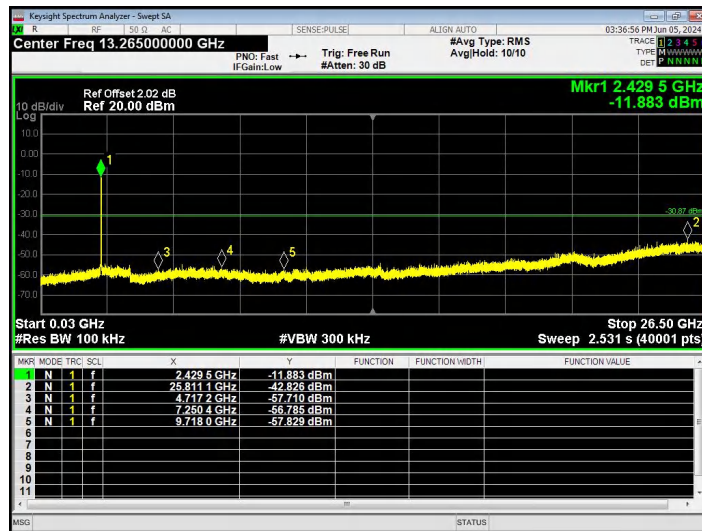

Highest channel

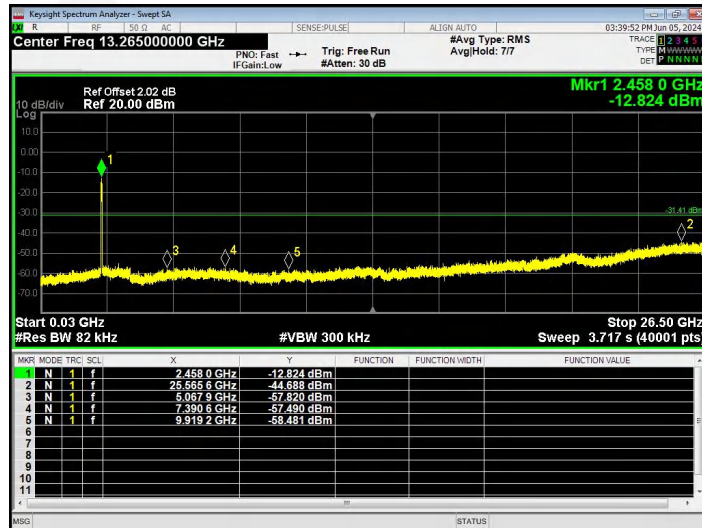



10. DUTY CYCLE

| | |
|--------------|------------------|
| Test Method: | ANSI C63.10:2013 |
|--------------|------------------|

10.1 APPLIED PROCEDURES / LIMIT

Measurements of duty cycle and transmission duration shall be performed using one of the following techniques:

- a) A diode detector and an oscilloscope that together have a sufficiently short response time to permit accurate measurements of the ON and OFF times of the transmitted signal.
- b) The zero-span mode on a spectrum analyzer or EMI receiver if the response time and spacing between bins on the sweep are sufficient to permit accurate measurements of the ON and OFF times of the transmitted signal:
 - 1) Set the center frequency of the instrument to the center frequency of the transmission.
 - 2) Set $RBW \geq OBW$ if possible; otherwise, set RBW to the largest available value.
 - 3) Set $VBW \geq RBW$. Set detector = peak or average.
 - 4) The zero-span measurement method shall not be used unless both RBW and VBW are $> 50/T$ and the number of sweep points across duration T exceeds 100. (For example, if VBW and/or RBW are limited to 3 MHz, then the zero-span method of measuring the duty cycle shall not be used if $T \leq 16.7 \mu s$.)

10.2 DEVIATION FROM STANDARD

No deviation.

10.3 TEST SETUP





10.4 TEST RESULTS

| Mode | Frequency (MHz) | Duty Cycle (%) | Duty Cycle Correction Factor (dB) | Result |
|-----------|-----------------|----------------|-----------------------------------|--------|
| 802.11b | 2412 | 98.96 | 0 | Pass |
| 802.11g | 2412 | 94.52 | 0.24 | Pass |
| 802.11n20 | 2412 | 93.66 | 0.28 | Pass |
| 802.11n40 | 2422 | 88.79 | 0.52 | Pass |

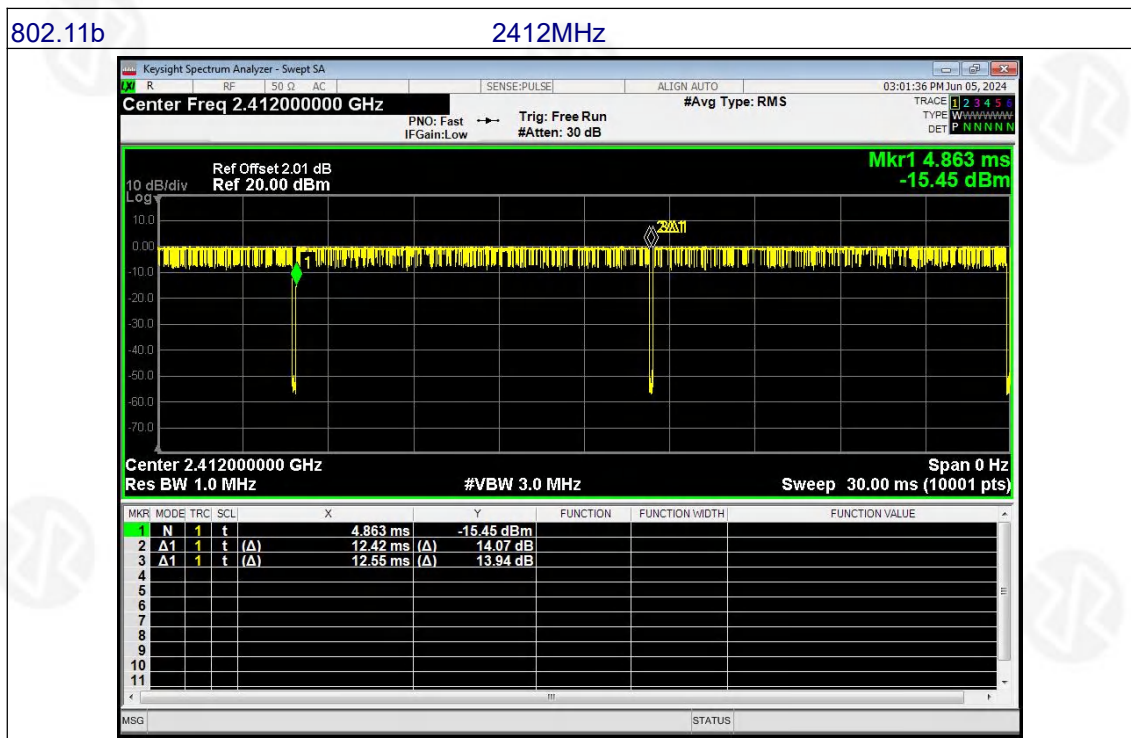



802.11g

2412MHz

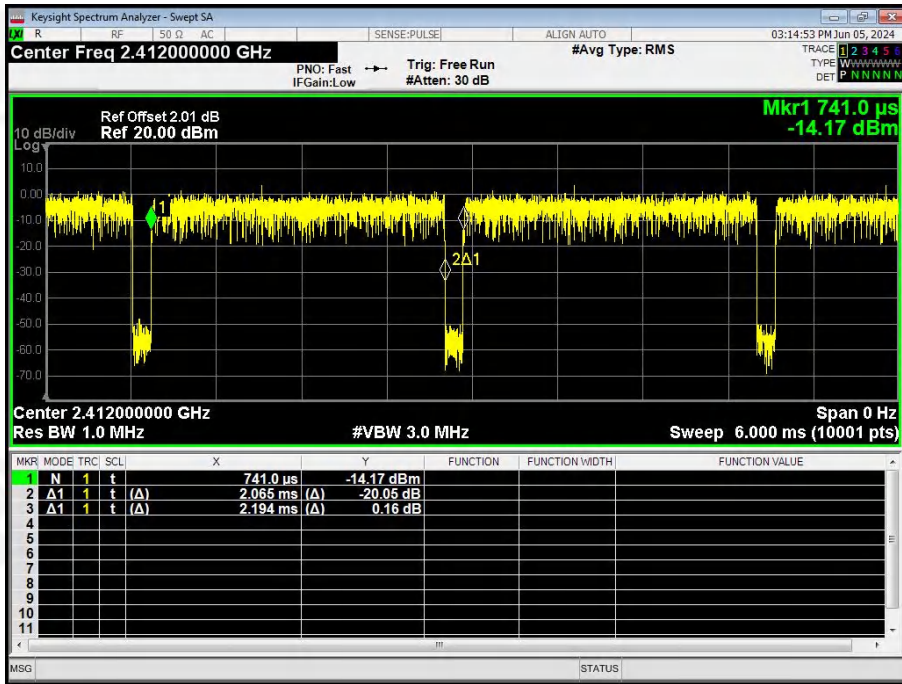

802.11n20

2412MHz

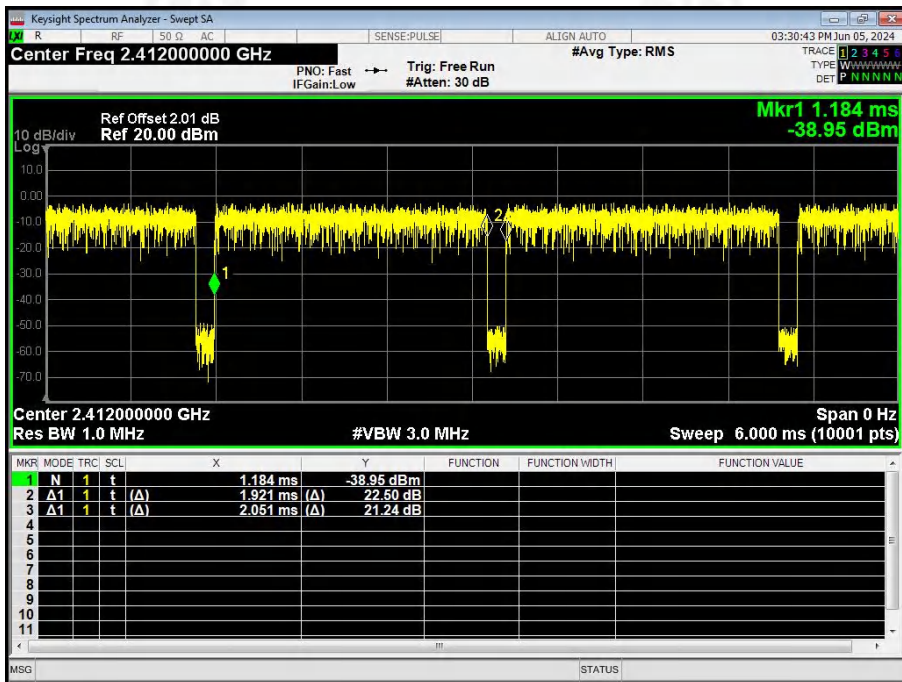



802.11n40

2422MHz

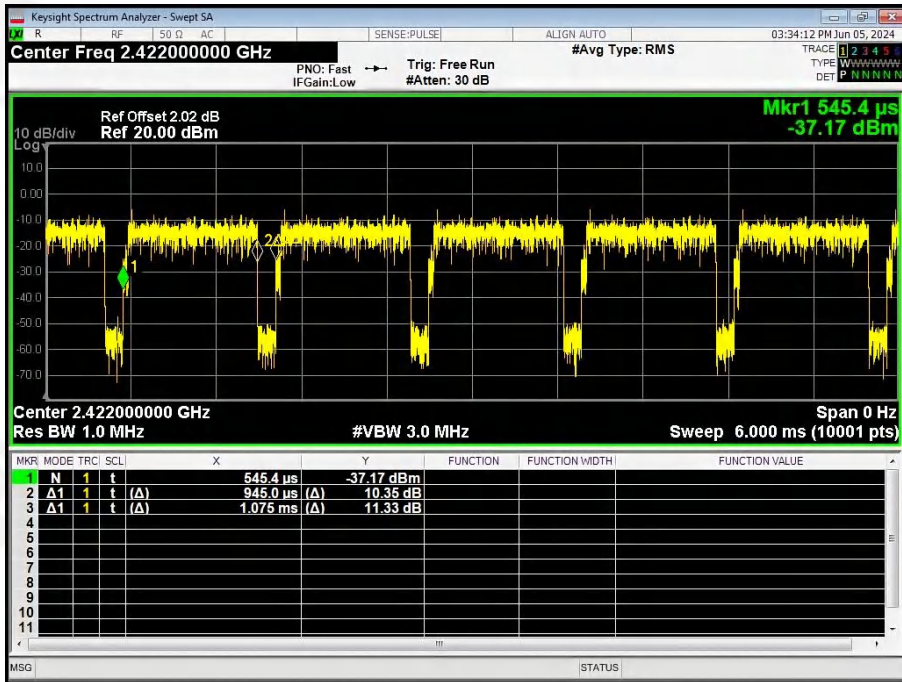

Note: All channel have been tested, and the report only reflects the worst case data.

Duty Cycle= Ton /Total*100%

Duty Cycle Correction Factor = 10log (1/Duty Cycle)



11. ANTENNA REQUIREMENT

| | |
|---|-------------------------------------|
| Standard requirement: | FCC Part15 C Section 15.203 /247(c) |
| <p>15.203 requirement: An intentional radiator shall be designed to ensure that no antenna other than that furnished by the responsible party shall be used with the device. The use of a permanently attached antenna or of an antenna that uses a unique coupling to the intentional radiator, the manufacturer may design the unit so that a broken antenna can be replaced by the user, but the use of a standard antenna jack or electrical connector is prohibited.</p> <p>15.247(c) (1)(i) requirement: (i) Systems operating in the 2400-2483.5 MHz band that is used exclusively for fixed. Point-to-point operations may employ transmitting antennas with directional gain greater than 6dBi provided the maximum conducted output power of the intentional radiator is reduced by 1 dB for every 3 dB that the directional gain of the antenna exceeds 6dBi. A transmitter can only be sold or operated with antennas with which it was approved.</p> | |
| EUT Antenna: | |
| The antenna is FPC Antenna, the best case gain of the antenna is 2dBi, reference to the appendix II for details | |



12. TEST SETUP PHOTO

Reference to the appendix I for details.

13. EUT CONSTRUCTIONAL DETAILS

Reference to the appendix II for details.

***** END OF REPORT *****